



Lexmark™

CX820, CX827, XC6152, XC6153 MFPs

User's Guide

September 2022

www.lexmark.com

Machine type(s):

7563

Model(s):

136, 137

Contents

- Safety information.....7**
 - Conventions.....7
 - Product statements.....7

- Learning about the printer..... 10**
 - Finding information about the printer..... 10
 - Selecting a location for the printer..... 11
 - Printer configurations..... 12
 - Attaching cables..... 13
 - Using the control panel..... 15
 - Understanding the status of the power button and indicator light..... 16
 - Using the home screen.....16

- Setting up and using the home screen applications..... 18**
 - Customizing the home screen..... 18
 - Supported applications..... 18
 - Setting up Forms and Favorites..... 18
 - Setting up Card Copy..... 19
 - Using Shortcut Center..... 19
 - Setting up Scan Center..... 19
 - Setting up Device Quotas..... 20
 - Using QR Code Generator..... 20
 - Configuring Eco-Settings..... 21
 - Using Customer Support..... 21
 - Creating a Cloud Connector profile..... 21
 - Managing bookmarks..... 22
 - Managing contacts..... 23

- Setting up and using the accessibility features..... 25**
 - Enabling Magnification mode..... 25
 - Activating Voice Guidance..... 25
 - Adjusting the Voice Guidance speech rate..... 25
 - Enabling spoken passwords or personal identification numbers..... 25
 - Navigating the screen using gestures..... 26
 - Using the keyboard on the display..... 26

Loading paper and specialty media..... 27

- Setting the size and type of the specialty media..... 27
- Configuring Universal paper settings.....27
- Loading trays..... 27
- Loading the multipurpose feeder..... 29
- Linking trays.....30

Paper support..... 31

- Supported paper sizes..... 31
- Supported paper types..... 34
- Supported paper weights..... 36

Printing.....38

- Printing from a computer.....38
- Printing forms..... 38
- Printing from a mobile device..... 38
- Printing from a flash drive..... 40
- Supported flash drives and file types.....41
- Configuring confidential jobs..... 42
- Printing confidential and other held jobs..... 42
- Printing from a Cloud Connector profile..... 43
- Printing a font sample list..... 43
- Printing a directory list.....44
- Canceling a print job.....44

Copying..... 45

- Using the automatic document feeder and scanner glass..... 45
- Making copies..... 45
- Copying photos.....45
- Copying on letterhead..... 46
- Copying on both sides of the paper.....46
- Reducing or enlarging copies..... 46
- Collating copies..... 46
- Placing separator sheets between copies..... 46
- Copying multiple pages onto a single sheet.....47
- Creating a copy shortcut..... 47

E-mailing.....	48
Using the automatic document feeder and scanner glass.....	48
Configuring the SMTP server for e-mail.....	48
Sending an e-mail.....	49
Creating an e-mail shortcut.....	49
Faxing.....	50
Setting up the printer to fax.....	50
Using the automatic document feeder and scanner glass.....	59
Sending a fax.....	59
Scheduling a fax.....	60
Creating a fax destination shortcut.....	60
Changing the fax resolution.....	61
Adjusting the fax darkness.....	61
Printing a fax log.....	61
Blocking junk faxes.....	61
Holding faxes.....	61
Forwarding a fax.....	61
Scanning.....	62
Using the automatic document feeder and scanner glass.....	62
Scanning to an FTP server.....	62
Creating an FTP shortcut.....	62
Creating a network folder shortcut.....	62
Scanning to a flash drive.....	63
Scanning to a fax server.....	64
Sending scanned documents to a computer.....	64
Scanning to a Cloud Connector profile.....	64
Understanding the printer menus.....	66
Menu map.....	66
Device.....	67
Print.....	83
Paper.....	93
Copy.....	96
Fax.....	101

E-mail.....	114
FTP.....	120
USB Drive.....	124
Network/Ports.....	130
Security.....	142
Reports.....	149
Help.....	150
Troubleshooting.....	151
Printing the Menu Settings Page.....	151
Securing the printer.....	152
Locating the security slot.....	152
Erasing printer memory.....	152
Erasing printer hard disk memory.....	152
Encrypting the printer hard disk.....	153
Restoring factory default settings.....	153
Statement of Volatility.....	153
Maintaining the printer.....	155
Setting up e-mail alerts.....	155
Viewing reports.....	155
Adjusting the speaker volume.....	155
Networking.....	156
Setting up serial printing (Windows only).....	158
Cleaning printer parts.....	159
Ordering parts and supplies.....	164
Replacing parts and supplies.....	168
Storing supplies.....	200
Moving the printer.....	200
Saving energy and paper.....	201
Recycling.....	202
Clearing jams.....	203
Avoiding jams.....	203
Identifying jam locations.....	204
Paper jam in trays.....	205
Paper jam in the multipurpose feeder.....	206

Paper jam in the automatic document feeder.....207

Paper jam in the standard bin..... 209

Paper jam in door B.....210

Paper jam in the finisher bin..... 213

Staple jam in door G.....215

Troubleshooting..... 219

Network connection problems.....219

Hardware options problems..... 221

Issues with supplies..... 223

Paper feed problems..... 225

Printing problems.....228

Color quality problems..... 251

Faxing problems.....254

Scanning problems.....257

Contacting customer support..... 261

Upgrading and migrating.....262

Hardware..... 262

Software..... 278

Firmware.....278

Notices.....280

Index..... 295

Safety information

Conventions

Note: A *note* identifies information that could help you.

Warning: A *warning* identifies something that could damage the product hardware or software.

CAUTION: A *caution* indicates a potentially hazardous situation that could injure you.

Different types of caution statements include:



CAUTION—POTENTIAL INJURY: Indicates a risk of injury.



CAUTION—SHOCK HAZARD: Indicates a risk of electrical shock.



CAUTION—HOT SURFACE: Indicates a risk of burn if touched.



CAUTION—TIPPING HAZARD: Indicates a crush hazard.



CAUTION—PINCH HAZARD: Indicates a risk of being caught between moving parts.

Product statements



CAUTION—POTENTIAL INJURY: To avoid the risk of fire or electrical shock, connect the power cord to an appropriately rated and properly grounded electrical outlet that is near the product and easily accessible.



CAUTION—POTENTIAL INJURY: To avoid the risk of fire or electrical shock, use only the power cord provided with this product or the manufacturer's authorized replacement.



CAUTION—POTENTIAL INJURY: Do not use this product with extension cords, multioutlet power strips, multioutlet extenders, or UPS devices. The power capacity of these types of accessories can be easily overloaded by a laser printer and may result in a risk of fire, property damage, or poor printer performance.



CAUTION—POTENTIAL INJURY: Only a Lexmark Inline Surge Protector that is properly connected between the printer and the power cord provided with the printer may be used with this product. The use of non-Lexmark surge protection devices may result in a risk of fire, property damage, or poor printer performance.



CAUTION—POTENTIAL INJURY: To reduce the risk of fire, use only a 26 AWG or larger telecommunications (RJ-11) cord when connecting this product to the public switched telephone network. For users in Australia, the cord must be approved by the Australian Communications and Media Authority.





CAUTION—SHOCK HAZARD: To avoid the risk of electrical shock, do not place or use this product near water or wet locations.





CAUTION—SHOCK HAZARD: To avoid the risk of electrical shock, do not set up this product or make any electrical or cabling connections, such as the power cord, fax feature, or telephone, during a lightning storm.

 **CAUTION—POTENTIAL INJURY:** Do not cut, twist, bind, crush, or place heavy objects on the power cord. Do not subject the power cord to abrasion or stress. Do not pinch the power cord between objects such as furniture and walls. If any of these things happen, a risk of fire or electrical shock results. Inspect the power cord regularly for signs of such problems. Remove the power cord from the electrical outlet before inspecting it.

 **CAUTION—SHOCK HAZARD:** To avoid the risk of electrical shock, make sure that all external connections (such as Ethernet and telephone system connections) are properly installed in their marked plug-in ports.

 **CAUTION—SHOCK HAZARD:** To avoid the risk of electrical shock, if you are accessing the controller board or installing optional hardware or memory devices sometime after setting up the printer, then turn the printer off, and unplug the power cord from the electrical outlet before continuing. If you have any other devices attached to the printer, then turn them off as well, and unplug any cables going into the printer.

 **CAUTION—SHOCK HAZARD:** To avoid the risk of electrical shock, do not use the fax feature during a lightning storm.





 **CAUTION—SHOCK HAZARD:** To avoid the risk of electrical shock when cleaning the exterior of the printer, unplug the power cord from the electrical outlet and disconnect all cables from the printer before proceeding.

 **CAUTION—POTENTIAL INJURY:** If the printer weight is greater than 20 kg (44 lb), then it may require two or more people to lift it safely.

 **CAUTION—POTENTIAL INJURY:** When moving the printer, follow these guidelines to avoid personal injury or printer damage:

- Make sure that all doors and trays are closed.
- Turn off the printer, and then unplug the power cord from the electrical outlet.
- Disconnect all cords and cables from the printer.
- If the printer has separate floor-standing optional trays or output options attached to it, then disconnect them before moving the printer.
- If the printer has a caster base, then carefully roll it to the new location. Use caution when passing over thresholds and breaks in flooring.
- If the printer does not have a caster base but is configured with optional trays or output options, then remove the output options and lift the printer off the trays. Do not try to lift the printer and any options at the same time.
- Always use the handholds on the printer to lift it.
- Any cart used to move the printer must have a surface able to support the full footprint of the printer.
- Any cart used to move the hardware options must have a surface able to support the dimensions of the options.
- Keep the printer in an upright position.
- Avoid severe jarring movements.
- Make sure that your fingers are not under the printer when you set it down.
- Make sure that there is adequate clearance around the printer.

 **CAUTION—TIPPING HAZARD:** Installing one or more options on your printer or MFP may require a caster base, furniture, or other feature to prevent instability causing possible injury. For more information on supported configurations, see www.lexmark.com/multifunctionprinters.

-  **CAUTION—TIPPING HAZARD:** To reduce the risk of equipment instability, load each tray separately. Keep all other trays closed until needed.
-  **CAUTION—HOT SURFACE:** The inside of the printer might be hot. To reduce the risk of injury from a hot component, allow the surface to cool before touching it.
-  **CAUTION—PINCH HAZARD:** To avoid the risk of a pinch injury, use caution in areas marked with this label. Pinch injuries may occur around moving parts, such as gears, doors, trays, and covers.
-  **CAUTION—POTENTIAL INJURY:** This product uses a laser. Use of controls or adjustments or performance of procedures other than those specified in the *User's Guide* may result in hazardous radiation exposure.
-  **CAUTION—POTENTIAL INJURY:** The lithium battery in this product is not intended to be replaced. There is a danger of explosion if a lithium battery is incorrectly replaced. Do not recharge, disassemble, or incinerate a lithium battery. Discard used lithium batteries according to the manufacturer's instructions and local regulations.

This product is designed, tested, and approved to meet strict global safety standards with the use of specific manufacturer's components. The safety features of some parts may not always be obvious. The manufacturer is not responsible for the use of other replacement parts.

Refer service or repairs, other than those described in the user documentation, to a service representative.

This product uses a printing process that heats the print media, and the heat may cause the media to release emissions. You must understand the section in your operating instructions that discusses the guidelines for selecting print media to avoid the possibility of harmful emissions.

This product may produce small amounts of ozone during normal operation, and may be equipped with a filter designed to limit ozone concentrations to levels well below the recommended exposure limits. To avoid high ozone concentration levels during extensive usage, install this product in a well-ventilated area and replace the ozone and exhaust filters if instructed to do so in the product maintenance instructions. If there are no references to filters in the product maintenance instructions, then there are no filters requiring replacement for this product.

SAVE THESE INSTRUCTIONS.

Learning about the printer

Finding information about the printer

What are you looking for?	Find it here
Initial setup instructions: <ul style="list-style-type: none"> • Connecting the printer • Installing the printer software 	See the setup documentation that came with the printer or go to http://support.lexmark.com .
More setup and instructions for using the printer: <ul style="list-style-type: none"> • Selecting and storing paper and specialty media • Loading paper • Configuring printer settings • Viewing and printing documents and photos • Setting up and using the printer software • Configuring the printer on a network • Caring for and maintaining the printer • Troubleshooting and solving problems 	<i>Information Center</i> —Go to http://infoserve.lexmark.com . <i>Help Menu Pages</i> —Access the guides on the printer firmware or go to http://support.lexmark.com . <i>Touch Screen Guide</i> —Go to http://support.lexmark.com . Product videos—Go to http://infoserve.lexmark.com/idv/ .
Information on setting up and configuring the accessibility features of your printer	<i>Lexmark Accessibility Guide</i> —Go to http://support.lexmark.com .
Help using the printer software	Help for Microsoft Windows or Macintosh operating systems—Open a printer software program or application, and then click Help . Click  to view context-sensitive information. Notes: <ul style="list-style-type: none"> • Help is automatically installed with the printer software. • Depending on the operating system, the printer software is located in the printer program folder or on the desktop.

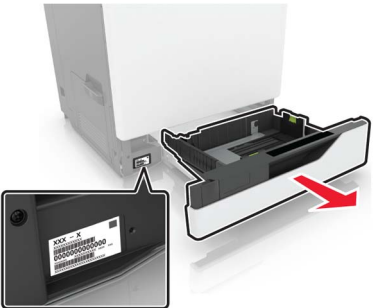
What are you looking for?	Find it here
<p>The latest supplemental information, updates, and customer support:</p> <ul style="list-style-type: none"> • Documentation • Driver downloads • Live chat support • E-mail support • Voice support 	<p>Go to http://support.lexmark.com.</p> <p>Note: Select your country or region, and then select your product to view the appropriate support site.</p> <p>Support contact information for your country or region can be found on the website or on the printed warranty that came with the printer.</p> <p>Have the following information ready when you contact customer support:</p> <ul style="list-style-type: none"> • Place and date of purchase • Machine type and serial number 
<ul style="list-style-type: none"> • Safety information • Regulatory information • Warranty information • Environmental information 	<p>Warranty information varies by country or region:</p> <ul style="list-style-type: none"> • In the U.S.—See the Statement of Limited Warranty included with the printer, or go to http://support.lexmark.com. • In other countries and regions—See the printed warranty that came with the printer. <p><i>Product Information Guide</i>—See the documentation that came with the printer or go to http://support.lexmark.com.</p>

Selecting a location for the printer

When selecting a location for the printer, leave enough room to open trays, covers, and doors and to install hardware options.

- Set up the printer near an electrical outlet.

 **CAUTION—POTENTIAL INJURY:** To avoid the risk of fire or electrical shock, connect the power cord to an appropriately rated and properly grounded electrical outlet that is near the product and easily accessible.

 **CAUTION—SHOCK HAZARD:** To avoid the risk of electrical shock, do not place or use this product near water or wet locations.

- Make sure that airflow in the room meets the latest revision of the ASHRAE 62 standard or the CEN Technical Committee 156 standard.
- Provide a flat, sturdy, and stable surface.

- Keep the printer:
 - Clean, dry, and free of dust.
 - Away from stray staples and paper clips.
 - Away from the direct airflow of air conditioners, heaters, or ventilators.
 - Free from direct sunlight and humidity extremes.
- Observe the recommended temperatures and avoid fluctuations:

Ambient temperature	10 to 32.2°C (50 to 90°F)
Storage temperature	-40 to 43.3°C (-40 to 110°F)

- Allow the following recommended amount of space around the printer for proper ventilation:

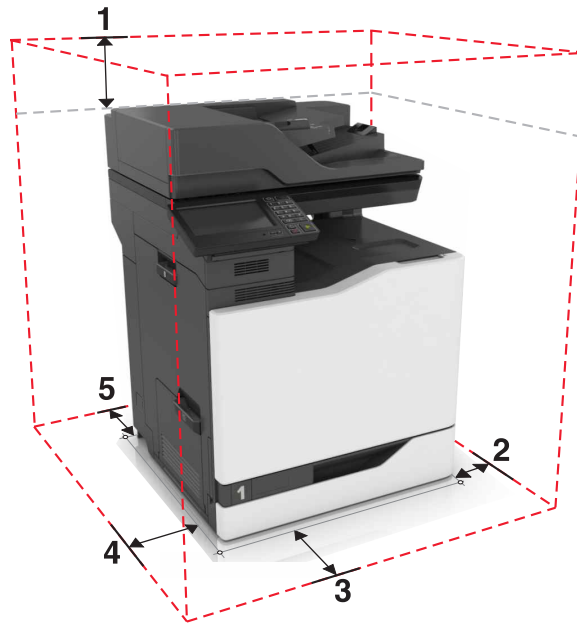

1	Top	330 mm (13 in.)
2	Right side	152 mm (6 in.)
3	Front	381 mm (15 in.)
4	Left side	457 mm (18 in.)
5	Rear	203 mm (8 in.)

Printer configurations

CAUTION—TIPPING HAZARD: Installing one or more options on your printer or MFP may require a caster base, furniture, or other feature to prevent instability causing possible injury. For more information on supported configurations, see www.lexmark.com/multifunctionprinters.

You can configure your printer by adding an optional 2200-sheet tray or a combination of up to three optional 550-sheet trays or envelope trays.

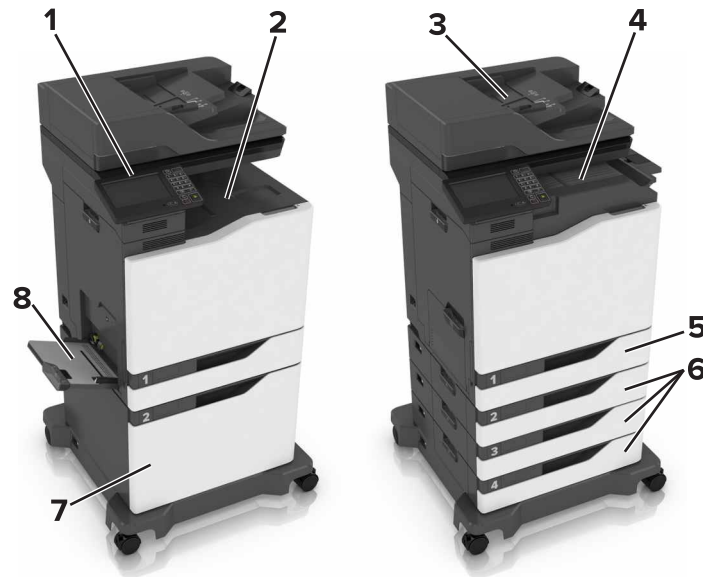

1	Control panel
2	Standard bin
3	Automatic document feeder (ADF)
4	Staple finisher
5	Standard 550-sheet tray
6	Optional 550-sheet trays or envelope trays
7	Optional 2200-sheet tray
8	Multipurpose feeder

Attaching cables

- ⚠ CAUTION—SHOCK HAZARD:** To avoid the risk of electrical shock, do not set up this product or make any electrical or cabling connections, such as the power cord, fax feature, or telephone, during a lightning storm.
- ⚠ CAUTION—POTENTIAL INJURY:** To avoid the risk of fire or electrical shock, connect the power cord to an appropriately rated and properly grounded electrical outlet that is near the product and easily accessible.
- ⚠ CAUTION—POTENTIAL INJURY:** To avoid the risk of fire or electrical shock, use only the power cord provided with this product or the manufacturer's authorized replacement.
- ⚠ CAUTION—POTENTIAL INJURY:** To reduce the risk of fire, use only a 26 AWG or larger telecommunications (RJ-11) cord when connecting this product to the public switched telephone network. For users in Australia, the cord must be approved by the Australian Communications and Media Authority.

Warning—Potential Damage: To avoid loss of data or printer malfunction, do not touch the USB cable, any wireless network adapter, or the printer in the areas shown while actively printing.

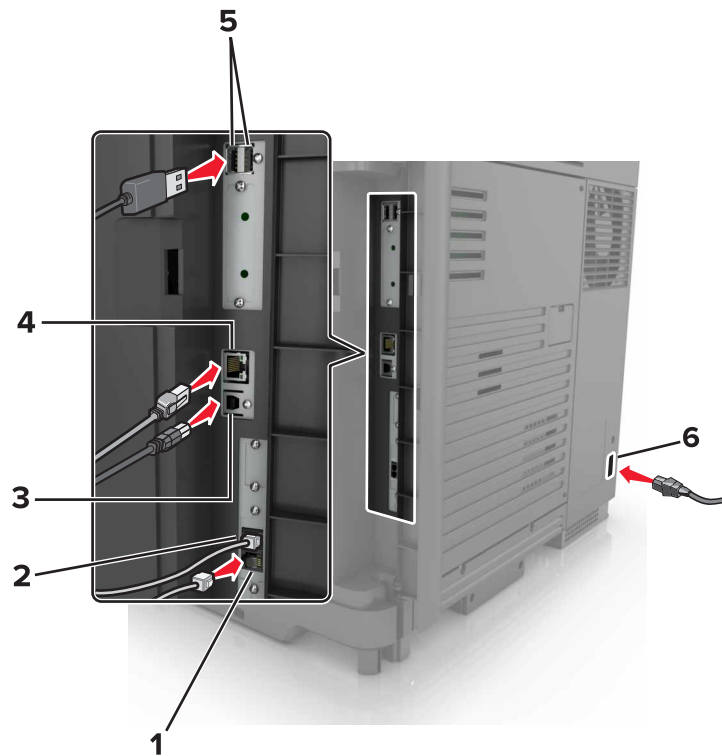

	Printer port	Function
1	EXT port	Connect more devices (telephone or answering machine) to the printer and the telephone line. Use this port if you do not have a dedicated fax line for the printer and if this connection method is supported in your country or region. Note: Remove the plug to access the port.
2	LINE port	Connect the printer to an active telephone line through a standard wall jack (RJ-11), DSL filter, or VoIP adapter, or any other adapter that allows you to access the telephone line to send and receive faxes.
3	USB printer port	Connect the printer to a computer.
4	Ethernet port	Connect the printer to a network.
5	USB ports	Attach a keyboard or any compatible option.
6	Power cord socket	Connect the printer to a properly grounded electrical outlet.

Using the control panel

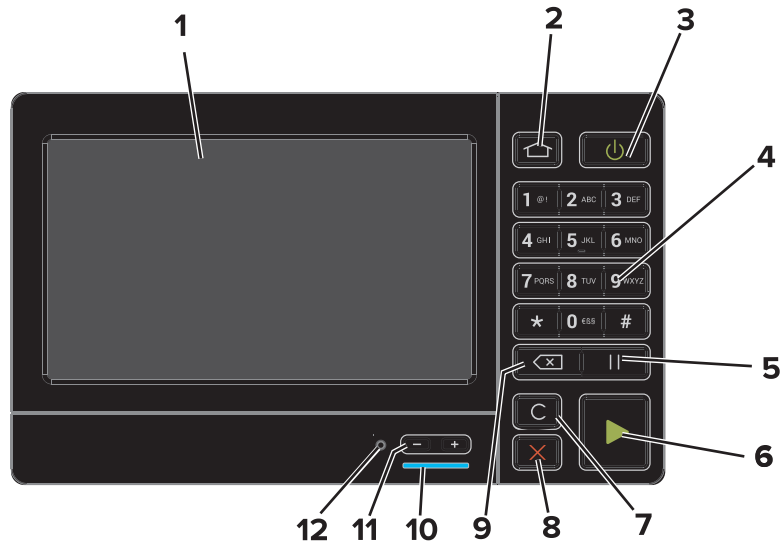

	Use the	To
1	Display	<ul style="list-style-type: none"> View the printer messages and supply status. Set up and operate the printer.
2	Home button	Go to the home screen.
3	Power button	<ul style="list-style-type: none"> Turn on or turn off the printer. <p>Note: To turn off the printer, press and hold the power button for five seconds.</p> <ul style="list-style-type: none"> Set the printer to Sleep or Hibernate mode. Wake the printer from Sleep or Hibernate mode.
4	Keypad	Enter numbers or symbols in an input field.
5	Pause button	Place a dial pause in a fax number.
6	Start button	Start a job, depending on which mode is selected.
7	Clear all or Reset button	Reset the default settings of a function such as copying, faxing, or scanning.
8	Stop or Cancel button	Stop the current job.
9	Backspace button	Move the cursor backward and delete a character in an input field.
10	Indicator light	Check the status of the printer.
11	Volume buttons	Adjust the volume of the headset or speaker.
12	Headset or speaker port	Attach a headset or speaker.

Understanding the status of the power button and indicator light

Indicator light	Printer status
Off	The printer is off or in Hibernate mode.
Blue	The printer is ready or processing data.
Red	The printer requires user intervention.

Power button light	Printer status
Off	The printer is off, ready, or processing data.
Solid amber	The printer is in sleep mode.
Blinking amber	The printer is in hibernate mode.

Using the home screen

Note: Your home screen may vary depending on your home screen customization settings, administrative setup, and active embedded solutions.

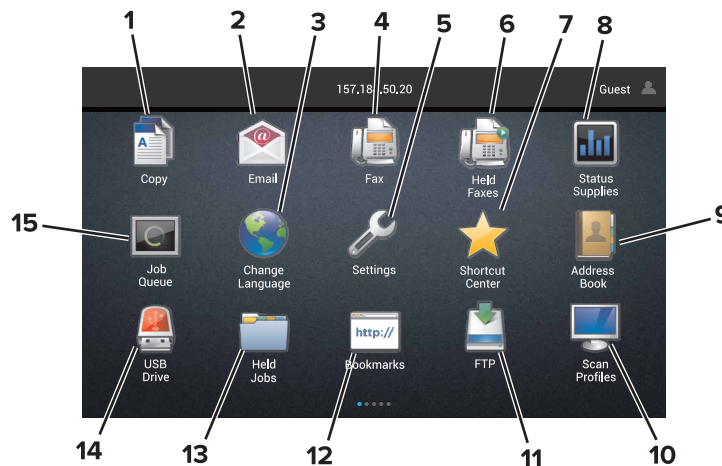

Touch	To
1	Copy Make copies.
2	E-mail Send e-mails.
3	Change Language Change the language on the printer display.
4	Fax Send fax.
5	Settings Access the printer menus.
6	Held Faxes Show all the current held fax jobs. Note: If Held Faxes is hidden, then Release Held Faxes appears.
7	Shortcut Center Organize all shortcuts.

Touch		To
8	Status/Supplies	<ul style="list-style-type: none"> • Show a printer warning or error message whenever the printer requires intervention to continue processing. • View more information on the printer warning or message, and on how to clear it. <p>Note: You can also access this setting by touching the top section of the home screen.</p>
9	Address Book	Access, create, and organize contacts.
10	Scan Profiles	Scan and save documents directly to the computer.
11	FTP	Scan and save documents directly to an FTP server.
12	Bookmarks	Organize all bookmarks.
13	Held Jobs	Show all the current held print jobs
14	USB Drive	View, select, or print photos and documents from a flash drive.
15	Job Queue	<p>Show all the current print jobs.</p> <p>Note: You can also access this setting by touching the top section of the home screen.</p>

These settings may also appear on the home screen

Touch	To
App Profiles	Access application profiles.
Lock Device	Prevent users from accessing any printer functions from the home screen.

Setting up and using the home screen applications

Customizing the home screen

- 1 From the control panel, touch **Settings** > **Device** > **Visible Home Screen Icons**.
- 2 Select the icons that you want to appear on the home screen.
- 3 Apply the changes.

Supported applications

Application	Printer models
Scan Center	CX820, CX827, XC6152, XC6153
Shortcut Center	CX820, CX827, XC6152, XC6153
Card Copy	CX820, CX827, XC6152, XC6153
Display Customization	CX820, CX827, XC6152, XC6153
Forms and Favorites	CX820, CX827, XC6152, XC6153
Customer Support	XC6152, XC6153
Device Quotas	XC6152, XC6153
QR Code	XC6152, XC6153
Eco-Settings	XC6152, XC6153
Cloud Connector	XC6152, XC6153

Setting up Forms and Favorites

- 1 Open a Web browser, and then type the printer IP address in the address field.

Notes:

- View the printer IP address on the printer home screen. The IP address appears as four sets of numbers separated by periods, such as 123.123.123.123.
- If you are using a proxy server, then temporarily disable it to load the Web page correctly.

- 2 Click **Apps** > **Forms and Favorites** > **Configure**.

- 3 Click **Add**, and then customize the settings.

Notes:

- To make sure that the location settings of the bookmark are correct, type the IP address of the host computer where the bookmark is located.

- Make sure that the printer has access rights to the folder where the bookmark is located.

4 Apply the changes.

Setting up Card Copy

1 Open a Web browser, and then type the printer IP address in the address field.

Notes:

- View the printer IP address on the printer home screen. The IP address appears as four sets of numbers separated by periods, such as 123.123.123.123.
- If you are using a proxy server, then temporarily disable it to load the Web page correctly.

2 Click **Apps > Card Copy > Configure**.

3 Configure the output options and scan settings.

Notes:

- When scanning a card, make sure that the scan resolution does not exceed 200 dpi for color and 400 dpi for black and white.
- When scanning multiple cards, make sure that the scan resolution does not exceed 150 dpi for color and 300 dpi for black and white.
- You need a printer hard disk to scan multiple cards.
- Make sure that the printer network and e-mail settings are configured.

4 Apply the changes.

Using Shortcut Center

1 From the home screen, touch **Shortcut Center**, and then select a printer function.

2 Touch **Create Shortcut**, and then configure the settings.

3 Touch **Save**, and then type a unique shortcut name.

4 Apply the changes.

Setting up Scan Center

1 From the home screen, touch **Scan Center**.

2 Select and create a destination, and then configure the settings.

Notes:

- When creating a network destination, make sure to validate and adjust the settings until no errors occur.
- Only destinations created from the Embedded Web Server are saved. For more information, see the documentation that came with the solution.

3 Apply the changes.

Setting up Device Quotas

Notes:

- This application is supported only in some printer models. For more information, see [“Supported applications” on page 18](#).
- You may need administrative rights to access the application.

1 Open a web browser, and then type the printer IP address in the address field.

Notes:

- View the printer IP address on the printer home screen. The IP address appears as four sets of numbers separated by periods, such as 123.123.123.123.
- If you are using a proxy server, then temporarily disable it to load the web page correctly.

2 Click **Apps > Device Quotas > Configure**.

3 In the User Accounts section, add or edit a user, and then set the user quota.

4 Apply the changes.

Note: For information on how to configure the application and its security settings, see the *Device Quotas Administrator’s Guide*.

Using QR Code Generator

Notes:

- This application is supported only in some printer models. For more information, see [“Supported applications” on page 18](#).
- You may need administrative rights to access the application.

1 Open a web browser, and then type the printer IP address in the address field.

Notes:

- View the printer IP address on the printer home screen. The IP address appears as four sets of numbers separated by periods, such as 123.123.123.123.
- If you are using a proxy server, then temporarily disable it to load the web page correctly.

2 Click **Apps > QR Code Generator > Configure**.

3 Do either of the following:

- Select a default QR code value.
- Type a QR code value.

4 Apply the changes.

Configuring Eco-Settings

Note: This application is supported only in some printer models. For more information, see [“Supported applications” on page 18](#).

- 1 From the home screen, touch **Eco-Settings**.
- 2 Configure the Eco-Mode settings or schedule a power-saving mode.

Using Customer Support

Note: This application is supported only in some printer models. For more information, see [“Supported applications” on page 18](#).

- 1 From the home screen, touch **Customer Support**.
- 2 Print or e-mail the information.

Note: For information on configuring the application settings, see the *Customer Support Administrator’s Guide*.

Creating a Cloud Connector profile

Note: This application is available only in certain country or region. For more information, contact your Lexmark representative.

- 1 From the home screen, touch **Cloud Connector**.
- 2 Select a cloud service provider.
- 3 Touch **Create** or .

- 4 Type a unique profile name.

Note: We recommend creating a PIN to protect the profile.

- 5 Touch **OK**, and then take note of the authorization code.

Note: The authorization code is valid only for 24 hours.

- 6 Open a web browser, and then go to <https://lexmark.cloud-connect.co>.

- 7 Click **Next**, and then accept the Terms of Use.

- 8 Enter the authorization code, and then click **Connect**.

- 9 Log in to your cloud service provider account.

- 10 Grant permissions.

Note: To complete the authorization process, open the profile within 72 hours.

Managing bookmarks

Creating bookmarks

Use bookmarks to print frequently accessed documents that are stored in servers or on the web.

- 1 Open a web browser, and then type the printer IP address in the address field.

Notes:

- View the printer IP address on the printer home screen. The IP address appears as four sets of numbers separated by periods, such as 123.123.123.123.
- If you are using a proxy server, then temporarily disable it to load the web page correctly.

- 2 Click **Bookmarks > Add Bookmark**, and then type a bookmark name.

- 3 Select an Address protocol type, and then do one of the following:

- For HTTP and HTTPS, type the URL that you want to bookmark.
- For HTTPS, make sure to use the host name instead of the IP address. For example, type **myWebsite.com/sample.pdf** instead of typing **123.123.123.123/sample.pdf**. Make sure that the host name also matches the Common Name (CN) value in the server certificate. For more information on obtaining the CN value in the server certificate, see the help information for your web browser.
- For FTP, type the FTP address. For example, **myServer/myDirectory**. Enter the FTP port. Port 21 is the default port for sending commands.
- For SMB, type the network folder address. For example, **myServer/myShare/myFile.pdf**. Type the network domain name.
- If necessary, select the Authentication type for FTP and SMB.

To limit access to the bookmark, enter a PIN.

Note: The application supports the following file types: PDF, JPEG, TIFF, and HTML-based web pages. Other file types such as DOCX and XLXS are supported in some printer models.

- 4 Click **Save**.

Creating folders

- 1 Open a web browser, and then type the printer IP address in the address field.

Notes:

- View the printer IP address on the printer home screen. The IP address appears as four sets of numbers separated by periods, such as 123.123.123.123.
- If you are using a proxy server, then temporarily disable it to load the web page correctly.

- 2 Click **Bookmarks > Add Folder**, and then type a folder name.

Note: To limit access to the folder, enter a PIN.

- 3 Click **Save**.

Note: You can create folders or bookmarks inside a folder. To create a bookmark, see [“Creating bookmarks” on page 22](#).

Managing contacts

Adding contacts

- 1 Open a web browser, and then type the printer IP address in the address field.

Notes:

- View the printer IP address on the printer home screen. The IP address appears as four sets of numbers separated by periods, such as 123.123.123.123.
- If you are using a proxy server, then temporarily disable it to load the web page correctly.

- 2 Click **Address Book**.

- 3 From the Contacts section, add a contact.

Note: You can assign the contact to one or more groups.

- 4 If necessary, specify a login method to allow application access.

- 5 Apply the changes.

Adding groups

- 1 Open a web browser, and then type the printer IP address in the address field.

Notes:

- View the printer IP address on the printer home screen. The IP address appears as four sets of numbers separated by periods, such as 123.123.123.123.
- If you are using a proxy server, then temporarily disable it to load the web page correctly.

- 2 Click **Address Book**.

- 3 From the Contact Groups section, add a group name.

Note: You can assign one or more contacts to the group.

- 4 Apply the changes.

Editing contacts or groups

- 1 Open a web browser, and then type the printer IP address in the address field.

Notes:

- View the printer IP address on the printer home screen. The IP address appears as four sets of numbers separated by periods, such as 123.123.123.123.
- If you are using a proxy server, then temporarily disable it to load the web page correctly.

- 2 Click **Address Book**.

3 Do either of the following:

- From the Contacts section, click a contact name, and then edit the information.
- From the Contact Groups section, click a group name, and then edit the information.

4 Apply the changes.

Deleting contacts or groups

1 Open a web browser, and then type the printer IP address in the address field.

Notes:

- View the printer IP address on the printer home screen. The IP address appears as four sets of numbers separated by periods, such as 123.123.123.123.
- If you are using a proxy server, then temporarily disable it to load the web page correctly.

2 Click **Address Book**.

3 Do either of the following:

- From the Contacts section, select a contact that you want to delete.
- From the Contact Groups section, select a group name that you want to delete.

Setting up and using the accessibility features

Enabling Magnification mode

- 1 From the control panel, press and hold the **5** key until you hear a voice message.
- 2 Select **Magnification mode**.
- 3 Select **OK**.

For more information on navigating a magnified screen, see [“Navigating the screen using gestures” on page 26](#).

Activating Voice Guidance

From the control panel

- 1 Press and hold the **5** key until you hear a voice message.
- 2 Select **OK**.

From the keyboard

- 1 Press and hold the **5** key until you hear a voice message.
- 2 Press **Tab** to navigate the focus cursor to the OK button, and then press **Enter**.

Notes:

- Voice Guidance is also activated when you insert headphones into the headphone jack.
- To adjust the volume, use the volume buttons at the bottom part of the control panel.

Adjusting the Voice Guidance speech rate

- 1 From the home screen, select **Settings > Device > Accessibility > Speech Rate**.
- 2 Select the speech rate.

Enabling spoken passwords or personal identification numbers

- 1 From the home screen, select **Settings > Device > Accessibility > Speak Passwords/PINs**.
- 2 Enable the setting.

Navigating the screen using gestures

Notes:

- The gestures are applicable only when Voice Guidance is activated.
- Enable Magnification to use the zoom and pan gestures.
- Use a physical keyboard to type characters and adjust certain settings.

Gesture	Function
Double-tap	Select an option or item on the screen.
Triple-tap	Zoom in or zoom out text and images.
Swipe right or swipe down	Move to the next item on the screen.
Swipe left or swipe up	Move to the previous item on the screen.
Pan	Access parts of the zoomed image that are beyond the limits of the screen. Note: This gesture requires the use of two fingers to drag across a zoomed image.
Swipe up then left	Exit an application and return to the home screen.
Swipe down then left	<ul style="list-style-type: none"> • Cancel a job. • Go back to the previous setting. • Exit the screen that appears without changing any setting or value.
Swipe up then down	Repeat a spoken prompt.

Using the keyboard on the display

Do one or more of the following:

- Drag a finger over the key to announce the character.
- Lift the finger to enter or type the character in the field.
- Select **Backspace** to delete characters.
- To hear the content in the input field, select **Tab**, and then select **Shift + Tab**.

Loading paper and specialty media

Setting the size and type of the specialty media

The trays automatically detect the size of plain paper. For specialty media like labels, card stock, or envelopes, do the following:

- 1 From the home screen, navigate to:
Settings > Paper > Tray Configuration > Paper Size/Type > select a paper source
- 2 Set the size and type of the specialty media.

Configuring Universal paper settings

- 1 From the home screen, touch **Settings > Paper > Media Configuration > Universal Setup**.
- 2 Configure the settings.

Loading trays

 **CAUTION—TIPPING HAZARD:** To reduce the risk of equipment instability, load each tray separately. Keep all other trays closed until needed.

- 1 Pull out the tray.

Note: To avoid paper jams, do not remove trays while the printer is busy.



- 2 Adjust the guides to match the size of the paper that you are loading.

Note: Use the indicators on the bottom of the tray to position the guides.

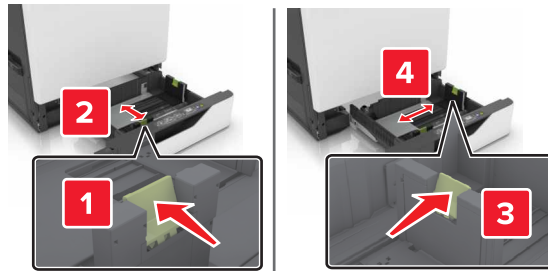

3 Flex, fan, and align the paper edges before loading.

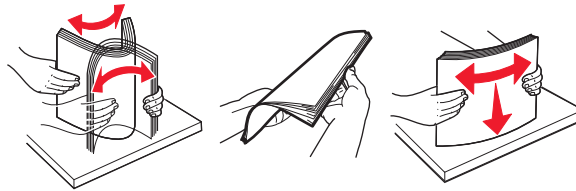

4 Load the paper with the printable side faceup.

Note: Load envelopes only in the optional envelope tray.

Warning—Potential Damage: Do not use envelopes with stamps, clasps, snaps, windows, coated linings, or self-stick adhesives in the optional envelope tray.

Notes:

- Load letterhead faceup with the header on the left side of the tray for one-sided printing.
- Load letterhead facedown with the header on the right side of the tray for two-sided printing.
- Load letterhead faceup with the header on the right side of the tray for one-sided print jobs that require finishing.
- Load letterhead facedown with the header on the left side of the tray for two-sided print jobs that require finishing.
- Load pre-punched paper with the holes toward the front or left side of the tray.
- Load envelopes with the flap side down and against the back side of the tray. Load European envelopes with the flap side down and against the left side of the tray.
- Do not slide paper into the tray.
- Make sure that the stack height is below the maximum paper fill indicator. Overfilling may cause paper jams.



5 Insert the tray.

If loading a paper type other than plain, set the paper size and paper type in the Paper menu to match the paper loaded.

Loading the multipurpose feeder

1 Open the multipurpose feeder.



2 Adjust the guide to match the size of the paper you are loading.

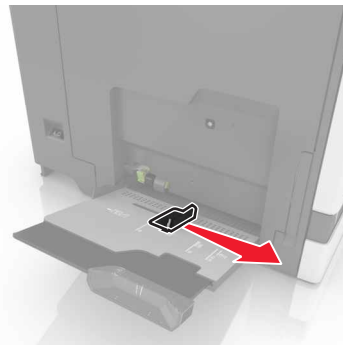

3 Flex, fan, and align the paper edges before loading.

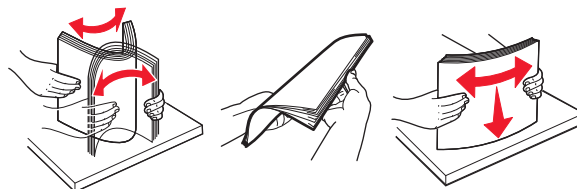

4 Load the paper.

- Load paper, card stock, and transparencies with the printable side facedown and the top edge entering the printer first.

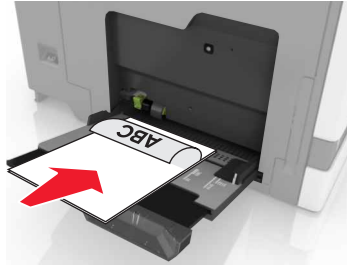

- Load envelopes with the flap side up and against the left side of the paper guide. Load European envelopes with the flap side up and entering the printer first.

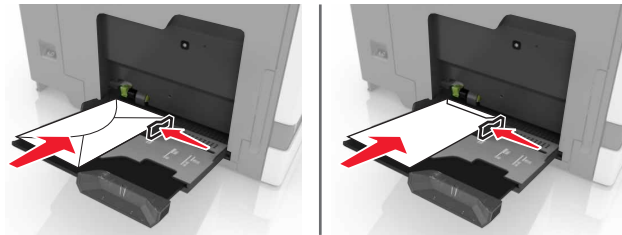

Warning—Potential Damage: Do not use envelopes with stamps, clasps, snaps, windows, coated linings, or self-stick adhesives.

5 From the control panel, set the paper size and type to match the paper loaded in the tray.

Linking trays

- 1 From the home screen, touch **Settings > Paper > Tray Configuration** > select a paper source.
- 2 Set the same paper size and paper type for the trays that you are linking.
- 3 From the home screen, touch **Settings > Device > Maintenance > Configuration Menu > Tray Configuration > Tray Linking**.
- 4 Touch **Automatic**.

To unlink trays, make sure that no trays have the same paper size and paper type settings.

Warning—Potential Damage: The temperature of the fuser varies according to the specified paper type. To avoid printing issues, match the paper type setting in the printer with the paper loaded in the tray.

Paper support

Supported paper sizes

Supported input sizes

Paper size	Dimensions	550-sheet tray	2200-sheet tray	Envelope tray	Multipurpose feeder ¹	Two-sided printing	ADF
3 x 5	76.2 x 127 mm (3 x 5 in.)	X	X	X	✓	X	X
4 x 6	101.6 x 152.4 mm (4 x 6 in.)	X	X	X	✓	X	X
A4	210 x 297 mm (8.3 x 11.7 in.)	✓	✓	X	✓	✓	✓
A5 landscape	210 x 148 mm (8.3 x 5.8 in.)	✓	✓	X	✓	✓	X
A5 portrait²	148 x 210 mm (5.8 x 8.3 in.)	✓	X	X	✓	✓	✓
A6	105 x 148 mm (4.1 x 5.8 in.)	X	X	X	✓	✓	✓
Banner	Max width: 215.9 mm (8.5 in.) Max length: 1320.8 mm (52 in.)	X	X	X	✓	X	X
Executive	184.2 x 266.7 mm (7.3 x 10.5 in.)	✓	X	X	✓	✓	✓
Folio	215.9 x 330.2 mm (8.5 x 13 in.)	✓	✓	X	✓	✓	✓
JIS B5	182 x 257 mm (7.2 x 10.1 in.)	✓	X	X	✓	✓	✓
Legal	215.9 x 355.6 mm (8.5 x 14 in.)	✓	✓	X	✓	✓	✓
Letter	215.9 x 279.4 mm (8.5 x 11 in.)	✓	✓	X	✓	✓	✓
Oficio	216 x 340 mm (8.5 x 13.4 in.)	✓	✓	X	✓	✓	✓

¹ This paper source does not support automatic size sensing.

² A5 portrait reports as Universal in the standard and optional 550-sheet trays.

Paper size	Dimensions	550-sheet tray	2200-sheet tray	Envelope tray	Multipurpose feeder ¹	Two-sided printing	ADF
Statement	139.7 x 215.9 mm (5.5 x 8.5 in.)	✓	✗	✗	✓	✓	✓
Universal	139.7 x 148 mm to 215.9 x 355.6 mm (5.5 x 5.8 in. to 8.5 x 14 in.)	✗	✗	✗	✓	✗	✗
Universal	76.2 x 127 mm to 229 x 359.9 mm (3 x 5 in. to 9 x 14.2 in.)	✓	✗	✗	✓	✓	✗
Universal	98.4 x 162 mm to 176 x 250 mm (3.9 x 6.4 in. to 6.9 x 9.8 in.)	✗	✗	✓	✗	✗	✗
Universal	210 x 215.9 mm to 210 x 1321 mm (8.27 x 8.5 in. to 8.27 x 52 in.)	✗	✗	✗	✓	✗	✗
7 3/4 Envelope	98 x 190.5 mm (3.9 x 7.5 in.)	✗	✗	✓	✓	✗	✗
9 Envelope	98.4 x 225.4 mm (3.86 x 8.9 in.)	✗	✗	✓	✓	✗	✗
10 Envelope	104.8 x 241.3 mm (4.1 x 9.5 in.)	✗	✗	✓	✓	✗	✗
B5 Envelope	176 x 250 mm (6.9 x 9.8 in.)	✗	✗	✓	✓	✗	✗
C4 Envelope	229 x 324 mm (9 x 13 in.)	✗	✗	✗	✓	✗	✗
C5 Envelope	162 x 229 mm (6.4 x 9 in.)	✗	✗	✓	✓	✗	✗
DL Envelope	110 x 220 mm (4.3 x 8.7 in.)	✗	✗	✓	✓	✗	✗
Other Envelope	98.4 x 162 mm to 229 x 359.9 mm (3.9 x 6.4 in. to 9 x 14.2 in.)	✗	✗	✗	✓	✗	✗

¹ This paper source does not support automatic size sensing.

² A5 portrait reports as Universal in the standard and optional 550-sheet trays.

Supported output sizes

Paper size	Dimensions	Standard bin	Staple finisher		Multiposition staple, hole punch finisher			
			Offset	Staple	Offset	Staple	Hole punch	2-bin mailbox
3 x 5	76.2 x 127 mm (3 x 5 in.)	✓	X	X	✓	X	X	✓
4 x 6	101.6 x 152.4 mm (4 x 6 in.)	✓	X	X	✓	X	X	✓
A4	210 x 297 mm (8.3 x 11.7 in.)	✓	✓	✓	✓	✓	✓	✓
A5 landscape	210 x 148 mm (8.3 x 5.8 in.)	✓	✓	X	✓	✓	X	✓
A5 portrait*	148 x 210 mm (5.8 x 8.3 in.)	✓	X	X	✓	X	✓	✓
A6	105 x 148 mm (4.1 x 5.8 in.)	✓	X	X	✓	X	X	X
Executive	184.2 x 266.7 mm (7.3 x 10.5 in.)	✓	✓	X	✓	✓	✓	✓
Folio	215.9 x 330.2 mm (8.5 x 13 in.)	✓	✓	✓	✓	✓	✓	✓
JIS B5	182 x 257 mm (7.2 x 10.1 in.)	✓	✓	X	✓	✓	✓	✓
Legal	215.9 x 355.6 mm (8.5 x 14 in.)	✓	✓	✓	✓	✓	X	✓
Letter	215.9 x 279.4 mm (8.5 x 11 in.)	✓	✓	✓	✓	✓	✓	✓
Oficio	216 x 340 mm (8.5 x 13.4 in.)	✓	✓	✓	✓	✓	✓	✓
Statement	139.7 x 215.9 mm (5.5 x 8.5 in.)	✓	X	X	✓	X	✓	✓
Universal	139.7 x 148 mm to 215.9 x 359.9 mm (5.5 x 5.8 in. to 8.5 x 14.2 in.)	✓	X	X	✓	X	X	X
Universal	76.2 x 127 mm to 229 x 359.9 mm (3 x 5 in. to 9 x 14.2 in.)	✓	X	✓	✓	X	X	X

* A5 portrait reports as Universal in the standard and optional 550-sheet trays.

Paper size	Dimensions	Standard bin	Staple finisher		Multiposition staple, hole punch finisher			
			Offset	Staple	Offset	Staple	Hole punch	2-bin mailbox
Universal	98.4 x 162 mm to 176 x 250 mm (3.9 x 6.4 in. to 6.9 x 9.8 in.)	✓	X	X	X	X	X	X
Universal	210 x 215.9 mm to 210 x 1321 mm (8.27 x 8.5 in. to 8.27 x 52 in.)	✓	X	X	X	X	X	X
7 3/4 Envelope	98 x 190.5 mm (3.9 x 7.5 in.)	✓	X	X	X	X	X	X
9 Envelope	98.4 x 225.4 mm (3.86 x 8.9 in.)	✓	X	X	X	X	X	X
10 Envelope	104.8 x 241.3 mm (4.1 x 9.5 in.)	✓	X	X	X	X	X	X
B5 Envelope	176 x 250 mm (6.9 x 9.8 in.)	✓	X	X	X	X	X	X
C4 Envelope	229 x 324 mm (9 x 13 in.)	✓	X	X	X	X	X	X
C5 Envelope	162 x 229 mm (6.4 x 9 in.)	✓	X	X	X	X	X	X
DL Envelope	110 x 220 mm (4.3 x 8.7 in.)	✓	X	X	X	X	X	X
Other Envelope	98.4 x 162 mm to 229 x 359.9 mm (3.9 x 6.4 in. to 9 x 14.2 in.)	✓	X	X	X	X	X	X

* A5 portrait reports as Universal in the standard and optional 550-sheet trays.

Supported paper types

Supported input types

Note: Labels, envelopes, and card stock always print at reduced speed.

Paper type	550-sheet tray	2200-sheet tray	Envelope tray	Multipurpose feeder	Two-sided printing	ADF
Plain Paper	✓	✓	X	✓	✓	✓
Card Stock ²	✓ ¹	X	X	✓ ¹	✓	X
Recycled	✓	✓	X	✓	✓	✓
Glossy	✓	✓	X	✓	✓	X
Heavy Glossy	✓	✓	X	✓	✓	X
Labels	✓	X	X	✓	X	X
Vinyl Labels	✓	X	X	✓	X	X
Bond	✓	✓	X	✓	✓	✓
Envelope	X	X	✓	✓	X	X
Rough Envelope	X	X	✓	✓	X	X
Transparency	X	X	X	✓	X	X
Letterhead	✓	✓	X	✓	✓	✓
Preprinted	✓	✓	X	✓	✓	✓
Colored Paper	✓	✓	X	✓	✓	✓
Light Paper	✓	✓	X	✓	✓	✓
Heavy Paper	✓	✓	X	✓	✓	✓
Rough Cotton	✓	✓	X	✓	✓	✓

¹ Supports up to 176 g/m² of card stock weight.

² Card stock that weighs more than 176 g/m² is supported only in one-sided printing using the standard 550-sheet tray.

Supported output types

Paper type	Staple finisher			Multiposition staple, hole punch finisher		
	Non-finishing	Offset	Staple	Standard bin (Normal and offset stacking)	2-bin mailbox	Staple and hole punch
Plain Paper	✓	✓	✓	✓	✓	✓
Card Stock	✓	✓	X	✓	X	X
Transparency	✓	X	X	✓	X	X

Paper type	Staple finisher			Multiposition staple, hole punch finisher		
	Non-finishing	Offset	Staple	Standard bin (Normal and offset stacking)	2-bin mailbox	Staple and hole punch
Recycled	✓	✓	✓	✓	✓	✓
Glossy	✓	✓	✗	✓	✓	✗
Heavy Glossy	✓	✓	✗	✓	✓	✗
Labels	✓	✗	✗	✓	✗	✗
Vinyl Labels	✓	✗	✗	✓	✗	✗
Bond	✓	✓	✓	✓	✓	✓
Envelope	✓	✓	✗	✓	✗	✗
Rough Envelope	✓	✓	✗	✓	✗	✗
Letterhead	✓	✓	✓	✓	✓	✓
Preprinted	✓	✓	✓	✓	✓	✓
Colored Paper	✓	✓	✓	✓	✓	✓
Light Paper	✓	✓	✓	✓	✓	✓
Heavy Paper	✓	✓	✓	✓	✓	✓
Rough Cotton	✓	✓	✓	✓	✓	✓

Supported paper weights

Paper type	Standard 550-sheet tray	2200-sheet tray	Envelope tray	Multipurpose feeder
Plain Paper ^{1,2}	60–176 g/m ² (16–47 lb) ³	60–120 g/m ² (16–32 lb)	N/A	60–176 g/m ² (16–47 lb)
Banner Paper	N/A	N/A	N/A	90–105 g/m ² (24–28 lb)
Glossy	88–176 g/m ² (60–120 lb)	N/A	N/A	88–176 g/m ² (60–120 lb)

¹ Grain short paper that weighs at least 90 g/m² (24 lb) is supported in two-sided printing.

² Recycled paper that weighs 75–120 g/m² (20–32 lb) is supported in two-sided printing.

³ The paper weight is also supported in two-sided printing.

⁴ 100% cotton content maximum weight is 24 lb bond.

⁵ 28 lb-bond envelopes are limited to 25% cotton content.

Paper type	Standard 550-sheet tray	2200-sheet tray	Envelope tray	Multipurpose feeder
Card stock	88–300 g/m ² (60–192 lb)	N/A	N/A	163–176 g/m ² (90–120 lb)
Labels	88–300 g/m ² (60–192 lb)	N/A	N/A	199–220 g/m ² (53–59 lb)
Envelopes	N/A	N/A	60–105 g/m ² (16–28 lb) ^{4, 5}	60–105 g/m ² (16–28 lb)

¹ Grain short paper that weighs at least 90 g/m² (24 lb) is supported in two-sided printing.

² Recycled paper that weighs 75–120 g/m² (20–32 lb) is supported in two-sided printing.

³ The paper weight is also supported in two-sided printing.

⁴ 100% cotton content maximum weight is 24 lb bond.

⁵ 28 lb-bond envelopes are limited to 25% cotton content.

Printing

 **CAUTION—PINCH HAZARD:** To avoid the risk of a pinch injury, use caution in areas marked with this label. Pinch injuries may occur around moving parts, such as gears, doors, trays, and covers.

Printing from a computer

Note: For labels, card stock, and envelopes, set the paper size and type in the printer before printing the document.

- 1 From the document that you are trying to print, open the Print dialog.
- 2 If necessary, adjust the settings.
- 3 Print the document.

Printing forms

- 1 From the home screen, navigate to:
Forms and Favorites > select form > **Print**
- 2 If necessary, configure the print settings.
- 3 Send the print job.

Printing from a mobile device

Printing from a mobile device using Lexmark Mobile Print

Lexmark™ Mobile Print allows you to send documents and images directly to a supported Lexmark printer.



- 1 Open the document, and then send or share the document to Lexmark Mobile Print.
Note: Some third-party applications may not support the send or share feature. For more information, see the documentation that came with the application.
- 2 Select a printer.
- 3 Print the document.

Printing from a mobile device using Google Cloud Print

Google Cloud Print™ is a printing service that allows you to print to any Google Cloud Print-ready printer.

Before you begin, make sure that:



- The printer is registered to the Google Cloud Print server.
- The Cloud Print plugin is downloaded from the Google Play™ store and is enabled in the mobile device.

- 1 From your Android™ mobile device, open a document or select a document from your file manager.
- 2 Tap  > **Print**.
- 3 Select a printer, and then tap .

Printing from a mobile device using Mopria Print Service

Mopria® Print Service is a mobile printing solution for mobile devices running on Android version 5.0 or later. It allows you to print directly to any Mopria-certified printer.

Note: Make sure that you download the Mopria Print Service application from the Google Play store and enable it in the mobile device.

- 1 From your Android mobile device, launch a compatible application or select a document from your file manager.
- 2 Tap  > **Print**.
- 3 Select a printer, and then adjust the settings, if necessary.
- 4 Tap .

Printing from a mobile device using AirPrint

The AirPrint software feature is a mobile printing solution that allows you to print directly from Apple devices to an AirPrint-certified printer.



Notes:

- Make sure that the Apple device and the printer are connected to the same network. If the network has multiple wireless hubs, then make sure that both devices are connected to the same subnet.
 - This application is supported only in some Apple devices.
- 1 From your mobile device, select a document from your file manager or launch a compatible application.
 - 2 Tap  > **Print**.
 - 3 Select a printer, and then adjust the settings, if necessary.
 - 4 Print the document.

Printing from a mobile device using Wi-Fi Direct®

Wi-Fi Direct® is a printing service that lets you print to any Wi-Fi Direct-ready printer.

Note: Make sure that the mobile device is connected to the printer wireless network. For more information, see [“Connecting a mobile device to the printer” on page 157](#).

- 1 From your mobile device, launch a compatible application or select a document from your file manager.
- 2 Depending on your mobile device, do one of the following:
 - Tap  > **Print**.
 - Tap  > **Print**.
 - Tap  > **Print**.
- 3 Select a printer, and then adjust the settings, if necessary.
- 4 Print the document.

Printing from a flash drive

- 1 Insert the flash drive.

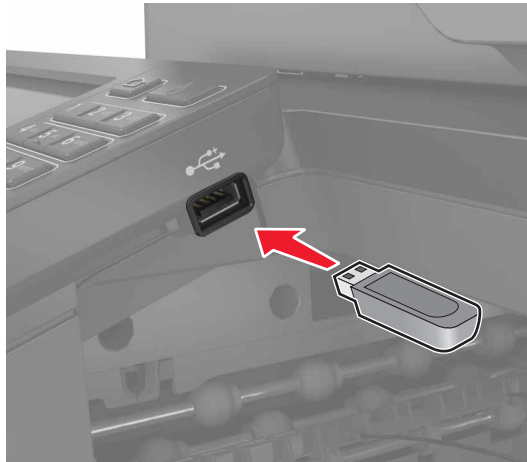

Notes:

- If you insert the flash drive when an error message appears, then the printer ignores the flash drive.
 - If you insert the flash drive while the printer is processing other print jobs, then **Busy** appears on the display.
- 2 From the display, touch the document that you want to print.
If necessary, configure other print settings.
 - 3 Send the print job.
To print another document, touch **USB Drive**.

Warning—Potential Damage: To avoid loss of data or printer malfunction, do not touch the flash drive or the printer in the area shown while actively printing, reading, or writing from the memory device.



Supported flash drives and file types

Flash drives

- Lexar JumpDrive S70 (16GB and 32GB)
- SanDisk Cruzer (16GB and 32GB)
- PNY Attache (16GB and 32GB)

Notes:

- The printer supports high-speed USB flash drives with full-speed standard.
- USB flash drives must support the File Allocation Table (FAT) system.

File types

Documents

- PDF (version 1.7 or earlier)
- HTML
- XPS
- Microsoft file formats (.doc, .docx, .xls, .xlsx, .ppt, .pptx)

Images

- .dcx
- .gif
- .JPEG or .jpg
- .bmp
- .pcx
- .TIFF or .tif
- .png

Configuring confidential jobs

- 1 From the control panel, navigate to:
Settings > Security > Confidential Print Setup
- 2 Configure the settings.

Use	To
Max Invalid PIN	Set the number of times an invalid PIN can be entered. Note: When the limit is reached, the print jobs for that user name are deleted.
Confidential Job Expiration	Set the expiration time for confidential print jobs. Note: Confidential held jobs are stored in the printer until they are released or deleted manually.
Repeat Job Expiration	Set the expiration time for a repeat print job. Note: Repeat held jobs are stored in the printer memory for reprinting.
Verify Job Expiration	Set the expiration time that the printer prints a copy before printing the remaining copies. Note: Verify jobs print one copy to check if it is satisfactory before printing the remaining copies.
Reserve Job Expiration	Set the expiration time that the printer stores print jobs. Note: Reserve held jobs are automatically deleted after printing.
Require All Jobs to be Held	Set the printer to hold all print jobs.
Keep duplicate documents	Set the printer to print all documents with the same file name.

Printing confidential and other held jobs

For Windows users

- 1 With a document open, click **File > Print**.
- 2 Click **Properties, Preferences, Options, or Setup**.
- 3 Click **Print and Hold**.
- 4 Select **Use Print and Hold**, and then assign a user name.
- 5 Select the print job type (Confidential, Repeat, Reserve, or Verify).
 If the print job is confidential, then enter a four-digit PIN.
- 6 Click **OK** or **Print**.

- 7 From the printer home screen, release the print job.
 - For confidential print jobs, navigate to:
Held jobs > select your user name > **Confidential** > enter the PIN > select the print job > configure the settings > **Print**
 - For other print jobs, navigate to:
Held jobs > select your user name > select the print job > configure the settings > **Print**

For Macintosh users

- 1 With a document open, choose **File** > **Print**.
If necessary, click the disclosure triangle to see more options.
- 2 From the print options or Copies & Pages menu, choose **Job Routing**.
- 3 Select the print job type (Confidential, Repeat, Reserve, or Verify).
If the print job is confidential, then assign a user name and a four-digit PIN.
- 4 Click **OK** or **Print**.
- 5 From the printer home screen, release the print job.
 - For confidential print jobs, navigate to:
Held jobs > select your user name > **Confidential** > enter the PIN > select the print job > configure the settings > **Print**
 - For other print jobs, navigate to:
Held jobs > select your user name > select the print job > configure the settings > **Print**

Printing from a Cloud Connector profile

Note: This application is available only in certain country or region. For more information, contact your Lexmark representative.

- 1 From the home screen, touch **Cloud Connector**.
- 2 Select a cloud service provider, and then select a profile.
Note: For more information on creating a Cloud Connector profile, see [“Creating a Cloud Connector profile” on page 21](#).
- 3 Touch **Print**, and then select a file.
If necessary, change the settings.
Note: Make sure to select a supported file.
- 4 Print the document.

Printing a font sample list

- 1 From the home screen, touch **Settings** > **Reports** > **Print** > **Print Fonts**.
- 2 Touch **PCL Fonts** or **PS Fonts**.

Printing a directory list

From the home screen, touch **Settings > Reports > Print > Print Directory**.

Canceling a print job

From the printer control panel

- 1 From the home screen, touch **Job Queue**.

Note: You can also access this setting by touching the top section of the home screen.

- 2 Select the job to cancel.

From the computer

- 1 Depending on the operating system, do either of the following:
 - Open the printers folder, and then select your printer.
 - From the System Preferences in the Apple menu, navigate to your printer.
- 2 Select the job to cancel.

Copying

Using the automatic document feeder and scanner glass

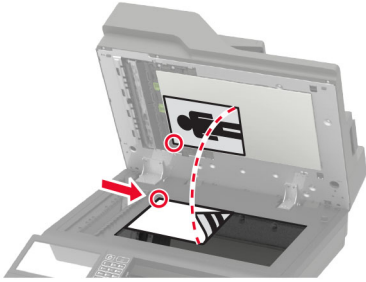
Automatic document feeder (ADF)	Scanner glass
 <ul style="list-style-type: none"> • Use the ADF for multiple-page or two-sided documents. • Load an original document faceup. For multiple-page documents, make sure to align the leading edge before loading. • Make sure to adjust the ADF guides to match the width of the paper that you are loading. 	 <ul style="list-style-type: none"> • Use the scanner glass for single-page documents, book pages, small items (such as postcards or photos), transparencies, photo paper, or thin media (such as magazine clippings). • Place the document facedown in the corner with the arrow.

Making copies

- 1 Load an original document into the ADF tray or on the scanner glass.

Note: To avoid a cropped image, make sure that the original document and output have the same paper size.

- 2 From the home screen, touch **Copy**, and then specify the number of copies.
If necessary, adjust the copy settings.
- 3 Copy the document.

Note: To make a quick copy, from the control panel, press .

Copying photos

- 1 Place a photo on the scanner glass.
- 2 From the home screen, touch **Copy** > **Content** > **Content Type** > **Photo**.
- 3 Touch **Content Source**, and then select the setting that best matches the original photo.
- 4 Copy the photo.

Copying on letterhead

- 1 Load an original document into the ADF tray or on the scanner glass.
- 2 From the home screen, touch **Copy** > **Copy From** > select the size of the original document.
- 3 Touch **Copy To**, and then select the paper source that contains the letterhead.
If you loaded the letterhead into the multipurpose feeder, then navigate to:
Copy To > **Multipurpose Feeder** > select a paper size > **Letterhead**
- 4 Copy the document.

Copying on both sides of the paper

- 1 Load an original document into the ADF tray or on the scanner glass.
- 2 From the home screen, touch **Copy** > **Paper Setup**.
- 3 Adjust the settings.
- 4 Copy the document.

Reducing or enlarging copies

- 1 Load an original document into the ADF tray or on the scanner glass.
- 2 From the home screen, navigate to:
Copy > **Scale** > specify a scale value
Note: Changing the size of the original document or output after setting Scale restores the scale value to Auto.
- 3 Copy the document.

Collating copies

- 1 Load an original document into the ADF tray or on the scanner glass.
- 2 From the home screen, touch **Copy** > **Collate** > **On** [1,2,1,2,1,2].
- 3 Copy the document.

Placing separator sheets between copies

- 1 Load an original document into the ADF tray or on the scanner glass.
- 2 From the home screen, touch **Copy** > **Separator Sheets**.
- 3 Adjust the settings.
- 4 Send the copy job.

Copying multiple pages onto a single sheet

- 1 Load an original document into the ADF tray or on the scanner glass.
- 2 From the home screen, touch **Copy** > **Pages per Side**.
- 3 Adjust the settings.
- 4 Copy the document.

Creating a copy shortcut

- 1 From the home screen, touch **Copy**.
- 2 Configure the settings, and then touch .
- 3 Create a shortcut.

E-mailing

Using the automatic document feeder and scanner glass

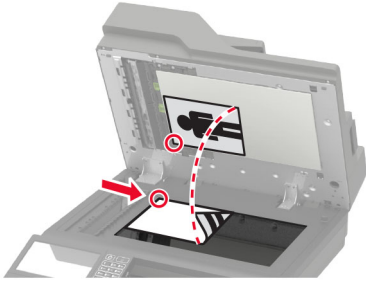
Automatic document feeder (ADF)	Scanner glass
 <ul style="list-style-type: none"> • Use the ADF for multiple-page or two-sided documents. • Load an original document faceup. For multiple-page documents, make sure to align the leading edge before loading. • Make sure to adjust the ADF guides to match the width of the paper that you are loading. 	 <ul style="list-style-type: none"> • Use the scanner glass for single-page documents, book pages, small items (such as postcards or photos), transparencies, photo paper, or thin media (such as magazine clippings). • Place the document facedown in the corner with the arrow.

Configuring the SMTP server for e-mail

From the control panel

- 1 From the control panel, touch **Settings** > **E-mail** > **E-mail Setup**.
- 2 Configure the settings.

From the Embedded Web Server

- 1 Open a web browser, and then type the printer IP address in the address field.

Notes:

- View the printer IP address on the printer home screen. The IP address appears as four sets of numbers separated by periods, such as 123.123.123.123.
- If you are using a proxy server, then temporarily disable it to load the web page correctly.

- 2 Click **Settings** > **E-mail**.
- 3 From the E-mail Setup section, configure the settings.
- 4 Click **Save**.

Sending an e-mail

Using the control panel

- 1 Load an original document into the ADF tray or on the scanner glass.
- 2 From the home screen, touch **E-mail**, and then enter the needed information.
Note: You can also enter the recipient using the address book or shortcut number.
- 3 If necessary, configure the output file type settings.
- 4 Send the e-mail.

Using the shortcut number

- 1 From the control panel, press #, and then enter the shortcut number using the keypad.
- 2 Send the e-mail.

Creating an e-mail shortcut

- 1 From the home screen, touch **E-mail**.
- 2 Configure the settings, and then touch .
- 3 Create a shortcut.

Faxing

Setting up the printer to fax

Notes:

- The following connection methods are applicable only in some countries or regions.
- During the initial printer setup, clear the fax function check box and any other function you plan to set up later, and then touch **Continue**.
- The indicator light may blink red if the fax function is enabled and not fully set up.

Warning—Potential Damage: Do not touch cables or the printer in the area shown while actively sending or receiving a fax.



Configuring the SMTP server for fax

From the control panel

- 1 From the control panel, touch **Settings > Fax > Fax Server Setup > Fax Server E-mail Settings**.
- 2 Configure the settings.

Note: To use the SMTP server setting for e-mail, enable **Use E-mail SMTP Server**.

From the Embedded Web Server

- 1 Open a web browser, and then type the printer IP address in the address field.

Notes:

- View the printer IP address on the printer home screen. The IP address appears as four sets of numbers separated by periods, such as 123.123.123.123.
- If you are using a proxy server, then temporarily disable it to load the web page correctly.

2 Click **Settings > Fax > Fax Server Setup**.

3 From the Fax Server E-mail Settings section, configure the settings.

Note: To use the SMTP server setting for e-mail, enable **Use E-mail SMTP Server**.

4 Click **Save**.

Choosing a fax connection

Setting up fax using a standard telephone line



CAUTION—SHOCK HAZARD: To avoid the risk of electrical shock, do not set up this product or make any electrical or cabling connections, such as the power cord, fax feature, or telephone, during a lightning storm.



CAUTION—SHOCK HAZARD: To avoid the risk of electrical shock, do not use the fax feature during a lightning storm.



CAUTION—POTENTIAL INJURY: To reduce the risk of fire, use only a 26 AWG or larger telecommunications (RJ-11) cord when connecting this product to the public switched telephone network. For users in Australia, the cord must be approved by the Australian Communications and Media Authority.

Setup 1: Printer is connected to a dedicated fax line

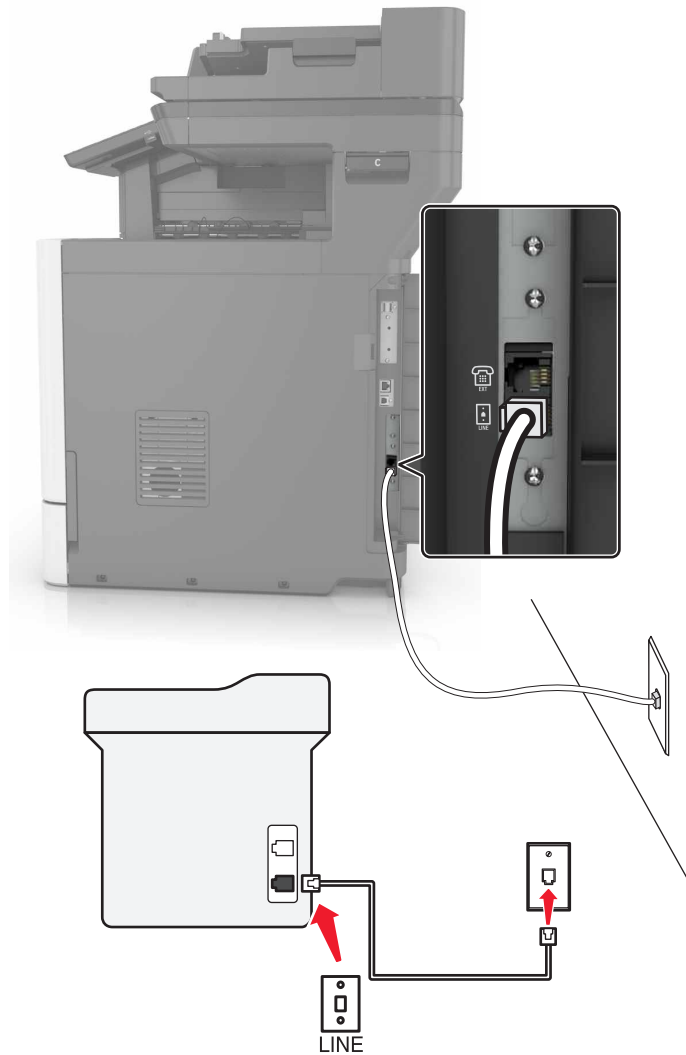

1 Connect one end of the telephone cable to the line port of the printer.

2 Connect the other end of the cable to an active analog wall jack.

Notes:

- You can set the printer to receive faxes automatically (Auto Answer On) or manually (Auto Answer Off).
- If you want to receive faxes automatically, then set the printer to pick up on a specified number of rings.

Setup 2: Printer is sharing the line with an answering machine

Note: If you subscribe to a distinctive ring service, then make sure that you set the correct ring pattern for the printer. Otherwise, the printer does not receive faxes even if you have set it to receive faxes automatically.

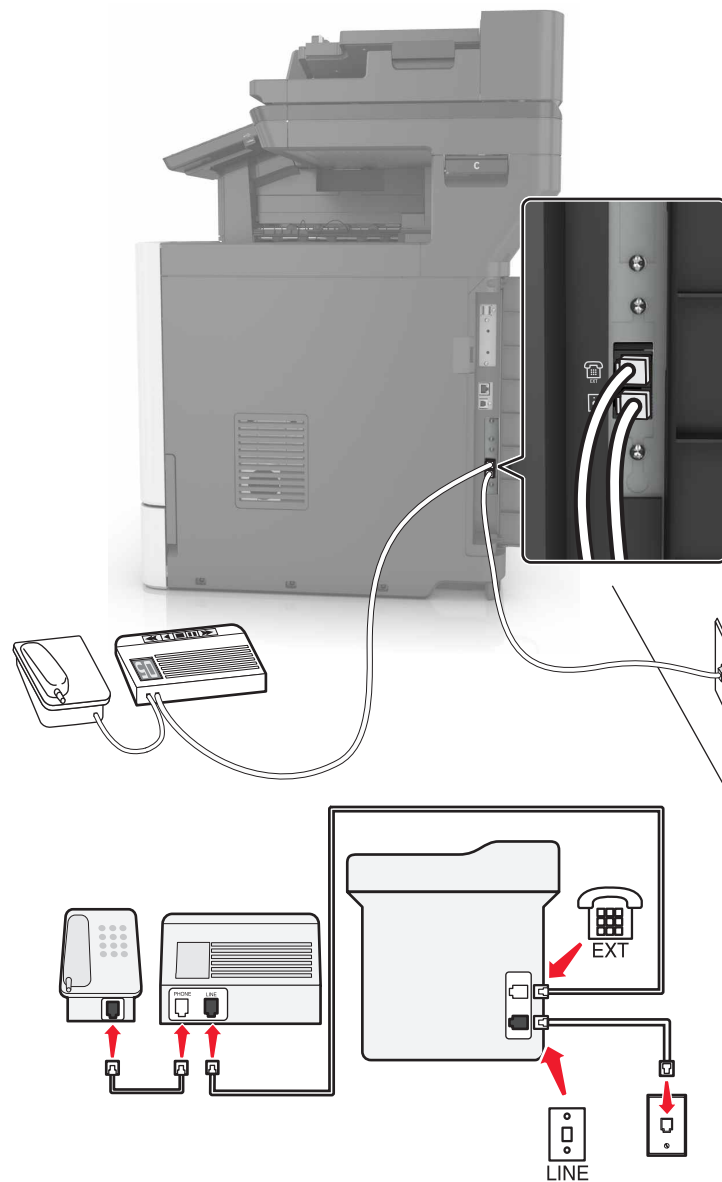
Connected to the same telephone wall jack

- 1** Connect one end of the telephone cable to the line port of the printer.
- 2** Connect the other end of the cable to an active analog wall jack.
- 3** Connect the answering machine to the telephone port of the printer.

Connected to different wall jacks

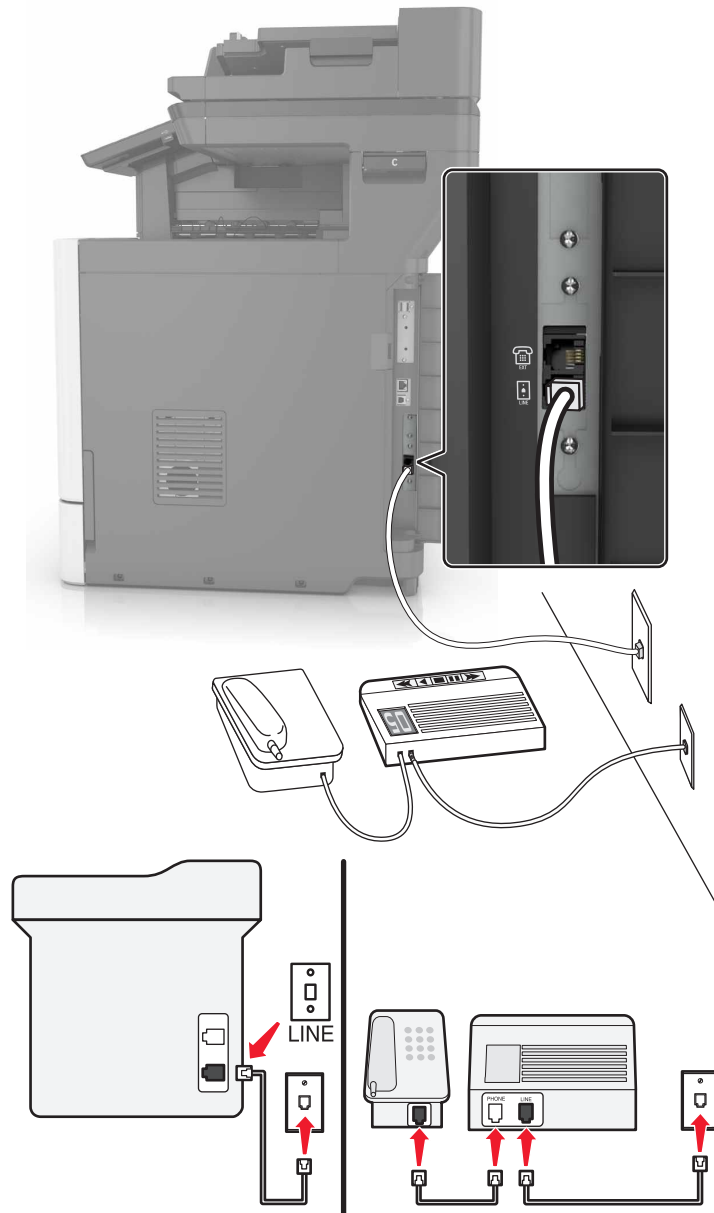

- 1 Connect one end of the telephone cable to the line port of the printer.
- 2 Connect the other end of the cable to an active analog wall jack.

Notes:

- If you have only one telephone number on your line, then set the printer to receive faxes automatically.
- Set the printer to pick up calls two rings after the answering machine. For example, if the answering machine picks up calls after four rings, then set the printer Rings to Answer setting to six.

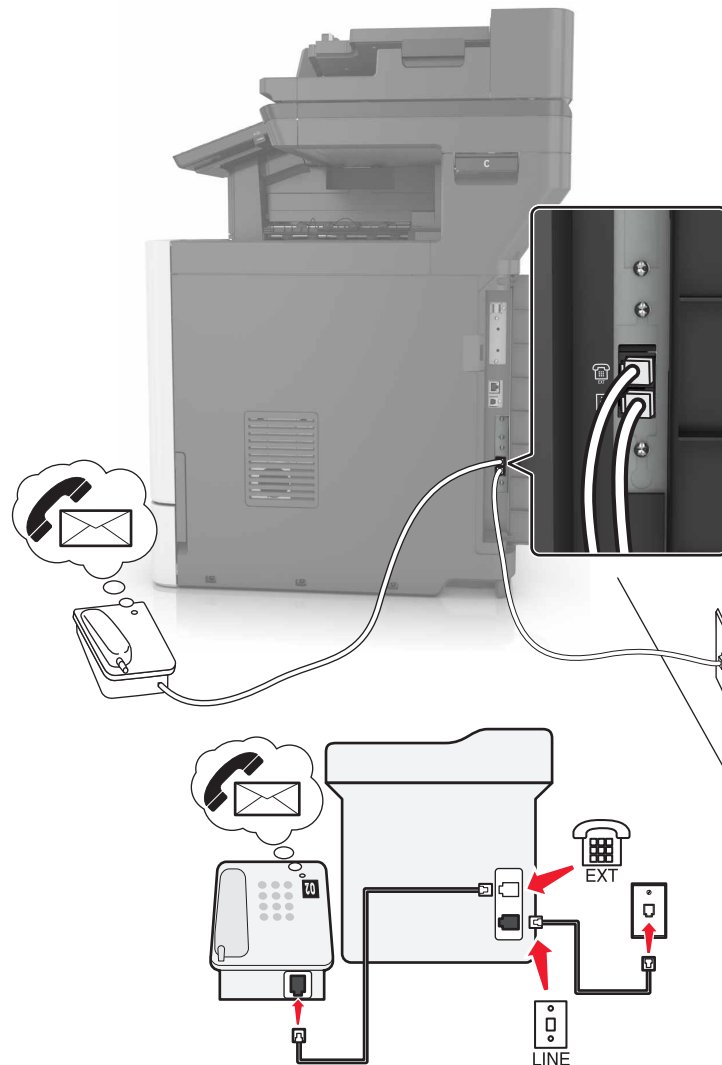
Setup 3: Printer is sharing the line with a telephone subscribed to voice mail service

- 1 Connect one end of the telephone cable to the line port of the printer.
- 2 Connect the other end of the cable to an active analog wall jack.
- 3 Connect the telephone to the telephone port of the printer.

Notes:

- This setup works best if you are using voice mail more often than fax, and if you subscribe to a distinctive ring service.
- When you answer the telephone and you hear fax tones, press ***9*** or the manual answer code on the telephone to receive the fax.
- You can also set the printer to receive faxes automatically, but turn off the voice mail service when you are expecting a fax.

Setting up fax in countries or regions with different telephone wall jacks and plugs

- ⚡ CAUTION—SHOCK HAZARD:** To avoid the risk of electrical shock, do not set up this product or make any electrical or cabling connections, such as the power cord, fax feature, or telephone, during a lightning storm.
- ⚡ CAUTION—SHOCK HAZARD:** To avoid the risk of electrical shock, do not use the fax feature during a lightning storm.
- ⚠ CAUTION—POTENTIAL INJURY:** To reduce the risk of fire, use only a 26 AWG or larger telecommunications (RJ-11) cord when connecting this product to the public switched telephone network. For users in Australia, the cord must be approved by the Australian Communications and Media Authority.

The standard wall jack adopted by most countries or regions is RJ11. If the wall jack or equipment in your facility is not compatible with this type of connection, then use a telephone adapter. An adapter for your country or region may not come with your printer, and you may need to purchase it separately.

There may be an adapter plug installed in the telephone port of the printer. Do not remove the adapter plug from the telephone port of the printer if you are connecting to a serial or cascaded telephone system.

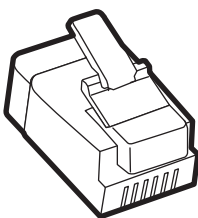

Part name	Part number
Lexmark adapter plug	40X8519

Connecting the printer to a non-RJ11 wall jack

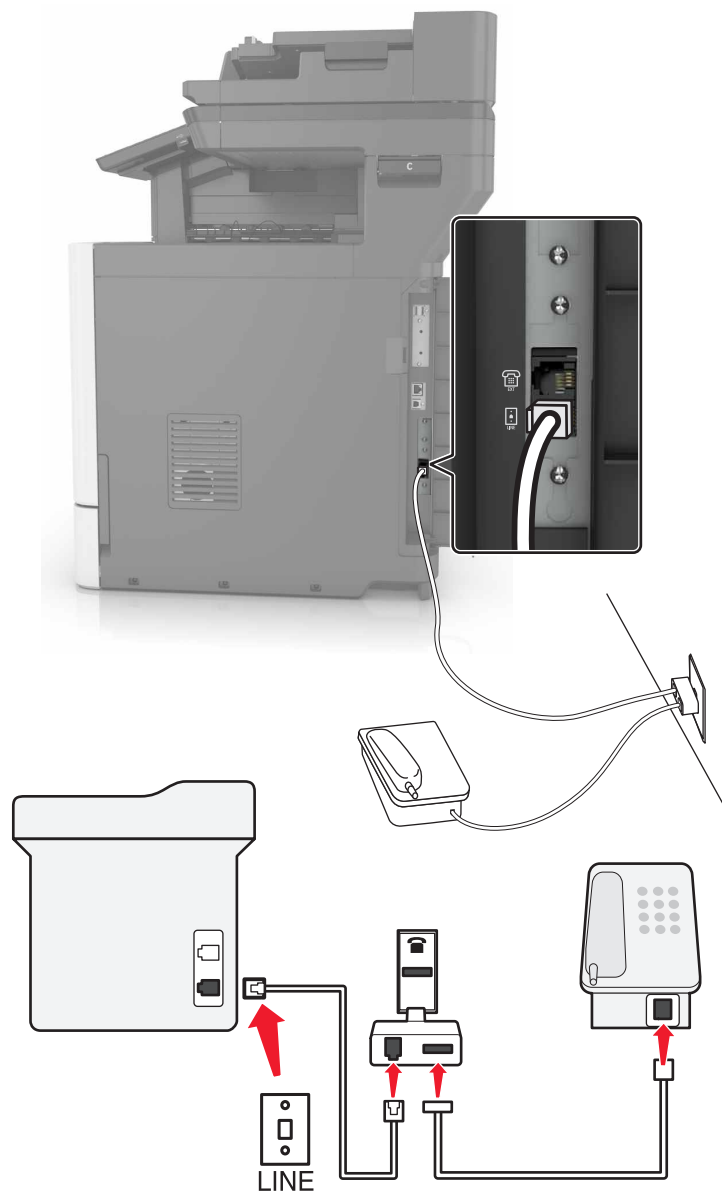

- 1** Connect one end of the telephone cable to the line port of the printer.
- 2** Connect the other end of the cable to the RJ11 adapter, and then connect the adapter to the wall jack.
- 3** If you want to connect another device with a non-RJ11 connector to the same wall jack, then connect it directly to the telephone adapter.

Connecting the printer to a wall jack in Germany

The German wall jack has two kinds of ports. The N ports are for fax machines, modems, and answering machines. The F port is for telephones. Connect the printer to any of the N ports.

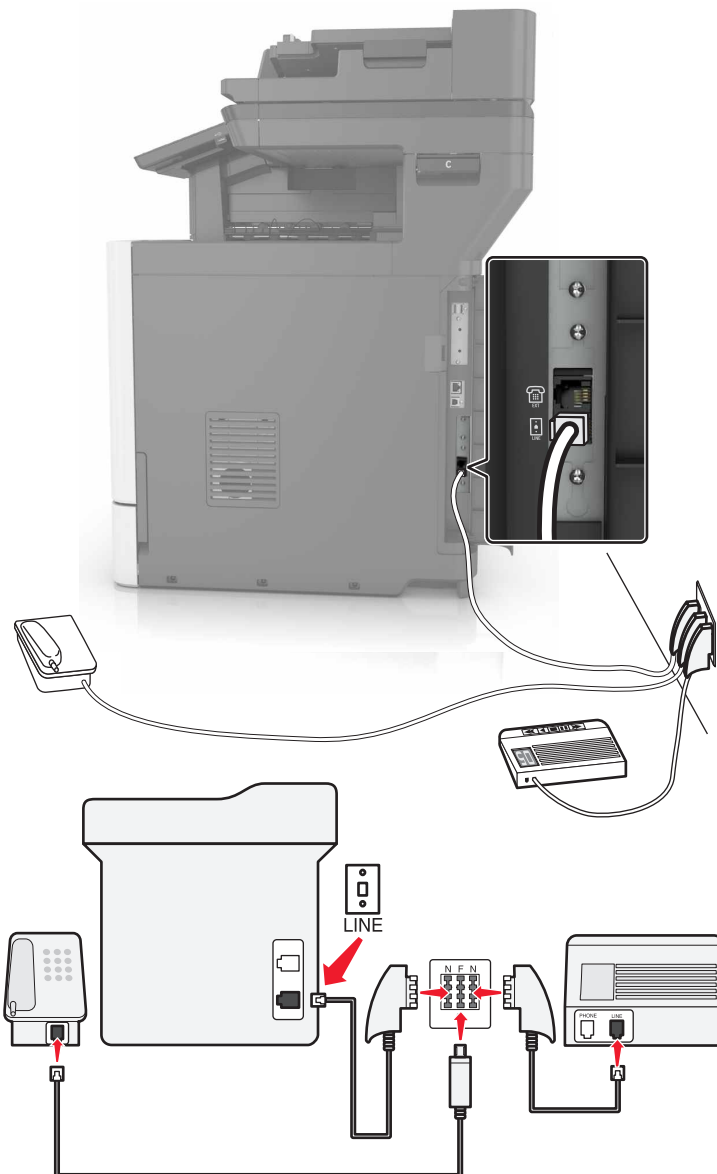

- 1 Connect one end of the telephone cable to the line port of the printer.
- 2 Connect the other end of the cable to the RJ11 adapter, and then connect the adapter to an N port.
- 3 If you want to connect a telephone and answering machine to the same wall jack, then connect the devices as shown.

Connecting to a distinctive ring service

A distinctive ring service lets you have multiple telephone numbers on one telephone line. Each telephone number is assigned a different ring pattern.

- 1 From the home screen, touch **Settings** > **Fax** > **Fax Setup** > **Fax Receive Settings** > **Admin Controls** > **Answer On**.
- 2 Select a ring pattern.

Setting the fax date and time

- 1 From the home screen, touch **Settings** > **Device** > **Preferences** > **Date and Time** > **Configure**.
- 2 Configure the settings.

Configuring daylight saving time

- 1 From the home screen, touch **Settings** > **Device** > **Preferences** > **Date and Time** > **Configure**.
- 2 In the Time Zone menu, select **(UTC+user) Custom**.
- 3 Configure the settings.

Using the automatic document feeder and scanner glass

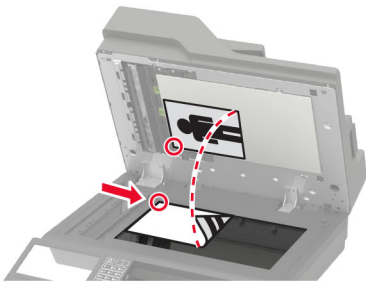
Automatic document feeder (ADF)	Scanner glass
 <ul style="list-style-type: none"> • Use the ADF for multiple-page or two-sided documents. • Load an original document faceup. For multiple-page documents, make sure to align the leading edge before loading. • Make sure to adjust the ADF guides to match the width of the paper that you are loading. 	 <ul style="list-style-type: none"> • Use the scanner glass for single-page documents, book pages, small items (such as postcards or photos), transparencies, photo paper, or thin media (such as magazine clippings). • Place the document facedown in the corner with the arrow.

Sending a fax

Using the control panel

- 1 Load the original document into the ADF tray or on the scanner glass.
- 2 From the home screen, touch **Fax**, and then enter the needed information.

- 3 If necessary, configure other fax settings.
- 4 Send the fax job.

Using the computer

Note: Make sure that the Universal Fax driver is installed.

For Windows users

- 1 With a document open, click **File > Print**.
- 2 Select the printer, and then click **Properties, Preferences, Options, or Setup**.
- 3 Click **Fax > Enable fax**, and then enter the recipient number.
- 4 If necessary, configure other fax settings.
- 5 Send the fax job.

For Macintosh users

- 1 With a document open, choose **File > Print**.
- 2 Select the printer and enter the recipient number.
- 3 If necessary, configure other fax settings.
- 4 Send the fax job.

Scheduling a fax

- 1 Load the original document into the ADF tray or on the scanner glass.
- 2 From the home screen, navigate to:
Fax > To > enter the fax number > Done
- 3 Touch **Send Time**, configure the settings, and then touch **Done**.
- 4 Send the fax.

Creating a fax destination shortcut

- 1 From the home screen, touch **Fax > To**.
- 2 Enter the recipient number, and then touch **Done**.
- 3 Touch .
- 4 Create a shortcut.

Changing the fax resolution

- 1 Load an original document into the ADF tray or on the scanner glass.
- 2 From the home screen, touch **Fax**, and then enter the needed information.
- 3 Touch **Resolution**, and then adjust the setting.
- 4 Send the fax.

Adjusting the fax darkness

- 1 Load an original document into the ADF tray or on the scanner glass.
- 2 From the home screen, touch **Fax**, and then enter the needed information.
- 3 Touch **Darkness**, and then adjust the setting.
- 4 Send the fax.

Printing a fax log

- 1 From the home screen, touch **Settings > Reports > Fax**.
- 2 Touch **Fax Job Log** or **Fax Call Log**.

Blocking junk faxes

- 1 From the home screen, touch **Settings > Fax > Fax Setup > Fax Receive Settings > Admin Controls**.
- 2 Set Block No Name Fax to **On**.

Holding faxes

- 1 From the home screen, touch **Settings > Fax > Fax Setup > Fax Receive Settings > Holding Faxes**.
- 2 Select a mode.

Forwarding a fax

- 1 From the home screen, touch **Settings > Fax > Fax Setup > Fax Receive Settings > Admin Controls**.
- 2 Touch **Fax Forwarding > Forward**.
- 3 Configure the Forward to and Confirmation E-mail settings.

Scanning

Using the automatic document feeder and scanner glass

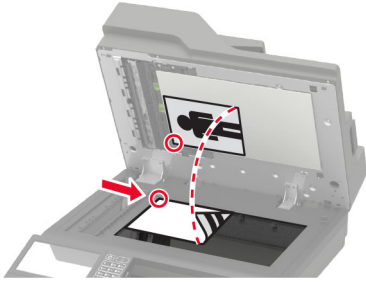
Automatic document feeder (ADF)	Scanner glass
 <ul style="list-style-type: none"> • Use the ADF for multiple-page or two-sided documents. • Load an original document faceup. For multiple-page documents, make sure to align the leading edge before loading. • Make sure to adjust the ADF guides to match the width of the paper that you are loading. 	 <ul style="list-style-type: none"> • Use the scanner glass for single-page documents, book pages, small items (such as postcards or photos), transparencies, photo paper, or thin media (such as magazine clippings). • Place the document facedown in the corner with the arrow.

Scanning to an FTP server

- 1 Load the original document into the ADF tray or on the scanner glass.
- 2 From the home screen, touch **FTP**, and then enter the needed information.
- 3 If necessary, configure other FTP settings.
- 4 Send the FTP job.

Creating an FTP shortcut

- 1 From the home screen, touch **FTP**.
- 2 Enter the FTP server address, and then touch .
- 3 Create a shortcut.

Creating a network folder shortcut

- 1 Open a web browser, and then type the printer IP address in the address field.

Notes:

- View the printer IP address on the printer home screen. The IP address appears as four sets of numbers separated by periods, such as 123.123.123.123.

- If you are using a proxy server, then temporarily disable it to load the web page correctly.

2 Click **Shortcuts > Add Shortcut**.

3 From the Shortcut Type menu, select **Network Folder**, and then configure the settings.

4 Apply the changes.

Scanning to a flash drive

1 Load an original document into the ADF tray or on the scanner glass.

2 Insert the flash drive.

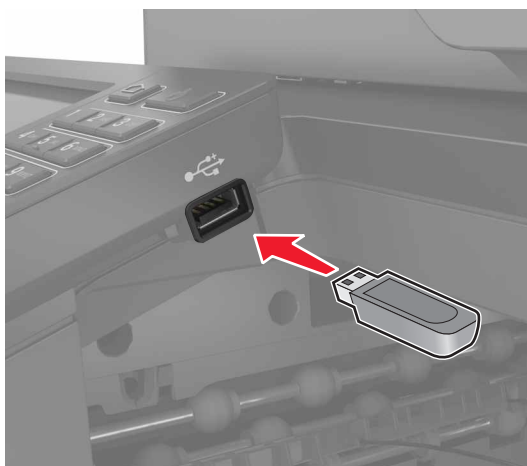

3 Touch **Scan to USB** and adjust the settings if necessary.

Note: If the USB Drive screen does not appear, then touch **USB Drive** on the home screen.

4 Scan the document.

Warning—Potential Damage: To avoid loss of data or printer malfunction, do not touch the flash drive or the printer in the area shown while actively printing, reading, or writing from the memory device.



Scanning to a fax server

- 1 Load an original document into the ADF tray or on the scanner glass.
- 2 From the home screen, touch **Scan Center**, and then from the list of destinations, select **Fax**.
- 3 Select a fax destination.
Note: To create a fax destination, touch **Create Fax**.
- 4 Scan the document.

Sending scanned documents to a computer

- 1 Load an original document into the ADF tray or on the scanner glass.
- 2 From the home screen, touch **Scan Profiles > Scan To Computer**.
- 3 Select the scan profile where you want to save the document.

Scanning to a Cloud Connector profile

Note: This application is available only in certain country or region. For more information, contact your Lexmark representative.

- 1 Load an original document into the ADF tray or on the scanner glass.
- 2 From the home screen, touch **Cloud Connector**.
- 3 Select a cloud service provider, and then select a profile.

Note: For more information on creating a Cloud Connector profile, see [“Creating a Cloud Connector profile” on page 21](#).

- 4 Touch **Scan**, and then assign a filename and destination folder.

5 Touch **Scan Here**.

If necessary, change the scan settings.

6 Scan the document.

Understanding the printer menus

Menu map

Device	<ul style="list-style-type: none"> • Preferences • Eco-Mode • Remote Operator Panel • Notifications • Power Management • Information Sent to Lexmark 	<ul style="list-style-type: none"> • Accessibility • Restore Factory Defaults • Maintenance • Visible Home Screen Icons • About this Printer
Print	<ul style="list-style-type: none"> • Layout • Finishing* • Setup • Quality • Job Accounting • XPS 	<ul style="list-style-type: none"> • PDF • PostScript • PCL • HTML • Image
Paper	<ul style="list-style-type: none"> • Tray Configuration • Media Configuration 	<ul style="list-style-type: none"> • Bin Configuration*
Copy	Copy Defaults	
Fax	Fax Defaults	
E-mail	<ul style="list-style-type: none"> • E-mail Setup • E-mail Defaults 	<ul style="list-style-type: none"> • Web Link Setup
FTP	FTP Defaults	
USB Drive	<ul style="list-style-type: none"> • Flash Drive Scan 	<ul style="list-style-type: none"> • Flash Drive Print
Network/Ports	<ul style="list-style-type: none"> • Network Overview • Wireless • Ethernet • TCP/IP • SNMP • IPSec • 802.1x 	<ul style="list-style-type: none"> • LPD Configuration • HTTP/FTP Settings • ThinPrint • USB • Restrict external network access • Google Cloud Print • Wi-Fi Direct
Security	<ul style="list-style-type: none"> • Login Methods • Schedule USB Devices • Security Audit Log • Login Restrictions • Confidential Print Setup 	<ul style="list-style-type: none"> • Disk Encryption • Erase Temporary Data Files • Solutions LDAP Settings • Miscellaneous

* This menu item appears only when a finisher is installed.

Reports	<ul style="list-style-type: none"> • Menu Settings Page • Device • Print 	<ul style="list-style-type: none"> • Shortcuts • Fax • Network
Help	<ul style="list-style-type: none"> • Print All Guides • Color Quality Guide • Connection Guide • Copy Guide • E-mail Guide • Fax Guide 	<ul style="list-style-type: none"> • Information Guide • Media Guide • Moving Guide • Print Quality Guide • Scan Guide • Supplies Guide
Troubleshooting	Print Quality Test Pages	Cleaning the Scanner
* This menu item appears only when a finisher is installed.		

Device

Preferences

Menu item	Description
Display Language	Set the language of the text that appears on the display.
Country/Region	Identify the country or region that the printer is configured to operate.
Run initial setup Off* On	Run the setup wizard.
Keyboard Keyboard Type	Select a language as a keyboard type. Note: All the Keyboard Type values may not appear or may require special hardware be installed to appear.
Displayed information Display Text 1 (IP Address*) Display Text 2 (Date/Time*) Custom Text 1 Custom Text 2	Specify the information to appear on the home screen.
Note: An asterisk (*) next to a value indicates the factory default setting.	

Menu item	Description
<p>Date and Time</p> <ul style="list-style-type: none"> Configure <ul style="list-style-type: none"> Current Date and Time Manually Set Date and Time Date Format (MM-DD-YYYY*) Time Format (24 hour clock*) Time Zone (UTC-5:00*) Network Time Protocol <ul style="list-style-type: none"> Enable NTP (On*) NTP Server Enable Authentication 	<p>Configure the printer date and time and network time protocol.</p>
<p>Paper Sizes</p> <ul style="list-style-type: none"> U.S.* Metric 	<p>Specify the unit of measurement for paper sizes.</p> <p>Note: The country or region selected in the initial setup wizard determines the initial paper size setting.</p>
<p>Screen Brightness</p> <p>20–100% (100*)</p>	<p>Adjust the brightness of the display.</p>
<p>Flash Drive Access</p> <ul style="list-style-type: none"> Enabled* Disabled 	<p>Enable access to the flash drive.</p>
<p>Allow Background Removal</p> <ul style="list-style-type: none"> Off On* 	<p>Specify whether background removal is allowed.</p>
<p>Allow Custom Job scans</p> <ul style="list-style-type: none"> Off On* 	<p>Specify whether the Custom Job Scanning setting appears for copy, scan, and fax.</p> <p>Note: This menu item appears only when a hard disk is installed.</p>
<p>One Page Flatbed Scanning</p> <ul style="list-style-type: none"> Off* On 	<p>Set the printer to scan any type of job involving the scanner glass as a single page.</p> <p>Note: The printer returns to the home screen after performing a single flatbed scan instead of displaying prompts.</p>
<p>Output Lighting</p> <ul style="list-style-type: none"> Off* On 	<p>Enable the integrated output light or indicator light of an optional output bin.</p>
<p>Audio Feedback</p> <ul style="list-style-type: none"> Button Feedback (On*) Volume (5*) 	<ul style="list-style-type: none"> • Enable audio feedback for button presses, panel interactions, paper loaded prompts, and error notifications. • Adjust the feedback volume.
<p>Screen Timeout</p> <p>5–300 seconds (60*)</p>	<p>Set the idle time before the display shows the home screen or before the printer logs out a user account automatically.</p>
<p>Note: An asterisk (*) next to a value indicates the factory default setting.</p>	

Eco-Mode

Menu item	Description
Print Sides 1-Sided* 2-Sided	Specify whether to print on one side or both sides of the paper.
Print Pages per Side Off* 2 pages per side 3 pages per side 4 pages per side 6 pages per side 9 pages per side 12 pages per side 16 pages per side	Print multiple page images on one side of a sheet of paper.
Print Toner Darkness 1–5 (4*)	Determine the lightness or darkness of text images.
Print Color Saver Off* On	Reduce the amount of toner used to print graphics and images.
Copy Sides 1 sided to 1 sided* 1 sided to 2 sided 2 sided to 1 sided 2 sided to 2 sided	Specify the scanning behavior based on the original document.
Copy Pages per Side Off* 2 Portrait pages 4 Portrait pages 2 Landscape pages 4 Landscape pages	Specify the scanning behavior based on the original document.
Copy Darkness 1–9 (5*)	Determine the darkness of the scanned text images.
Note: An asterisk (*) next to a value indicates the factory default setting.	

Remote Operator Panel

Menu item	Description
External VNC Connection Don't Allow* Allow	Connect an external Virtual Network Computing (VNC) client to the remote control panel.
Authentication Type None* Standard Authentication	Set the authentication type when accessing the VNC client server.
VNC Password	Specify the password to connect to the VNC client server. Note: This menu item appears only if Authentication Type is set to Standard Authentication.
Note: An asterisk (*) next to a value indicates the factory default setting.	

Notifications

	Menu item	Description
	Error Lighting Off On*	Set the indicator light to come on when a printer error occurs.
	ADF Loaded Beep Off On*	Enable a sound when loading paper into the ADF.
	Alarm Control Off Single* Continuous	Set the number of times that the alarm sounds when the printer requires user intervention.
	Supplies Show Supply Estimates Show estimates* Do not show estimates	Show the estimated status of the supplies.
	Supplies Display Estimates Pages* Percent	Determine the unit that the printer uses to estimate supply usage and trigger custom notifications when user intervention is required. Note: This menu item appears only in the Embedded Web Server.
	Supplies Cartridge Alarm Off Single* Continuous	Set the number of times that the alarm sounds when the cartridge is low.
Note: An asterisk (*) next to a value indicates the factory default setting.		

	Menu item	Description
	Supplies Custom Supply Estimates Show Estimates Do Not Show Estimates*	Configure notification settings when the printer requires user intervention. Note: This menu item appears only in the Embedded Web Server.
	E-mail Alerts Setup E-mail Setup Primary SMTP Gateway	Type the IP address or host name of the primary SMTP server for sending e-mail.
	E-mail Alerts Setup E-mail Setup Primary SMTP Gateway Port 1–65535 (25*)	Enter the port number of the primary SMTP server.
	E-mail Alerts Setup E-mail Setup Secondary SMTP Gateway	Type the server IP address or host name of your secondary or backup SMTP server.
	E-mail Alerts Setup E-mail Setup Secondary SMTP Gateway Port 1–65535 (25*)	Enter the server port number of your secondary or backup SMTP server.
	E-mail Alerts Setup E-mail Setup SMTP Timeout 5–30 seconds (30*)	Specify how long before the printer times out if the SMTP server does not respond.
	E-mail Alerts Setup E-mail Setup Reply Address	Specify a reply address in the e-mail.
	E-mail Alerts Setup E-mail Setup Always use SMTP default Reply Address Off* On	Use the SMTP default Reply Address.
	E-mail Alerts Setup E-mail Setup Use SSL/TLS Disabled* Negotiate Required	Send an e-mail using an encrypted link.
	Note: An asterisk (*) next to a value indicates the factory default setting.	

	Menu item	Description
	E-mail Alerts Setup E-mail Setup Require Trusted Certificate On* Off	Require a trusted certificate when accessing the SMTP server.
	E-mail Alerts Setup E-mail Setup SMTP Server Authentication No authentication required* Login / Plain NTLM CRAM-MD5 Digest-MD5 Kerberos 5	Set the authentication type for the SMTP server.
	E-mail Alerts Setup E-mail Setup Device-Initiated E-mail None* Use Device SMTP Credentials	Set whether credentials are required for device-initiated e-mails.
	E-mail Alerts Setup E-mail Setup User-Initiated E-mail None Use Device SMTP Credentials Use Session User ID and Password Use Session E-mail address and Password* Prompt user	Set whether credentials are required for user-initiated e-mails.
	E-mail Alerts Setup E-mail Setup Use Active Directory Device Credentials Off On*	Enable user credentials and group designations to connect to the SMTP server.
	E-mail Alerts Setup E-mail Setup Device Userid	Specify the user ID to connect to the SMTP server.
Note: An asterisk (*) next to a value indicates the factory default setting.		

	Menu item	Description
	E-mail Alerts Setup E-mail Setup Device Password	Specify the password to connect to the SMTP server.
	E-mail Alerts Setup E-mail Setup Kerberos 5 REALM	Specify the realm for the Kerberos 5 authentication protocol.
	E-mail Alerts Setup E-mail Setup NTLM Domain	Specify the domain name for the NTLM security protocol.
	Error Prevention ADF Multifeed Sensor Off On*	Detect when the ADF picks more than one sheet of media at once.
	Error Prevention Jam Assist Off On*	Set the printer to check for jammed paper automatically.
	Error Prevention Auto Continue Off On* (5 seconds)	Let the printer continue processing or printing a job automatically after clearing certain attendance conditions.
	Error Prevention Auto Reboot Auto Reboot Reboot when idle Reboot always* Reboot never	Set the printer to restart when an error occurs.
	Error Prevention Auto Reboot Max Auto Reboots 1–20 (2*)	Set the number of automatic reboots that the printer can perform.
	Error Prevention Auto Reboot Auto Reboot Window 1–525600 seconds (720*)	Set the number of seconds before the printer performs an automatic reboot.
	Error Prevention Auto Reboot Auto Reboot Counter	Show a read-only information of the reboot counter.
Note: An asterisk (*) next to a value indicates the factory default setting.		

	Menu item	Description
	Error Prevention Auto Reboot Reset Auto Reboot Counter Cancel Continue	Reset the Auto Reboot Counter.
	Error Prevention Display Short Paper Error On Auto-clear*	Set the printer to show a message when a short paper error occurs. Note: Short paper refers to the size of the paper loaded.
	Error Prevention Page Protect Off* On	Set the printer to process the entire page into the memory before printing it.
	Jam Content Recovery Jam Recovery Off On Auto*	Set the printer to reprint jammed pages.
	Jam Content Recovery Scanner Jam Recovery Job level Page level*	Specify how to restart a scan job after resolving a paper jam.
Note: An asterisk (*) next to a value indicates the factory default setting.		

Power Management

Menu item	Description
Sleep Mode Profile Print from Sleep Mode Stay awake after printing Enter Sleep Mode after printing*	Set the printer to stay in Ready mode or return to Sleep mode after printing.
Timeouts Sleep Mode 1–120 minutes (15*)	Set the idle time before the printer begins operating in Sleep mode.
Note: An asterisk (*) next to a value indicates the factory default setting.	

Menu item	Description
Timeouts Hibernate Timeout Disabled 1 hour 2 hours 3 hours 6 hours 1 day 2 days 3 days* 1 week 2 weeks 1 month	Set the time before the printer turns off.
Timeouts Hibernate Timeout on Connection Hibernate Do Not Hibernate*	Set Hibernate Timeout to turn off the printer while an active Ethernet connection exists.
Note: An asterisk (*) next to a value indicates the factory default setting.	

Information Sent to Lexmark

Menu item	Description
Information Sent to Lexmark Supplies and Page Usage Device Performance None of the Above*	Send printer usage and performance information to Lexmark. Note: Information Send Time appears only when you select any of the settings in Information Sent to Lexmark, except None.
Information Send Time Start Time Stop Time	
Note: An asterisk (*) next to a value indicates the factory default setting.	

Accessibility

Menu item	Description
Duplicate Key Strike Interval 0–5 (0*)	Set the interval in seconds during which the printer ignores duplicate key presses on an attached keyboard.
Key Repeat Initial Delay 0.25–5 (1*)	Set the initial length of delay in seconds before a repeating key starts repeating.
Key Repeat Rate 0.5–30 (30*)	Set the number of presses per second for a repeating key.
Note: An asterisk (*) next to a value indicates the factory default setting.	

Menu item	Description
Prolong Screen Timeout Off* On	Let the user remain in the same location and reset the Screen Timeout timer when it expires instead of returning to the home screen.
Headphone Volume 1–10 (5*)	Adjust the headphone volume.
Enable Voice Guidance When Headphone Is Attached Off* On	Enable Voice Guidance when a headphone is attached to the printer.
Speak Passwords/PINs Off* On	Set the printer to read out loud passwords or personal identification numbers.
Speech Rate Very Slow Slow Normal* Fast Faster Very Fast Rapid Very Rapid Fastest	Set the Voice Guidance speech rate.
Note: An asterisk (*) next to a value indicates the factory default setting.	

Restore Factory Defaults

Menu item	Description
Restore Settings Restore all settings Restore printer settings Restore network settings Restore fax settings Restore app settings	Restore the printer factory default settings.

Maintenance

Configuration Menu

Menu item	Description
USB Configuration USB PnP 1* 2	Change the USB driver mode of the printer to improve its compatibility with a personal computer.
USB Configuration USB Scan to Local On* Off	Set whether the USB device driver enumerates as a USB Simple device (single interface) or as a USB Composite device (multiple interfaces).
USB Configuration USB Speed Full Auto*	Set the USB port to run at full speed and disable its high-speed capabilities.
Tray Configuration Size Sensing Tray [x] Sensing Off On*	Set the tray to sense automatically the paper size loaded into it.
Tray Configuration Tray Linking Automatic* Off	Set the printer to link the trays that have the same paper type and paper size settings.
Tray Configuration Show Tray Insert Message Off Only for unknown sizes* Always	Display a message that lets the user change the paper size and paper type settings after inserting the tray.
Tray Configuration A5 Loading Short Edge Long Edge*	Determine the default loading orientation for the A5 size paper in all paper sources.
Tray Configuration Paper Prompts Auto* Multipurpose Feeder Manual Paper	Set the paper source that the user fills when a prompt to load paper appears. Note: For Multipurpose Feeder to appear, in the Paper menu, set Configure MP to Cassette.
Note: An asterisk (*) next to a value indicates the factory default setting.	

Menu item	Description
Tray Configuration Envelope Prompts Auto* Multipurpose Feeder Manual Envelope	Set the paper source that the user fills when a prompt to load envelope appears. Note: For Multipurpose Feeder to appear, in the Paper menu, set Configure MP to Cassette.
Tray Configuration Action for Prompts Prompt user* Continue Use current	Set the printer to resolve paper- or envelope-related change prompts.
Reports Menu Settings Page Event Log Event Log Summary HealthCheck Statistics	Print reports about printer menu settings, status, and event logs.
Supply Usage And Counters Clear Supply Usage History	Reset the supply usage history, such as number of pages and days remaining, to the factory shipped level.
Supply Usage And Counters Fuser Reset Reset Black Dev Unit Counter	Reset the counter after installing a new part or supply.
Tiered Coverage Ranges Tiered Coverage Metrics Show* Hide Tiered Coverage Ranges Highlight Range Business Range Graphics Range	Adjust the amount of color coverage for each printing range.
Printer Emulations PPDS Emulation Off* On	Set the printer to recognize and use the PPDS data stream.
Printer Emulations PS Emulation Off On*	Set the printer to recognize and use the PS data stream.
Printer Emulations Emulator Security Page Timeout 0–60 (60*)	Set the page timeout during emulation.
Note: An asterisk (*) next to a value indicates the factory default setting.	

Menu item	Description
<p>Printer Emulations Emulator Security Reset Emulator After Job Off* On</p>	<p>Reset the emulator after a print job.</p>
<p>Printer Emulations Emulator Security Disable Printer Message Access Off On*</p>	<p>Disable access to printer message during emulation.</p>
<p>Fax Configuration Fax Low Power Support Disable Sleep Permit Sleep Auto*</p>	<p>Set fax to enter Sleep mode whenever the printer determines that it should.</p>
<p>Fax Configuration Fax Storage Location NAND Disk*</p>	<p>Set the storage location for all faxes. Note: This menu item appears only when a hard disk is installed.</p>
<p>Print Configuration Black Only Mode Off* On</p>	<p>Print non-copy jobs in grayscale.</p>
<p>Print Configuration Color Trapping Off 1 2* 3 4 5</p>	<p>Enhance the printed output to compensate for misregistration in the printer.</p>
<p>Print Configuration Font Sharpening 0–150 (24*)</p>	<p>Set a text point-size value below which the high-frequency screens are used when printing font data. For example, if the value is 24, then all fonts sized 24 points or less use the high-frequency screens.</p>
<p>Device Operations Quiet Mode Off* On</p>	<p>Set the printer to operate in Quiet Mode. Note: Enabling this setting slows down the overall performance of the printer.</p>
<p>Note: An asterisk (*) next to a value indicates the factory default setting.</p>	

Menu item	Description
Device Operations Panel Menus Enable* Disable	Enable access to the control panel menus.
Device Operations Safe Mode Off* On	Set the printer to operate in a special mode, in which it attempts to continue offering as much functionality as possible, despite known issues. For example, when set to On, and the duplex motor is nonfunctional, the printer performs one-sided printing of the documents even if the job is two-sided printing.
Device Operations Minimum Copy Memory 80 MB* 100 MB	Set the minimum memory allocation for storing copy jobs.
Device Operations Clear Custom Status	Erase user-defined strings for the Default or Alternate custom messages.
Device Operations Clear all remotely-installed messages	Erase messages that were remotely installed.
Device Operations Automatically Display Error Screens Off On*	Show existing error messages on the display after the printer remains inactive on the home screen for a length of time equal to the Screen Timeout setting.
Device Operations Honor orientation on fast path copy Off* On	Enable the printer to use the orientation setting under the Copy menu when sending quick copy jobs.
Device Operations Clean sensing and laser optics	Set the printer to run its wipers and clean the sensing and laser optics.
Toner patch sensor setup Calibration frequency preference Disabled Fewest color adjustments Fewer color adjustments Normal* Better color accuracy Best color accuracy	Set the printer to put down the correct amount of toner to maintain color consistency.
Toner patch sensor setup Full calibration	Run the full color calibration.
Toner patch sensor setup Print TPS information page	Print a diagnostic page that contains information on toner patch sensor calibration.
Note: An asterisk (*) next to a value indicates the factory default setting.	

Menu item	Description
App Configuration LES Applications Off On*	Enable the Lexmark Embedded Solutions (LES) applications.
Scanner Configuration Scanner Manual Registration Print Quick Test	Print a Quick Test target page. Note: Make sure that the margin spacing on the target page is uniform all the way around the target. If it is not, then the printer margins must be reset.
Scanner Configuration Scanner Manual Registration Front ADF Registration Rear ADF Registration Flatbed Registration	Manually register the flatbed and ADF after replacing the ADF, scanner glass, or controller board.
Scanner Configuration Reset Maintenance Counter	Reset the counter after replacing the ADF maintenance kit.
Scanner Configuration Edge Erase Flatbed Edge Erase (3*) ADF Edge Erase (3*)	Set the size, in millimeters, of the no-print area around an ADF or flatbed scan job.
Scanner Configuration ADF Deskew ADF Electronic Deskew (On*)	Reduce skewing of documents that are scanned from the ADF.
Scanner Configuration Disable Scanner Enabled* Disabled ADF Disabled	Disable the scanner when it is not working properly.
Scanner Configuration Tiff Byte Order CPU Endianness* Little Endian Big Endian	Set the byte order of a TIFF-formatted scan output.
Scanner Configuration Exact Tiff Rows Per Strip On* Off	Set the RowsPerStrip tag value of a TIFF-formatted scan output.
Note: An asterisk (*) next to a value indicates the factory default setting.	

Out of Service Erase

Menu item	Description
Memory Last Sanitized Hard Disk Last Sanitized	Show information on when the printer memory or hard disk was last sanitized. Note: Hard Disk Last Sanitized appears only when a hard disk is installed.
Sanitize all information on nonvolatile memory Erase all printer and network settings Erase all apps and app settings Erase all shortcuts and shortcut settings Sanitize all information on hard disk Erase downloads (Erase all macros, fonts, PFOs, etc.) Erase buffered jobs Erase Held jobs	Clear all information on nonvolatile memory and information on the hard disk. Note: Sanitize all information on hard disk appears only when a hard disk is installed.

Visible Home Screen Icons

Menu	Description
Copy E-mail Fax Status/Supplies Job Queue Change Language Shortcut Center Address Book Bookmarks Held Jobs USB FTP Scan Profiles App Profiles Display Customization Forms and Favorites Scan Center Card Copy	Specify which icons to show on the home screen.

About this Printer

Menu item	Description
Asset Tag	Describe the printer. The maximum length is 32 characters.
Printer's Location	Identify the printer location. The maximum length is 63 characters.
* This menu item appears only in some printer models.	

Menu item	Description
Contact	Personalize the printer name. The maximum length is 63 characters.
Export Configuration File to USB*	Export configuration files to a flash drive.
Export Compressed Logs to USB*	Export compressed log files to a flash drive.
Send Logs Cancel Send	Send diagnostic information to Lexmark.
* This menu item appears only in some printer models.	

Print

Layout

Menu item	Description
Sides 1-Sided* 2-Sided	Specify whether to print on one side or both sides of the paper.
Flip Style Long Edge* Short Edge	Determine which side of the paper is bound when performing two-sided printing.
Blank Pages Print Do Not Print*	Print blank pages that are included in a print job.
Collate Off (1,1,2,2,2) On (1,2,1,2,1,2)*	Keep the pages of a print job stacked in sequence, particularly when printing multiple copies of the job.
Separator Sheets None* Between Copies Between Jobs Between Pages	Insert blank separator sheets when printing.
Separator Sheet Source Tray [x] (1*) Multipurpose Feeder	Specify the paper source for the separator sheet.
Note: An asterisk (*) next to a value indicates the factory default setting.	

Menu item	Description
Pages per Side Off* 2 pages per side 3 pages per side 4 pages per side 6 pages per side 9 pages per side 12 pages per side 16 pages per side	Print multiple page images on one side of a sheet of paper.
Pages per Side Ordering Horizontal* Reverse Horizontal Vertical Reverse Vertical	Specify the positioning of multiple page images when using the Pages per Side menu.
Pages per Side Orientation Auto* Landscape Portrait	Specify the orientation of multiple page images when using the Pages per Side menu.
Pages per Side Border None* Solid	Print a border around each page image when using the Pages per Side menu.
Copies 1–9999 (1*)	Specify the number of copies for each print job.
Print Area Normal* Fit to page Whole Page	Set the printable area on a sheet of paper.
Note: An asterisk (*) next to a value indicates the factory default setting.	

Finishing

Menu item	Description
Staple Job Off* 1 staple, top left corner 2 staples, left 1 staple, top right corner 2 staples, top 1 staple, bottom left corner 2 staples, bottom 1 staple, bottom right corner 2 staples, right	Specify the staple position for all print jobs. Note: This menu item appears only when a finisher is installed.
Staple Test Start	Determine whether the staple finisher is functioning properly. Note: This menu item appears only when a finisher is installed.
Hole Punch Off* On	Punch holes along the edge of the printed output. Note: This menu item appears only when a multiposition staple, hole punch finisher is installed.
Hole Punch Mode 2 holes 3 holes 4 holes	Set the hole punch mode for the printed output. Notes: <ul style="list-style-type: none"> • 3 holes is the U.S. factory default setting. 4 holes is the international factory default setting. • This menu item appears only when a multiposition staple, hole punch finisher is installed.
Offset Pages None* Between Copies Between Jobs	Offset the output of each print job or each copy of a print job. Notes: <ul style="list-style-type: none"> • Between Copies offsets each copy of a print job if Collate is set to On [1,2,1,2,1,2]. If Collate is set to Off [1,1,2,2,2], then each set of printed pages is offset, such as all page 1s and all page 2s. • Between Jobs sets the same offset position for the entire print job regardless of the number of copies printed. • This menu item appears only when a multiposition staple, hole punch finisher is installed.
Note: An asterisk (*) next to a value indicates the factory default setting.	

Setup

Menu item	Description
Printer Language PCL Emulation PS Emulation*	Set the printer language. Note: Setting a printer language default does not prevent a software program from sending print jobs that use another printer language.
Note: An asterisk (*) next to a value indicates the factory default setting.	

Menu item	Description
Job Waiting Off* On	Preserve print jobs requiring supplies so that jobs not requiring the missing supplies can print. Note: This menu item appears only when a printer hard disk is installed.
Job Hold Timeout 0–255 (30*)	Set the time in seconds that the printer waits for user intervention before it holds jobs that require unavailable resources and continues to print other jobs in the print queue. Note: This menu item appears only when a printer hard disk is installed.
Printer Usage Max Speed Max Yield*	Determine how the color imaging kit operates during printing. Notes: <ul style="list-style-type: none"> • When set to Max Yield, the color imaging kit slows or stops while printing groups of black-only pages. • When set to Max Speed, the color imaging kit always runs while printing, whether color or black pages are being printed.
Download Target RAM* Disk	Specify where to save all permanent resources, such as fonts and macros, that have been downloaded to the printer. Note: This menu item appears only when a printer hard disk is installed.
Resource Save Off* On	Determine what the printer does with downloaded resources, such as fonts and macros, when it receives a job that requires more than the available memory. Notes: <ul style="list-style-type: none"> • When set to Off, the printer retains downloaded resources only until memory is needed. Resources associated with the inactive printer language are deleted. • When set to On, the printer preserves all the permanent downloaded resources across all language switches. When necessary, the printer shows memory full messages instead of deleting permanent resources.
Print All Order Alphabetical* Newest First Oldest First	Specify the order when you choose to print all held and confidential jobs. Note: This menu item appears only when a printer hard disk is installed.
Note: An asterisk (*) next to a value indicates the factory default setting.	

Quality

Menu item	Description
Print Mode Black and White Color*	Set how the printer generates color content.
Note: An asterisk (*) next to a value indicates the factory default setting.	

Menu item	Description
Print Resolution 4800 CQ* 1200 dpi	Set the resolution for the printed output. Note: 4800 CQ provides high-quality output at maximum speed.
Toner Darkness 1 to 5 (4*)	Determine the lightness or darkness of text images.
Halftone Normal* Detail	Enhance the printed output to have smoother lines with sharper edges.
Color Saver Off* On	Reduce the amount of toner used to print graphics and images. Note: When set to On, this setting overrides the value of the Toner Darkness setting.
RGB Brightness -6 to 6 (0*)	Adjust the brightness, contrast, and saturation for color output. Note: This setting does not affect files where CMYK color specifications are used.
RGB Contrast 0 to 5 (0*)	
RGB Saturation 0 to 5 (0*)	
Note: An asterisk (*) next to a value indicates the factory default setting.	

Advanced Imaging

Menu item	Description
Color Balance Cyan -5 to 5 (0*) Magenta -5 to 5 (0*) Yellow -5 to 5 (0*) Black -5 to 5 (0*) Reset Defaults	Adjust the amount of toner that is used for each color.
Color Correction Off Auto* Manual	Modify the color settings used to print documents. Notes: <ul style="list-style-type: none"> • Off sets the printer to receive the color correction from the software. • Auto sets the printer to apply different color profiles to each object on the printed page. • Manual allows the customization of the RGB or CMYK color conversions applied to each object on the printed page.
Note: An asterisk (*) next to a value indicates the factory default setting.	

Menu item	Description
Color Samples Print Color Samples	Print sample pages for each of the RGB and CMYK color conversion tables used in the printer.
Color Adjust	Calibrate the printer to adjust color variations in the printed output.
Spot Color Replacement Set Custom CMYK	Assign specific CMYK values to twenty named spot colors.
Note: An asterisk (*) next to a value indicates the factory default setting.	

Job Accounting

Menu item	Description
Job Accounting Off* On	Set the printer to create a log of the print jobs that it receives. Note: This menu item appears only when a flash memory or hard disk is installed.
Accounting Log Frequency Daily Weekly Monthly*	Specify how often the printer creates a log file.
Log Action at End of Frequency None* E-mail Current Log E-mail & Delete Current Log Post Current Log Post & Delete Current Log	Specify how the printer responds when the frequency threshold expires. Note: The value defined in Accounting Log Frequency determines when this action is triggered.
Log Near Full Level Off On (5)*	Specify the maximum size of the log file before the printer executes the Log Action at Near Full.
Log Action at Near Full None* E-mail Current Log E-mail & Delete Current Log E-mail & Delete Oldest Log Post Current Log Post & Delete Current Log Post & Delete Oldest Log Delete Current Log Delete Oldest Log Delete All But Current Delete All Logs	Specify how the printer responds when the hard disk is nearly full. Note: The value defined in Log Near Full Level determines when this action is triggered.
Note: An asterisk (*) next to a value indicates the factory default setting.	

Menu item	Description
Log Action at Full None* E-mail & Delete Current Log E-mail & Delete Oldest Log Post & Delete Current Log Post & Delete Oldest Log Delete Current Log Delete Oldest Log Delete All But Current Delete All Logs	Specify how the printer responds when hard disk usage reaches the maximum limit (100MB).
URL to Post Log	Specify where the printer posts job accounting logs.
E-mail Address to Send Logs	Specify the e-mail address to which the printer sends job accounting logs.
Log File Prefix	Specify the prefix for the log files. Note: The current host name defined in the TCP/IP menu is used as the default log file prefix.
Note: An asterisk (*) next to a value indicates the factory default setting.	

XPS

Menu item	Description
Print Error Pages Off* On	Print the error pages that the printer encountered while processing an XPS file.
Minimum Line Width 1–30 (2*)	Set the minimum stroke width. Notes: <ul style="list-style-type: none"> Jobs printed in 1200 dpi use the value directly. Jobs printed in 4800 CQ use half the value.
Note: An asterisk (*) next to a value indicates the factory default setting.	

PDF

Menu item	Description
Scale To Fit Off* On	Scale the page content to fit the selected paper size.
Annotations Print Do Not Print*	Specify whether to print annotations in the PDF.
Note: An asterisk (*) next to a value indicates the factory default setting.	

Menu item	Description
Print PDF Error Off On*	Enable the printing of PDF error.
Note: An asterisk (*) next to a value indicates the factory default setting.	

PostScript

Menu item	Description
Print PS Error Off* On	Print a page that describes the PostScript® error. Note: When an error occurs, processing of the job stops, the printer prints an error message, and the rest of the print job is flushed.
Minimum Line Width 1–30 (2*)	Set the minimum stroke width. Notes: <ul style="list-style-type: none"> Jobs printed in 1200 dpi use the value directly. Jobs printed in 4800 CQ use half the value.
Lock PS Startup Mode Off On*	Disable the SysStart file.
Image Smoothing Off* On	Enhance the contrast and sharpness of low-resolution images. Note: This setting has no effect on images with a resolution of 300 dpi or higher.
Font Priority Resident* Flash/Disk	Establish the font search order. Notes: <ul style="list-style-type: none"> Resident sets the printer to search its memory for the requested font before searching the flash memory or printer hard disk. Flash/Disk sets the printer to search the flash memory or printer hard disk for the requested font before searching the printer memory. This menu item appears only when a flash memory or hard disk is installed.
Wait Timeout Off On* (40 seconds)	Enable the printer to wait for more data before canceling a print job.
Note: An asterisk (*) next to a value indicates the factory default setting.	

PCL

Menu item	Description
Font Source Resident* Disk Flash All	Choose the source which contains the default font selection. Notes: <ul style="list-style-type: none"> Flash and Disk appear only when a flash memory or hard disk is installed. For Flash and Disk to appear, make sure that they are not read- or write-protected.
Font Name Courier*	Select a font from the specified font source.
Symbol Set 12U PC-850*	Specify the symbol set for each font name. Note: A symbol set is a set of alphabetic and numeric characters, punctuation, and special symbols. Symbol sets support the different languages or specific programs such as math symbols for scientific text.
Pitch 0.08–100 (10*)	Specify the pitch for fixed or monospaced fonts. Note: Pitch refers to the number of fixed-space characters in a horizontal inch of type.
Orientation Portrait* Landscape	Specify the orientation of text and graphics on the page.
Lines per Page 1–255	Specify the number of lines of text for each page printed through the PCL® data stream. Notes: <ul style="list-style-type: none"> This menu item activates vertical escapement that causes the selected number of requested lines to print between the default margins of the page. 60 is the U.S. factory default setting. 64 is the international factory default setting.
PCL5 Minimum Line Width 1–30 (2*)	Set the initial minimum stroke width. Notes:
PCLXL Minimum Line Width 1–30 (2*)	<ul style="list-style-type: none"> Jobs printed in 1200 dpi use the value directly. Jobs printed in 4800 CQ use half the value.
A4 Width 198 mm* 203 mm	Set the width of the logical page on A4-size paper. Note: Logical page is the space on the physical page where data is printed.
Auto CR after LF Off* On	Set the printer to perform a carriage return after a line feed control command. Note: Carriage return is a mechanism that commands the printer to move the position of the cursor to the first position on the same line.
Note: An asterisk (*) next to a value indicates the factory default setting.	

Menu item	Description
Auto LF after CR Off* On	Set the printer to perform a line feed after a carriage return control command.
Tray Renumber Assign MP Feeder Assign Tray [x] Assign Manual Paper Assign Manual Envelope	Configure the printer to work with a different print driver or custom application that uses a different set of source assignments to request a given paper source. Choose from the following options: Off*—The printer uses the factory default paper source assignments. None—The paper source ignores the Select Paper Feed command. 0–199—Select a numeric value to assign a custom value to a paper source.
Tray Renumber View Factory Defaults	Show the factory default value assigned for each paper source.
Tray Renumber Restore Defaults	Restore the tray renumber values to their factory defaults.
Print Timeout Off On* (90 seconds)	Set the printer to end a print job after it has been idle for the specified amount of time.
Note: An asterisk (*) next to a value indicates the factory default setting.	

HTML

Menu item	Description
Font Name Times*	Set the font to use when printing HTML documents.
Font Size 1–255 (12*)	Set the font size to use when printing HTML documents.
Scale 1–400% (100*)	Scale HTML documents for printing.
Orientation Portrait* Landscape	Set the page orientation for HTML documents.
Margin Size 8–255 mm (19*)	Set the page margin for HTML documents.
Backgrounds Do Not Print Print*	Print background information or graphics in HTML documents.
Note: An asterisk (*) next to a value indicates the factory default setting.	

Image

Menu item	Description
Auto Fit On Off*	Select the best available paper size and orientation setting for an image. Note: When set to On, this menu item overrides the scaling and orientation settings for the image.
Invert Off* On	Invert bitonal monochrome images. Note: This menu item does not apply to GIF or JPEG image formats.
Scaling Anchor Top Left Best Fit* Anchor Center Fit Height/Width Fit Height Fit Width	Adjust the image to fit the printable area. Note: When Auto Fit is set to On, Scaling is automatically set to Best Fit.
Orientation Portrait* Landscape Reverse Portrait Reverse Landscape	Specify the orientation of text and graphics on the page.
Note: An asterisk (*) next to a value indicates the factory default setting.	

Paper

Tray Configuration

Menu item	Description
Default Source Tray [x] (1*) Multipurpose Feeder Manual Paper Manual Envelope	Set the paper source for all print jobs.
Paper Size/Type Tray [x] Multipurpose Feeder Manual Paper Manual Envelope	Specify the paper size or paper type loaded in each paper source.
Note: An asterisk (*) next to a value indicates the factory default setting.	

Menu item	Description
Substitute Size Off Letter/A4 All Listed*	Set the printer to substitute a specified paper size if the requested size is not loaded in any paper source. Notes: <ul style="list-style-type: none"> • Off prompts the user to load the required paper size. • All Listed allows all available substitutions.
Configure MP Cassette* Manual First	Determine the behavior of the multipurpose feeder. Notes: <ul style="list-style-type: none"> • Cassette configures the multipurpose feeder as the automatic paper source. • Manual sets the multipurpose feeder only for manual-feed print jobs. • First configures the multipurpose feeder as the primary paper source.
Note: An asterisk (*) next to a value indicates the factory default setting.	

Media Configuration

Universal Setup

Menu item	Description
Units of Measure Inches Millimeters	Specify the unit of measurement for the universal paper. Note: Inches is the U.S. factory default setting. Millimeters is the international factory default setting.
Portrait Width 3–52 inches (8.5*) 76–1321 mm (216*)	Set the portrait width of the universal paper.
Portrait Height 3–52 inches (14*) 76.2–1321 mm (356*)	Set the portrait height of the universal paper.
Feed Direction Short Edge* Long Edge	Set the printer to pick paper from the short edge or long edge direction. Note: Long Edge appears only when the longest edge is shorter than the maximum width supported.
Note: An asterisk (*) next to a value indicates the factory default setting.	

Custom Scan Sizes

Menu item	Description
Custom Scan Size [x] Scan Size Name Width 1–8.5 inches (8.5*) 25.4–215.9 mm (215.9*) Height 1–25 inches (14*) 25.4–635 mm (355.6*) Orientation Portrait* Landscape 2 scans per side Off* On	Assign a scan size name and configure the scan settings.

Media Types

Menu item	Description
Plain Card Stock Recycled Transparency Glossy Heavy Glossy Labels Vinyl Labels Bond Envelope Rough Envelope Letterhead Preprinted Colored Paper Light Heavy Rough/Cotton Custom Type [X]	Specify the texture, weight, and orientation of the paper.

Bin Configuration

Menu item	Description
Output Bin Standard Bin* Bin [x]	Specify the output bin.
Configure Bins Mailbox* Link Link Optional Type Assignment	Configure the mode of operation for the output bins. Notes: <ul style="list-style-type: none"> • Mailbox allows the standard bin and any optional bin to be selected individually. • Link allows all output bins to be linked together as though they were one large bin. • Link Optional treats all optional bins as one large output bin. • Type Assignment assigns each paper type a bin or a linked bin set.
Custom Bin Names Standard Bin Bin [x]	Assign a name for the bin.
Note: An asterisk (*) next to a value indicates the factory default setting.	

Copy

Copy Defaults

Menu item	Description
Content Type Text Text/Photo* Photo Graphics	Improve the output result based on the content of the original document.
Content Source Black and White Laser Color Laser* Inkjet Photo/Film Magazine Newspaper Press Other	Improve the output result based on the source of the original document.
Note: An asterisk (*) next to a value indicates the factory default setting.	

Menu item	Description
Sides 1 sided to 1 sided* 1 sided to 2 sided 2 sided to 1 sided 2 sided to 2 sided	Specify the scanning behavior based on the original document.
Separator Sheets None* Between Copies Between Jobs Between Pages	Specify whether to insert blank separator sheets when printing.
Separator Sheet Source Tray [x] (1*) Multipurpose Feeder	Specify the paper source for the separator sheet.
Color Off On* Auto	Set the printer to generate color output from a scan job.
Pages per Side Off* 2 Portrait pages 4 Portrait pages 2 Landscape pages 4 Landscape pages	Specify the number of page images to print on one side of a sheet of paper.
Print Page Borders Off* On	Place a border around each image when printing multiple pages on a single page.
Collate Off [1,1,1,2,2,2] On [1,2,1,2,1,2]*	Print multiple copies in sequence.
Offset Pages None* Between Copies Between Jobs	Offset the output of each print job or each copy of a print job. Notes: <ul style="list-style-type: none"> • Between Copies offsets each copy of a print job if Collate is set to On [1,2,1,2,1,2]. If Collate is set to Off [1,1,1,2,2,2], then each set of printed pages is offset, such as all page 1s and all page 2s. • Between Jobs sets the same offset position for the entire print job regardless of the number of copies printed. • This menu item appears only when a multiposition staple, hole punch finisher is installed.
Note: An asterisk (*) next to a value indicates the factory default setting.	

Menu item	Description
Staple Off* 1 staple, top left corner 2 staples, left 1 staple, top right corner 2 staples, top 1 staple, bottom left corner 2 staples, bottom 1 staple, bottom right corner 2 staples, right	Specify the staple position for all print jobs. Note: This menu item appears only when a finisher is installed.
Punch Off* 2 holes 3 holes 4 holes	Punch holes on the printed output. Note: This menu item appears only when a multiposition staple, hole punch finisher is installed.
“Copy from” Size [List of paper sizes]	Set the paper size of the original document. Note: Letter is the U.S. factory default setting. A4 is the international factory default setting.
“Copy to” Source Tray [x] (1*) Multipurpose Feeder Auto Size Match	Specify the paper source for the copy job.
Temperature -4 to 4 (0*)	Specify whether to generate a cooler or warmer output.
Darkness 1 to 9 (5*)	Adjust the darkness of the scanned image.
Number of Copies 1–9999 (1*)	Specify the number of copies.
Header/Footer Left Header Middle Header Right Header Left Footer Middle Footer Right Footer	Specify the header or footer information on the scanned image.
Note: An asterisk (*) next to a value indicates the factory default setting.	

Menu item	Description
Overlay Confidential Copy Draft Urgent Custom Off*	Specify the overlay text to print on each copy.
Custom overlay	Type the text for the Custom choice in Overlay menu.
Note: An asterisk (*) next to a value indicates the factory default setting.	

Advanced Imaging

Menu item	Description
Color Balance Cyan to Red -4 to 4 (0*) Magenta to Green -4 to 4 (0*) Yellow to Blue -4 to 4 (0*)	Adjust the color intensity for cyan, magenta, and yellow.
Color Dropout Color Dropout (None*) Default Red Threshold (128*) Default Green Threshold (128*) Default Blue Threshold (128*)	Specify which color to drop during scanning, and adjust the dropout setting for that color.
Auto Color Detect Color Sensitivity 1–9 (5*) Area Sensitivity 1–9 (5*)	Configure the auto color detection setting.
Contrast Best for content* 0–5	Specify the contrast for the scanned image.
Background Removal Background Detection Content-based* Fixed Level -4 to 4 (0*)	Remove the background color or image noise from the original document. Notes: <ul style="list-style-type: none"> • Content-based removes the background color from the original document . • Fixed removes image noise from a photo.
Auto Center Off* On	Align the content at the center of the page.
Note: An asterisk (*) next to a value indicates the factory default setting.	

Menu item	Description
Mirror Image Off* On	Create a mirror image of the original document.
Negative Image Off* On	Create a negative image of the original document.
Shadow Detail -4 to 4 (0*)	Adjust the shadow detail in the original document.
Scan Edge to Edge Off* On	Scan the original document from edge to edge.
Sharpness 1–5 (3*)	Adjust the sharpness of the scanned image.
Note: An asterisk (*) next to a value indicates the factory default setting.	

Admin Controls

Menu item	Description
Allow Color Copies Off On*	Print copies in color.
Transparency Separators Off On*	Insert a blank sheet between transparencies.
Output Bin Standard Bin* Bin [x]	Specify the output bin.
Allow Priority Copies Off On*	Interrupt a print job to make copies.
Custom Job Scanning Off* On	Set the printer to scan the first set of original documents using the specified settings, and then scan the next set with the same or different settings. Note: This menu item appears only when a hard disk is installed.
Allow Save as Shortcut Off On*	Save copy settings as a shortcut.
Adjust ADF Skew Off* On	Set the printer to adjust the skewed images from documents that are scanned from the ADF.
Note: An asterisk (*) next to a value indicates the factory default setting.	

Menu item	Description
Sample Copy Off* On	Print a sample copy to check the quality before printing the remaining copies. Note: This menu item appears only when a hard disk is installed.
Note: An asterisk (*) next to a value indicates the factory default setting.	

Fax

Fax Defaults

Fax Mode

Menu item	Description
Fax Mode Fax* Fax Server Disabled	Select a fax mode.
Note: An asterisk (*) next to a value indicates the factory default setting.	

Fax Setup

General Fax settings

Menu item	Description
Fax Name	Identify your fax machine.
Fax Number	Identify your fax number.
Fax ID Fax Name Fax Number*	Notify fax recipients of your fax name or fax number.
Enable Manual Fax Off* On	Set the printer to fax manually. Notes: <ul style="list-style-type: none"> • This menu item requires a line splitter and a telephone handset. • Use a regular telephone line to answer an incoming fax job and to dial a fax number. • To go directly to the manual fax function, touch # and 0 on the keypad.
Note: An asterisk (*) next to a value indicates the factory default setting.	

Menu item	Description
Memory Use All receive Mostly receive Equal* Mostly send All send	Set the amount of internal printer memory allocated for faxing. Note: This menu item prevents memory buffer conditions and failed faxes.
Cancel Faxes Allow* Don't Allow	Cancel outgoing faxes before they are transmitted, or cancel incoming faxes before they finish printing.
Fax Number Masking Off* From Left From Right	Specify the format for masking an outgoing fax number.
Digits to Mask 0–58 (0*)	Specify the number of digits to mask in an outgoing fax number.
Enable Line Connected Detection Off On*	Determine whether a telephone line is connected to the printer. Note: Detection takes place when turning on the printer and before each call.
Enable Line In Wrong Jack Detection Off On*	Determine whether a telephone line is connected to the correct port on the printer. Note: Detection takes place when turning on the printer and before each call.
Enable Extension in Use Support Off On*	Determine whether a telephone line is used by another device, such as another phone on the same line. Note: Detection takes place when turning on the printer and before each call.
Optimize Fax Compatibility	Configure the printer fax functionality for optimal compatibility with other fax machines.
Fax Transport Analog* etherFAX None	Set the fax transport method.
Note: An asterisk (*) next to a value indicates the factory default setting.	

Fax Send Settings

Menu item	Description
Resolution Standard* Fine Super Fine Ultra Fine	Set the resolution of the scanned image. Note: A higher resolution increases fax transmission time and requires higher memory.
Original Size [List of paper sizes]	Specify the size of the original document. Note: Letter is the U.S. factory default setting. A4 is the international factory default setting.
Orientation Portrait* Landscape	Specify the orientation of the original document. Note: This menu item appears only in some printer models.
Sides Off* Short Edge Long Edge	Specify the orientation of the original document when scanning on both sides of the document. Note: This menu item appears only in some printer models.
Content Type Text* Text/Photo Photo Graphics	Improve the output result based on the content of the original document.
Content Source Black and White Laser Color Laser* Inkjet Photo/Film Magazine Newspaper Press Other	Improve the output result based on the source of the original document.
Darkness 1–9 (5*)	Adjust the darkness of the scanned image.
Behind a PABX On Off*	Set the printer to dial a fax number without waiting to recognize the dial tone. Note: Private Automated Branch Exchange (PABX) is a telephone network that allows a single access number to offer multiple lines to outside callers.
Dial Mode Tone* Pulse	Specify the dial mode for incoming or outgoing faxes.
Note: An asterisk (*) next to a value indicates the factory default setting.	

Advanced Imaging

Menu item	Description
Color Balance Cyan - Red -4 to 4 (0*) Magenta - Green -4 to 4 (0*) Yellow - Blue -4 to 4 (0*)	Adjust the color intensity during scanning.
Color Dropout Color Dropout (None*) Default Red Threshold (128*) Default Green Threshold (128*) Default Blue Threshold (128*)	Specify which color to drop during scanning, and adjust the dropout setting for that color.
Contrast Best for Content* 0 1 2 3 4 5	Set the contrast of the output.
Background Removal Background Detection Content-based* Fixed Level -4 to 4 (0*)	Adjust the amount of background visible on a scanned image. Note: If you want to remove the background color from the original document, then set Background Detection to Content-based. If you want to remove image noise from a photo, then set Background Detection to Fixed.
Mirror Image Off* On	Create a mirror image of the original document.
Negative Image Off* On	Create a negative image of the original document.
Shadow Detail -4 to 4 (0*)	Adjust the amount of shadow detail visible on a scanned image.
Scan Edge to Edge On Off*	Allow edge-to-edge scanning of the original document.
Sharpness 1–5 (3*)	Adjust the sharpness of the scanned image.
Note: An asterisk (*) next to a value indicates the factory default setting.	

Menu item	Description
Temperature -4 to 4 (0*)	Specify whether to generate a cooler or warmer output.
Note: An asterisk (*) next to a value indicates the factory default setting.	

Admin Controls

Menu item	Description
Automatic Redial 0–9 (5*)	Adjust the number of redial attempts based on the activity levels of recipient fax machines.
Redial Frequency 1–200 minutes (3*)	Increase the time between redial attempts to increase the chance of sending fax successfully.
Enable ECM On* Off	Activate Error Correction Mode (ECM) for fax jobs. Note: ECM detects and corrects errors in the fax transmission process caused by telephone line noise and poor signal strength.
Enable Fax Scans On* Off	Fax documents that are scanned at the printer.
Driver to Fax On* Off	Allow the print driver to send fax.
Allow Save as Shortcut On* Off	Save fax numbers as shortcuts on the printer.
Max Speed 33600* 14400 9600 4800 2400	Set the maximum speed for sending fax.
Custom Job Scanning Off* On	Turn on scanning of custom jobs by default. Note: This menu item appears only when a hard disk is installed.
Scan Preview Off* On	Show a preview of the scan on the display. Note: This menu item appears only when a hard disk is installed.
Adjust ADF Skew Off* On	Correct slight skew in the scanned image.
Note: An asterisk (*) next to a value indicates the factory default setting.	

Menu item	Description
Enable Color Fax Scans Off by Default* On by Default Never Use Always Use	Enable color scans for fax.
Auto Convert Color Faxes to Mono Faxes On* Off	Convert all outgoing color faxes to black and white.
Confirm Fax Number Off* On	Ask the user to confirm the fax number.
Dial Prefix	Set a dialing prefix.
Dialing Prefix Rules	Establish a dialing prefix rule.
Note: An asterisk (*) next to a value indicates the factory default setting.	

Fax Receive Settings

Menu item	Description
Fax Job Waiting None* Toner Toner and Supplies	Remove fax jobs that request specific unavailable resources from the print queue.
Rings to Answer 1–25 (3*)	Set the number of rings for incoming fax.
Auto Reduction On* Off	Scale incoming fax to fit on the page.
Paper Source Tray [X] Auto*	Set the paper source for printing incoming fax.
Sides On Off*	Print on both sides of the paper.
Separator Sheets None* Before Job After Job	Specify whether to insert blank separator sheets when printing.
Separator Sheet Source Tray [X] (1*)	Specify the paper source for the separator sheet.
Note: An asterisk (*) next to a value indicates the factory default setting.	

Menu item	Description
Output Bin Standard Bin	Specify the output bin for received faxes.
Fax Footer On Off*	Print the transmission information at the bottom of each page from a received fax.
Fax Footer Time Stamp Receive* Print	Print the time stamp at the bottom of each page from a received fax.
Punch Off* 2 holes 3 holes 4 holes	Punch holes along the edge of the printed fax document. Note: This menu item appears only when a multiposition staple, hole punch finisher is installed.
Staple Off* 1 staple 2 staples	Staple the printed fax document. Note: This menu item appears only when a finisher is installed.
Holding Faxes Held Fax Mode Off* Always On Manual Scheduled	Hold received faxes from printing until they are released.
Note: An asterisk (*) next to a value indicates the factory default setting.	

Admin Controls

Menu item	Description
Enable Fax Receive On* Off	Set the printer to receive fax.
Enable Color Fax Receive On* Off	Set the printer to receive fax in color.
Enable Caller ID On* Off	Show the number that is sending the incoming fax.
Block No Name Fax On Off*	Block incoming faxes sent from devices with no station ID or fax ID specified.
Note: An asterisk (*) next to a value indicates the factory default setting.	

Menu item	Description
Banned Fax List Add Banned Fax	Specify the phone numbers that you want to block.
Answer On All Rings* Single Ring Only Double Ring Only Triple Ring Only Single or Double Rings Only Single or Triple Rings Only Double or Triple Rings Only	Set a distinctive ring pattern for incoming fax.
Auto Answer On* Off	Set the printer to receive fax automatically.
Fax Forwarding Print* Print and Forward Forward	Specify whether to forward received fax.
Forward To Destination 1 Destination 2	Specify where to forward received fax. Note: This menu item appears only when Fax Forwarding is set to Print and Forward or Forward.
Confirmation E-mail	Send a confirmation e-mail when fax forwarding is successful. Note: The e-mail is sent only when forwarding to FTP or Network Share destinations.
Max Speed 33600* 14400 9600 4800 2400	Set the maximum speed for transmitting fax.
Note: An asterisk (*) next to a value indicates the factory default setting.	

Fax Cover Page

Menu item	Description
Fax Cover Page Off by Default* On by Default Never Use Always Use	Configure the settings for the fax cover page.
Include To field Off* On	
Include From field Off* On	
From	
Include Message Field Off* On	
Message:	
Include Logo Off* On	
Include Footer [x] Off* On	
Footer [x]	
Note: An asterisk (*) next to a value indicates the factory default setting.	

Fax Log settings

Menu item	Description
Transmission Log Frequency Always* Never Only for Error	Specify how often the printer creates a transmission log.
Transmission Log Action Print Off On* E-mail Off* On	
Note: An asterisk (*) next to a value indicates the factory default setting.	

Menu item	Description
Receive Error Log Print Never* Print on Error	Print a log for fax-receive failures.
Auto Print Logs On* Off	Print all fax activity.
Log Paper Source Tray [x] (1*)	Specify the paper source for printing logs.
Logs Display Remote Fax Name* Dialed Number	Identify the sender by remote fax name or fax number.
Enable Job Log On* Off	View a summary of all fax jobs.
Enable Call Log On* Off	View a summary of fax dialing history.
Log Output Bin Standard Bin* Bin [x]	Specify the output bin for printed logs.
Note: An asterisk (*) next to a value indicates the factory default setting.	

Speaker settings

Menu item	Description
Speaker Mode Always Off* Always On On until Connected	Set the fax speaker mode.
Speaker Volume Low* High	Adjust the fax speaker volume.
Ringer Volume Off* On	Enable the ringer volume.
Note: An asterisk (*) next to a value indicates the factory default setting.	

Fax Server Setup

General Fax Settings

Menu item	Description
To Format	Specify a fax recipient. Note: If you want to use the fax number, then type the number sign (#) before a number.
Reply Address	Specify a reply address for sending fax.
Subject	Specify the fax subject and message.
Message	
Enable analog receive Off* On	Set the printer to receive analog faxes.
Note: An asterisk (*) next to a value indicates the factory default setting.	

Fax Server E-mail Settings

Menu item	Description
Use E-mail SMTP Server On* Off	Use the Simple Mail Transfer Protocol (SMTP) settings for e-mail in receiving and sending faxes. Note: When set to On, all other settings of the Fax Server E-mail Settings menu are not shown.
Primary SMTP Gateway	Type the IP address or host name of the primary SMTP server.
Primary SMTP Gateway Port 1–65535 (25*)	Enter the port number of the primary SMTP server.
Secondary SMTP Gateway	Type the server IP address or host name of your secondary or backup SMTP server.
Secondary SMTP Gateway Port 1–65535 (25*)	Enter the server port number of your secondary or backup SMTP server.
SMTP Timeout 5–30 (30*)	Set the time before the printer times out if the SMTP server does not respond.
Reply Address	Specify a reply address for sending fax.
Use SSL/TLS Disabled* Negotiate Required	Specify whether to send fax using an encrypted link.
Require Trusted Certificate Off On*	Specify a trusted certificate when accessing the SMTP server.
Note: An asterisk (*) next to a value indicates the factory default setting.	

Menu item	Description
SMTP Server Authentication No authentication required* Login / Plain NTLM CRAM-MD5 Digest-MD5 Kerberos 5	Set the authentication type for the SMTP server.
Device-Initiated E-mail None* Use Device SMTP Credentials	Specify whether credentials are required for device-initiated e-mail.
User-Initiated E-mail None* Use Device SMTP Credentials Use Session User ID and Password Use Session E-mail address and Password Prompt user	Specify whether credentials are required for user-initiated e-mail.
Use Active Directory Device Credentials Off* On	Enable user credentials and group destinations to connect to the SMTP server.
Device Userid	Specify the user ID and password to connect to the SMTP server.
Device Password	
Kerberos 5 REALM	Specify the realm for the Kerberos 5 authentication protocol.
NTLM Domain	Specify the domain name for the NTLM security protocol.
Disable "SMTP server not set up" error Off* On	Hide the SMTP server not set up error message.
Note: An asterisk (*) next to a value indicates the factory default setting.	

Fax Server Scan Settings

Menu item	Description
Image Format TIFF (.tif) PDF (.pdf)* XPS (.xps) TXT (.txt) RTF (.rtf) DOCX (.docx) CSV (.csv)	Specify the file format for the scanned image.
Content Type Text* Text/Photo Photo Graphics	Improve the output result based on the content of the original document.
Content Source Black and White Laser Color Laser* Inkjet Photo/Film Magazine Newspaper Press Other	Improve the output result based on the source of the original document.
Fax Resolution Standard* Fine Super Fine Ultra Fine	Set the fax resolution.
Sides Off* Short Edge Long Edge	Specify the orientation of the original document when scanning on both sides of the document.
Darkness 1–9 (5*)	Set the darkness of the output.
Orientation Portrait* Landscape	Specify the orientation of text and graphics on the page.
Note: An asterisk (*) next to a value indicates the factory default setting.	

Menu item	Description
Original Size [List of paper sizes]	Set the paper size of the original document. Notes: <ul style="list-style-type: none"> • Mixed Sizes is the U.S. factory default setting. A4 is the international factory default setting. • This setting may vary depending on your printer model.
Use Multi-Page TIFF Off On*	Choose between single- and multiple-page TIFF files.
Note: An asterisk (*) next to a value indicates the factory default setting.	

E-mail

E-mail Setup

Menu item	Description
Primary SMTP Gateway	Type the IP address or host name of the primary SMTP server for sending e-mail.
Primary SMTP Gateway Port 1–65535 (25*)	Enter the port number of the primary SMTP server.
Secondary SMTP Gateway	Type the server IP address or host name of your secondary or backup SMTP server.
Secondary SMTP Gateway Port 1–65535 (25*)	Enter the server port number of your secondary or backup SMTP server.
SMTP Timeout 5–30 seconds (30*)	Set the time before the printer times out if the SMTP server does not respond.
Reply Address	Specify a reply address in the e-mail.
Always use SMTP default Reply Address On Off*	Always use the default reply address in the SMTP server.
Use SSL/TLS Disabled* Negotiate Required	Specify whether to send e-mail using an encrypted link.
Require Trusted Certificate Off On*	Require a trusted certificate when accessing the SMTP server.
Note: An asterisk (*) next to a value indicates the factory default setting.	

Menu item	Description
SMTP Server Authentication No authentication required* Login / Plain NTLM CRAM-MD5 Digest-MD5 Kerberos 5	Set the authentication type for the SMTP server.
Device-Initiated E-mail None* Use Device SMTP Credentials	Specify whether credentials are required for device-initiated e-mail.
User-Initiated E-mail None* Use Device SMTP Credentials Use Session User ID and Password Use Session E-mail address and Password Prompt user	Specify whether credentials are required for user-initiated e-mail.
Use Active Directory Device Credentials Off* On	Specify whether credentials are required for user-initiated e-mail.
Device Userid	Specify the user ID and password to connect to the SMTP server.
Device Password	
Kerberos 5 REALM	Specify the realm for the Kerberos 5 authentication protocol.
NTLM Domain	Specify the domain name for the NTLM security protocol.
Note: An asterisk (*) next to a value indicates the factory default setting.	

E-mail Defaults

Menu item	Description
Subject:	Specify the e-mail subject and message.
Message:	
File Name	Specify the filename for the scanned document.
Format JPEG (.jpg) PDF (.pdf)* TIFF (.tif) XPS (.xps) TXT (.txt) RTF (.rtf) DOCX (.docx) CSV (.csv)	Specify the file format of the scanned document.
Note: An asterisk (*) next to a value indicates the factory default setting.	

Menu item	Description
Global OCR Settings Recognized Languages Auto Rotate Despeckle Auto Contrast Enhance	Configure the settings for optical character recognition (OCR). Note: This menu item appears only if you have purchased and installed an OCR solution.
PDF Settings PDF Version (1.5*) Archival Version (A-1a*) Highly Compressed (Off*) Secure (Off*) Archival (PDF/A) (Off*)	Configure the PDF settings of the scanned document. Notes: <ul style="list-style-type: none"> • Archival Version and Archival (PDF/A) are supported only when PDF Version is set to 1.4. • Highly Compressed appears only when a hard disk is installed.
Content Type Text Text/Photo* Photo Graphics	Improve the output result based on the content type of the original document.
Content Source Black and White Laser Color Laser* Inkjet Photo/Film Magazine Newspaper Press Other	Improve the output result based on the content source of the original document.
Color Black and White Gray Color* Auto	Set the printer to capture file content in color or in mono.
Resolution 75 dpi 150 dpi* 200 dpi 300 dpi 400 dpi 600 dpi	Set the resolution of the scanned image.
Darkness 1–9 (5*)	Adjust the darkness of the scanned image.
Orientation Portrait* Landscape	Specify the orientation of the original document.
Note: An asterisk (*) next to a value indicates the factory default setting.	

Menu item	Description
Original Size Mixed Sizes*	Set the paper size of the original document.
Sides Off* Short Edge Long Edge	Specify the orientation of the original document when scanning on both sides of the document.
Note: An asterisk (*) next to a value indicates the factory default setting.	

Advanced Imaging

Menu item	Description
Color Balance Cyan (0*) Magenta (0*) Yellow (0*)	Adjust the color intensity for cyan, magenta, and yellow.
Color Dropout Color Dropout (None*) Default Red Threshold (128*) Default Green Threshold (128*) Default Blue Threshold (128*)	Specify which color to drop during scanning, and adjust the dropout setting for that color.
Auto Color Detect Color Sensitivity (5*) Area Sensitivity (5*) E-mail Bit Depth (1 bit*)	Configure the auto color detection setting.
Minimum Scan Resolution 75 dpi 150 dpi 200 dpi 300 dpi*	Specify the minimum resolution for the scanned image.
JPEG Quality Best for content* 5–95	Set the JPEG quality of the scanned image.
Contrast Best for content* 0–5	Specify the contrast for the scanned image.
Background Removal Background Detection (Content-based*) Level (0*)	Remove the background color or image noise from the original document. Notes: <ul style="list-style-type: none"> • Content-based removes the background color from the original document. • Fixed removes image noise from a photo.
Note: An asterisk (*) next to a value indicates the factory default setting.	

Menu item	Description
Mirror Image Off* On	Create a mirror image of the original document.
Negative Image Off* On	Create a negative image of the original document.
Shadow Detail -4 to 4 (0*)	Adjust the shadow detail in the scanned image.
Scan Edge to Edge Off* On	Scan the original document from edge to edge.
Sharpness 1–5 (3*)	Adjust the sharpness in the scanned image.
Temperature -4 to 4 (0*)	Generate a bluer or redder output of the original document.
Blank Pages Blank Page Removal (Do Not Remove*) Blank Page Sensitivity (5*)	Set the sensitivity of scans in relation to blank pages in the original document.
Note: An asterisk (*) next to a value indicates the factory default setting.	

Admin Controls

Menu item	Description
Max E-mail Size 0–65535 (0*)	Set the allowable file size for each e-mail.
Size Error Message	Specify an error message that the printer sends when an e-mail exceeds its allowable file size. Note: You can type up to 1024 characters.
Limit Destinations	Limit sending of e-mail only to the specified list of domain name. Note: Use a comma to separate each domain.
Send Me a Copy Never appears* On by Default Off by Default Always On	Send a copy of the e-mail to yourself.
Allow self e-mails only Off* On	Set the printer to send e-mails to yourself only.
Note: An asterisk (*) next to a value indicates the factory default setting.	

Menu item	Description
Use cc:/bcc: Off* On	Enable carbon copy and blind carbon copy in e-mail.
Use Multi-Page TIFF Off On*	Enable scanning of multiple TIFF images in one TIFF file.
TIFF Compression JPEG LZW*	Specify the compression type for TIFF files.
Text Default 5–95 (75*)	Set the text quality in the content being scanned.
Text/Photo Default 5–95 (75*)	Set the text and photo quality in the content being scanned.
Photo Default 5–95 (50*)	Set the photo quality of the content being scanned.
Adjust ADF Skew Off* On	Set the printer to adjust the skewed images from documents that are scanned from the ADF.
Transmission Log Print log* Do Not Print Log Print Only For Error	Print a transmission log for e-mail scans.
Log Paper Source Tray [x] (1*) Multipurpose Feeder	Specify the paper source for printing e-mail logs.
Log Output Bin Standard Bin * Bin [x]	Specify the output bin for printed logs.
Custom Job Scanning Off* On	Set the printer to scan the first set of original documents using the specified settings, and then scan the next set with the same or different settings. Note: This menu item appears only when a hard disk is installed.
Scan Preview Off* On	Show a scan preview of the original document. Note: This menu item appears only when a hard disk is installed.
Allow Save as Shortcut Off On*	Save an e-mail address as a shortcut.
Note: An asterisk (*) next to a value indicates the factory default setting.	

Menu item	Description
E-mail Images Sent As Attachment* Web Link	Specify how to send the images that are included in the e-mail.
Reset E-mail Information After Sending Off On*	Reset the To, Subject, Message, and Filename fields to their default values after sending an e-mail.
Note: An asterisk (*) next to a value indicates the factory default setting.	

Web Link Setup

Menu item	Description
Server	Specify the credentials of the server that is hosting the images that are included in the e-mail.
Login	
Password	
Path	
File Name	
Web Link	

FTP

FTP Defaults

Menu item	Description
Format JPEG (.jpg) PDF (.pdf)* TIFF (.tif) XPS (.xps) TXT (.txt) RTF (.rtf) DOCX (.docx) CSV (.csv)	Specify the file format for the scanned image.
Global OCR Settings Recognized Languages Auto Rotate Despeckle Auto Contrast Enhance	Configure the settings for optical character recognition (OCR). Note: This menu item appears only if you have purchased and installed an OCR solution.
Note: An asterisk (*) next to a value indicates the factory default setting.	

Menu item	Description
PDF Settings PDF Version (1.5*) Archival Version (A-1a*) Highly Compressed (Off*) Secure (Off*) Archival (PDF/A) (Off*)	Configure the PDF settings for the scanned image. Note: Highly Compressed appears only when a hard disk is installed.
Content Type Text Text/Photo* Graphics Photo	Improve the output result based on the content type of the original document.
Content Source Black and White Laser Color Laser* Inkjet Photo/Film Magazine Newspaper Press Other	Improve the output result based on the content source of the original document.
Color Black and White Gray Color* Auto	Set the printer to capture file content in color or in mono.
Resolution 75 dpi 150 dpi* 200 dpi 300 dpi 400 dpi 600 dpi	Set the resolution of the scanned image.
Darkness 1–9 (5*)	Adjust the darkness of the scanned image.
Orientation Portrait* Landscape	Specify the orientation of the original document.
Original Size Mixed Sizes*	Set the paper size of the original document.
Note: An asterisk (*) next to a value indicates the factory default setting.	

Menu item	Description
Sides Off* Long Edge Short Edge	Specify the orientation when scanning on both sides of the document.
File Name	Specify the file name of the scanned image.
Note: An asterisk (*) next to a value indicates the factory default setting.	

Advanced Imaging

Menu item	Description
Color Balance Cyan (0*) Magenta (0*) Yellow (0*)	Adjust the color intensity for cyan, magenta, and yellow.
Color Dropout Color Dropout (None*) Default Red Threshold (128*) Default Green Threshold (128*) Default Blue Threshold (128*)	Specify which color to drop during scanning, and adjust the dropout setting for that color.
Auto Color Detect Color Sensitivity (5*) Area Sensitivity (5*) FTP Bit Depth (1 bit*)	Configure the auto color detection setting.
JPEG Quality Best for content* 5–95	Set the JPEG quality of the scanned image.
Contrast Best for content* 0 1 2 3 4 5	Specify the contrast for the scanned image.
Background Removal Background Detection (Content-based*) Level (0*)	Remove the background color or image noise from the original document. Notes: <ul style="list-style-type: none"> • Content-based removes the background color from the original document . • Fixed removes image noise from a photo.
Note: An asterisk (*) next to a value indicates the factory default setting.	

Menu item	Description
Mirror Image Off* On	Create a mirror image of the original document.
Negative Image Off* On	Create a negative image of the original document.
Shadow Detail -4 to 4 (0*)	Adjust the shadow detail in the scanned image.
Scan Edge to Edge Off* On	Allow edge-to-edge scanning of the original document.
Sharpness 1–5 (3*)	Adjust the sharpness in the scanned image.
Temperature -4 to 4 (0*)	Generate a bluer or redder output of the original document.
Blank Pages Blank Page Removal (Do Not Remove*) Blank Page Sensitivity (5*)	Set the sensitivity of scans in relation to blank pages in the original document.
Note: An asterisk (*) next to a value indicates the factory default setting.	

Admin Controls

Menu item	Description
Text Default 5–95 (75*)	Set the quality of text on the scanned image.
Text/Photo Default 5–95 (75*)	Set the quality of text and photo on the scanned image.
Photo Default 5–95 (50*)	Set the quality of photo on the scanned image.
Use Multi-Page TIFF On* Off	Enable scanning of multiple TIFF images in one TIFF file.
TIFF Compression LZW* JPEG	Specify the compression type for TIFF files.
Transmission Log Print Log* Do Not Print Log Print Only For Error	Print a transmission log for FTP scans.
Note: An asterisk (*) next to a value indicates the factory default setting.	

Menu item	Description
Log Paper Source Tray [x] (1*) Multipurpose Feeder	Specify the paper source for printing FTP logs.
Custom Job Scanning Off* On	Set the printer to scan the first set of original documents using the specified settings, and then scan the next set with the same or different settings. Note: This menu item appears only when a hard disk is installed.
Scan Preview Off* On	Show a preview of the original document. Note: This menu item appears only when a hard disk is installed.
Allow Save as Shortcut Off On*	Save an FTP address as a shortcut.
Adjust ADF Skew Off* On	Set the printer to adjust the skewed images from documents that are scanned from the ADF.
Note: An asterisk (*) next to a value indicates the factory default setting.	

USB Drive

Flash Drive Scan

Menu item	Description
Format JPEG (.jpg) PDF (.pdf)* TIFF (.tif) XPS (.xps) TXT (.txt) RTF (.rtf) DOCX (.docx) CSV (.csv)	Specify the file format for the scanned image.
Global OCR Settings Recognized Languages Auto Rotate Despeckle Auto Contrast Enhance	Configure the settings for optical character recognition (OCR). Note: This menu item appears only if you have purchased and installed an OCR solution.
Note: An asterisk (*) next to a value indicates the factory default setting.	

Menu item	Description
PDF Settings PDF Version (1.5*) Archival Version (A-1a*) Highly Compressed (Off*) Secure (Off*) Archival (PDF/A) (Off*)	Configure the PDF settings of the scanned image. Notes: <ul style="list-style-type: none"> • Archival Version and Archival (PDF/A) are supported only when PDF Version is set to 1.4. • Highly Compressed appears only when a hard disk is installed.
Content Type Text Text/Photo* Graphics Photo	Improve the output result based on the content type of the original document.
Content Source Black and White Laser Color Laser* Inkjet Photo/Film Magazine Newspaper Press Other	Improve the output result based on the content source of the original document.
Color Black and White Gray Color* Auto	Set the printer to capture file content in color or in mono.
Resolution 75 dpi 150 dpi* 200 dpi 300 dpi 400 dpi 600 dpi	Set the resolution of the scanned image.
Darkness 1–9 (5*)	Adjust the darkness of the scanned image.
Orientation Portrait* Landscape	Specify the orientation of the original document.
Original Size Mixed Sizes*	Set the paper size of the original document.
Note: An asterisk (*) next to a value indicates the factory default setting.	

Menu item	Description
Sides Off* Long edge Short edge	Specify the orientation of the original document when scanning on both sides of the document.
File Name	Specify the file name of the scanned image.
Note: An asterisk (*) next to a value indicates the factory default setting.	

Advanced Imaging

Menu item	Description
Color Balance Cyan (0*) Magenta (0*) Yellow (0*)	Adjust the color intensity for cyan, magenta, and yellow.
Color Dropout Color Dropout (None*) Default Red Threshold (128*) Default Green Threshold (128*) Default Blue Threshold (128*)	Specify which color to drop during scanning, and adjust the dropout setting for that color.
Auto Color Detect Color Sensitivity (5*) Area Sensitivity (5*) Scan Bit Depth (1 bit*)	Configure the auto color detection setting.
JPEG Quality Best for content* 5–95	Set the JPEG quality of the scanned image.
Contrast Best for content* 0–5	Specify the contrast for the scanned image.
Background Removal Background Detection (Content-based*) Level (0*)	Remove the background color or image noise from the original document. Notes: <ul style="list-style-type: none"> • Content-based removes the background color from the original document. • Fixed removes image noise from a photo.
Mirror Image Off* On	Create a mirror image of the original document.
Negative Image Off* On	Create a negative image of the original document.
Note: An asterisk (*) next to a value indicates the factory default setting.	

Menu item	Description
Shadow Detail -4 to 4 (0*)	Adjust the shadow detail in the scanned image.
Scan Edge to Edge Off* On	Scan the original document from edge to edge.
Sharpness 1–5 (3*)	Adjust the sharpness in the scanned image.
Temperature -4 to 4 (0*)	Generate a bluer or redder output of the original document.
Blank Pages Blank Page Removal (Do Not Remove*) Blank Page Sensitivity (5*)	Set the sensitivity of scans in relation to blank pages in the original document.
Note: An asterisk (*) next to a value indicates the factory default setting.	

Admin Controls

Menu item	Description
Text Default 5–95 (75*)	Set the quality of text on the scanned image.
Text/Photo Default 5–95 (75*)	Set the quality of text and photo on the scanned image.
Photo Default 5–95 (50*)	Set the quality of a photo on the scanned image.
Use Multi-Page TIFF Off On*	Enable scanning of multiple TIFF images in one TIFF file.
TIFF Compression LZW* JPEG	Specify the compression type for TIFF files.
Custom Job Scanning Off* On	Set the printer to scan the first set of original documents using the specified settings, and then scan the next set with the same or different settings. Note: This menu item appears only when a hard disk is installed.
Scan Preview Off* On	Show a scan preview of the original document. Note: This menu item appears only when a hard disk is installed.
Adjust ADF Skew Off* On	Set the printer to adjust the skewed images from documents that are scanned from the ADF.
Note: An asterisk (*) next to a value indicates the factory default setting.	

Flash Drive Print

Menu item	Description
Number of Copies 1–9999 (1*)	Set the number of copies.
Paper Source Tray [x] (1*) Multipurpose Feeder Manual Paper Manual Envelope	Set the paper source for the print job.
Color Off On*	Print a flash drive file in color.
Collate (1,1,1) (2,2,2) (1,2,3) (1,2,3)*	Keep the pages of a print job stacked in sequence, particularly when printing multiple copies of the job.
Sides 1-Sided* 2-Sided	Specify whether to print on one side or both sides of the paper.
Staple Off* 1 staple, top left corner 2 staples, left 1 staple, top right corner 2 staples, top 1 staple, bottom left corner 2 staples, bottom 1 staple, bottom right corner 2 staples, right	Specify the staple position for all print jobs. Note: This menu item appears only when a finisher is installed.
Hole Punch Off* On	Punch holes along the edge of the printed output. Note: This menu item appears only when a multiposition staple, hole punch finisher is installed.
Hole Punch Mode 2 holes 3 holes 4 holes	Set the hole punch mode for the printed output. Notes: <ul style="list-style-type: none"> • 3 holes is the U.S. factory default setting. 4 holes is the international factory default setting. • This menu item appears only when a multiposition staple, hole punch finisher is installed.
Note: An asterisk (*) next to a value indicates the factory default setting.	

Menu item	Description
Offset Pages None* Between Copies Between Jobs	Offset the output of each print job or each copy of a print job. Notes: <ul style="list-style-type: none"> • Between Copies offsets each copy of a print job if Collate is set to (1,2,3) (1,2,3). If Collate is set to (1,1,1)(2,2,2), then each set of printed pages is offset, such as all page 1s and all page 2s. • Between Jobs sets the same offset position for the entire print job regardless of the number of copies printed. • This menu item appears only when a multiposition staple, hole punch finisher is installed.
Flip Style Long Edge* Short Edge	Determine which side of the paper is bound when performing two-sided printing.
Pages per Side Off* 2 pages per side 3 pages per side 4 pages per side 6 pages per side 9 pages per side 12 pages per side 16 pages per side	Print multiple page images on one side of a sheet of paper.
Pages per Side Ordering Horizontal* Reverse Horizontal Reverse Vertical Vertical	Specify the positioning of multiple page images when using Pages per Side menu.
Pages per Side Orientation Auto* Landscape Portrait	Specify the orientation of multiple page images when using Pages per Side menu.
Pages per Side Border None* Solid	Print a border around each page image when using Pages per Side menu.
Separator Sheets Off* Between Copies Between Jobs Between Pages	Insert blank separator sheets when printing.
Separator Sheet Source Tray [x] (1*) Multipurpose Feeder	Specify the paper source for the separator sheet.
Note: An asterisk (*) next to a value indicates the factory default setting.	

Menu item	Description
Blank Pages Do Not Print* Print	Print blank pages in a print job.
Note: An asterisk (*) next to a value indicates the factory default setting.	

Network/Ports

Network Overview

Menu item	Description
Active Adapter Auto* Standard Network Wireless	Specify the type of the network connection. Note: Wireless is available only in printers connected to a wireless network.
Network Status	Show the connectivity status of the printer network.
Display Network Status on Printer Off On*	Show the network status on the display.
Speed, Duplex	Show the speed of the currently active network card.
IPv4	Show the IPv4 address.
All IPv6 Addresses	Show all IPv6 addresses.
Reset Print Server	Reset all active network connections to the printer. Note: This setting removes all network configuration settings.
Network Job Timeout Off On* (90 seconds)	Set the time before the printer cancels a network print job.
Banner Page Off* On	Print a banner page.
Scan to PC Port Range	Specify a valid port range for printers that are behind a port blocking firewall.
Enable Network Connections Off On*	Enable the printer to connect to a network.
Enable LLDP Off* On	Enable Link Layer Discovery Protocol (LLDP) in the printer.
Note: An asterisk (*) next to a value indicates the factory default setting.	

Wireless

Note: This menu is available only in printers connected to a Wi-Fi network or printers that have a wireless network adapter.

Menu item	Description
Setup Using Mobile App	Configure the wireless connection using Lexmark Mobile Assistant.
Setup On Printer Panel Choose Network Add Wi-Fi Network Network Name Network Mode (Infrastructure*) Wireless Security Mode (Disabled*)	Configure the wireless connection using the control panel.
Wi-Fi Protected Setup Start Push Button Method Start PIN Method	Establish a Wi-Fi network and enable network security.
Enable Wi-Fi Direct On Off*	Enable Wi-Fi Direct-capable devices to connect to the printer.
Compatibility 802.11b/g/n (2.4GHz) 802.11a/b/g/n/ac (2.4GHz/5GHz)* 802.11a/n/ac (5GHz)	Specify the standard for the Wi-Fi network.
Wireless Security Mode Disabled* WEP WPA2/WPA-Personal WPA2-Personal 802.1x - RADIUS	Set the security mode for connecting the printer to Wi-Fi devices.
IPv4 Enable DHCP (On*) Set Static IP Address	Configure the IPv4 settings.
IPv6 Enable IPv6 (On*) Enable DHCPv6 (Off*) Stateless Address Autoconfiguration (On*) DNS Server Address Manually Assigned IPv6 Address Manually Assigned IPv6 Router Address Prefix (64*) All IPv6 Addresses All IPv6 Router Addresses	Configure the IPv6 settings.
Network Address	Specify the network address.

Menu item	Description
PCL SmartSwitch Off On*	Set the printer to switch automatically to PCL emulation when a print job requires it, regardless of the default printer language. Note: When this setting is disabled, the printer does not examine incoming data and uses the default printer language specified in the Setup menu.
PS SmartSwitch Off On*	Set the printer to switch automatically to PostScript emulation when a print job requires it, regardless of the default printer language. Note: When this setting is disabled, the printer does not examine incoming data and uses the default printer language specified in the Setup menu.
Job Buffering Off* On	Temporarily store print jobs on the hard disk before printing. Note: This menu item appears only when a hard disk is installed.
Mac Binary PS Auto* On Off	Set the printer to process Macintosh binary PostScript print jobs. Notes: <ul style="list-style-type: none"> • On processes raw binary PostScript print jobs. • Off filters print jobs using the standard protocol.

Ethernet

Menu item	Description
Network Speed	Show the speed of the active network adapter.
IPv4 Enable DHCP (On*) Set Static IP Address	Configure the IPv4 settings.
IPv6 Enable IPv6 (On*) Enable DHCPv6 (Off*) Stateless Address Autoconfiguration (On*) DNS Server Address Manually Assigned IPv6 Address Manually Assigned IPv6 Router Address Prefix (64*) All IPv6 Addresses All IPv6 Router Addresses	Configure the IPv6 settings.
Network Address UAA LAA	Specify the network address.

Note: An asterisk (*) next to a value indicates the factory default setting.

Menu item	Description
PCL SmartSwitch Off On*	Set the printer to switch automatically to PCL emulation when a print job requires it, regardless of the default printer language. Note: When this setting is disabled, the printer does not examine incoming data and uses the default printer language specified in the Setup menu.
PS SmartSwitch Off On*	Set the printer to switch automatically to PostScript emulation when a print job requires it, regardless of the default printer language. Note: When this setting is disabled, the printer does not examine incoming data and uses the default printer language specified in the Setup menu.
Job Buffering Off* On	Temporarily store jobs on the hard disk before printing. Note: This menu item appears only when a hard disk is installed.
Mac Binary PS Auto* On Off	Set the printer to process Macintosh binary PostScript print jobs. Notes: <ul style="list-style-type: none"> • Auto processes print jobs from computers using either Windows or Macintosh operating systems. • Off filters PostScript print jobs using the standard protocol.
Energy Efficient Ethernet On Off Auto*	Reduce power consumption when the printer does not receive data from the Ethernet network.
Note: An asterisk (*) next to a value indicates the factory default setting.	

TCP/IP

Note: This menu appears only in network printers or printers attached to print servers.

Menu item	Description
Set Hostname	Set the current TCP/IP host name.
Domain Name	Set the domain name.
Allow DHCP/BOOTP to update NTP server On* Off	Allow the DHCP and BOOTP clients to update the NTP settings of the printer.
Zero Configuration Name	Specify a service name for the zero configuration network.
Enable Auto IP Off* On	Assign an IP address automatically.
DNS Server Address	Specify the current Domain Name System (DNS) server address.
Note: An asterisk (*) next to a value indicates the factory default setting.	

Menu item	Description
Backup DNS Address	Specify the backup DNS server addresses.
Backup DNS Address 2	
Backup DNS Address 3	
Domain Search Order	Specify a list of domain names to locate the printer and its resources that reside in different domains on the network.
Enable DDNS Off* On	Update the Dynamic DNS settings.
DDNS TTL	Specify the current DDNS settings.
Default TTL	
DDNS Refresh Time	
Enable mDNS Off On*	Update the multicast DNS settings.
WINS Server Address	Specify a server address for Windows Internet Name Service (WINS).
Enable BOOTP Off* On	Allow the BOOTP to assign a printer IP address.
Restricted Server List	Specify the IP addresses that are allowed to communicate with the printer over TCP/IP. Notes: <ul style="list-style-type: none"> • Use a comma to separate each IP address. • You can add up to 50 IP addresses.
Restricted Server List Options Block All Ports* Block Printing Only Block Printing and HTTP Only	Specify the access option for IP addresses that are not in the list.
MTU 256–1500 Ethernet (1500*)	Specify a maximum transmission unit (MTU) parameter for the TCP connections.
Raw Print Port 1–65535 (9100*)	Specify a raw port number for printers connected on a network.
Outbound Traffic Maximum Speed Off* On	Set the maximum transfer rate of the printer. Note: When enabled, the option for this setting is 100–1000000 Kilobits/second.
Enable TLSv1.0 Off On*	Enable the TLSv1.0 protocol.
Note: An asterisk (*) next to a value indicates the factory default setting.	

Menu item	Description
Enable TLSv1.1 Off On*	Enable the TLSv1.1 protocol.
SSL Cipher List	Specify the cipher algorithms to use for the SSL or the TLS connections.
Note: An asterisk (*) next to a value indicates the factory default setting.	

SNMP

Note: This menu appears only in network printers or printers that are attached to print servers.

Menu item	Description
SNMP Versions 1 and 2c Enabled Off On* Allow SNMP Set Off On* Enable PPM MIB Off On* SNMP Community	Configure Simple Network Management Protocol (SNMP) versions 1 and 2c to install print drivers and applications.
Note: An asterisk (*) next to a value indicates the factory default setting.	

Menu item	Description
SNMP Version 3 Enabled Off On* Context Name Set Read/Write Credentials User Name Authentication Password Privacy Password Set Read-only Credentials User Name Authentication Password Privacy Password Authentication Hash MD5 SHA1* Minimum Authentication Level No Authentication, No Privacy Authentication, No Privacy Authentication, Privacy* Privacy Algorithm DES AES-128*	Configure SNMP version 3 to install and update the printer security.
Note: An asterisk (*) next to a value indicates the factory default setting.	

IPSec

Note: This menu appears only in network printers or printers that are attached to print servers.

Menu item	Description
Enable IPSec Off* On	Enable Internet Protocol Security (IPSec).
Base Configuration Default* Compatibility Secure	Set the IPSec base configuration. Note: This menu item appears only when Enable IPSec is set to On.
DH (Diffie-Hellman) Group Proposal modp2048 (14)* modp3072 (15) modp4096 (16) modp6144 (17)	Set the IPSec base configuration. Note: This menu item appears only when Base Configuration is set to Compatibility.
Note: An asterisk (*) next to a value indicates the factory default setting.	

Menu item	Description
Proposed Encryption Method 3DES AES*	Set the encryption method. Note: This menu item appears only when Base Configuration is set to Compatibility.
Proposed Authentication Method SHA1 SHA256* SHA512	Set the authentication method. Note: This menu item appears only when Base Configuration is set to Compatibility.
IKE SA Lifetime (Hours) 1 2 4 8 24*	Specify the IKE SA expiry period. Note: This menu item appears only when Base Configuration is set to Secure.
IPSec SA Lifetime (Hours) 1 2 4 8* 24	Specify the IPSec SA expiry period. Note: This menu item appears only when Base Configuration is set to Secure.
IPSec Device Certificate	Specify an IPSec certificate. Note: This menu item appears only when Enable IPSec is set to On.
Pre-Shared Key Authenticated Connections Host [x]	Configure the authenticated connections of the printer. Note: These menu items appear only when Enable IPSec is set to On.
Certificate Authenticated Connections Host [x] Address[/subnet]	
Note: An asterisk (*) next to a value indicates the factory default setting.	

802.1x

Note: This menu appears only in network printers or printers that are attached to print servers.

Menu item	Description
Active Off* On	Let the printer join networks that require authentication before allowing access.
Note: An asterisk (*) next to a value indicates the factory default setting.	

LPD Configuration

Note: This menu appears only in network printers or printers that are attached to print servers.

Menu item	Description
LPD Timeout 0–65535 seconds (90*)	Set the time-out value to stop the Line Printer Daemon (LPD) server from waiting indefinitely for hung or invalid print jobs.
LPD Banner Page Off* On	Print a banner page for all LPD print jobs. Note: A banner page is the first page of a print job used as a separator of print jobs and to identify the originator of the print job request.
LPD Trailer Page Off* On	Print a trailer page for all LPD print jobs. Note: A trailer page is the last page of a print job.
LPD Carriage Return Conversion Off* On	Enable carriage return conversion. Note: Carriage return is a mechanism that commands the printer to move the position of the cursor to the first position on the same line.
Note: An asterisk (*) next to a value indicates the factory default setting.	

HTTP/FTP Settings

Menu item	Description
Enable HTTP Server Off On*	Access the Embedded Web Server to monitor and manage the printer.
Enable HTTPS Off On*	Enable Hypertext Transfer Protocol Secure (HTTPS) to encrypt data transferring to and from the print server.
Force HTTPS Connections On Off*	Force the printer to use HTTPS connections.
Enable FTP/TFTP Off On*	Send files using FTP/TFTP.
Local Domains	Specify domain names for HTTP and FTP servers.
HTTP Proxy IP Address	Configure the HTTP and FTP server settings.
FTP Proxy IP Address	
HTTP Default IP Port	
HTTPS Device Certificate	
FTP Default IP Port	
Timeout for HTTP/FTP Requests 1–299 (30*)	Specify the amount of time before the server connection stops.
Note: An asterisk (*) next to a value indicates the factory default setting.	

Menu item	Description
Retries for HTTP/FTP Requests 1–299 (3*)	Set the number of retries to connect to the HTTP/FTP server.
Note: An asterisk (*) next to a value indicates the factory default setting.	

ThinPrint

Menu item	Description
Enable ThinPrint Off* On	Print using ThinPrint.
Port Number 4000–4999 (4000*)	Set the port number for the ThinPrint server.
Bandwidth (bits/sec) 100–1000000 (0*)	Set the speed to transmit data in a ThinPrint environment.
Packet Size (kbytes) 0–64000 (0*)	Set the packet size for data transmission.
Note: An asterisk (*) next to a value indicates the factory default setting.	

USB

Menu item	Description
PCL SmartSwitch Off On*	Set the printer to switch to PCL emulation when a print job received through a USB port requires it, regardless of the default printer language. Note: When this setting is disabled, the printer does not examine incoming data and uses the default printer language specified in the Setup menu.
PS SmartSwitch Off On*	Set the printer to switch to PostScript emulation when a print job received through a USB port requires it, regardless of the default printer language. Note: When this setting is disabled, the printer does not examine incoming data and uses the default printer language specified in the Setup menu.
Job Buffering Off* On	Temporarily store jobs on the hard disk before printing. Note: This menu item appears only when a hard disk is installed.
Mac Binary PS Auto* On Off	Set the printer to process Macintosh binary PostScript print jobs. Notes: <ul style="list-style-type: none"> • Auto processes print jobs from computers using either Windows or Macintosh operating systems. • Off filters PostScript print jobs using the standard protocol.
Note: An asterisk (*) next to a value indicates the factory default setting.	

Menu item	Description
Enable USB Port Off On*	Enable the front USB drive port.
Note: An asterisk (*) next to a value indicates the factory default setting.	

Restrict external network access

Menu item	Description
Restrict external network access Off* On	Restrict access to network sites.
External network address	Specify the network addresses with restricted access.
E-mail address for notification	Specify an e-mail address to send a notification of logged events.
Ping frequency 1–300 (10*)	Specify the network query interval in seconds.
Subject	Specify the subject and message of the notification e-mail.
Message	
Note: An asterisk (*) next to a value indicates the factory default setting.	

Google Cloud Print

Menu item	Description
Registration Register	Register the printer to the Google Cloud Print server.
Options Enable Google Cloud Print Off On*	Print directly from your Google account.
Options Enable Local Discovery Off On*	Allow the registered user and other users on the same subnet to send jobs to the printer locally.
Options Enable SSL Peer Verification Off On*	Verify authenticity of the peer certificate to connect to your Google account.
Note: An asterisk (*) next to a value indicates the factory default setting.	

Menu item	Description
Options Always Print As Image Off* On	Set the printer to process PDF files as an image for faster printing.
Note: An asterisk (*) next to a value indicates the factory default setting.	

Wi-Fi Direct

Note: This menu appears only when a direct Wi-Fi network is the active network.

Menu item	Description
SSID	Specify the service set identifier (SSID) of the Wi-Fi network.
Preferred Channel Number Auto 1–11 (6*)	Show the PSK on the Network Setup Page.
Set PSK	Set the preshared key (PSK) to authenticate and validate users on a Wi-Fi connection.
Show PSK on Setup Page Off On*	Show the PSK on the Network Setup Page.
Group Owner IP Address	Specify the IP address of the group owner.
Auto-Accept Push Button Requests Off* On	Accept requests to connect to the network automatically. Note: Accepting clients automatically is not secure.
Note: An asterisk (*) next to a value indicates the factory default setting.	

Security

Login Methods

Manage Permissions

Menu item	Description
Function Access Access Address Book in Apps Modify Address Book Manage Shortcuts Create Profiles Manage Bookmarks Flash Drive Print Flash Drive Color Printing Flash Drive Scan Copy Function Copy Color Printing Color Dropout E-mail Function Fax Function FTP Function Release Held Faxes Held Jobs Access Use Profiles Cancel Jobs at the Device Change Language Internet Printing Protocol (IPP) Initiate Scans Remotely B/W Print Color Print Network Folder - Print Network Folder - Color Print Network Folder - Scan Hard Disk - Print Hard Disk - Color Print Hard Disk - Scan	Control access to the printer functions. Note: Some menu items appear only when a hard disk is installed.

Menu item	Description
Administrative Menus Security Menu Network/Ports Menu Paper Menu Reports Menu Function Configuration Menus Supplies Menu Option Card Menu SE Menu Device Menu	Control access to the printer menu settings.
Device Management Remote Management Firmware Updates Apps Configuration Operator Panel Lock Import / Export All Settings Embedded Web Server Access Out of Service Erase	Control access to the printer management options.
Apps New Apps Slideshow Change Wallpaper Screen Saver Card Copy Scan Center Scan Center Custom [x] Forms and Favorites	Control access to printer applications.

Local Accounts

Menu item	Description
Manage Groups/Permissions	Show a list of all saved groups in the printer.
Add User User Name/Password User Name Password PIN	Create local accounts and specify their access to the printer functions, administrative menus, printer management options, and applications.

Schedule USB Devices

Menu item	Description
Schedules Add New Schedule	Schedule access to the front USB port.

Security Audit Log

Menu item	Description
Enable Audit Off* On	Record the events in the secure audit log and remote syslog.
Enable Remote Syslog Off* On	Send audit logs to a remote server.
Remote Syslog Server	Specify the remote syslog server.
Remote Syslog Port 1–65535 (514*)	Specify the remote syslog port.
Remote Syslog Method Normal UDP* Stunnel	Specify a syslog method to transmit logged events to a remote server.
Remote Syslog Facility 0 - Kernel Messages 1 - User-Level Messages 2 - Mail System 3 - System Daemons 4 - Security/Authorization Messages* 5 - Messages Generated Internally by Syslogs 6 - Line Printer Subsystem 7 - Network News Subsystem 8 - UUCP Subsystem 9 - Clock Daemon 10 - Security/Authorization Messages 11 - FTP Daemon 12 - NTP Subsystem 13 - Log Audit 14 - Log Alert 15 - Clock Daemon 16 - Local Use 0 (local0) 17 - Local Use 1 (local1) 18 - Local Use 2 (local2) 19 - Local Use 3 (local3) 20 - Local Use 4 (local4) 21 - Local Use 5 (local5) 22 - Local Use 6 (local6) 23 - Local Use 7 (local7)	Specify a facility code that the printer uses when sending log events to a remote server.
Note: An asterisk (*) next to a value indicates the factory default setting.	

Menu item	Description
Severity of Events to Log 0 - Emergency 1 - Alert 2 - Critical 3 - Error 4 - Warning* 5 - Notice 6 - Informational 7 - Debug	Specify the priority level cutoff for logging messages and events.
Remote Syslog Non-Logged Events Off* On	Send all events, regardless of severity level, to the remote server.
Admin's E-mail Address	Send e-mail notification of logged events to the administrator.
E-mail Log Cleared Alert Off* On	Send e-mail notification to the administrator when a log entry is deleted.
E-mail Log Wrapped Alert Off* On	Send e-mail notification to the administrator when the log becomes full and begins to overwrite the oldest entries.
Log Full Behavior Wrap Over Older Entries* E-mail Log Then Delete All Entries	Resolve log storage issues when the log fills its allotted memory.
E-mail % Full Alert Off* On	Send e-mail notification to the administrator when the log fills its allotted memory.
% Full Alert Level 1–99 (90*)	
E-mail Log Exported Alert Off* On	Send e-mail notification to the administrator when a log is exported.
E-mail Log Settings Changed Alert Off* On	Send e-mail notification to the administrator when Enable Audit is set.
Log Line Endings LF (\n)* CR (\r) CRLF (\r\n)	Specify how the log file terminates the end of each line.
Note: An asterisk (*) next to a value indicates the factory default setting.	

Menu item	Description
Digitally Sign Exports Off* On	Add a digital signature to each exported log file.
Clear Log	Delete all audit logs.
Export Log Syslog (RFC 5424) Syslog (RFC 3164) CSV	Export a security log to a flash drive.
Note: An asterisk (*) next to a value indicates the factory default setting.	

Login Restrictions

Menu item	Description
Login failures 1–10 (3*)	Specify the number of failed login attempts before the user gets locked out.
Failure time frame 1–60 minutes (5*)	Specify the time frame between failed login attempts before the user gets locked out.
Lockout time 1–60 minutes (5*)	Specify the lockout duration.
Web Login Timeout 1–120 minutes (10*)	Specify the delay for a remote login before the user is logged off automatically.
Note: An asterisk (*) next to a value indicates the factory default setting.	

Confidential Print Setup

Menu item	Description
Max Invalid PIN 2–10	Set the number of times an invalid PIN can be entered. Notes: <ul style="list-style-type: none"> • A value of zero turns off this setting. • When the limit is reached, the print jobs for that user name and PIN are deleted.
Confidential Job Expiration Off* 1 Hour 4 Hours 24 Hours 1 Week	Set the expiration time for confidential print jobs. Notes: <ul style="list-style-type: none"> • If this menu item is changed while confidential print jobs reside in the printer memory or hard disk, then the expiration time for those print jobs does not change to the new default value. • If the printer is turned off, then all confidential jobs held in the printer memory are deleted.
Note: An asterisk (*) next to a value indicates the factory default setting.	

Menu item	Description
Repeat Job Expiration Off* 1 Hour 4 Hours 24 Hours 1 Week	Set the expiration time for a print job that you want to repeat.
Verify Job Expiration Off* 1 Hour 4 Hours 24 Hours 1 Week	Set the expiration time that the printer prints a copy for the user to examine its quality, before printing the remaining copies.
Reserve Job Expiration Off* 1 Hour 4 Hours 24 Hours 1 Week	Set the expiration time that the printer stores print jobs for printing later.
Require All Jobs to be Held Off* On	Set the printer to hold all print jobs.
Keep duplicate documents Off* On	Set the printer to print other documents with the same file name without overwriting any of the print jobs.
Note: An asterisk (*) next to a value indicates the factory default setting.	

Disk Encryption

Note: This menu appears only when a hard disk is installed.

Menu item	Description
Status Enabled Disabled	Enable disk encryption.
Start encryption	

Erase Temporary Data Files

Menu item	Description
Stored in onboard memory Off* On	Delete all files stored on the printer memory.
Stored on hard disk 1 Pass Erase* 3 Pass Erase 7 Pass Erase	Delete all files stored on the printer hard disk. Note: This menu item appears only when a printer hard disk is installed.
Note: An asterisk (*) next to a value indicates the factory default setting.	

Solutions LDAP Settings

Menu item	Description
Follow LDAP Referrals Off* On	Search the different servers in the domain for the logged-in user account.
LDAP Certificate Verification Yes No*	Enable verification of LDAP certificates.

Miscellaneous

Menu item	Description
Protected Features Show* Hide	Show all the features that Function Access Control (FAC) protects regardless of the security permission that the user has. Note: Hide displays only FAC-protected features that the user has access.
Print Permission Off* On	Let the user log in before printing.
Default Print Permission Login User Name/Password* User Name	Set the default login for Print Permission.
Security Reset Jumper Enable "Guest" access* No Effect	Specify user access to the printer. Notes: <ul style="list-style-type: none"> The jumper is located beside a lock icon on the controller board. Enable "Guest" access provides anyone access to all aspects of the printer. No Effect may make access to the printer impossible when the required security information is unavailable.
Note: An asterisk (*) next to a value indicates the factory default setting.	

Menu item	Description
Minimum Password Length 0–32	Specify the password length.
Note: An asterisk (*) next to a value indicates the factory default setting.	

Reports

Menu Settings Page

Menu item	Description
Menu Settings Page	Print a report that contains the printer menus.

Device

Menu item	Description
Device Information	Print a report that contains information about the printer.
Device Statistics	Print a report about printer usage and supply status.
Profile List	Print a list of profiles that are stored in the printer.
Asset Report	Print a report that contains the printer serial number and model name.

Print

Menu item	Description
Print Fonts PCL Fonts PS Fonts	Print samples and information about the fonts that are available in each printer language.
Print Demo Demo Page	Print a page that shows the printer capabilities and supported solutions.
Print Directory	Print the resources that are stored in the flash drive or printer hard disk. Note: This menu item appears only when a flash drive or printer hard disk is installed.

Shortcuts

Menu item	Description
All Shortcuts	Print a report that lists the shortcuts that are stored in the printer.
Fax Shortcuts	
Copy Shortcuts	
E-mail Shortcuts	
FTP Shortcuts	
Network Folder Shortcuts	

Fax

Menu item	Description
Fax Job Log	Print a report about the last 200 completed fax jobs. Note: This menu item appears only when Enable Job Log is set to On.
Fax Call Log	Print a report about the last 100 attempted, received, and blocked calls. Note: This menu item appears only when Enable Job Log is set to On.

Network

Menu item	Description
Network Setup Page	Print a page that shows the configured network and wireless settings on the printer. Note: This menu item appears only in network printers or printers connected to print servers.
Wi-Fi Direct Connected Clients	Print a page that shows the list of devices that are connected to the printer using Wi-Fi Direct. Note: This menu item appears only when Enable Wi-Fi Direct is set to On.

Help

Menu item	Description
Print All Guides	Prints all the guides
Color Quality Guide	Provides information about solving color quality issues
Connection Guide	Provides information about connecting the printer locally (USB) or to a network
Copy Guide	Provides information about making a copy and configuring the settings
E-mail Guide	Provides information about sending an e-mail and configuring the settings
Fax Guide	Provides information about sending a fax and configuring the settings
Information Guide	Provides information about the printer
Media Guide	Provides information about loading paper and specialty media

Menu item	Description
Moving Guide	Provides information about moving, locating, or shipping the printer
Print Quality Guide	Provides information about solving print quality issues
Scan Guide	Provides information about scanning a document and configuring the settings
Supplies Guide	Provides information about ordering supplies

Troubleshooting

Menu item	Description
Print Quality Test Pages	Print sample pages to identify and correct print quality defects.
Cleaning the Scanner	Print instructions on how to clean the scanner.

Printing the Menu Settings Page

From the home screen, touch **Settings > Reports > Menu Settings Page**.

Securing the printer

Locating the security slot

The printer is equipped with a security lock feature. Attach a security lock compatible with most laptop computers in the location shown to secure the printer in place.



Erasing printer memory

To erase volatile memory or buffered data in your printer, turn off the printer.

To erase nonvolatile memory or individual settings, device and network settings, security settings, and embedded solutions, do the following:

- 1 From the home screen, touch **Settings > Device > Maintenance > Out of Service Erase**.
- 2 Select the **Sanitize all information on nonvolatile memory** check box, and then touch **ERASE**.
- 3 Select **Start initial setup wizard** or **Leave printer offline**, and then touch **Next**.
- 4 Start the operation.

Erasing printer hard disk memory

- 1 From the home screen, touch **Settings > Device > Maintenance > Out of Service Erase**.
- 2 Select the **Sanitize all information on hard disk** check box, and then touch **ERASE**.
- 3 Select a method to erase data.
- 4 Start the operation.

Note: This process can take from several minutes to more than an hour, making the printer unavailable for other tasks.

Encrypting the printer hard disk

This process erases all contents in the hard disk. If necessary, back up important data from the printer before starting the encryption.

- 1 From the home screen, touch **Settings > Security > Disk Encryption > Start encryption.**
- 2 Follow the instructions on the display.

Notes:

- To avoid loss of data, do not turn off the printer during the encryption process.
- This process can take from several minutes to more than an hour, making the printer unavailable for other tasks.
- After encryption, the printer automatically restarts.

Restoring factory default settings

- 1 From the home screen, touch **Settings > Device > Restore Factory Defaults.**
- 2 Touch **Restore Settings >** select the settings that you want to restore **> RESTORE.**
- 3 Start the operation.

Statement of Volatility

Type of memory	Description
Volatile memory	The printer uses standard random access memory (RAM) to buffer temporarily user data during simple print and copy jobs.
Non-volatile memory	The printer may use two forms of non-volatile memory: EEPROM and NAND (flash memory). Both types are used to store the operating system, printer settings, network information, scanner and bookmark settings, and embedded solutions.
Hard disk memory	Some printers may have a hard disk drive installed. The printer hard disk is designed for printer-specific functionality. The hard disk lets the printer retain buffered user data from complex print jobs, form data, and font data.

Erase the content of any installed printer memory in the following circumstances:

- The printer is decommissioned.
- The printer hard disk is replaced.
- The printer is moved to a different department or location.
- The printer is serviced by someone from outside your organization.

- The printer is removed from your premises for service.
- The printer is sold to another organization.

Disposing of a printer hard disk

- **Degaussing**—Flushes the hard disk with a magnetic field that erases stored data
- **Crushing**—Physically compresses the hard disk to break component parts and render them unreadable
- **Milling**—Physically shreds the hard disk into small metal bits

Note: To guarantee that all data are completely erased, destroy physically each hard disk where data is stored.

Maintaining the printer

Warning—Potential Damage: Failure to maintain optimum printer performance, or to replace parts and supplies, may cause damage to your printer.

Setting up e-mail alerts

Configure the printer to send e-mail alerts when supplies are low, when paper must be changed or added, or when there is a paper jam.

- 1 Open a web browser, and then type the printer IP address in the address field.

Notes:

- View the printer IP address on the printer home screen. The IP address appears as four sets of numbers separated by periods, such as 123.123.123.123.
- If you are using a proxy server, then temporarily disable it to load the web page correctly.

- 2 Click **Settings > Device > Notifications > E-mail Alert Setup**, and then configure the settings.

- 3 Click **Setup E-mail Lists and Alerts**, and then configure the settings.

- 4 Apply the changes.

Note: For more information on SMTP server settings, contact your e-mail provider.

Viewing reports

- 1 From the home screen, touch **Settings > Reports**.

- 2 Select the report that you want to view.

Adjusting the speaker volume

Adjusting the default internal speaker volume

- 1 From the control panel, navigate to:

Settings > Device > Preferences > Audio Feedback

- 2 Adjust the volume.

Notes:

- If Quiet Mode is enabled, then audible alerts are turned off. This setting also slows the printer performance.
- The volume resets to the default value after the session is logged out or when the printer wakes from Sleep or Hibernate mode.

Adjusting the default headphones volume

Headphones volume will reset to default value after the session is logged out, when the printer wakes from Sleep or Hibernate mode, or after a power-on reset.

- 1 From the control panel, select **Settings > Device > Accessibility > Headphone Volume**.
- 2 Select the volume.

Configuring the fax speaker settings

- 1 From the home screen, touch **Settings > Fax > Fax Setup > Speaker Settings**.
- 2 Do the following:
 - Set the Speaker Mode to **Always On**.
 - Set the Speaker Volume to **High**.
 - Activate the Ringer Volume.

Networking

Note: Purchase a MarkNet™ N8370 wireless network adapter first before setting up the printer on a wireless network. For information on installing the wireless network adapter, see the setup sheet that came with the adapter.

Connecting the printer to a wireless network using Wi-Fi Protected Setup (WPS)

Before you begin, make sure that:

- The access point (wireless router) is WPS-certified or WPS-compatible. For more information, see the documentation that came with your access point.
- A wireless network adapter is installed in your printer. For more information, see the instructions that came with the adapter.
- Active Adapter is set to Auto. From the home screen, touch **Settings > Network/Ports > Network Overview > Active Adapter**.

Using the Push Button method

- 1 From the home screen, touch **Settings > Network/Ports > Wireless > Wi-Fi Protected Setup > Start Push Button Method**.
- 2 Follow the instructions on the display.

Using the personal identification number (PIN) method

- 1 From the home screen, touch **Settings > Network/Ports > Wireless > Wi-Fi Protected Setup > Start PIN Method**.
- 2 Copy the eight-digit WPS PIN.
- 3 Open a web browser, and then type the IP address of your access point in the address field.

Notes:

- To know the IP address, see the documentation that came with your access point.
- If you are using a proxy server, then temporarily disable it to load the web page correctly.

4 Access the WPS settings. For more information, see the documentation that came with your access point.

5 Enter the eight-digit PIN, and then save the changes.

Connecting a mobile device to the printer

Before connecting your mobile device, make sure to do the following:

- Enable Wi-Fi Direct in the printer. From the control panel, navigate to: **Settings > Network/Ports > Wireless > Enable Wi-Fi Direct**.
- Show the preshared key (PSK) on the Network Setup Page. From the control panel, navigate to: **Settings > Network/Ports > Wi-Fi Direct > Show PSK on Setup Page**.
- Print the Network Setup Page. From the control panel, navigate to: **Settings > Reports > Network > Network Setup Page**.

Connecting using Wi-Fi Direct

- 1** From the mobile device, go to the settings menu.
- 2** Enable Wi-Fi, and then tap **Wi-Fi Direct**.
- 3** Select the printer SSID.
- 4** Confirm the connection on the printer control panel.

Connecting using Wi-Fi

- 1** From the mobile device, go to the settings menu.
- 2** Tap **Wi-Fi**, and then select the printer SSID.

Note: The string **DIRECT-xy** (where **x** and **y** are two random characters) is added before the SSID.

- 3** Enter the PSK.

Note: The PSK is the password.

Notes:

- You can change the SSID on the control panel. Navigate to: **Settings > Network/Ports > Wi-Fi Direct > SSID**.
- You can also change the PSK on the control panel. Navigate to: **Settings > Network/Ports > Wi-Fi Direct > Set PSK**.

Changing the printer port settings after installing an internal solutions port

Notes:

- If the printer has a static IP address, then do not change the configuration.
- If the computers are configured to use the network name instead of an IP address, then do not change the configuration.
- If you are adding a wireless internal solutions port (ISP) to a printer previously configured for an Ethernet connection, then disconnect the printer from the Ethernet network.

For Windows users

- 1 Open the printers folder.
- 2 From the shortcut menu of the printer with the new ISP, open the printer properties.
- 3 Configure the port from the list.
- 4 Update the IP address.
- 5 Apply the changes.

For Macintosh users

- 1 From System Preferences in the Apple menu, navigate to the list of printers, and then select **+ > IP**.
- 2 Type the IP address in the address field.
- 3 Apply the changes.

Deactivating the Wi-Fi network

- 1 From the home screen, touch **Settings > Network/Ports > Network Overview > Active Adapter > Standard Network**.
- 2 Follow the instructions on the display.

Setting up serial printing (Windows only)

- 1 Set the parameters in the printer.
 - a From the control panel, navigate to the menu for the port settings.
 - b Locate the menu for the serial port settings, and then adjust the settings, if necessary.
 - c Apply the changes.
- 2 From your computer, open the printers folder, and then select your printer.
- 3 Open the printer properties, and then select the COM port from the list.
- 4 Set the COM port parameters in Device Manager.

Notes:

- Serial printing reduces printing speed.
- Make sure that the serial cable is connected to the serial port on your printer.

Cleaning printer parts

Cleaning the printer

⚠ CAUTION—SHOCK HAZARD: To avoid the risk of electrical shock when cleaning the exterior of the printer, unplug the power cord from the electrical outlet and disconnect all cables from the printer before proceeding.

Notes:

- Perform this task after every few months.
- Damage to the printer caused by improper handling is not covered by the printer warranty.

- 1 Turn off the printer, and then unplug the power cord from the electrical outlet.
- 2 Remove paper from the standard bin and multipurpose feeder.
- 3 Remove any dust, lint, and pieces of paper around the printer using a soft brush or vacuum.
- 4 Wipe the outside of the printer with a damp, soft, lint-free cloth.

Notes:

- Do not use household cleaners or detergents, as they may damage the finish of the printer.
- Make sure that all areas of the printer are dry after cleaning.

- 5 Connect the power cord to the electrical outlet, and then turn on the printer.

⚠ CAUTION—POTENTIAL INJURY: To avoid the risk of fire or electrical shock, connect the power cord to an appropriately rated and properly grounded electrical outlet that is near the product and easily accessible.

Cleaning the scanner

- 1 Open the scanner cover.



2 Using a damp, soft, lint-free cloth, wipe the following areas:

- ADF glass

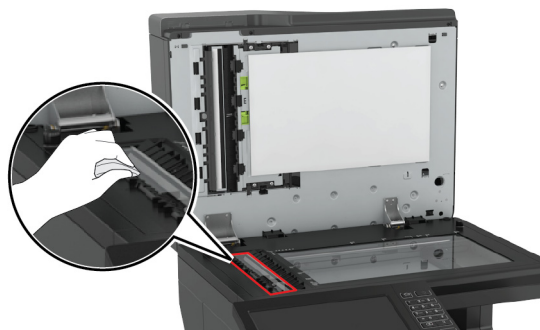

- ADF glass pad

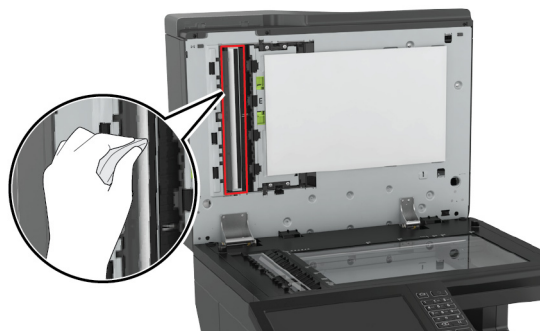

- Scanner glass

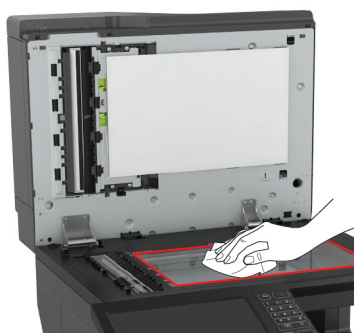

- Scanner glass pad

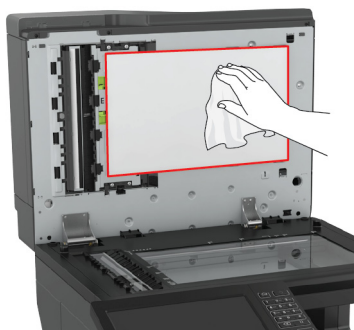

3 Open door E.

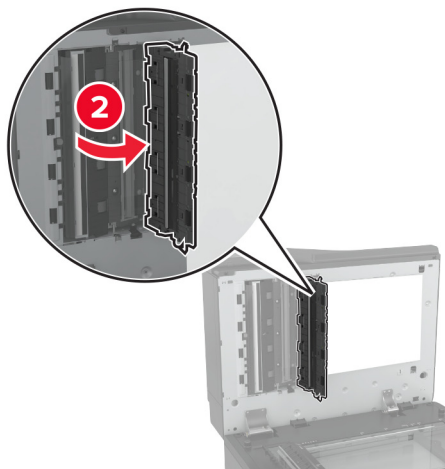
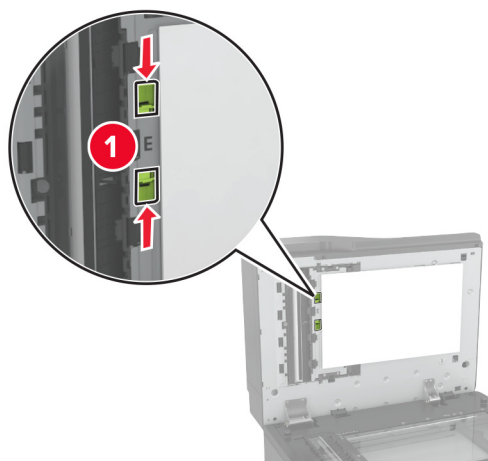

4 Wipe the following areas:

- ADF glass in door E

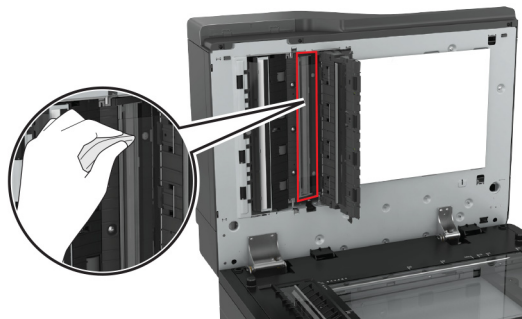

- ADF glass pad in door E

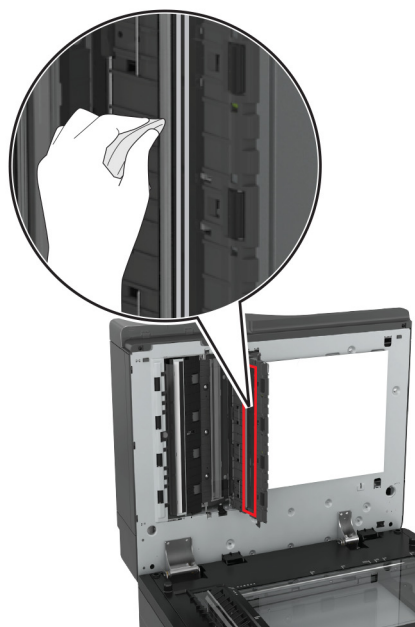
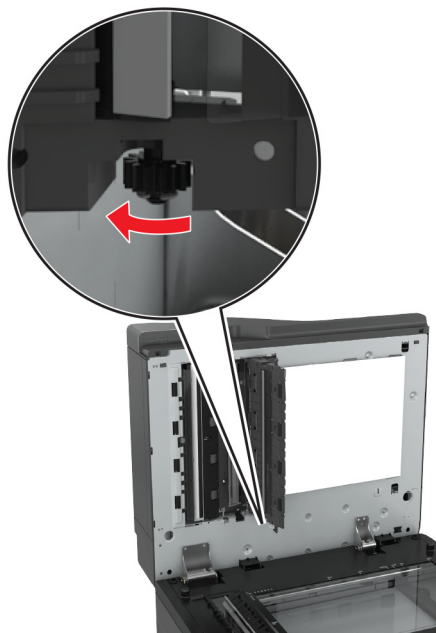

5 Close the door, and then close the scanner cover.

Ordering parts and supplies

To order parts and supplies in the U.S., contact 1-800-539-6275 for information about Lexmark authorized supplies dealers in your area. In other countries or regions, go to www.lexmark.com or contact the place where you purchased the printer.

Note: All life estimates for printer supplies assume printing on letter- or A4-size plain paper.

Checking the status of parts and supplies

- 1 From the home screen, touch **Status/Supplies**.
- 2 Select the parts or supplies that you want to check.

Note: You can also access this setting by touching the top section of the home screen.

Using genuine Lexmark parts and supplies

Your Lexmark printer is designed to function best with genuine Lexmark parts and supplies. Use of third-party supplies or parts may affect the performance, reliability, or life of the printer and its imaging components. It can also affect warranty coverage. Damage caused by the use of third-party parts and supplies is not covered by the warranty. All life indicators are designed to function with Lexmark parts and supplies, and may deliver unpredictable results if third-party parts and supplies are used. Imaging component usage beyond the intended life may damage your Lexmark printer or its associated components.

Ordering toner cartridges

Notes:

- The estimated cartridge yield is based on the ISO/IEC 19798 standard.
- Extremely low print coverage for extended periods of time may negatively affect actual yield and may cause cartridge parts to fail before toner exhaustion.

Lexmark CX820 Return Program cartridges

Item	United States and Canada	European Economic Area	Rest of Europe, Middle East, and Africa	Latin America	Rest of Asia Pacific	Australia and New Zealand
Return Program toner cartridges						
Black	72K10K0	72K20K0	72K50K0	72K40K0	72K30K0	72K60K0
Cyan	72K10C0	72K20C0	72K50C0	72K40C0	72K30C0	72K60C0
Magenta	72K10M0	72K20M0	72K50M0	72K40M0	72K30M0	72K60M0
Yellow	72K10Y0	72K20Y0	72K50Y0	72K40Y0	72K30Y0	72K60Y0
High Yield Return Program toner cartridges						
Cyan	82K1HC0	82K2HC0	82K5HC0	82K4HC0	82K3HC0	82K6HC0
Magenta	82K1HM0	82K2HM0	82K5HM0	82K4HM0	82K3HM0	82K6HM0

Item	United States and Canada	European Economic Area	Rest of Europe, Middle East, and Africa	Latin America	Rest of Asia Pacific	Australia and New Zealand
Yellow	82K1HY0	82K2HY0	82K5HY0	82K4HY0	82K3HY0	82K6HY0
Extra High Yield Return Program toner cartridge						
Black	72K1XK0	72K2XK0	72K3XK0	72K4XK0	72K5XK0	72K6XK0

Lexmark CX820 regular cartridges

Item	Worldwide
High yield regular toner cartridges	
Cyan	82K0H20
Magenta	82K0H30
Yellow	82K0H40
Extra high yield regular toner cartridge	
Black	72K0X10

Lexmark CX827 Return Program cartridges

Item	United States and Canada	European Economic Area	Rest of Europe, Middle East, and Africa	Latin America	Rest of Asia Pacific	Australia and New Zealand
Regular Program toner cartridges						
Black	73B10K0	73B20K0	73B50K0	73B40K0	73B30K0	73B60K0
Cyan	73B10C0	73B20C0	73B50C0	73B40C0	73B30C0	73B60C0
Magenta	73B10M0	73B20M0	73B50M0	73B40M0	73B30M0	73B60M0
Yellow	73B10Y0	73B20Y0	73B50Y0	73B40Y0	73B30Y0	73B60Y0

Lexmark CX827 regular cartridges

Item	Worldwide
Regular toner cartridges	
Black	73B0010
Cyan	73B0020
Magenta	73B0030
Yellow	73B0040

Lexmark XC6152 and XC6153 Return Program cartridges

Item	Worldwide	Latin America
Black	24B6511	24B2454
Cyan	24B6508	24B2154
Magenta	24B6509	24B2155
Yellow	24B6510	24B2421

Ordering a photoconductor unit

Item	Part number
Photoconductor unit (1 pack)	72K0P00
Photoconductor unit (3 pack)	72K0Q00

Ordering a developer and PC unit combo pack

Item	All countries and regions
Return Program developer and PC unit combo pack	
Black	72K0FK0
Color (CMY)	72K0FV0
Regular developer and PC unit combo pack	
Black	72K0F10
Color (CMY)	72K0F50

Ordering developer units

Item	Part number
Return Program developer units	
Black developer unit	72K0DK0
Color (CMY) developer kit	72K0DV0
Cyan developer unit	72K0DC0
Magenta developer unit	72K0DM0
Yellow developer unit	72K0DY0
Regular developer units	
Black developer unit	72K0D10
Color (CMY) developer kit	72K0D50
Cyan developer unit	72K0D20
Magenta developer unit	72K0D30

Item	Part number
Yellow developer unit	72K0D40

Ordering staple cartridges

Item	Part number
Staple cartridges	25A0013

Ordering a waste toner bottle

Item	Part number
Waste toner bottle	72K0W00

Configuring supply notifications

- 1 Open a web browser, and then type the printer IP address in the address field.

Notes:

- View the printer IP address on the printer home screen. The IP address appears as four sets of numbers separated by periods, such as 123.123.123.123.
- If you are using a proxy server, then temporarily disable it to load the web page correctly.

- 2 Click **Settings > Device > Notifications**.
- 3 From the Supplies menu, click **Custom Supply Notifications**.
- 4 Select a notification for each supply item.
- 5 Apply the changes.

Replacing parts and supplies

Replacing a developer unit

1 Open door A.

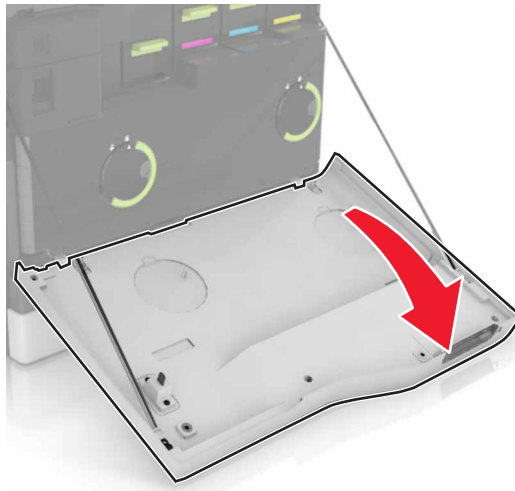

2 Remove the waste toner bottle.

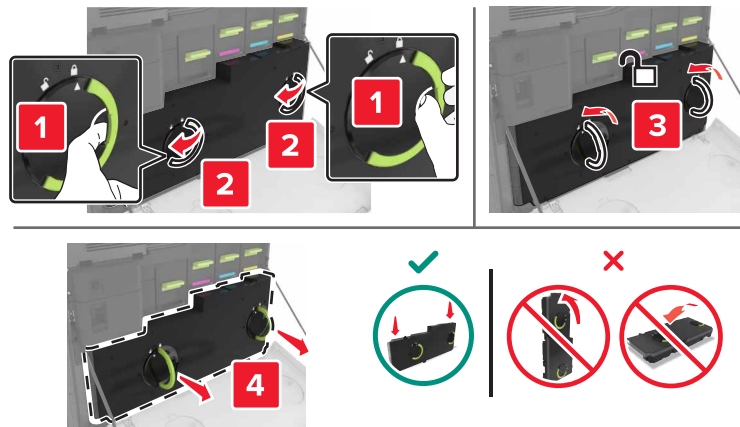

3 Remove the imaging unit.

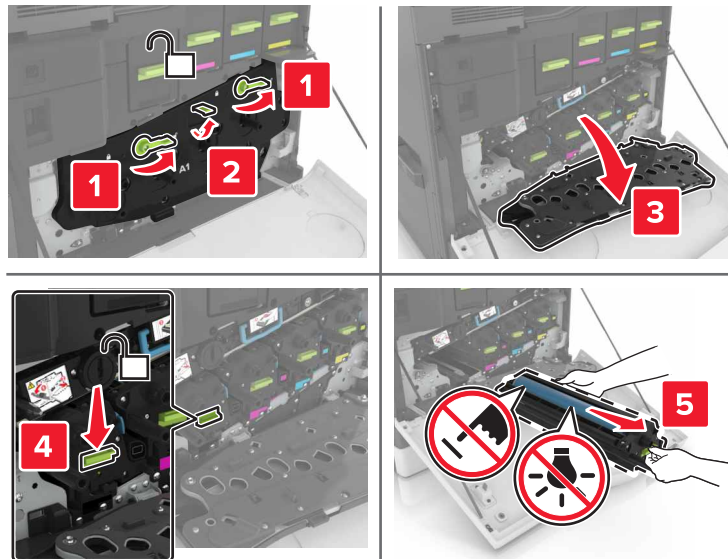

4 Remove the developer unit.

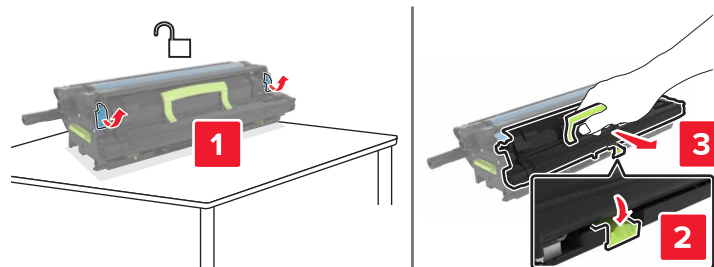

5 Unpack the new developer unit, and then remove the packing material.

6 Insert the new developer unit.

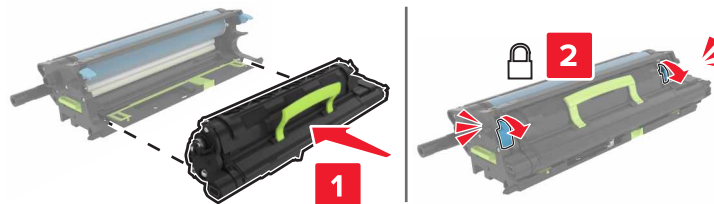

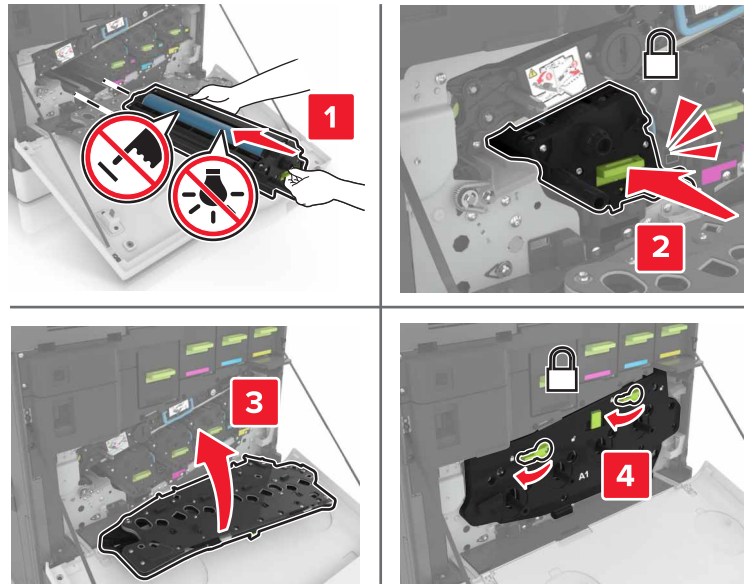
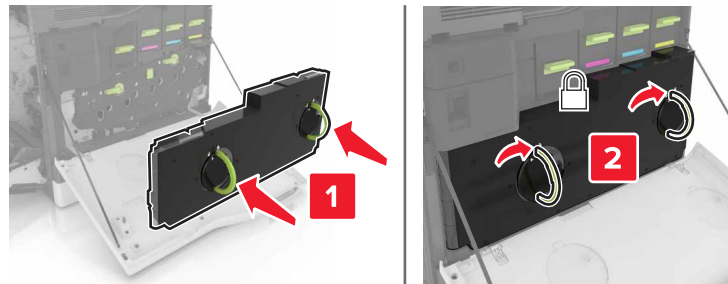
7 Insert the imaging unit.**8** Insert the waste toner bottle.**9** Close door A.**Replacing the fuser**

- 1** Turn off the printer.
- 2** Open door B.

 **CAUTION—HOT SURFACE:** The inside of the printer might be hot. To reduce the risk of injury from a hot component, allow the surface to cool before touching it.



3 Remove the fuser.

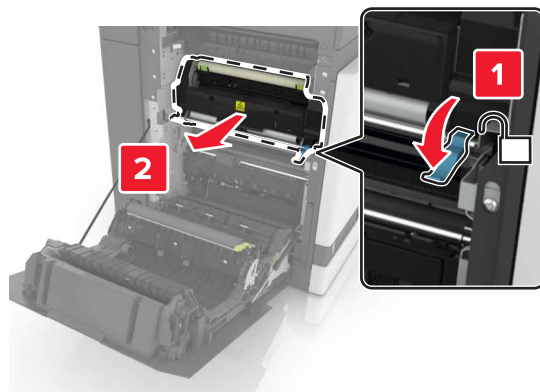

4 Unpack the new fuser.

5 Clean the fuser lens using the cotton swab that came with the package.

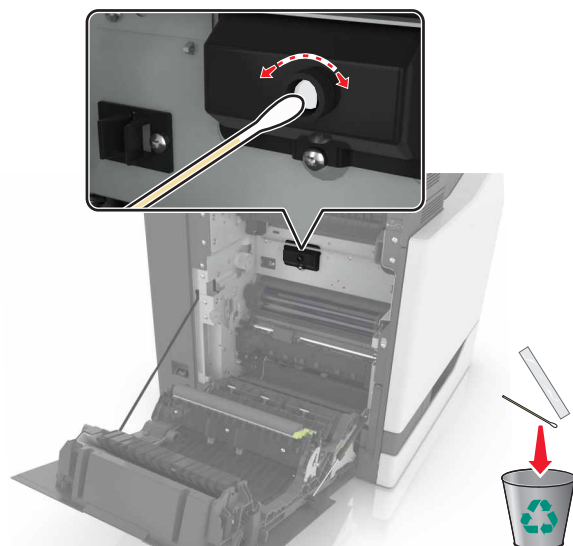

6 Insert the new fuser until it *clicks* into place.

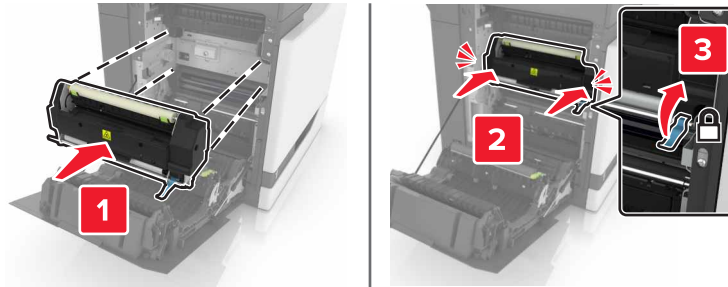

7 Close door B.

8 Turn on the printer.

Replacing a photoconductor unit

1 Open door A.

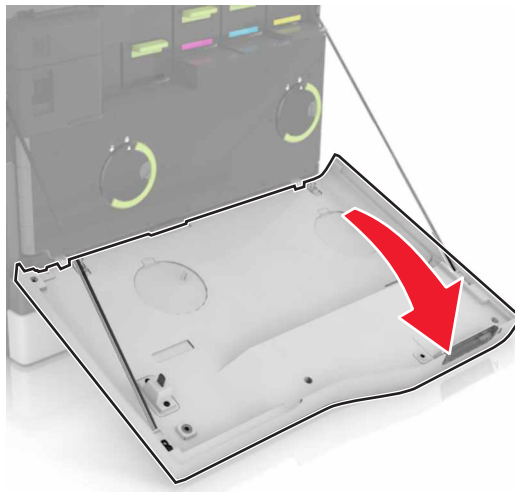

2 Remove the waste toner bottle.

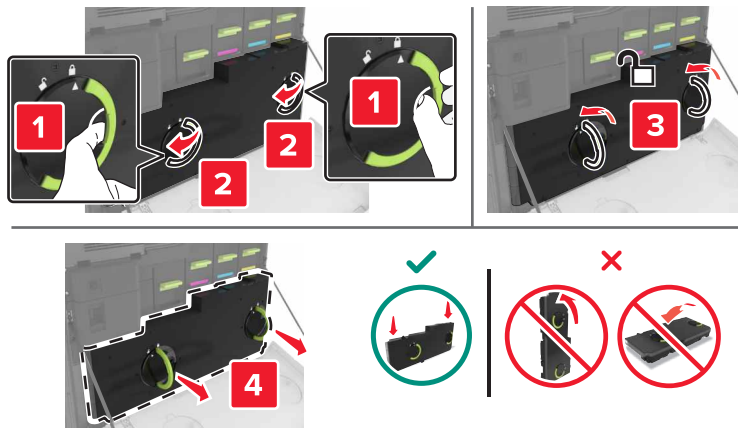

3 Remove the imaging unit.

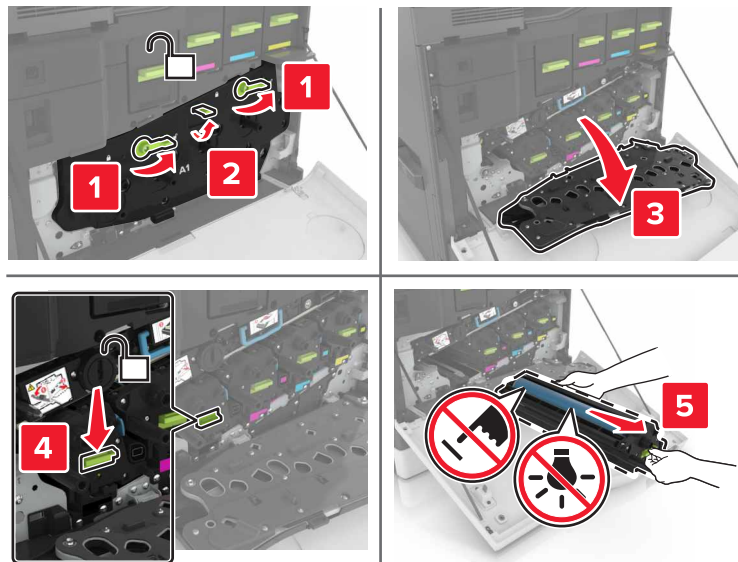

4 Remove the photoconductor unit.

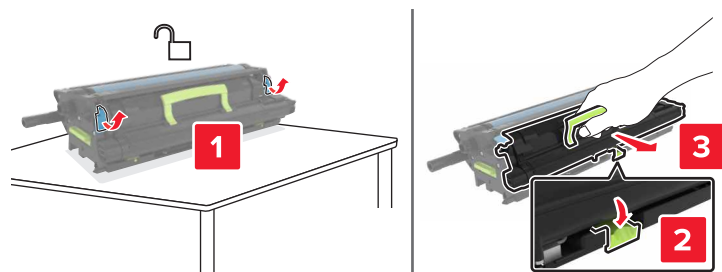

5 Unpack the new photoconductor unit, and then remove the packing material.

Warning—Potential Damage: Do not expose the photoconductor unit to direct light for more than 10 minutes. Extended exposure to light may cause print quality problems.

Warning—Potential Damage: Do not touch the photoconductor drum. Doing so may affect the print quality of future print jobs.

6 Insert the new photoconductor unit.

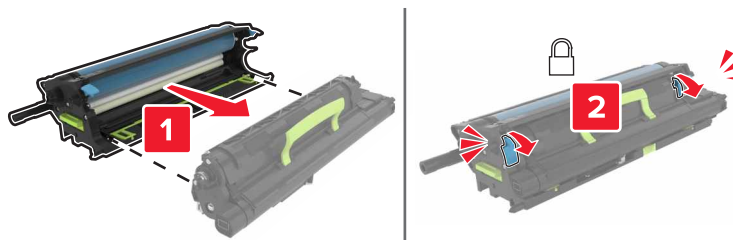

7 Insert the imaging unit.

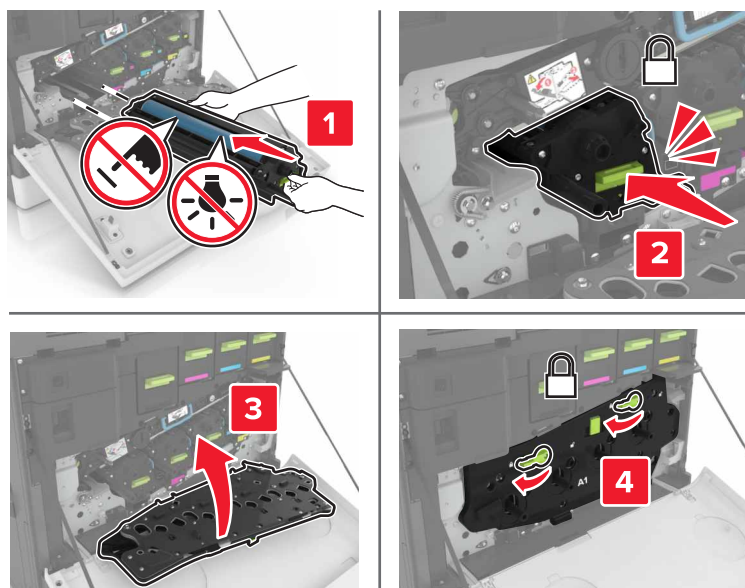

8 Insert the waste toner bottle.

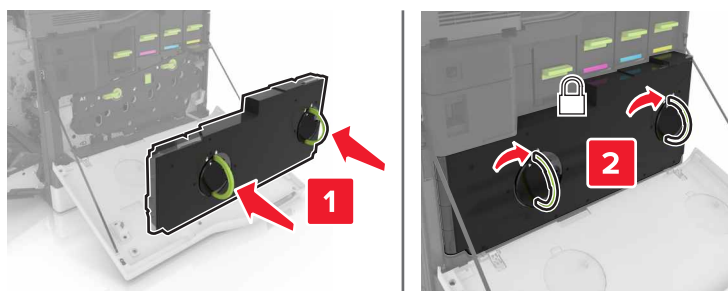

9 Close door A.

Replacing an imaging unit

1 Open door A.

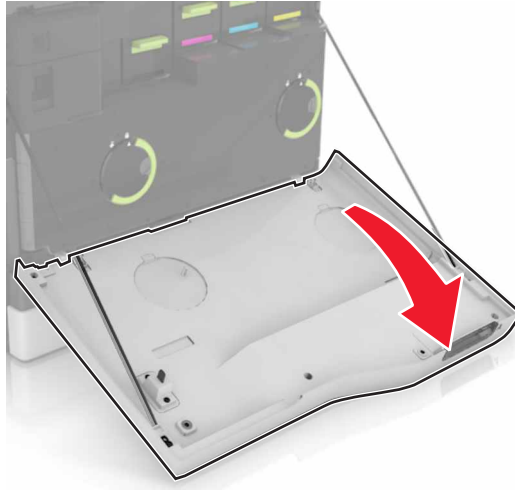

2 Remove the waste toner bottle.

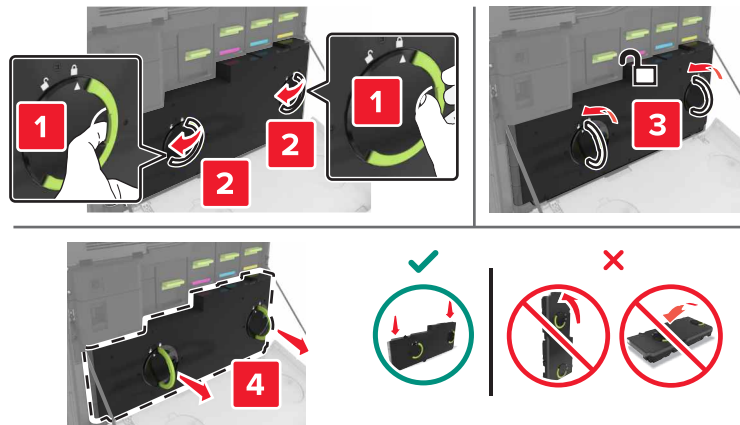

3 Remove the imaging unit.

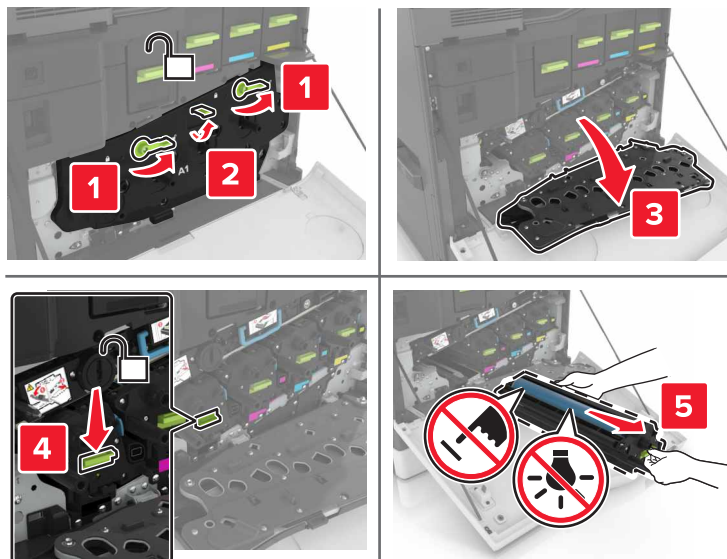

4 Unpack the new imaging unit, and then remove the packing material.

Warning—Potential Damage: Do not expose the photoconductor unit to direct light for more than 10 minutes. Extended exposure to light may cause print quality problems.

Warning—Potential Damage: Do not touch the photoconductor drum. Doing so may affect the print quality of future print jobs.

5 Insert the new imaging unit.

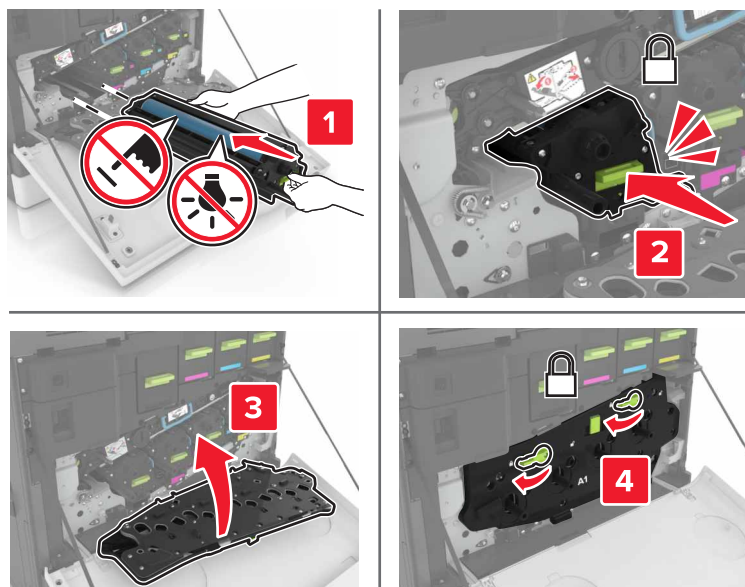

6 Insert the waste toner bottle.

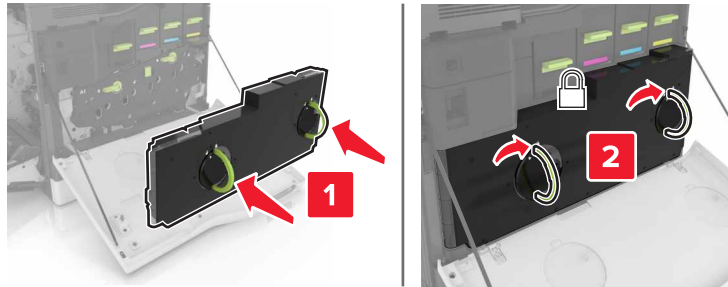

7 Close door A.

Replacing a toner cartridge

1 Open door A.

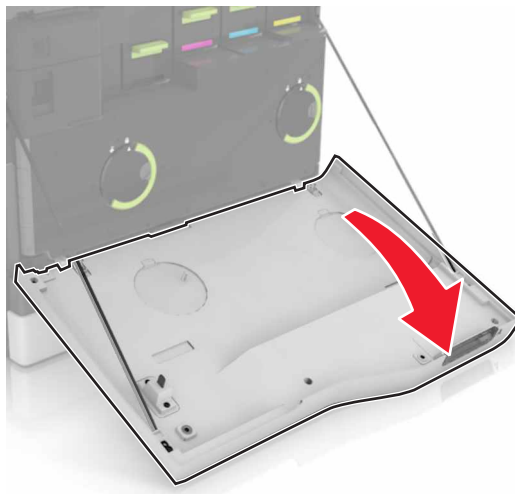

2 Remove the toner cartridge.



3 Unpack the new toner cartridge.

- 4 Insert the new toner cartridge until it *clicks* into place.

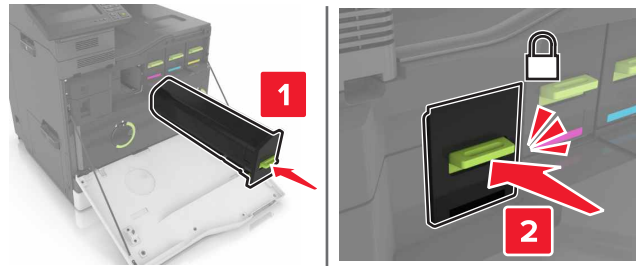

- 5 Close door A.

Replacing the pick roller

Replacing the pick roller in the 550-sheet tray or envelope tray

- 1 Turn off the printer.
- 2 Remove the tray.

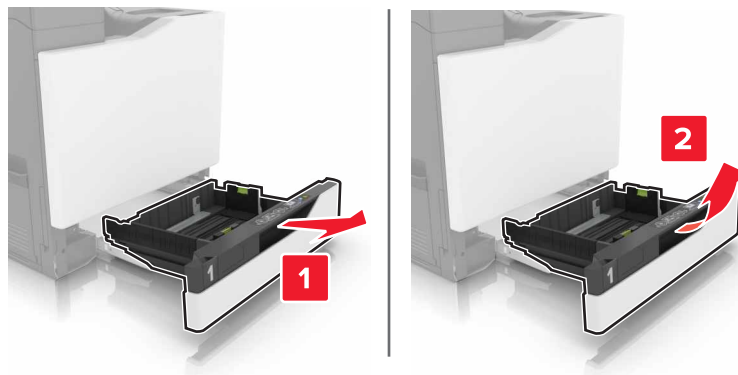

3 Remove the pick roller.

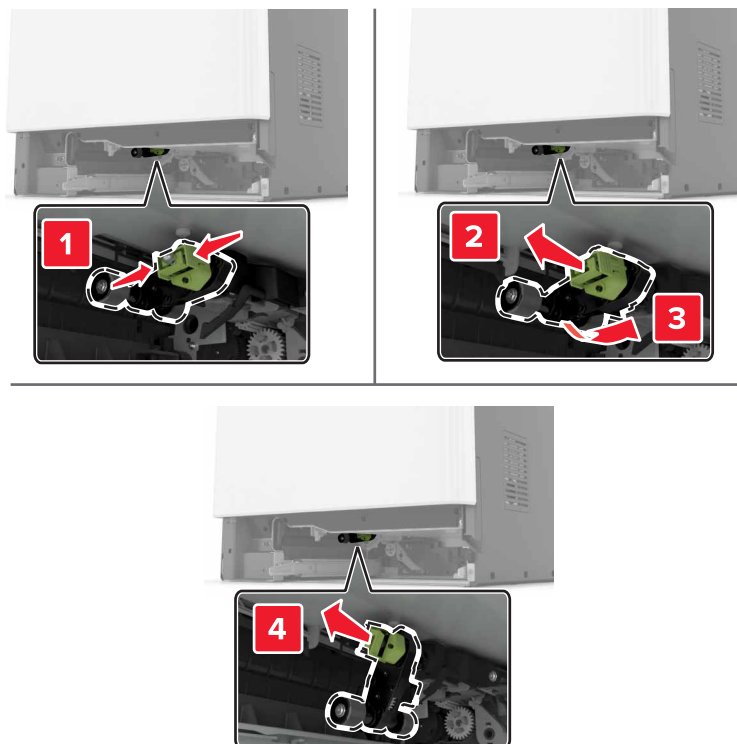

4 Unpack the new pick roller.

5 Insert the new pick roller until it *clicks* into place.

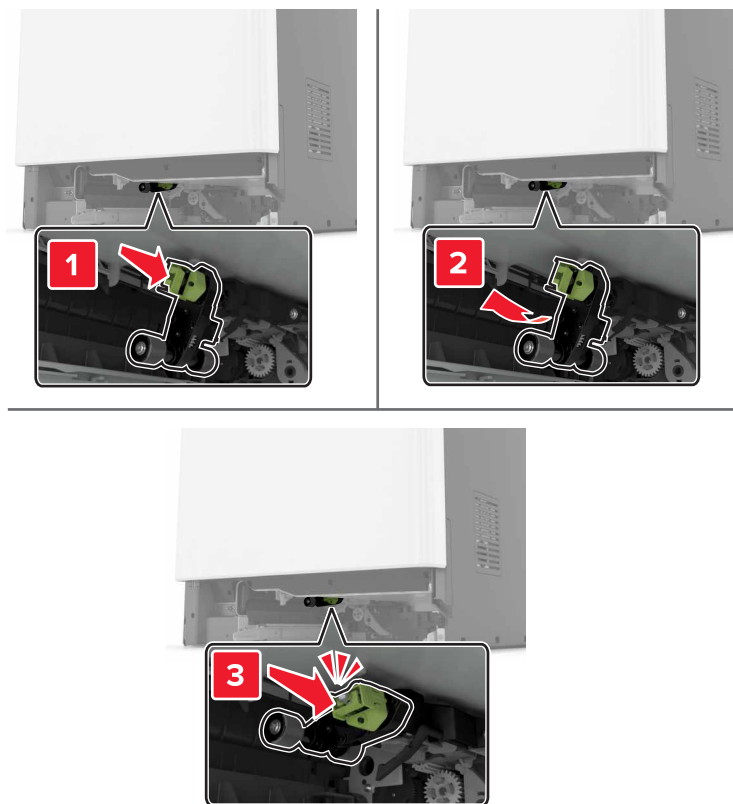

6 Insert the tray.

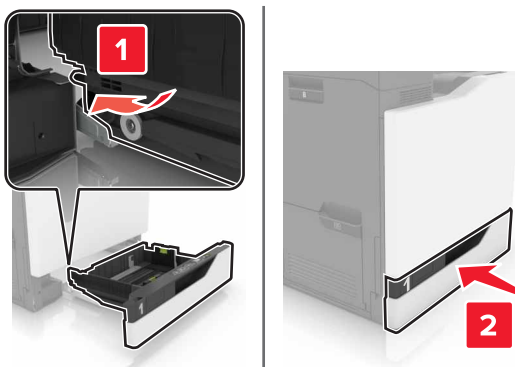

7 Turn on the printer.

Replacing the pick roller in the 2200-sheet tray

- 1 Turn off the printer.
- 2 Pull out, and then unlock the tray.

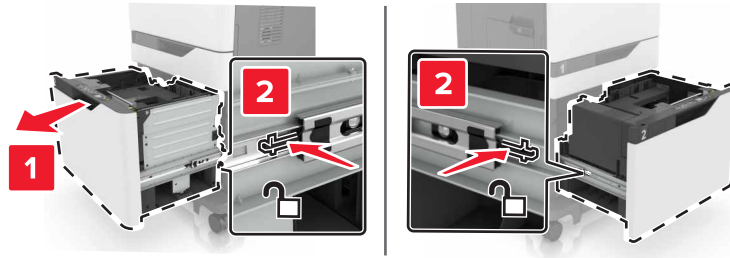

- 3 Remove the tray.
- 4 Remove the pick roller.

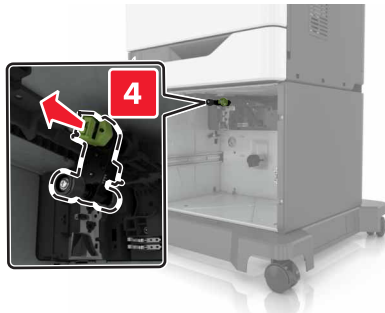
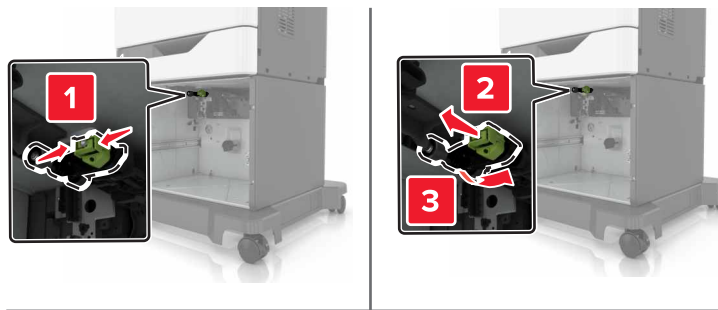

- 5 Unpack the new pick roller.

6 Insert the new pick roller until it *clicks* into place.

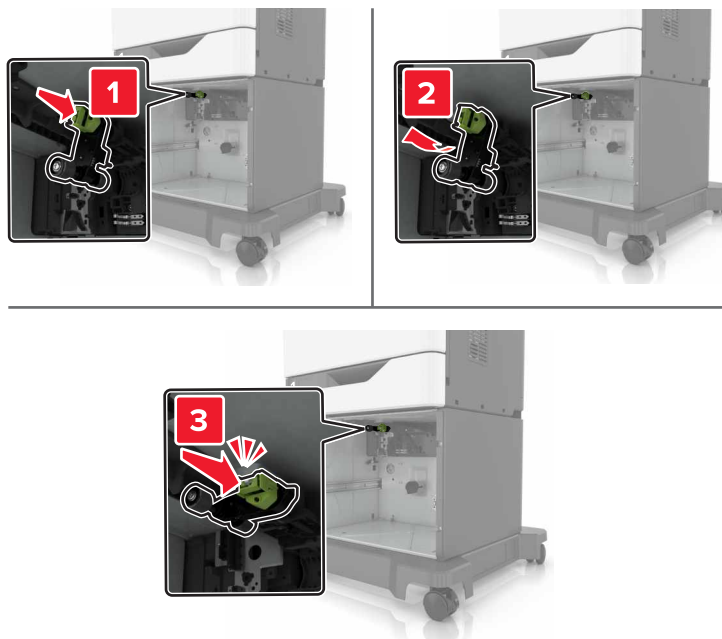

7 Insert the tray.

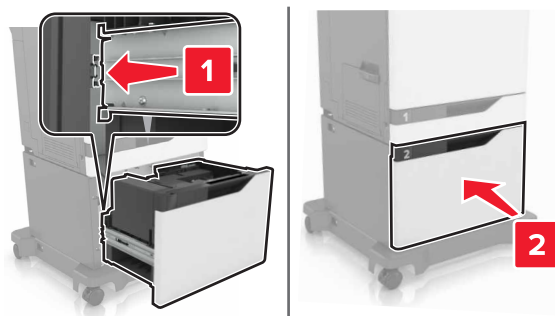

8 Turn on the printer.

Replacing the separator pad

- 1 Pull out the tray.

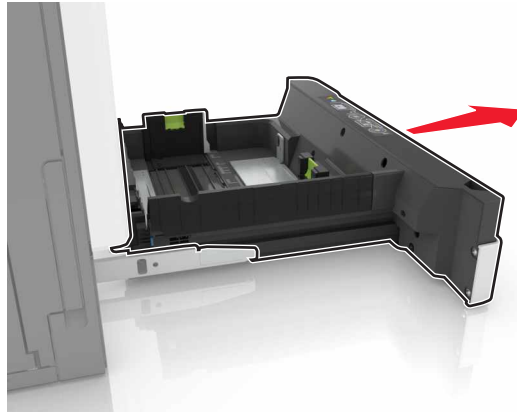

- 2 Remove the separator pad.

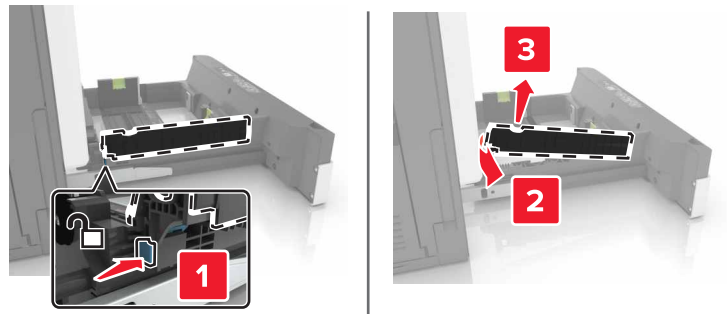

- 3 Unpack the new separator pad.

- 4 Insert the new separator pad until it *clicks* into place.

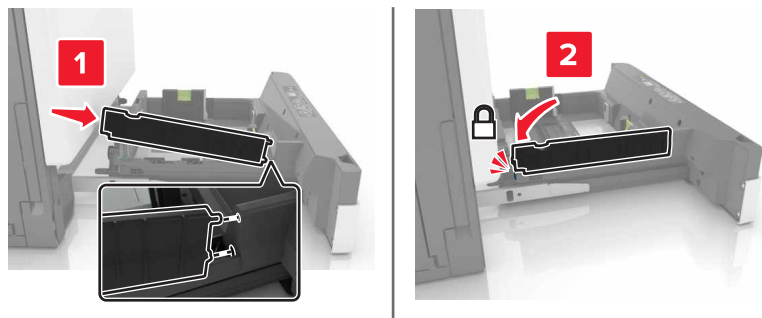

- 5 Insert the tray.

Replacing the waste toner bottle

1 Open door A.

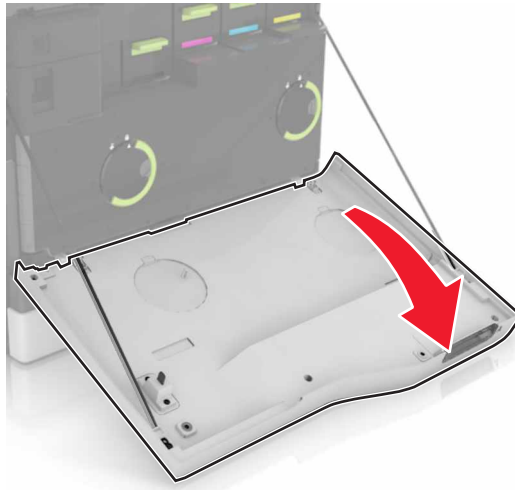

2 Remove the waste toner bottle.

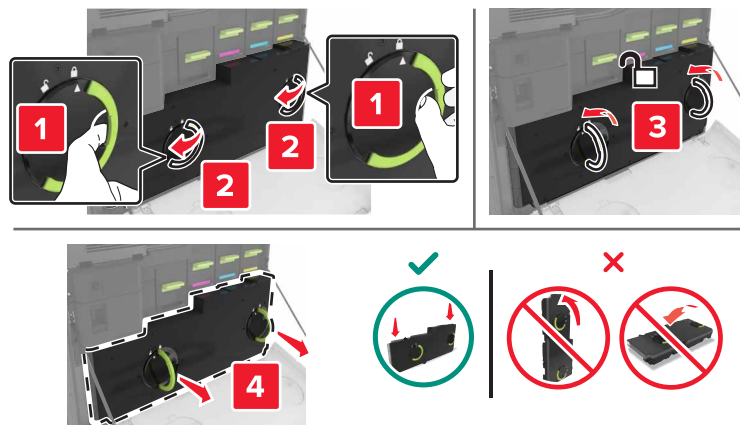

3 Unpack the new waste toner bottle.

4 Insert the new waste toner bottle.

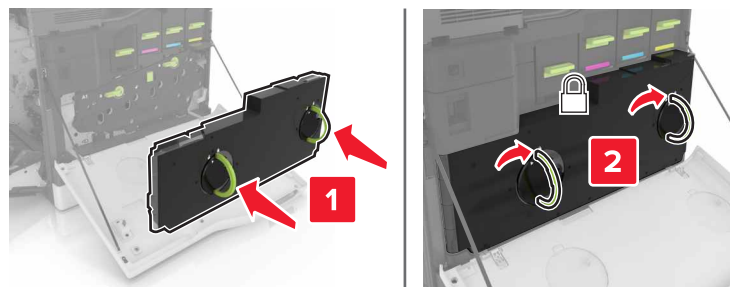

5 Close door A.

Replacing the transfer belt

- 1 Turn off the printer.
- 2 Open door A.

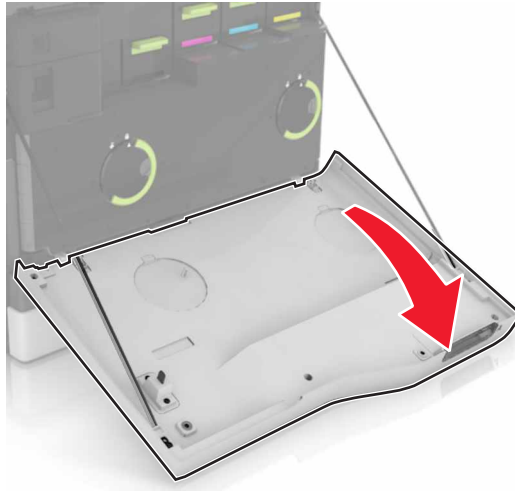

- 3 Remove the waste toner bottle.

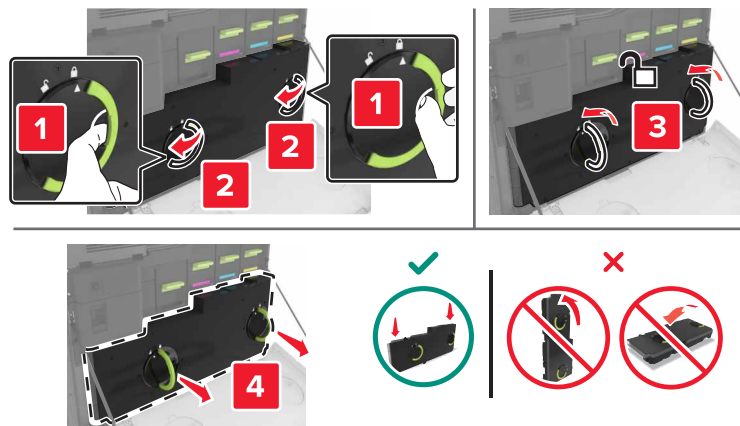

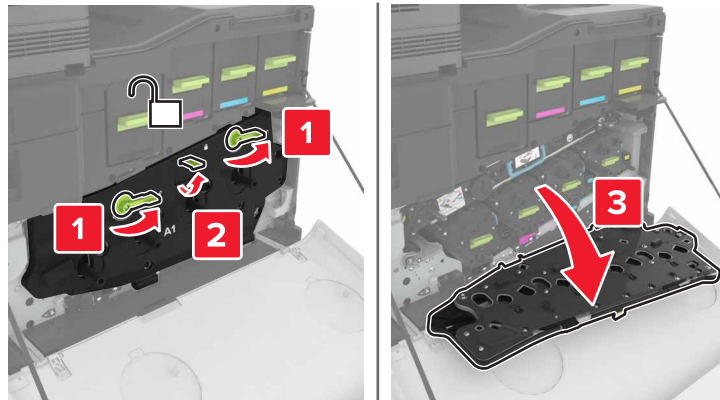
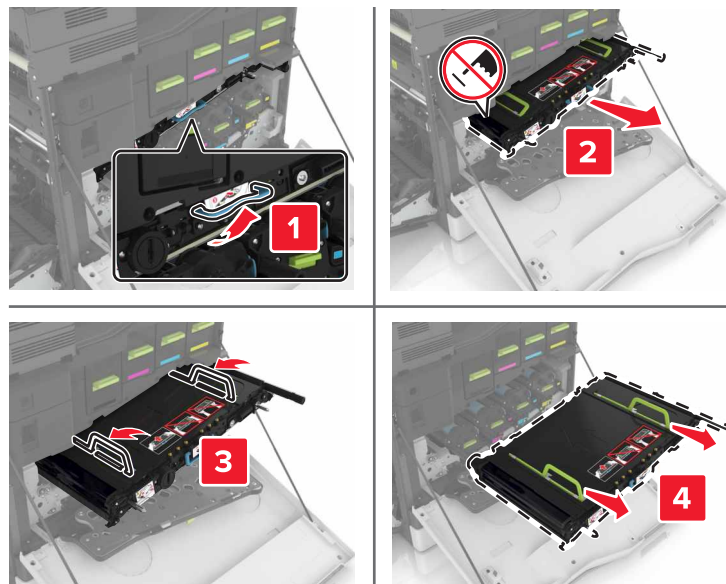
4 Open door A1.**5** Remove the transfer belt.**6** Unpack the new transfer belt, and then remove the packing material.

Warning—Potential Damage: Do not expose the transfer belt to direct light for more than 10 minutes. Extended exposure to light may cause print quality problems.

Warning—Potential Damage: Do not touch the transfer belt. Doing so may affect the print quality of future print jobs.



7 Insert the new transfer belt until it *clicks* into place.

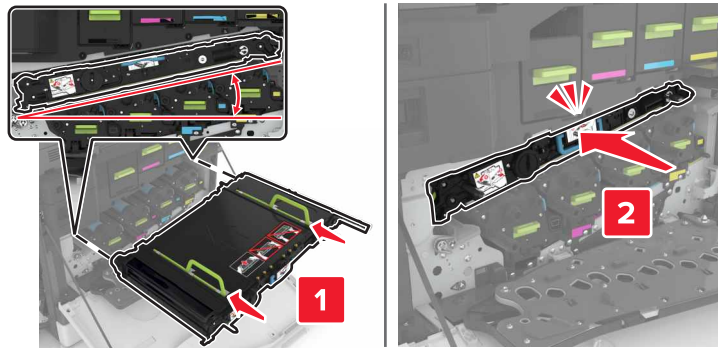

8 Close door A1.

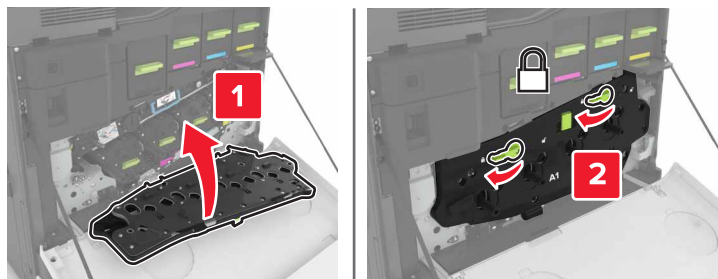

9 Insert the waste toner bottle.

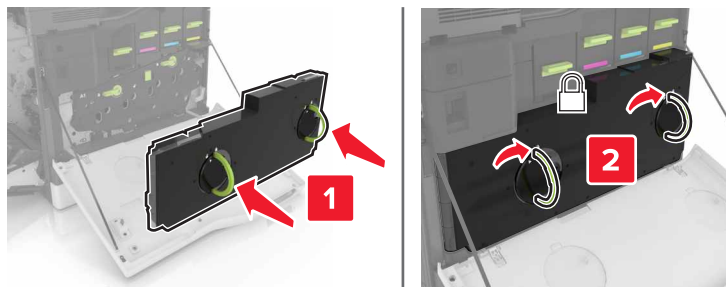

10 Close door A .

11 Turn on the printer.

Replacing the transfer roller

- 1 Open door B.

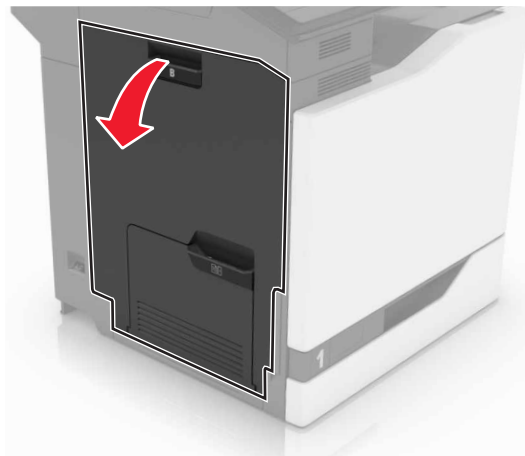

- 2 Remove the transfer roller.



- 3 Unpack the new transfer roller.

Note: Do not remove the white packing material.

4 Insert the new transfer roller.

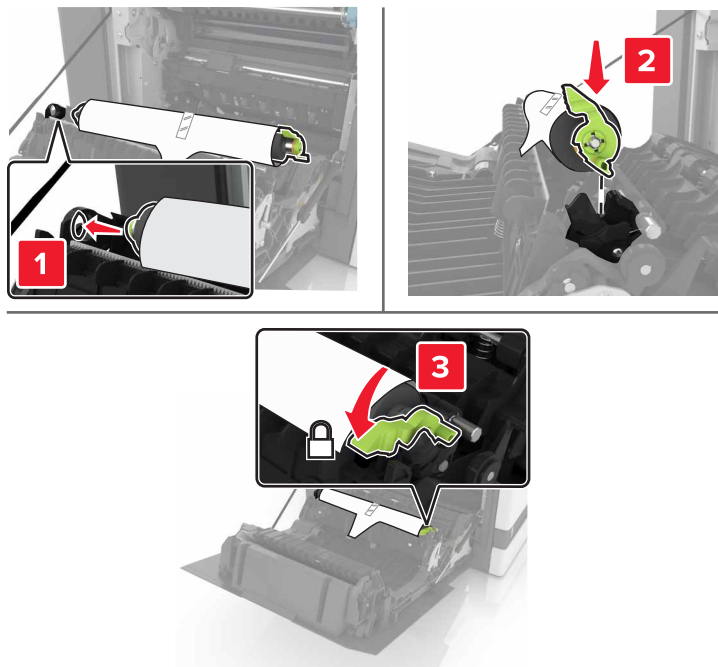

5 Remove the white packing material.



6 Close door B.

Replacing the ADF pick roller

- 1 Turn off the printer.
- 2 Open door D.

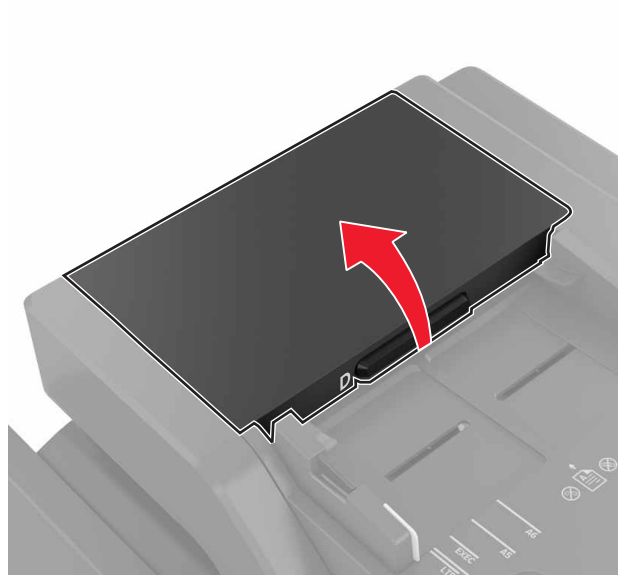

- 3 Remove the ADF pick roller cover.

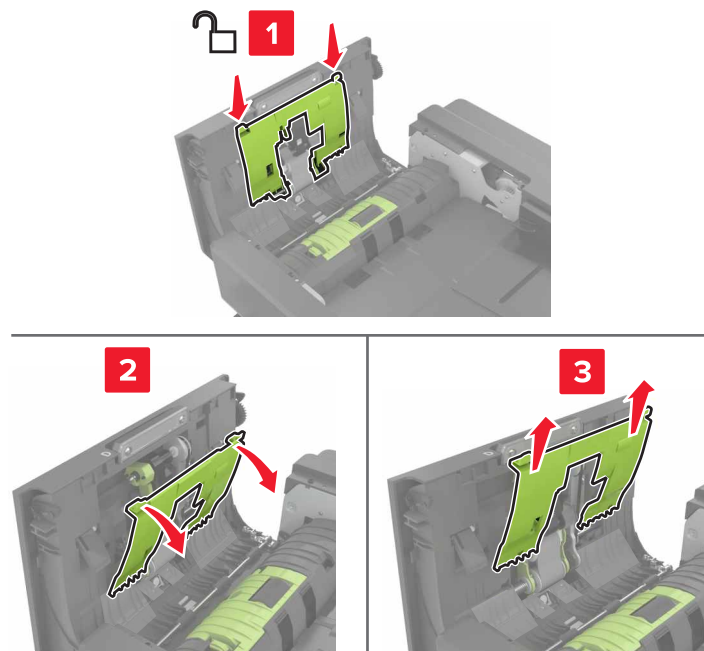

- 4 Remove the ADF pick roller.

Warning—Potential Damage: Some parts of the printer are easily damaged by static electricity. Before touching any parts or components in an area marked with the static-sensitive symbol, touch a metal surface in an area away from the symbol.

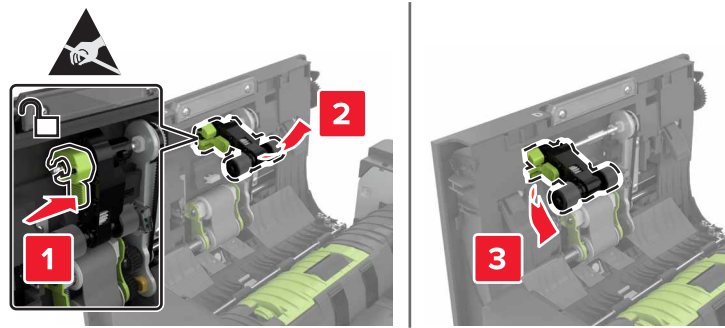

- 5 Unpack the new ADF pick roller.
- 6 Insert the new ADF pick roller until it *clicks* into place.

Warning—Potential Damage: Some parts of the printer are easily damaged by static electricity. Before touching any parts or components in an area marked with the static-sensitive symbol, touch a metal surface in an area away from the symbol.

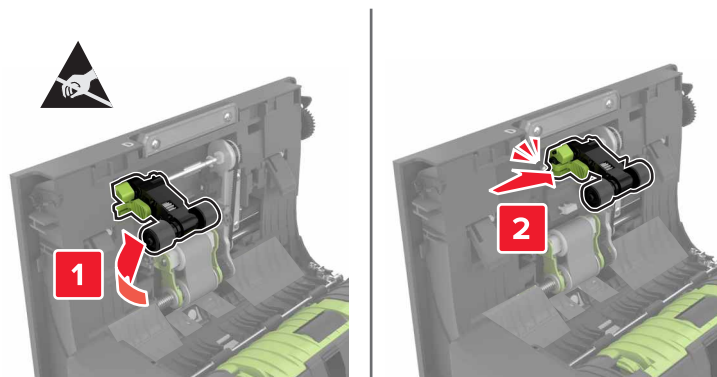

- 7 Insert the ADF pick roller cover until it *clicks* into place.

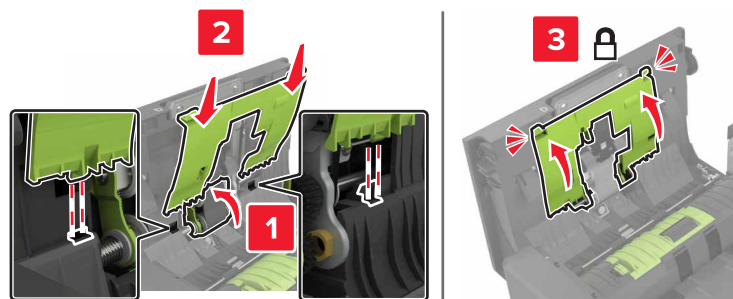

- 8 Close door D.
- 9 Turn on the printer.

Replacing the ADF feed roller

- 1 Turn off the printer.
- 2 Open door D.

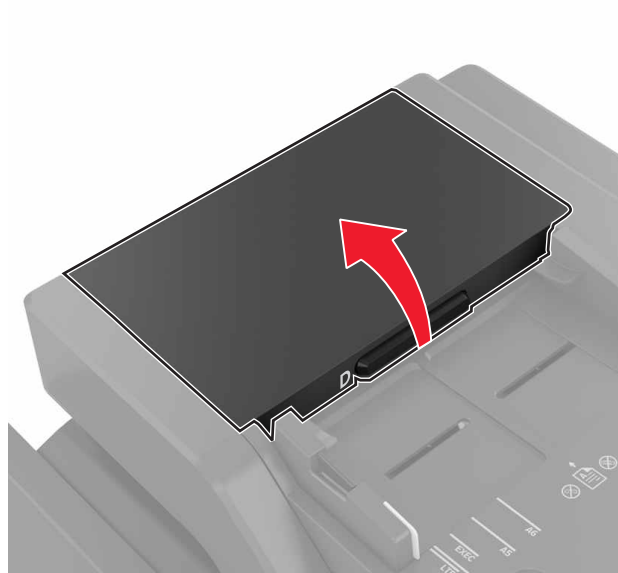

- 3 Remove the ADF pick roller cover.

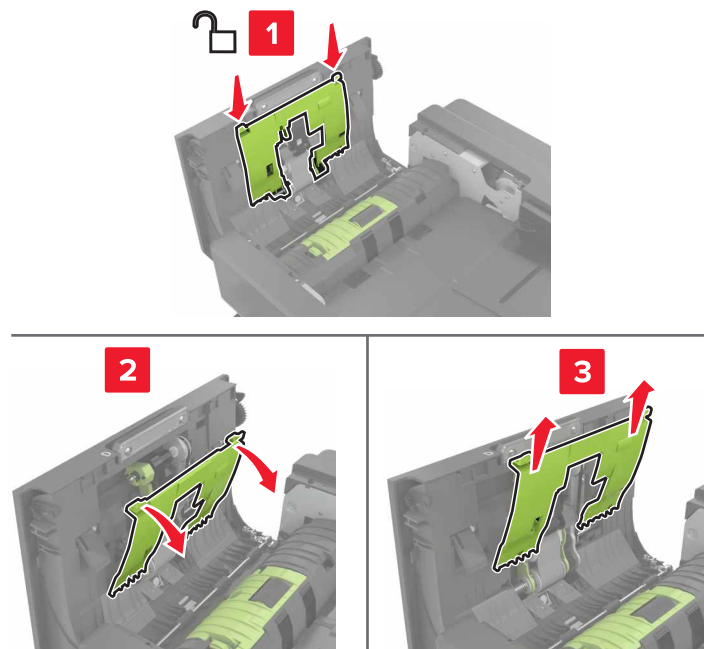

- 4 Remove the ADF feed roller.

Warning—Potential Damage: Some parts of the printer are easily damaged by static electricity. Before touching any parts or components in an area marked with the static-sensitive symbol, touch a metal surface in an area away from the symbol.

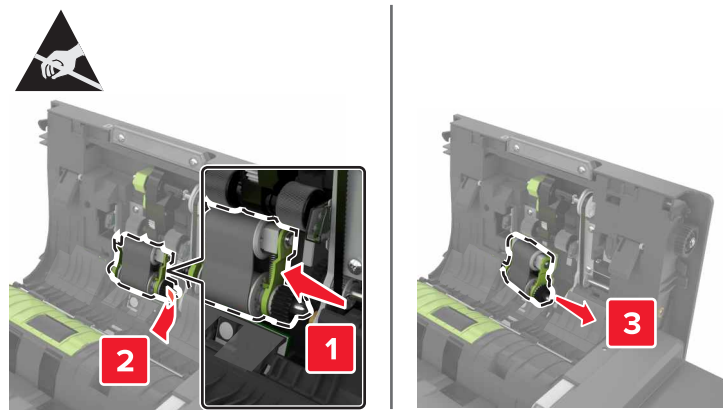

- 5 Unpack the new ADF feed roller.
- 6 Insert the new ADF feed roller until it *clicks* into place.

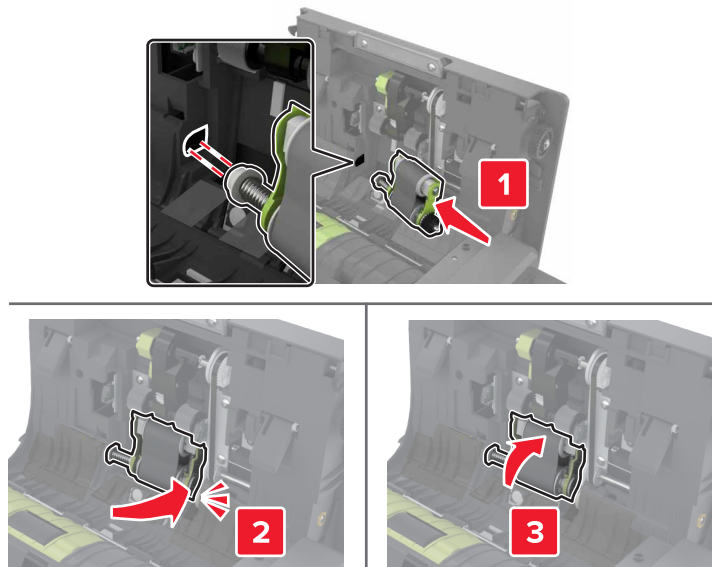

- 7 Insert the ADF pick roller cover until it *clicks* into place.

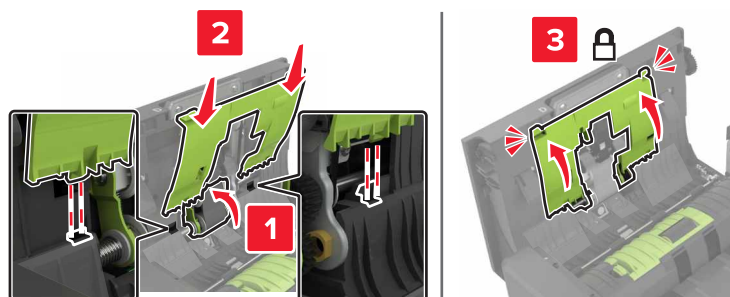

- 8 Close door D.
- 9 Turn on the printer.

Replacing the ADF separator roller

- 1 Turn off the printer.
- 2 Open door D.

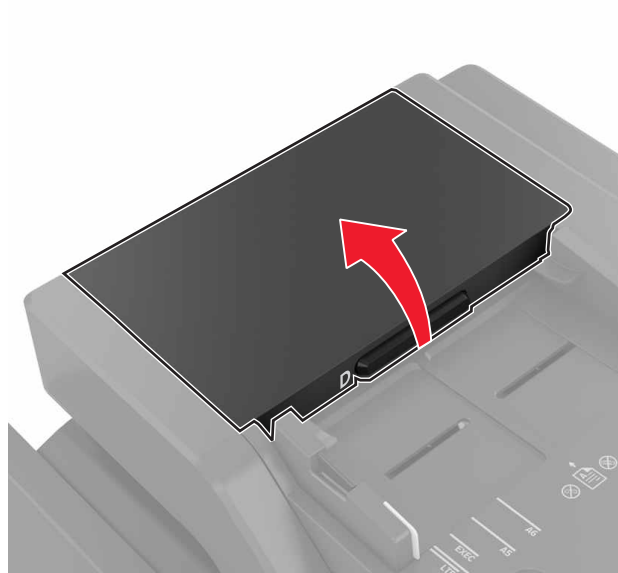

- 3 Remove the ADF separator roller cover.



- 4 Remove the ADF separator roller.

Warning—Potential Damage: Some parts of the printer are easily damaged by static electricity. Before touching any parts or components in an area marked with the static-sensitive symbol, touch a metal surface in an area away from the symbol.

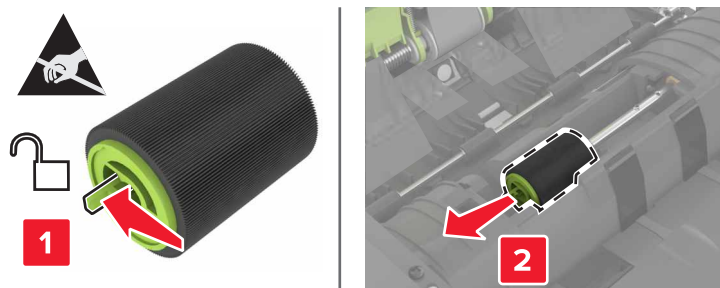

- 5 Unpack the new ADF separator roller.
- 6 Insert the new ADF separator roller until it *clicks* into place.

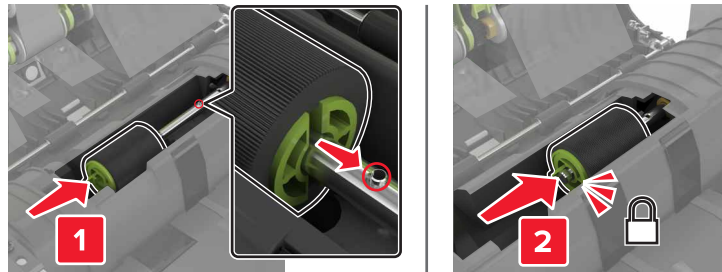

- 7 Insert the ADF separator roller cover until it *clicks* into place.

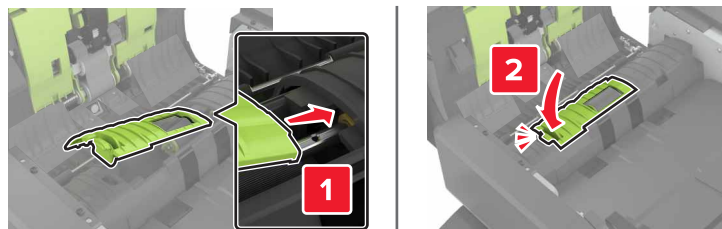

- 8 Close door D.
- 9 Turn on the printer.

Replacing the staple cartridge unit

Replacing the staple cartridge in the staple finisher

- 1 Open door C.

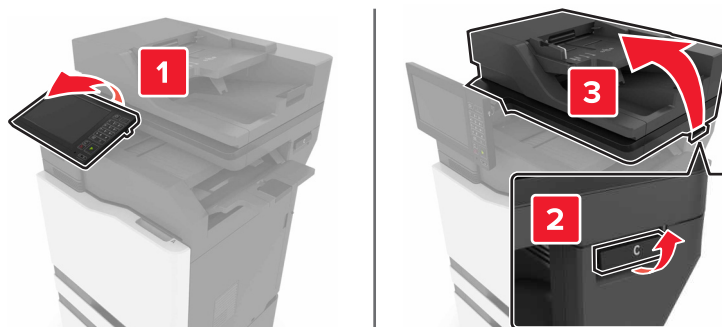

2 Open door G.

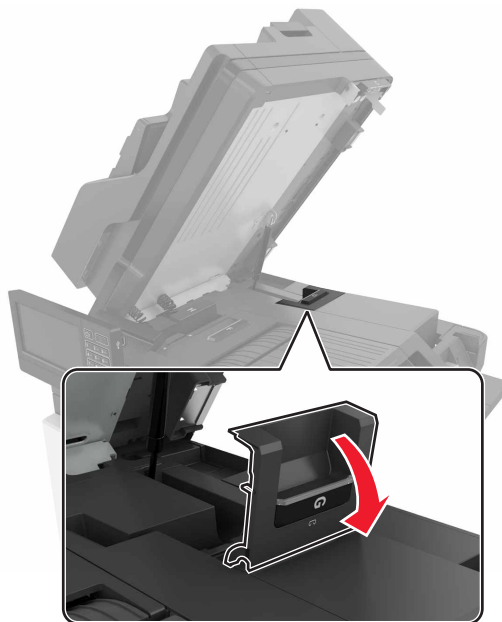

3 Remove the staple cartridge.

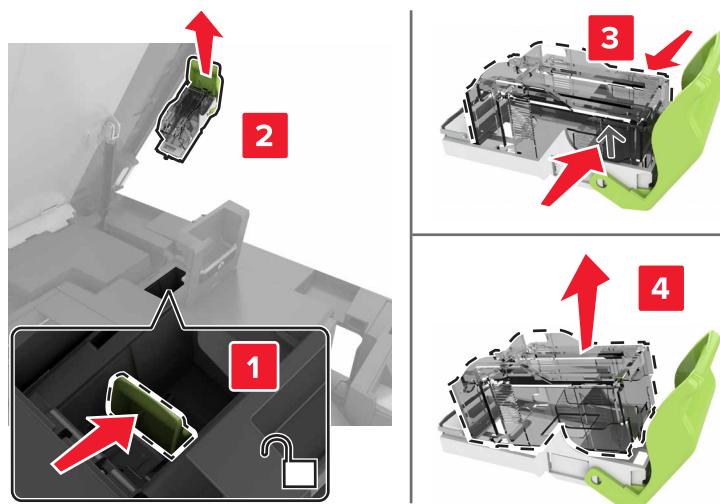

4 Unpack the new staple cartridge.

5 Insert the new staple cartridge until it *clicks* into place.

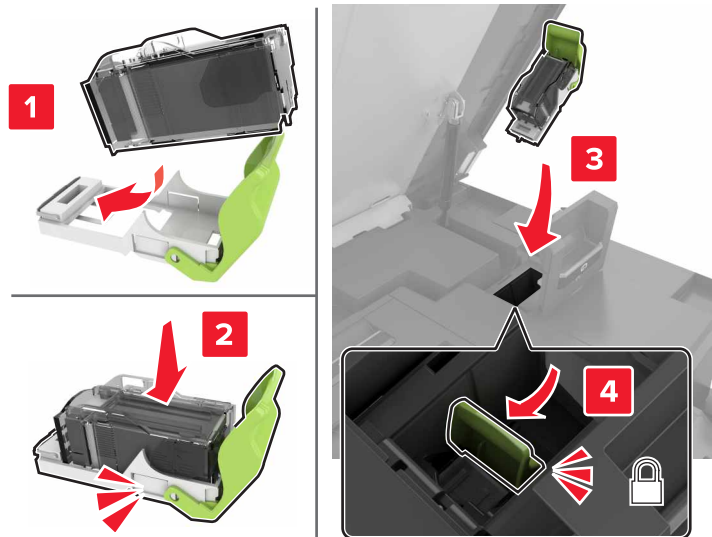

6 Close doors G and C.

CAUTION—PINCH HAZARD: To avoid the risk of a pinch injury, keep hands clear of the labeled area when closing door C.

Replacing the staple cartridge holder in the staple finisher

1 Open door C.

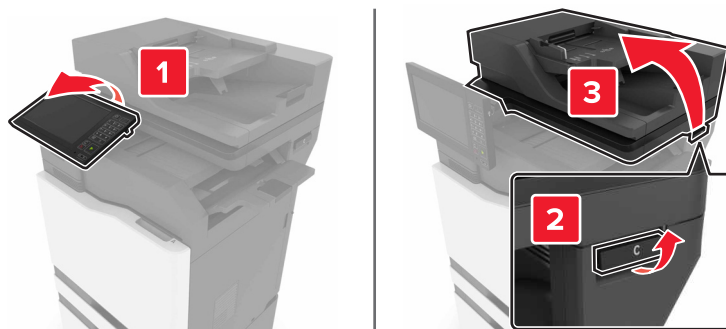

2 Open door G.

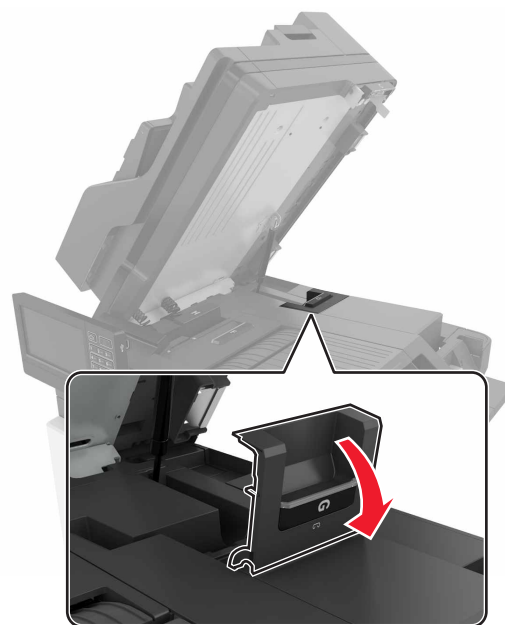

3 Pull out the staple cartridge holder.

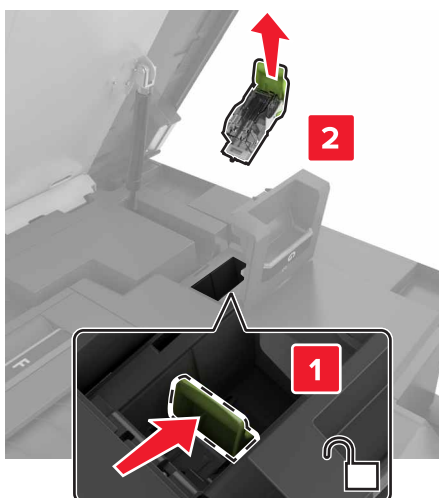

4 Remove the staple cartridge.

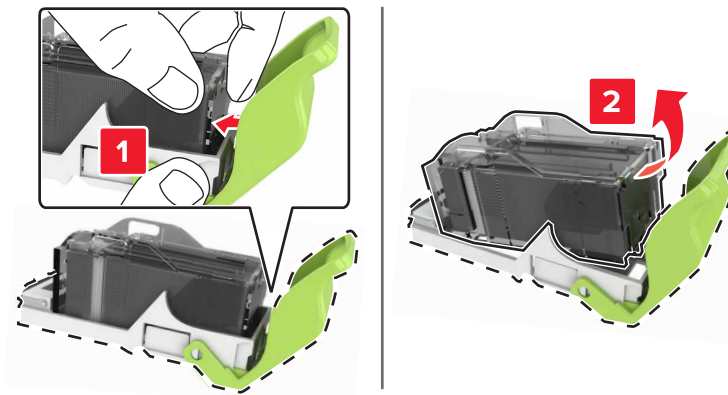

5 Unpack the new staple cartridge holder.

6 Insert the staple cartridge until it *clicks* into place.

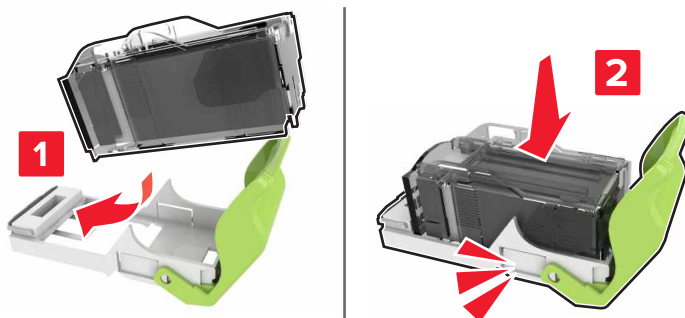

7 Insert the staple cartridge holder until it *clicks* into place.

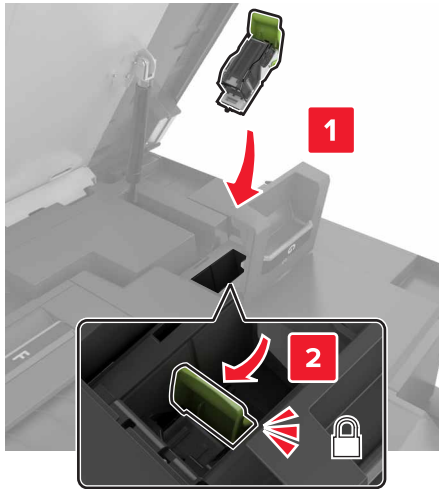

8 Close doors G and C.

 **CAUTION—PINCH HAZARD:** To avoid the risk of a pinch injury, keep hands clear of the labeled area when closing door C.

Storing supplies

Choose a cool, clean storage area for the printer supplies. Store supplies right side up in their original packing until you are ready to use them.

Do not expose supplies to:

- Direct sunlight
- Temperatures above 35°C (95°F)
- High humidity above 80%
- Salty air
- Corrosive gases
- Heavy dust

Moving the printer

Moving the printer to another location

 **CAUTION—POTENTIAL INJURY:** If the printer weight is greater than 20 kg (44 lb), then it may require two or more people to lift it safely.

 **CAUTION—POTENTIAL INJURY:** To avoid the risk of fire or electrical shock, use only the power cord provided with this product or the manufacturer's authorized replacement.

 **CAUTION—POTENTIAL INJURY:** When moving the printer, follow these guidelines to avoid personal injury or printer damage:

- Make sure that all doors and trays are closed.
- Turn off the printer, and then unplug the power cord from the electrical outlet.
- Disconnect all cords and cables from the printer.
- If the printer has separate floor-standing optional trays or output options attached to it, then disconnect them before moving the printer.
- If the printer has a caster base, then carefully roll it to the new location. Use caution when passing over thresholds and breaks in flooring.
- If the printer does not have a caster base but is configured with optional trays or output options, then remove the output options and lift the printer off the trays. Do not try to lift the printer and any options at the same time.
- Always use the handholds on the printer to lift it.
- Any cart used to move the printer must have a surface able to support the full footprint of the printer.
- Any cart used to move the hardware options must have a surface able to support the dimensions of the options.
- Keep the printer in an upright position.
- Avoid severe jarring movements.
- Make sure that your fingers are not under the printer when you set it down.
- Make sure that there is adequate clearance around the printer.

Note: Damage to the printer caused by improper moving is not covered by the printer warranty.

Shipping the printer

For shipping instructions, go to <http://support.lexmark.com> or contact customer support.

Saving energy and paper

Configuring the power save mode settings

Sleep mode

- 1 From the home screen, touch **Settings > Device > Power Management > Timeouts > Sleep Mode**.
- 2 Specify the amount of time that the printer stays idle before it enters Sleep Mode.

Hibernate mode

- 1 From the home screen, touch **Settings > Device > Power Management > Timeouts > Hibernate Timeout**.
- 2 Select the amount of time that the printer stays idle before it enters Hibernate mode.

Notes:

- For Hibernate Timeout to work, set Hibernate Timeout on Connection to Hibernate.
- The Embedded Web Server is disabled when the printer is in Hibernate mode.

Adjusting the brightness of the printer display

- 1 From the home screen, touch **Settings > Device > Preferences > Screen Brightness**.
- 2 Adjust the setting.

Conserving supplies

- Print on both sides of the paper.
 - Note:** Two-sided printing is the default setting in the print driver.
- Print multiple pages on a single sheet of paper.
- Use the preview feature to see how the document looks like before printing it.
- Print one copy of the document to check its content and format for accuracy.

Recycling

Recycling Lexmark products

To return Lexmark products for recycling:

- 1 Go to www.lexmark.com/recycle.
- 2 Select the product you want to recycle.

Note: Printer supplies and hardware not listed in the Lexmark Collection and Recycling Program may be recycled through your local recycling center.

Recycling Lexmark packaging

Lexmark continually strives to minimize packaging. Less packaging helps to ensure that Lexmark printers are transported in the most efficient and environmentally sensitive manner and that there is less packaging to dispose of. These efficiencies result in fewer greenhouse emissions, energy savings, and natural resource savings. Lexmark also offers recycling of packaging components in some countries or regions. For more information, go to www.lexmark.com/recycle, and then choose your country or region. Information on available packaging recycling programs is included with the information on product recycling.

Lexmark cartons are 100% recyclable where corrugated recycling facilities exist. Facilities may not exist in your area.

The foam used in Lexmark packaging is recyclable where foam recycling facilities exist. Facilities may not exist in your area.

When you return a cartridge to Lexmark, you can reuse the box that the cartridge came in. Lexmark recycles the box.

Clearing jams

Avoiding jams

Load paper properly

- Make sure that the paper lies flat in the tray.

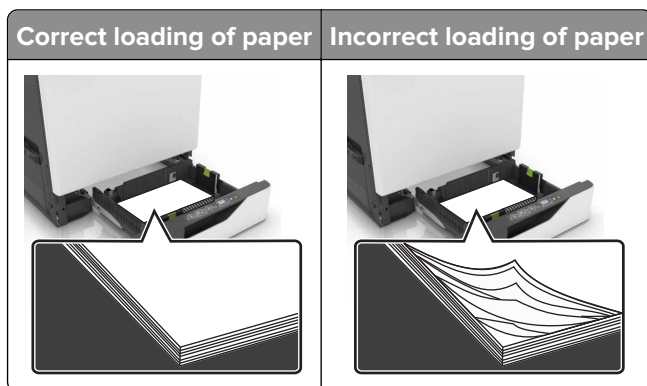

- Do not load or remove a tray while the printer is printing.
- Do not load too much paper. Make sure that the stack height is below the maximum paper fill indicator.
- Do not slide paper into the tray. Load paper as shown in the illustration.

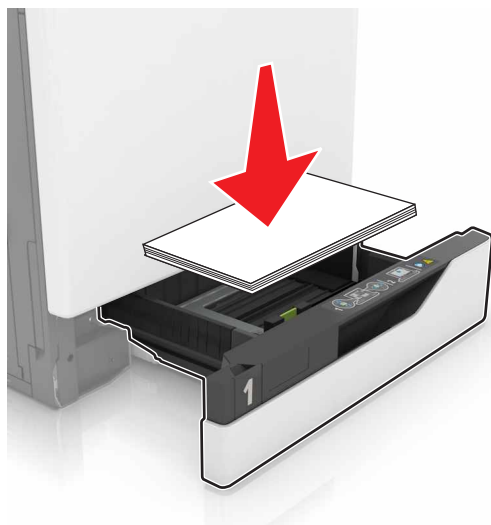

- Make sure that the paper guides are positioned correctly and are not pressing tightly against the paper or envelopes.
- Push the tray firmly into the printer after loading paper.

Use recommended paper

- Use only recommended paper or specialty media.
- Do not load paper that is wrinkled, creased, damp, bent, or curled.

- Flex, fan, and align the paper edges before loading.

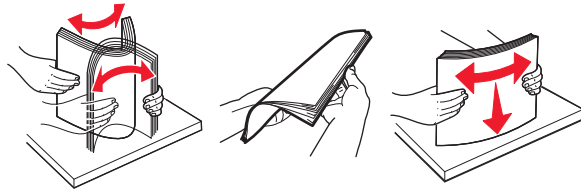

- Do not use paper that has been cut or trimmed by hand.
- Do not mix paper sizes, weights, or types in the same tray.
- Make sure that the paper size and type are set correctly on the computer or printer control panel.
- Store paper according to manufacturer recommendations.

Identifying jam locations

Notes:

- When Jam Assist is set to On, the printer flushes blank pages or pages with partial prints after a jammed page has been cleared. Check your printed output for blank pages.
- When Jam Recovery is set to On or Auto, the printer reprints jammed pages.

Printer jam locations

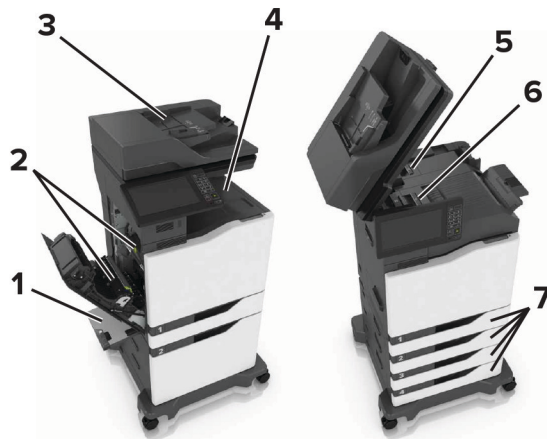

1	Multipurpose feeder
2	Door B
3	Automatic document feeder (ADF)
4	Standard bin
5	Door G
6	Finisher bin
7	Trays

Paper jam in trays

- 1 Pull out the tray.



- 2 Remove the jammed paper.

Note: Make sure that all paper fragments are removed.



- 3 Insert the tray.

- 4 Open the tray cover.



- 5 Remove the jammed paper.

Note: Make sure that all paper fragments are removed.

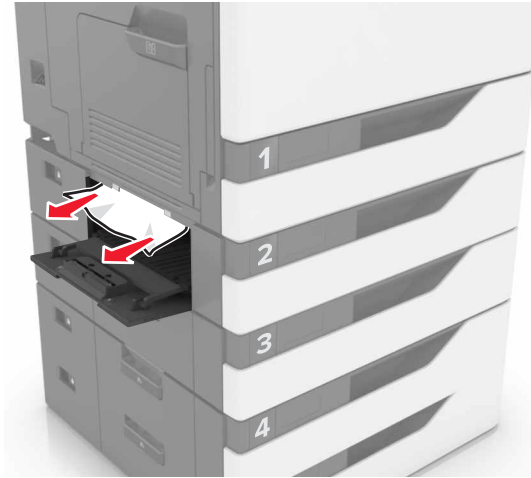

- 6 Close the tray cover.

Paper jam in the multipurpose feeder

- 1 Remove paper from the multipurpose feeder.
- 2 Remove the jammed paper.

Note: Make sure that all paper fragments are removed.

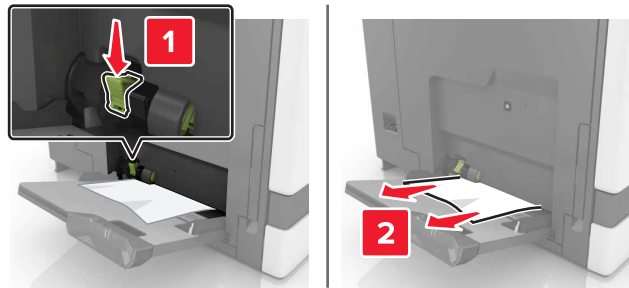

- 3 Open door B, and then remove any paper fragments.



CAUTION—HOT SURFACE: The inside of the printer might be hot. To reduce the risk of injury from a hot component, allow the surface to cool before touching it.

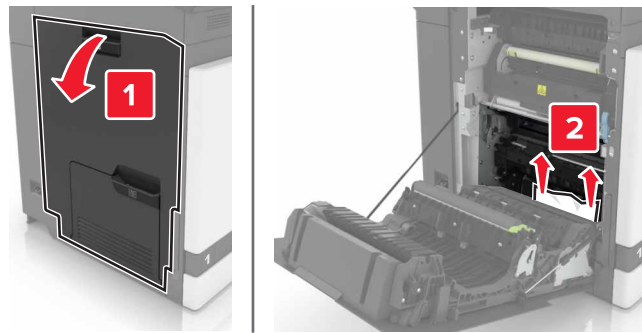

4 Close door B.

5 Flex, fan, and align the paper edges before loading.

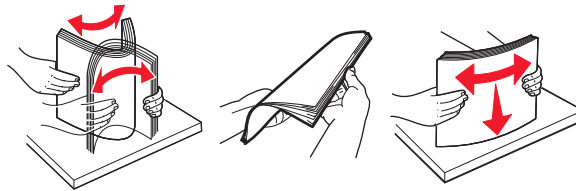

6 Reload paper.

Paper jam in the automatic document feeder

1 Remove all original documents from the ADF tray.

2 Open door D.

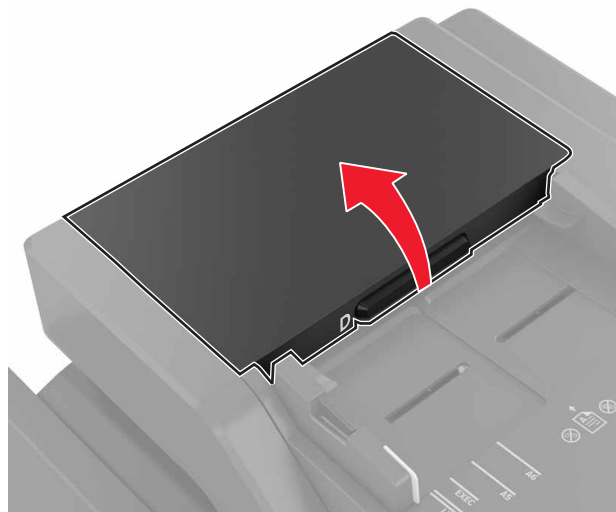

3 Remove the jammed paper.

Note: Make sure that all paper fragments are removed.

Warning—Potential Damage: Some parts of the printer are easily damaged by static electricity. Before touching any parts or components in an area marked with the static-sensitive symbol, touch a metal surface in an area away from the symbol.

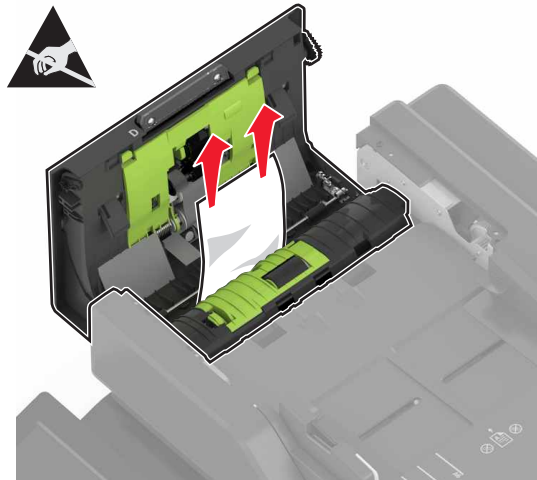

4 Close door D.

5 Open the scanner cover.



6 Open door E.

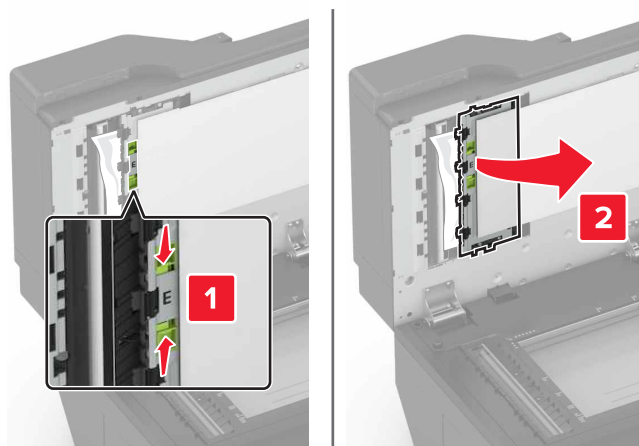

- 7 Remove the jammed paper.

Note: Make sure that all paper fragments are removed.

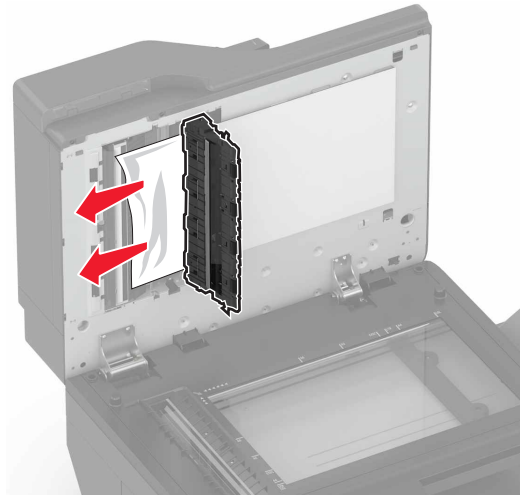

- 8 Close door E and the scanner cover.

Paper jam in the standard bin

- 1 Remove the jammed paper.

Note: Make sure that all paper fragments are removed.



- 2 Open door B, and then remove any paper fragments.

 **CAUTION—HOT SURFACE:** The inside of the printer might be hot. To reduce the risk of injury from a hot component, allow the surface to cool before touching it.

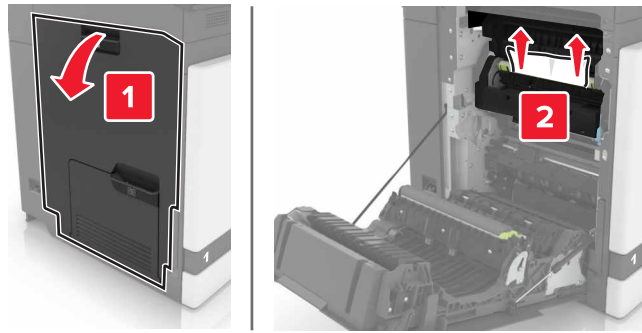

3 Close door B.

Paper jam in door B

Paper jam in the fuser

1 Open door B.

 **CAUTION—HOT SURFACE:** The inside of the printer might be hot. To reduce the risk of injury from a hot component, allow the surface to cool before touching it.

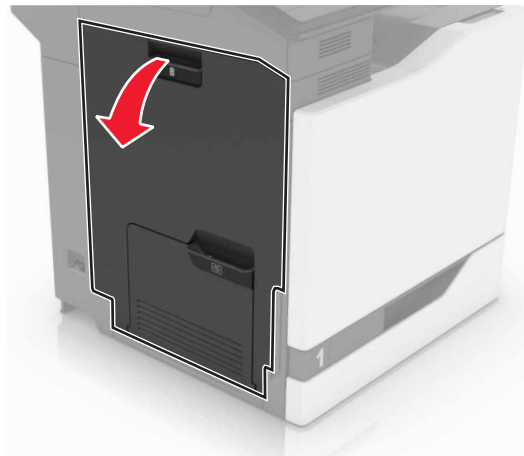

2 Remove the jammed paper.

Note: Make sure that all paper fragments are removed.

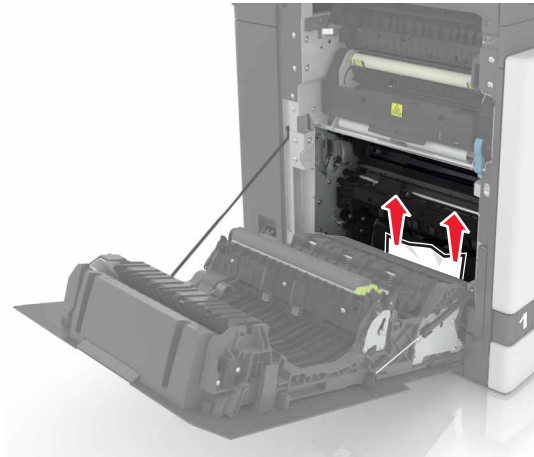

3 Open the fuser access door.



4 Remove the jammed paper.

Note: Make sure that all paper fragments are removed.

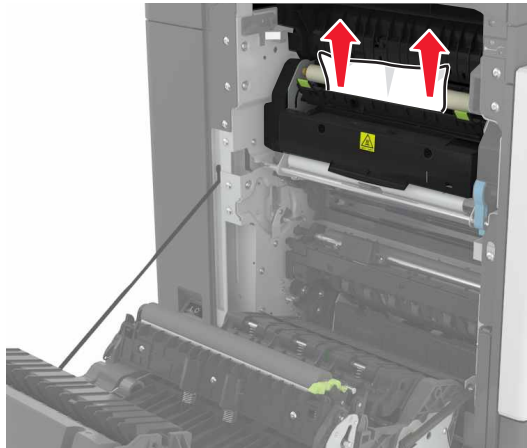

5 Close door B.

Paper jam in the duplex unit

1 Open door B.

 **CAUTION—HOT SURFACE:** The inside of the printer might be hot. To reduce the risk of injury from a hot component, allow the surface to cool before touching it.

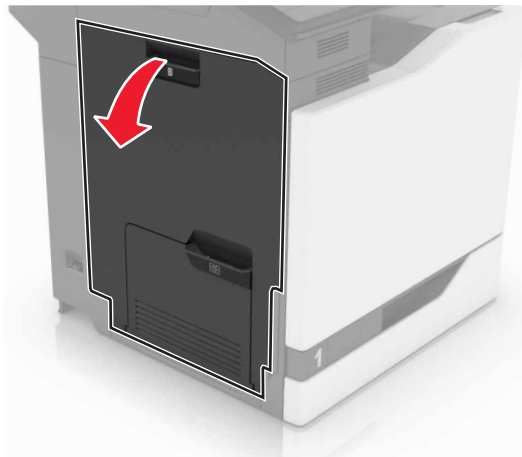

2 Remove the jammed paper.

Note: Make sure that all paper fragments are removed.

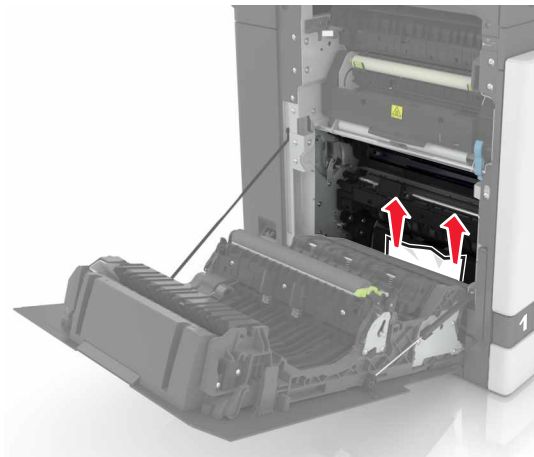

3 Open the duplex cover.



4 Remove the jammed paper.

Note: Make sure that all paper fragments are removed.

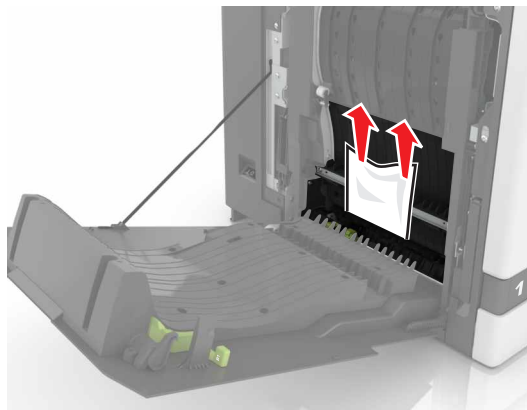

5 Close the duplex cover and door B.

Paper jam in the finisher bin

1 Remove the jammed paper.

Note: Make sure that all paper fragments are removed.

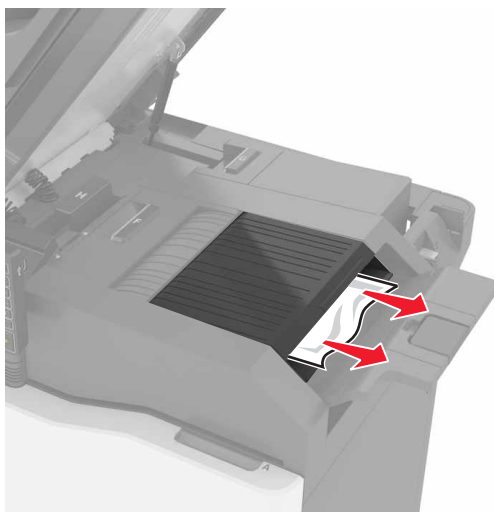

2 Open door C.

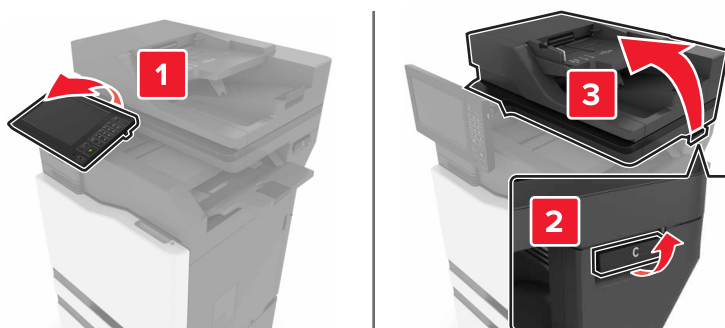

3 Open door F.

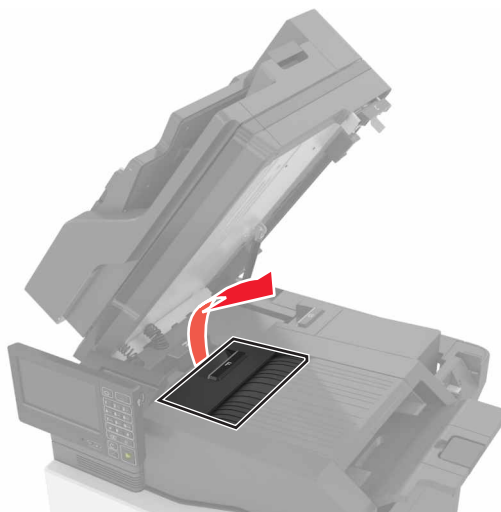

4 Remove the jammed paper.

Note: Make sure that all paper fragments are removed.

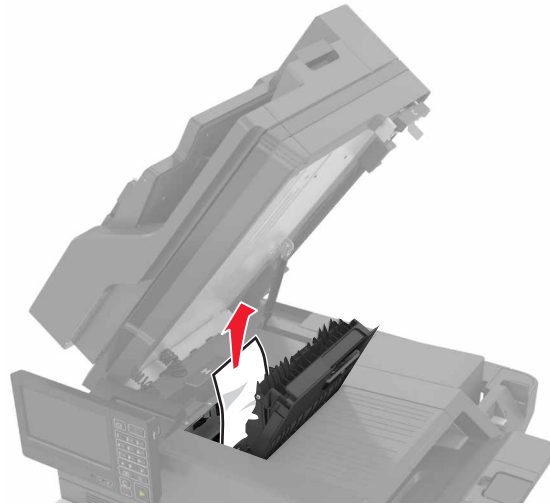

5 Close doors F and C.

 **CAUTION—PINCH HAZARD:** To avoid the risk of a pinch injury, keep hands clear of the labeled area when closing door C.

Staple jam in door G

1 Open door C.

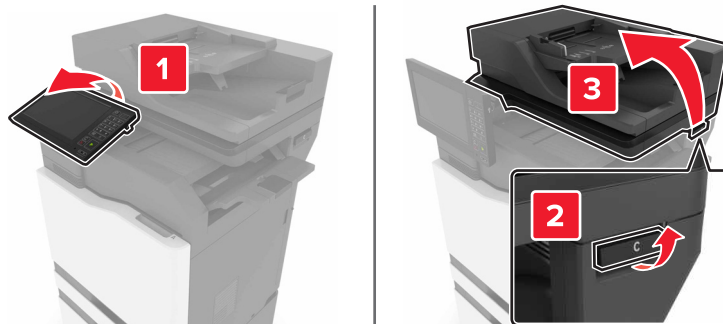

2 Open door G.

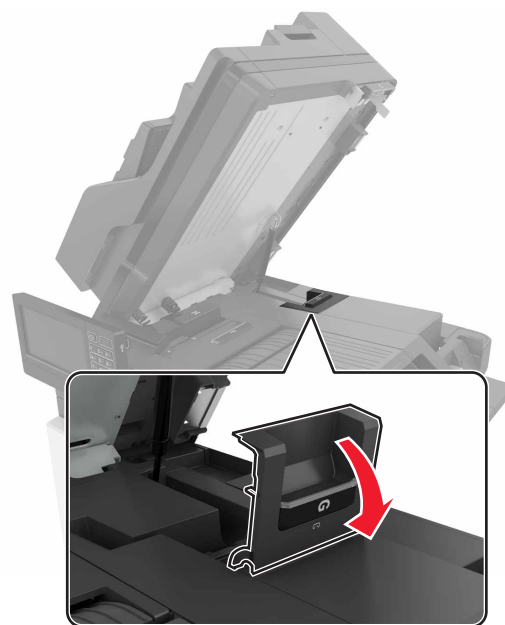

3 Pull out the staple cartridge holder.

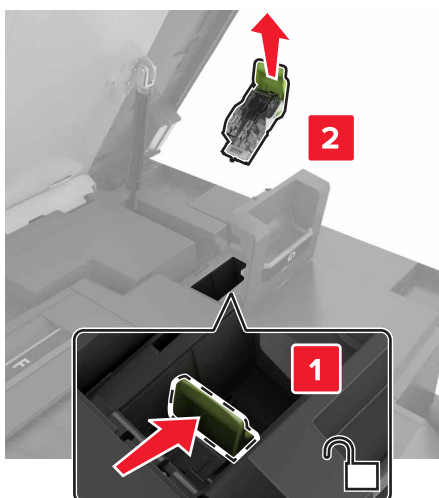

4 Lift the staple guard, and then remove the loose staples.

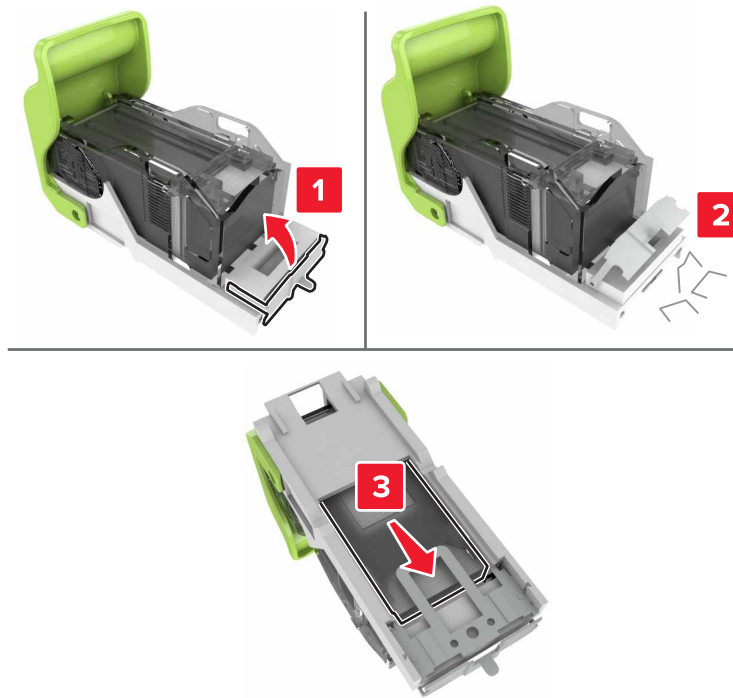

Note: Do not insert the staples that came out of the cartridge.

5 Close the staple guard.



6 Insert the staple cartridge holder.

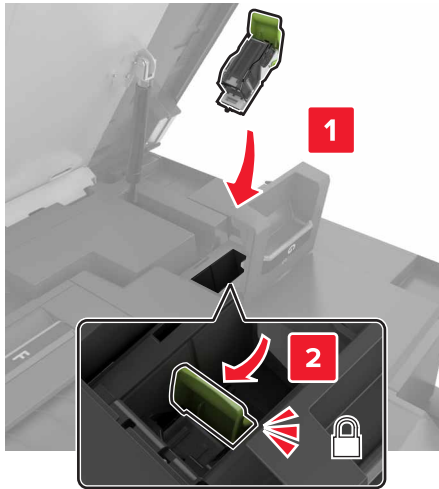

7 Close doors G and C.

 **CAUTION—PINCH HAZARD:** To avoid the risk of a pinch injury, keep hands clear of the labeled area when closing door C.

Troubleshooting

Network connection problems

Cannot open Embedded Web Server

Action	Yes	No
<p>Step 1 Check if the printer is on.</p> <p>Is the printer on?</p>	Go to step 2.	Turn on the printer.
<p>Step 2 Make sure that the printer IP address is correct.</p> <p>Notes:</p> <ul style="list-style-type: none"> • View the IP address on the home screen. • An IP address appears as four sets of numbers separated by periods, such as 123.123.123.123. <p>Is the printer IP address correct?</p>	Go to step 3.	Type the correct printer IP address in the address field.
<p>Step 3 Check if you are using a supported browser:</p> <ul style="list-style-type: none"> • Internet Explorer version 11 or later • Microsoft Edge • Safari version 6 or later • Google Chrome™ version 32 or later • Mozilla Firefox version 24 or later <p>Is your browser supported?</p>	Go to step 4.	Install a supported browser.
<p>Step 4 Check if the network connection is working.</p> <p>Is the network connection working?</p>	Go to step 5.	Contact your administrator.
<p>Step 5 Make sure that the cable connections to the printer and print server are secure. For more information, see the documentation that came with the printer.</p> <p>Are the cable connections secure?</p>	Go to step 6.	Secure the cable connections.
<p>Step 6 Check if the web proxy servers are disabled.</p> <p>Are the web proxy servers disabled?</p>	Go to step 7.	Contact your administrator.

Action	Yes	No
<p>Step 7 Access the Embedded Web Server.</p> <p>Did the Embedded Web Server open?</p>	The problem is solved.	Contact customer support .

Unable to read flash drive

Action	Yes	No
<p>Step 1 Check if the printer is not busy processing another print, copy, scan, or fax job.</p> <p>Is the printer ready?</p>	Go to step 2.	Wait for the printer to finish processing the other job.
<p>Step 2 Check if the flash drive is supported. For more information, see “Supported flash drives and file types” on page 41.</p> <p>Is the flash drive supported?</p>	Go to step 3.	Insert a supported flash drive.
<p>Step 3 Remove, and then insert the flash drive.</p> <p>Does the printer recognize the flash drive?</p>	The problem is solved.	Contact customer support .

Enabling the USB port

From the home screen, touch **Settings > Network/Ports > USB > Enable USB Port**.

Checking the printer connectivity

- 1 From the home screen, touch **Settings > Reports > Network > Network Setup Page**.
- 2 Check the first section of the network setup page, and confirm that the status is connected.
If the status is not connected, then the LAN drop may be inactive, or the network cable may be unplugged or malfunctioning. Contact your administrator for assistance.

Hardware options problems

Cannot detect internal option

Action	Yes	No
<p>Step 1 Turn off the printer, wait for about 10 seconds, and then turn on the printer.</p> <p>Does the internal option operate correctly?</p>	The problem is solved.	Go to step 2.
<p>Step 2 Print the Menu Settings Page, and then check if the internal option appears in the Installed Features list.</p> <p>Is the internal option listed in the menu settings page?</p>	Go to step 4.	Go to step 3.
<p>Step 3 Check if the internal option is installed properly into the controller board.</p> <ul style="list-style-type: none"> a Turn off the printer, and then unplug the power cord from the electrical outlet. b Make sure that the internal option is installed in the appropriate connector in the controller board. c Connect the power cord to the electrical outlet, and then turn on the printer. <p> CAUTION—POTENTIAL INJURY: To avoid the risk of fire or electrical shock, connect the power cord to an appropriately rated and properly grounded electrical outlet that is near the product and easily accessible.</p> <p>Does the internal option operate correctly?</p>	The problem is solved.	Go to step 4.
<p>Step 4</p> <ul style="list-style-type: none"> a Check if the internal option is available in the print driver. Note: If necessary, manually add the internal option in the print driver to make it available for print jobs. For more information, see “Adding available options in the print driver” on page 278. b Resend the print job. <p>Does the internal option operate correctly?</p>	The problem is solved.	Contact customer support .

Internal solutions port does not operate correctly

Action	Yes	No
<p>Step 1 Print a menu settings page, and then check if the internal solutions port (ISP) appears in the Installed Features list.</p> <p>Is the ISP listed in the Installed Features list?</p>	Go to step 3.	Go to step 2.
<p>Step 2 Remove, and then install the ISP. For more information, see “Installing an internal solutions port” on page 263.</p> <p>Note: Use a supported ISP.</p> <p>Does the ISP operate correctly?</p>	The problem is solved.	Go to step 3.
<p>Step 3 Check the cable and the ISP connection.</p> <ul style="list-style-type: none"> a Use the correct cable, and then make sure that it is securely connected to the ISP. b Check if the ISP solution interface cable is securely connected into the receptacle of the controller board. <p>Does the ISP operate correctly?</p>	The problem is solved.	Contact customer support .

Parallel or serial interface card does not operate correctly

Action	Yes	No
<p>Step 1 Print a menu settings page, and then check if the parallel or serial interface card appears in the Installed Features list.</p> <p>Is the parallel or serial interface card listed in the Installed Features list?</p>	Go to step 3.	Go to step 2.
<p>Step 2 Remove, and then install the parallel or serial interface card. For more information, see “Installing an internal solutions port” on page 263.</p> <p>Does the parallel or serial interface card operate correctly?</p>	The problem is solved.	Go to step 3.
<p>Step 3 Check the connection between the cable and the parallel or serial interface card.</p> <p>Does the parallel or serial interface card operate correctly?</p>	The problem is solved.	Contact customer support .

Defective flash detected

Try one or more of the following:

- Replace the defective flash memory.
- From the printer control panel, select **Continue** to ignore the message and continue printing.
- Cancel the current print job.

Not enough free space in flash memory for resources

Try one or more of the following:

- From the printer control panel, select **Continue** to clear the message and continue printing.
- Delete fonts, macros, and other data stored in the flash memory.
- Install flash memory with larger capacity.

Note: Downloaded fonts and macros that are not previously stored in the flash memory are deleted.

Unformatted flash detected

Try one or more of the following:

- From the control panel, select **Continue** to stop the defragmentation and continue printing.
- Format the flash memory.

Note: If the error message remains, then the flash memory may be defective and needs to be replaced.

Issues with supplies

Replace cartridge, printer region mismatch

To correct this problem, purchase a cartridge with the correct region that matches the printer region, or purchase a worldwide cartridge.

- The first number in the message after 42 indicates the region of the printer.
- The second number in the message after 42 indicates the region of the cartridge.

Printer and toner cartridge regions

Region	Numeric code
Worldwide or Undefined region	0
North America (United States, Canada)	1
European Economic Area, Western Europe, Nordic countries, Switzerland	2
Asia Pacific	3
Latin America	4
Rest of Europe, Middle East, Africa	5
Australia, New Zealand	6

Region	Numeric code
Invalid region	9

Note: To find the region settings of the printer and toner cartridge, print the print quality test pages. From the control panel, navigate to: **Settings > Troubleshooting > Print Quality Test Pages.**

Non-Lexmark supply

The printer has detected a non-Lexmark supply or part installed in the printer.

Your Lexmark printer is designed to function best with genuine Lexmark supplies and parts. Use of third-party supplies or parts may affect the performance, reliability, or life of the printer and its imaging components.

All life indicators are designed to function with Lexmark supplies and parts and may deliver unpredictable results if third-party supplies or parts are used. Imaging component usage beyond the intended life may damage your Lexmark printer or associated components.

Warning—Potential Damage: Use of third-party supplies or parts can affect warranty coverage. Damage caused by the use of third-party supplies or parts may not be covered by the warranty.

To accept any and all of these risks and to proceed with the use of non-genuine supplies or parts in your printer, from the control panel, press and hold **X** and **#** simultaneously for 15 seconds.

If you do not want to accept these risks, then remove the third-party supply or part from your printer and install a genuine Lexmark supply or part. For more information, see [“Using genuine Lexmark parts and supplies” on page 164.](#)

If the printer does not print after pressing and holding **X** and **#** simultaneously for 15 seconds, then reset the supply usage counter.

- 1 From the control panel, navigate to:
Settings > Device > Maintenance > Configuration Menu > Supply Usage And Counters
- 2 Select the part or supply that you want to reset, and then select **Start**.
- 3 Read the warning message, and then select **Continue**.
- 4 Press and hold **X** and **#** simultaneously for 15 seconds to clear the message.

Note: If you are unable to reset the supply usage counters, then return the item to the place of purchase.

Scanner maintenance required, use ADF Kit

The printer is scheduled for maintenance. For more information, go to <http://support.lexmark.com> or contact your service representative, and then report the message.

Paper feed problems

Envelope seals when printing

Action	Yes	No
<p>Step 1</p> <p>a Use an envelope that has been stored in a dry environment. Note: Printing on envelopes with high moisture content can seal the flaps.</p> <p>b Send the print job.</p> <p>Does the envelope seal when printing?</p>	Go to step 2.	The problem is solved.
<p>Step 2</p> <p>a Make sure that paper type is set to Envelope. From the control panel, navigate to: Settings > Paper > Tray Configuration > Paper Size/Type</p> <p>b Send the print job.</p> <p>Does the envelope seal when printing?</p>	Contact customer support .	The problem is solved.

Collated printing does not work

Action	Yes	No
<p>Step 1</p> <p>a From the control panel, navigate to: Settings > Print > Layout > Collate</p> <p>b Touch On [1,2,1,2,1,2].</p> <p>c Print the document.</p> <p>Is the document collated correctly?</p>	The problem is solved.	Go to step 2.
<p>Step 2</p> <p>a From the document that you are trying to print, open the Print dialog, and then select Collate.</p> <p>b Print the document.</p> <p>Is the document collated correctly?</p>	The problem is solved.	Go to step 3.
<p>Step 3</p> <p>a Reduce the number of pages to print.</p> <p>b Print the document.</p> <p>Are the pages collated correctly?</p>	The problem is solved.	Contact customer support .

Paper curl



Action	Yes	No
<p>Step 1</p> <p>a Adjust the guides in the tray to the correct position for the paper loaded.</p> <p>b Print the document.</p> <p>Is the paper curled?</p>	Go to step 2.	The problem is solved.
<p>Step 2</p> <p>a Depending on your operating system, specify the paper type from the Printing Preferences or Print dialog.</p> <p>Notes:</p> <ul style="list-style-type: none"> • Make sure that the setting matches the paper loaded. • You can also change the setting on the printer control panel. Navigate to: <p>Settings > Paper > Tray Configuration > Paper Size/Type</p> <p>b Print the document.</p> <p>Is the paper curled?</p>	Go to step 3.	The problem is solved.
<p>Step 3</p> <p>Print on the other side of the paper.</p> <p>a Remove paper, flip it over, and then reload paper.</p> <p>b Print the document.</p> <p>Is the paper curled?</p>	Go to step 4.	The problem is solved.
<p>Step 4</p> <p>a Load paper from a fresh package.</p> <p>Note: Paper absorbs moisture due to high humidity. Store paper in its original wrapper until you are ready to use it.</p> <p>b Print the document.</p> <p>Is the paper curled?</p>	Contact customer support .	The problem is solved.

Tray linking does not work

Action	Yes	No
<p>Step 1</p> <p>a Check if the trays contain the same paper size and paper type.</p> <p>b Check if the paper guides are positioned correctly.</p> <p>c Print the document.</p> <p>Do the trays link correctly?</p>	The problem is solved.	Go to step 2.
<p>Step 2</p> <p>a From the control panel, touch Settings > Paper > Tray Configuration > Paper Size/Type</p> <p>b Set the paper size and paper type to match the paper loaded in the linked trays.</p> <p>c Print the document.</p> <p>Do the trays link correctly?</p>	The problem is solved.	Go to step 3.
<p>Step 3</p> <p>a Make sure that Tray Linking is set to Automatic. For more information, see “Linking trays” on page 30.</p> <p>b Print the document.</p> <p>Do the trays link correctly?</p>	The problem is solved.	Contact customer support .

Paper frequently jams

Action	Yes	No
<p>Step 1</p> <p>a Remove the tray.</p> <p>b Check if paper is loaded correctly.</p> <p>Notes:</p> <ul style="list-style-type: none"> • Make sure that the paper guides are positioned correctly. • Make sure that the stack height is below the maximum paper fill indicator. • Make sure to print on recommended paper size and type. <p>c Insert the tray.</p> <p>d Print the document.</p> <p>Do paper jams occur frequently?</p>	Go to step 2.	The problem is solved.

Action	Yes	No
<p>Step 2</p> <p>a From the control panel, navigate to: Settings > Paper > Tray Configuration > Paper Size/Type</p> <p>b Set the correct paper size and type.</p> <p>c Print the document.</p> <p>Do paper jams occur frequently?</p>	Go to step 3.	The problem is solved.
<p>Step 3</p> <p>a Load paper from a fresh package.</p> <p>Note: Paper absorbs moisture due to high humidity. Store paper in its original wrapper until you are ready to use it.</p> <p>b Print the document.</p> <p>Do paper jams occur frequently?</p>	Contact customer support .	The problem is solved.

Jammed pages are not reprinted

Action	Yes	No
<p>a From the control panel, navigate to: Settings > Device > Notifications > Jam Content Recovery</p> <p>b In the Jam Recovery menu, select On or Auto.</p> <p>c Print the document.</p> <p>Are the jammed pages reprinted?</p>	The problem is solved.	Contact customer support .

Printing problems

Confidential and other held documents do not print

Action	Yes	No
<p>Step 1</p> <p>a From the control panel, check if the documents appear in the Held Jobs list.</p> <p>Note: If the documents are not listed, then print the documents using the Print and Hold options.</p> <p>b Print the documents.</p> <p>Are the documents printed?</p>	The problem is solved.	Go to step 2.

Action	Yes	No
<p>Step 2 The print job may contain a formatting error or invalid data. Delete the print job, and then send it again.</p> <p>Are the documents printed?</p>	<p>The problem is solved.</p>	<p>Go to step 3.</p>
<p>Step 3 If you are printing from the Internet, then the printer may be reading the multiple job titles as duplicates.</p> <p>For Windows users</p> <ul style="list-style-type: none"> a Open the Printing Preferences dialog. b From the Print and Hold tab, click Use Print and Hold, and then click Keep duplicate documents. c Enter a PIN, and then save the changes. d Send the print job. <p>For Macintosh users</p> <ul style="list-style-type: none"> a Save and name each job differently. b Send the job individually. <p>Are the documents printed?</p>	<p>The problem is solved.</p>	<p>Go to step 4.</p>
<p>Step 4</p> <ul style="list-style-type: none"> a Delete some held jobs to free up printer memory. b Print the documents. <p>Are the documents printed?</p>	<p>The problem is solved.</p>	<p>Go to step 5.</p>
<p>Step 5</p> <ul style="list-style-type: none"> a Add printer memory. b Print the documents. <p>Are the documents printed?</p>	<p>The problem is solved.</p>	<p>Contact customer support.</p>

Slow printing

Action	Yes	No
<p>Step 1</p> <p>Make sure that the printer cable is securely connected to the printer and to the computer, print server, option, or other network device.</p> <p>Is the printer printing slow?</p>	Go to step 2.	The problem is solved.
<p>Step 2</p> <p>a Make sure that the printer is not in Quiet Mode. From the home screen, touch Settings > Device > Maintenance > Configuration Menu > Device Operations > Quiet Mode.</p> <p>b Print the document.</p> <p>Is the printer printing slow?</p>	Go to step 3.	The problem is solved.
<p>Step 3</p> <p>a Depending on your operating system, specify the print resolution from the Printing Preferences or Print dialog.</p> <p>b Set the resolution to 4800 CQ.</p> <p>c Print the document.</p> <p>Is the printer printing slow?</p>	Go to step 4.	The problem is solved.
<p>Step 4</p> <p>a From the home screen, touch Settings > Print > Quality > Print Resolution.</p> <p>b Set the resolution to 4800 CQ.</p> <p>c Print the document.</p> <p>Is the printer printing slow?</p>	Go to step 5.	The problem is solved.
<p>Step 5</p> <p>a Depending on your operating system, specify the paper type from the Printing Preferences or Print dialog.</p> <p>Notes:</p> <ul style="list-style-type: none"> • Make sure that the setting matches the paper loaded. • You can also change the setting on the printer control panel. From the home screen, touch Settings > Paper > Tray Configuration > Paper Size/Type. • Heavier paper prints more slowly. • Paper narrower than letter, A4, and legal may print more slowly. <p>b Print the document.</p> <p>Is the printer printing slow?</p>	Go to step 6.	The problem is solved.

Action	Yes	No
<p>Step 6</p> <p>a Make sure that the printer settings for texture and weight match the paper being loaded.</p> <p>From the home screen, touch Settings > Paper > Media Configuration > Media Types.</p> <p>Note: Rough paper texture and heavy paper weight may print more slowly.</p> <p>b Print the document.</p> <p>Is the printer printing slow?</p>	Go to step 7.	The problem is solved.
<p>Step 7</p> <p>Remove held jobs.</p> <p>Is the printer printing slow?</p>	Go to step 8.	The problem is solved.
<p>Step 8</p> <p>a Make sure that the printer is not overheating.</p> <p>Notes:</p> <ul style="list-style-type: none"> • Allow the printer to cool down after a long print job. • Observe the recommended ambient temperature for the printer. For more information, see “Selecting a location for the printer” on page 11. <p>b Print the document.</p> <p>Is the printer printing slow?</p>	Contact customer support .	The problem is solved.

Print jobs do not print

Action	Yes	No
<p>Step 1</p> <p>a From the document you are trying to print, open the Print dialog, and then check if you have selected the correct printer.</p> <p>b Print the document.</p> <p>Is the document printed?</p>	The problem is solved.	Go to step 2.
<p>Step 2</p> <p>a Check if the printer is on.</p> <p>b Resolve any error messages that appear on the display.</p> <p>c Print the document.</p> <p>Is the document printed?</p>	The problem is solved.	Go to step 3.

Action	Yes	No
<p>Step 3</p> <p>a Check if the ports are working and if the cables are securely connected to the computer and the printer. For more information, see the setup documentation that came with the printer.</p> <p>b Print the document.</p> <p>Is the document printed?</p>	The problem is solved.	Go to step 4.
<p>Step 4</p> <p>a Turn off the printer, wait for about 10 seconds, and then turn on the printer.</p> <p>b Print the document.</p> <p>Is the document printed?</p>	The problem is solved.	Go to step 5.
<p>Step 5</p> <p>a Remove, and then reinstall the print driver.</p> <p>b Print the document.</p> <p>Is the document printed?</p>	The problem is solved.	Contact customer support .

The printer is not responding

Action	Yes	No
<p>Step 1</p> <p>Check if the power cord is connected to the electrical outlet.</p> <p> CAUTION—POTENTIAL INJURY: To avoid the risk of fire or electrical shock, connect the power cord to an appropriately rated and properly grounded electrical outlet that is near the product and easily accessible.</p> <p>Is the printer responding?</p>	The problem is solved.	Go to step 2.
<p>Step 2</p> <p>Check if the electrical outlet is turned off by a switch or breaker.</p> <p>Is the electrical outlet turned off by a switch or breaker?</p>	Turn on the switch or reset the breaker.	Go to step 3.
<p>Step 3</p> <p>Check if the printer is on.</p> <p>Is the printer on?</p>	Go to step 4.	Turn on the printer.
<p>Step 4</p> <p>Check if the printer is in Sleep or Hibernate mode.</p> <p>Is the printer in Sleep or Hibernate mode?</p>	Press the power button to wake the printer.	Go to step 5.

Action	Yes	No
<p>Step 5 Check if the cables connecting the printer and the computer are inserted to the correct ports.</p> <p>Are the cables inserted to the correct ports?</p>	Go to step 6.	Insert the cables to the correct ports.
<p>Step 6 Turn off the printer, install the hardware options, and then turn on the printer. For more information, see the documentation that came with the option.</p> <p>Is the printer responding?</p>	The problem is solved.	Go to step 7.
<p>Step 7 Install the correct print driver.</p> <p>Is the printer responding?</p>	The problem is solved.	Go to step 8.
<p>Step 8 Turn off the printer, wait for about 10 seconds, and then turn on the printer.</p> <p>Is the printer responding?</p>	The problem is solved.	Contact customer support .

Job prints from the wrong tray or on the wrong paper

Action	Yes	No
<p>Step 1 a Check if you are printing on the correct paper. b Print the document.</p> <p>Is the document printed on the correct paper?</p>	Go to step 2.	Load the correct paper size and paper type.
<p>Step 2 a Depending on your operating system, specify the paper size and paper type from the Printing Preferences or Print dialog. Note: You can also change the settings on the printer control panel. Navigate to: Settings > Paper > Tray Configuration > Paper Size/Type b Make sure that the settings match the paper loaded. c Print the document.</p> <p>Is the document printed on the correct paper?</p>	The problem is solved.	Go to step 3.

Action	Yes	No
<p>Step 3</p> <p>a Check if the trays are linked. For more information, see “Linking trays” on page 30.</p> <p>b Print the document.</p> <p>Is the document printed from the correct tray?</p>	<p>The problem is solved.</p>	<p>Contact customer support.</p>

Print quality is poor

Blank or white pages



Note: Before solving the problem, print the quality sample pages to determine the missing color. From the home screen, touch **Settings > Troubleshooting > Print Quality Test Pages.**

Action	Yes	No
<p>Step 1</p> <p>a Remove, and then insert the imaging unit. Warning—Potential Damage: Do not expose the imaging unit to direct light for more than 10 minutes. Extended exposure to light may cause print quality problems. Warning—Potential Damage: Do not touch the photoconductor drum under the imaging unit. Doing so may affect the quality of future print jobs..</p> <p>b Print the document.</p> <p>Is the printer printing blank or white pages?</p>	<p>Go to step 2.</p>	<p>The problem is solved.</p>
<p>Step 2</p> <p>Replace the imaging unit, and then print the document.</p> <p>Is the printer printing blank or white pages?</p>	<p>Contact customer support.</p>	<p>The problem is solved.</p>

Dark print

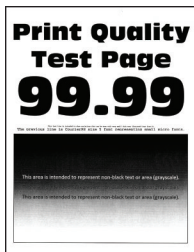

Note: Before solving the problem, print the quality sample pages to determine the missing color. From the home screen, touch **Settings > Troubleshooting > Print Quality Test Pages**.

Action	Yes	No
<p>Step 1</p> <p>a Perform Color Adjust. From the home screen, touch Settings > Print > Quality > Advanced Imaging > Color Adjust.</p> <p>b Print the document.</p> <p>Is the print too dark?</p>	Go to step 2.	The problem is solved.
<p>Step 2</p> <p>a Depending on your operating system, reduce the toner darkness from the Printing Preferences or Print dialog. Note: You can also change the setting on the printer control panel. From the home screen, touch Settings > Print > Quality > Toner Darkness.</p> <p>b Print the document.</p> <p>Is the print too dark?</p>	Go to step 3.	The problem is solved.
<p>Step 3</p> <p>a Depending on your operating system, specify the paper type from the Printing Preferences or Print dialog. Notes:</p> <ul style="list-style-type: none"> • Make sure that the setting matches the paper loaded in the tray. • You can also change the setting on the printer control panel. From the home screen, touch Settings > Paper > Tray Configuration > Paper Size/Type. <p>b Print the document.</p> <p>Is the print too dark?</p>	Go to step 4.	The problem is solved.
<p>Step 4</p> <p>Make sure that the paper has no texture or rough finishes.</p> <p>Are you printing on textured or rough paper?</p>	Go to step 5.	Go to step 6.

Action	Yes	No
<p>Step 5</p> <p>a Replace textured or rough paper with plain paper.</p> <p>b Print the document.</p> <p>Is the print too dark?</p>	Go to step 6.	The problem is solved.
<p>Step 6</p> <p>a Load paper from a fresh package.</p> <p>Note: Paper absorbs moisture due to high humidity. Store paper in its original wrapper until you are ready to use it.</p> <p>b Print the document.</p> <p>Is the print too dark?</p>	Go to step 7.	The problem is solved.
<p>Step 7</p> <p>Replace the imaging unit, and then print the document.</p> <p>Is the print too dark?</p>	Contact customer support .	The problem is solved.

Ghost images

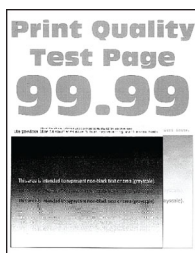

Note: Before solving the problem, print the Print Quality Test Pages. From the home screen, touch **Settings** > **Troubleshooting** > **Print Quality Test Pages**.

Action	Yes	No
<p>Step 1</p> <p>a Load the tray with the correct paper type and weight.</p> <p>b Print the document.</p> <p>Do ghost images appear on prints?</p>	Go to step 2.	The problem is solved.

Action	Yes	No
<p>Step 2</p> <p>a Depending on your operating system, specify the paper type from the Printing Preferences or Print dialog.</p> <p>Notes:</p> <ul style="list-style-type: none"> • Make sure that the setting matches the paper loaded in the tray. • You can also change the setting on the printer control panel. From the home screen, touch Settings > Paper > Tray Configuration > Paper Size/Type. <p>b Print the document.</p> <p>Do ghost images appear on prints?</p>	Go to step 3.	The problem is solved.
<p>Step 3</p> <p>a Perform Color Adjust.</p> <p>From the home screen, touch Settings > Print > Quality > Advanced Imaging > Color Adjust.</p> <p>b Print the document.</p> <p>Do ghost images appear on prints?</p>	Contact customer support .	The problem is solved.

Gray or colored background

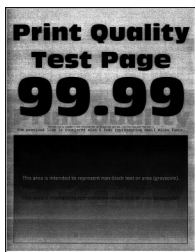

Note: Before solving the problem, print the Print Quality Test Pages. From the home screen, touch **Settings > Troubleshooting > Print Quality Test Pages**.

Action	Yes	No
<p>Step 1</p> <p>a Depending on your operating system, increase toner darkness from the Printing Preferences or Print dialog.</p> <p>Note: You can also change the setting on the printer control panel. From the home screen, touch Settings > Print > Quality > Toner Darkness.</p> <p>b Print the document.</p> <p>Does gray or colored background appear on prints?</p>	Go to step 2.	The problem is solved.

Action	Yes	No
<p>Step 2</p> <p>a Perform Color Adjust. From the home screen, touch Settings > Print > Quality > Advanced Imaging > Color Adjust.</p> <p>b Print the document.</p> <p>Does gray or colored background appear on prints?</p>	Go to step 3.	The problem is solved.
<p>Step 3</p> <p>a Remove, and then insert the imaging unit. Warning—Potential Damage: Do not expose the imaging unit to direct light for more than 10 minutes. Extended exposure to light may cause print quality problems. Warning—Potential Damage: Do not touch the photoconductor drum under the imaging unit. Doing so may affect the quality of future print jobs.</p> <p>b Print the document.</p> <p>Does gray or colored background appear on prints?</p>	Contact customer support .	The problem is solved.

Incorrect margins



Action	Yes	No
<p>Step 1</p> <p>a Adjust the paper guides to the correct position for the paper loaded.</p> <p>b Print the document.</p> <p>Are the margins correct?</p>	The problem is solved.	Go to step 2.
<p>Step 2</p> <p>a Set the paper size. From the control panel, navigate to: Settings > Paper > Tray Configuration > Paper Size/Type</p> <p>b Print the document.</p> <p>Are the margins correct?</p>	The problem is solved.	Go to step 3.

Action	Yes	No
<p>Step 3</p> <p>a Depending on your operating system, specify the paper size from the Printing Preferences or Print dialog.</p> <p>Note: Make sure that the setting matches the paper loaded.</p> <p>b Print the document.</p> <p>Are the margins correct?</p>	<p>The problem is solved.</p>	<p>Contact customer support.</p>

Light print

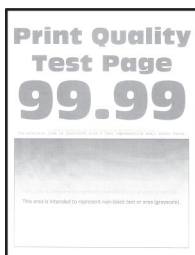

Note: Before solving the problem, print the Print Quality Test Pages. From the control panel, touch **Settings > Troubleshooting > Print Quality Test Pages**.

Action	Yes	No
<p>Step 1</p> <p>a Perform Color Adjust.</p> <p>From the control panel, navigate to:</p> <p>Settings > Print > Quality > Advanced Imaging > Color Adjust</p> <p>b Print the document.</p> <p>Is the print light?</p>	<p>Go to step 2.</p>	<p>The problem is solved.</p>
<p>Step 2</p> <p>a Depending on your operating system, increase toner darkness from the Printing Preferences or Print dialog.</p> <p>Note: You can also change the setting on the printer control panel. Navigate to Settings > Print > Quality > Toner Darkness.</p> <p>b Print the document.</p> <p>Is the print light?</p>	<p>Go to step 3.</p>	<p>The problem is solved.</p>

Action	Yes	No
<p>Step 3</p> <p>a Turn off Color Saver. From the control panel, navigate to: Settings > Print > Quality > Color Saver</p> <p>b Print the document.</p> <p>Is the print light?</p>	Go to step 4.	The problem is solved.
<p>Step 4</p> <p>a Depending on your operating system, specify the paper type from the Printing Preferences or Print dialog.</p> <p>Notes:</p> <ul style="list-style-type: none"> • Make sure that the setting matches the paper loaded. • You can also change the setting on the printer control panel. Navigate to Settings > Paper > Tray Configuration > Paper Size/Type. <p>b Print the document.</p> <p>Is the print light?</p>	Go to step 5.	The problem is solved.
<p>Step 5</p> <p>Check if paper has texture or rough finishes.</p> <p>Are you printing on textured or rough paper?</p>	Go to step 6.	Go to step 7.
<p>Step 6</p> <p>a Replace textured or rough paper with plain paper.</p> <p>b Print the document.</p> <p>Is the print light?</p>	Go to step 7.	The problem is solved.
<p>Step 7</p> <p>a Load paper from a fresh package. Note: Paper absorbs moisture due to high humidity. Store paper in its original wrapper until you are ready to use it.</p> <p>b Print the document.</p> <p>Is the print light?</p>	Go to step 8.	The problem is solved.
<p>Step 8</p> <p>Replace the imaging unit, and then print the document.</p> <p>Is the print too light?</p>	Contact customer support .	The problem is solved.

Mottled print and dots



Note: Before solving the problem, print the Print Quality Test Pages. From the control panel, touch **Settings > Troubleshooting > Print Quality Test Pages**.

Action	Yes	No
<p>Step 1 Check the printer for leaked toner contamination.</p> <p>Is the printer free of leaked toner?</p>	Go to step 2.	Contact customer support .
<p>Step 2</p> <p>a From the control panel, navigate to: Settings > Paper > Tray Configuration > Paper Size/Type</p> <p>b Check if the paper size and paper type settings match the paper loaded.</p> <p>Note: Make sure that paper does not have texture or rough finishes.</p> <p>Do the settings match?</p>	Go to step 4.	Go to step 3.
<p>Step 3</p> <p>a Depending on your operating system, specify the paper size and paper type from the Printing Preferences or Print dialog.</p> <p>Note: Make sure that the settings match the paper loaded.</p> <p>b Print the document.</p> <p>Is the print mottled?</p>	Go to step 4.	The problem is solved.
<p>Step 4</p> <p>a Load paper from a fresh package.</p> <p>Note: Paper absorbs moisture due to high humidity. Store paper in its original wrapper until you are ready to use it.</p> <p>b Print the document.</p> <p>Is the print mottled?</p>	Go to step 5.	The problem is solved.
<p>Step 5 Replace the imaging unit, and then print the document.</p> <p>Is the print mottled?</p>	Contact customer support .	The problem is solved.

Print crooked or skewed



Note: Before solving the problem, print the Print Quality Test Pages. From the home screen, touch **Settings** > **Troubleshooting** > **Print Quality Test Pages**.

Action	Yes	No
<p>Step 1</p> <ul style="list-style-type: none"> a Pull out the tray. b Remove the paper, and then load paper from a fresh package. Note: Paper absorbs moisture due to high humidity. Store paper in its original wrapper until you are ready to use it. c Squeeze and slide the paper guides to the correct position for the size of the paper you are loading. d Insert the tray. e Print the document. <p>Is the print crooked or skewed?</p>	Go to step 2.	The problem is solved.
<p>Step 2</p> <ul style="list-style-type: none"> a Check if you are printing on a supported paper. b Print the document. <p>Is the print crooked or skewed?</p>	Contact customer support .	The problem is solved.

Solid color or black images

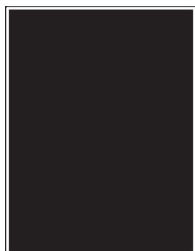

Note: Before solving the problem, print the Print Quality Test Pages. From the control panel, navigate to **Settings** > **Troubleshooting** > **Print Quality Test Pages**.

Action	Yes	No
<p>Step 1</p> <p>a Remove, and then insert the imaging unit.</p> <p>Warning—Potential Damage: Do not expose the imaging unit to direct light for more than 10 minutes. Extended exposure to light may cause print quality problems.</p> <p>Warning—Potential Damage: Do not touch the photoconductor drum under the imaging unit. Doing so may affect the quality of future print jobs.</p> <p>b Print the document.</p> <p>Is the printer printing solid color or black images?</p>	Go to step 2.	The problem is solved.
<p>Step 2</p> <p>Replace the imaging unit, and then print the document.</p> <p>Is the printer printing solid color or black images?</p>	Contact customer support .	The problem is solved.

Text or images cut off

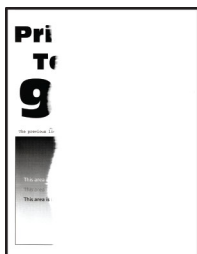

Note: Before solving the problem, print the Print Quality Test Pages. From the home screen, touch **Settings** > **Troubleshooting** > **Print Quality Test Pages**.

Action	Yes	No
<p>Step 1</p> <p>a Move the paper guides in the tray to the correct position for the paper loaded.</p> <p>b Print the document.</p> <p>Is the page or image clipped?</p>	Go to step 2.	The problem is solved.

Action	Yes	No
<p>Step 2</p> <p>a Depending on your operating system, specify the paper size from the Printing Preferences or Print dialog.</p> <p>Notes:</p> <ul style="list-style-type: none"> • Make sure that the setting matches the paper loaded in the tray. • You can also change the setting on the printer control panel. From the home screen, touch Settings > Paper > Tray Configuration > Paper Size/Type. <p>b Print the document.</p> <p>Is the page or image clipped?</p>	<p>Go to step 3.</p>	<p>The problem is solved.</p>
<p>Step 3</p> <p>a Remove, and then insert the imaging unit.</p> <p>Warning—Potential Damage: Do not expose the imaging unit to direct light for more than 10 minutes. Extended exposure to light may cause print quality problems.</p> <p>Warning—Potential Damage: Do not touch the photoconductor drum under the imaging unit. Doing so may affect the quality of future print jobs.</p> <p>b Print the document.</p> <p>Is the page or image clipped?</p>	<p>Contact customer support.</p>	<p>The problem is solved.</p>

Toner easily rubs off



Note: Before solving the problem, print the Print Quality Test Pages. From the home screen, touch **Settings > Troubleshooting > Print Quality Test Pages**.

Action	Yes	No
<p>1 Depending on your operating system, specify the paper type from the Printing Preferences or Print dialog.</p> <p>Notes:</p> <ul style="list-style-type: none"> • Make sure that the setting matches the paper loaded. • You can also change the setting on the printer control panel. From the home screen, touch Settings > Paper > Tray Configuration > Paper Size/Type. <p>2 Print the document.</p> <p>Does the toner rub off?</p>	<p>Contact customer support.</p>	<p>The problem is solved.</p>

Uneven print density



Note: Before solving the problem, print the Print Quality Test Pages. From the control panel, navigate to **Settings > Troubleshooting > Print Quality Test Pages.**

Action	Yes	No
<p>Replace the imaging unit, and then print the document.</p> <p>Is the print density uneven?</p>	<p>Contact customer support.</p>	<p>The problem is solved.</p>

Horizontal dark lines



Notes:

- Before solving the problem, print the Print Quality Test Pages. From the home screen, touch **Settings > Troubleshooting > Print Quality Test Pages.**
- If horizontal dark lines keep appearing on the prints, then see the “Repeating defects” topic.

Action	Yes	No
<p>Step 1</p> <p>a Depending on your operating system, specify the paper source from the Printing Preferences or Print dialog.</p> <p>b Print the document.</p> <p>Do horizontal dark lines appear on prints?</p>	<p>Go to step 2.</p>	<p>The problem is solved.</p>
<p>Step 2</p> <p>a Depending on your operating system, specify the paper type from the Printing Preferences or from Print dialog.</p> <p>Notes:</p> <ul style="list-style-type: none"> • Make sure that the setting matches the paper loaded in the tray. • You can also change the setting on the printer control panel. From the home screen, touch Settings > Paper > Tray Configuration > Paper Size/Type. <p>b Print the document.</p> <p>Do horizontal dark lines appear on prints?</p>	<p>Go to step 3.</p>	<p>The problem is solved.</p>
<p>Step 3</p> <p>a Load paper from a fresh package.</p> <p>Note: Paper absorbs moisture due to high humidity. Store paper in its original wrapper until you use it.</p> <p>b Print the document.</p> <p>Do horizontal dark lines appear on prints?</p>	<p>Go to step 4.</p>	<p>The problem is solved.</p>
<p>Step 4</p> <p>a Remove, and then insert the imaging unit.</p> <p>Warning—Potential Damage: Do not expose the imaging unit to direct light for more than 10 minutes. Extended exposure to light may cause print quality problems.</p> <p>Warning—Potential Damage: Do not touch the photoconductor drum under the imaging unit. Doing so may affect the quality of future print jobs.</p> <p>b Print the document.</p> <p>Do horizontal dark lines appear on prints?</p>	<p>Go to step 5.</p>	<p>The problem is solved.</p>
<p>Step 5</p> <p>Replace the imaging unit, and then print the document.</p> <p>Do horizontal dark lines appear on prints?</p>	<p>Contact customer support.</p>	<p>The problem is solved.</p>

Vertical dark lines



Note: Before solving the problem, print the Print Quality Test Pages. From the home screen, touch **Settings** > **Troubleshooting** > **Print Quality Test Pages**.

Action	Yes	No
<p>Step 1</p> <p>a Depending on your operating system, specify the paper type from the Printing Preferences or Print dialog.</p> <p>Notes:</p> <ul style="list-style-type: none"> • Make sure that the setting matches the paper loaded in the tray. • You can also change the setting on the printer control panel. From the home screen, touch Settings > Paper > Tray Configuration > Paper Size/Type. <p>b Print the document.</p> <p>Do vertical dark lines appear on prints?</p>	Go to step 2.	The problem is solved.
<p>Step 2</p> <p>a Load paper from a fresh package.</p> <p>Note: Paper absorbs moisture due to high humidity. Store paper in its original wrapper until you use it.</p> <p>b Print the document.</p> <p>Do vertical dark lines appear on prints?</p>	Go to step 3.	The problem is solved.
<p>Step 3</p> <p>a Remove, and then insert the imaging unit.</p> <p>Warning—Potential Damage: Do not expose the imaging unit to direct light for more than 10 minutes. Extended exposure to light may cause print quality problems.</p> <p>Warning—Potential Damage: Do not touch the photoconductor drum under the imaging unit. Doing so may affect the quality of future print jobs.</p> <p>b Print the document.</p> <p>Do vertical dark lines appear on prints?</p>	Go to step 4.	The problem is solved.

Action	Yes	No
<p>Step 4 Replace the imaging unit, and then print the document.</p> <p>Do vertical dark lines appear on prints?</p>	<p>Contact customer support.</p>	<p>The problem is solved.</p>

Horizontal white lines



Notes:

- Before solving the problem, print the Print Quality Test Pages. From the home screen, touch **Settings > Troubleshooting > Print Quality Test Pages**.
- If horizontal white lines keep appearing on the prints, then see the “Repeating defects” topic.

Action	Yes	No
<p>Step 1</p> <p>a Depending on your operating system, specify the paper type from the Printing Preferences or Print dialog.</p> <p>Notes:</p> <ul style="list-style-type: none"> • Make sure that the setting matches the paper loaded in the tray. • You can also change the setting on the printer control panel. From the home screen, touch Settings > Paper > Tray Configuration > Paper Size/Type. <p>b Print the document.</p> <p>Do horizontal white lines appear on prints?</p>	<p>Go to step 2.</p>	<p>The problem is solved.</p>
<p>Step 2</p> <p>a Load the specified paper source with the recommended paper type.</p> <p>b Print the document.</p> <p>Do horizontal white lines appear on prints?</p>	<p>Go to step 3.</p>	<p>The problem is solved.</p>

Action	Yes	No
<p>Step 3</p> <p>a Remove, and then insert the imaging unit.</p> <p>Warning—Potential Damage: Do not expose the imaging unit to direct light for more than 10 minutes. Extended exposure to light may cause print quality problems.</p> <p>Warning—Potential Damage: Do not touch the photoconductor drum under the imaging unit. Doing so may affect the quality of future print jobs.</p> <p>b Print the document.</p> <p>Do horizontal white lines appear on prints?</p>	Go to step 4.	The problem is solved.
<p>Step 4</p> <p>Replace the imaging unit, and then print the document.</p> <p>Do horizontal white lines appear on prints?</p>	Contact customer support .	The problem is solved.

Vertical white lines



Note: Before solving the problem, print the Print Quality Test Pages. From the home screen, touch **Settings** > **Troubleshooting** > **Print Quality Test Pages**.

Action	Yes	No
<p>Step 1</p> <p>a Depending on your operating system, specify the paper type from the Printing Preferences or Print dialog.</p> <p>Notes:</p> <ul style="list-style-type: none"> • Make sure that the setting matches the paper loaded in the tray. • You can also change the setting on the printer control panel. From the home screen, touch Settings > Paper > Tray Configuration > Paper Size/Type. <p>b Print the document.</p> <p>Do vertical white lines appear on prints?</p>	Go to step 2.	The problem is solved.

Action	Yes	No
<p>Step 2 Check if you are using the recommended paper type.</p> <ul style="list-style-type: none"> a Load the specified paper source with the recommended paper type. b Print the document. <p>Do vertical white lines still appear on prints?</p>	Go to step 3.	The problem is solved.
<p>Step 3 a Remove, and then insert the imaging unit.</p> <p>Warning—Potential Damage: Do not expose the imaging unit to direct light for more than 10 minutes. Extended exposure to light may cause print quality problems.</p> <p>Warning—Potential Damage: Do not touch the photoconductor drum under the imaging unit. Doing so may affect the quality of future print jobs.</p> <ul style="list-style-type: none"> b Print the document. <p>Do vertical white lines still appear on prints?</p>	Go to step 4.	The problem is solved.
<p>Step 4 Replace the imaging unit, and then print the document.</p> <p>Do vertical white lines still appear on prints?</p>	Contact customer support .	The problem is solved.

Repeating defects

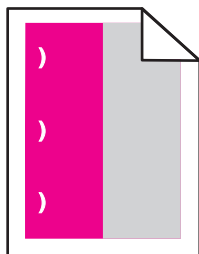

Note: Before solving the problem, print the Print Quality Test Pages. From the home screen, touch **Settings** > **Troubleshooting** > **Print Quality Test Pages**.

Action	Yes	No
<p>Step 1</p> <p>a Using the Maintenance Defect Ruler page, measure the distance between the repeating defects on the affected color page.</p> <p>b Replace the supply item that matches the measurement on the affected color page.</p> <p>Photoconductor unit</p> <ul style="list-style-type: none"> • 125.70 mm (4.95 in.) • 35.40 mm (1.39 in.) <p>Developer unit</p> <p>42 mm (1.65 in.)</p> <p>c Print the quality sample pages.</p> <p>Do the defects appear?</p>	<p>Take note of the distance, and then contact customer support or your service representative.</p>	<p>The problem is solved.</p>
<p>Step 2</p> <p>a Using the Maintenance Defect Ruler page, measure the distance between the repeating defects on the affected color page.</p> <p>b Replace the supply item that matches the measurement on the affected color page.</p> <p>Transfer roller</p> <p>78.50 mm (3.09 in.)</p> <p>Transfer module</p> <ul style="list-style-type: none"> • 47.10 mm (1.86 in.) • 90 mm (3.54 in.) <p>Fuser</p> <ul style="list-style-type: none"> • 96.60 mm (3.80 in.) • 127.60 mm (5.02 in.) <p>c Print the quality sample pages.</p> <p>Do the defects appear?</p>	<p>Take note of the distance, and then contact customer support or your service representative.</p>	<p>The problem is solved.</p>

Color quality problems

Adjusting toner darkness

- 1 From the home screen, touch **Settings > Print > Quality**.
- 2 Adjust the toner darkness.
- 3 Apply the changes.

Modifying the colors in printed output

- 1 From the home screen, touch **Settings > Print > Quality > Advanced Imaging > Color Correction**.
- 2 In the Color Correction menu, touch **Manual > Color Correction Content**.
- 3 Choose the appropriate color conversion setting.

Object type	Color conversion tables
RGB Image RGB Text RGB Graphics	<ul style="list-style-type: none"> • Vivid—Produces brighter, more saturated colors and may be applied to all incoming color formats. • sRGB Display—Produces an output that approximates the colors shown on a computer monitor. Black toner usage is optimized for printing photographs. • Display-True Black—Produces an output that approximates the colors shown on a computer monitor. This setting uses only black toner to create all levels of neutral gray. • sRGB Vivid—Provides an increased color saturation for the sRGB Display color correction. Black toner usage is optimized for printing business graphics. • Off
CMYK Image CMYK Text CMYK Graphics	<ul style="list-style-type: none"> • US CMYK—Applies color correction to approximate the Specifications for Web Offset Publishing (SWOP) color output. • Euro CMYK—Applies color correction to approximate Euroscale color output. • Vivid CMYK—Increases the color saturation of the US CMYK color correction setting. • Off

FAQ about color printing

What is RGB color?

RGB color is a method of describing colors by indicating the amount of red, green, or blue used to produce a certain color. Red, green, and blue light can be added in various amounts to produce a large range of colors observed in nature. Computer screens, scanners, and digital cameras use this method to display colors.

What is CMYK color?

CMYK color is a method of describing colors by indicating the amount of cyan, magenta, yellow, and black used to reproduce a particular color. Cyan, magenta, yellow, and black inks or toners can be printed in various amounts to produce a large range of colors observed in nature. Printing presses, inkjet printers, and color laser printers create colors in this manner.

How is color specified in a document to be printed?

Software programs are used to specify and modify the document color using RGB or CMYK color combinations. For more information, see the software program Help topics.

How does the printer know what color to print?

When printing a document, information describing the type and color of each object is sent to the printer and is passed through color conversion tables. Color is translated into the appropriate amounts of cyan, magenta, yellow, and black toner used to produce the color you want. The object information determines the application of color conversion tables. For example, it is possible to apply one type of color conversion table to text while applying a different color conversion table to photographic images.

What is manual color correction?

When manual color correction is enabled, the printer employs user-selected color conversion tables to process objects. Manual color correction settings are specific to the type of object being printed (text, graphics, or images). It is also specific to how the color of the object is specified in the software program (RGB or CMYK combinations). To apply a different color conversion table manually, see [“Modifying the colors in printed output” on page 252](#).

If the software program does not specify colors with RGB or CMYK combinations, then manual color correction is not useful. It is also not effective if the software program or the computer operating system controls the adjustment of colors. In most situations, setting the Color Correction to Auto generates preferred colors for the documents.

How can I match a particular color (such as a corporate logo)?

From the printer Quality menu, nine types of Color Samples sets are available. These sets are also available from the Color Samples page of the Embedded Web Server. Selecting any sample set generates multiple-page prints consisting of hundreds of colored boxes. Each box contains a CMYK or RGB combination, depending on the table selected. The observed color of each box is obtained by passing the CMYK or RGB combination labeled on the box through the selected color conversion table.

By examining Color Samples sets, you can identify the box with color closest to the color being matched. The color combination labeled on the box can then be used for modifying the color of the object in a software program. For more information, see the software program Help topics. Manual color correction may be necessary to use the selected color conversion table for the particular object.

Selecting which Color Samples set to use for a particular color-matching problem depends on:

- The Color Correction setting being used (Auto, Off, or Manual)
- The type of object being printed (text, graphics, or images)
- How the color of the object is specified in the software program (RGB or CMYK combinations)

If the software program does not specify colors with RGB or CMYK combinations, then the Color Samples pages are not useful. Additionally, some software programs adjust the RGB or CMYK combinations specified in the program through color management. In these situations, the printed color may not be an exact match of the Color Samples pages.

The print appears tinted

Action	Yes	No
<p>Step 1 Perform Color Adjust.</p> <p>a From the home screen, touch Settings > Print > Quality > Advanced Imaging > Color Adjust.</p> <p>b Print the document.</p> <p>Does the print appear tinted?</p>	Go to step 2.	The problem is solved.

Action	Yes	No
<p>Step 2 Perform Color Balance.</p> <p>a From the home screen, touch Settings > Print > Quality > Advanced Imaging > Color Balance.</p> <p>b Adjust the settings.</p> <p>c Print the document.</p> <p>Does the print appear tinted?</p>	<p>Contact customer support.</p>	<p>The problem is solved.</p>

Faxing problems

Caller ID is not shown

Action	Yes	No
<p>Enable caller ID.</p> <p>From the home screen, touch Settings > Fax > Fax Setup > Fax Receive Settings > Admin Controls > Enable Caller ID.</p> <p>Does the caller ID appear?</p>	<p>The problem is solved.</p>	<p>Contact customer support.</p>

Cannot send or receive faxes

Action	Yes	No
<p>Step 1 Resolve any error messages that appear on the display.</p> <p>Can you send or receive a fax?</p>	<p>The problem is solved.</p>	<p>Go to step 2.</p>
<p>Step 2 Make sure that the cable connections for the following equipment are secure:</p> <ul style="list-style-type: none"> • Telephone • Handset • Answering machine <p>Can you send or receive a fax?</p>	<p>The problem is solved.</p>	<p>Go to step 3.</p>
<p>Step 3 Check for a dial tone.</p> <ul style="list-style-type: none"> • Call the fax number to check if it is working properly. • If you are using the On Hook Dial feature, then turn up the volume to check if you hear a dial tone. <p>Can you hear a dial tone?</p>	<p>Go to step 5.</p>	<p>Go to step 4.</p>

Action	Yes	No
<p>Step 4</p> <p>Check the telephone wall jack.</p> <ul style="list-style-type: none"> a Connect the analog telephone directly to the wall jack. b Listen for a dial tone. c If you do not hear a dial tone, then use a different telephone cable. d If you still do not hear a dial tone, then connect the analog telephone to a different wall jack. e If you hear a dial tone, then connect the printer to that wall jack. <p>Can you send or receive a fax?</p>	<p>The problem is solved.</p>	<p>Go to step 5.</p>
<p>Step 5</p> <p>Check if the printer is connected to an analog phone service or to the correct digital connector.</p> <ul style="list-style-type: none"> • If you are using an Integrated Services for Digital Network (ISDN) telephone service, then connect to an analog telephone port of an ISDN terminal adapter. For more information, contact your ISDN provider. • If you are using DSL, then connect to a DSL filter or router that supports analog use. For more information, contact your DSL provider. • If you are using a private branch exchange (PBX) telephone service, then make sure that you are connecting to an analog connection on the PBX. If none exists, then consider installing an analog telephone line for the fax machine. <p>Can you send or receive a fax?</p>	<p>The problem is solved.</p>	<p>Go to step 6.</p>
<p>Step 6</p> <p>Temporarily disconnect other equipment and disable other telephone services.</p> <ul style="list-style-type: none"> a Disconnect other equipment (such as answering machines, computers, modems, or telephone line splitters) between the printer and the telephone line. b Disable call waiting and voice mail. For more information, contact your telephone company. <p>Can you send or receive a fax?</p>	<p>The problem is solved.</p>	<p>Go to step 7.</p>
<p>Step 7</p> <p>Scan the original document one page at a time.</p> <ul style="list-style-type: none"> a Dial the fax number. b Scan the document. <p>Can you send or receive a fax?</p>	<p>The problem is solved.</p>	<p>Contact customer support.</p>

Can receive but not send faxes

Action	Yes	No
<p>Step 1 Load the original document properly into the ADF tray or on the scanner glass.</p> <p>Can you send faxes?</p>	The problem is solved.	Go to step 2.
<p>Step 2 Set up the shortcut number properly.</p> <ul style="list-style-type: none"> • Check if the shortcut number is set for the telephone number that you want to dial. • Dial the telephone number manually. <p>Can you send faxes?</p>	The problem is solved.	Contact customer support .

Can send but not receive faxes

Action	Yes	No
<p>Step 1 Make sure that the paper source is not empty.</p> <p>Can you receive faxes?</p>	The problem is solved.	Go to step 2.
<p>Step 2 Check the ring count delay settings. From the control panel, touch Settings > Fax > Fax Setup > Fax Receive Settings > Rings to Answer.</p> <p>Can you receive faxes?</p>	The problem is solved.	Go to step 3.
<p>Step 3 If the printer is printing blank pages, then see “Blank or white pages” on page 234.</p> <p>Can you receive faxes?</p>	The problem is solved.	Contact customer support .

Poor fax print quality

Action	Yes	No
<p>Step 1 Make sure that there are no print quality defects.</p> <p>a From the control panel, touch Settings > Troubleshooting > Print Quality Test Pages.</p> <p>b Correct any print quality defects. For more information, see “Print quality is poor” on page 234.</p> <p>Is the fax print quality satisfactory?</p>	<p>The problem is solved.</p>	<p>Go to step 2.</p>
<p>Step 2 Decrease the incoming fax transmission speed.</p> <p>a From the control panel, touch Settings > Fax > Fax Setup > Fax Receive Settings > Admin Controls.</p> <p>b In the Max Speed menu, select a lower transmission speed.</p> <p>Is the fax print quality satisfactory?</p>	<p>The problem is solved.</p>	<p>Contact customer support.</p>

Scanning problems

Cannot scan from a computer

Action	Yes	No
<p>Step 1</p> <p>a Turn off the printer, wait for about 10 seconds, and then turn it back on.</p> <p>b Resend the scan job.</p> <p>Can you send the scan job?</p>	<p>The problem is solved.</p>	<p>Go to step 2.</p>
<p>Step 2</p> <p>a Make sure that the cables between the printer and the print server are secure. For more information, see the setup documentation that came with the printer.</p> <p>b Resend the scan job.</p> <p>Can you send the scan job?</p>	<p>The problem is solved.</p>	<p>Contact customer support.</p>

Partial copies of document or photo

Action	Yes	No
<p>Step 1</p> <p>a Make sure that the document or photo is loaded facedown on the upper left corner of the scanner glass.</p> <p>b Copy the document or photo.</p> <p>Is the document or photo copied correctly?</p>	The problem is solved.	Go to step 2.
<p>Step 2</p> <p>a Match the paper size setting and the paper loaded in the tray.</p> <p>b Copy the document or photo.</p> <p>Is the document or photo copied correctly?</p>	The problem is solved.	Contact customer support .

Poor copy quality

Action	Yes	No
<p>Step 1</p> <p>a Clean the scanner glass and the ADF glass with a damp, soft, lint-free cloth. If your printer has a second ADF glass inside the ADF, then also clean that glass. For more information, see “Cleaning the scanner” on page 159.</p> <p>b Make sure that the document or photo is loaded facedown on the upper left corner of the scanner glass.</p> <p>c Copy the document or photo.</p> <p>Is the copy quality satisfactory?</p>	The problem is solved.	Go to step 2.
<p>Step 2</p> <p>a Check the quality of the original document or photo.</p> <p>b Adjust the scan quality settings.</p> <p>c Copy the document or photo.</p> <p>Is the copy quality satisfactory?</p>	The problem is solved.	Contact customer support .

Scan job was not successful

Action	Yes	No
<p>Step 1 Check the cable connections.</p> <ul style="list-style-type: none"> a Make sure that the Ethernet or USB cable is securely connected to the computer and the printer. b Resend the scan job. <p>Is the scan job successful?</p>	The problem is solved.	Go to step 2.
<p>Step 2 Check the file you want to scan.</p> <ul style="list-style-type: none"> a Make sure that the file name is not already used in the destination folder. b Make sure that the document or photo you want to scan is not open in another application. c Resend the scan job. <p>Is the scan job successful?</p>	The problem is solved.	Go to step 3.
<p>Step 3</p> <ul style="list-style-type: none"> a Make sure that the Append time stamp or the Overwrite existing file check box is selected in the destination configuration settings. b Resend the scan job. <p>Is the scan job successful?</p>	The problem is solved.	Contact customer support .

Scanner does not close

Action	Yes	No
<p>Remove obstructions that keep the scanner cover open.</p> <p>Did the scanner cover close correctly?</p>	The problem is solved.	Contact customer support .

Scanning takes too long or freezes the computer

Action	Yes	No
<p>Close all applications that are interfering with the scan.</p> <p>Does scanning take too long or freeze the computer?</p>	Contact customer support .	The problem is solved.

Scanner does not respond

Action	Yes	No
<p>Step 1</p> <p>a Check if the power cord is connected properly to the printer and the electrical outlet.</p> <p> CAUTION—POTENTIAL INJURY: To avoid the risk of fire or electrical shock, connect the power cord to an appropriately rated and properly grounded electrical outlet that is near the product and easily accessible.</p> <p>b Copy or scan the document.</p> <p>Is the scanner responding?</p>	The problem is solved.	Go to step 2.
<p>Step 2</p> <p>a Check if the printer is turned on.</p> <p>b Resolve any error messages that appear on the display.</p> <p>c Copy or scan the document.</p> <p>Is the scanner responding?</p>	The problem is solved.	Go to step 3.
<p>Step 3</p> <p>a Turn off the printer, wait for about 10 seconds, and then turn the printer on.</p> <p>b Copy or scan the document.</p> <p>Is the scanner responding?</p>	The problem is solved.	Contact customer support .

Adjusting scanner registration

- 1 From the home screen, touch **Settings > Device > Maintenance > Configuration Menu > Scanner Configuration > Scanner Manual Registration**.
- 2 In the Print Quick Test menu, touch **Start**.
- 3 Place the Print Quick Test page on the scanner glass, and then touch **Flatbed Registration**.
- 4 In the Copy Quick Test menu, touch **Start**.
- 5 Compare the Copy Quick Test page with the original document.

Note: If the margins of the test page are different from the original document, then adjust Left Margin and Top Margin.
- 6 Repeat [step 4](#) and [step 5](#) until the margins of the Copy Quick Test page closely match the original document.

Adjusting ADF registration

- 1 From the home screen, touch **Settings > Device > Maintenance > Configuration Menu > Scanner Configuration > Scanner Manual Registration**.
- 2 In the Print Quick Test menu, touch **Start**.

3 Place the Print Quick Test page on the ADF tray.

4 Touch **Front ADF Registration** or **Rear ADF Registration**.

Notes:

- To align Front ADF Registration, place the test page faceup, short edge first into the ADF.
- To align Rear ADF Registration, place the test page facedown, short edge first into the ADF.

5 In the Copy Quick Test menu, touch **Start**.

6 Compare the Copy Quick Test page with the original document.

Note: If the margins of the test page are different from the original document, then adjust Horizontal Adjust and Top Margin.

7 Repeat [step 5](#) and [step 6](#) until the margins of the Copy Quick Test page closely match the original document.

Contacting customer support

Before contacting customer support, make sure to have the following information:

- Printer problem
- Error message
- Printer model type and serial number

Go to <http://support.lexmark.com> to receive e-mail or chat support, or browse through the library of manuals, support documentation, drivers, and other downloads.

Technical support via telephone is also available. In the U.S. or Canada, call 1-800-539-6275. For other countries or regions, go to <http://support.lexmark.com>.

Upgrading and migrating

Hardware

Available internal options

- Memory card
 - DDR3 DIMM
 - Flash memory
 - Fonts
 - Application cards
 - Forms and Bar Code
 - PRESCRIBE
 - IPDS
- Lexmark Internal Solutions Port (ISP)
 - MarkNet N8370 (802.11 a/b/g/n/ac Wireless Print Server)
 - IEEE 1284-B Parallel Card
 - RS-232C Serial Card

Installing a memory card

CAUTION—SHOCK HAZARD: To avoid the risk of electrical shock, if you are accessing the controller board or installing optional hardware or memory devices sometime after setting up the printer, then turn the printer off, and unplug the power cord from the electrical outlet before continuing. If you have any other devices attached to the printer, then turn them off as well, and unplug any cables going into the printer.

1 Turn off the printer, and then unplug the power cord from the electrical outlet.

2 Using a flat-head screwdriver, remove the controller board access cover.

Warning—Potential Damage: Controller board electronic components are easily damaged by static electricity. Touch a metal surface on the printer before touching any controller board components or connectors.

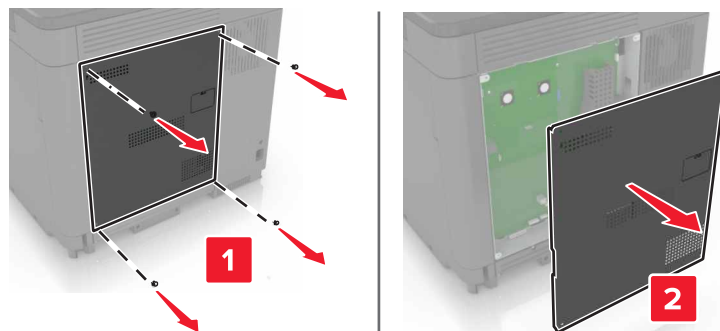

- 3 Unpack the memory card.

Warning—Potential Damage: Avoid touching the connection points along the edge of the card.

- 4 Insert the memory card until it *clicks* into place.

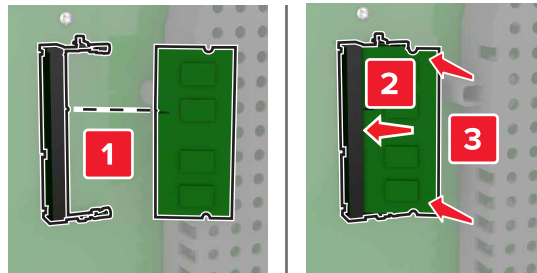

- 5 Reattach the access cover.

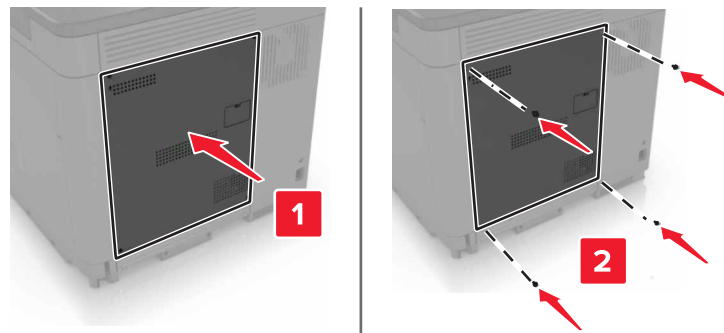

- 6 Connect the power cord to the electrical outlet, and then turn on the printer.

CAUTION—POTENTIAL INJURY: To avoid the risk of fire or electrical shock, connect the power cord to an appropriately rated and properly grounded electrical outlet that is near the product and easily accessible.

Installing an internal solutions port

CAUTION—SHOCK HAZARD: To avoid the risk of electrical shock, if you are accessing the controller board or installing optional hardware or memory devices sometime after setting up the printer, then turn the printer off, and unplug the power cord from the electrical outlet before continuing. If you have any other devices attached to the printer, then turn them off as well, and unplug any cables going into the printer.

- 1 Turn off the printer, and then unplug the power cord from the electrical outlet.
- 2 Using a flat-head screwdriver, remove the controller board access cover.

Warning—Potential Damage: Controller board electronic components are easily damaged by static electricity. Touch a metal surface on the printer before touching any controller board components or connectors.

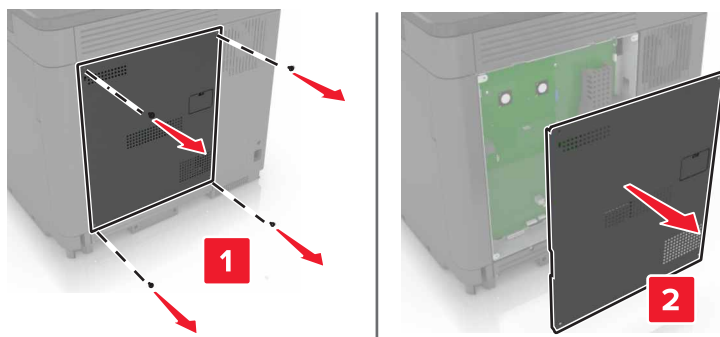

3 Unpack the internal solutions port (ISP) kit.

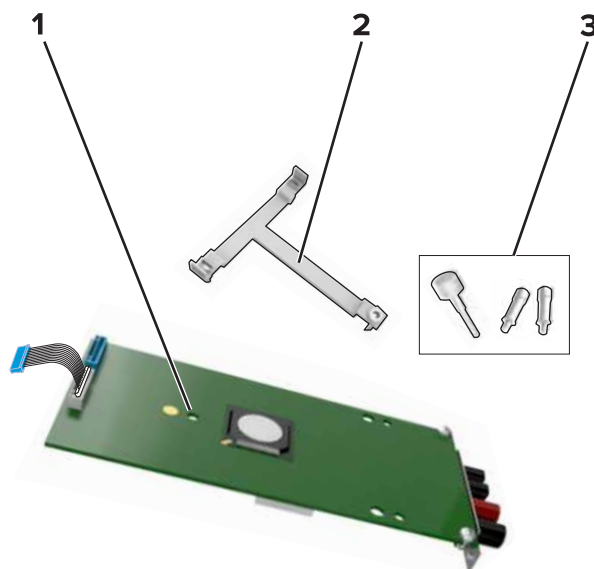

1	ISP
2	Mounting bracket
3	Thumbscrews

4 If necessary, remove the printer hard disk.

5 Insert the bracket into the board until it *clicks* into place.

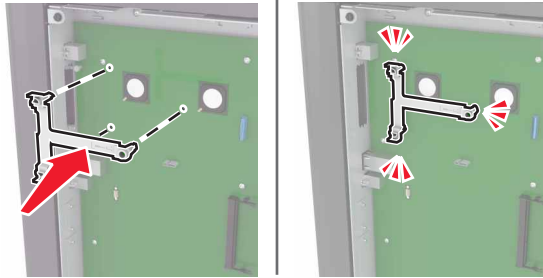

6 Attach the ISP to the bracket.

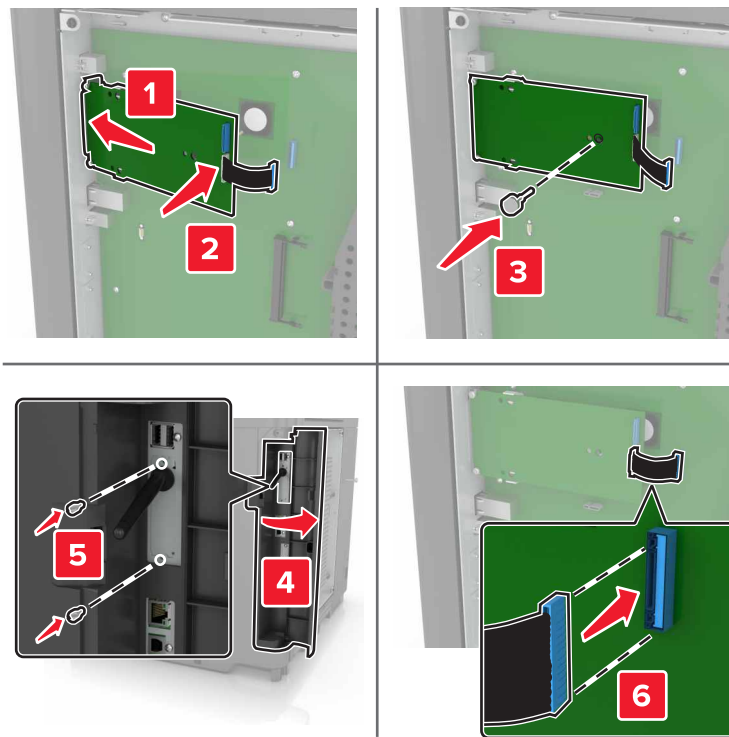

7 If necessary, attach the hard disk to the ISP.

a Remove the hard disk bracket.

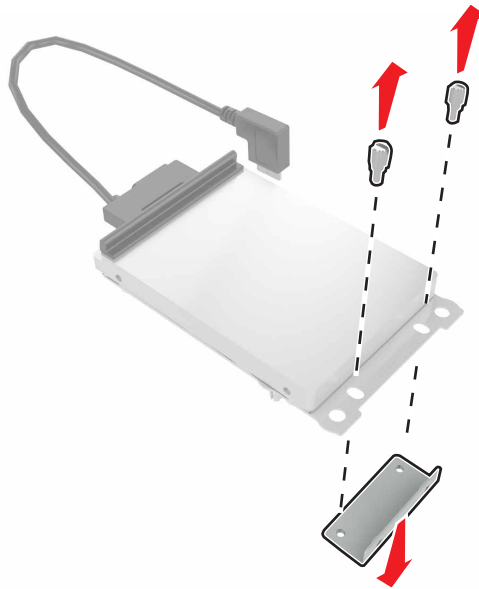

b Connect the hard disk to the ISP.

Warning—Potential Damage: Do not touch or press the center of the hard disk.

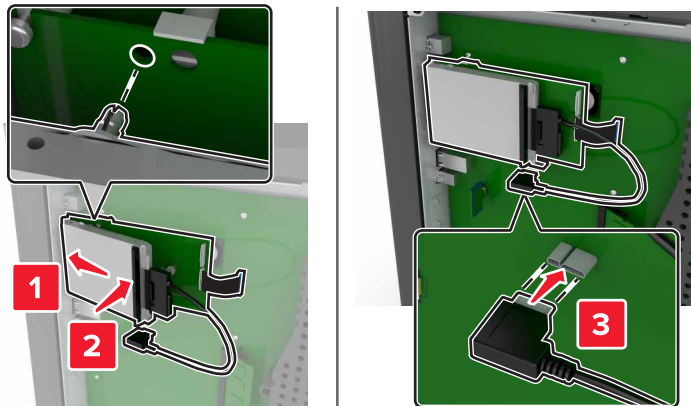

- 8 Reattach the access cover.

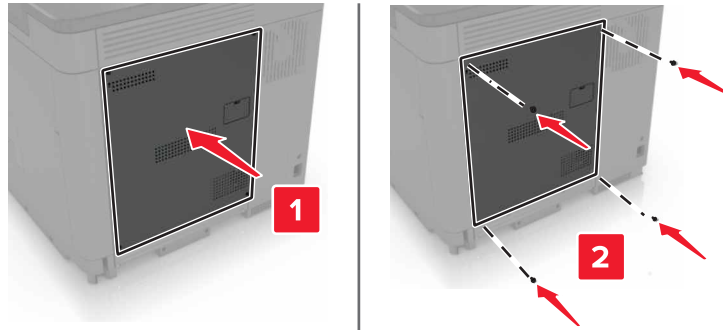

- 9 Connect the power cord to the electrical outlet, and then turn on the printer.

CAUTION—POTENTIAL INJURY: To avoid the risk of fire or electrical shock, connect the power cord to an appropriately rated and properly grounded electrical outlet that is near the product and easily accessible.

Installing an optional card

CAUTION—SHOCK HAZARD: To avoid the risk of electrical shock, if you are accessing the controller board or installing optional hardware or memory devices sometime after setting up the printer, then turn the printer off, and unplug the power cord from the electrical outlet before continuing. If you have any other devices attached to the printer, then turn them off as well, and unplug any cables going into the printer.

- 1 Turn off the printer, and then unplug the power cord from the electrical outlet.
- 2 Using a flat-head screwdriver, remove the controller board access cover.

Warning—Potential Damage: Controller board electronic components are easily damaged by static electricity. Touch a metal surface on the printer before touching any components or connectors.

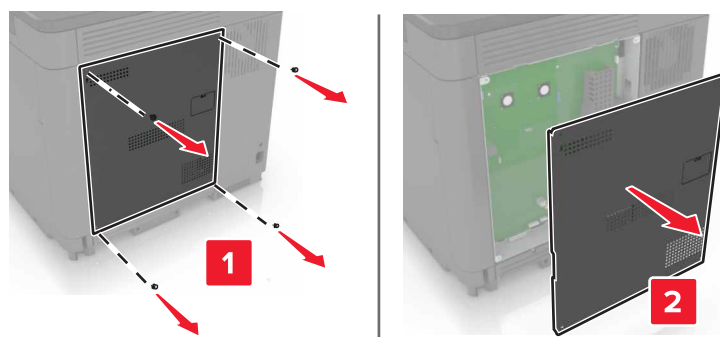

- 3 Unpack the optional card.

Warning—Potential Damage: Avoid touching the connection points along the edge of the card.

- 4 Push the card firmly into place.

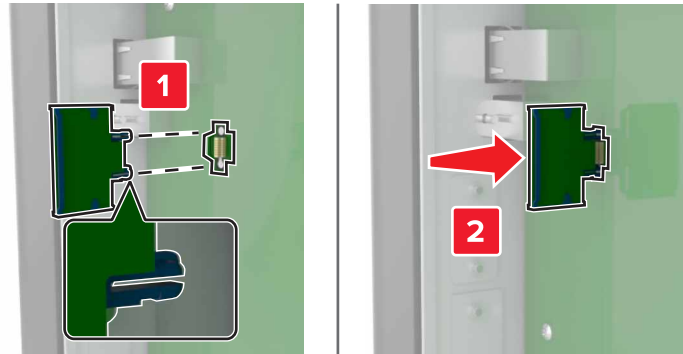

Note: The entire length of the connector on the card must touch and be flush against the controller board.

Warning—Potential Damage: Improper installation of the card may cause damage to the card and the controller board.

- 5 Reattach the access cover.

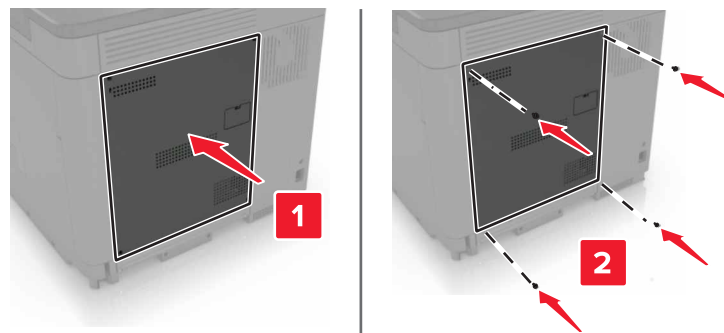

- 6 Connect the power cord to the electrical outlet, and then turn on the printer.

CAUTION—POTENTIAL INJURY: To avoid the risk of fire or electrical shock, connect the power cord to an appropriately rated and properly grounded electrical outlet that is near the product and easily accessible.

Installing a printer hard disk

CAUTION—SHOCK HAZARD: To avoid the risk of electrical shock, if you are accessing the controller board or installing optional hardware or memory devices sometime after setting up the printer, then turn the printer off, and unplug the power cord from the electrical outlet before continuing. If you have any other devices attached to the printer, then turn them off as well, and unplug any cables going into the printer.

- 1 Turn off the printer, and then unplug the power cord from the electrical outlet.
- 2 Using a flat-head screwdriver, remove the controller board access cover.

Warning—Potential Damage: Controller board electronic components are easily damaged by static electricity. Touch a metal surface on the printer before touching any controller board components or connectors.

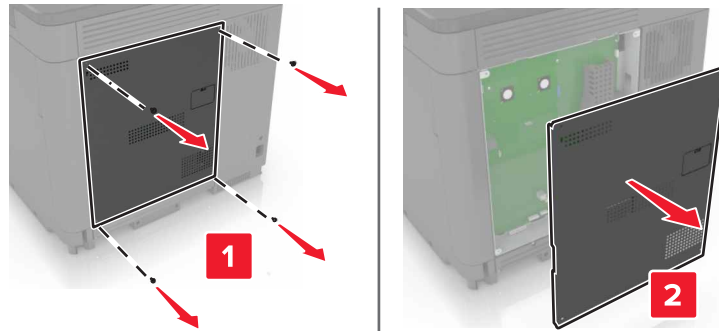

3 Unpack the hard disk.

4 Attach the hard disk to the controller board.

Warning—Potential Damage: Do not touch or press the center of the hard disk.

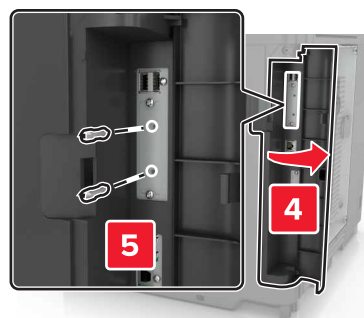
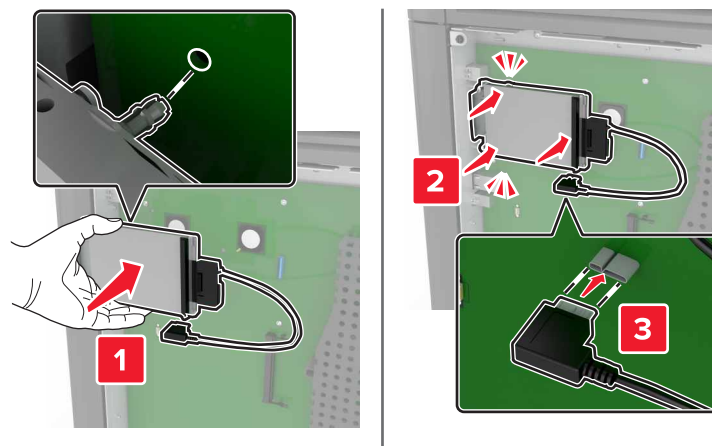

If an internal solutions port (ISP) is installed, then do the following:

- a Remove the hard disk bracket.

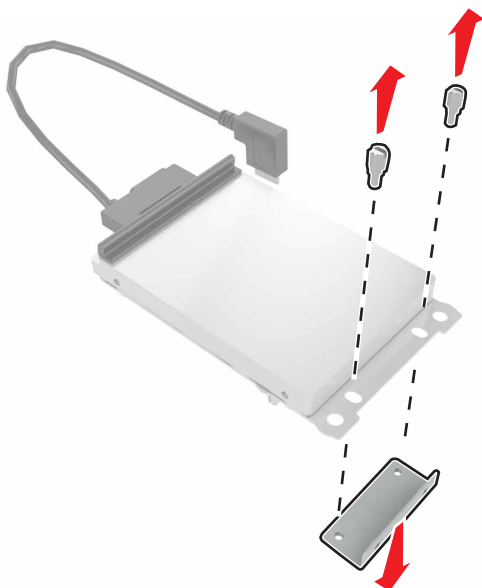

- b Attach the hard disk to the ISP.

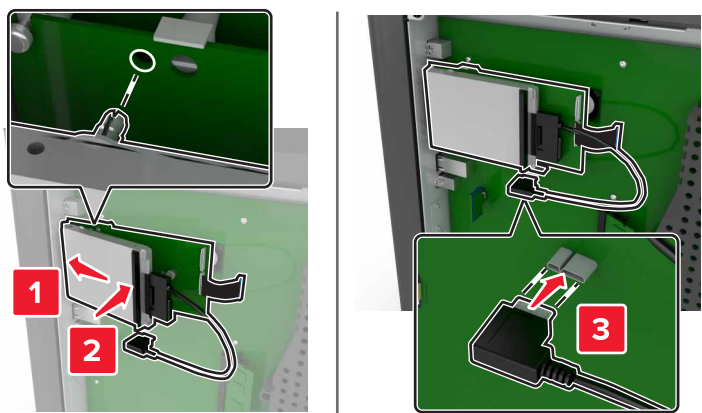

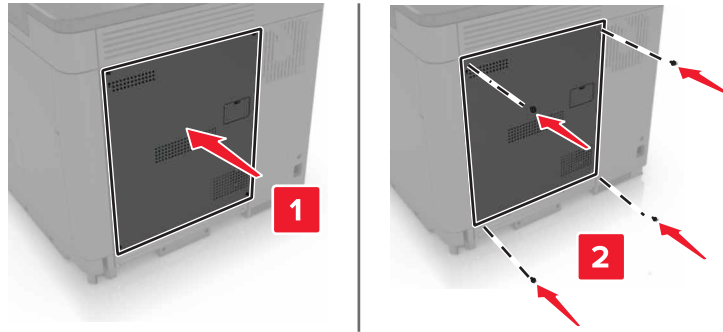
5 Reattach the access cover.**6** Connect the power cord to the electrical outlet, and then turn on the printer.

CAUTION—POTENTIAL INJURY: To avoid the risk of fire or electrical shock, connect the power cord to an appropriately rated and properly grounded electrical outlet that is near the product and easily accessible.

Installing optional trays

CAUTION—SHOCK HAZARD: To avoid the risk of electrical shock, if you are accessing the controller board or installing optional hardware or memory devices sometime after setting up the printer, then turn the printer off, and unplug the power cord from the electrical outlet before continuing. If you have any other devices attached to the printer, then turn them off as well, and unplug any cables going into the printer.

CAUTION—TIPPING HAZARD: Installing one or more options on your printer or MFP may require a caster base, furniture, or other feature to prevent instability causing possible injury. For more information on supported configurations, see www.lexmark.com/multifunctionprinters.

- 1 Turn off the printer.
- 2 Unplug the power cord from the electrical outlet, and then from the printer.
- 3 Unpack the optional tray, and then remove all packing material.
- 4 Lift the printer using the side and rear handles.

CAUTION—POTENTIAL INJURY: If the printer weight is greater than 20 kg (44 lb), then it may require two or more people to lift it safely.

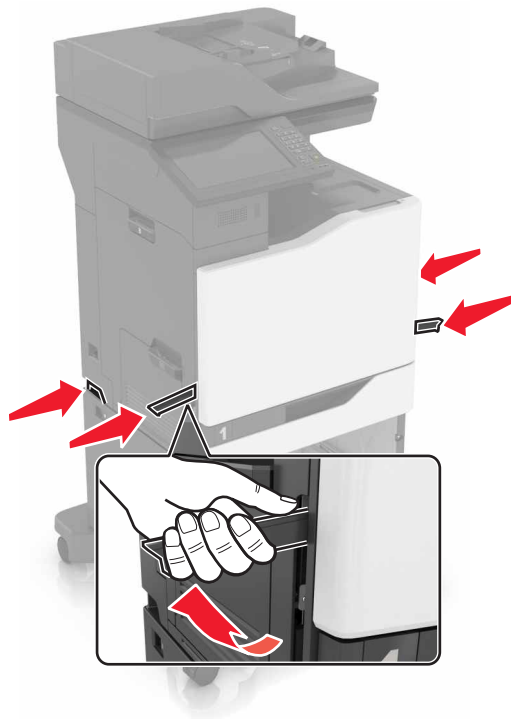

Note: If optional trays are already installed, then unlock them from the printer before lifting the printer. Do not try to lift the printer and trays at the same time.

- 5 Align the printer with the optional tray, and then lower the printer until it *clicks* into place.

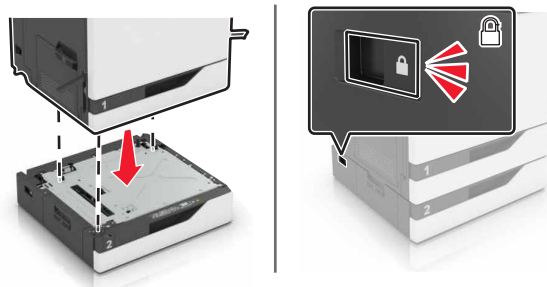

- 6 Connect the power cord to the printer, and then to the electrical outlet.

⚠ CAUTION—POTENTIAL INJURY: To avoid the risk of fire or electrical shock, connect the power cord to an appropriately rated and properly grounded electrical outlet that is near the product and easily accessible.

- 7 Turn on the printer.

If necessary, manually add the tray in the print driver to make it available for print jobs. For more information, see [“Adding available options in the print driver” on page 278](#).

When installing more than one hardware option, follow this order of installation.

- Caster base
- Optional 2200-sheet tray
- Optional 550-sheet tray or envelope tray

- Printer
- Staple finisher

Installing the staple finisher

- 1 Turn off the printer.
- 2 Open door C.

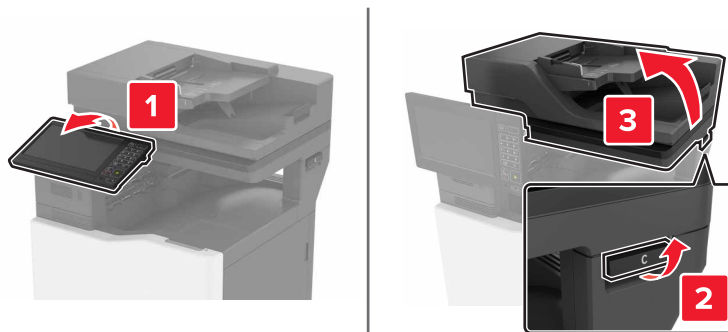

- 3 Open door A.

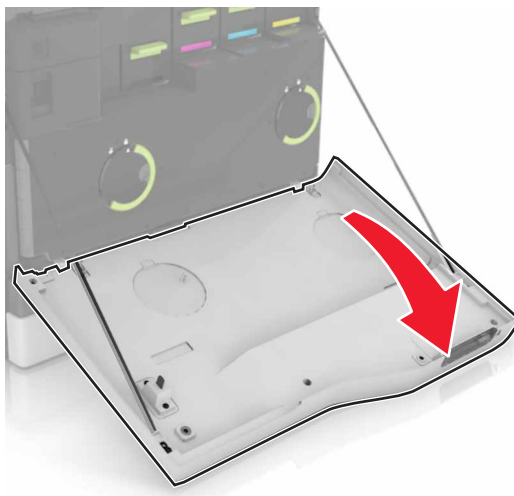

4 Remove the paper bail.

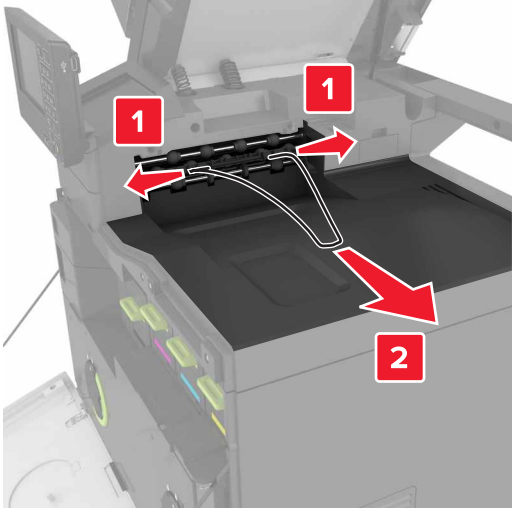

5 Remove the standard bin insert.

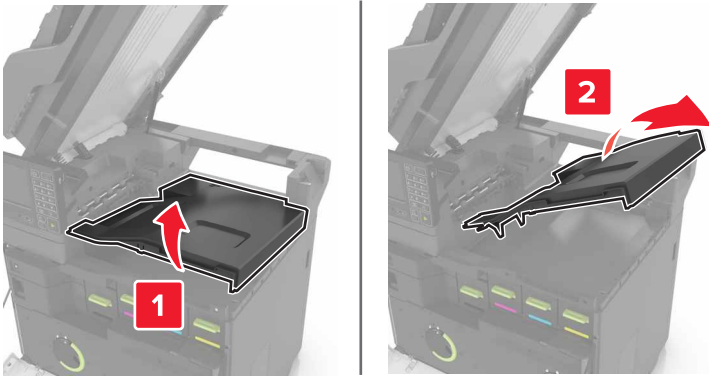

- 6 Remove the staple finisher connector cover.

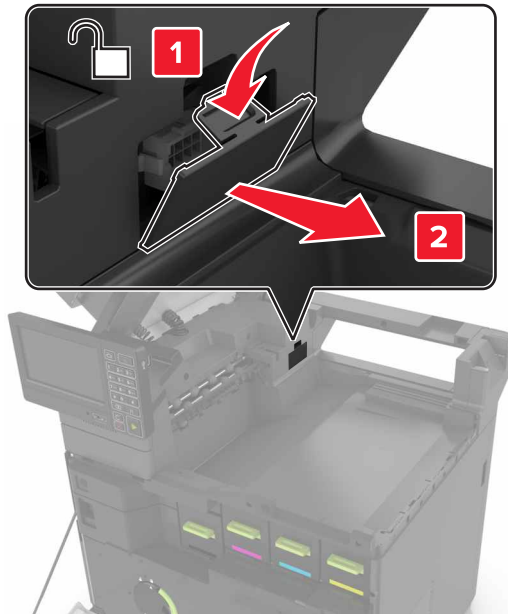

- 7 Unpack the staple finisher, and then remove the packing material.

- 8 Insert the staple finisher until it *clicks* into place.

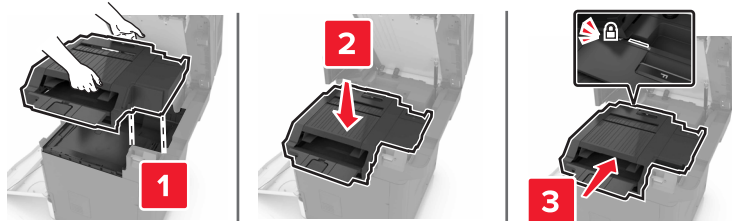

- 9 Close doors A and C.

 **CAUTION—PINCH HAZARD:** To avoid the risk of a pinch injury, keep hands clear of the labeled area when closing door C.

- 10 Turn on the printer.

Installing the keyboard tray

- 1 Turn off the printer.
- 2 Open door A.

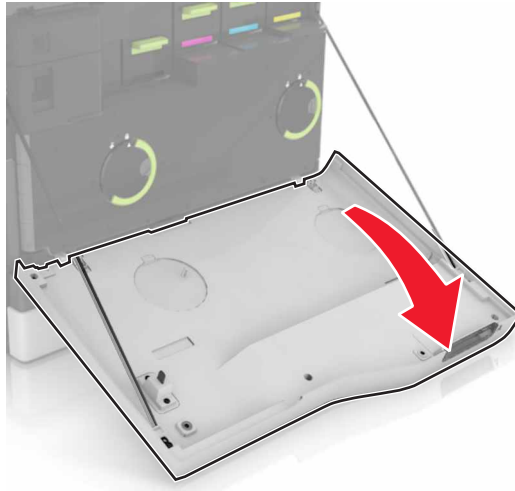

- 3 Remove the keyboard attach cover.

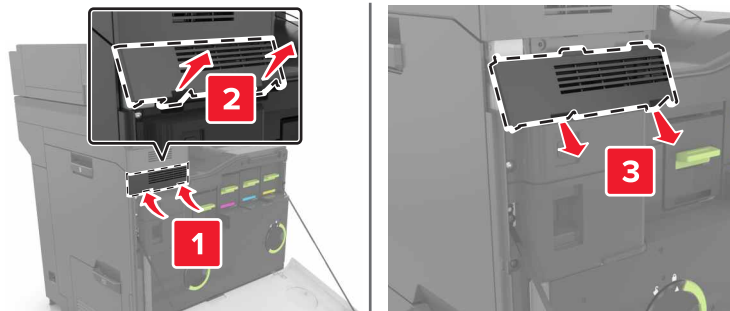

- 4 Unpack the keyboard tray.

5 Attach the keyboard to the base.

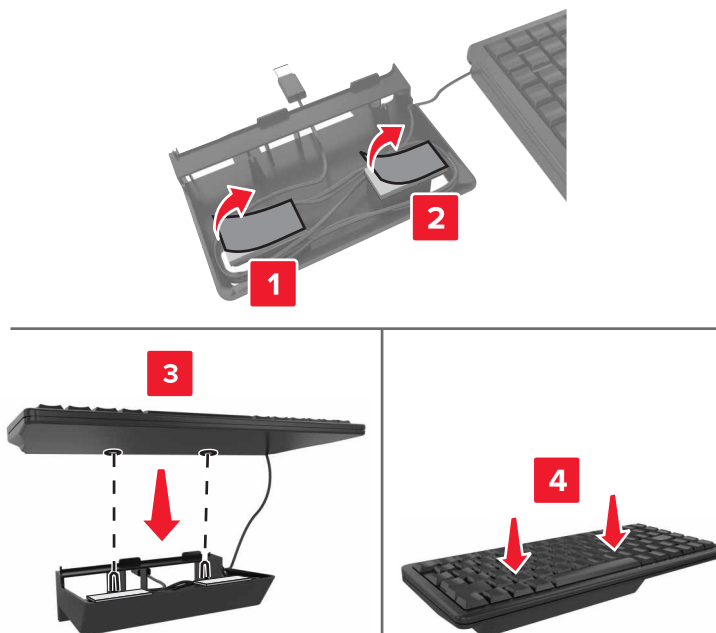

6 Insert the keyboard tray.

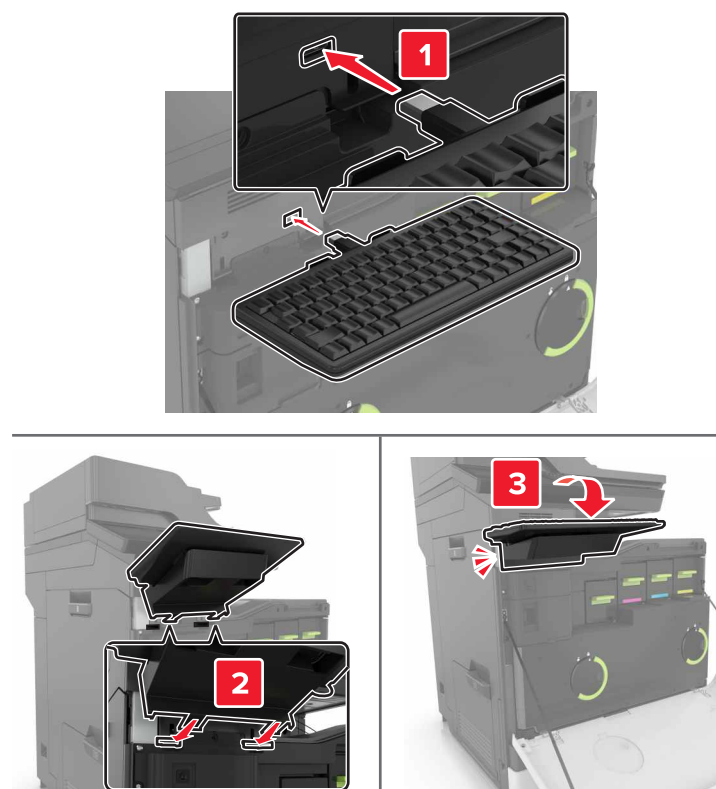

7 Close door A.

8 Turn on the printer.

Software

Installing the printer software

Notes:

- The print driver is included in the software installer package.
 - For Macintosh computers with macOS version 10.7 or later, you do not need to install the driver to print on an AirPrint-certified printer.
- 1 Obtain a copy of the software installer package.
 - From the software CD that came with your printer.
 - Go to <http://support.lexmark.com>, and then select your printer and operating system.
 - 2 Run the installer, and then follow the instructions on the computer screen.

Adding available options in the print driver

For Windows users

- 1 Open the printers folder.
- 2 Select the printer you want to update, and then do either of the following:
 - For Windows 7 or later, select **Printer properties**.
 - For earlier versions, select **Properties**.
- 3 Navigate to the Configuration tab, and then select **Update Now - Ask Printer**.
- 4 Apply the changes.

For Macintosh users

- 1 From System Preferences in the Apple menu, navigate to your printer, and then select **Options & Supplies**.
- 2 Navigate to the list of hardware options, and then add any installed options.
- 3 Apply the changes.

Firmware

Exporting or importing a configuration file

You can export the configuration settings of your printer into a text file, and then import the file to apply the settings to other printers.

- 1 Open a web browser, and then type the printer IP address in the address field.

Notes:

- View the printer IP address on the printer home screen. The IP address appears as four sets of numbers separated by periods, such as 123.123.123.123.

- If you are using a proxy server, then temporarily disable it to load the web page correctly.
- 2** From the Embedded Web Server, click **Export Configuration** or **Import Configuration**.
 - 3** Follow the instructions on the screen.
 - 4** If the printer supports applications, then do the following:
 - a** Click **Apps** > select the application > **Configure**.
 - b** Click **Export** or **Import**.

Updating firmware

Some applications require a minimum device firmware level to operate correctly.

For more information on updating the device firmware, contact your Lexmark representative.

- 1** Open a web browser, and then type the printer IP address in the address field.

Notes:

- View the printer IP address on the printer home screen. The IP address appears as four sets of numbers separated by periods, such as 123.123.123.123.
 - If you are using a proxy server, then temporarily disable it to load the web page correctly.
- 2** Click **Settings** > **Device** > **Update Firmware**.
 - 3** Browse to the flash file.
 - 4** Click **Upload**.

Notices

Product information

Product name:

Lexmark CX820de, CX820dtfe, CX827de, XC6152de, XC6152dtfe, XC6153, XC6153de MFPs

Machine type:

7563

Model(s):

136, 137

Edition notice

September 2022

The following paragraph does not apply to any country where such provisions are inconsistent with local law: LEXMARK INTERNATIONAL, INC., PROVIDES THIS PUBLICATION "AS IS" WITHOUT WARRANTY OF ANY KIND, EITHER EXPRESS OR IMPLIED, INCLUDING, BUT NOT LIMITED TO, THE IMPLIED WARRANTIES OF MERCHANTABILITY OR FITNESS FOR A PARTICULAR PURPOSE. Some states do not allow disclaimer of express or implied warranties in certain transactions; therefore, this statement may not apply to you.

This publication could include technical inaccuracies or typographical errors. Changes are periodically made to the information herein; these changes will be incorporated in later editions. Improvements or changes in the products or the programs described may be made at any time.

References in this publication to products, programs, or services do not imply that the manufacturer intends to make these available in all countries in which it operates. Any reference to a product, program, or service is not intended to state or imply that only that product, program, or service may be used. Any functionally equivalent product, program, or service that does not infringe any existing intellectual property right may be used instead. Evaluation and verification of operation in conjunction with other products, programs, or services, except those expressly designated by the manufacturer, are the user's responsibility.

For Lexmark technical support, go to <http://support.lexmark.com>.

For information on Lexmark's privacy policy governing the use of this product, go to www.lexmark.com/privacy.

For information on supplies and downloads, go to www.lexmark.com.

© 2016 Lexmark International, Inc.

All rights reserved.

GOVERNMENT END USERS

The Software Program and any related documentation are "Commercial Items," as that term is defined in 48 C.F.R. 2.101, "Computer Software" and "Commercial Computer Software Documentation," as such terms are used in 48 C.F.R. 12.212 or 48 C.F.R. 227.7202, as applicable. Consistent with 48 C.F.R. 12.212 or 48 C.F.R. 227.7202-1 through 227.7207-4, as applicable, the Commercial Computer Software and Commercial Software

Documentation are licensed to the U.S. Government end users (a) only as Commercial Items and (b) with only those rights as are granted to all other end users pursuant to the terms and conditions herein.

Trademarks

Lexmark and the Lexmark logo are trademarks or registered trademarks of Lexmark International, Inc. in the United States and/or other countries.

Google Cloud Print, Google Chrome, Android, and Google Play are trademarks of Google LLC.

Macintosh, App Store, Safari, and AirPrint are trademarks of Apple Inc., registered in the U.S. and other countries. Use of the Works with Apple badge means that an accessory has been designed to work specifically with the technology identified in the badge and has been certified by the developer to meet Apple performance standards.

The Mopria® word mark is a registered and/or unregistered trademark of Mopria Alliance, Inc. in the United States and other countries. Unauthorized use is strictly prohibited.

PCL® is a registered trademark of the Hewlett-Packard Company. PCL is Hewlett-Packard Company's designation of a set of printer commands (language) and functions included in its printer products. This printer is intended to be compatible with the PCL language. This means the printer recognizes PCL commands used in various application programs, and that the printer emulates the functions corresponding to the commands.

PostScript is a registered trademark of Adobe Systems Incorporated in the United States and/or other countries.

Wi-Fi® and Wi-Fi Direct® are registered trademarks of Wi-Fi Alliance®.

All other trademarks are the property of their respective owners.

Licensing notices

All licensing notices associated with this product can be viewed from the CD:\NOTICES directory of the installation software CD.

Noise emission levels

The following measurements were made in accordance with ISO 7779 and reported in conformance with ISO 9296.

Note: Some modes may not apply to your product.

1-meter average sound pressure, dBA	
Printing	One-sided: 54 (mono), 55 (color); Two-sided: 56 (mono), 56 (color)
Scanning	54 (mono); 55 (color)
Copying	57 (mono); 58 (color)
Ready	15

Values are subject to change. See www.lexmark.com for current values.

Waste from Electrical and Electronic Equipment (WEEE) directive

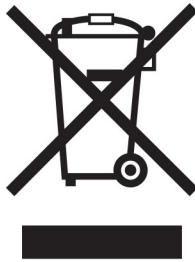

The WEEE logo signifies specific recycling programs and procedures for electronic products in countries of the European Union. We encourage the recycling of our products.

If you have further questions about recycling options, visit the Lexmark Web site at www.lexmark.com for your local sales office phone number.

India E-Waste notice

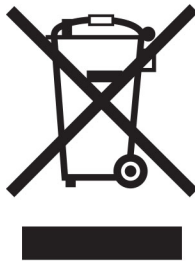

This product complies with the India E-Waste (Management and Handling) Rules, 2011, which prohibit use of lead, mercury, hexavalent chromium, polybrominated biphenyls, or polybrominated diphenyl ethers in concentrations exceeding 0.1% by weight and 0.01% by weight for cadmium, except for the exemption set in Schedule II of the Rules.

Product disposal

Do not dispose of the printer or supplies in the same manner as normal household waste. Consult your local authorities for disposal and recycling options.

Returning Lexmark cartridges for reuse or recycling

The Lexmark Cartridge Collection Program allows you to return used cartridges for free to Lexmark for reuse or recycling. One hundred percent of the empty cartridges returned to Lexmark are either reused or demanufactured for recycling. The boxes used to return the cartridges are also recycled.

To return Lexmark cartridges for reuse or recycling, do the following:

- 1 Go to www.lexmark.com/recycle.
- 2 Select the product that you want to recycle.

Static sensitivity notice

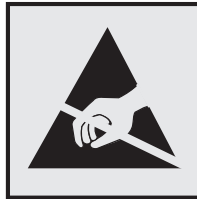

This symbol identifies static-sensitive parts. Do not touch the areas near these symbols without first touching a metal surface in an area away from the symbol.

To prevent damage from electrostatic discharge when performing maintenance tasks such as clearing paper jams or replacing supplies, touch any exposed metal frame of the printer before accessing or touching interior areas of the printer even if the symbol is not present.

ENERGY STAR

Any Lexmark product bearing the ENERGY STAR® emblem on the product or on a start-up screen is certified to comply with Environmental Protection Agency (EPA) ENERGY STAR requirements as of the date of manufacture.



Temperature information

Operating temperature and relative humidity	10 to 32.2°C (50 to 90°F) and 15 to 80% RH
Printer / cartridge / imaging unit long-term storage ¹	15.3 to 32.2°C (60 to 90°F) and 8 to 15% RH Maximum wet bulb temperature: 22.8°C (73°F)
Printer / cartridge / imaging unit short-term shipping	-10 to 40°C (14 to 104°F)
¹ Supplies shelf life is approximately 2 years. This is based on storage in a standard office environment at 22°C (72°F) and 45% humidity. ² Wet-bulb temperature is determined by the air temperature and the relative humidity.	

Laser notice

The printer is certified in the U.S. to conform to the requirements of DHHS 21 CFR, Chapter I, Subchapter J for Class I (1) laser products, and elsewhere is certified as a Class I laser product conforming to the requirements of IEC 60825-1: 2014.

Class I laser products are not considered to be hazardous. The laser system and printer are designed so there is never any human access to laser radiation above a Class I level during normal operation, user maintenance,

or prescribed service conditions. The printer has a non-serviceable printhead assembly that contains a laser with the following specifications:

Class: IIIb (3b) AlGaAs

Nominal output power (milliwatts): 20

Wavelength (nanometers): 755–800

Power consumption

Product power consumption

The following table documents the power consumption characteristics of the product.

Note: Some modes may not apply to your product.

Mode	Description	Power consumption (Watts)
Printing	The product is generating hard-copy output from electronic inputs.	760 (one-sided); 740 (two-sided)
Copy	The product is generating hard-copy output from hard-copy original documents.	870
Scan	The product is scanning hard-copy documents.	115
Ready	The product is waiting for a print job.	80 (higher power usage); 70 (lower power usage)
Sleep Mode	The product is in a high-level energy-saving mode.	1.46
Hibernate	The product is in a low-level energy-saving mode.	0.3
Off	The product is plugged into an electrical outlet, but the power switch is turned off.	0.2

The power consumption levels listed in the previous table represent time-averaged measurements. Instantaneous power draws may be substantially higher than the average.

Values are subject to change. See www.lexmark.com for current values.

Sleep Mode

This product is designed with an energy-saving mode called *Sleep Mode*. The Sleep Mode saves energy by lowering power consumption during extended periods of inactivity. The Sleep Mode is automatically engaged after this product is not used for a specified period of time, called the *Sleep Mode Timeout*.

Factory default Sleep Mode Timeout for this product (in minutes):	1
---	---

By using the configuration menus, the Sleep Mode Timeout can be modified between 1 minute and 120 minutes. If the print speed is less than or equal to 30 pages per minute, then you can set the timeout only up to 60 minutes. Setting the Sleep Mode Timeout to a low value reduces energy consumption, but may increase the response time of the product. Setting the Sleep Mode Timeout to a high value maintains a fast response, but uses more energy.

Hibernate Mode

This product is designed with an ultra-low power operating mode called *Hibernate mode*. When operating in Hibernate Mode, all other systems and devices are powered down safely.

The Hibernate mode can be entered in any of the following methods:

- Using the Hibernate Timeout
- Using the Schedule Power modes

Factory default Hibernate Timeout for this product in all countries or regions	3 days
--	--------

The amount of time the printer waits after a job is printed before it enters Hibernate mode can be modified between one hour and one month.

Off mode

If this product has an off mode which still consumes a small amount of power, then to completely stop product power consumption, disconnect the power supply cord from the electrical outlet.

Total energy usage

It is sometimes helpful to estimate the total product energy usage. Since power consumption claims are provided in power units of Watts, the power consumption should be multiplied by the time the product spends in each mode in order to calculate energy usage. The total product energy usage is the sum of each mode's energy usage.

Applicability of Regulation (EU) 2019/2015 and (EU) 2019/2020

Per Commission Regulation (EU) 2019/2015 and (EU) 2019/2020, the light source contained within this product or its component is intended to be used for Image Capture or Image Projection only, and is not intended for use in other applications.

Regulatory notices for telecommunication terminal equipment

This section contains regulatory information pertaining to products that contain the analog facsimile card:

Lexmark Regulatory Type/Model Number:

LEX-M03-002

Notice to users of the US telephone network: FCC requirements

This equipment complies with Part 68 of the FCC rules and the requirements adopted by the Administrative Council for Terminal Attachments (ACTA). On the back of this equipment is a label that contains, among other information, a product identifier in the format US:AAAEQ##TXXXX. If requested, this number must be provided to your telephone company.

This equipment uses the RJ-11C Universal Service Order Code (USOC) jack.

A plug and jack used to connect this equipment to the premises' wiring and telephone network must comply with the applicable FCC Part 68 rules and requirements adopted by the ACTA. Use a compliant telephone cord

(RJ-11) that is 26 AWG or larger when connecting this product to the public switched telephone network. See your setup documentation for more information.

The Ringer Equivalence Number (REN) is used to determine the number of devices that may be connected to a telephone line. Excessive RENs on a telephone line may result in the devices not ringing in response to an incoming call. In most but not all areas, the sum of RENs should not exceed five (5.0). To be certain of the number of devices that may be connected to a line, as determined by the total RENs, contact your local telephone company. For products approved after July 23, 2001, the REN for this product is part of the product identifier that has the format US:AAAEQ##TXXXX. The digits represented by ## are the REN without a decimal point (for example, 03 is a REN of 0.3). For earlier products, the REN is shown separately on the label.

If this equipment causes harm to the telephone network, the telephone company will notify you in advance that temporary discontinuance of service may be required. If advance notice is not practical, the telephone company will notify the customer as soon as possible. You will also be advised of your right to file a complaint with the FCC.

The telephone company may make changes in its facilities, equipment, operations or procedures that could affect the operation of this equipment. If this happens, the telephone company will provide advance notice in order for you to make necessary modifications to maintain uninterrupted service.

If you experience trouble with this equipment, for repair or warranty information, contact Lexmark International, Inc. at www.lexmark.com or your Lexmark representative. If the equipment is causing harm to the telephone network, the telephone company may request that you disconnect the equipment until the problem is resolved.

This equipment contains no user serviceable parts. For repair and warranty information, contact Lexmark International, Inc. See the previous paragraph for contact information.

Connection to party line service is subject to state tariffs. Contact the state public utility commission, public service commission, or corporation commission for information.

If your home has specially wired alarm equipment connected to the telephone line, ensure the installation of this equipment does not disable your alarm equipment. If you have questions about what will disable alarm equipment, consult your telephone company or a qualified installer.

The Telephone Consumer Protection Act of 1991 makes it unlawful for any person to use a computer or other electronic device, including fax machines, to send any message unless said message clearly contains in a margin at the top or bottom of each transmitted page or on the first page of the transmission, the date and time it is sent and an identification of the business or other entity, or other individual sending the message, and the telephone number of the sending machine or such business, other entity, or individual. (The telephone number provided may not be a 900 number or any other number for which charges exceed local or long-distance transmission charges.)

See your user documentation in order to program this information into your fax machine.

Notice to users of the Canadian telephone network

This product meets the applicable Innovation, Science and Economic Development Canada technical specifications.

The Ringer Equivalence Number (REN) indicates the maximum number of devices allowed to be connected to a telephone interface. The termination of an interface may consist of any combination of devices subject only to the requirement that the sum of the RENs of all the devices not exceed five. The REN is located on the product label.

This equipment uses CA11A telephone jacks.

Avis réservé aux utilisateurs du réseau téléphonique du Canada

Ce produit est conforme aux spécifications techniques d'Innovation, Sciences et Développement économique Canada.

Le numéro REN (ringer equivalence number : numéro d'équivalence de sonnerie) indique le nombre maximum d'appareils pouvant être connectés à l'interface téléphonique. En bout de ligne, le nombre d'appareils qui peuvent être connectés n'est pas directement limité, mais la somme des REN de ces appareils ne doit pas dépasser cinq. Le numéro REN est indiqué sur l'étiquette produit.

Cet équipement utilise des prises de téléphone CA11A.

Notice to users of the New Zealand telephone network

The following are special conditions for the Facsimile User Instructions. The grant of a telepermit for any item of terminal equipment indicates only that Telecom has accepted that the item complies with minimum conditions for connection to its network. It indicates no endorsement of the product by Telecom, nor does it provide any sort of warranty. Above all, it provides no assurance that any item will work correctly in all respects with another item of telepermitted equipment of a different make or model, nor does it imply that any product is compatible with all of Telecom's network services.

This equipment shall not be set up to make automatic calls to the Telecom "111" Emergency Service.

This equipment may not provide for the effective hand-over of a call to another device connected to the same line.

This equipment should not be used under any circumstances that may constitute a nuisance to other Telecom customers.

This equipment is not capable, under all operating conditions, of correct operation at the higher speeds for which it is designed. Telecom will accept no responsibility should difficulties arise in such circumstances.

The decadic (or pulse) dialing on this device is unsuitable for use on the Telecom network in New Zealand.

For correct operation, the total of all the Ringer Equivalence Numbers (RENs) of all parallel devices connected to the same telephone line may not exceed 5. The REN of this device is located on the label.

This device uses an RJ-11C modular connector. Contact your point of purchase if a BT adapter is required. The Lexmark part number is 80D1873.

Some parameters required for compliance with Telecom's telepermit requirements are dependent on the equipment associated with this device. The associated equipment shall be set to operate within the following limits for compliance to Telecom's specifications:

- There shall be no more than 10 call attempts to the same number within any 30 minute period for any single manual call initiation, and
- The equipment shall go on-hook for a period of not less than 30 seconds between the end of one attempt and the beginning of the next call attempt.
- The equipment shall be set to ensure that automatic calls to different numbers are spaced such that there is not less than 5 seconds between the end of one call attempt and the beginning of another.

Japanese telecom notice

The installed optional modem is in compliance with Japanese Telecommunication Law and has been Certified by JATE, with the following Certification Number:

A11-0160001JP

	Lexmark International, Inc.
	LEX-M03-002
	A11-0160001JP

Using this product in Switzerland

This product requires a Swiss billing tone filter (Lexmark part number 80D1877) to be installed on any line which receives metering pulses in Switzerland.

Utilisation de ce produit en Suisse

Cet appareil nécessite l'utilisation d'un filtre de tonalité de facturation suisse (n° de référence Lexmark : 80D1877) devant être installé sur toute ligne recevant des impulsions de comptage en Suisse.

Verwendung dieses Produkts in der Schweiz

Für dieses Produkt muss ein schweizerischer Billing Tone Filter zur Zählzeichenübertragung (Lexmark Teilenummer 80D1877) für jede Leitung installiert werden, über die in der Schweiz Zeitsteuertakte übertragen werden.

Uso del prodotto in Svizzera

Questo prodotto richiede un filtro toni Billing svizzero, (codice Lexmark 80D1877) da installare su tutte le linee che ricevono impulsi remoti in Svizzera.

Regulatory notices for wireless products

This section contains regulatory information that applies only to wireless models.

If in doubt as to whether your model is a wireless model, go to <http://support.lexmark.com>.

Modular component notice

Wireless-equipped models contain the following modular component(s):

Lexmark Regulatory Type/LEX-M01-005; FCC ID: IYLLEXM01005; Industry Canada IC: 2376A-M01005

Exposure to radio frequency radiation

The radiated output power of this device is far below the radio frequency exposure limits of the FCC and other regulatory agencies. A minimum separation of 20 cm (8 inches) must be maintained between the antenna and any persons for this device to satisfy the RF exposure requirements of the FCC and other regulatory agencies.

European Community (EC) directives conformity

This product is in conformity with the protection requirements of EC Council directive 2014/53/EU on the approximation and harmonization of the laws of the Member States relating to radio equipment.

The manufacturer of this product is: Lexmark International, Inc., 740 West New Circle Road, Lexington, KY, 40550 USA. The authorized representative is: Lexmark International Technology Hungária Kft., 8 Lechner Ödön fasor, Millennium Tower III, 1095 Budapest HUNGARY. A declaration of conformity to the requirements of the Directives is available upon request from the Authorized Representative or may be obtained at www.lexmark.com/en_us/about/regulatory-compliance/european-union-declaration-of-conformity.html.

Compliance is indicated by the CE marking:



Restrictions

This radio equipment is restricted to indoor use only. Outdoor use is prohibited. This restriction applies to all the countries listed in the table below:

								
AT	BE	BG	CH	CY	CZ	DE	DK	EE
EL	ES	FI	FR	HR	HU	IE	IS	IT
LI	LT	LU	LV	MT	NL	NO	PL	PT
RO	SE	SI	SK	TR	UK			

EU and other countries statement of radio transmitter operational frequency bands and maximum RF power

This radio product transmits in either the 2.4GHz (2.412–2.472 GHz in the EU) or 5GHz (5.15–5.35, 5.47–5.725 in the EU) bands. The maximum transmitter EIRP power output, including antenna gain, is ≤ 20dBm for both bands.

Federal Communications Commission (FCC) compliance information statement

This product has been tested and found to comply with the limits for a Class A digital device, pursuant to Part 15 of the FCC Rules. Operation is subject to the following two conditions: (1) this device may not cause harmful interference, and (2) this device must accept any interference received, including interference that may cause undesired operation.

The FCC Class A limits are designed to provide reasonable protection against harmful interference when the equipment is operated in a commercial environment. This equipment generates, uses, and can radiate radio frequency energy and, if not installed and used in accordance with the instruction manual, may cause harmful interference to radio communications. Operation of this equipment in a residential area is likely to cause harmful interference, in which case the user will be required to correct the interference at his own expense.

The manufacturer is not responsible for any radio or television interference caused by using other than recommended cables or by unauthorized changes or modifications to this equipment. Unauthorized changes or modifications could void the user's authority to operate this equipment.

Note: To assure compliance with FCC regulations on electromagnetic interference for a Class A computing device, use a properly shielded and grounded cable such as Lexmark part number 1021231 for parallel attach or 1021294 for USB attach. Use of a substitute cable not properly shielded and grounded may result in a violation of FCC regulations.

Any questions regarding this compliance information statement should be directed to:

Director of Lexmark Technology & Services
Lexmark International, Inc.
740 West New Circle Road
Lexington, KY 40550
Telephone: (859) 232-2000
E-mail: regulatory@lexmark.com

Innovation, Science and Economic Development Canada compliance statement

This Class A digital apparatus meets all requirements of the Canadian Interference-Causing Equipment Standard ICES-003.

Avis de conformité aux normes de l'Innovation, Sciences et Développement économique Canada

Cet appareil numérique de classe A est conforme aux exigences de la norme canadienne relative aux équipements pouvant causer des interférences NMB-003.

Japanese VCCI notice

製品にこのラベルが表示されている場合、
次の要件を満たしています。

この装置は、クラス A 情報技術装置です。この装置を家庭環境で使用すると電波妨害を引き起こすことがあります。この場合には使用者が適切な対策を講ずるよう要求されることがあります。 VCCI-A

この装置は、クラスA情報技術装置です。この装置を家庭環境で使用すると電波妨害を引き起こすことがあります。この場合には使用者が適切な対策を講ずるよう要求されることがあります。 VCCI-A

Notice to users of Class A products in Brazil

Este produto não é apropriado para uso em ambientes domésticos, pois poderá causar interferências eletromagnéticas que obrigam o usuário a tomar medidas necessárias para minimizar estas interferências.

European Community (EC) directives conformity

This product is in conformity with the protection requirements of EC Council directives 2014/30/EU, 2014/35/EU, and 2011/65/EU as amended by (EU) 2015/863 on the approximation and harmonization of the laws of the Member States relating to electromagnetic compatibility, safety of electrical equipment designed for use within certain voltage limits, and on the restrictions of use of certain hazardous substances in electrical and electronic equipment.

The manufacturer of this product is: Lexmark International, Inc., 740 West New Circle Road, Lexington, KY, 40550 USA. The authorized representative is: Lexmark International Technology Hungária Kft., 8 Lechner Ödön fasor, Millennium Tower III, 1095 Budapest HUNGARY. A declaration of conformity to the requirements of the Directives is available upon request from the Authorized Representative or may be obtained at www.lexmark.com/en_us/about/regulatory-compliance/european-union-declaration-of-conformity.html.

This product satisfies the Class A limits of EN 55022 and EN55032 and safety requirements of EN 60950-1 or EN 62368-1.

Radio interference notice

Warning

This is a product that complies with the emission requirements of EN55022 and EN55032 Class A limits and immunity requirements of EN55024. This product is not intended to be used in residential/domestic environments.

This is a Class A product. In a domestic environment, this product may cause radio interference, in which case the user may be required to take adequate measures.

STATEMENT OF LIMITED WARRANTY FOR LEXMARK LASER PRINTERS, LEXMARK LED PRINTERS, AND LEXMARK MULTIFUNCTION LASER PRINTERS

Lexmark International, Inc., Lexington, KY

This limited warranty applies to the United States and Canada. For customers outside the U.S., refer to the country-specific warranty information that came with your product.

This limited warranty applies to this product only if it was originally purchased for your use, and not for resale, from Lexmark or a Lexmark Remarketer, referred to in this statement as “Remarketer.”

Limited warranty

Lexmark warrants that this product:

- Is manufactured from new parts, or new and serviceable used parts, which perform like new parts
- Is, during normal use, free from defects in material and workmanship

If this product does not function as warranted during the warranty period, contact a Remarketer or Lexmark for repair or replacement (at Lexmark's option).

If this product is a feature or option, this statement applies only when that feature or option is used with the product for which it was intended. To obtain warranty service, you may be required to present the feature or option with the product.

If you transfer this product to another user, warranty service under the terms of this statement is available to that user for the remainder of the warranty period. You should transfer proof of original purchase and this statement to that user.

Limited warranty service

The warranty period starts on the date of original purchase as shown on the purchase receipt and ends 12 months later provided that the warranty period for any supplies and for any maintenance items included with the printer shall end earlier if it, or its original contents, are substantially used up, depleted, or consumed. Fuser Units, Transfer/Transport Units, Paper Feed items, if any, and any other items for which a Maintenance Kit is available are substantially consumed when the printer displays a “Life Warning” or “Scheduled Maintenance” message for such item.

To obtain warranty service you may be required to present proof of original purchase. You may be required to deliver your product to the Remarketer or Lexmark, or ship it prepaid and suitably packaged to a Lexmark designated location. You are responsible for loss of, or damage to, a product in transit to the Remarketer or the Lexmark designated location.

When warranty service involves the exchange of a product or part, the item replaced becomes the property of the Remarketer or Lexmark. The replacement may be a new or repaired item.

The replacement item assumes the remaining warranty period of the original product.

Replacement is not available to you if the product you present for exchange is defaced, altered, in need of a repair not included in warranty service, damaged beyond repair, or if the product is not free of all legal obligations, restrictions, liens, and encumbrances.

As part of your warranty service and/or replacement, Lexmark may update the firmware in your printer to the latest version. Firmware updates may modify printer settings and cause counterfeit and/or unauthorized products, supplies, parts, materials (such as toners and inks), software, or interfaces to stop working. Authorized use of genuine Lexmark products will not be impacted.

Before you present this product for warranty service, remove all print cartridges, programs, data, and removable storage media (unless directed otherwise by Lexmark).

For further explanation of your warranty alternatives and the nearest Lexmark authorized servicer in your area contact Lexmark on the World Wide Web.

Remote technical support is provided for this product throughout its warranty period. For products no longer covered by a Lexmark warranty, technical support may not be available or only be available for a fee.

Extent of limited warranty

Lexmark does not warrant uninterrupted or error-free operation of any product or the durability or longevity of prints produced by any product.

Warranty service does not include repair of failures caused by:

- Modification or unauthorized attachments
- Accidents, misuse, abuse or use inconsistent with Lexmark user's guides, manuals, instructions or guidance
- Unsuitable physical or operating environment
- Maintenance by anyone other than Lexmark or a Lexmark authorized servicer
- Operation of a product beyond the limit of its duty cycle
- Use of printing media outside of Lexmark specifications
- Refurbishment, repair, refilling or remanufacture by a third party of products, supplies or parts
- Products, supplies, parts, materials (such as toners and inks), software, or interfaces not furnished by Lexmark

TO THE EXTENT PERMITTED BY APPLICABLE LAW, NEITHER LEXMARK NOR ITS THIRD PARTY SUPPLIERS OR REMARKETERS MAKE ANY OTHER WARRANTY OR CONDITION OF ANY KIND, WHETHER EXPRESS OR IMPLIED, WITH RESPECT TO THIS PRODUCT, AND SPECIFICALLY DISCLAIM THE IMPLIED WARRANTIES OR CONDITIONS OF MERCHANTABILITY, FITNESS FOR A PARTICULAR PURPOSE, AND SATISFACTORY QUALITY. ANY WARRANTIES THAT MAY NOT BE DISCLAIMED UNDER APPLICABLE LAW ARE LIMITED IN DURATION TO THE WARRANTY PERIOD. NO WARRANTIES, EXPRESS OR IMPLIED, WILL APPLY AFTER THIS PERIOD. ALL INFORMATION, SPECIFICATIONS, PRICES, AND SERVICES ARE SUBJECT TO CHANGE AT ANY TIME WITHOUT NOTICE.

Limitation of liability

Your sole remedy under this limited warranty is set forth in this document. For any claim concerning performance or nonperformance of Lexmark or a Remarketer for this product under this limited warranty, you may recover actual damages up to the limit set forth in the following paragraph.

Lexmark's liability for actual damages from any cause whatsoever will be limited to the amount you paid for the product that caused the damages. This limitation of liability will not apply to claims by you for bodily injury or damage to real property or tangible personal property for which Lexmark is legally liable. **IN NO EVENT WILL LEXMARK BE LIABLE FOR ANY LOST PROFITS, LOST SAVINGS, INCIDENTAL DAMAGE, OR OTHER ECONOMIC OR CONSEQUENTIAL DAMAGES.** This is true even if you advise Lexmark or a Remarketer of the possibility of such damages. Lexmark is not liable for any claim by you based on a third party claim.

This limitation of remedies also applies to claims against any Suppliers and Remarketers of Lexmark. Lexmark's and its Suppliers' and Remarketers' limitations of remedies are not cumulative. Such Suppliers and Remarketers are intended beneficiaries of this limitation.

Additional rights

Some states do not allow limitations on how long an implied warranty lasts, or do not allow the exclusion or limitation of incidental or consequential damages, so the limitations or exclusions contained above may not apply to you.

This limited warranty gives you specific legal rights. You may also have other rights that vary from state to state.

Index

A

- activating Voice Guidance 25
- adapter plug 56
- adding a shortcut
 - copy 47
- adding contacts 23
- adding groups 23
- adding hardware options
 - print driver 278
- adding internal options
 - print driver 278
- adding shortcut
 - e-mail 49
 - fax destination 60
 - FTP address 62
- ADF feed roller
 - replacing 192
- ADF pick roller
 - replacing 190
- ADF registration
 - adjusting 260
- ADF separator roller
 - replacing 194
- adjusting
 - scanner registration 260
 - adjusting ADF registration 260
 - adjusting darkness
 - fax 61
 - adjusting default volume
 - speaker 155
 - adjusting speech rate
 - Voice Guidance 25
 - adjusting the brightness
 - printer display 202
 - adjusting the brightness of the printer display 202
 - adjusting the default headphones volume 156
 - adjusting toner darkness 251
- AirPrint
 - using 39
- Android device
 - printing from 38
- answering machine
 - setting up 51
- applications, supported 18
- assigning printer to a ring pattern 59

- attaching cables 13
- automatic document feeder (ADF)
 - using 45, 48, 59, 62
- available internal options 262
- avoiding paper jams 203

B

- blocking junk faxes 61
- bookmarks
 - creating 22
 - creating folders for 22

C

- can send but not receive faxes 256
- canceling a print job
 - from the computer 44
 - from the printer control panel 44
- cannot open Embedded Web Server 219
- cannot receive faxes 256
- Card Copy
 - setting up 19
- card stock
 - loading 29
- changing resolution
 - fax 61
- changing the printer port settings
 - after installing ISP 158
- checking the printer connectivity 220
- checking the status of parts and supplies 164
- cleaning
 - exterior of the printer 159
 - interior of the printer 159
 - scanner 159
- cleaning the printer 159
- Cleaning the Scanner 151
- Cloud Connector profile
 - creating 21
 - printing from 43
 - scanning to 64
- collated printing does not work 225
- collating copies 46
- color correction 252
- color quality, troubleshooting
 - print appears tinted 253
- confidential documents do not print 228
- confidential print jobs 42
 - printing from a Macintosh computer 42
 - printing from Windows 42
- configuring daylight saving time 59
- configuring supply notifications 167
- configuring the settings
 - fax speaker 156
- configuring the SMTP server 48
- configuring the SMTP server for fax 50
- connecting a mobile device to the printer wireless network 157
- connecting printer to distinctive ring service 59
- connecting to a wireless network
 - using PIN method 156
 - using Push Button method 156
- conserving supplies 202
- contacting customer support 261
- contacts
 - adding 23
 - deleting 24
 - editing 23
- control panel
 - using 15
- copy troubleshooting
 - partial copies of documents or photos 258
 - poor copy quality 258
 - scanner does not respond 260
- copying
 - on both sides of the paper 46
 - on letterhead 46
 - photos 45
 - using the automatic document feeder (ADF) 45
 - using the scanner glass 45
- copying different paper sizes 45

- copying from
 - selected tray 45
- copying multiple pages
 - onto a single sheet 47
- creating a Cloud Connector profile 21
- creating a shortcut
 - copy 47
 - network folder 62
- creating bookmarks 22
- creating folders
 - for bookmarks 22
- creating shortcut
 - e-mail 49
 - fax destination 60
 - FTP address 62
- crooked print 242
- Customer Support
 - using 21
- customer support
 - contacting 261
- D**
- dark print 235
- date and time
 - fax settings 59
- daylight saving time
 - configuring 59
- deactivating the Wi-Fi network 158
- default headphones volume
 - adjusting 156
- default speaker volume
 - adjusting 155
- Defective flash detected 223
- deleting contacts 24
- deleting groups 24
- developer and PC unit combo pack
 - ordering 166
- developer unit
 - ordering 166
 - replacing 168
- Device Quotas
 - setting up 20
- different paper sizes, copying 45
- directory list
 - printing 44
- distinctive ring service, fax
 - enabling 59
- documents
 - scanning to a fax server 64
- documents, printing
 - from a computer 38
 - from a mobile device 38
- E**
- Eco-Settings
 - configuring 21
- editing contacts 23
- editing groups 23
- emission notices 281, 289, 291
- enabling Magnification mode 25
- enabling personal identification numbers 25
- enabling spoken passwords 25
- enabling the USB port 220
- enabling Wi-Fi Direct 157
- encrypting
 - printer hard disk 153
- enlarging copies 46
- envelopes
 - loading 29
- environmental settings 201
- erasing
 - printer memory 152
- erasing hard disk memory 152
- erasing printer memory 153
- Ethernet port 13
- exporting a configuration file
 - using the Embedded Web Server 278
- EXT port 13
- e-mail alerts
 - setting up 155
- e-mail server
 - setting up 48
- e-mail shortcut
 - creating 49
- e-mailing
 - using a shortcut number 49
 - using the address book 49
 - using the automatic document feeder (ADF) 48
 - using the printer 49
 - using the scanner glass 48
- F**
- factory default settings
 - restoring 153
- FAQ about color printing 252
- fax
 - configuring the SMTP server 50
 - forwarding 61
 - holding 61
 - setting the schedule to send 60
- fax darkness
 - adjusting 61
- fax destination shortcut
 - creating 60
- fax log
 - viewing 61
- fax resolution
 - changing 61
- fax setup
 - country- or region-specific 56
 - standard telephone line connection 51
- fax speaker
 - configuring the settings 156
- fax troubleshooting
 - caller ID is not shown 254
 - cannot receive faxes 256
 - cannot send faxes 256
 - cannot send or receive faxes 254
 - poor print quality 257
- faxing
 - setting the date and time 59
 - using the automatic document feeder (ADF) 59
 - using the scanner glass 59
- FCC notices 289
- finding more information about the printer 10
- firmware card 262
- firmware, updating 279
- flash drive
 - printing from 40
 - scanning to 63
- font sample list
 - printing 43
- forms
 - printing 38
- Forms and Favorites
 - setting up 18
- FTP address
 - creating shortcut 62
- FTP server, scanning to
 - using the control panel 62
- fuser
 - replacing 170

G

ghost images appear on prints 236
Google Cloud Print
 using 38
gray or colored background 237
groups
 adding 23
 deleting 24
 editing 23

H

hard disk memory
 erasing 152
hardware options
 installing 271
hardware options, adding
 print driver 278
headphones
 default volume 156
held documents do not print 228
held jobs 42
 printing from a Macintosh
 computer 42
 printing from Windows 42
Hibernate mode
 configuring 201
holding faxes 61
home screen
 customizing 18
home screen icons
 displaying 18
 using 16
horizontal dark lines 245
horizontal white lines 248
humidity around the printer 283

I

icons on the home screen
 showing 18
imaging unit
 replacing 175
importing a configuration file
 using the Embedded Web
 Server 278
incorrect margins 238
indicator light
 printer status 16
installing a memory card 262
installing a printer hard disk 268

installing an internal solutions
port 263
installing an optional card 267
installing optional trays 271
installing options
 internal solutions port 263
 printer hard disk 268
installing the keyboard tray 276
installing the print driver 278
installing the printer
software 278
installing the staple finisher 273
internal option is not
detected 221
internal options 262
 installing 267
 memory card 262
internal options, adding
 print driver 278
internal solutions port
 installing 263
 troubleshooting 222

J

jam locations
 identifying 204
jam, clearing
 automatic document
 feeder 207
 duplex unit 210
 finisher bin 213
 fuser 210
 multipurpose feeder 206
 standard bin 209
 staple cartridge 215
 trays 205
jams
 avoiding 203
junk faxes
 blocking 61

K

keyboard on the display
 using 26
keyboard tray
 installing 276

L

letterhead
 copying on 46

Lexmark Mobile Print
 using 38
LINE port 13
linking trays 30
loading
 card stock 29
 envelopes 27
 transparencies 29
 trays 27
loading envelopes
 multipurpose feeder 29
loading paper
 multipurpose feeder 29
locating jam areas 204
locating the security slot 152

M

Magnification mode
 enabling 25
making copies 45
manual color correction 252
memory card 262
 installing 262
menu
 802.1x 137
 About this Printer 82
 Accessibility 75
 Bin Configuration 96
 Confidential Print Setup 146
 Configuration Menu 77
 Copy Defaults 96
 Custom Scan Sizes 95
 Device 149
 Disk Encryption 147
 Eco-Mode 69
 Erase Temporary Data Files 148
 Ethernet 132
 E-mail Defaults 115
 E-mail Setup 114
 Fax 150
 Fax Mode 101
 Fax Server Setup 111
 Fax Setup 101
 Finishing 85
 Flash Drive Print 128
 Flash Drive Scan 124
 FTP Defaults 120
 Google Cloud Print 140
 Help 150
 HTML 92
 HTTP/FTP Settings 138
 Image 93

- Information Sent to Lexmark 75
 - IPSec 136
 - Job Accounting 88
 - Layout 83
 - Local Accounts 143
 - Login Restrictions 146
 - LPD Configuration 137
 - Manage Permissions 142
 - Media Types 95
 - Menu Settings Page 149
 - Miscellaneous 148
 - Network 150
 - Network Overview 130
 - Notifications 70
 - Out of Service Erase 82
 - PCL 91
 - PDF 89
 - PostScript 90
 - Power Management 74
 - Preferences 67
 - Print 149
 - Quality 86
 - Remote Operator Panel 70
 - Restore Factory Defaults 76
 - Restrict external network
 - access 140
 - Schedule USB Devices 143
 - Security Audit Log 144
 - Setup 85
 - Shortcuts 150
 - SNMP 135
 - Solutions LDAP Settings 148
 - TCP/IP 133
 - ThinPrint 139
 - Tray Configuration 93
 - Troubleshooting 151
 - Universal Setup 94
 - USB 139
 - Visible Home Screen Icons 82
 - Web Link Setup 120
 - Wireless 131
 - Wi-Fi Direct 141
 - XPS 89
 - menu map 66
 - Menu Settings Page
 - printing 151
 - mobile device
 - printing from 38, 39, 40
 - modifying color output 252
 - Mopria Print Service 39
 - moving the printer 11, 200
 - multipurpose feeder
 - loading 29
- N**
- navigating the screen
 - using gestures 26
 - navigating the screen using gestures 26
 - network folder
 - creating a shortcut 62
 - noise emission levels 281
 - nonvolatile memory
 - erasing 152
 - Non-Lexmark supply 224
 - non-volatile memory 153
 - Not enough free space in flash memory for resources 223
 - notices 281, 282, 284, 285, 288, 289, 291
- O**
- optional card
 - installing 267
 - optional trays
 - installing 271
 - options
 - firmware cards 262
 - memory card 262
 - wireless 262
 - ordering
 - developer and PC unit combo pack 166
 - developer unit 166
 - photoconductor unit 166
 - ordering supplies
 - staple cartridges 167
 - waste toner bottle 167
 - ordering toner cartridges 164
- P**
- paper
 - Universal size setting 27
 - paper jam in door B 210
 - paper jam in the automatic document feeder 207
 - paper jam in the finisher bin 213
 - paper jam in the multipurpose feeder 206
 - paper jam in the standard bin 209
 - paper jam in trays 205
 - paper jam, clearing
 - automatic document feeder 207
 - duplex unit 210
 - finisher bin 213
 - fuser 210
 - multipurpose feeder 206
 - standard bin 209
 - trays 205
 - paper jams
 - avoiding 203
 - location 204
 - paper size
 - setting 27
 - paper sizes
 - supported 31
 - paper type
 - setting 27
 - paper types
 - supported 34
 - parallel interface card
 - troubleshooting 222
 - parts status
 - checking 164
 - personal identification number
 - method 156
 - personal identification numbers
 - enabling 25
 - photoconductor unit
 - ordering 166
 - replacing 172
 - photos, copying 45
 - pick roller
 - replacing 178
 - placing separator sheets
 - between copies
 - copying 46
 - poor fax print quality 257
 - power button light
 - printer status 16
 - power cord socket 13
 - power save modes
 - configuring 201
 - print appears tinted 253
 - print driver
 - hardware options, adding 278
 - installing 278
 - print job
 - canceling from the computer 44
 - canceling from the printer control panel 44

- print jobs not printed 231
 - print quality
 - cleaning the scanner 159
 - Print Quality Test Pages 151
 - print quality troubleshooting
 - blank or white pages 234
 - crooked print 242
 - dark print 235
 - ghost images appear on prints 236
 - gray or colored background 237
 - horizontal dark lines 245
 - horizontal white lines 248
 - light print 239
 - mottled print and dots 241
 - paper curl 226
 - repeating print defects 250
 - skewed print 242
 - solid color or black images 242
 - text or images cut off 243
 - toner easily rubs off 244
 - uneven print density 245
 - vertical dark lines appear on prints 247
 - vertical white lines 249
 - print troubleshooting
 - collated printing does not work 225
 - confidential and other held documents do not print 228
 - envelope seals when printing 225
 - incorrect margins 238
 - jammed pages are not reprinted 228
 - job prints from the wrong tray 233
 - job prints on the wrong paper 233
 - paper frequently jams 227
 - print jobs do not print 231
 - slow printing 230
 - tray linking does not work 227
 - unable to read flash drive 220
 - printer
 - fully configured 12
 - minimum clearances 11
 - moving 11
 - selecting a location 11
 - shipping 201
 - printer configurations 12
 - printer display
 - adjusting the brightness 202
 - printer hard disk
 - encrypting 153
 - printer hard disk memory 153
 - printer information
 - finding 10
 - printer is not responding 232
 - printer memory
 - erasing 152
 - printer menus 66
 - printer messages
 - Defective flash detected 223
 - Non-Lexmark supply 224
 - Not enough free space in flash memory for resources 223
 - Replace cartridge, printer region mismatch 223
 - Scanner maintenance required, use ADF Kit 224
 - Unformatted flash detected 223
 - printer options troubleshooting
 - cannot detect internal option 221
 - internal solutions port 222
 - parallel interface card 222
 - serial interface card 222
 - printer port settings
 - changing 158
 - printer ports 13
 - printer settings
 - restoring factory default 153
 - printer software
 - installing 278
 - printer wireless network
 - connecting a mobile device to 157
 - printing
 - directory list 44
 - font sample list 43
 - from a Cloud Connector profile 43
 - from a computer 38
 - from a flash drive 40
 - from a mobile device 38, 39, 40
 - from an Android device 38
 - Menu Settings Page 151
 - using Google Cloud Print 38
 - using Mopria Print Service 39
 - using Wi-Fi Direct 40
 - printing a directory list 44
 - printing a font sample list 43
 - printing a network setup page 220
 - printing confidential and other held jobs
 - from a Macintosh computer 42
 - from Windows 42
 - printing forms 38
 - printing from a computer 38
 - printing from a flash drive 40
 - Push Button method 156
- Q**
- QR codes
 - adding 20
- R**
- received fax
 - forwarding 61
 - received faxes
 - holding 61
 - recycling
 - Lexmark packaging 202
 - Lexmark products 202
 - reducing copies 46
 - repeat print jobs 42
 - printing from a Macintosh computer 42
 - printing from Windows 42
 - repeating print defects 250
 - Replace cartridge, printer region mismatch 223
 - replacing
 - transfer belt 185
 - replacing a developer unit 168
 - replacing a photoconductor unit 172
 - replacing a toner cartridge 177
 - replacing an imaging unit 175
 - replacing parts
 - ADF feed roller 192
 - ADF pick roller 190
 - ADF separator roller 194
 - pick roller 178
 - separator pad 183
 - replacing supplies
 - staple cartridge 195
 - staple cartridge holder 197
 - waste toner bottle 184
 - replacing the ADF feed roller 192
 - replacing the ADF pick roller 190

- replacing the ADF separator roller 194
- replacing the fuser 170
- replacing the pick roller 178
- replacing the separator pad 183
- replacing the staple cartridge holder in the staple finisher 197
- replacing the staple cartridge in the staple finisher 195
- replacing the transfer belt 185
- replacing the waste toner bottle 184
- replacing transfer roller 188
- reports
 - printer status 155
 - printer usage 155
- reserve print jobs
 - printing from a Macintosh computer 42
 - printing from Windows 42
- resetting
 - supply usage counters 224
- resetting the supply usage counters 224
- RJ11 adapter 56

S

- safety information 8, 9
- saving paper 47
- saving toner 47
- Scan Center
 - setting up 19
- Scan to Computer
 - setting up 64
- scan troubleshooting
 - cannot scan from a computer 257
 - partial copies of documents or photos 258
 - poor copy quality 258
 - scan job was not successful 259
 - scanner does not respond 260
 - scanning freezes the computer 259
 - scanning takes too long 259
- scanner
 - cleaning 159
- scanner does not close 259
- scanner glass
 - using 45, 48, 59, 62

- Scanner maintenance required, use ADF Kit 224
- scanning
 - to a Cloud Connector profile 64
 - to an FTP server 62
 - using the automatic document feeder (ADF) 62
 - using the scanner glass 62
- scanning to a computer 64
- scanning to a fax server 64
- scanning to a flash drive 63
- scanning to an FTP server
 - using the control panel 62
- scheduling a fax 60
- securing printer memory 153
- security slot
 - locating 152
- selecting a location for the printer 11
- sending a fax
 - using the computer 59
 - using the control panel 59
- sending an e-mail 49
- separator pad
 - replacing 183
- serial interface card
 - troubleshooting 222
- serial printing
 - setting up 158
- setting the paper size 27
- setting the paper type 27
- setting the Universal paper size 27
- setting up Device Quotas 20
- setting up e-mail alerts 155
- setting up fax
 - country- or region-specific 56
 - standard telephone line connection 51
- setting up serial printing 158
- shipping the printer 201
- Shortcut Center
 - using 19
- shortcut, creating
 - e-mail 49
 - fax destination 60
 - FTP address 62
- shortcut, creating a copy 47
- skewed print 242
- Sleep mode
 - configuring 201

- slow printing 230
- SMTP server for e-mail
 - configuring 48
- SMTP server for fax
 - configuring 50
- sorting multiple copies 46
- spoken passwords
 - enabling 25
- staple cartridge
 - replacing 195
- staple cartridge holder
 - replacing 197
- staple cartridges
 - ordering 167
- staple jam in door G 215
- staple jam, clearing
 - door G 215
- statement of volatility 153
- storing
 - supplies 200
- storing print jobs 42
- supplies
 - conserving 202
 - storing 200
- supplies status
 - checking 164
- supplies, ordering
 - developer unit 166
 - photoconductor unit 166
 - staple cartridges 167
 - toner cartridges 164
 - waste toner bottle 167
- supply notifications
 - configuring 167
- supply usage counters
 - resetting 224
- supported applications 18
- supported file types 41
- supported flash drives 41
- supported paper sizes 31
- supported paper types 34
- supported paper weights 36

T

- temperature around the printer 283
- text or images cut off 243
- toner cartridge
 - replacing 177
- toner cartridges
 - ordering 164

- toner darkness
 - adjusting 251
 - toner easily rubs off 244
 - transfer belt
 - replacing 185
 - transfer roller
 - replacing 188
 - transparencies
 - loading 29
 - trays
 - linking 30
 - loading 27
 - unlinking 30
 - troubleshooting
 - cannot open Embedded Web Server 219
 - FAQ about color printing 252
 - printer is not responding 232
 - troubleshooting, color quality
 - print appears tinted 253
 - troubleshooting, copy
 - partial copies of documents or photos 258
 - poor copy quality 258
 - scanner does not close 259
 - scanner does not respond 260
 - troubleshooting, fax
 - caller ID is not shown 254
 - cannot send faxes 256
 - cannot send or receive faxes 254
 - poor print quality 257
 - troubleshooting, print
 - collated printing does not work 225
 - confidential and other held documents do not print 228
 - envelope seals when printing 225
 - incorrect margins 238
 - jammed pages are not reprinted 228
 - job prints from the wrong tray 233
 - job prints on the wrong paper 233
 - paper frequently jams 227
 - print jobs do not print 231
 - slow printing 230
 - tray linking does not work 227
 - troubleshooting, print quality
 - blank or white pages 234
 - crooked print 242
 - dark print 235
 - ghost images appear on prints 236
 - gray or colored
 - background 237
 - horizontal dark lines 245
 - horizontal white lines 248
 - light print 239
 - mottled print and dots 241
 - paper curl 226
 - repeating print defects 250
 - skewed print 242
 - solid color or black images 242
 - text or images cut off 243
 - toner easily rubs off 244
 - uneven print density 245
 - vertical dark lines appear on prints 247
 - vertical white lines 249
 - troubleshooting, printer options
 - cannot detect internal option 221
 - internal solutions port 222
 - troubleshooting, scan
 - cannot scan from a computer 257
 - partial copies of documents or photos 258
 - poor copy quality 258
 - scan job was not successful 259
 - scanner does not close 259
 - scanner does not respond 260
 - two-sided copying 46
- U**
- unable to read flash drive
 - troubleshooting, print 220
 - understanding the status of the power button and indicator light 16
 - Unformatted flash detected 223
 - Universal paper size
 - setting 27
 - unlinking trays 30
 - updating firmware 279
 - USB port
 - enabling 220
 - USB printer port 13
 - using
 - genuine Lexmark parts 164
 - genuine Lexmark supplies 164
 - using Customer Support 21
 - using QR Code Generator 20
 - using the ADF
 - copying 45
 - using the automatic document feeder (ADF) 45, 48, 59, 62
 - using the control panel 15
 - using the home screen 16
 - using the scanner
 - glass 45, 48, 59, 62
 - copying 45
- V**
- verify print jobs 42
 - printing from a Macintosh computer 42
 - printing from Windows 42
 - vertical dark lines on prints 247
 - vertical white lines 249
 - viewing a fax log 61
 - viewing reports 155
 - virtual keyboard
 - using 26
 - Voice Guidance
 - activating 25
 - speech rate 25
 - Voice Guidance speech rate
 - adjusting 25
 - voice mail
 - setting up 51
 - volatile memory 153
 - erasing 152
- W**
- waste toner bottle
 - ordering 167
 - replacing 184
 - wireless network
 - Wi-Fi Protected Setup 156
 - wireless option 262
 - Wi-Fi Direct 157
 - printing from a mobile device 40
 - Wi-Fi network
 - deactivating 158
 - Wi-Fi Protected Setup
 - wireless network 156