

SunBrite

Veranda 4K HDR Operator's Manual



**Models: SB-V-43-4KHDR
SB-V-55-4KHDR
SB-V-65-4KHDR**



Important Safety Instructions

Dear SunBrite Customer:

Congratulations on the ownership of your SunBrite all-weather outdoor LCD TV, and welcome to the family of satisfied SunBrite customers. You are in great company, with thousands of homeowners and esteemed commercial facilities such as Yankee Stadium, Fenway Park, Disney World, and Sea World who have trusted us to deliver superior performance, lasting durability and the enjoyment of superb television viewing in the great outdoors.

Our products are designed to withstand the rigors of the outdoor environment and provide our customers with many years of optimum viewing, while delivering excellent picture and sound as well as the ease of use and convenience of conventional indoor TVs.

To ensure safety and long product life, please read the Important Safety Instructions and complete manual carefully before using the TV. If you have any questions about the installation procedures, please contact our qualified SunBrite Customer Support Team at 866.357.8688.

 <div style="border: 1px solid black; padding: 5px; width: fit-content; margin: 0 auto;"> <p>CAUTION RISK OF ELECTRIC SHOCK DO NOT OPEN</p> </div> 	<p>The lightning flash with arrow-head symbol, within an equilateral triangle, is intended to alert the user to the presence of uninsulated "dangerous voltage" within the product's enclosure that may be of sufficient magnitude to constitute a risk of electric shock to persons.</p>
<p>CAUTION: TO REDUCE THE RISK OF ELECTRIC SHOCK, DO NOT REMOVE COVER (OR BACK). NO USER-SERVICEABLE PARTS INSIDE. REFER SERVICING TO QUALIFIED SERVICE PERSONNEL.</p>	 <p>The exclamation point within a triangle is intended to alert the user to the presence of important operating and maintenance (servicing) instructions in the literature accompanying the product.</p>

CAUTION: TO PREVENT ELECTRIC SHOCK, MATCH WIDE BLADE OF PLUG TO WIDE SLOT, FULLY INSERT.

WARNING: FCC Regulations state that any unauthorized changes or modifications to this equipment not expressly approved by the manufacturer could void the user's authority to operate this equipment.

CAUTION: This product satisfies FCC regulations when shielded cables and connectors are used to connect the unit to other equipment. To prevent electromagnetic interference with electric appliances such as radios and televisions, use shielded cables and connectors for connections.

INFORMATION:
This equipment has been tested and found to comply with the limits for a Class B digital device, pursuant to Part 15 of the FCC Rules. These limits are designed to provide reasonable protection against harmful interference in a residential installation. This equipment generates, uses and can radiate radio frequency energy and, if not installed and used in accordance with the instructions, may cause harmful interference to radio communications. However, there is no guarantee that interference will not occur in a particular installation. If this equipment does cause harmful interference to radio or television reception, which can be determined by turning the equipment off and on, the user is encouraged to try to correct the interference by one or more of the following measures:

- Reorient or relocate the receiving antenna.
- Increase the separation between the equipment and receiver.
- Connect the equipment into an outlet on a circuit different from that to which the receiver is connected.
- Consult the dealer or an experienced radio/TV technician for help.

FCC Compliance Statement
This device complies with part 15 of the FCC Rules. Operation is subject to the following two conditions: (1) This device may not cause harmful interference, and (2) this device must accept any interference received, including interference that may cause undesired operation.

Important: Any changes or modifications not expressly approved by the party responsible for compliance could void the user's authority to operate the equipment.

FCC Radiation Exposure Statement: This equipment complies with FCC radiation exposure limits set forth for an uncontrolled environment. This equipment should be installed and operated with minimum distance 20cm between the radiator & your body.

Industry Canada Statement
This Class B digital apparatus complies with CAN ICES-003(B)/NMB-3(B)

Important: Any changes or modifications not expressly approved by the party responsible for compliance could void the user's authority to operate the equipment.

IC Radiation Exposure Statement: This device complies with IC RSS-210 rules; Operation is subject to the following two conditions:
(1) This device may not cause harmful interference, and (2) this device must accept interference received, including interference that may cause undesired operation.

Note to CATV system installer: This reminder is provided to call the CATV system installer's attention to Article 820 of the National Electrical Code that provides guidelines for proper grounding and, in particular, specifies that the cable ground shall be connected to the grounding system of the building, as close to the point of cable entry as practical.



WARNING: This product can expose you to chemicals including [name of one or more chemicals], which is [are] known to the State of California to cause cancer, and [name of one or more chemicals], which is [are] known to the State of California to cause birth defects or other reproductive harm. For more information go to www.P65Warnings.ca.gov.

Important Safety Instructions

Electricity is used to perform many useful functions, but it can also cause personal injuries and property damage if improperly handled. This product has been engineered and manufactured with the highest priority on safety. However, improper use can result in electric shock and/or fire. In order to prevent potential danger, please observe the following instructions when installing, operating and cleaning the product. To ensure your safety and prolong the service life of your Liquid Crystal Television, please read the following precautions carefully before using the product.

- 1) Read these instructions.
- 2) Keep these instructions.
- 3) Heed all warnings.
- 4) Follow all instructions.
- 5) Do not use this apparatus near water.
- 6) Clean only with dry cloth.
- 7) Do not block any ventilation openings. Install in accordance with the manufacturer's instructions.
- 8) Do not install near any heat sources such as radiators, heat registers, stoves, or other apparatus (including amplifiers) that produce heat.
- 9) Do not defeat the safety purpose of the polarized or grounding-type plug. A polarized plug has two blades with one wider than the other. A grounding type plug has two blades and a third grounding prong. The wide blade or the third prong are provided for your safety. If the provided plug does not fit into your outlet, consult an electrician for replacement of the obsolete outlet.
- 10) Protect the power cord from being walked on or pinched particularly at plugs, convenience receptacles, and the point where they exit from the apparatus.
- 11) Only use attachments/accessories specified by the manufacturer.
- 12) Use only with the cart, stand, tripod, bracket, or table specified by the manufacturer, or sold with the apparatus. When a cart is used, use caution when moving the cart/apparatus combination to avoid injury from tip-over.
- 13) Unplug this apparatus during lightning storms or when unused for long periods of time.
- 14) Refer all servicing to qualified service personnel. Servicing is required when the apparatus has been damaged in any way, such as power-supply cord or plug is damaged, liquid has been spilled or objects have fallen into the apparatus, the apparatus has been exposed to rain or moisture, does not operate normally, or has been dropped.



Additional Safety Information

- 15) **Power Sources**—This product should be operated only from the type of power source indicated on the marking label. If you are not sure of the type of power supply to your home, consult your product dealer or local power company. For products intended to operate from battery power, or other sources, refer to the operating instructions.
- 16) **Overloading**—Do not overload wall outlets, extension cords, or integral convenience receptacles as this can result in a risk of fire or electric shock.
- 17) **Object and Liquid Entry**—Never push objects of any kind into this product through openings as they may touch dangerous voltage points or short-out parts that could result in a fire or electric shock. Never spill liquid of any kind on the product.
- 18) **Damage Requiring Service**—Unplug this product from the wall outlet and refer servicing to qualified service personnel under the following conditions:
 - a) When the AC cord or plug is damaged,
 - b) If liquid has been spilled, or objects have fallen into the product,
 - c) If the product has been exposed to rain or water,
 - d) If the product does not operate normally by following the operating instructions.
 Adjust only those controls that are covered by the operating instructions as an improper adjustment of other controls may result in damage and will often require extensive work by a qualified technician to restore the product to its normal operation.
 - e) If the product has been dropped or damaged in any way, and

f) When the product exhibits a distinct change in performance - this indicates a need for service.

- 19) **Replacement Parts**—When replacement parts are required, be sure the service technician has used replacement parts specified by the manufacturer or have the same characteristics as the original part. Unauthorized substitutions may result in fire, electric shock, or other hazards.
- 20) **Safety Check**—Upon completion of any service or repairs to this product, ask the service technician to perform safety checks to determine that the product is in proper operating condition.
- 21) **Wall or ceiling mounting**—When mounting the product on a wall or ceiling, be sure to install the product according to the method recommended by the manufacturer.

- **Outdoor Antenna Grounding** — If an outside antenna is connected to the television equipment, be sure the antenna system is grounded so as to provide some protection against voltage surges and built-up static charges.

Article 810 of the National Electrical Code, ANSI/NFPA 70, provides information with regard to proper grounding of the mast and supporting structure, grounding of the lead-in wire to an antenna discharge unit, size of grounding conductors, location of antenna-discharge unit, connection to grounding electrodes, and requirements for the grounding electrode.

EXAMPLE OF ANTENNA GROUNDING AS PER NATIONAL ELECTRICAL CODE, ANSI/NFPA 70

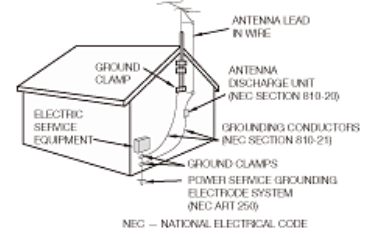

- **Water and Moisture** — Do not use this product near water - for example, near a bath tub, wash bowl, kitchen sink, or laundry tub; in a wet basement; or near a swimming pool; and the like.
- **Stand** — Do not place the product on an unstable cart, stand, tripod or table. Placing the product on an unstable base can cause the product to fall, resulting in serious personal injuries as well as damage to the product. Use only a cart, stand, tripod, bracket or table recommended by the manufacturer or sold with the product. When mounting the product on a wall, be sure to follow the manufacturer's instructions. Use only the mounting hardware recommended by the manufacturer.
- **Selecting the location** — Select a place with no direct sunlight and good ventilation.
- **Ventilation** — The vents and other openings in the cabinet are designed for ventilation. Do not cover or block these vents and openings since insufficient ventilation can cause overheating and/or shorten the life of the product. Do not place the product on a bed, sofa, rug or other similar surface, since they can block ventilation openings. This product is not designed for built-in installation; do not place the product in an enclosed place such as a bookcase or rack, unless proper ventilation is provided or the manufacturer's instructions are followed.
- **The front panel used in this product is made of glass.** Therefore, it can break when the product is dropped or applied with impact. Be careful not to be injured by broken glass pieces in case the panel breaks.
- **Heat** — The product should be situated away from heat sources such as radiators, heat registers, stoves, or other products (including amplifiers) that produce heat.
- **The Liquid Crystal panel is a very high technology product with 2,073,600 pixels,** giving you fine picture details. Occasionally, a few non-active pixels may appear on the screen as a fixed point of blue, green or red. Please note that this does not affect the performance of your product.
- **Lightning** — For added protection for this television equipment during a lightning storm, or when it is left unattended and unused for long periods of time, unplug it from the wall outlet and disconnect the antenna. This will prevent damage to the equipment due to lightning and power-line surges.
- **Power Lines** — An outside antenna system should not be located in the vicinity of overhead power lines or other electric light or power circuits, or where it can fall into such power lines or circuits. When installing an outside antenna system, extreme care should be taken to keep from touching such power lines or circuits as contact with them might be fatal.
- **To prevent fire, never place any type of candle or flames on the top or near the TV set.**
- **To prevent fire or shock hazard, do not place the AC cord under the TV set or other heavy items.**

- Do not display a still picture for a long time, as this could cause an afterimage to remain.
- To prevent fire or shock hazard, do not expose this product to dripping or splashing. No objects filled with liquids, such as vases, should be placed on the product.
- Do not insert foreign objects into the air vents or other openings may result in fire or electric shock. Exercise special caution when using the product around children.

Precautions when transporting the TV

- When transporting the TV, never carry it by holding or otherwise putting pressure onto the display. Be sure to always carry the TV by two people holding it with two hands.



Caring for the cabinet

- Use a soft cloth (cotton, flannel, etc.) and gently wipe the surface of the cabinet.
 - Using a chemical cloth (wet/dry sheet type cloth, etc.) may deform the components of the main unit cabinet or cause cracking.
 - Wiping with a hard cloth or using strong force may scratch the surface of the cabinet.
 - If the cabinet is very dirty, wipe with a soft cloth (cotton, flannel, etc.) soaked in neutral detergent diluted with water and thoroughly wrung out, and then wipe with a soft dry cloth.
 - Avoid using benzene, thinner, and other solvents, as these may deform the cabinet and cause the paint to peel off.
 - Do not apply insecticides or other volatile liquids.
- Also, do not allow the cabinet to remain in contact with rubber or vinyl products for a long period of time. Plasticizers inside the plastic may cause the cabinet to deform and cause the paint to peel off.

Caring for the front panel

- Turn off the main power and unplug the AC cord from the wall outlet before handling.
- Gently wipe the surface of the front panel with a soft cloth (cotton, flannel, etc.). To protect the front panel, do not use a dirty cloth, liquid cleaners, or a chemical cloth (wet/dry sheet type cloth, etc.). This may damage the surface of the front panel.
- Wiping with a hard cloth or using strong force may scratch the surface of the front panel.
- Use a soft damp cloth to gently wipe the front panel when it is really dirty. (It may scratch the surface of the front panel when wiped strongly.)
- If the front panel is dusty, use an anti-static brush, which is commercially available, to clean it.
- To avoid scratching the frame or screen, please use a soft, lint free cloth for cleaning.



CHILD SAFETY: PROPER TELEVISION PLACEMENT MATTERS



THE CONSUMER ELECTRONICS INDUSTRY CARES

- Manufacturers, retailers and the rest of the consumer electronics industry are committed to making home entertainment safe and enjoyable.
- As you enjoy your television, please note that all televisions - new and old - must be supported on proper stands or installed according to the manufacturer's recommendations. Televisions that are inappropriately situated on dressers, bookcases, shelves, desks, speakers, chests, carts, etc., may fall over, resulting in injury.

TUNE IN TO SAFETY

- **ALWAYS** follow the manufacturer's recommendations for the safe installation of your television.
- **ALWAYS** read and follow all instructions for proper use of your television.
- **NEVER** allow children to climb on or play on the television or the furniture on which the television is placed.
- **NEVER** place the television on furniture that can easily be used as steps, such as a chest of drawers.
- **ALWAYS** install the television where it cannot be pushed, pulled over or knocked down.
- **ALWAYS** route cords and cables connected to the television so that they cannot be tripped over, pulled or grabbed.

WALL OR CEILING MOUNT YOUR TELEVISION

- **ALWAYS** contact your retailer about professional installation if you have any doubts about your ability to safely mount your television.
- **ALWAYS** use a mount that has been recommended by the television manufacturer and has a safety certification by an independent laboratory (such as UL, CSA, ETL).
- **ALWAYS** follow all instructions supplied by the television and mount manufacturers.
- **ALWAYS** make sure that the wall or ceiling where you are mounting the television is appropriate. Some mounts are not designed to be mounted to walls and ceilings with steel studs or cinder block construction. If you are unsure, contact a professional installer.
- Televisions can be heavy. A minimum of two people is required for a wall or ceiling mount installation.

MOVING AN OLDER TELEVISION TO A NEW PLACE IN YOUR HOME

- Many new television buyers move their older CRT televisions into a secondary room after the purchase of a flat-panel television. Special care should be made in the placement of older CRT televisions.
- **ALWAYS** place your older CRT television on furniture that is sturdy and appropriate for its size and weight.
- **NEVER** place your older CRT television on a dresser where children may be tempted to use the drawers to climb.
- **ALWAYS** make sure your older CRT television does not hang over the edge of your furniture.

Important Safety Instructions

Cleaning Instructions: See “Care of SunBrite” on page 46.

Attachments: Do not use attachments not specifically recommended by the manufacturer. Use of improper attachments can result in accidents.

Power Source: SunBrite must operate on a power source indicated on the specification label. If you are not sure of the type of power supply used in your home, consult your dealer or local power company. When using the TV outdoors, you must use a GFI-protected AC outlet with “in-use” waterproof cover.

Installation: Do not place the product on an unstable cart, stand, tripod, table, or anywhere the unit is not permanently installed. Placing the product on an unstable place can cause the product to fall, resulting in potential serious personal injuries, as well as damage to the product.

Precautions when Transporting the TV: Carrying the television requires at least two people.

Ventilation: Adequate ventilation must be maintained to ensure reliable and continued operation and to protect the television from overheating. There must be at least 1.5” of space on all sides. Do not install inside an enclosure, Kisok, etc.

Power cord protection: The power cord must be routed properly to prevent people from stepping on it, or objects from resting on it. Check the cords at the plugs and product.

Power source: This product must operate on a power source specified on the specification label. If you are unsure of the type of power supply used in your home, consult your dealer or local power company.

Do not let metal pieces or objects of any kind fall into the television from ventilation holes. High voltage flows in the product, and inserting an object can cause electric shock and/or short internal parts.

Do not mount SunBrite near a motor or transformer where strong magnetism is generated. Images on the television will become distorted and the color irregular.

Do not mount SunBrite near heat sources such as radiators, heaters, stoves and other heat-generating products (including amplifiers).

Do not submerge SunBrite in water: The SunBrite will resist water exposure from normal rain, sprinklers, garden hoses, etc.; however, it is not designed to be submerged in water.

Do not pressure-wash SunBrite: SunBrite will resist water exposure from normal rain, sprinklers, garden hoses, etc.; however, it is not designed to withstand pressure washers, high-pressure water jets, or hurricane-type weather.

Do not service SunBrite yourself: Removal of the television screen cover may expose you to high voltage or other dangerous risks. Refer all servicing to a qualified service professional. Warranty will not be honored if you service the unit yourself.

Repair: If any of the following conditions occurs, unplug the power cord, and call a qualified service professional to perform repairs:

- When power cord or plug is damaged.
- When objects have fallen into the product.
- If unit was submerged in water or pressure-washed.
- When product does not operate properly as described in the operating instructions. Do not touch the controls other than as described in the operating instructions. Improper adjustments of controls not described in the instructions can cause damage, which can require extensive repair work by a qualified technician.
- When the product has been dropped or damaged.
- When the product displays an abnormal condition. Any noticeable abnormality in the product indicates that the product needs servicing.

Replacement parts: In case the product needs replacement parts, make sure that the service person uses replacement parts provided by SunBrite. Use of unauthorized parts can result in fire, electric shock and/or other danger.

Safety checks: Upon completion of service or repair work, ask the service technician to perform safety checks to ensure that the product is in proper operating condition.

Table of Contents

CONTENTS

Important Safety Instructions.....	2
Part Names	6
Remote Control Unit.....	7
Displaying an External Equipment Image.....	9
Watching TV.....	10
Initial Installation.....	10
Direct Button Operation.....	12
Changing Channels	12
MUTE	13
Channel Return.....	14
AUDIO	15
Sleep Timer.....	16
Sound Mode	17
Picture Mode.....	18
Closed Captions and Digital Closed Captions.....	19
ASPECT MODE	21
For HD programs	21
On-Screen Display Menu	24
On-Screen Display Menu Operation.....	25
Menu Operation Buttons	26
Audio	27
Picture	28
Advanced Picture.....	29
Link	30
System	31
System	32
USB Photo/Music/Video Playback	33
Preparation	33
CAUTION:.....	33
Selecting the Folders to Play Back	34
Playing Back Files on a USB Memory Device	36
Music Mode.....	38
Video Mode.....	39
Using LINK Operation	40
Controlling HDMI Equipment Using LINK CEC Operation.....	40
Appendix	42
TV Stand	42
Optional Speaker Bar	43
Mounting the TV on the Wall.....	44
Caring for the LCD Panel:.....	46
Troubleshooting.....	47
Specifications.....	49

Part Names

TV
(Front)

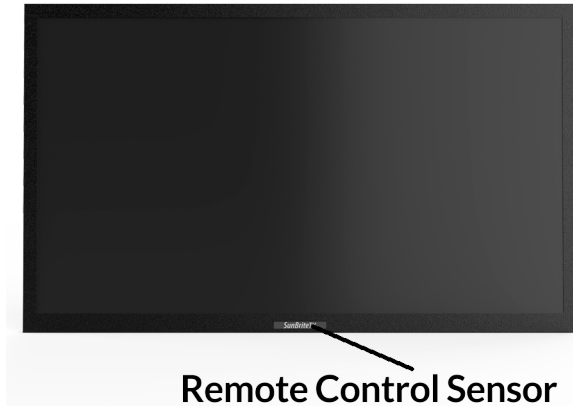

Remote Control Sensor
Power Indicator

(Side)

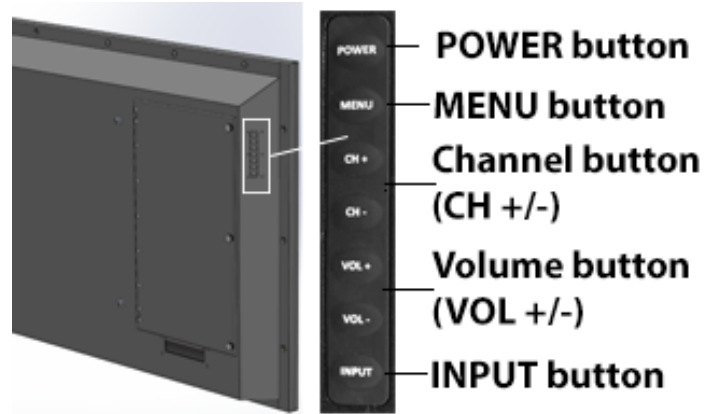

* See page 8 for button operations.

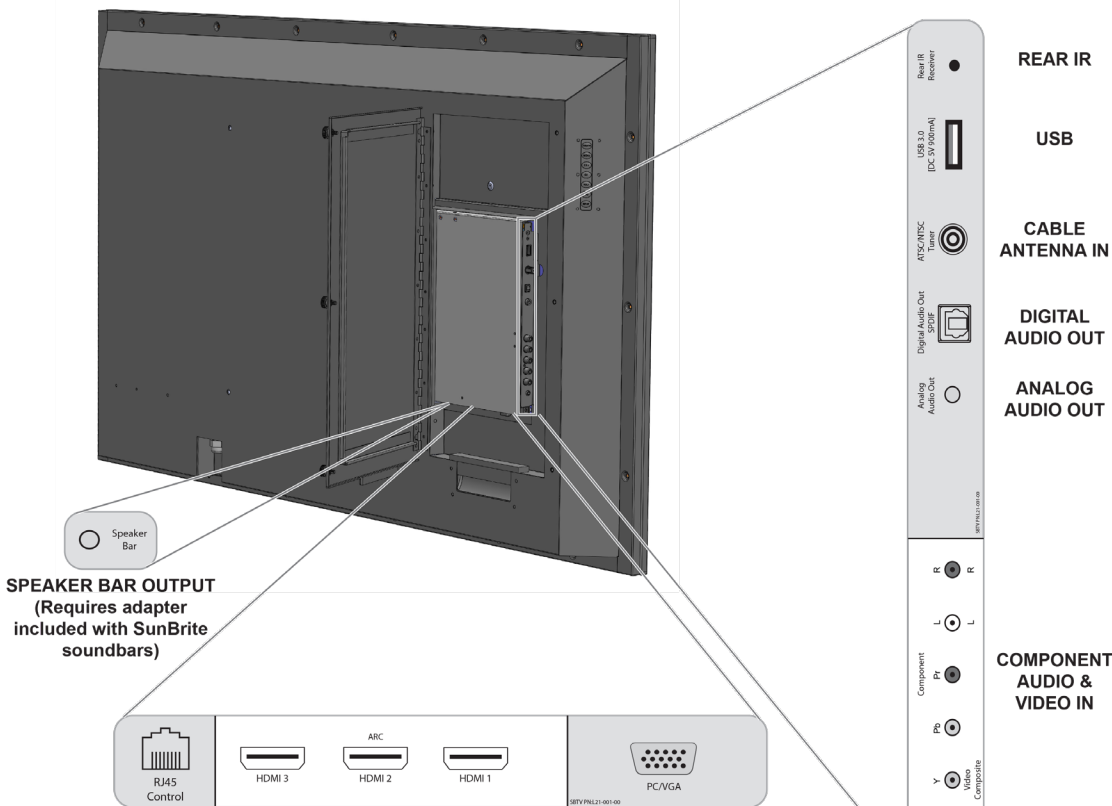

Caution

When using the ethernet port for IP control, connect the cable to the network switch before connecting to the SunBriteTV ethernet port.

SPEAKER BAR OUTPUT.

- See page 43 for optional speaker bar connection.
- ARC See page 41 for details on the Audio Return Channel.
- See page 9 for details on the Input Select function.

Note: The illustrations and on-screen displays in this operation manual are for explanation purposes and may vary slightly from the actual operations.

Remote Control Unit

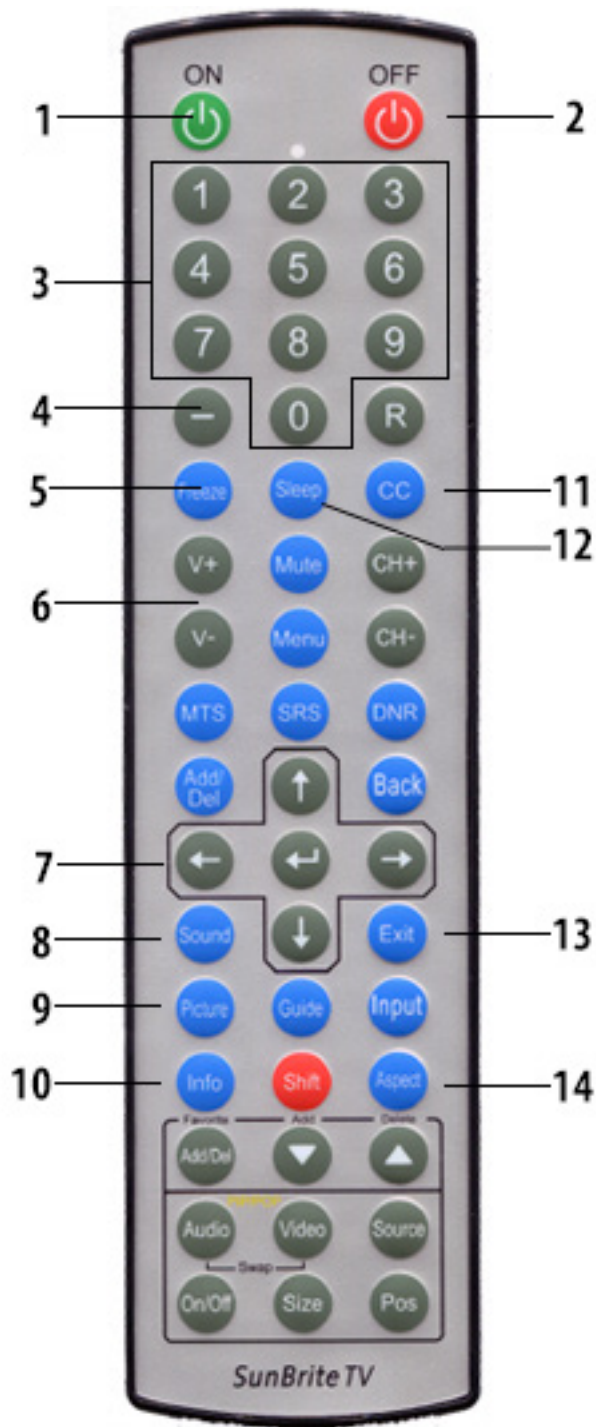

Note: SunBrite TVs use the Sony TV IR codeset. When programming a universal remote or control system try Sony IR codes if SunBrite TV codes are not listed.

- 1 POWER ON: Switch the TV power on.
- 2 POWER OFF: Switch the TV power off.
- 3 0-9: Set the channel.
- 4 - (Dash): Set a digital channel.
- 5 FREEZE: Freeze not supported on Veranda 2 series
- 6 VOL+/-: Set the volume.
- 7 ▲/▼/◀/▶, ENTER: Select a desired item on the screen.
- 8 SOUND: Change sound preset modes.
- 9 PICTURE: Change picture settings preset modes.
- 10 INFO: Display the channel or source information.
- 11 CC: Display captions from a closed-caption source.
- 12 SLEEP: Set the sleep timer.
- 13 EXIT: Turn off the menu screen.
- 14 ASPECT: Select the screen aspect.

Note: When using the remote control unit, point it at the TV.

SunbriteTV Remote Control Unit (Continued)

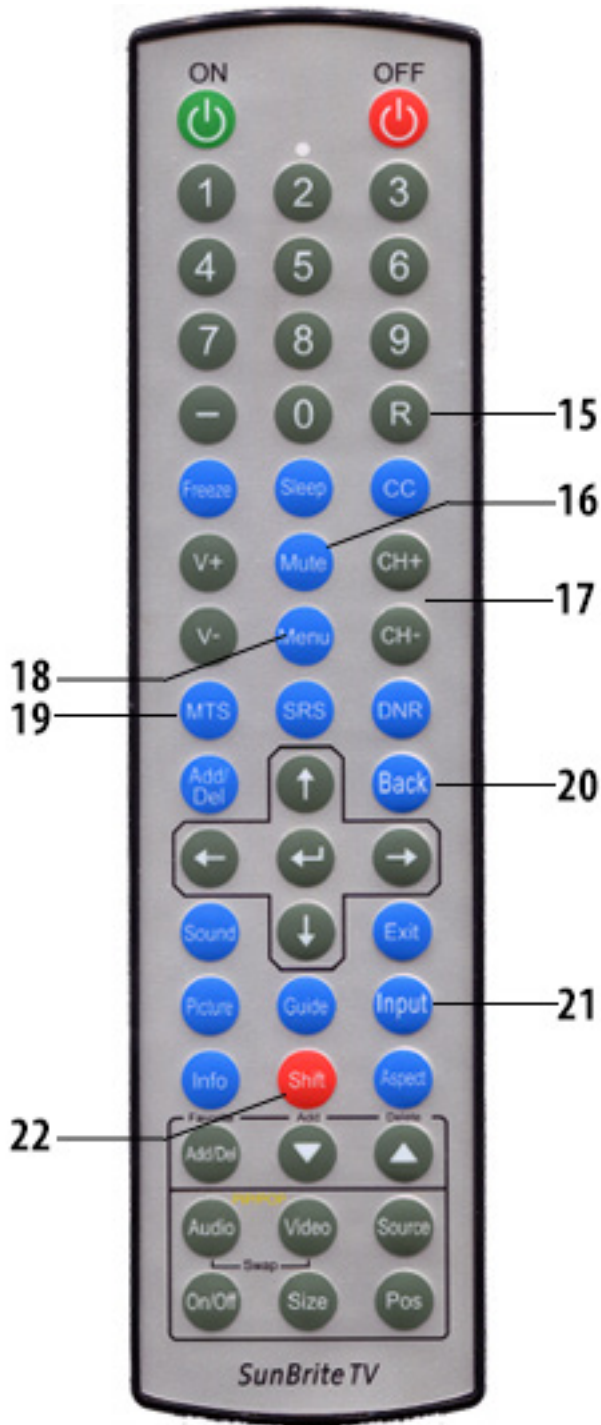

Note: SunBrite TVs use the Sony TV IR codeset. When programming a universal remote or control system try Sony IR codes if SunBrite TV codes are not listed.

- 15 RETURN: Return to the previous channel.
- 16 MUTE: Mute the sound.
- 17 CH+/- : Select the channel.
- 18 MENU: Display the menu screen.
- 19 MTS: Selects the MTS/SAP or the audio mode during multichannel audio broadcasts.(Antenna/Cable only)
- 20 BACK: Return to the previous menu screen.
- 21 INPUT: Select a TV input source.
- 22 SHIFT: Press and hold this button then press buttons 0-9 to directly select TV input

Shift-1	VIDEO
Shift-2	N/A
Shift-3	HDMI 3
Shift-4	USB
Shift-5	Component
Shift-6	N/A
Shift-7	N/A
Shift-8	HDMI 1
Shift-9	HDMI 2
Shift-0	TV Tuner
Shift-ON	Power Toggle

NOTE
When using the remote control unit, point it at the TV.

Displaying an External Equipment Image



To view external source images, select the input source by pressing INPUT on the remote control unit or on the TV.



1. Press INPUT.
The INPUT list screen displays.
2. Press / to select the input source.
An image from the selected source automatically displays.



You can also select the input source by pressing INPUT. Each time INPUT is pressed, the input source toggles.
TV > HDMI1 > HDMI2 > HDMI3 > MMP(USB) > PC > VIDEO > COMPONENT > TV

Note: Video and Component will only display when a source signal is applied to the input

Watching TV

INITIAL INSTALLATION



Perform the following steps before you press POWER on the remote control unit.

1. Insert the batteries into the remote control unit.
2. Connect the antenna cable to the TV.
3. Plug in the AC cord to the AC outlet.

Select Antenna or Cable

1. Press to select and then press ENTER.

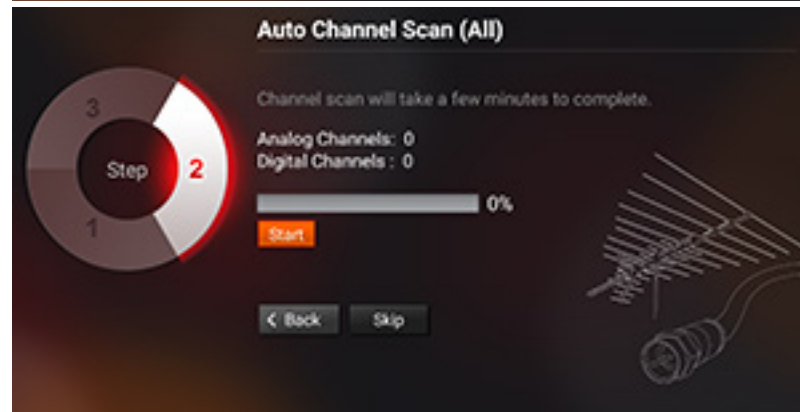
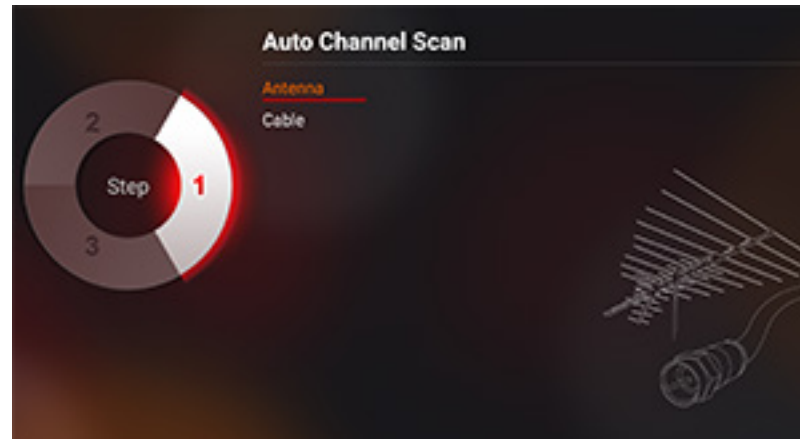

2. Select **Start** if you will be using Antenna or Cable input, otherwise select **Skip**.

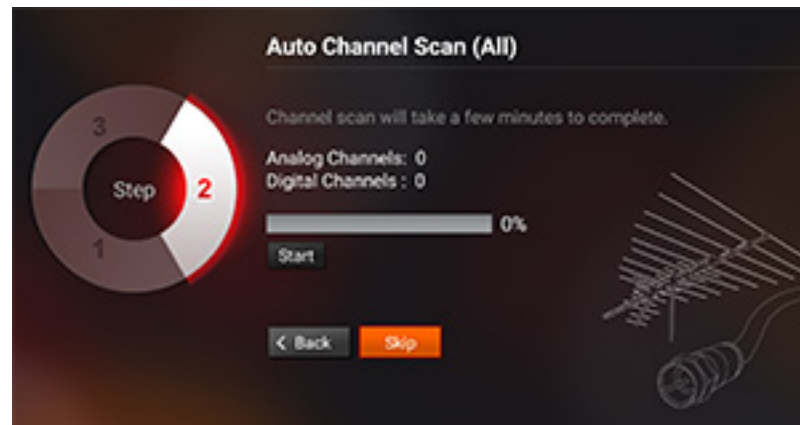

Watching TV

INITIAL INSTALLATION (CONTINUED)



3. The tuner will scan for available channels and store them into memory. This process can take from 3-10 minutes.

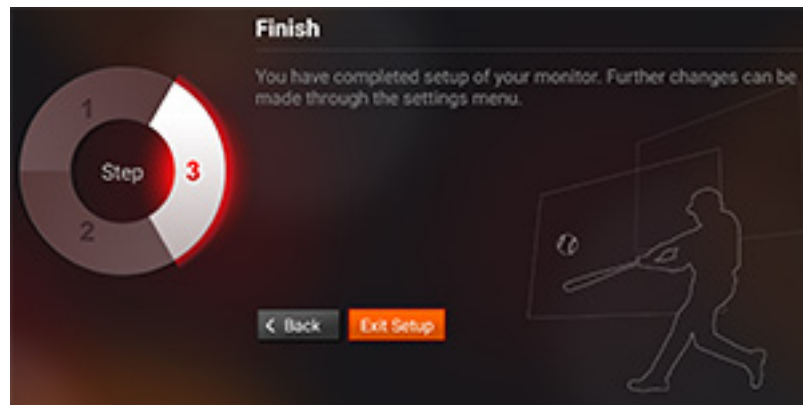

4. When the scan process is complete, select exit setup.

Direct Button Operation



CHANGING CHANNELS

You can change channels in several ways.

Method 1

Using CH +/- on the remote control unit or on the TV.

Method 2

Using remote control buttons 0-9, - (Dash).

Examples:

To select a 1 or 2-digit channel number (e. g., Channel 5):

Press 5 → ENTER

To select a 3-digit channel number (e. g., Channel 115):

Press 1 → 1 → 5 → ENTER

To select a 4-digit channel number (e. g., Channel 22.1):

Press 2 → 2 → - (Dash) → 1 → ENTER

Method 3

Selecting the program from the Channel list.

1. Press INPUT on the remote control unit.
The INPUT list displays.
2. Press to select AIR or CABLE.
The Channel list displays.
3. Press to select the desired channel, and then press ENTER.

Note:

- When selecting a 1-digit channel number, it is not necessary to press 0 before the number.
- When you enter 0-9 only, channel selection will be made if there is no operation within a few seconds.
- If you push "0" by itself, nothing will happen.
- Complete the above steps within a few seconds.
- When you enter 0-9 and - (Dash), channel selection will be made if there is no operation within a few seconds

CHANGING VOLUME

You can change the volume by pressing VOL +/- on the TV or on the remote control unit.

To increase the volume, press VOL +.

To decrease the volume, press VOL -.



Direct Button Operation



MUTE

Mutes the current sound output.

Press MUTE.

 will be displayed on the screen, and the sound is silenced.



Direct Button Operation



CHANNEL RETURN

- Press R (Ch Return) to switch to the previously tuned channel.
- Press R (Ch Return) again to switch back to the currently tuned channel.
- Note: R (Ch Return) will not work if no channel has been changed after the TV is turned on

Direct Button Operation



AUDIO

MTS/SAP stereo mode

The TV has a feature that allows reception of sound other than the main audio for the program. This feature is called Multi-channel Television Sound (MTS). The TV with MTS can receive mono sound, stereo sound and Secondary Audio Programs (SAP). The SAP feature allows a TV station to broadcast other information, which could be audio in another language or something completely different like weather information.

You can enjoy Hi-Fi stereo sound or SAP broadcasts where available.

- **Stereo broadcasts:** View programs like live sporting events, shows and concerts in dynamic stereo sound.
- **SAP broadcasts:** Receive TV broadcasts in either MAIN or SAP sound.
- **MAIN sound:** The normal program soundtrack (either in mono or stereo).
- **SAP sound:** Listen to a second language, supplementary commentary or other information. (SAP is mono sound.)

If stereo sound is difficult to hear:

- Obtain a clearer sound by manually switching to fixed mono-sound mode.

You can change MTS as shown below to match the television broadcast signal.

Press **AUDIO** to toggle between audio modes.

Examples: when receiving MTS and SAP

STEREO mode:	ST(SAP) → SAP(ST) → MONO
STEREO + SAP mode:	STEREO ↔ MONO
MAIN + SAP mode:	MAIN ↔ SAP
MONO mode:	MONO

Digital broadcasting audio mode

The types of audio transmitted in a digital broadcast include **SURROUND** as well as **MONO** and **STEREO**. In addition, it is possible for multiple audio tracks to accompany a single video track.

Press **ENTER** to toggle between audio modes.

Example: when receiving Digital broadcasting

STEREO (Audio1) → STEREO (Audio2)
 ↖ SURROUND (Audio3) ↗

Note: MTS only operates while in TV mode

Direct Button Operation



SLEEP TIMER

Allows you to set a time when the TV automatically switches to standby.

Press **SLEEP**.

- The remaining time displays when the sleep timer has been set.
- Each time you press **SLEEP**, the remaining time switches as shown below.
- Highlight the desired selection and press enter

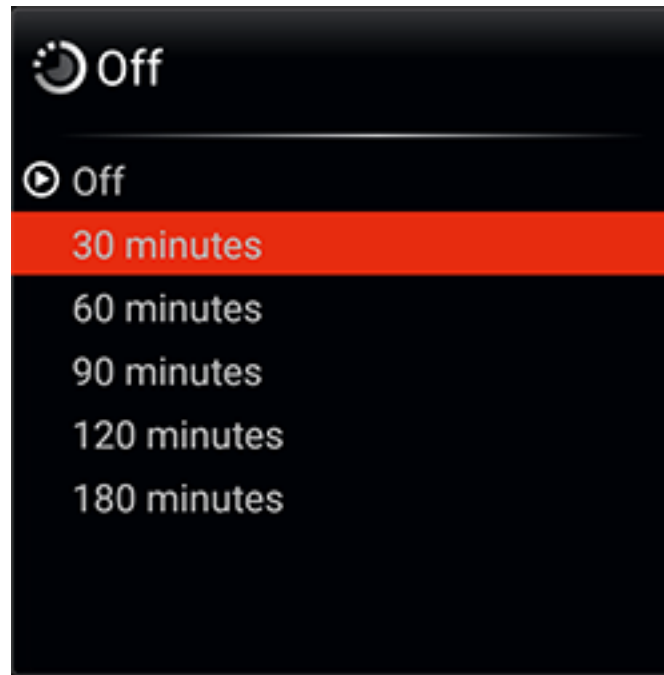

Direct Button Operation



SOUND MODE

Sound MODE gives you several audio setting options to choose from to best match the surrounding environment of the TV, which can vary due to factors like listening environment, type of program watched or the type of device connected.

Press **SOUND**. Sound menu OSD displays.

- Press Sound again or use the up and down arrow keys to highlight the desired selection
- Press enter to select the desired sound mode

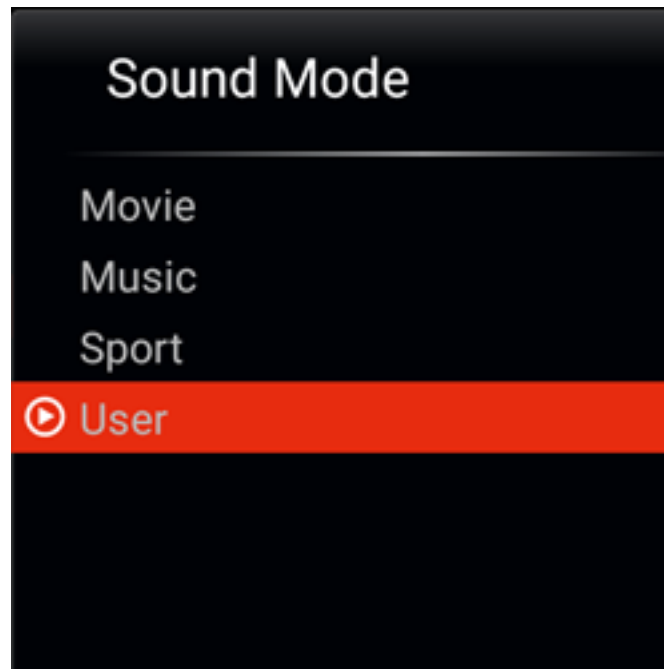

On-Screen Display Menu



PICTURE MODE

Picture mode gives you several viewing options to choose from to best match the surrounding environment of the TV, which can vary due to factors like ambient light, type of program watched or the type of device connected.

Press **Picture** button. Current picture mode displays.

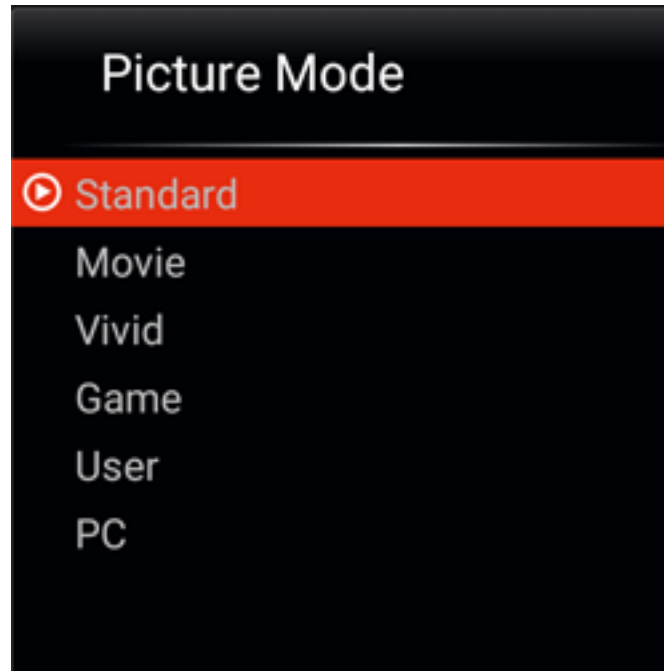

Standard: For a highly defined image in a normal lighting.

Movie: For a movie.

Vivid: For a clear-cut image emphasizing high contrast, useful for sports viewing.

Game: Gaming.

User: Custom user profile settings.

PC: For PC.

Direct Button Operation



CLOSED CAPTIONS AND DIGITAL CLOSED CAPTIONS

Your TV is equipped with an internal Closed Caption decoder. It allows you to view conversations, narration and sound effects as subtitles on your TV. Closed Captions are available on some TV programs and on some VHS home video tapes at the discretion of the program provider.

Digital Closed Caption service is a new caption service available only on digital TV programs (also at the discretion of the service provider). It is a more flexible system than the original Closed Caption system, because it allows for a variety of caption sizes and font styles. When the Digital Closed Caption service is in use, it will be indicated by the appearance of a 3-letter abbreviation that also indicates the language of the Digital Closed Captions: ENG (English), SPA (Spanish), FRA (French) or other language codes.

Not all programs and VHS videotapes offer closed captions. Please look for the  symbol to ensure that captions will be shown.

In the Closed Caption system, there can be more than one caption service provided. Each is identified by its own number. The "CC1" and "CC2" services display subtitles of TV programs superimposed over the program's picture.

In the Closed Caption system, the "Text1" or "Text2" services display text that is unrelated to the program being viewed (e.g., weather or news). These services are also superimposed over the program currently being viewed.

1. Press CC.
 - This will present the Closed Caption information display.
2. Press CC while the Closed Caption information is still on the screen.
 - Press repeatedly until you select the desired closed caption service.



- Depending on the number of caption services in the signal being received, you will see information such as 1/2 or 1/4 displayed.

1/2 means "the first of two services".

Example:

If a program has three services (Digital CC(ENG), CC1 and Text1), the closed caption display will toggle in this sequence:

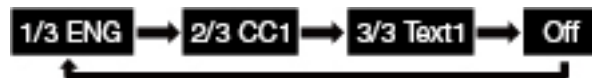

Direct Button Operation



CLOSED CAPTIONS AND DIGITAL CLOSED CAPTIONS (CONTINUE)

Examples:

In a case where there are two closed caption services provided (for instance, Digital CC(ENG) and CC1), and Digital CC(ENG) is displayed as your current selection, if Digital CC(ENG) is not broadcast for the next program, the other closed caption service, CC1, will be displayed in parentheses.

A closed caption service appears in parentheses because the service you selected is not available and a different service is displayed on your screen. **1/1(CC1)** is displayed instead of **1/2/ENG**.

Note:

- When the program contains no closed caption, -- displays in the closed caption information.
- If the language code, e.g. **ENG**, is not found on Digital TV programs, -- will be shown.
- Four kinds of closed caption service (CC1, CC2, Text1, Text2) are potentially available, but a broadcast may contain none or only some of these services at the discretion of the program provider.
- When a web page is displayed, Closed Captions are not available.
- You can have the same settings by choosing **Change CC** on the menu items.

Direct Button Operation





ASPECT MODE

You can select the screen size.

1. Press ASPECT.
 - The Aspect Mode menu displays.
 - The menu lists the Aspect Mode options selectable for the type of video signal currently being received.
2. Press ASPECT or GKProjA_a/GKProjA_b while the View Mode menu is displayed to select a desired item on the menu.
 - You can sequentially select an Aspect Mode that has its own aspect ratio.

FOR HD PROGRAMS

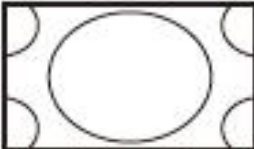
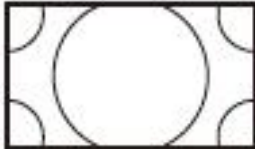
Stretch	Full Screen (Dot By Dot)	S. Stretch (Smart Stretch)	Zoom
			
Suitable for viewing wide-screen 1.78:1 aspect ratio program, stretch mode will still show very thin black bands at the top and bottom of the screen.	"Dot by Dot" when the number of pixels on the screen and the resolution of the signal are the same. "Full Screen" when the number of pixels on the screen and the resolution of the signal are different. In either case, the image fully fills the screen.	Suitable for stretching 4:3 programs to fill the screen.	Suitable for viewing wide-screen 2.35:1 aspect-ratio programs in full screen.

Note: When using Dot by Dot or Full Screen, it is possible to see noise or bars around different outer portions of the screen. Please change view mode to correct this.

Direct Button Operation



ASPECT MODE (CONTINUED)

For 4:3 programs

Example: Screen size images

Side Bar	S. Stretch (Smart Sketch)	Zoom	Stretch
Suitable for viewing conventional 4:3 programs in their normal format.	Suitable for stretching 4:3 programs to fill the screen.	Suitable for viewing wide-screen 2.35:1 anamorphic DVDs in full screen.	This mode is useful for 1.78:1 DVDs. When viewing 1.85:1 DVDs, stretch mode will still show very thin black bands at the top and bottom of the screen.

For USB-Video and images

Example: Screen size images

Input Signal	Auto	Original	Stretch
	Keeps the original aspect ratio in a full screen display.	Displays an image by an original size.	An image fully fills the screen.

Direct Button Operation



ASPECT MODE (CONTINUE)

For PC

Example: Screen Size Images

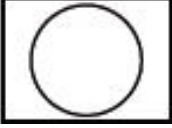
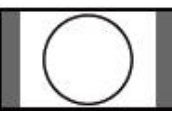
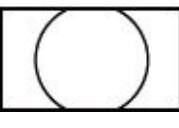
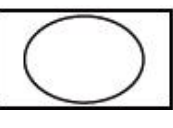
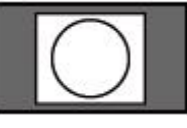
Input Signal	Auto	Zoom	Stretch	Full Screen (Dot by Dot)
 4:3	 Keeps the original aspect ratio in a full screen display.	 For viewing widescreen programs. The top and bottom of the image is cropped.	 An image fully fills the screen.	 Detects the resolution of the signal and displays an image with the same number of pixels on the screen.

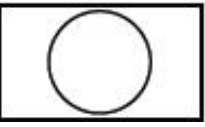
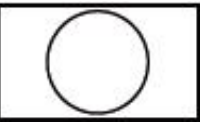
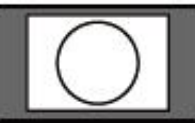
Input Signal	Stretch	Full Screen (Dot by Dot)
 16:9	 An image fully fills the screen.	 Detects the resolution of the signal and displays an image with the same number of pixels on the screen.

Note: Connect the PC before making adjustments. See the Setup Guide.

Selectable screen size may vary with input signal type

On-Screen Display Menu



Introduction

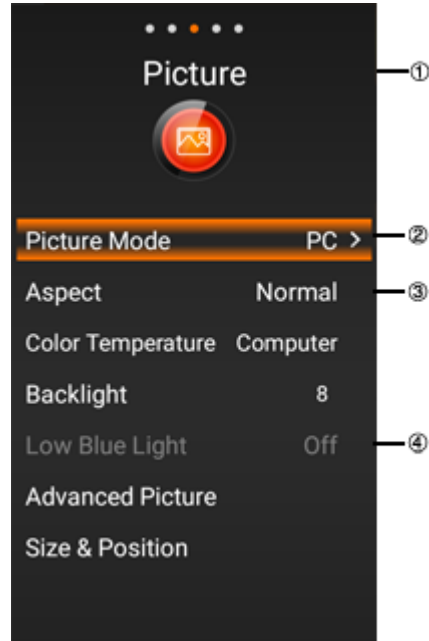

1. User Menu Option Title
 - This indicates the item currently selected.
 - Press **ENTER** to go to the adjustment screen for this item.
2. Highlighted Menu Option
 - This indicates the currently selected item.
3. Item displayed in white
 - This indicates that the item can be selected.
4. Item displayed in gray
 - This indicates that the item cannot be selected.
 - There are various reasons why the items cannot be selected, but the main reasons are as follows:
 - Nothing is connected to the selected input terminal.
 - The function is not compatible with the current input signal.
 - When this conflicts with other functions, you must change the settings for the other functions.

About Menu Items

- Some menu items may not be displayed depending on the selected input source.

Note:

- The screens in the operation manual are for explanation purposes (some are enlarged, others cropped) and may vary slightly from the actual screens.
- The order of explanations for each menu item in the following pages is not necessarily in accordance with the alignment of the items on the screen.

On-Screen Display Menu



ON-SCREEN DISPLAY MENU OPERATION

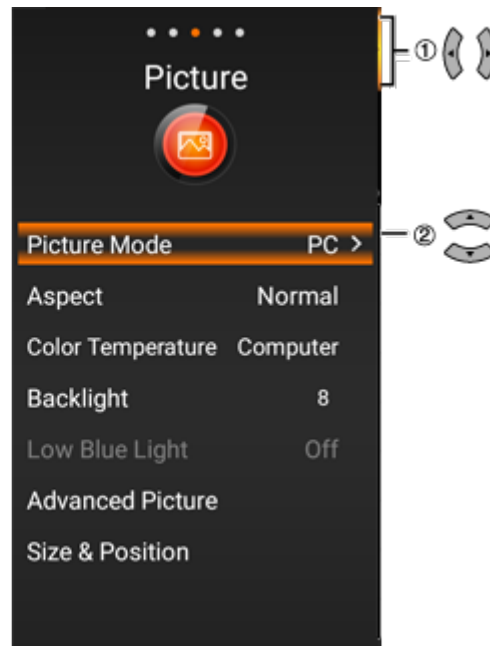

1. Press MENU to display the MENU screen.
2. Press ◀/▶ to select the desired menu.
Press ▲/▼ to select a specific adjustment item, and then press ENTER.
 - Additional related adjustment items may be displayed. Press ▲/▼ to select the desired item.
3. Press MENU to Exit

On-Screen Display Menu



MENU OPERATION BUTTONS

Using the Remote Control

Use the following buttons on the remote control to operate the menu.

MENU: Press to open or close the menu screen.

◀▶/▲▼: Press to select a desired item on the screen or adjust a selected item.

ENTER: Press to go to the next step or complete the setting.

BACK: Press to return to the previous step.

Using the Control Panel Of The Tv

You can also operate the menu with the control panel of the TV.

Button operations on the control panel correspond to the ones on the remote control as shown below.



MENU: MENU on the remote control.

INPUT: ENTER on the remote control.

CH +/-: Cursor ▲▼ on the remote control.

VOL +/-: Cursor ▶◀ on the remote control.

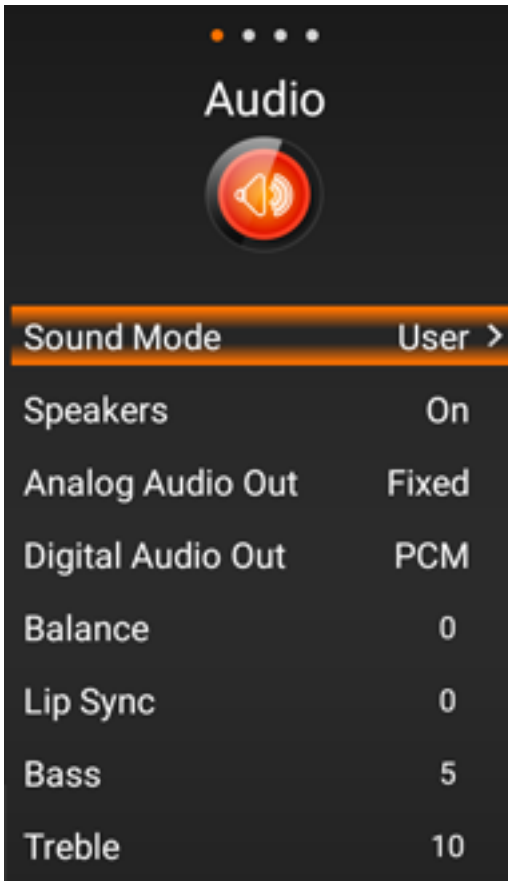

AUDIO

Note: For operating the on-screen display menu. See pages 24-26.

Sound Mode

Enter to select various sound mode presets

Movie/Music/Sport/User

Speakers

Turn the TV internal speakers on or off

Analog Audio Out

Set the output of the 3.5mm Analog Audio output. Fixed/Variable

Digital Audio Out

Set the output mode of the TosLink digital audio (Off/Dolby Digital/PCM)

Balance

Set the balance to the Left and Right speaker, default is 0 left and right equal output.

Lip Sync

Set this to adjust the audio delay related to video

Note: Bass and Treble adjustments available in User Audio preset only.

Bass

Adjust the low end audio frequency output (-12/+12) default 0

Treble

Adjust the high end audio frequency output (-12/+12) default 0

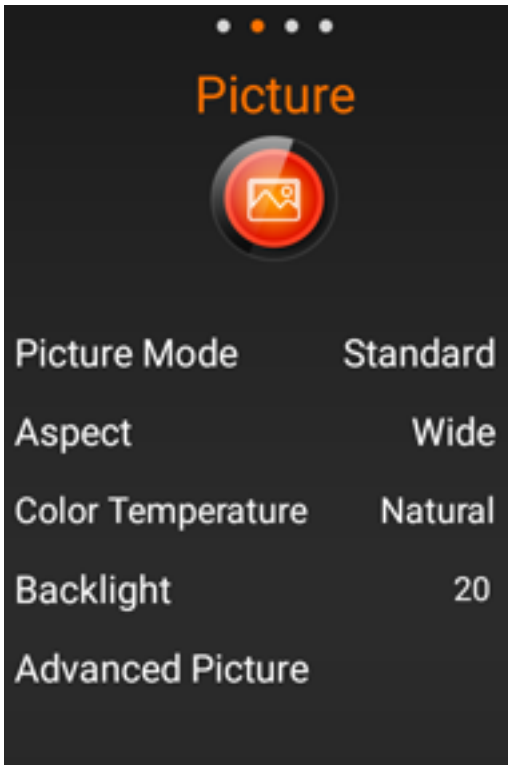

PICTURE

Note: For operating the on-screen display menu. See pages 24-26.

Picture Mode

Select Picture Mode Preset Settings (Standard/Movie/Vivid/Game/User/PC)

Aspect

Select the aspect mode used when displaying various content (Normal/Wide/Zoom/Stretch)

Color Temperature

Select the color temperature of the white areas in the video content (Natural/Warm/Computer/Cool)

Backlight

Set the backlight brightness (0-20)

Advanced Picture

Select this option to adjust various picture quality settings

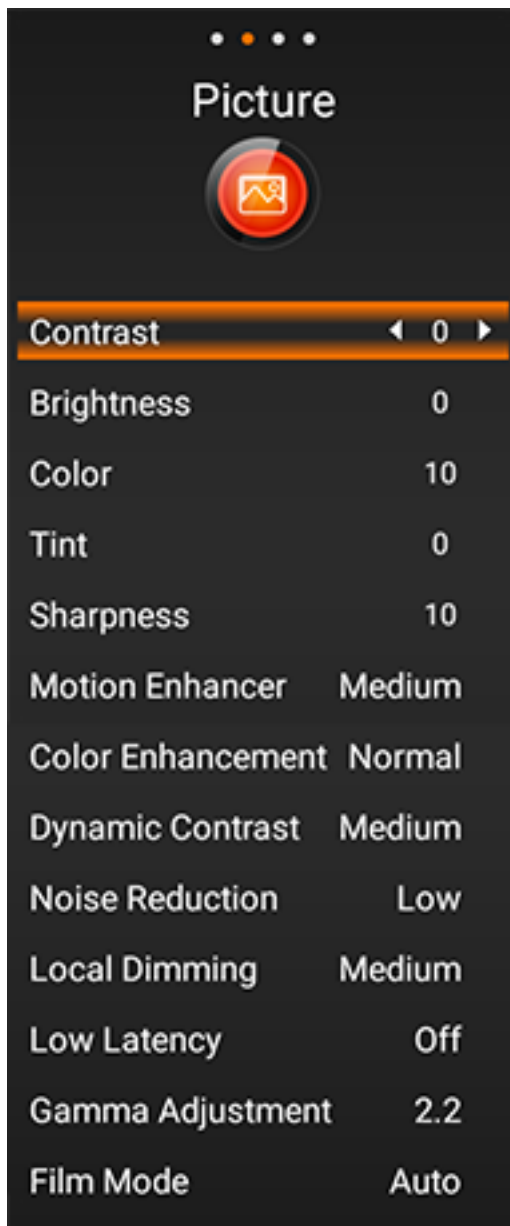

ADVANCED PICTURE

Note: For operating the on-screen display menu. See pages 24-26.

Contrast

Adjust the picture contrast

Brightness

Adjust the picture brightness

Color

Adjust the color saturation of the picture

Tint

Adjust the tint of the picture

Sharpness

Adjust the sharpness of the picture, useful when source is high resolution PC or graphics

Motion Enhancer

Adjust the sharpness of the picture displaying high motion video content

Color Enhancement

Adjust the enhancement of overall picture color

Dynamic Contrast

Contrast is adjusted automatically based on content (Off/Low/Medium/High)

Noise Reduction

Feature to remove digital artifacts contained in some video content (Off/Low/Medium/High)

Local Dimming

Backlight is dimmed in zones based on content (Off/Low/Medium/High)

Low Latency

Select On to reduce video delay when gaming.

Gamma Adjustment

Adjust the correction to the light and dark areas of the picture (Default 2.2) (Range from 1.8 to 2.4)

Film Mode

When film content is detected, picture will be optimized. For best picture, set to Auto

On-Screen Display Menu

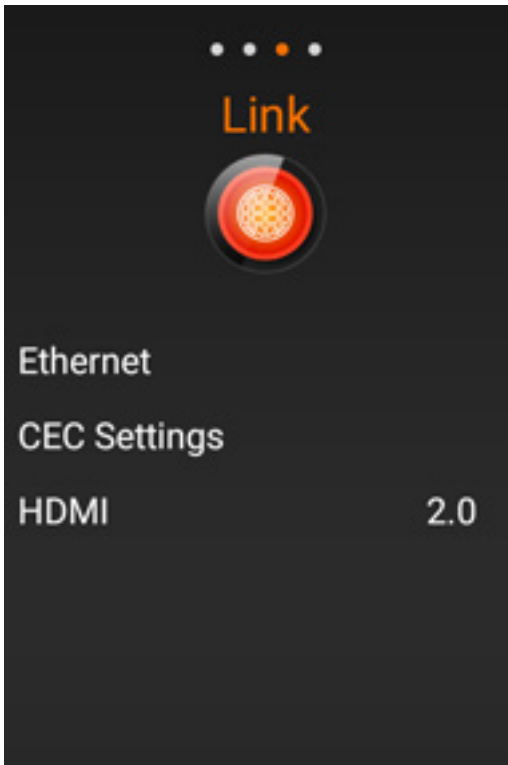

LINK

Note: For operating the on-screen display menu. See pages 24-26.

Ethernet

Select to change the ethernet network type from DHCP(Dynamic) or Static

CEC Settings

Select to change Link CEC Control settings

HDMI (Mode)

Select 2.0 for EDID 2.0 full 4k, Select 1.4 for legacy EDID 1.4 4k/30 support
Available only when HDMI input is selected

TV Mode

Select to change the tuner mode type (Antenna/Cable)

Auto Channel Scan

Select to scan and learn channels from the cable or antenna signal input.

Analog MTS

Select the default multichannel television sound used during a cable or antenna broadcast, Stereo, SAP or Mono. (default Stereo)

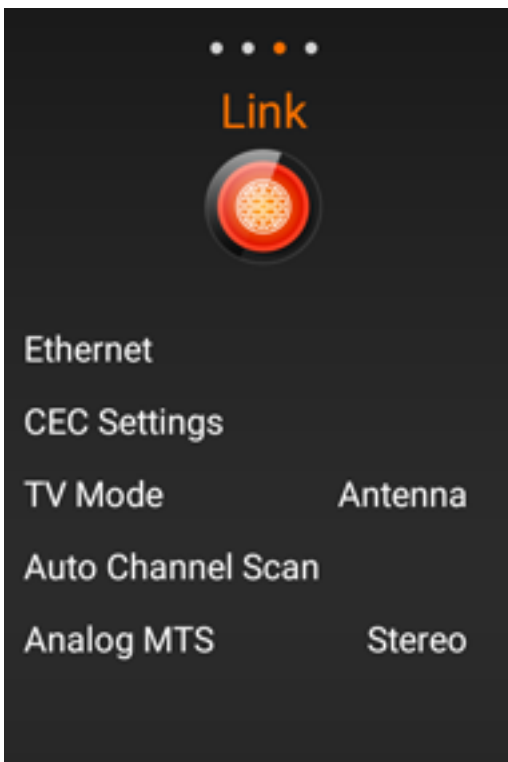

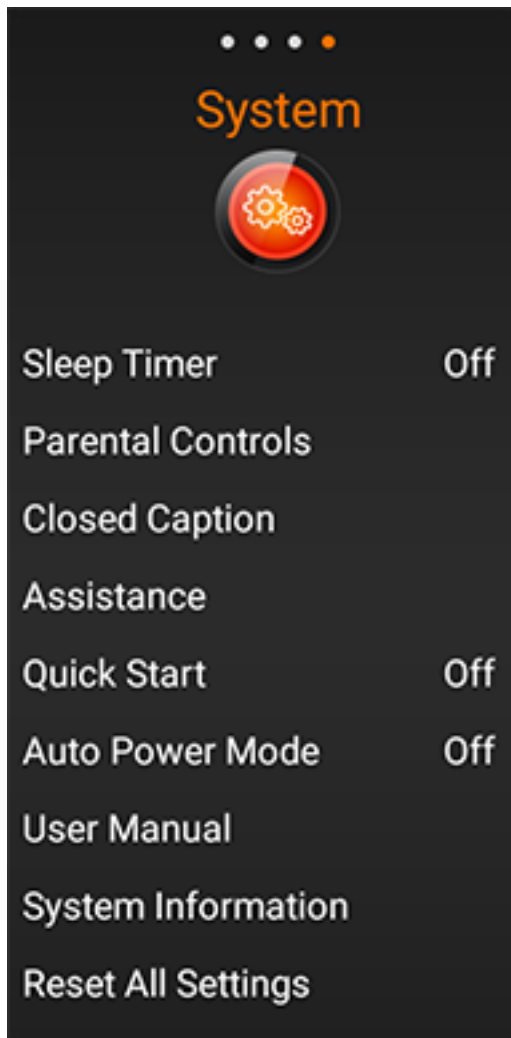

SYSTEM

Note: For operating the on-screen display menu. See pages 24-26.

Sleep Timer

Set the time for auto turn off of the TV
(30/60/90/120/180 minutes)
Same function as remote sleep button.

Parental Controls

Available only when TV(Tuner) input is selected.
Default password is 0000
Select parental controls on TV channels based on the contents rating.

Closed Caption

Available only when TV(Tuner) input is selected.
Select options for displaying closed caption text on the content.

Quick Start

Enable allows the TV to start faster when the power on button is pressed.
TV will use more power in this mode.
Must be enabled to fully enable IP control.

User Manual

Select this option to display the manual you are currently reading.

System Information

Displays detailed TV information, see page 4-21 for more details

Reset All Settings

Restore all TV settings to factory default

On-Screen Display Menu



SYSTEM

Note: For operating the on-screen display menu. See pages 24-26.

Model Name

SunBriteTV model number of your outdoor TV

Revision

Current firmware version

Input Source

Current source input selected

Video Timing

TBD

Content Frequency

Input source frame rate, 60(hz) is typical

Network Type

Ethernet - wired network connection to the rear RJ45 jack

IP Address

IPV4 network address assigned to the TV

Gateway

IPV4 network address of the local network gateway

Prefix Length

Number of bits in the subnet (24=255.255.255.0)

Pref. DNS

Preferred network name server

Alt. DNS

Alternate network name server

RJ45 MAC

Hardware address of the TV network adapter

USB Photo/Music/Video Playback

PREPARATION

You can connect the TV to a USB memory device to view pictures, listen to music, and watch videos.

Note:

- Depending on the USB memory device, the TV may not be able to recognize the recorded data.
- It may take time to read the recorded data if the USB memory device contains many files or folders.
- Use only alphanumeric characters for naming files.
- File names over 80 characters (may vary depending on character set) may not be displayed.

Connecting a USB Memory Device/USB Hard Drive

Insert the USB memory device with recorded photos, music or videos into the USB terminal on the TV.

- When connecting a USB hard drive, be sure to use a hard drive with an AC adapter.
- Do not remove a USB memory device or memory card from the TV while transferring files, using the slide show function, or switching screens, or before you exit "USB" from the INPUT list.
- Do not insert and remove a USB memory device/USB hard drive to and from the TV repeatedly.
- When using a card reader, be sure to insert a USB memory device first.

CAUTION:

- Do not use a USB extension cable when connecting a USB memory device to the USB terminal on the TV.
- Using a USB extension cable with the USB memory device may prevent the TV from performing correctly.

USB Photo/Music/Video Playback



SELECTING THE FOLDERS TO PLAY BACK

- To play back data on a USB memory device, insert the USB memory device on the TV.
- Use the following procedure to switch back to USB mode after switching from USB mode to another mode.

1. Select **MMP(USB)** from **INPUT** list screen.
2. Press **▲/▼** to select Video, Music or Photo, and then press **ENTER**.



3. Press **▲/▼** **◀▶** to select the desired folder, and then press **ENTER**.

USB Device Compatibility	
USB device	USB Memory, USB card reader (Mass Storage class), USB hard drive
File system	FAT/FAT32/NTFS (USB hard drive only)
Photo file format	JPEG (.jpg) (DCF2.0 compliant)
Music file format	MP3 (.mp3) Bitrate: 32k, 40k, 48k, 56k, 64k, 80k, 96k, 112k, 128k, 160k, 192k, 224k, 256k, 320kbps Sampling frequency: 32k, 44.1k, 48kHz



SELECTING THE FOLDERS TO PLAY BACK

Video File Format			
File Extension	Container	Video	Audio
.avi	AVI	MPEG-1 MPEG-4 SP/ ASP(XviD) MPEG-4 AVC (H.264) Motion JPEG	MPEG-Audio LPCM MS-ADPCM AC3
.mkv	MKV	MPEG-1 MPEG-2 MPEG-4 SP/ ASP(XviD) MPEG-4 AVC (H.264)	MPEG-Audio LPCM MS-ADPCM AC3
.asf .wmv	ASF WMV	MPEG-4 SP/ASP(XviD) WMV 7/8/9	LPCM WMA
.mp4	MP4	MPEG-4 SP/ ASP(XviD) MPEG-4 AVC (H.264) Motion JPEG	MPEG-Audio LPCM MS-ADPCM AC3
.mpg .mpeg	MPG	MPEG-1 MPEG-2	MPEG-Audio LPCM MS-ADPCM AC3

Note:

- Progressive format jpeg files are not supported.
- USB 1.1 devices may not be played properly.
- Operation using USB hubs is not guaranteed.
- Some video file formats may not be played depending on the file.
- Some images may not be displayed in the appropriate aspect ratio depending on the file format.

File Format Compatibility

Photo File Format	JPEG
Music File Format	LPCM, MP3
Video File Format	AVI, MKV, ASF, MP4, WMV, MPG

Note:

- Progressive format jpeg files are not supported.
- Some video file formats may not be played depending on the file or the server.
- WMV, ASF, MP4, MOV and AVI are not Home Network contents.

USB Photo/Music/Video Playback

PLAYING BACK FILES ON A USB MEMORY DEVICE

Note:

- The screen images in this section are for the USB mode.

Photo Mode

Viewing Thumbnails



Buttons for Thumbnail Operations

Buttons	Description
	Select a desired item.
	Setup options for photo viewing; file sort and slideshow interval time
ENTER	When selecting a folder icon: Enter this directory. When selecting a photo thumbnail: Start the slide show.
BACK	Return to the previous process.

PLAYING BACK FILES ON A USB MEMORY DEVICE (CONTINUE)

Slide Show

The photos displayed on the thumbnail selection screen are displayed as a slide show.

Buttons for slide show operation

Buttons	Description
BACK	Return to the thumbnail selection screen
Left Arrow	Previous file
Down Arrow	Displaying/hiding operation guidance.
Right Arrow	Next file

Note:

- Rotating photos only applies to the temporarily selected item and this setting is not saved.



PLAYING BACK FILES ON A USB MEMORY DEVICE (CONTINUE)

MUSIC MODE



Buttons for Music Mode

Buttons	Description
	Select a desired item.
ENTER	When selecting a folder icon: Enter this directory. When selecting a photo thumbnail: Start the slide show.
BACK	Return to the previous process.

PLAYING BACK FILES ON A USB MEMORY DEVICE (CONTINUE)

VIDEO MODE

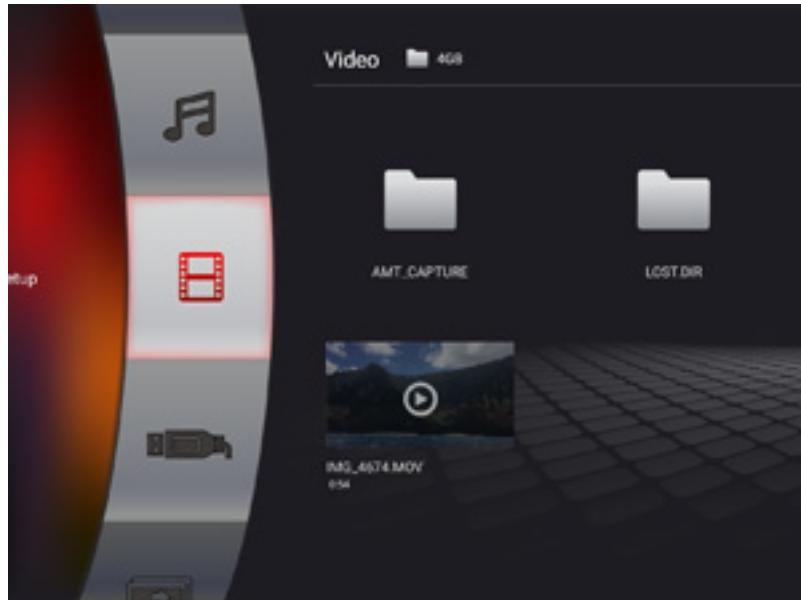

Buttons for File Selecting Operations

Buttons	Description
	Select a desired item.
ENTER	When selecting a folder icon: Enter this directory. When selecting a photo thumbnail: When selecting a video file: Play the video.
BACK	End playback and return to the previous process.



Using LINK Operation

CONTROLLING HDMI EQUIPMENT USING LINK CEC OPERATION

What's LINK Operation?

- Using the HDMI CEC (Consumer Electronics Control) protocol, with LINK Operation you can interactively operate compatible system equipment (Blu-ray disc equipment, AV amplifier, DVD).
- To access this function: System Operation > Initial Setup > Input Settings > Link Setup > Link Operation.

Note:

- For connecting the TV to LINK-compatible equipment, use commercially available cables.
- Point the remote control toward the TV, not to connected HDMI equipment.
- Video noise may occur depending on the type of HDMI cable used. Make sure to use an HDMI-certified cable.
- Up to 3 pieces of HDMI recording equipment and one AV amplifier can be connected using this system.
- These operations affect the HDMI equipment selected as the current input source. If the equipment does not operate, turn on the equipment and select the appropriate input source using INPUT.
- The LINK feature may not operate properly when an HDMI splitter or AV selector unit is used. These devices may cause interruptions to the image and/or sound.

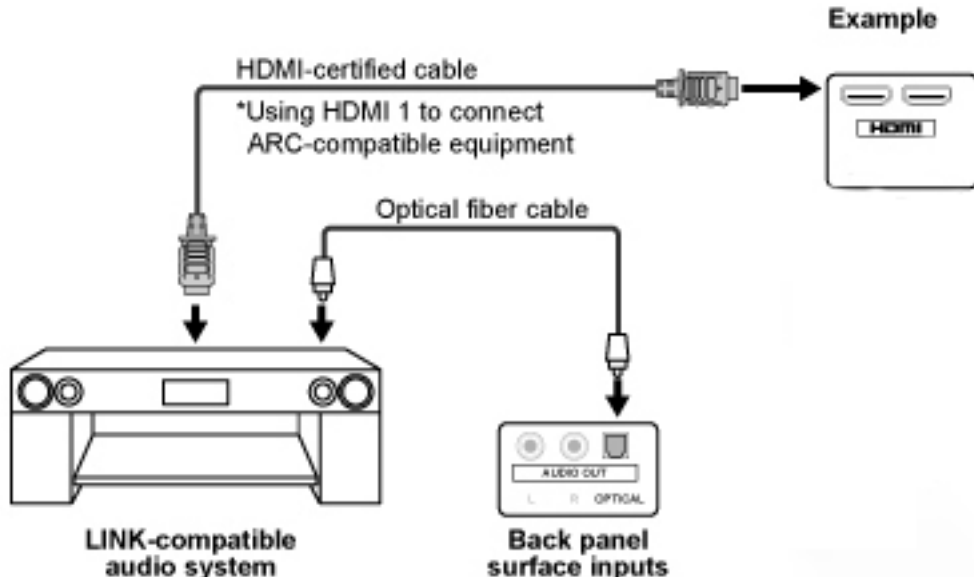

Connected LINK-compatible devices can be operated without changing the settings of the remote control unit.

Control the Link-Compatible Audio System

Set the volume of LINK-compatible audio system.

Note:

- The steps in "LINK Setup" on page 41 need to be completed beforehand.
- Refer to this operation manual and the operation manual of the LINK device to be used with this TV.

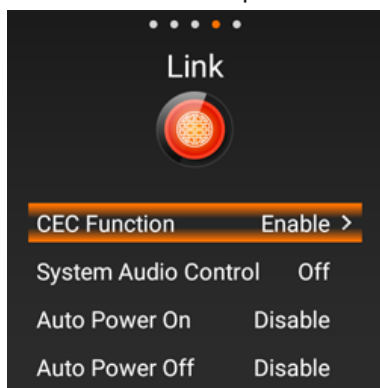



CONTROLLING HDMI EQUIPMENT USING LINK CEC OPERATION (CONTINUE)

LINK Setup

Make the settings to use LINK Operation. Set the settings with "Menu" > "Link" > "CEC Settings".

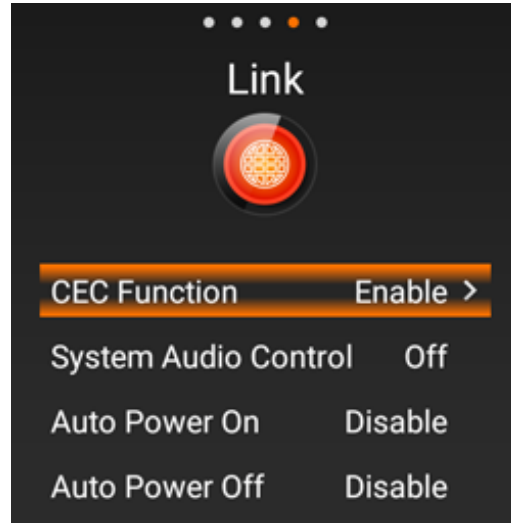

CEC Function

Select CEC Function to disable the LINK function even when a LINK-compatible HDMI device is connected to the TV. This function prevents the device from turning on or off unexpectedly due to a CEC command from the source device.

System Audio Control(ARC)

This function allows you to listen to the TV audio via audio equipment without using an optical fiber cable, which conventionally is required.

Requirements for using an ARC-compatible AV amplifier:

- ARC-compatible AV amplifier connected to the ARC-compatible HDMI terminal. (HDMI 2) (Refer to the operation manual of the ARC-compatible equipment for details.)
- Use of an ARC-compatible cable.

Note:

- If the TV audio cannot be output from the AV amplifier even after making the necessary settings, connect the TV to the AV amplifier with an optical fiber cable and select "Off".

Auto Power On

If this is enabled and the source device has CEC enabled the TV will automatically turn on and plays back the content from the HDMI source.

Auto Power Off

If this is enabled and the source device has CEC enabled the TV will automatically turn on and plays back the content from the HDMI source.

Appendix

TV STAND

- Before detaching (or attaching) the stand, make sure to turn off the TV and unplug the AC cord.

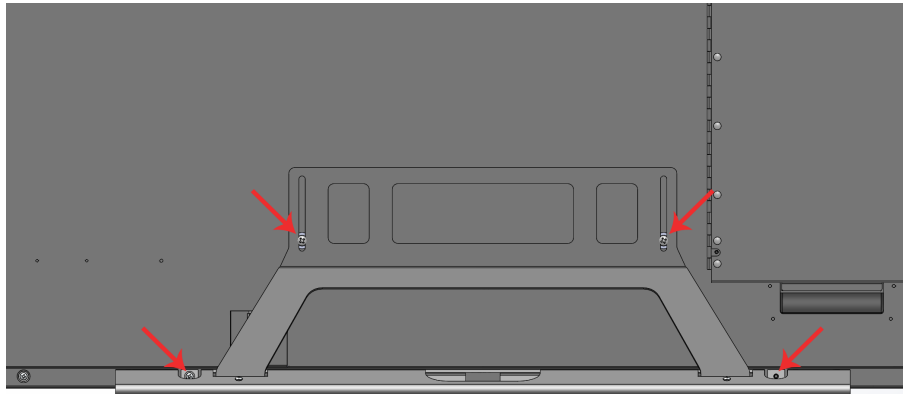

1. Unfasten the four screws used to secure the stand in place.

Example:

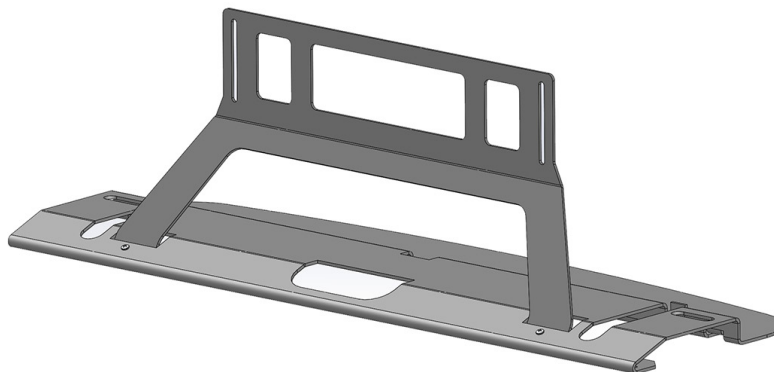

2. Attach the stand to the TV.

If necessary secure the stand to the table surface before attaching to the TV.

Secure the stand to the TV using all 4 screws as shown.

Note:

- Be sure to always carry the TV by two people holding it with two hands.

Appendix

OPTIONAL SPEAKER BAR

The optional speaker bar and required adapter cable is not included in the purchase of a SunBrite TV. These accessories are available at SunBriteTV.com, local dealer or reseller. Before detaching (or attaching) the speaker, make sure to turn off the TV and unplug the AC cord.



1. Mount the speaker bar to the bottom of the Veranda Outdoor TV.



2. Attach the 4 conductor Din adapter to the speaker bar connector and then plug the 3.5mm plug inside the cable bay into the speaker bar output.

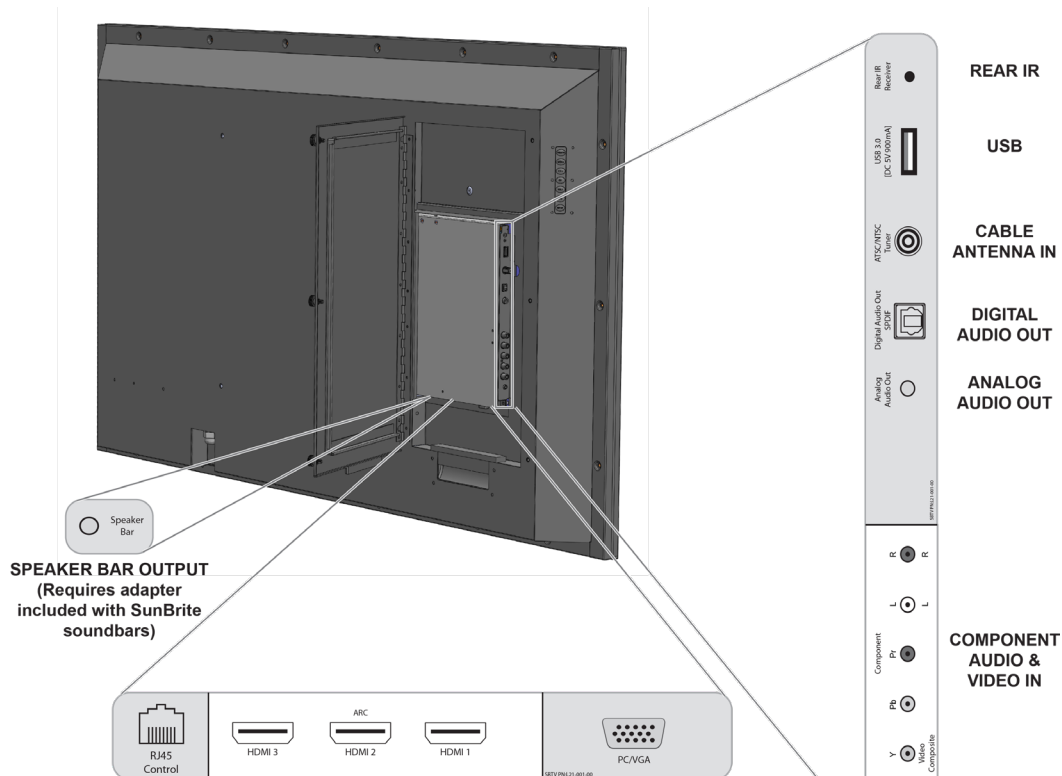

MOUNTING THE TV ON THE WALL

Standard dimensions for wall mount kits are shown below. Visit www.SunBriteTV.com for information on all available mounts.

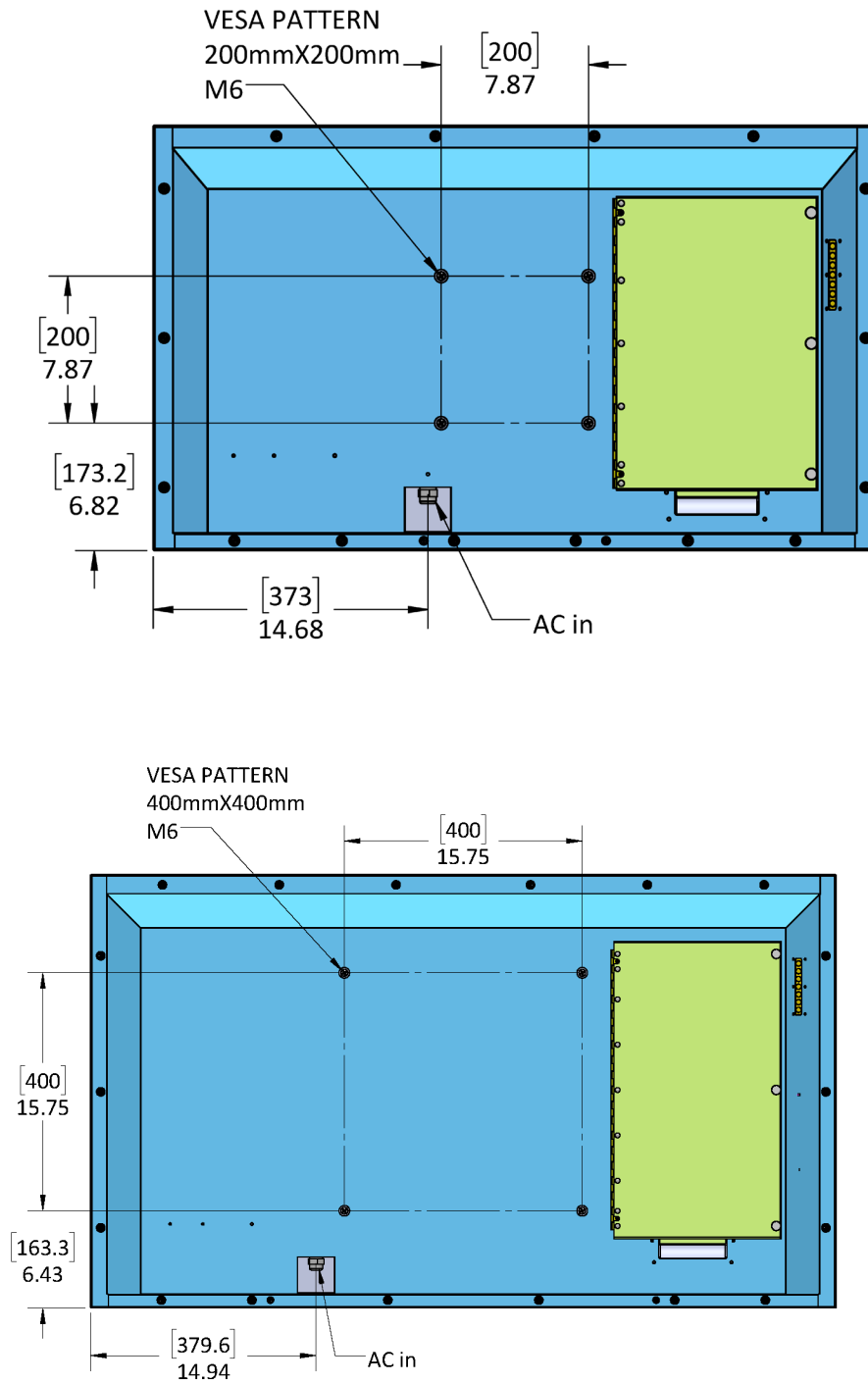

- The mounting means should be strong enough to bear the weight of the display.
- The wall mounting bracket should have UL or related approval

Appendix

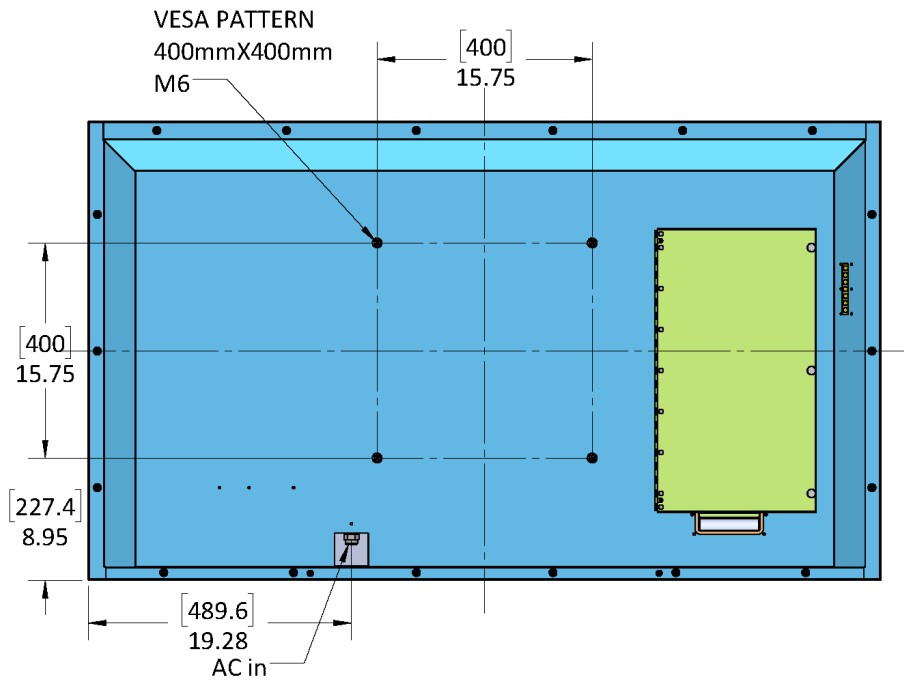

Wallmount Dimensions (A x B)	SB-V-43-4KHDR 200mm x 200mm
	SB-V-55-4KHDR SB-V-65-4KHDR 400mm x 400mm
Wallmount Screws	M6

Trouble	Solutions
<p>Cautions regarding use in high and low temperature environments</p> <p>When the unit is used in a low temperature space (e.g. room, office), the picture may leave trails or appear slightly delayed. This is not a malfunction, and the unit will recover when the temperature returns to normal.</p> <p>Do not leave the unit in a hot or cold location. Also, do not leave the unit in a location exposed to direct sunlight or near a heater, as this may cause the cabinet to deform and the front panel to malfunction.</p> <p>Storage temperature: -4°F to +140°F (-20°C to +60°C)</p>	

Appendix

The example of an error message displayed on a screen	Error code	Possible Solution
An incompatible audio signal has been received. Check the output device settings	—	This message is displayed when an audio format other than PCM, DTS or Dolby Digital is input. - Set the audio output format of connected external HDMI equipment to PCM or Dolby Digital. - Refer to the operation manual of the external equipment for setting details.

CARING FOR THE LCD PANEL:

1. To clean the LCD Panel, turn the TV off and gently wipe the surface of the display panel with a water damp microfiber, cotton or flannel cloth. (Do not use tissues, rags, sponges or paper towels which may damage the screen or leave behind lint).
2. If the LCD panel is very dirty, mix equal parts of isopropyl alcohol and distilled water in a clean spray bottle, and spray the mixture onto a microfiber, cotton or flannel cloth (do not spray the solution directly on the panel) and gently wipe the panel clean.
3. Keep the TV covered with the optional SunBriteTV Outdoor Dust Cover when not in use.
 - The fitted dust cover is designed to protect the LCD panel from harmful UV rays from direct sunlight, and keeps wind-blown objects from scratching the surface of the panel.
 - To order a Dust Cover, contact your Authorized SunBrite dealer, SunBrite Customer Care at 866.357.8688, or visit www.sunbrite.tv.

Troubleshooting

TROUBLESHOOTING

Problem	Possible Solution
No power	<ul style="list-style-type: none"> • Check if you pressed POWER on the remote control unit. • Is the AC cord disconnected? • Has the power been turned on?
Unit cannot be operated.	<p>External influences such as lightning, static electricity, may cause improper operation. In this case, operate the unit after first turning off the power of the TV or unplugging the AC cord and replugging it in after 1 or 2 minutes.</p>
Remote control unit does not operate.	<ul style="list-style-type: none"> • Is the equipment to be operated by the remote control unit set correctly? Press TV to set the remote control unit to the setting for operating the TV. • Are batteries inserted with polarity (+, -) aligned? • Are batteries worn out? (Replace with new batteries.) • Are you using it under strong or fluorescent lighting? • Is a fluorescent light illuminated near the remote control sensor?
Picture is cut off/with sidebar screen.	<p>Are screen mode adjustments such as picture size made correctly? Pages 21 to 23.</p>
Strange color, light color, or color misalignment	<ul style="list-style-type: none"> • Adjust the picture tone Pages 28-29. • Is the room too bright? The picture may look dark in a room that is too bright.
Power is suddenly turned off.	<ul style="list-style-type: none"> • Is the sleep timer set? Page 16 • Check the power control settings. Page 31
No picture	<ul style="list-style-type: none"> • Is connection to other components correct? • Is the correct input selected? Page 9 • If the PC image is not displayed, check the following: When connecting a laptop PC to the TV, check that display output mode of the PC is set to external monitor.
Picture quality of HD programs is poor.	<ul style="list-style-type: none"> • To enjoy HD images from external equipment, you are required to set up HDMI connection or component connection. • If the program content is not of HD quality, HD images cannot be displayed. Check that the program you are viewing provides HD images. • The HD cable/satellite set-top box may need to be configured to output HD images via cable/satellite. • The cable/satellite broadcast may not be in full 1080 HD or 4K
The TV sometimes makes a cracking sound.	<p>This is not a malfunction. This happens when the cabinet slightly expands and contracts according to change in temperature. This does not affect the TV's performance.</p>

Troubleshooting

Problem	Possible Solution
No sound	<ul style="list-style-type: none"> • Is connection to other components correct? • Is the volume too low? • Is "Variable" selected in "Output Select"? • Have you pressed MUTE on the remote control unit? • Check the audio output of the connected external equipment. Is the volume too low or muted? • When external equipment is connected via an HDMI cable, you may need to configure the audio to be output through the HDMI cable. • When audio is not output from external equipment connected to the HDMI 2 terminal, check the Digital Audio Out setting. • When connecting a PC via an HDMI-certified cable, check the following: <ul style="list-style-type: none"> • Is the audio output of the PC configured correctly? Check the audio output settings and output audio format in Sound Properties on the PC. • The audio formats compatible with this TV are PCM and Dolby Digital. With other formats, audio cannot be output.

Cautions Regarding Use In High And Low Temperature Environments

- When the unit is used in a low temperature space, the picture may leave trails or appear slightly delayed. This is not a malfunction, and the unit will recover when the temperature returns to normal.
- Do not leave the unit in a hot or cold location. Also, do not leave the unit in a location exposed to direct sunlight or near a heater, as this may cause the cabinet to deform and the front panel to malfunction.
- Storage temperature: -4°F to +140°F (-20°C to +60°C)

TROUBLESHOOTING - ERROR MESSAGE

The Example of an Error Message Displayed on a Screen	Error Code	Possible Solution
An incompatible audio signal has been received. Check the output device settings.	—	<p>This message is displayed when an audio format other than PCM, DTS or Dolby Digital is input.</p> <ul style="list-style-type: none"> • Set the audio output format of connected external HDMI equipment to PCM or Dolby Digital. • Refer to the operation manual of the external equipment for setting details.

Specifications

SunBriteTV Model SB-V-43-4KHDR

LCD Screen	43-inch diagonal Color Active Matrix TFT LED LCD
Resolution	3840 x 2160 UHD 4k HDR
Aspect Ratio	16:9
Backlight Brightness - Surface Luminance, white	400 nits (cd/m ²)
Contrast Ratio	4000:1
Frame Rate	60hz
H/V Viewing Angle	178° by 178°
Response Time	8 milliseconds
TV formats	2160p*, 1080p, 1080i, 720p, 720i, 480p, 480i * using HDMI only
Input Connectors:	
RF	Antenna/CATV (NTSC/ATSC/QAM) x1
HDMI	HDMI Input x3 (Supports HDMI 1.4, HDMI 2.0, HDCP 1.4 & HDCP 2.2) (ARC on HDMI2)
Video Composite	Composite Video x1, L/R Audio Inputs x1
Video Component	YPbPr plus Stereo Audio x1
RGB	VGA DB15hd (up to 1920 x 1080)
Control Set	Discrete IR Control, Concealed rear IR receiver, IP Control
Audio Out	Tos-Link Optical audio (Fixed) Analog 3.5mm (variable)
Speakers	20 Watt downfiring internal speakers or optional speaker bar (not included)
Exterior	Powder-coated aluminum
Colors	Black only
Input Power	100-240 VAC, 50-60 Hz 2.8A Max (75 watts/.7a@120v)
Operating Temp.	24° to 104° F. (0° to 40° C.)
Non-op. Temp.	-24° to 140° F. (-31° to 60° C.)
Accessories Included	Weatherproof remote control with battery
TV Dimensions	39" W x 23" H x 3.4" D 991mm W x 584mm H x 86mm D
TV Weight	30 lbs. (13.6 kgs)
Shipping Weight	40 lbs. (18.14 kgs)
Residential Warranty	1 year
Commercial Warranty	1 year
Vesa Mount Pattern	200mm x 200mm

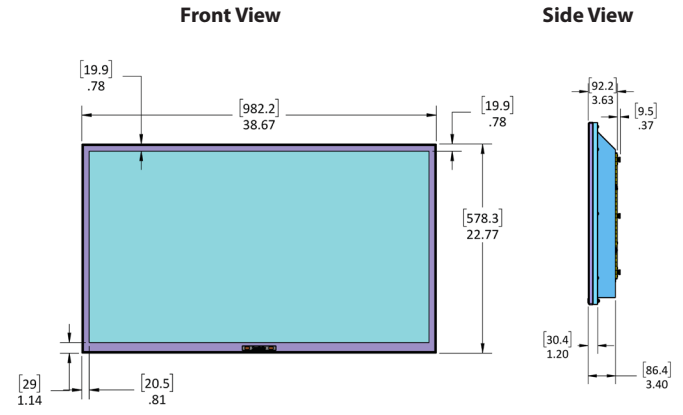

All dimensions are in inches, dimensions in [] are [metric]

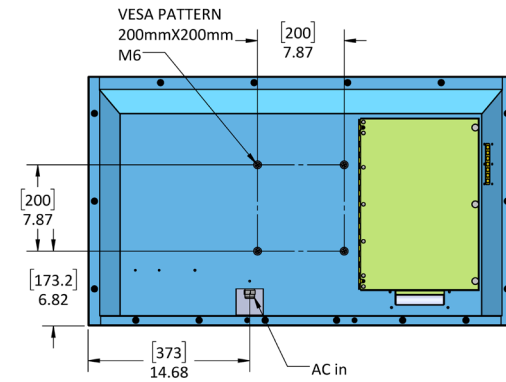

Specifications are subject to change.

Specifications

SunBriteTV Model SB-V55-4KHDR

LCD Screen	55-inch diagonal Color Active Matrix TFT LED LCD
Resolution	3840 x 2160 UHD 4k HDR
Aspect Ratio	16:9
Backlight Brightness - Surface Luminance, white	400 nits (cd/m ²)
Contrast Ratio	4000:1
Frame Rate	60hz
H/V Viewing Angle	178° by 178°
Response Time	8 milliseconds
TV formats	2160p*, 1080p, 1080i, 720p, 720i, 480p, 480i * using HDMI only
Input Connectors:	
RF	Antenna/CATV (NTSC/ATSC/QAM) x1
HDMI	HDMI Input x3 (Supports HDMI 1.4, HDMI 2.0, HDCP 1.4 & HDCP 2.2) (ARC on HDMI2)
Video Composite	Composite Video x1, L/R Audio Inputs x1
Video Component	YPbPr plus Stereo Audio x1
RGB	VGA DB15hd (up to 1920 x 1080)
Control Set	Discrete IR Control, Concealed rear IR receiver, IP Control
Audio Out	Tos-Link Optical audio (Fixed) Analog 3.5mm (variable)
Speakers	20 Watt downfiring internal speakers or optional speaker bar (not included)
Exterior	Powder-coated aluminum
Colors	Black only
Input Power	100-240 VAC, 50-60 Hz 2.8A Max (125 watts/1.0a@120v)
Operating Temp.	24° to 104° F. (0° to 40° C.)
Non-op. Temp.	-24° to 140° F. (-31° to 60° C.)
Accessories Included	Weatherproof remote control with battery
TV Dimensions	49.4" W x 28.6" H x 3.4" D 1254mm W x 726mm H x 86mm D
TV Weight	47 lbs. (21.3 kgs)
Shipping Weight	63 lbs. (28.5 kgs)
Residential Warranty	1 year
Commercial Warranty	1 year
Vesa Mount Pattern	400mm x 400mm

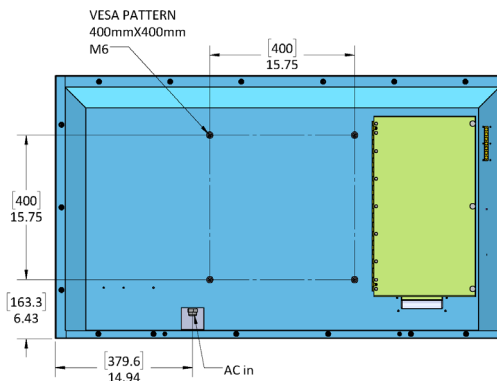
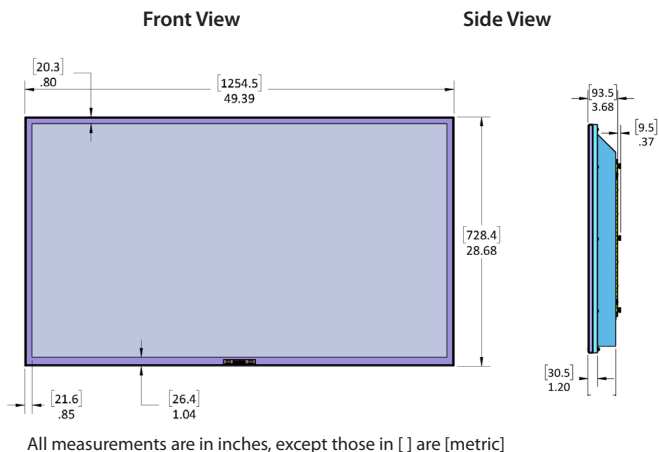

Specifications

SunBriteTV Model SB-V-65-4KHDR

LCD Screen	65-inch diagonal Color Active Matrix TFT LED LCD
Resolution	3840 x 2160 UHD 4k HDR
Aspect Ratio	16:9
Blacklight Brightness - Surface Luminance, white	400 nits (cd/m ²)
Contrast Ratio	4000:1
Frame Rate	60hz
H/V Viewing Angle	178° by 178°
Response Time	8 milliseconds
TV formats	2160p*, 1080p, 1080i, 720p, 720i, 480p, 480i * using HDMI only
Input Connectors:	
RF	Antenna/CATV (NTSC/ATSC/QAM) x1
HDMI	HDMI Input x3 (Supports HDMI 1.4, HDMI 2.0, HDCP 1.4 & HDCP 2.2) (ARC on HDMI2)
Video Composite	Composite Video x1, L/R Audio Inputs x1
Video Component	YPbPr plus Stereo Audio x1
RGB	VGA DB15hd (up to 1920 x 1080)
Control Set	Discrete IR Control, Concealed rear IR receiver, IP Control
Audio Out	Tos-Link Optical audio (Fixed) Analog 3.5mm (variable)
Speakers	20 Watt downfiring internal speakers or optional speaker bar (not included)
Exterior	Powder-coated aluminum
Colors	Black only
Input Power	100-240 VAC, 50-60 Hz 2.8A Max (205 watts/1.8a@120v)
Operating Temp.	24° to 104° F. (0° to 40° C.)
Non-op. Temp.	-24° to 140° F. (-31° to 60° C.)
Accessories Included	Weatherproof remote control with battery
TV Dimensions	58" W x 33.6" H x 3.5" D 1473mm W x 838mm H x 89mm D
TV Weight	69 lbs. (31.3 kgs)
Shipping Weight	90 lbs. (40.8 kgs)
Residential Warranty	1 year
Commercial Warranty	1 year
Vesa Mount Pattern	400mm x 400mm

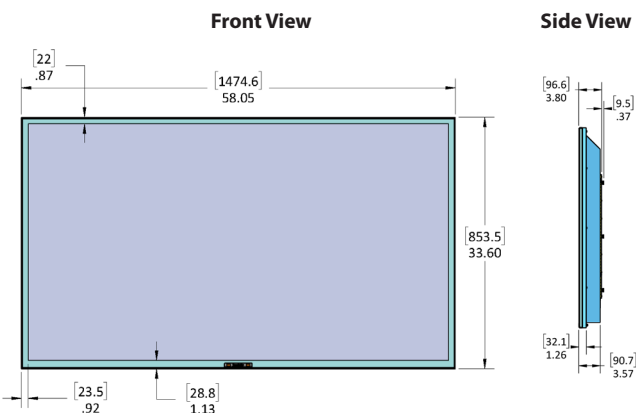

All dimensions are in inches, dimensions in [] are [metric]

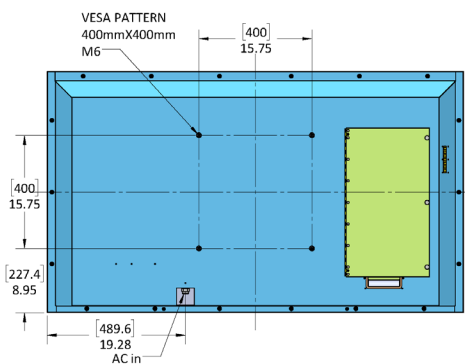

Specifications are subject to change.

SunBrite[®]

True Outdoor Television

www.SunBrite.com