



VTrak D5000 Series

High-Availability Storage System

Product Manual

Version 1.0

About This Manual

This Product Manual describes how to setup, use, and maintain the VTrak D5300, VTrak D5320, Vtrak D5600, and VTrak D5800 external storage subsystems.

This manual includes a full table of contents, index, chapter task lists and numerous cross-references to help you find the specific information you are looking for.

The terms “VTrak D5000” or “subsystem” are used in examples or descriptions throughout this manual to refer to any of the available VTrak D5000 Series models. The terms “unit” or “device” can refer to any VTrak D5000 Series or VTrak J5000 Series model.

Manual Overview

The manual is organized into chapters as follows:

- “Introduction” on page 1, this chapter provides a general overview of the available devices in the VTrak D5000 Series.
- “Hardware Installation” on page 13 describes the steps necessary for installing subsystem hardware including installing hard disks and placing the device into a rack system.
- “WebPAM PROe - System Configuration” on page 51 provides a more detailed description of the various menus used for managing the VTrak D5000 Series and connected VTrak J5000 Series expansion devices.
- “Managing with the CLI” on page 136 describes using the CLI to manage the VTrak D5000 Series through the network or via serial connection.
- “Contacting Technical Support” on page 228 includes how to contact technical support, how to return a system for repair, and warranty information.

This manual includes are four levels of notices:



Warning

A Warning notifies you of probable equipment damage or loss of data, or the possibility of physical injury, and how to avoid them.



Caution

A Caution informs you of possible equipment damage or loss of data and how to avoid them.



Important

An Important message calls attention to an essential step or point required to complete a task, including things often missed.



Note

A Note provides helpful information such as hints or alternative ways of doing a task.

ABOUT THIS MANUAL	I
MANUAL OVERVIEW	II
INTRODUCTION	1
THIN PROVISIONING	1
VTRAK D5000 SERIES MODELS	2
VTRAK J5000 SERIES MODELS	2
SPECIFICATIONS	3
HARDWARE	6
FRONT OF VTRAK D5800 AND D5600	6
FRONT OF VTRAK D5300 AND D5320	8
BACK OF VTRAK D5800 AND D5600	9
BACK OF VTRAK D5300 AND D5320	11
HARDWARE INSTALLATION	13
UNPACKING	14
PACKING LIST	14
MOUNTING THE VTRAK ENCLOSURE IN A RACK	15
MOUNTING THE VTRAK D5300/J5320	19
INSTALLING PHYSICAL DRIVES	22
NUMBER OF DRIVES REQUIRED	22
DRIVE SLOT NUMBERING	23
INSTALLING YOUR DRIVES	25
2.5-INCH HARD DISK DRIVES	27
MAKING MANAGEMENT CONNECTIONS	29
NETWORK MANAGEMENT CONNECTION	30
SERIAL MANAGEMENT CONNECTION	31
MAKING DATA CONNECTIONS	32
FIBER OPTIC (SFP+) DATA PATH	32
SFP+ FIBER OPTIC SAN CONNECTIONS	33
SFP+ FIBER OPTIC DAS CONNECTIONS	33
FIBRE CHANNEL SAN DATA PATH	34
FIBRE CHANNEL SAN CONNECTIONS	35
FIBER CHANNEL DAS DATA PATH	36
FIBRE CHANNEL DAS CONNECTIONS	36
VTRAK D5000 WITH JBOD EXPANSION	37
VTRAK D5800 SSD DATA CACHE MODULE	39
CONNECTING THE POWER	40

POWER ON	41
FRONT LED BEHAVIOR	42
VTRAK D5600 / VTRAK D5800 POWER SUPPLY LEDs.....	45
VTRAK D5300 / VTRAK D5320 POWER SUPPLY LEDs.....	46
CONTROLLER LEDs	47
CONTROLLER LED BEHAVIOR	48
RESETTING THE DEFAULT PASSWORD.....	50
WebPAM PROE - SYSTEM CONFIGURATION	51
LOGGING INTO WEBPAM PROE	52
CHOOSING THE DISPLAY LANGUAGE	53
PERUSING THE INTERFACE	54
LOGGING OUT OF WEBPAM PROE	56
VIEWING THE STORAGE NETWORK.....	57
LOGGING ONTO A SUBSYSTEM	57
DASHBOARD	58
GENERATING A SERVICE REPORT	59
CREATING A SHARED STORAGE POOL.....	60
POOL LIST	62
EXTENDING A STORAGE POOL WITH JBOD	62
CREATING SPARE DRIVE.....	63
CREATING AN SSD CACHE	65
CREATING A VOLUME	66
VOLUME LIST.....	67
SNAPSHOTS.....	68
CLONES.....	69
ROLLBACKS	70
LUN MAPPING AND MASKING	71
ADDING A LUN MAP	71
EDITING A LUN MAP.....	72
DELETING A LUN MAP	73
ENABLING AND DISABLING LUN MASKING	73
MANAGEMENT USER	74
MAKING MAINTENANCE MODE SETTINGS	75
ADDING A NEW USER	76
CHANGING USER SETTINGS	77
CHANGING USER PASSWORDS	77
DELETING A USER	78

SETTING USER EVENT SUBSCRIPTIONS	78
DEVICE	79
VIEWING SUBSYSTEM INFORMATION	79
RESTARTING THE SUBSYSTEM	80
SHUTTING DOWN THE SUBSYSTEM	81
RESTARTING THE SUBSYSTEM AFTER A SHUTDOWN	81
DEVICE VIEW	82
VIEWING ENCLOSURE INFORMATION	84
LOCATING AN ENCLOSURE	84
MAKING CONTROLLER SETTINGS	85
VIEWING CONTROLLER INFORMATION	86
BUZZER SETTINGS	88
SILENCING THE BUZZER	88
MANAGING PHYSICAL DRIVES	89
VIEWING PHYSICAL DRIVE INFORMATION	89
MAKING GLOBAL PHYSICAL DRIVE SETTINGS	90
MANAGING UPS UNITS	91
VIEWING UPS INFORMATION	91
MAKING UPS SETTINGS	92
MANAGING INITIATORS	93
ADDING A FIBRE CHANNEL OR iSCSI INITIATOR	93
VIEWING INITIATORS	94
DELETING AN INITIATOR.....	94
MANAGING NETWORK CONNECTIONS	95
MAKING VIRTUAL MANAGEMENT PORT SETTINGS	95
MAKING MAINTENANCE MODE PORT SETTINGS	96
MANAGING FIBRE CHANNEL CONNECTIONS	97
VIEWING FIBRE CHANNEL NODE INFORMATION.....	97
VIEWING FIBRE CHANNEL PORT INFORMATION	98
MAKING FIBRE CHANNEL PORT SETTINGS	99
PORT SETTING INFORMATION.....	99
VIEWING FIBRE CHANNEL PORT STATISTICS.....	100
VIEWING FIBRE CHANNEL LOGGED-IN DEVICES	100
VIEWING FIBRE CHANNEL INITIATORS ON THE FABRIC	101
VIEWING FIBRE CHANNEL SFPs.....	101
MANAGING iSCSI CONNECTIONS	102
VIEWING iSCSI TARGET INFORMATION.....	102

MAKING iSCSI TARGET SETTINGS	103
VIEWING A LIST OF iSCSI SESSIONS	104
VIEWING iSCSI SESSION INFORMATION	104
DELETING AN iSCSI SESSION	105
VIEWING iSCSI iSNS INFORMATION	106
MAKING iSCSI iSNS SETTINGS	106
VIEWING A LIST OF iSCSI CHAPs	107
ADDING iSCSI CHAPs	107
MAKING iSCSI CHAP SETTINGS	108
DELETING iSCSI CHAPs	108
USING THE EVENT VIEWER	109
VIEWING EVENTS	110
SAVING EVENTS	110
CLEARING EVENTS	110
MANAGING USERS	111
VIEWING USER INFORMATION	111
CREATING A USER	111
MAKING USER SETTINGS	112
CHANGING USER PASSWORDS	113
DELETING A USER	113
SETTING USER EVENT SUBSCRIPTIONS	114
VIEWING SERVICES	115
EMAIL SERVICE	116
STOPPING EMAIL SERVICE	116
RESTARTING EMAIL SERVICE	116
MAKING EMAIL SETTINGS	117
SLP SERVICE	118
STOPPING SLP SERVICE	118
RESTARTING SLP SERVICE	118
MAKING SLP SETTINGS	119
WEBSERVER SERVICE	119
STOPPING WEBSERVER SERVICE	119
RESTARTING WEBSERVER SERVICE	120
MAKING WEBSERVER SETTINGS	120
SSH SERVICE	121
STOPPING SSH SERVICE	121
RESTARTING SSH SERVICE	121

MAKING SSH SETTINGS	122
SSH PUBLIC KEY MANAGEMENT	122
MANAGING BACKGROUND ACTIVITIES	123
VIEW CURRENT BACKGROUND ACTIVITIES	124
VIEW SCHEDULED BACKGROUND ACTIVITIES	124
ADD A SCHEDULED BACKGROUND ACTIVITY	124
CHANGE A BACKGROUND ACTIVITY SCHEDULE	126
ENABLE/DISABLE SCHEDULED BACKGROUND ACTIVITY	127
DELETE A SCHEDULED BACKGROUND ACTIVITY	127
MEDIA PATROL	128
STARTING, STOPPING, PAUSING AND RESUMING MEDIA PATROL.....	128
REDUNDANCY CHECK	129
STARTING, STOPPING, PAUSING AND RESUMING REDUNDANCY CHECK	129
REBUILD	130
STARTING A REBUILD	130
RESTORE FACTORY DEFAULT SETTINGS	131
EXPORT USER DATABASE	133
EXPORT SERVICE REPORT	133
EXPORT CONFIGURATION SCRIPT, NAS CONFIGURATION, NAS ACCOUNT	134
IMPORT USER DATABASE	135
IMPORT CONFIGURATION SCRIPT, NAS CONFIGURATION, NAS ACCOUNT	136
UPDATE FIRMWARE	137
AUTOMATIC RESTART	138
MANAGING WITH THE CLI	139
MAKING A SERIAL CONNECTION	139
LOGGING INTO THE CLI	140
TABLE OF SUPPORTED COMMANDS	141
NOTES AND CONVENTIONS	145
CONTACTING TECHNICAL SUPPORT	231
LIMITED WARRANTY	235
DISCLAIMER OF OTHER WARRANTIES.....	236
YOUR RESPONSIBILITIES	237
RETURNING THE PRODUCT FOR REPAIR.....	237

INTRODUCTION

The VTrak D5000 Series offers an alternative approach to the storage management technology available in the VTrak Fibre Channel storage. The VTrak D5000 uses storage pools and storage volumes, including the option of using thin provisioning or full provisioning, while still ensuring data security with proven RAID redundancy. Additionally, the VTrak D5000 features Snapshot, Clone and SSD Caching capability. These new features are described in this introduction, along with a brief description of how to setup and use them on the VTrak D5000 system.

Thin Provisioning

The VTrak D5000 Series introduces *thin provisioning* to the VTrak line of storage network hardware. Thin provisioning is a process used for management of a storage area network (SAN) where storage capacity for a client devices is reserved and allocated on demand using a shared storage pool. The storage pool is made up of physical hard disks arranged in a RAID (typically RAID5 or RAID6) and further organized as one or more volumes. Thin provisioning allows the totally theoretical capacity of the contained volumes to exceed the physical capacity of the hard disks that make up the storage pool. In contrast, full or 'fat' provisioning does not allow the total capacity of the volumes in a shared pool to exceed the physical capacity of the disks in the pool. The VTrak D5000 allows the administrator to create shared storage volumes using either thin provisioning or full provisioning.

Thin provisioning is used for flexible storage planning, greater control and optimization of storage utilization and continuous storage provisioning. Rather than allocating storage space upfront, thin provisioning provides a SAN's connected devices with storage on demand, dynamically according to the workload.

With thin provisioning, a connected device can appear to have more than the actual storage capacity.

VTrak D5000 Series Models

All models are equipped with two power supplies.

Model	Controller Units	Interface	Number of Drives
D5800xD	2	2 x 10G SFP+ Fiber Optic	24(LFF) + 4(SFF)
D5800xS	1	2 x 10G SFP+ Fiber Optic	24(LFF) + 4(SFF)
D5800fxD	2	2 x 10G SFP+ Fiber Optic / 4 x Fibre Channel	24(LFF) + 4(SFF)
D5800fxS	1	2 x 10G SFP+ Fiber Optic / 4 x Fibre Channel	24(LFF) + 4(SFF)
D5600xD	2	2 x 10G SFP+ Fiber Optic	16
D5600xS	1	2 x 10G SFP+ Fiber Optic	16
D5600fxD	2	2 x 10G SFP+ Fiber Optic / 4 x Fibre Channel	16
D5600fxS	1	2 x 10G SFP+ Fiber Optic / 4 x Fibre Channel	16
D5300xD	2	2 x 10G SFP+ Fiber Optic	12
D5300xS	1	2 x 10G SFP+ Fiber Optic	12
D5300fxD	2	2 x 10G SFP+ Fiber Optic / 4 x Fibre Channel	12
D5300fxS	1	2 x 10G SFP+ Fiber Optic / 4 x Fibre Channel	12
D5320xD	2	2 x 10G SFP+ Fiber Optic	24 (2.5")
D5320xS	1	2 x 10G SFP+ Fiber Optic	24 (2.5")
D5320fxD	2	2 x 10G SFP+ Fiber Optic / 4 x Fibre Channel	24 (2.5")
D5320fxS	1	2 x 10G SFP+ Fiber Optic / 4 x Fibre Channel	24 (2.5")

VTrak J5000 Series Models

Model	Controller Units	Interface	Number of Drives	Power Supplies
J5800	2	SFF-8644 SAS	24	2
J5600	2	SFF-8644 SAS	16	2
J5300	2	SFF-8644 SAS	12	2
J5320	2	SFF-8644 SAS	24 (2.5")	2

Note: VTrak J5000 Series also available with single controller.

Specifications

Form factor	2U, 3U, and 4U 19" rack mount
Drives supported	12 Gb/s or 6 Gb/s SAS, 6 Gb/s SATA HDD and SSD Supports mix of SAS and SATA drives simultaneously in the same enclosure. SAS drives are recommended for better performance.
I/O Ports per D5000 controller	Two 10G SFP+ Four 16G Fibre Channel ports (16 / 8 / 4 Gb/s)* Two 12G SFF-8644 mini-SAS connectors per controller for JBOD expansion.
SSD Cache	VTrak D5800 is shipped with a data cache module featuring 4 disk carriers for SSD drives.
Storage Expansion	Cascade up to twelve VTrak J5000 JBOD expansion units. VTrak J5000 Series supports 12, 16 or 24 drives per device.
Operational	
RAID support	0, 1, 5, 6, 10, 50, 60
RAID stripe size	64K, 128K, 256K, 512K, 1MB
Hot Spare Drives	Global, Dedicated and Revertible option

* VTrak D5000 controllers supporting Fiber Channel are not available in all markets.

General	Description			
Power Supplies	Efficient 80 PLUS GOLD certified redundant PSU			
Current (Maximum)	9A @ 100 VAC; 4A @ 240 VAC			
Power Conversion Efficiency	>80% @ 110V (>20% load); >80% @ 240V (>20% load)			
	D5320	D5300	D5600	D5800
Dimensions (Height, Width, Depth)	88 x 46.7 x 420 mm 3.5 x 17.6 x 16.5 in	88 x 446.7 x 507 mm 3.5 x 17.6 x 19.96 in	131 x 446.7 x 507 mm 5.2 x 17.6 x 19.96 in	174.4 x 446.7 x 507 mm 6.87 x 17.6 x 19.96 in
Weight (w/o drives) (w drives)	16.2 Kg (35.7 lbs) 20.5 Kg (45.2 lbs)	18.9 Kg (41.7 lbs) 26.8 Kg (59.1 lbs)	22.3 Kg (50.7 lbs) 33.4 Kg (73.6lbs)	26.8 Kg (59.1 lbs) 43.8 Kg (96.6 lbs)

Safety & Environment	Description
EMI / RFI Statements	EMC Class A: CE, FCC, VCCI, BSMI, RCM Safety: IEEE CB, UL/cUL and TUV
Environmental Standards	RoHS, GreenPC, WEEE
Temperature Range	Operational: 5° to 35°C (41° to 95°F) Non-Operational: -40° to 60°C (-40° to 140°F)
Humidity Range	Operational: 20% to 80% (Non-Condensing) Non-Operational: ~ 95% (Non-Condensing)
Acoustic Noise Levels	< 60dB, 25C
Shock	Operational: 5G, 11 ms duration Non-Operational: 30G, 11ms duration
Vibration	Operational: 0.2G, 5 to 500Hz (sine wave) ; 0.41G, 3-10-200-500Hz (Random) , Non-Operational: 1G, 5 to 500Hz (sine wave) ; 2.256G, 5-80-350-500Hz (Random)

Support & Warranty	Description
Support	<ul style="list-style-type: none"> • 24 hour, 7 days a week, 365 days a year e-mail and phone support (English only) • 24 hour, 7 days a week, 365 days a year access to PROMISE support site • Firmware and compatibility lists
Warranty	3-year full system limited warranty, optional extended warranty, on site parts replacement program

Hardware

The following section provides a summary of the front and back panel hardware features of the VTrak D5000 Series enclosures.

Front of VTrak D5800 and D5600

VTrak D5800/D5600 enclosures feature handles on each side used to secure the enclosure to an equipment rack.

Front view of VTrak D5800



Front view of VTrak D5600

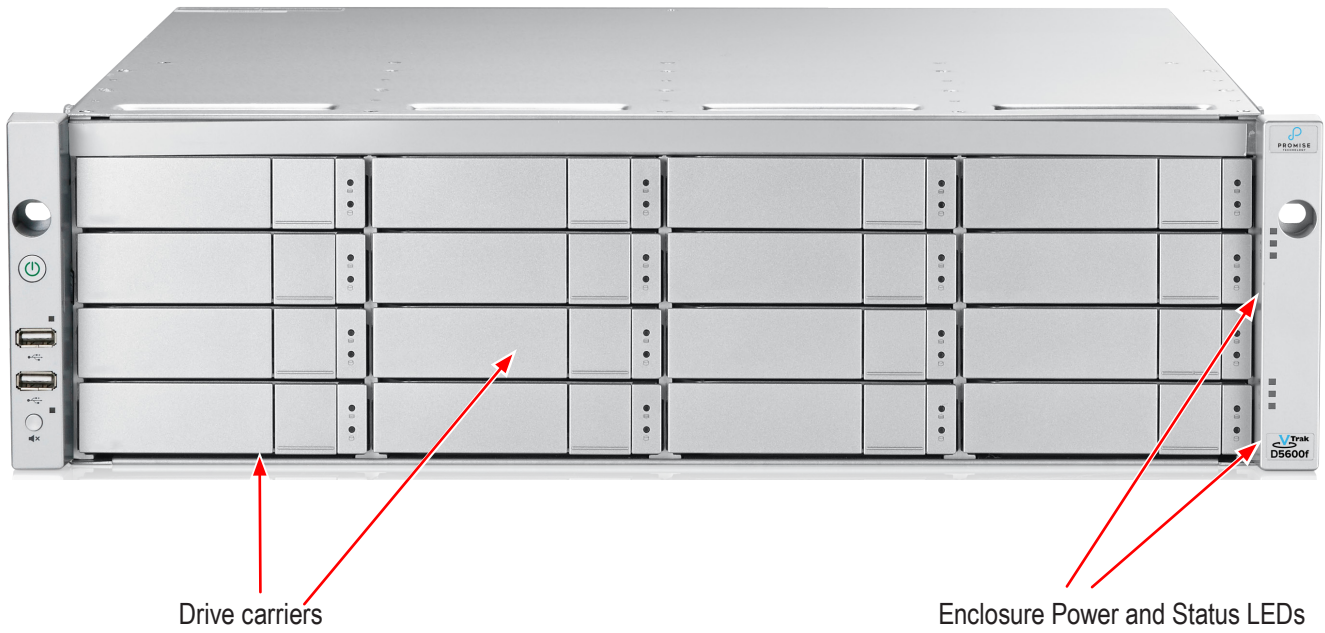

Front of VTrak D5300 and D5320

The front panel of VTrak D5000 enclosures provide access to storage disk drive carriers, a view of drive status LED indicators located on the front of each drive carrier, the LED indicators for system monitoring.

See the illustrations of the front view of each model below.

VTrak D5300 front view

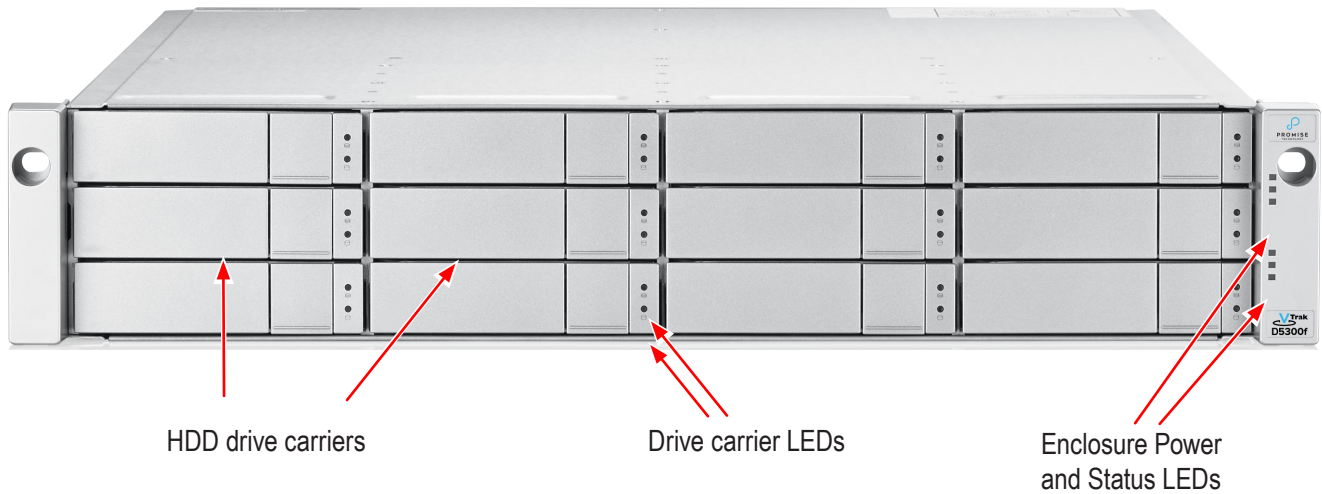

VTrak D5320 front view

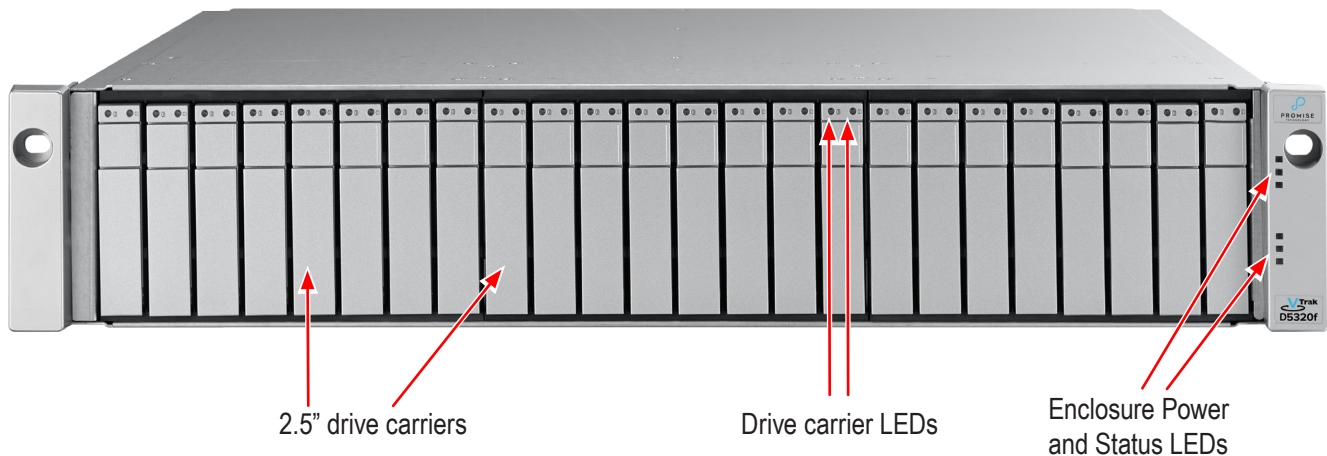

Back of VTrak D5800 and D5600

The rear of the VTrak D5000 Series enclosure provides access to the power supply units, which include the cooling fans, and the system controller(s).

Each controller has two RJ-45 Gigabit Ethernet ports used for management, an RS-232 serial management port using an RJ-11 connector, two 10 Gb/s iSCSI ports (SFP+ ports), two SAS Expansion ports for additional drive enclosures, and various LED indicators which are described below. In some markets, a special release of the VTrak D5000 controller includes four Fibre Channel data ports per controller using standard SFP sockets. The controllers pictured in this section display the Fibre Channel version.

Back view of VTrak D5800

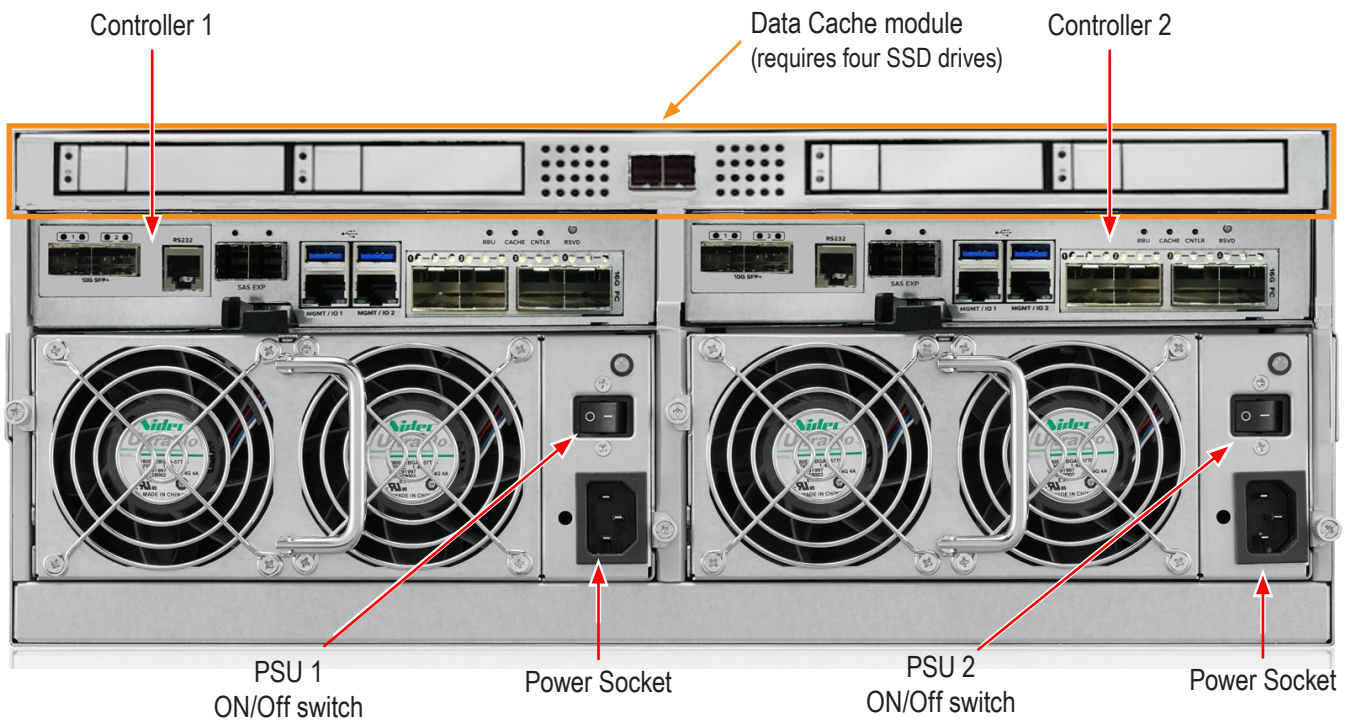

Back view of VTrak D5600

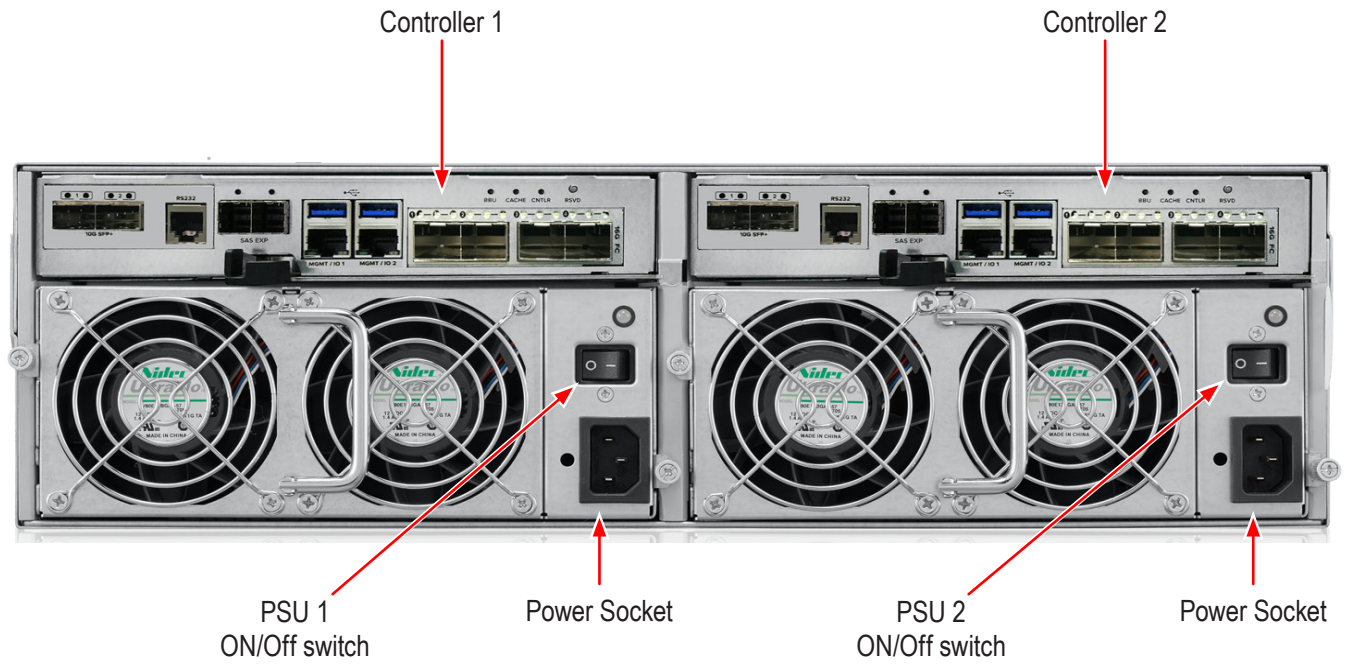

Back of VTrak D5300 and D5320

The rear of the VTrak D5000 Series enclosure provides access to the power supply units, which include the cooling fans, and the system controller(s).

Each controller has two RJ-45 Gigabit Ethernet ports used for management, an RS-232 serial management port using an RJ-11 connector, four Fibre Channel data ports per controller using standard SFP sockets, two 10 Gb/s iSCSI ports (SFP+ ports), two SAS Expansion port for additional drive enclosures, and various LED indicators which are described below.

VTrak D5300 and VTrak D5320 rear view

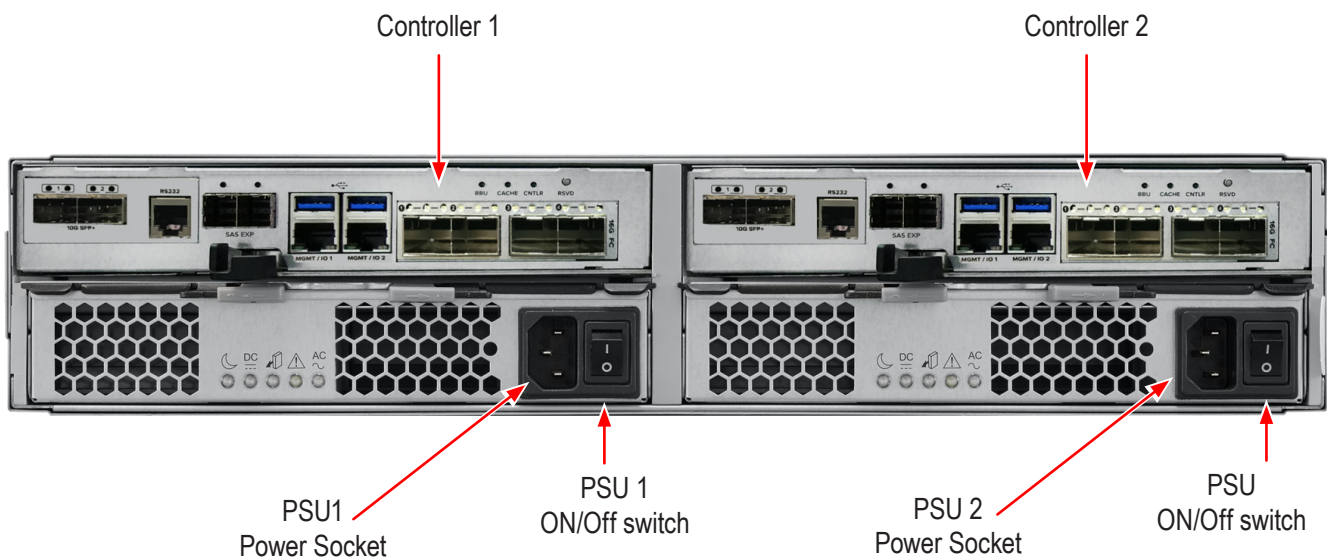

WARRANTY AND SUPPORT

WARRANTY

- Three year complete system limited warranty
- Battery Backup Unit has a one year limited warranty
- Optional 2-year extended warranty
- Optional onsite parts replacement program

Promise Technology, Inc. ("Promise") warrants that for three (3) years from the time of the delivery of the product to the original end user except for one (1) year warranty on the battery backup unit:

- a) the product will conform to Promise's specifications;
- b) the product will be free from defects in material and workmanship under normal use and service.

This warranty:

- a) applies only to products which are new and in cartons on the date of purchase;
- b) is not transferable;
- c) is valid only when accompanied by a copy of the original purchase invoice;
- d) is not valid on spare parts.

This warranty shall not apply to defects resulting from:

- a) improper or inadequate maintenance, or unauthorized modification(s), performed by the end user;
- b) operation outside the environmental specifications for the product;
- c) accident, misuse, negligence, misapplication, abuse, natural or personal disaster, or maintenance by anyone other than a Promise or a Promise authorized service center.

HARDWARE INSTALLATION

This chapter presents basic information on unpacking the VTrak D5000 Series enclosure and mounting it in an equipment rack, making the connections for data and management paths and connecting the power. It also describes how to power on the system and what to look for while it is powering up.

The main sections in Hardware Setup include the following:

- Unpacking
- Mounting the VTrak enclosure in a rack
- Installing Physical Drives
- Making Management Connections
- Connecting the Power
- Power on

Depending on the details of your order, the VTrak D5000 Series enclosure might be shipped with hard drives installed, or it might require that you install hard drives. The section “Installing Physical Drives” on page 22 provides instruction for installing hard disks.

Unpacking

Packing List

The VTrak D5000 Series box contains the following items:

- VTrak D5000 Unit
- One Quick Start Guide printed
- Sliding rail assembly for rack mounting
- DB9-to-RJ11 serial data cable

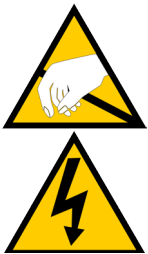

Warning

The electronic components within the VTrak enclosure are sensitive to damage from Electro-Static Discharge (ESD). Observe appropriate precautions at all times when handling the VTrak or its subassemblies.



Warning

**Two persons are needed to safely place the unit onto the rails.
DO NOT lift the unit by the handles**

Mounting the VTrak enclosure in a rack

This section provides instructions for installing the VTrak D5000 Series enclosure into a rack



Caution

To lighten the enclosure, remove the power supplies, and remove all hard drive carriers. Replace the power supplies and drive carriers after the unit is mounted in your rack.



Cautions

- Do not populate any unit with hard drives until it has been securely installed in the rack.
 - At least two persons are required to safely lift, place, and attach the unit into a rack system.
 - Do not lift or move the unit by the handles, power supplies or the controller units. Hold the system itself.
 - Do not install the unit into a rack without rails to support the system.
 - Only a qualified technician who is familiar with the installation procedure should mount and install the unit.
 - Mount the rails to the rack using the appropriate screws and nuts, fully tightened, at each end of the rail.
 - Do not load the rails unless they are installed with screws as instructed.
 - The rails available for the PROMISE VTrak unit are designed to safely support that PROMISE VTrak unit when properly installed. Additional loading on the rails is at the customer's risk.
 - PROMISE Technology, Inc. cannot guarantee that the mounting rails will support your PROMISE VTrak unit unless you install them as instructed.
-

To install the VTrak into a rack with the supplied mounting rails:

1. Check the fit of the mounting rails in your rack system.

Installing the rails onto the rack

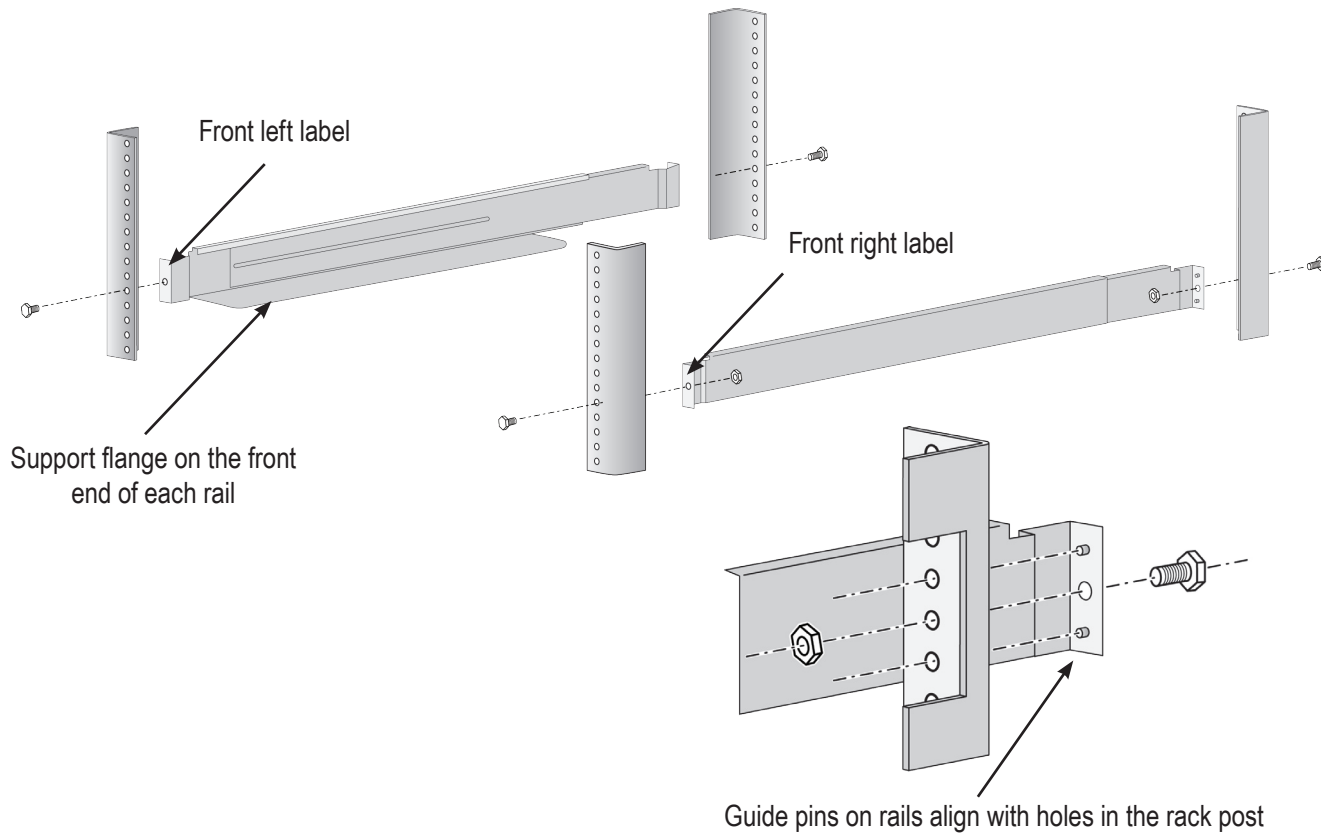

2. Adjust the length of the mounting rails as needed.

- The rear rail slides inside the front rail. The rails are composed of two sliding sections and do not require adjusting screws.
- The front-left and front-right mounting rail ends are labeled.
- Be sure the front rail support is on the bottom facing inward.
- All rail ends, front and rear, attach at the outside of the rack posts.
- The guide pins at the rail ends align with the holes in the rack posts.
- Use the attaching screws and nuts from your rack system. Tighten the screws and nuts according to instructions for your rack system.

Rail ends attach to the outside of each post

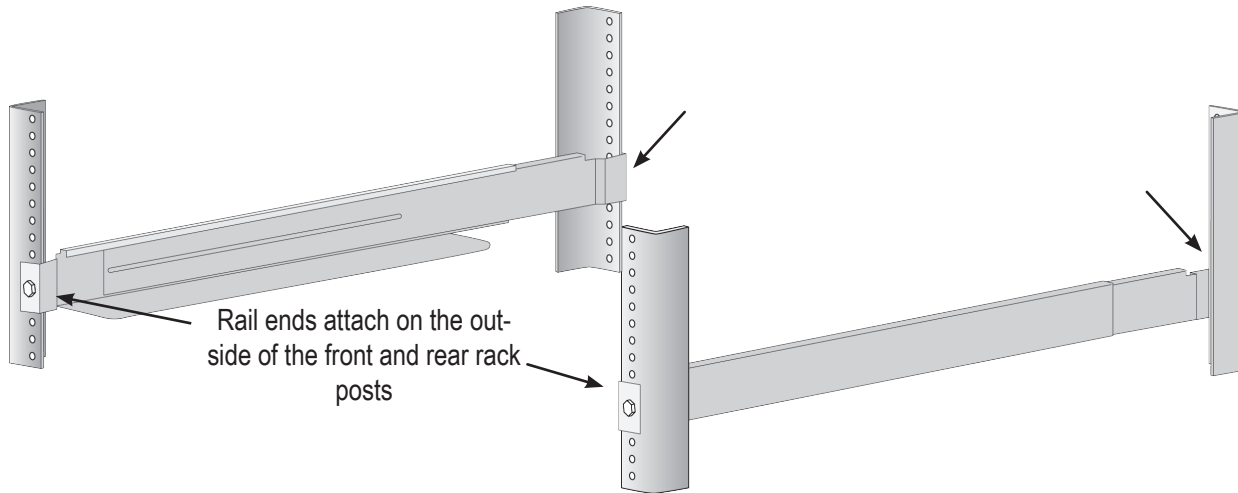

3. Place the VTrak onto the rails.

- At least two persons are required to safely lift the system.
- Lift the VTrak itself. Do not lift the system by its brackets.



Warning

Two persons are needed to safely place the unit onto the rails.

DO NOT lift the unit by the handles

Placing the VTrak system onto the rack rails

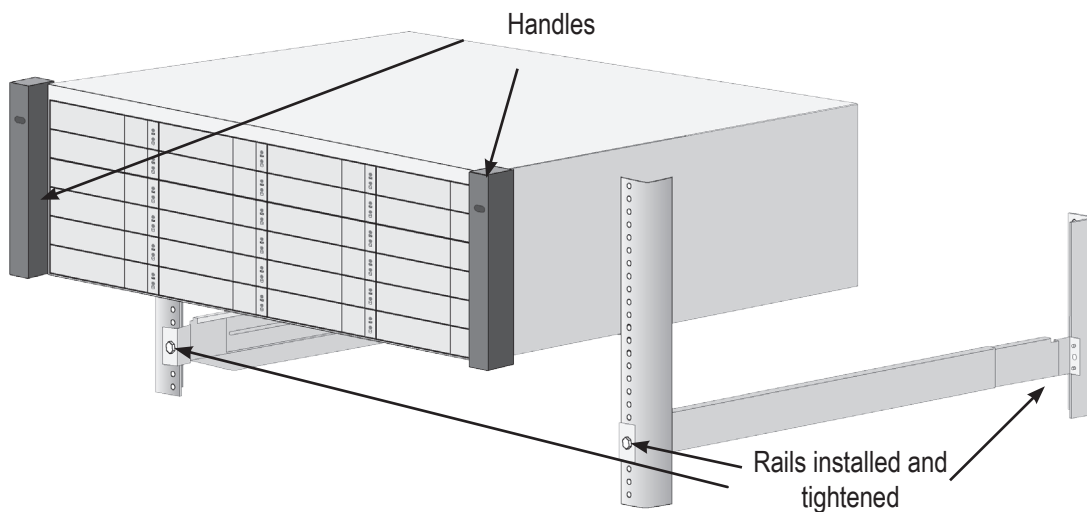

4. Secure the enclosure to the rack.
 - Use screws and nuts to lock the unit in to place in the rack.

Secure to rack

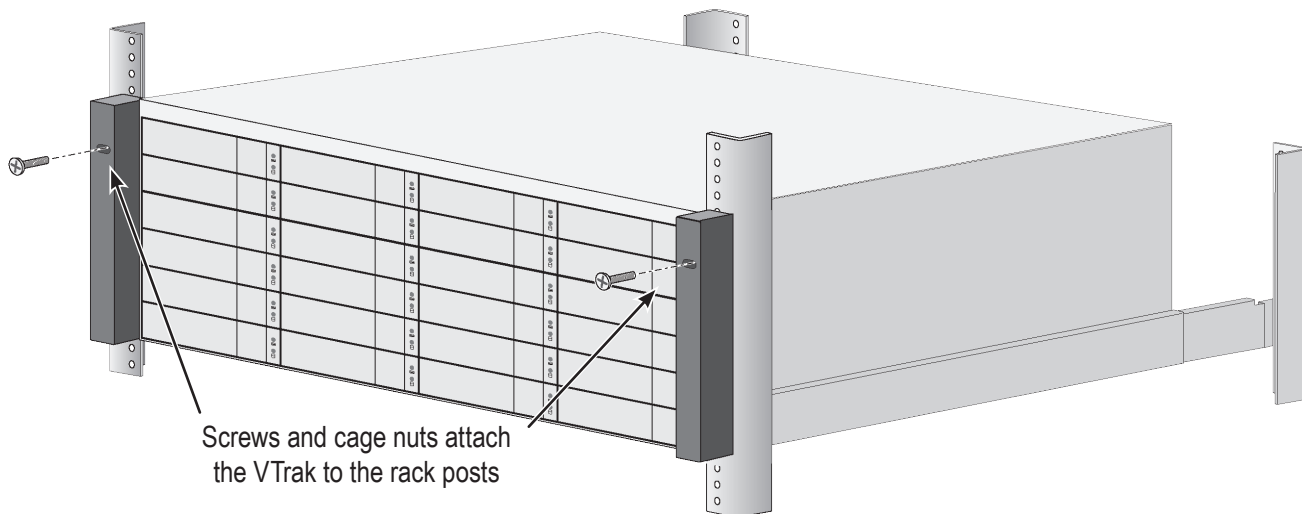

System installed in rack

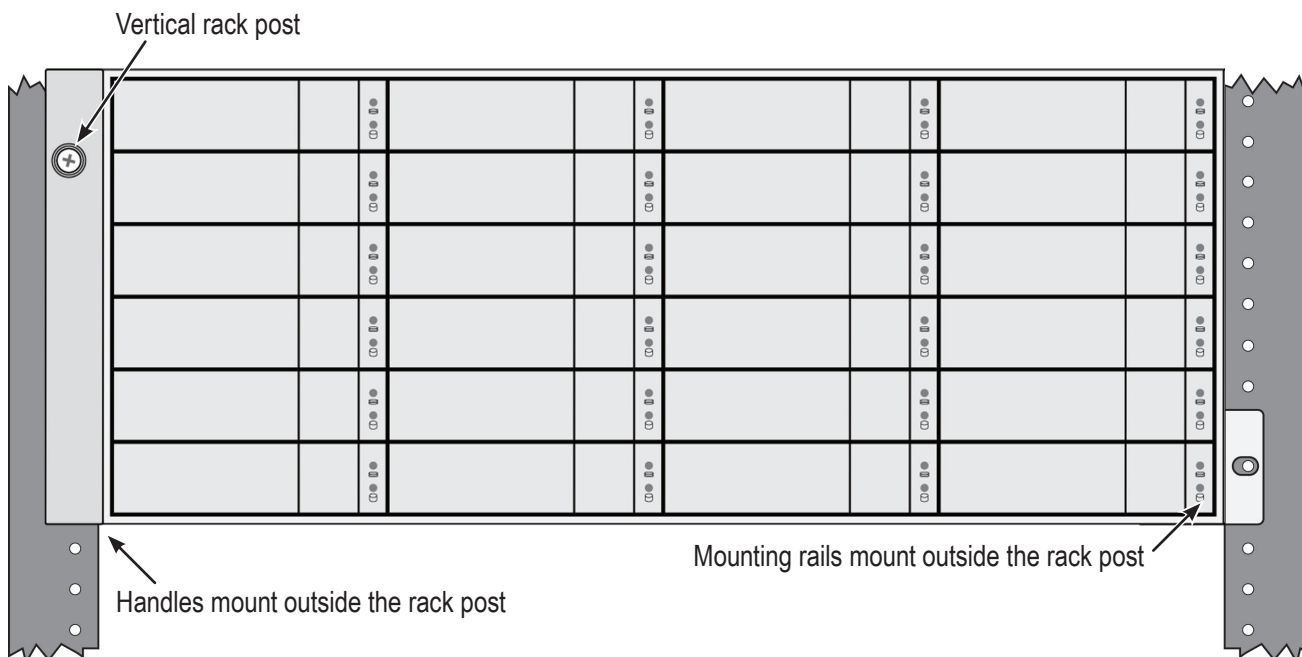

Mounting the VTrak D5300/J5320

To install the 2U VTrak enclosure into a rack with the supplied mounting rails:

1. Determine what height to place the 2U enclosure in the rack, then place the right and left rack rails at the same height on in the right and left rack position. Choose the mounting holes accordingly for your rack system. Consult the documentation for your rack if you are unsure which holes to use. Note that three holes are required on each front post, the uppermost of the three to be used for the nuts to anchor the enclosure to the rack posts.

Determine position for rack rails



Insert nut in each front post

Notice that each end of the sliding rails have a lever to operate the lock mechanism that grips the rack post.

Lock release lever (back left)

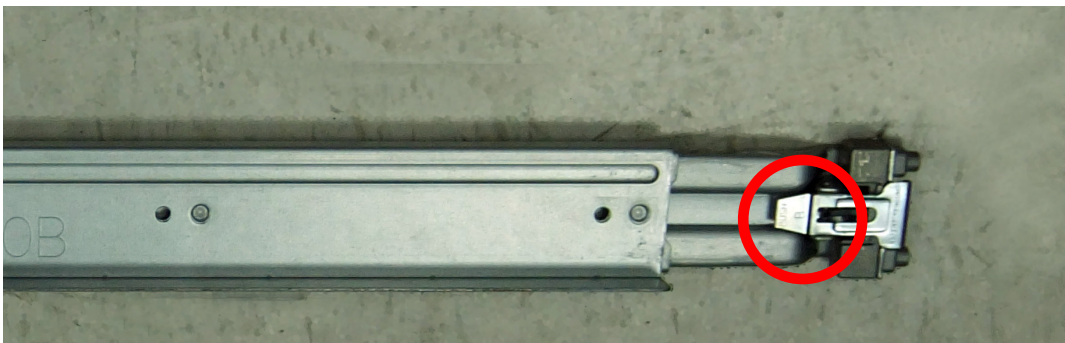

Press lever to release lock (front right)

2. Secure the rails to the rack posts. Make sure the rack rails are properly oriented in the rack.

To set the rails into the rack posts and secure the rails, follow these steps:

- a. Press the spring lock then insert the studs into the selected square holes on the rack post.
- b. Press the spring lock on the other end of the rail and insert the studs into the selected mounting hole on the rack post. If necessary, extend the rail to reach the post.
- c. Use the rail screws to anchor the rack rail to the post.
- d. Make sure the rack rail is aligned, secure, stable and in the correct place.
- e. Perform steps a through c above for the other rail.
- f. Make sure the rack rails are aligned, secure, stable and in place. See figure below.

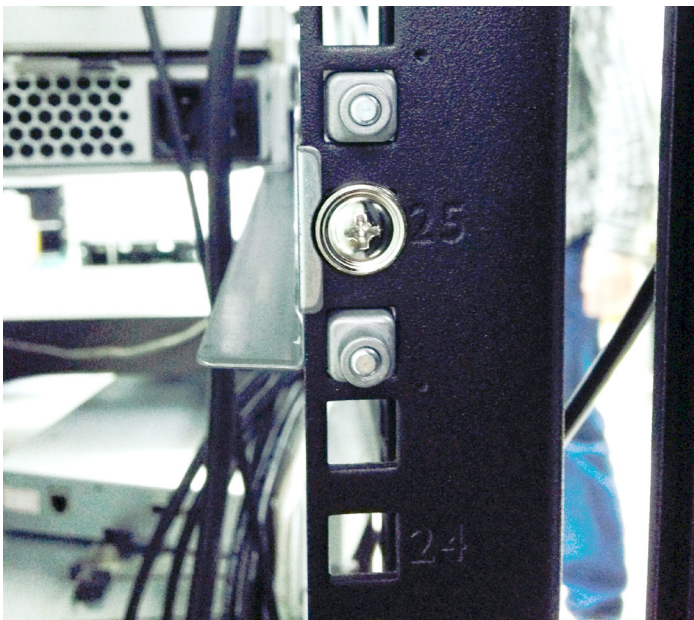
Back left rail secured to post

3. Secure the enclosure to the rack.

- Use screws to lock the unit in to place in the rack.
- Use the attaching screws that came with the mounting hardware.

Insert screws on each side of the front of the enclosure to secure it to the rack posts

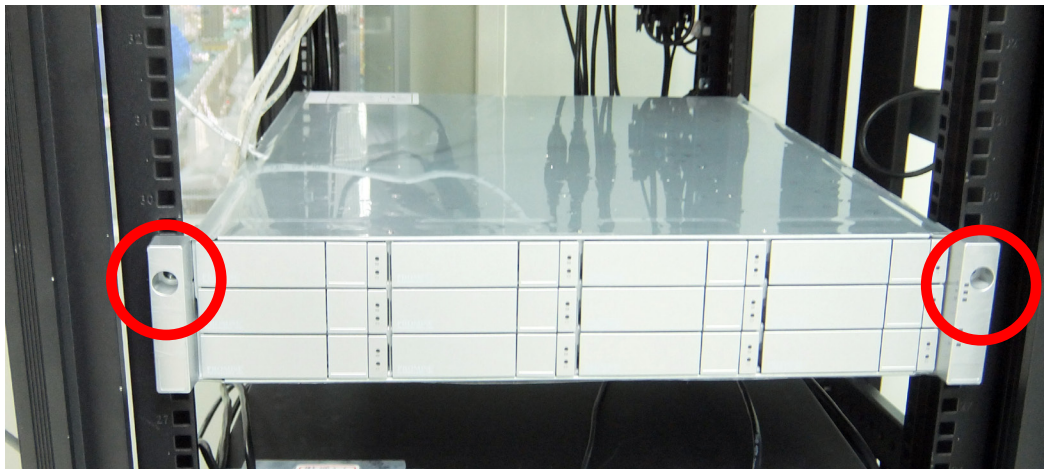

Installing Physical Drives

The VTrak D5000 Series subsystems support:

- SAS hard disks
- SATA hard disks (SATA drives require use of an adapter)
- 3.5-inch hard disk drives for VTrak D5800, VTrak D5600, and VTrak D5300.
- 2.5-inch disk drives for VTrak D5320

For a list of supported physical drives, download the latest compatibility list from the PROMISE

<http://www.promise.com/support/>.

Number of Drives Required

The table below shows the number of drives required for each RAID level

Level	Number of Drives		Level	Number of Drives
RAID 0	1 or more		RAID 6	4 to 32
RAID 1	2 only		RAID 10	4 or more*
RAID 5	3 to 32		RAID 50	6 or more
			RAID 60	8 or more

*Must be an even number of drives.



Caution

The VTrak D5000 Series supports disk drive hot-swapping. To avoid hand contact with an electrical hazard, do not remove more than one drive carrier a time.

Drive Slot Numbering

You can install any suitable disk drive into any slot in the enclosure. The diagrams below shows how drive slots are numbered. Slot numbering is reflected in the WebPAM PROe and CLI user interfaces.

Be sure to install all of the drive carriers into the VTrak D5000 enclosure to ensure proper airflow, even if you do not populate all the carriers with physical drives.

Drive slot numbering on VTrak D5800

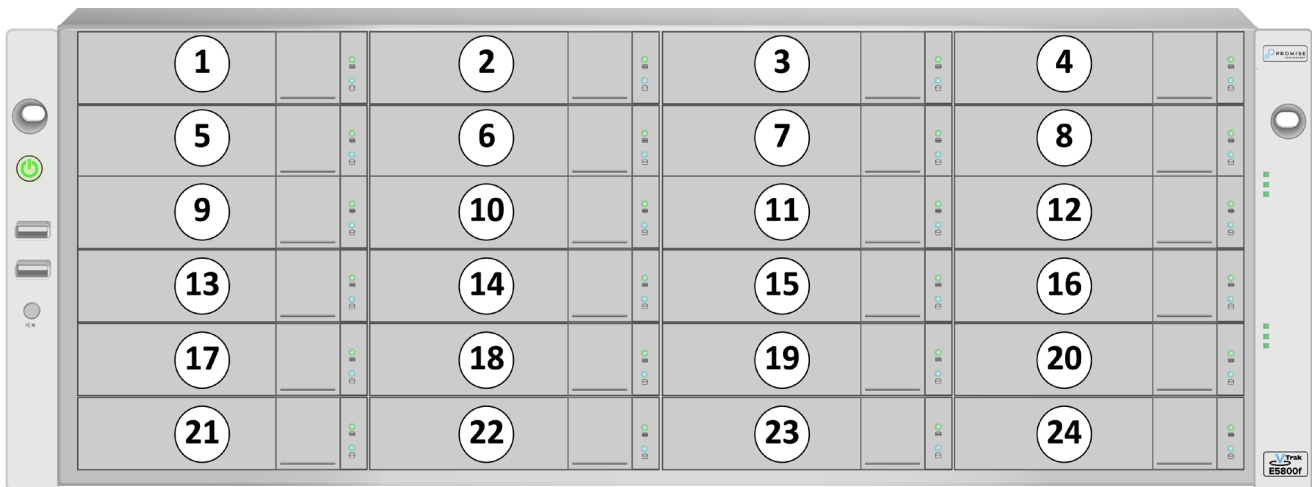

Drive slot numbering on VTrak D5600

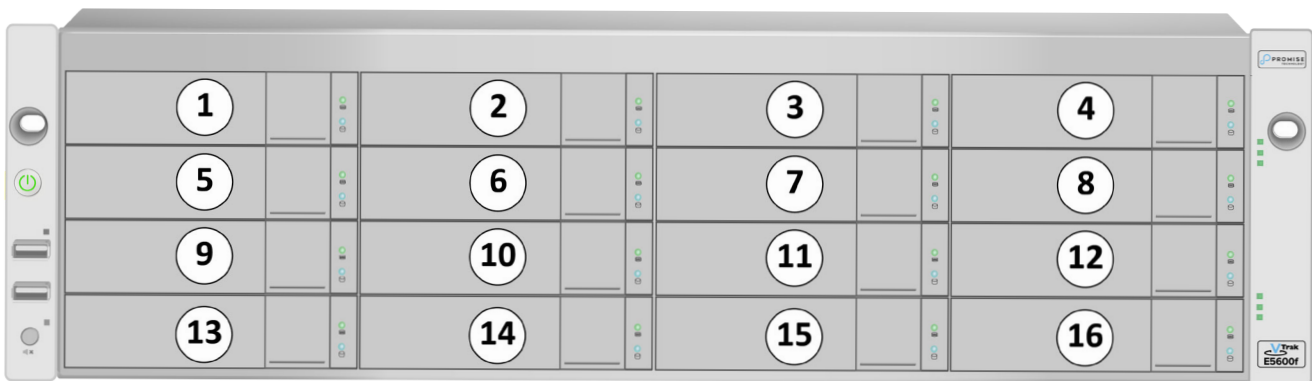

Drive slot numbering on VTrak D5300

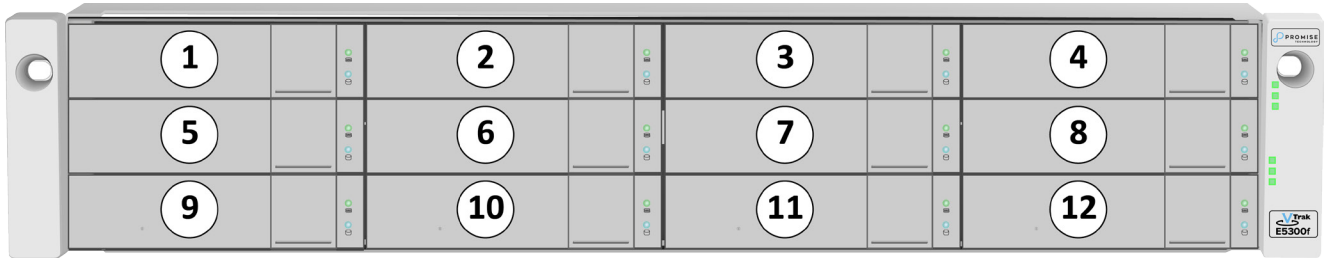

Drive slot numbering on VTrak D5320

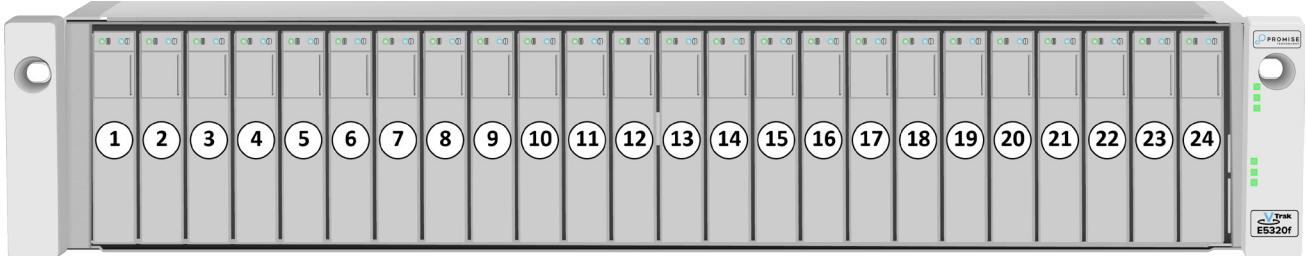

Installing Your Drives

The drive carrier accommodates 2.5-inch and 3.5-inch drives.

The VTrak D5000 does support use of SATA drives (SATA drives require use of an adapter), but SAS drives are recommended.

Follow instructions on the next page to install drives in the VTrak D5300, VTrak D5600 and VTrak D5800.



Cautions

Swing open the drive carrier handle before you insert the drive carrier into the enclosure.

To avoid hand contact with an electrical hazard, remove only one drive carrier a time.



Important

SATA drives require a SAS-to-SATA adapter, available from PROMISE Technology at <http://www.promise.com/>

SAS drives do not require adapters.

1. Press the drive carrier release button.
2. Grasp the front and gently pull the empty drive carrier out of the enclosure.

Drive carrier front view



Disk carrier release button

3. If you are installing SATA drives, attach a SAS-to-SATA adapter onto the power and IO connectors of each drive.
4. Carefully lay the drive into the carrier with the power and IO connectors facing away from the carrier handle.
5. Position the drive in the carrier so the mounting holes line up.
 - 2.5-inch drive mounting screws go through the bottom of the carrier.
 - SAS-to-SATA adapter mounting screws go through the bottom of the carrier.
 - 3.5-inch drive mounting screws go through the sides of the carrier.
6. Insert the screws through the proper holes in the carrier and into the drive or adapter.
 - Use the screws supplied with the shipment or the SAS-to-SATA adapter.
 - Install four screws per drive.
 - Install two screws per adapter.
 - Snug each screw. Be careful not to over tighten.
7. With the drive carrier handle in open position, gently slide the drive carrier into the enclosure.



Important

Press the release button to push the drive carrier into position.

Proper drive installation ensures adequate grounding and minimizes vibration. Always attach the drive to the carrier with four screws.

2.5-inch Hard Disk Drives

The VTrak D5320 features 24 drive carriers designed to fit 2.5” drives. Notice that the carriers are oriented vertically, with the carrier release button at the top. The lever mechanism to remove the carrier from the drive bay works exactly the same as the 3.5” carriers, except they are positioned vertically rather than horizontally.



Caution

Swing open the drive carrier handle before you insert the drive carrier into the enclosure.

2.5” drive carrier front view

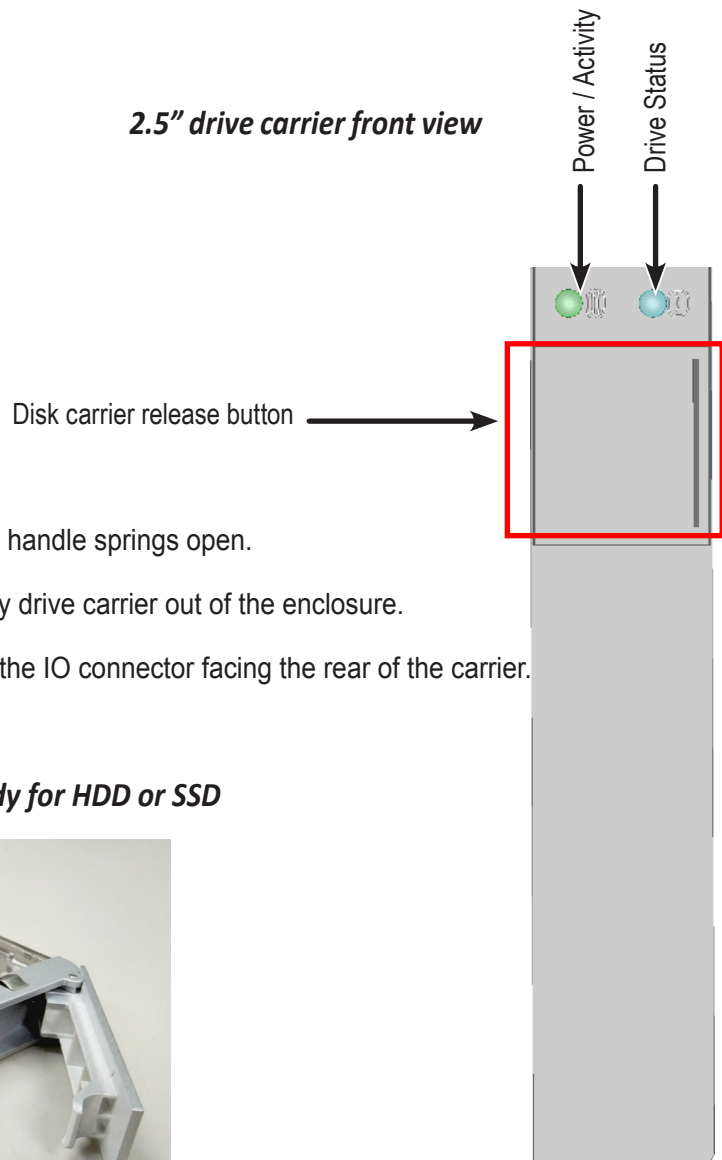

1. Press the drive carrier release button. The handle springs open.
2. Grasp the handle and gently pull the empty drive carrier out of the enclosure.
3. Carefully lay the drive into the carrier with the IO connector facing the rear of the carrier.

Empty 2.5” drive carrier front ready for HDD or SSD

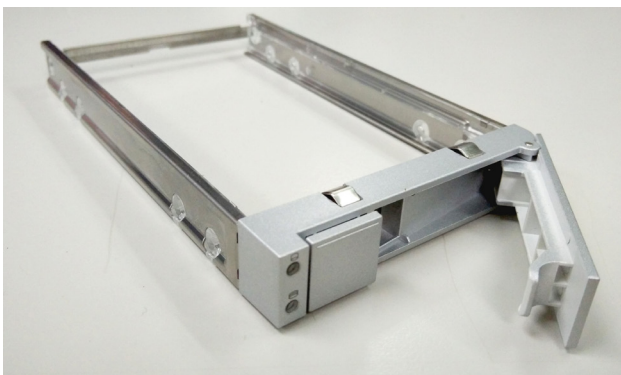

4. Position the drive in the carrier so the mounting holes line up.
5. Insert the screws through the proper holes in the carrier and into the drive or adapter.
 - Install four screws per drive.
 - Snug each screw. Be careful not to over tighten.

2.5" drive carrier with HDD installed, front view



2.5" drive carrier with HDD, 'left' side with HDD undercarriage exposed

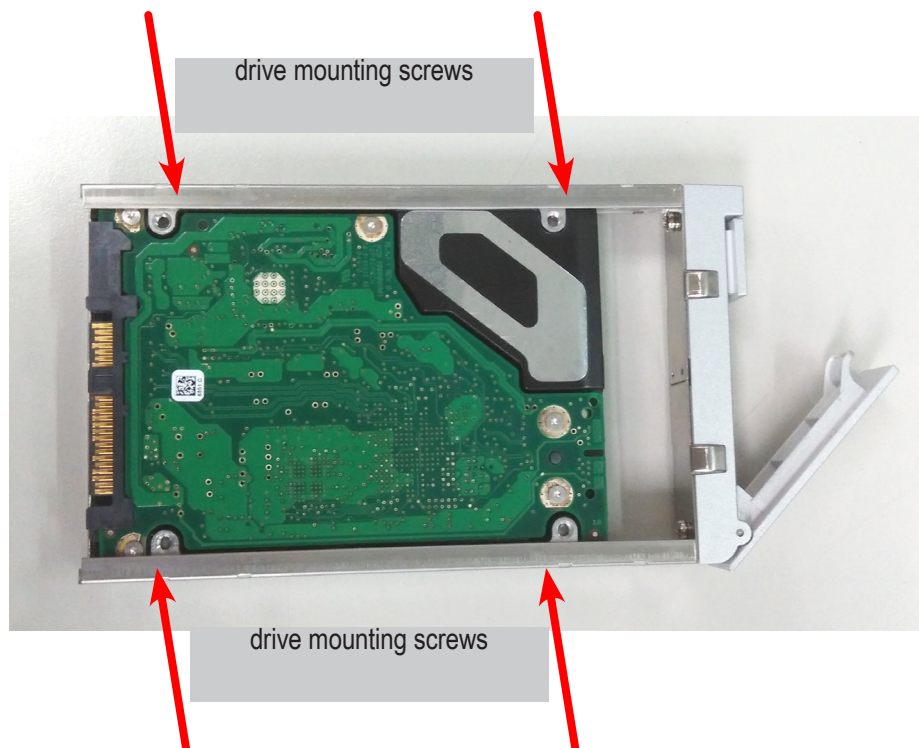

6. With the drive carrier handle in open position, gently slide the drive carrier into the enclosure. The drive carrier should be oriented so the the "top" of the 2.5" HDD is on the right, and the "bottom" of the HDD is on the left. The LED indicators will be at the top.

Making Management Connections

There are two methods to establish a management connection, Network and Serial connection. For the initial setup, it is necessary to establish the network management connection; use the MGMT 1 port on both controllers for system management. The VTrak D5000 Series also features a Serial management port for system management using a terminal emulation program and the VTrak D5000 Command Line Interface (CLI). The hardware connections for both methods are described in this section.

VTrak D5000 Series controller Management and IO ports

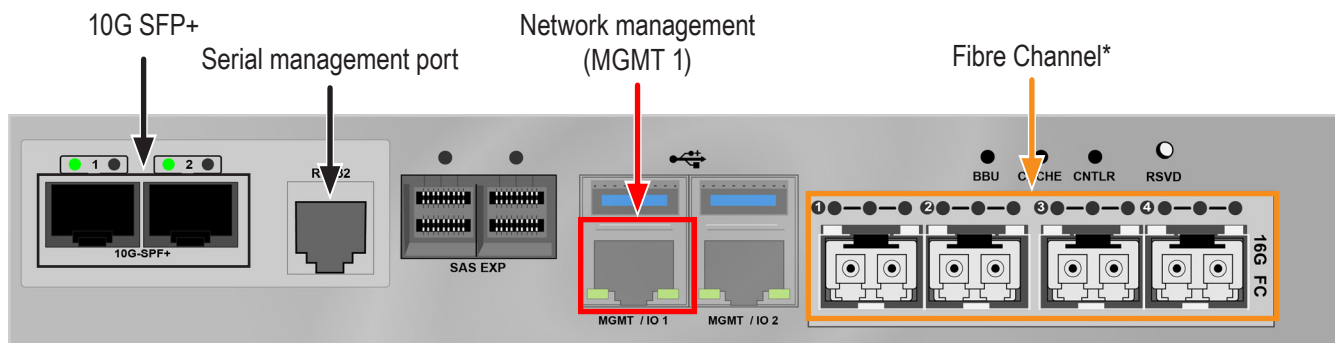

* Fibre Channel might not be available in all markets.

Network management connection

Each VTrak D5000 Series controller has two 1000BASE-T Ethernet ports. Port MGMT 1 (left most 1000BASE-T port) is used for system management.

To establish the management path network connection:

1. Attach one end of an Ethernet cable to the network connector or standard NIC in the Host PC, attach the other end of the Ethernet cable to a port on a standard network switch.
2. Attach one end of an Ethernet cable to the same network switch and attach the other end to the MGMT 1 port on controller 1.
3. If the subsystem is dual controller, connect one end of an Ethernet cable to the same network switch and attach the other end to the MGMT 1 on controller 2.



Note

The RJ-45 network management ports on a VTrak D5000 Series subsystem share the same Virtual IP address. The default Virtual IP address, 10.0.0.1, applies to the left most RJ-45 network port (MGMT 1) on both controllers. If you change the Virtual IP address, the change applies to both network management ports.

Serial management connection

Serial communication enables any computer that has an available serial port and terminal emulation application to access the VTrak Command Line Interface (CLI) to set up a network connection. The VTrak package includes one RJ11-to-DB9 serial data cable for each controller.

To set up a serial cable connection:

1. Attach the RJ-11 end of the serial data cable to the RJ-11 serial connector on one of the RAID controllers.
2. Attach the DB9 end of the serial data cable to a serial port on the host PC or server.

Controller serial interface

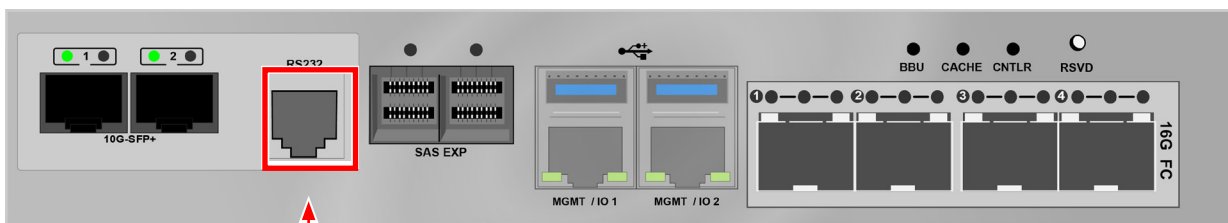

Serial port (RJ-11)
Use the DB9 to RJ-11 adapter to connect

Making Data Connections

Each VTrak D5000 controller supports two Fiber Optic (SFP+) 10G connections for data. Controllers available in some markets also support four Fibre Channel connections (up to 16G). Follow the instructions below for the type of data connection you are setting up.

Fiber Optic (SFP+) data path

The Fiber Optic data network for the VTrak D5000 controller requires the following items:

- An SFP+ connection in each host PC or server
- An SFP+ transceiver for every SFP+ port in the connection (subsystem, switch, HBA)
- An SFP+ switch (not required for direct attached connection)
- Fiber Optic cabling (LC/LC 62.5/125µm MMF)

Management and Fiber Optic SAN connections

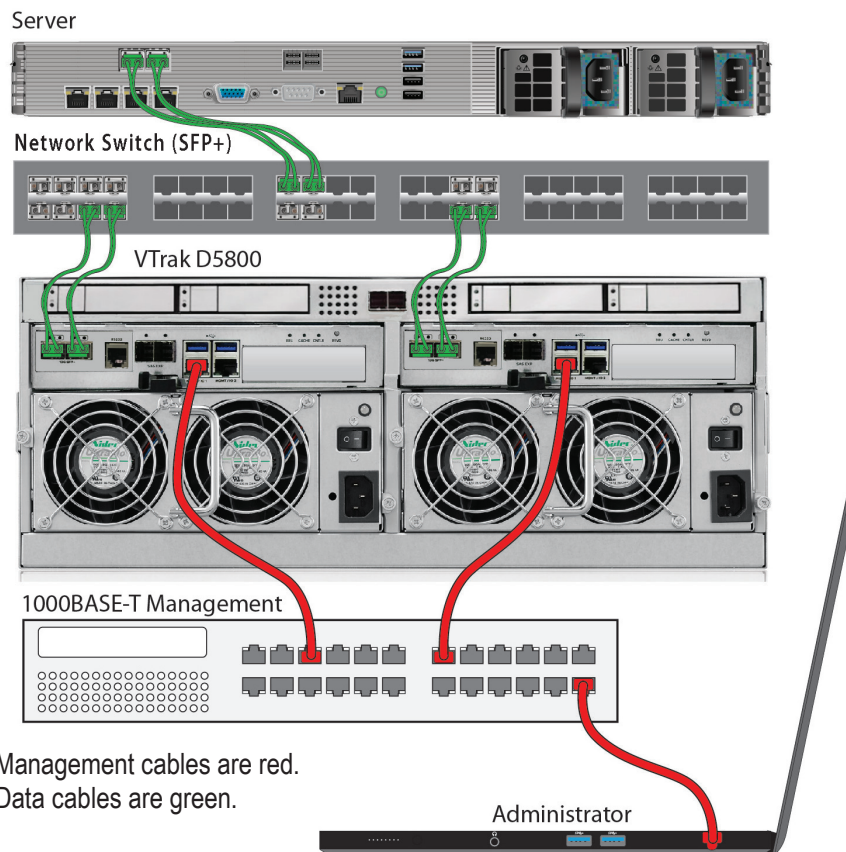

SFP+ Fiber Optic SAN connections

For the Fiber Optic storage network:

1. Connect a Fibre Optic cables between the Fibre Optic ports on the server and the Fibre Optic ports on the SFP+ switch.
2. Connect Fiber Optic cables between the Fiber Optic port on the VTrak D5000 controller and a Fiber Optic port on a SFP+ switch.

If you have multiple VTrak D5000 subsystems, host PCs or servers, repeat the steps as required.

Management and Fiber Optic DAS connections

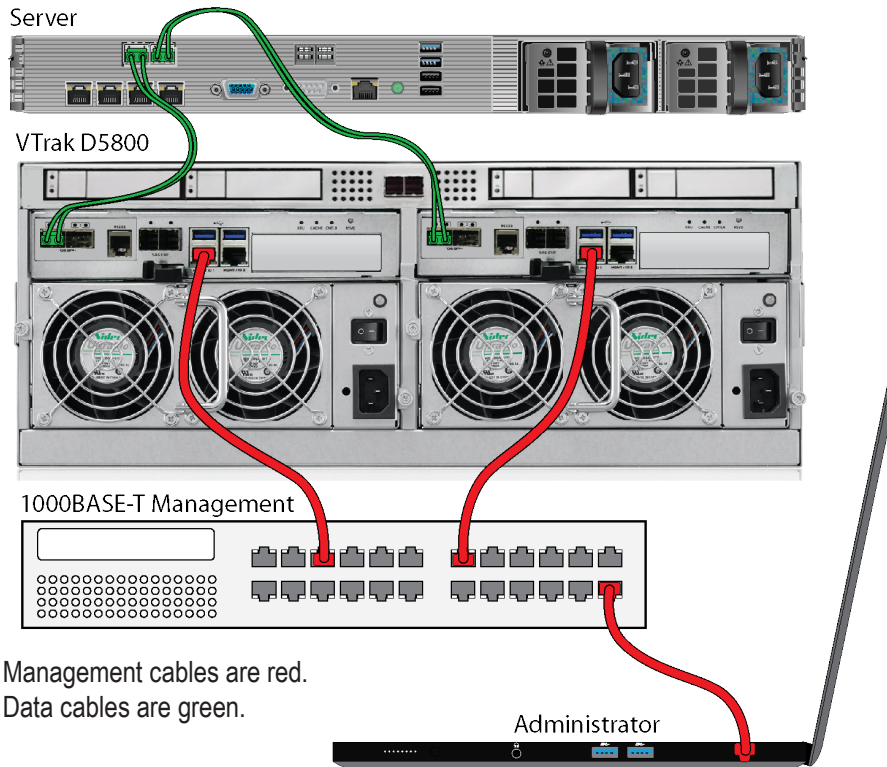

SFP+ Fiber Optic DAS connections

For the Fiber Optic Direct Attached Storage:

1. Connect Fiber Optic cable to the Fiber Optic port on the host PC or server.
2. Connect the other end of the Fiber Optic cables to the SFP+ Fiber Optic port on the VTrak D5000 controller.

Fibre Channel SAN data path

The Fibre Channel data network for the VTrak D5000 controllers requires the following items:

- A Fibre Channel connection in each host PC or server
- An SFP transceiver for every SFP (Fibre Channel) port in the connection (subsystem, switch, HBA)
- A Fiber Channel switch (not required for direct attached connection)
- Fiber Optic cabling

Management and Fiber Channel SAN data connections

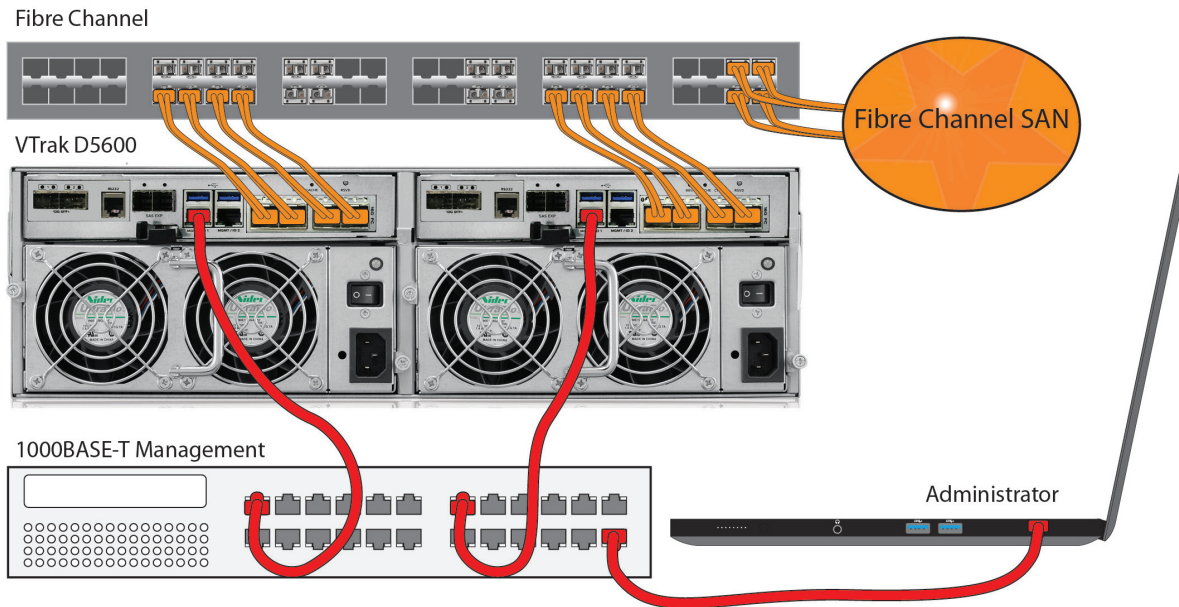

Management cables are red.
Data cables are orange.



Important

For a list of tested HBAs, switches, and SFP transceivers, download the latest compatibility list from PROMISE support:
<http://www.promise.com/support>

Fibre Channel SAN connections

For the Fibre Channel storage area network (SAN):

1. For servers equipped with Fibre Channel HBA cards, connect Fiber Optic cables between the Fibre Channel ports in both host PCs or servers and the ports on a Fibre Channel network switch.
2. Connect Fiber Optic cables between the Fibre Channel port on the VTrak D5000 controllers and a Fibre Channel port on a Fibre Channel switch or Fibre Channel capable switch (SFP).

If you have multiple VTrak D5000 subsystems, host PCs or servers, repeat the steps as required.

Fiber Channel DAS data path

The Fibre Channel data network for the VTrak D5000 controllers requires the following items:

- A Fibre Channel connection in each host PC or server
- An Fibre Channel transceiver for each connected port on the subsystem
- Fiber Optic cabling (LC/LC 62.5/125µm MMF)

Direct Attached Storage (DAS) Fibre Channel connection

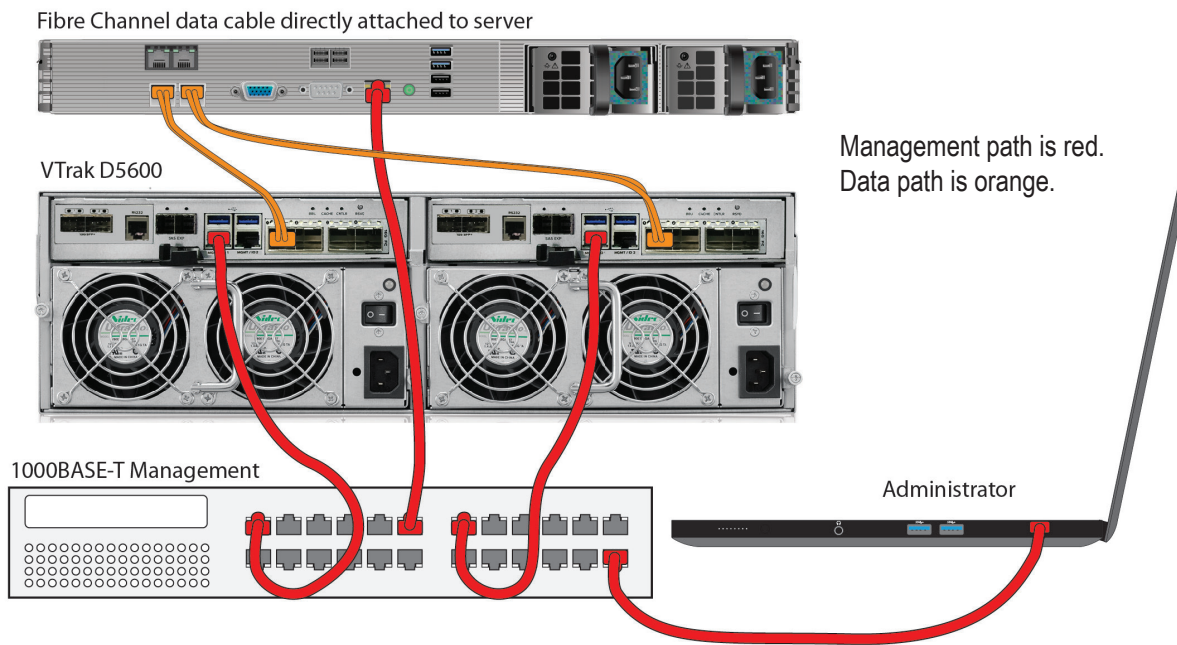

Fibre Channel DAS connections

For Fibre Channel direct attached storage (DAS):

1. For each attached server or host PC, connect Fiber Optic cable to the Fibre Channel port on the host PC or server.
2. Connect the other end of the Fiber Optic cable to a Fibre Channel port on one of the VTrak D5000 controllers.

It is recommended to use two Fibre Channel connections from the host computer to the VTrak D5000 so that there is a physical path from the host to each of the VTrak D5000's controller's. This improves performance and provides redundancy.

VTrak D5000 with JBOD Expansion

The setup description below references the illustration “VTrak D5600 with VTrak J5600 JBOD expansion connections” on the next page.

To add VTrak J5000 Series units:

1. Connect the SAS expansion port (SAS port to the right) on the left controller of the RAID subsystem to the SAS port 1 on the left I/O module of the first VTrak J5000 unit.
2. Connect the SAS expansion port (SAS port to the right) on the right controller of the RAID subsystem to the SAS data port 1 on the right I/O module of the first VTrak J5000 unit.
3. Connect the SAS data port 2 on left I/O module of the first VTrak J5000 unit to the SAS data port 1 on the left I/O module of the second VTrak J5000 unit.
4. Connect the SAS data port 2 on right I/O module of the first VTrak J5000 unit to the SAS data port 1 on the right I/O module of the second VTrak J5000 unit.
5. Connect any remaining VTrak J5000 units in the same manner.

Keep in mind the following points:

- Keep your data paths organized to ensure redundancy.
- JBOD expansion supports up to nine VTrak J5000 units.



Important

Power on the JBOD units first, when you are ready to power on the enclosures.

Read the VTrak J5000 Series Product Manual for information on the VTrak J5000 Series enclosures.

VTrak D5600 with VTrak J5600 JBOD expansion connections

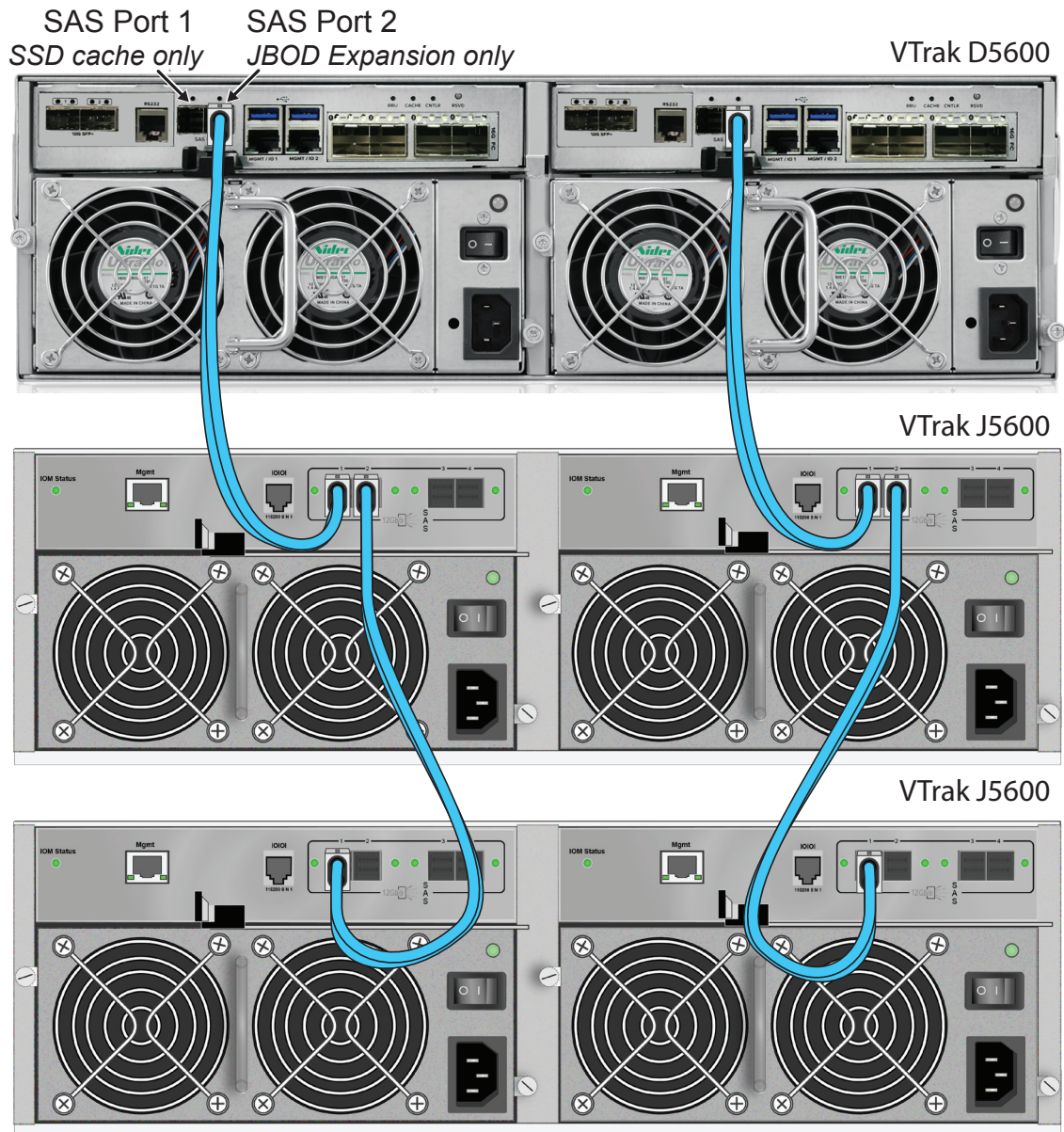

VTrak D5800 SSD Data Cache Module

The VTrak D5800 includes a module used for an SSD data cache. If you will use this, make sure to install the SSD drives and connect the SAS cables before you configure the storage.

Note that the disk carrier hardware is identical to the 2.5" disk carriers used for the VTrak D5320. Install identical SSD drives in all four disk carriers. Go to www.promise.com for a list of compatible SSD drives.

1. Connect the left most SAS port on the data cache module to the left most SAS port on the left controller.
2. Connect the right most SAS port on the data cache module to the left most SAS port on the right controller.

SAS cable connections for SSD data cache on VTrak D5800

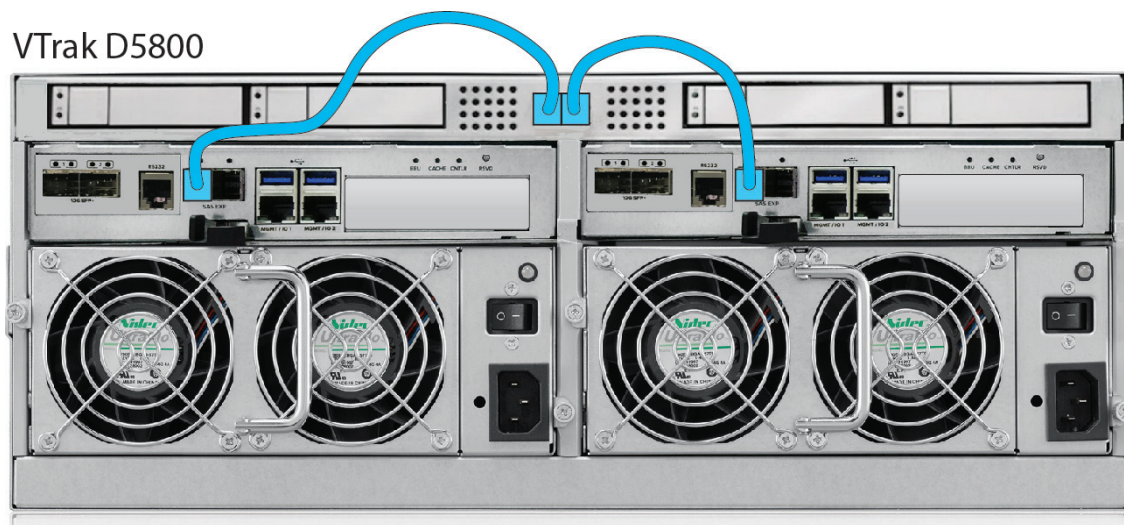

Important Notice for VTrak D5800

In order to use the optional SSD data cache, it is necessary to install four SSD drives and connect the SSD data cache module to both controllers via SAS cable. This must be done BEFORE storage configuration.

Connecting the Power

VTrak D5000 Series enclosures are equipped with two power supplies for each unit. All VTrak models feature an ON/OFF switch on the power supply unit (PSU). Connect both power supplies to a suitable power source.

The 2U VTrak D5300/D5320 will power on when the power switch on each power supply is in the *On* position.

See illustration below.

The 3U VTrak D5600 and 4U VTrak D5800 have a power button on the front used to power on the subsystem.

Power supplies on VTrak D5600

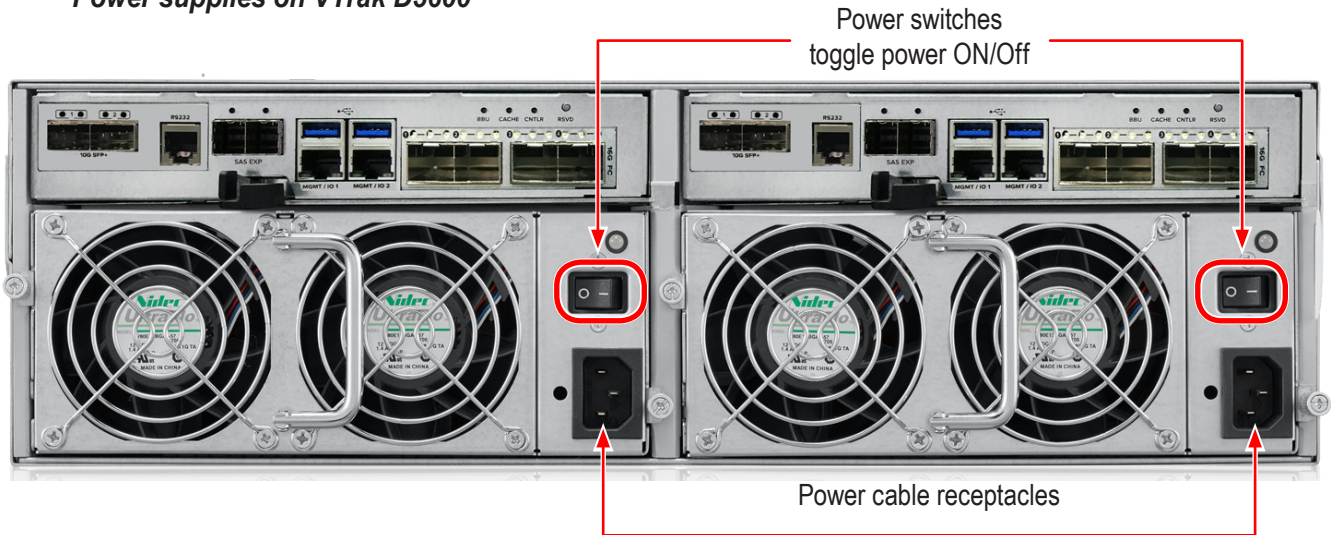

Power supplies on VTrak D5300/VTrak D5320

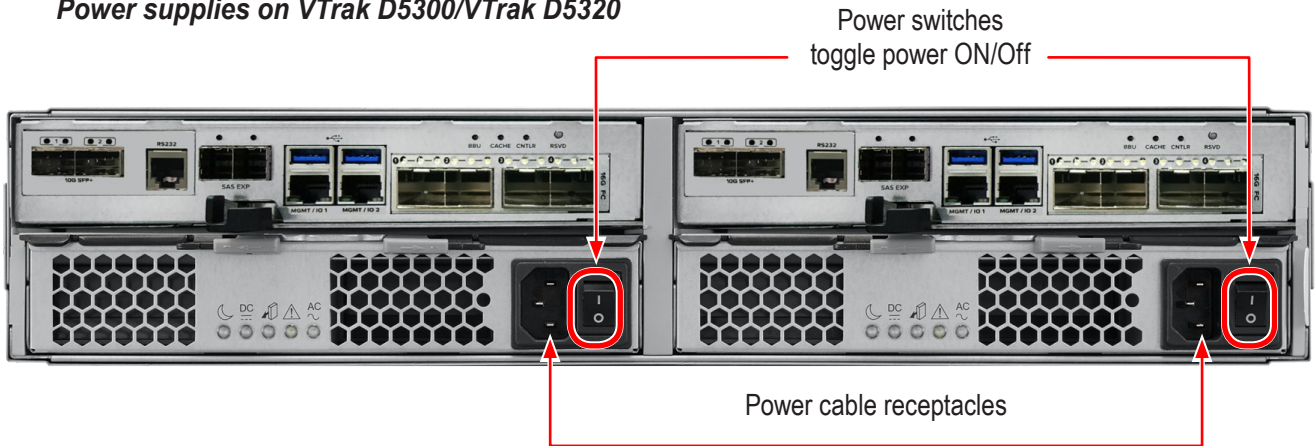

Power on

With the power cables connected, the system can now be powered on. The power supply modules include the cooling fans that cool the enclosure. Both power supplies should be powered up when starting the system. Make sure the power switch on each power supply is in the *On* position. Note that this will power on the VTrak D5300 and VTrak D5320.

To power on the VTrak D5600 or VTrak D5800 subsystem, first switch on the power supplies in the back of the unit, then press the power button on the front left bracket facing (see illustration below). Observe the LEDs on the right front bracket facing.



Important

If you have a SAN, DAS, or Cascade with JBOD Expansion, always power on the JBOD subsystems first.

Power button on front left of VTrak D5600/D5800

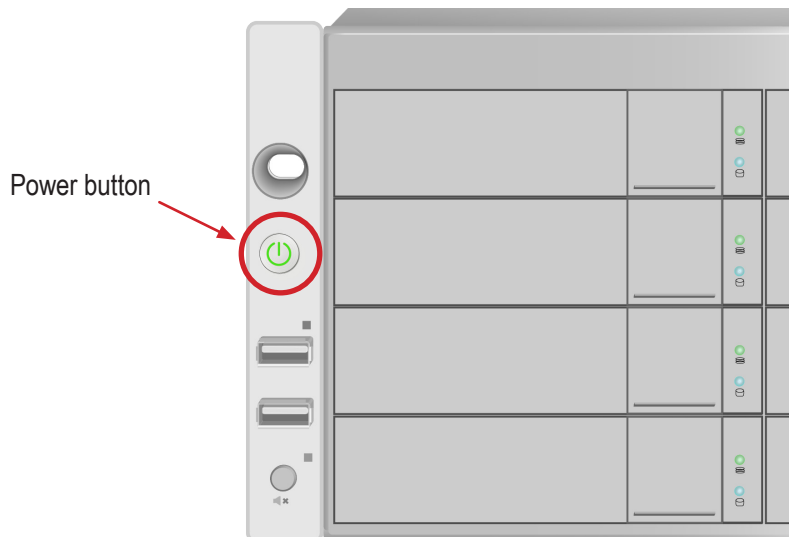

Front LED Behavior

When boot-up is finished and the subsystem is functioning normally:

- Power, FRU and Logical Drive LEDs display Green continuously
- Controller Activity LED flashes Green when there is controller activity.
- System Heartbeat LED blinks Green once per second for five seconds, then goes dark for ten seconds, then repeats the same pattern.

Also on the front panel, there are two LEDs on each drive carrier. These report the presence of power and a physical drive, and the current condition of the drive. See table on next page for complete description of LEDs on front right of VTrak D5600/D5800 .

LED indicators on front right of VTrak D5600/D5800 enclosure

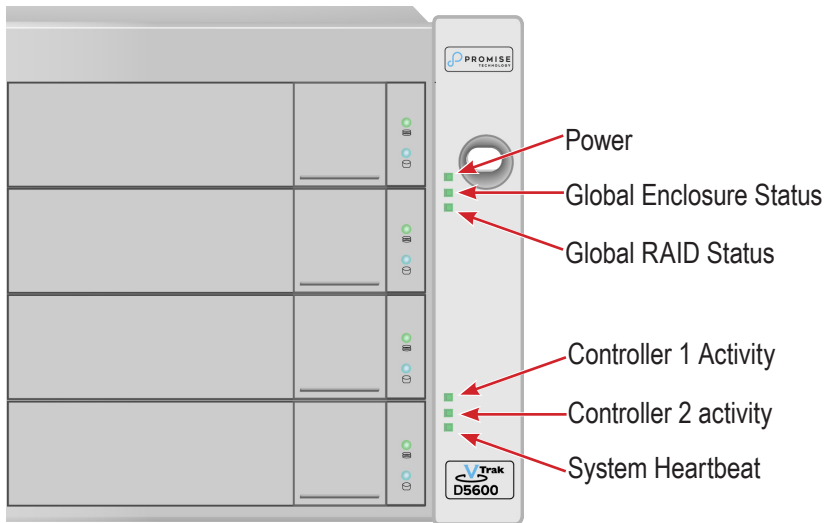

VTrak D5600/D5800 front right LED Behavior After Boot Up

State	Power	Global Enclosure	Global RAID	Controller Activity	Controller Heartbeat
Dark	No power	No power	—	Unit is off, or controller is not present or FC is not cable connected	—
Steady Green	Normal	Normal	Normal	Unit is up, controller is present and running, at least one FC cable is connected and a link is established.	—
Blinking Green	—	—	—	—	Normal**
Flashing Green	—	—	—	Activity	—
Amber	—	Problem*	Critical	—	—
Red	—	Failure*	Offline	—	—

* Check the LEDs on the back of the VTrak enclosure (controllers and PSUs).

** Blinks green once per second for two seconds for dual controller enclosure; blinks every four seconds for single controller enclosure.

Disk Carrier LEDs



The VTrak spins up hard disk drives sequentially to minimize power draw during start-up. After a few moments:

- The Power/Activity LED displays blue when a physical drive is present.
- The Drive Status LED displays green when the physical drive is configured as a member of a disk array or as a spare. When the physical drive is unconfigured, the LED is dark.

Steady means the LED is on.

Blinking means a regular on/off pattern.

Flashing means intermittent and irregular on/off pattern.

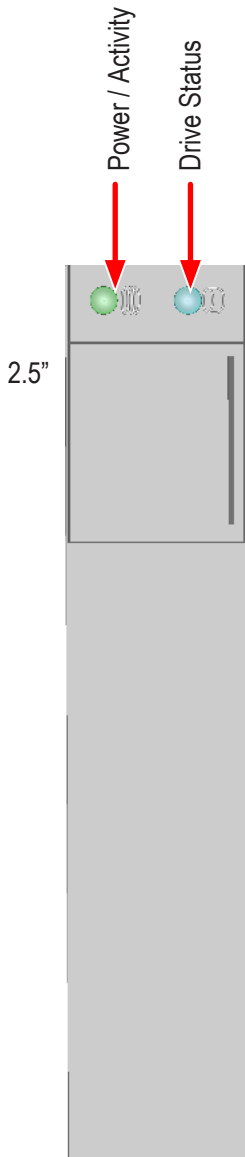

Drive Status LED Behavior After Boot Up

State	Power/Activity	Drive Status
Dark	No drive in carrier	Drive is not configured
Steady Blue	Drive in carrier	—
Flashing Blue	Activity on drive	—
Steady Green	—	Drive is configured
Blinking Green	—	Locator feature
Amber	—	Drive is rebuilding
Red	—	Drive error or failure

* Configured means the physical drive either belongs to an array or it is assigned as a spare drive.

VTrak D5600 / VTrak D5800 Power Supply LEDs

The LEDs on the rear panel of the VTrak D5600 and VTrak D5800 include a single status LED on each power supply. These PSU status LED will light green to indicate normal operation. A red LED indicates a problem or unit failure.

Status LED on VTrak D5600/D5800 Power Supply

PSU Status LED

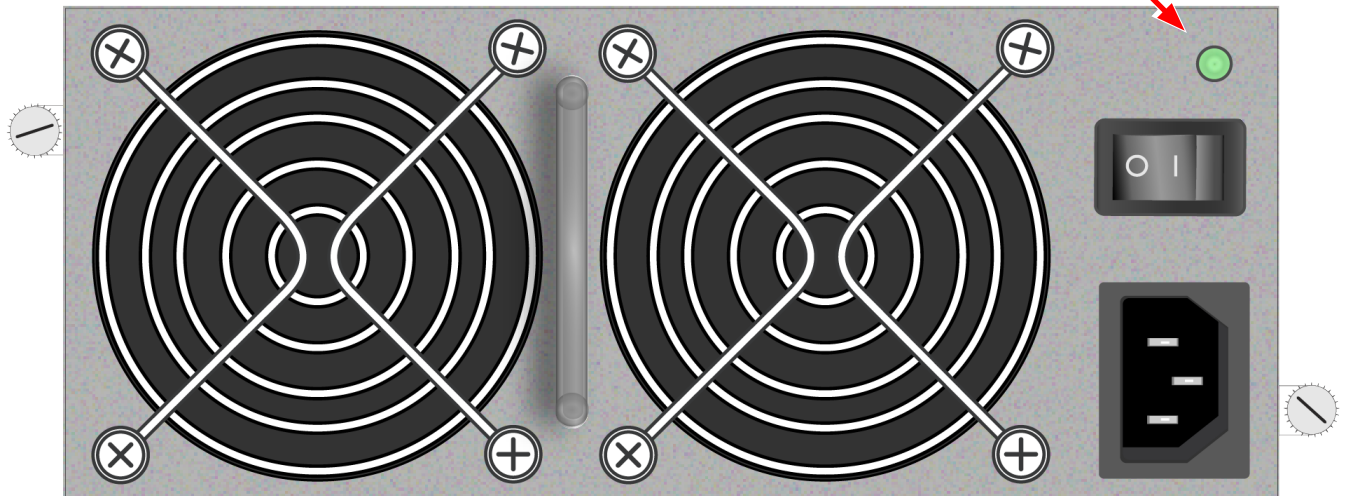

VTrak D5300 / VTrak D5320 Power Supply LEDs

The power supplies for the VTrak D5300 and VTrak D5320 have five LED indicators on each unit. See the table below for PSU LED behavior.

Power supply LED indicators on VTrak D5300/D5320

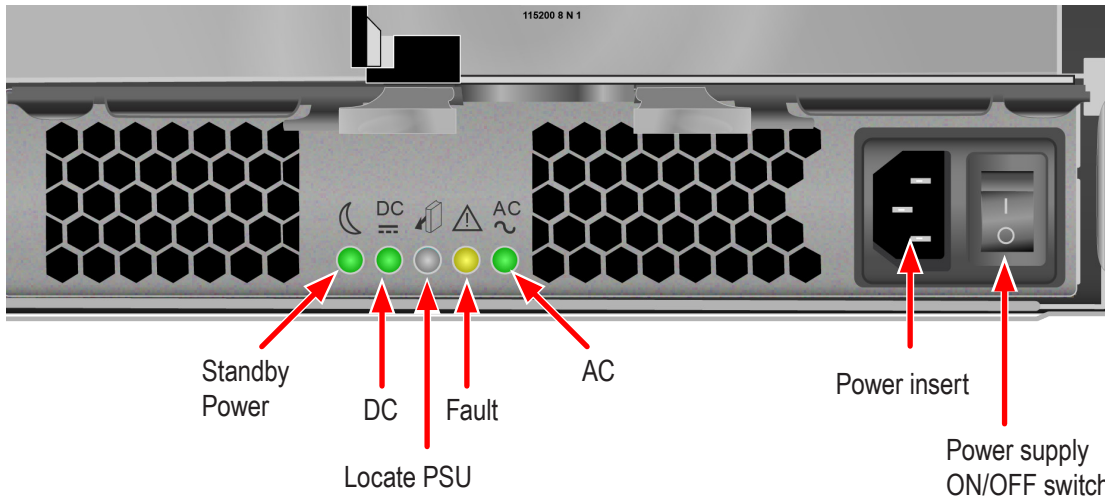

VTrak D5300/D5320 Power Supply LEDs

LED	Description
Standby Power	This indicates the standby power status. If the standby power is on and the power switch is off, the LED lights green. If the standby power is on and the power switch is on, then the LED will be off.
DC	This indicates if the power supply is properly inserted into the enclosure. The LED lights green when the power supply is properly inserted and the power supply is switched on. It is off if the power supply is not properly inserted, or when the power supply is switched off.
Fault	This indicates the overall health status of the power supply. When the power supply is functioning normally and no problems are detected, it will be off. If a problem with the power supply is detected, it light amber. Note that this LED blinks once when the power supply is switched on, then remains off unless there is a problem.
AC	This indicates that input power is present. When the power supply is switched on, it lights green if input power is available. It is off if power is not present and when the power supply is switched off.
Locate PSU	This flashes blue when using the <i>Locate PSU</i> function.

Controller LEDs

When boot-up is finished and the VTrak D5000 subsystem is functioning normally:

- Controller status LEDs display green continuously.
- Ethernet LEDs display green or flash depending on your network connection.
- The FC, SAS, and Expansion LEDs display green or flash during port activity.

See table on next page for complete description of controller LEDs.

Controller LEDs

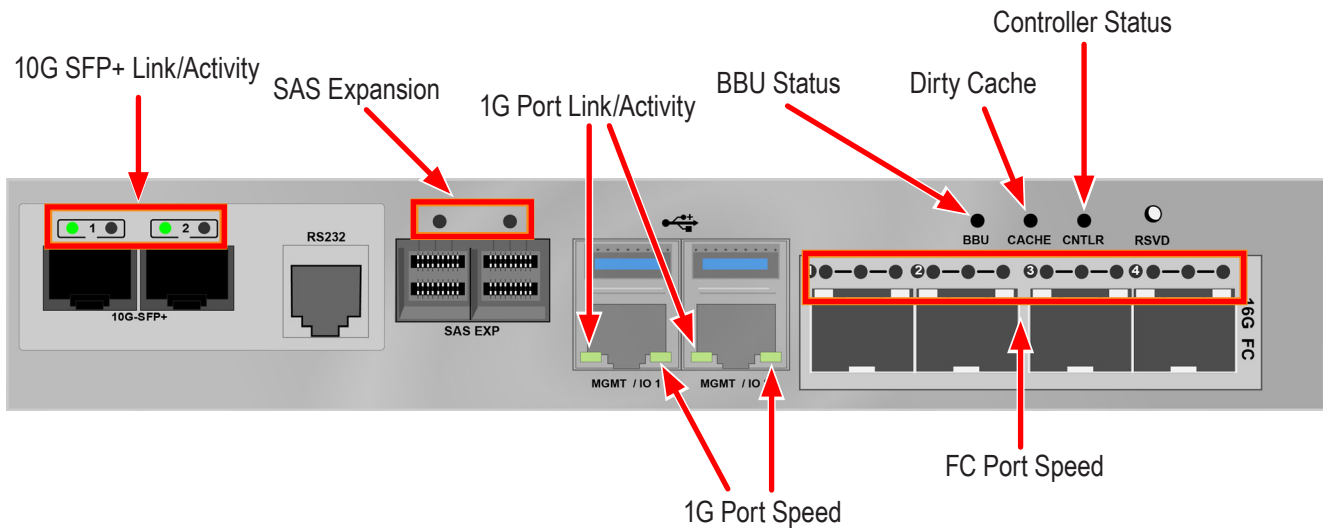

Controller LED Behavior

The table below describes behavior of the LED indicators on the VTrak D5000 Series controller.

LED	Description
10G SFP+ Link/Activity	Left LED: Solid green light indicates a link. Right LED: Flashing green light indicates activity.
SAS Expansion	One LED indicator for each SAS expansion port. These light green when connected, and flash green when there is activity.
1G Port Link/Activity Speed	Left LED: Flashing light indicates activity. Right LED: Solid green light indicates a link.
Controller Status	This displays the current operational status of the controller. A steady (unblinking) green light indicates the controller is operational. This will blink green when using the controller locator feature. A blinking amber light indicates a problem. Steady red light indicates controller failure. A flashing red light means the controller is in Maintenance Mode (offline while in Maintenance Mode).
Dirty Cache	Lights steady amber if cache is dirty, meaning that the controller memory cache contains data, otherwise this is dark. This will blink green when using the controller locator feature.
Battery Status	This lights steady green when the battery status is healthy (normal). Red indicates the battery has failed. A steady amber light indicates there is not enough reserve power in the battery to backup cache memory if the power fails.
FC ports	See next page

LED indicators for Fibre Channel ports, three LEDs for each FC port

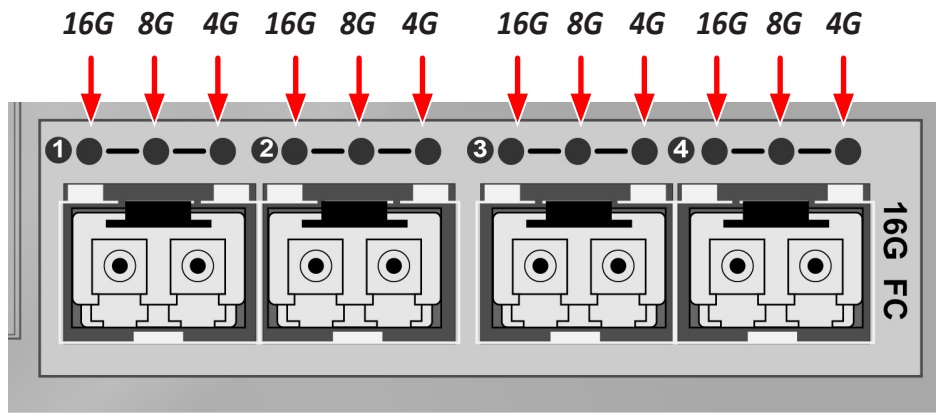

Fibre Channel Port LED behavior

LEDs	Power on (Before Firmware Initialization)	Power on (After Firmware Initialization)	Firmware Fault	4 Gbps Link Up/ACT	8 Gbps Link Up/ACT	16 Gbps Link Up/ACT
Green LED (16 Gbps)	On	Flash	Flash in sequence	Off	Off	On/Flash when active
Green LED (8 Gbps)				Off	On/Flash when active	Off
Green LED (4 Gbps)				On/Flash when active	Off	Off

All Fibre Channel port LED indicators will be dark when the system is powered off. If all three indicators for a port flash simultaneously, then there is no SFP transceiver installed, or the wrong type of transceiver is installed, or the port is not connected.

Resetting the Default Password

This feature resets the Administrator’s password to the default factory setting, password. Use this feature when you have forgotten Administrator’s password or a new Administrator has been appointed.

The reset applies to the Administrator’s login for WebPAM PROe and the CLI. No other user passwords are affected.

To reset the Administrator’s default password:

1. Verify that the VTrak has fully booted.
2. For one of the RAID controllers, locate the password reset switch. *See illustration below.*
3. Insert a pin or a straightened paper clip into the opening and momentarily depress password reset switch.

You only need to press the reset switch on one RAID controller.

The next time the Administrator logs in, use the default password: **password**.



Important

PROMISE recommends that you change the Administrator’s default password immediately after reset.

Password reset switch on controller

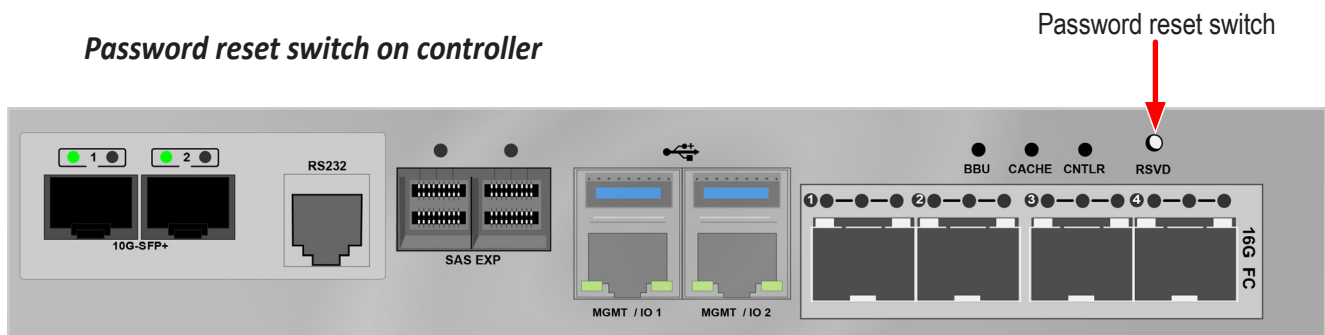

WEBPAM PROE - SYSTEM CONFIGURATION

This chapter describes system configuration using WebPAM PROe. The information is presented in approximately the same order the links for the menus appear in the WebPAM PROe user interface. The menus, submenus and other configuration information includes the following:

- Logging into WebPAM PROe
- Viewing the Storage Network
- Dashboard
- Creating a Shared Storage Pool
- Creating a Volume

LOGGING INTO WEBPAM PROE

1. Launch your browser.
2. In the browser address field, type in the virtual management port IP address of the VTrak D5000 subsystem.

Use the IP address you set in the CLI.

Note that WebPAM PROe requires a secure HTTP connection (i.e. https://). For example, if your VTrak D5000 has an IP address: 10.0.0.1 your entry looks like this: **https://10.0.0.1**

3. When the login screen appears:
 - Type **administrator** in the User Name field.
 - Type **password** in the Password field.
 - Click the **Login** button.

The User Name and Password are case sensitive.

4. Optional. Choose a display language from the drop-down menu.

WebPAM PROe displays in English and Simplified Chinese.

5. Click the **Login** button.

After login, the WebPAM PROe main menu appears.

Choosing the Display Language

WebPAM PROe displays in multiple languages. You choose the display language when you log in.

If you are already logged in and you want to change the display language:

1. Click **Logout** at the top right corner of the screen.

The Login screen appears.

2. Click the Language drop-down menu and highlight the language you prefer.

Login language selection menu



3. Reenter your user name and password.
4. Click the **Login** button.

WebPAM PROe opens in the language you chose.

Perusing the Interface

The WebPAM PROe interface consists of a header and four tabs, each with specific functions.

- Header

Top right corner of the window:

- Event Notification
- Save Service Report – Saves a detailed report to your Host PC
- Name of logged-in user
- Logout – Exits WebPAM PROe

Use the pulldown menu (small telephone icon) to see these links:

- Get Help – Accesses the Help Welcome screen
 - About – Information about WebPAM PROe
 - Contact Us – Technical support contact information
- Discovery tab (located in bottom left corner of WebPAM PROe window)
 - Displays other PROMISE RAID systems on your network
 - Enables direct login to other PROMISE RAID systems

The main information and configuration menus are as follows:

- Dashboard tab
 - Subsystem Health quick summary
 - Capacity Utilization summary
 - Performance graphic summary
- Pool tab
 - Create New Pool button (Setup Wizard)
 - Pool List (including Extend or Delete existing pool)
 - Cache (SSD cache configuration)
 - Spare Drive (including create or delete spare drive)
- Volume tab
 - Create New Volume button (Setup Wizard)
 - Volume List (including Delete, Export, and Un-export)
 - LUN Mapping & Masking
 - Periodic Snapshot

List continues on next page

- NAS Share tab
 - Create New NAS Share
 - NAS Share List
 - Protocol
 - Periodic Snapshot
- NAS Account tab
 - NAS User (Create, delete, modify users)
 - NAS Group
 - Domain
- Device tab
 - Device Overview (Device status and information summary, NTP settings, Date and time setting, Subsystem restart and shutdown)
 - Device View (Front View, Back View, Topology)
 - Component List (Enclosure, Controller, Battery, Buzzer, summary and configuration)
 - Physical Drive (Physical drive information summary, Physical drive settings)
 - UPS (summary and configuration)
 - Initiator (summary delete, add initiator)
 - Network Management (Virtual and physical port summary and configuration)
 - FC Management (Information and configuration for FC including: Node, Port, Statistics, Logged in devices, Devices on fabric, SFP)
 - iSCSI Management (Information and configuration for iSCSI including: Target, Port, Session, Portal, iSNS, Trunk, Chap, Logged in devices)
- Administration tab
 - Events
 - Management User
 - Service
 - Performance Monitor
 - Image Version
 - Firmware Update
 - Background Activity
 - Restore Factory Default
 - Import/Export
 - Product Registration
 - Setup Wizard

Web PAM PROe Main menu/Dashboard

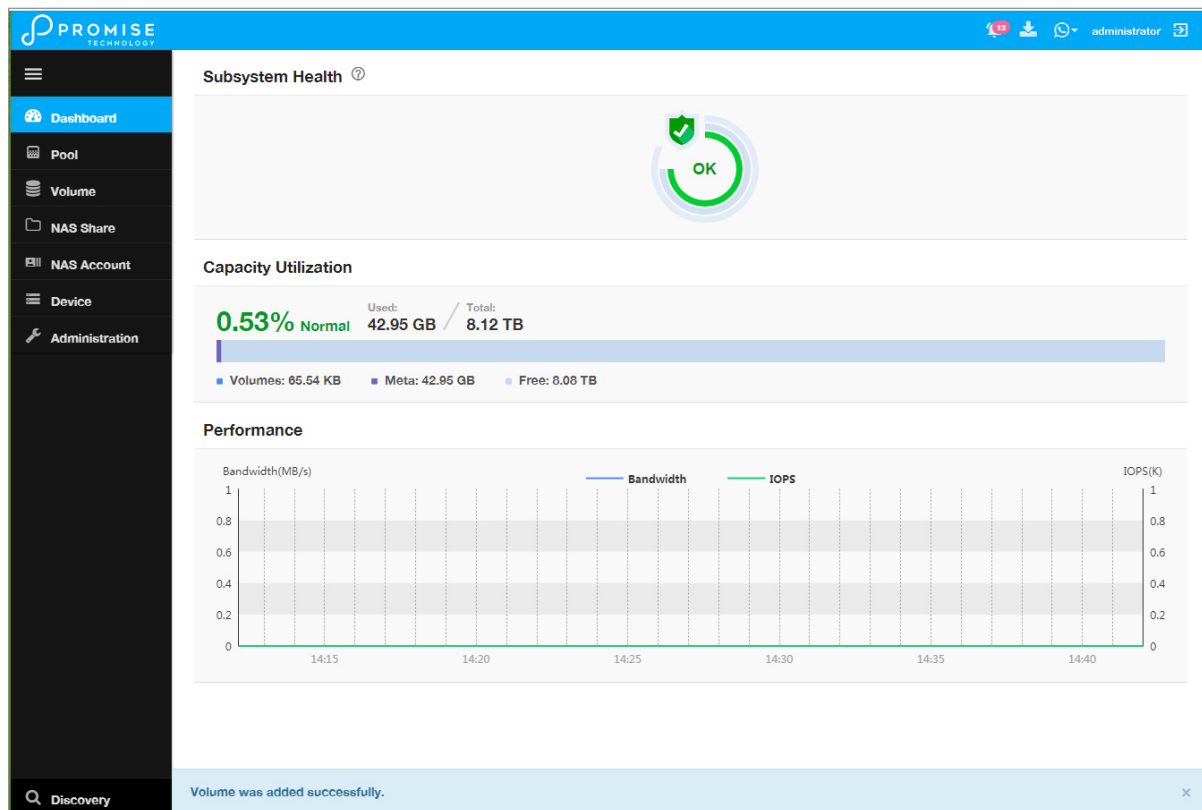

Logging out of WebPAM PROe

There are two ways to log out of WebPAM PROe:

- Close your browser window
- Click the **Logout** icon in the upper right corner of the GUI

Clicking Logout brings you back to the Login Screen.

After logging out, you must enter your user name and password in order to log in again.

VIEWING THE STORAGE NETWORK

To view the other subsystems on your Storage Network, click the **Discovery** button at the left bottom edge of the WebPAM PROe window.

Discovery menu in Main menu

The screenshot shows the WebPAM PROe interface. On the left is a navigation menu with options like Dashboard, Pool, Volume, User, Device, and Administration. The 'Pool' section is active, showing a 'Create New Pool' button and a list of pools (pool1, pool2). The main area displays the 'Pool List' with a table of pools. A 'Discovery' modal window is open in the foreground, listing various storage devices and their IP addresses.

ID	Name	Status	Capacity	RAID Level	Affinity
0	pool1		Free: 13.88 TB/Total: 13.88 TB	RAID5	Controller 2
1	pool2		Free: 3.57 TB/Total: 3.57 TB	RAID6	Controller 2

Device	IP Address
VT17=VTrak	D5800
VT19=VTrak	D5800
VT35=VTrak	D5605
EUT_script=VTrak	D5805
=VTrak	E5600f
=VTrak	E630f
=Vess	R2600fi
=VessRAID	1830s+

Logging onto a Subsystem

To log onto a subsystem in the list, click on the IP address of that subsystem.



Caution

The new subsystem displays in the same browser tab. Click your browser's back button to return to the original subsystem.

DASHBOARD

The Dashboard presents a quick system status overview, including graphs for storage capacity utilization, I/O performance and network bandwidth used.

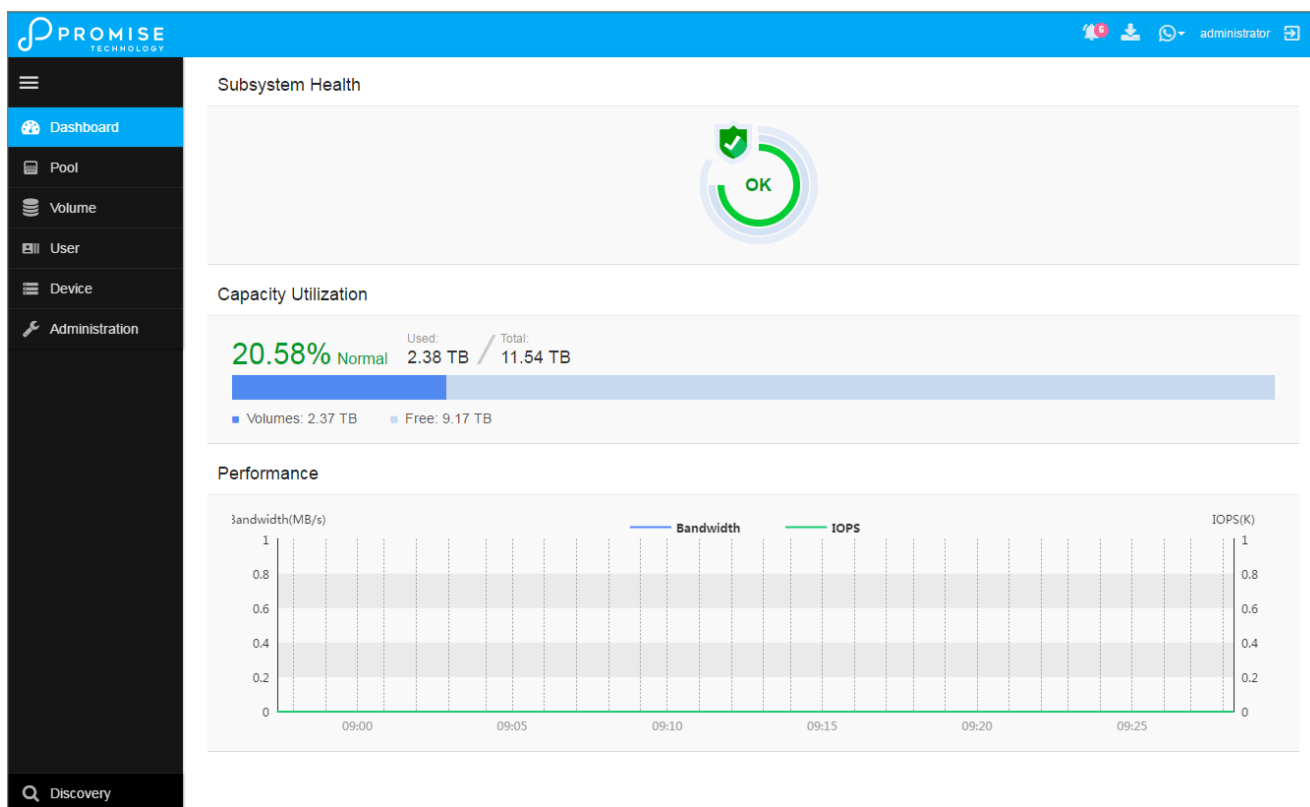

Capacity Utilization

A graph and numerical list of total available storage capacity, used capacity, size of existing volumes, storage used for snapshots, and free capacity.

Performance

A graphic summary of Bandwidth in MB/s and I/Os per second

Dashboard with new events

Click here to view
Events notices

Click here to
generate a
service report



Generating a Service Report

A Service Report is a detailed report covering the configuration and status of all components in your RAID system. A support technician or field engineer might request a service report for the purpose of diagnosis and troubleshooting.

To save a Service Report file:

1. Click the **Generate Service Report** in the Header (very top of the web interface, next to the *Events/Alarm* icon. It looks like a 'download' icon.).

Information for the report is gathered and compiled. This action takes up to a few minutes, depending on the report size of your RAID system

2. In the **Save File** dialog, click the **Save** button.

The report saves to your Host PC as a compressed HTML file.

3. Double-click the downloaded file to decompress it.
4. Double-click the report to open it in your default browser.

CREATING A SHARED STORAGE POOL

The first step for provisioning storage capacity to client systems is create a storage pool. The storage pool is a storage resource consisting of a number of hard disks in a RAID configuration.

After logging in, the Dashboard appears. Since the device is not yet configured, there will be little information in the Dashboard. The Dashboard is described in a later section once there is meaningful information to present.

To begin setting up the pool, you can click on the link in the middle of the menu, *Storage is not configured. Click here to create one*; or, click on the **Pool** menu icon in the left panel, then click the **Create Pool** button.

Dashboard

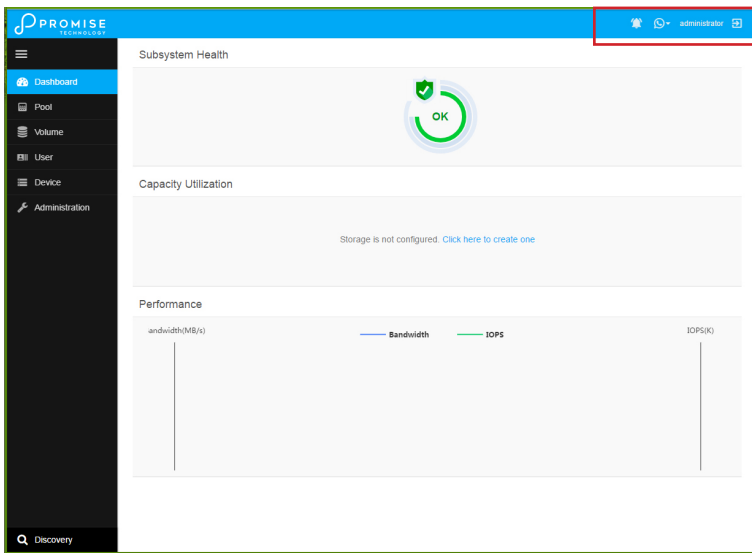

Create New Pool

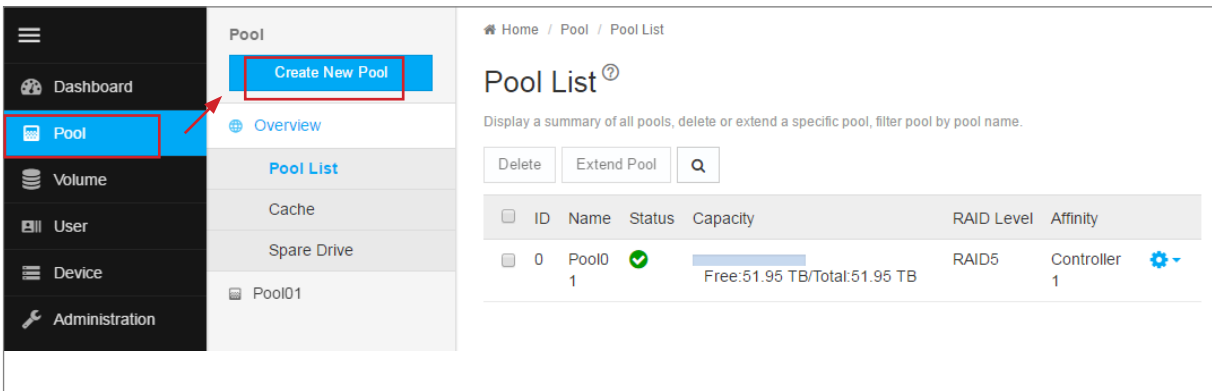

In the Create New Pool menu, click to select the available hard disks you want to be in the pool, the selected disks become darker in color to indicate selection. Type a name used for the pool, then choose the remaining parameters:

- **Media Type** (HDD or SSD)
- **RAID Level** (RAID0, 1, 5, 6, 10, 50, and 60)
- **Stripe Size** (64 KB, 128 KB, 256 KB, 512 KB, and 1 MB)
- **Sector Size** (512 B, 1 KB, 2 KB, and 4 KB)
- **Preferred Controller**

Choose drives for new pool

[Go Back](#) **Create New Pool** ?

Create new pool with specific physical drives, pool name and other settings.

Name:

Media Type:

Selected Physical Drives:

Enclosure 1: **SBB-SAS-12G-3U-16Bay**

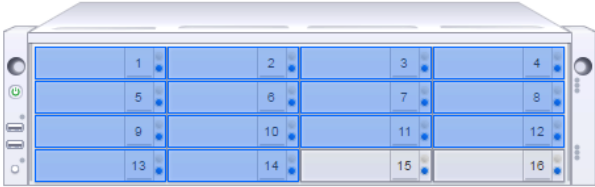

RAID Level:

Stripe Size:

Sector Size:

Preferred Controller: Controller 1 Controller 2

Click on the **Submit** button to create the pool.

Pool List

Storage pools are listed in the Pool List after creation. Use this menu to delete or extend a pool. To view more detail, click on the gear icon for the pool and select the *Detail* option. Note that, except of the pool name and preferred controller, pool parameters cannot be edited once it has been created.

To extend a pool, select it in the list and click on the **Extend** button. The Extend menu appears. If you want to add JBOD units, the Extend Pool procedure is used to add JBODs.

To delete a pool, select it and click the **Delete** button. You will need to confirm that you want to delete the pool in a pop-up menu. Type “confirm” and click the Confirm button to remove the pool. The drives in that pool revert to unassigned available status.

View current shared pool configuration

Extending a Storage Pool with JBOD

A storage pool can be extended if there are physical disks available in the original enclosure, or in a VTrak J5000 JBOD connected via SAS cable to the VTrak D5000 head unit. If you plan to expand capacity using JBODs, it is necessary to use the Extend Pool process for each JBOD added. You can add up to 12 JBOD units to one VTrak D5000.



Important

For a RAID5 or RAID6 pool, there is a limit of 36 disks. It is possible to expand a storage pool across multiple enclosures, however this is not a best practice; and doing so requires using RAID50 or RAID60.

Creating Spare Drive

Spare drives can be created at anytime, as long as there are unassigned drives available. The spare drive should be the same type (SSD or HDD) as the drives in the pool. Note that in this example, there is only one pool created, so the *Type* is irrelevant.

To create a spare drive, go to the Pool menu, and click **Create a Spare Drive**. Click to select an available hard disk, the selected disk become darker in color to indicate selection. Change the following spare drive options as desired:

- **Revertible** (reverts back to spare drive status after RAID is repaired or restored)
- **Type** (*Global* - available for any pool on the system, or *Dedicated* - assigned to specific pool)
- **Media** (*HDD* or *SSD*, must be same as pool)

Click on the **Submit** button to create the spare drive.

Create spare drive

[Go Back](#) **Create Spare Drive** [?]

Create a global or dedicate spare drive.

Revertible:

Type: Global Dedicated

Media Type:

Selected Physical Drives:

Enclosure 1: **SBB-SAS-12G-3U-16Bay**

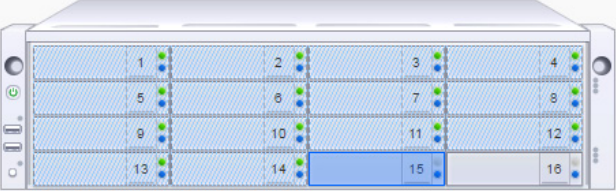

Spare Drive List

Spare drives are listed in the Spare Drive list. Use this menu to delete a spare drive or to view more details about a spare drive. Click the gear icon and select *Detail* to view information about a spare drive.

To delete a spare drive, select it in the list and click on the **Delete** button. You will need to confirm that you want to delete the spare drive in a pop-up menu. Type “confirm” and click the Confirm button to remove the spare drive. The drive status reverts to an unassigned available drive.

View spare drives

The screenshot shows the 'Spare Drive' management page in the Promise Technology interface. The breadcrumb path is 'Home / Pool / Spare Drive'. The page title is 'Spare Drive' with a help icon. Below the title, there is a description: 'Display a summary of spare list. Create, delete or modify spare drive.' and three buttons: 'Create Spare Drive', 'Delete', and 'View Detail'. A table lists the spare drives with the following data:

<input type="checkbox"/>	ID	Status	Config Capacity	Physical Drive ID	Revertible	Type	Dedicated to Pool
<input type="checkbox"/>	0	✔	4 TB	15	Yes	Global	
<input type="checkbox"/>	1	✔	4 TB	16	No	Global	

Creating an SSD Cache

You have the option to use installed SSD drives for the read and/or write data cache. To create an SSD write cache, there must be two SSD drives installed in order to mirror the drives. For a read cache, at least one SSD is needed (no mirroring for the read cache). SSD caching greatly improves read and/or write performance of the system.

To create an SSD cache, go to the **Pool** menu, expand the *Overview*, and click on **Cache**. This menu lists any previously created read or write SSD caches. Click the **Create Cache** button.

Create SSD Cache

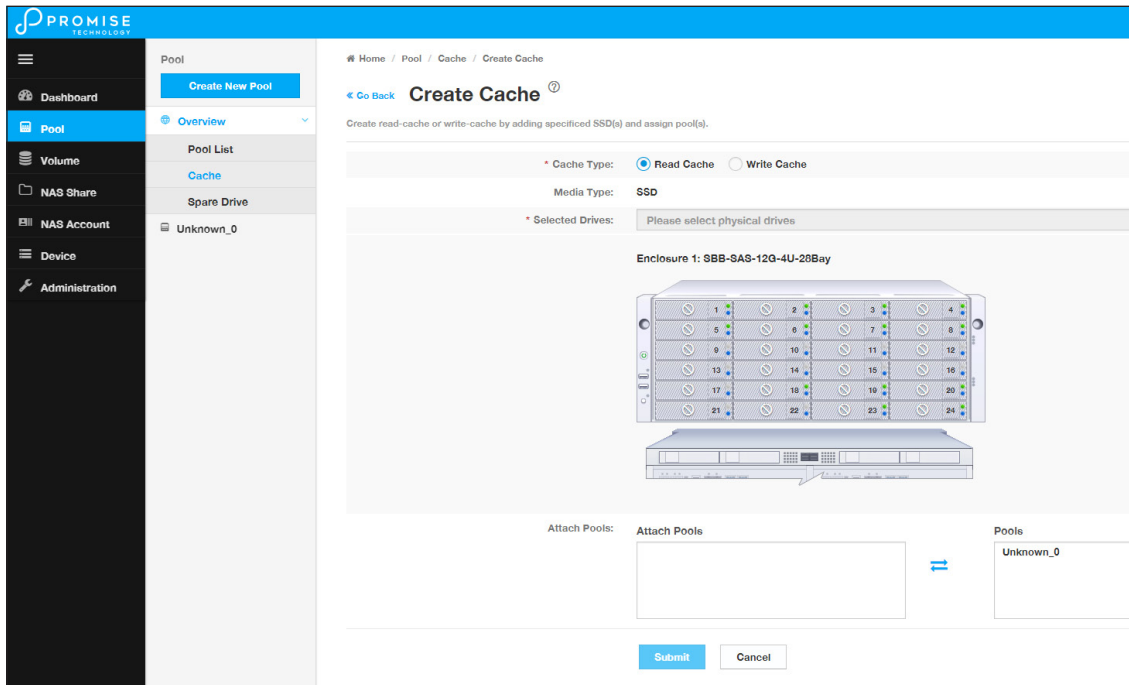

Use the Create Cache menu to select SSD drives and create a read or write cache.

CREATING A VOLUME

Now that we have a storage pool, we can create volumes in the pool. The main decision for volumes is whether to use thin or full provisioning. Thin provisioning allows for creation of volumes which have a total cumulative capacity that is greater than the physical capacity available for the pool. Thin provisioning might not be appropriate for certain applications. So plan your storage utilization carefully.

To create a new volume, go to the **Volume** menu, click the **Create New Volume** button, and **Create Volume** menu appears.

Create new volume

The screenshot displays the 'Create Volume' form in the Promise Technology web interface. The sidebar on the left shows the 'Volume' menu selected. The main content area has a breadcrumb trail: Home / Volume / Create Volume. The form title is 'Create Volume' with a help icon. Below the title, it says 'Create new volume with specific pool, volume name, capacity and other settings.' The form fields are:

- Pool Name:** A dropdown menu showing 'R0_c1'.
- Volume Name:** A text input field with a placeholder 'Max length is 32 characters.'
- Enable Thin Provisioning:** An unchecked checkbox.
- Capacity:** A text input field with '1', a 'GB' dropdown menu, and a note 'Max capacity 2.86 GB available' and '1PB thin provision'.

At the bottom of the form, there is a blue 'Submit' button and a grey 'Cancel' button. A link 'Expand Advanced Settings' is also visible.

In the Create Volume menu, enter a name for the new volume, and click the *Enable Thin Provisioning* option if you plan to use thin provisioning on this pool.

Next, enter a value for the volume capacity, note that you need to specify *TB* or *GB* in a separate pull-down menu. Click on the **Submit** button to create the new volume. This volume should now appear listed in the **Volume List**. Volumes are exported by default. An exported volume becomes available for sharing on the storage network. To Un-export a volume, use the Volume list menu.

Volume List

Use the Volume List menu to *Un-export*, *Export*, or *Delete* existing volumes. Also, this is where you can link to *LUN Mapping and Masking* to enable it.

To view more detailed information for a volume, you can either click the gear icon for the volume and select the *Detail* option, or click on the volume name in the left panel under *Overview*. Use the individual volume menu to link to the **Snapshot** and **Clone** menus.

Volume List

The screenshot shows the 'Volume List' page in the management console. On the left is a navigation sidebar with options like 'Create New Volume', 'Overview', 'Volume List', 'LUN Mapping & Masking', and 'Periodic Snapshot'. The main area displays a table of volumes. Below the table are buttons for 'View', 'Modify', 'Delete', 'Export', 'Un-export', and a search icon.

ID	Name	Capacity	Block Size	Exported Status	Pool Name	Affinity
0	v1	Available:0 Byte/Total:35 GB	8 KB	Exported	R0_c1	Controller1
1	v2	Available:0 Byte/Total:35 GB	8 KB	Exported	R1_c2	Controller2
2	v3	Available:0 Byte/Total:35 GB	8 KB	Exported	R5_c1	Controller1
3	v4	Available:0 Byte/Total:35 GB	8 KB	Exported	R6_c2	Controller2
4	v5	Available:0 Byte/Total:35 GB	8 KB	Exported	R10_c1	Controller1
5	v6	Available:0 Byte/Total:35 GB	8 KB	Exported	R50_c2	Controller2
6	v7	Available:0 Byte/Total:35 GB	8 KB	Exported	R60_c1	Controller1
10	iSCSI_v1	Available:0 Byte/Total:40 GB	8 KB	Exported	R5_c1	Controller1
11	iSCSI_v2	Available:0 Byte/Total:45 GB	8 KB	Exported	R6_c2	Controller2
12	iSCSI_v3	Available:0 Byte/Total:50 GB	8 KB	Exported	R50_c2	Controller2
13	iSCSI_v4	Available:0 Byte/Total:55 GB	8 KB	Exported	R60_c1	Controller1

Individual volume information

The screenshot shows the 'Individual volume information' page for volume 'v1'. The left sidebar is expanded to 'Volume' and 'v1'. The main content area shows the volume name 'v1' and a 'Snapshot & Clone' button. Below is a 'Volume Information' section with the following details:

- Name: v1
- Pool Name: R0_c1
- Capacity: Available:0 Byte/Total:35 GB
- Thin Provision: Disabled
- Exported Status: Exported
- Exported WWN: 2212-0001-555d-d702

At the bottom, there is a link to 'Expand Detail Information'.

Snapshots

A volume snapshot is used to capture a read-only copy of the volume status at the time the snapshot is created. The snapshot is saved in case it is necessary to revert back to the volume status at the time of the snapshot for disaster recovery. This is called a rollback.

Rolling back to a previous snapshot will discard all data changes that have occurred between the time of the snapshot and the current time.

Snapshots and clones are a quick and low cost (in terms of capacity used) means of backing up a volume for the purpose of recovery.

To create a volume snapshot, click on the volume name in the left panel, click the **Snapshot & Clone** button, *you will see the Snapshot & Clone list*, then click the **Create Snapshot** button.

Create Snapshot

Home / Volume / WebServer01 / Snapshot & Clone / Create Snapshot

[Go Back](#) Create Snapshot [?]

Create Snapshot

Pool Name:	Pool01
Volume Name:	WebServer01
Snapshot Name:	<input type="text"/>

In the Create Snapshot menu, enter a name for the snapshot and click the **Submit** button. The snapshot will appear listed Snapshot and Clone list.

Clones

A clone is created from a snapshot as a means of backing up the snapshot. If you intend to delete a snapshot that has a clone, you must first delete the clone.

To create a snapshot clone, first create the snapshot, select it in the Snapshot & Clone list, click on the **Create Clone** button.

Create Clone

Home / Snapshot & Clone / Create Clone

[Go Back](#) **Create Clone** ?

Create Clone

Pool Name:	Pool01
Volume Name:	WebServer01
Snapshot Name:	2017.04.21
Clone Name:	<input type="text"/>

In the Create Clone menu, enter a name for the clone and click the **Submit** button.

Rollbacks

To rollback using a snapshot, select the snapshot, click on the gear icon, and choose the *Rollback* option. You are required to confirm that you want to rollback using the snapshot in a pop-up menu. Type “confirm” and click on the **Confirm** button to proceed with the rollback. Remember, any changes in the volume that have occurred since the snapshot will be lost.

Rollback option

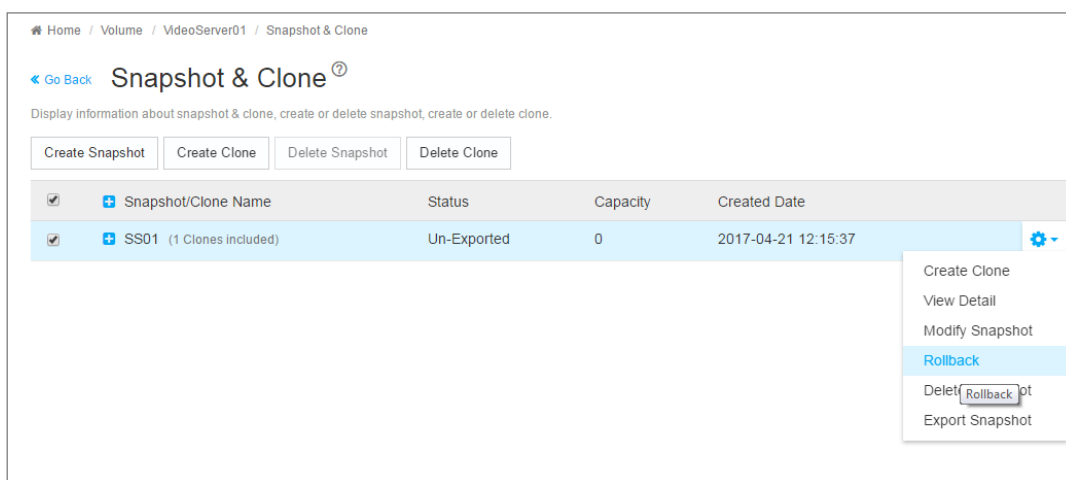

LUN Mapping and Masking

This feature applies to Fibre Channel SAN and iSCSI subsystems and controls user access to storage resources.

- LUN Mapping – Maps a LUN to an initiator; a LUN can be mapped to multiple initiators.
- LUN Masking – The process of applying a LUN Map.

To access LUN mapping:

1. Click the **Volume** tab.
2. Under **Overview**, click the **LUN Mapping & Masking** menu link.

To enable or disable LUN Masking, click on the **Enable LUN Masking** slider to toggle on LUN masking.

Adding a LUN Map

For Fibre Channel and iSCSI (SAN) systems, you can set up an Initiator LUN map.

A maximum of 256 logical drives can be mapped to a Fibre Channel initiator.

To assign a LUN to an initiator, the initiator must have been previously added to the initiator list.

(See “Adding a Fibre Channel or iSCSI Initiator” on page 93.)

To add a LUN map:

1. Click the **Volume** tab.
2. Click on **LUN Mapping & Masking**.
3. Click the **LUN Mapping** button. (See sample menu on next page)
4. In the LUN Mapping menu, the Initiators appear on the left side with volumes (including snapshots and clones) on the right. Use this menu to select a volume or volumes to assign to an initiator. Click the box to select an ID number of existing volumes, snapshots or clones in the right side, and use the arrow transfer button to assign them to the preferred initiator.
5. Click the **Submit** button.
The new LUN map is created.
6. By default, LUN Mapping & Masking is not enabled. To use LUN Mapping & Masking, it must be enabled in the LUN Mapping & Masking tab.

LUN Mapping

Home / Volume / LUN Mapping & Masking / LUN Mapping

[Go Back](#) **LUN Mapping** ?

Set LUN mapping with specific volumes, snapshots or clones with LUN ID. Click < or << button to add volume/snapshot/clone into selected initiator box, or click > or >> to remove the added volume/snapshot/clone.

FC Initiator ID 0 21-00-00-0e-1e-2c-69-90
Add a volume/snapshot/clone here

FC Initiator ID 1 21-00-00-0e-1e-2c-69-91
Add a volume/snapshot/clone here

ISCSI Initiator ID 2 iqn.1991-05.com.microsoft:asg-eut-host1
Add a volume/snapshot/clone here

Volume Snapshot Clone

ID	Name	Capacity	Pool Name
0	v1	35 GB	R0_c1(Pool 0)
1	v2	35 GB	R1_c2(Pool 1)
2	v3	35 GB	R5_c1(Pool 2)
3	v4	35 GB	R6_c2(Pool 3)
4	v5	35 GB	R10_c1(Pool 4)
5	v6	35 GB	R50_c2(Pool 5)
6	v7	35 GB	R60_c1(Pool 6)
10	iSCSI_v1	40 GB	R5_c1(Pool 2)
11	iSCSI_v2	45 GB	R6_c2(Pool 3)
12	iSCSI_v3	50 GB	R50_c2(Pool 5)
13	iSCSI_v4	55 GB	R60_c1(Pool 6)

Submit **Cancel**

Editing a LUN Map

Editing a LUN map is the action of assigning a logical drive or LUN to an initiator. By changing the assignment, you change the initiator's access.

To edit a LUN map:

1. Click the **Volume** tab.
2. Click on **LUN Mapping & Masking**.
3. Select the LUN to be edited.
4. Click on the **Gear** icon and select the *Modify* option.
5. To remove a volume from an initiator, click to select a Volume on the left side, and use the arrow transfer button to remove the volume from the initiator. To add a volume, Click the box to select an ID number of existing volumes in the right side, and use the arrow transfer button to assign the volume to the preferred initiator.
6. Click the **Submit** button.

The modified LUN map is created.

LUN Mapping & Masking

Home / Volume / LUN Mapping & Masking

LUN Mapping & Masking [?]

Display a summary of LUN Mapping & Masking list. Enable or disable LUN Masking. Delete or modify LUN Mapping.

Delete LUN Mapping Enable LUN Masking

<input type="checkbox"/>	Initiator ID	Initiator Name	LUN Mapping	
<input checked="" type="checkbox"/>	0	21-00-00-0e-1e-2c-60-90	(Volume0, Initiator LUN 0);(Volume1, Initiator LUN 1)...	
<input type="checkbox"/>	1	21-00-00-0e-1e-2c-60-91	(Volume0, Initiator LUN 0);(Volume1, Initiator LUN 1)...	Modify
<input type="checkbox"/>	2	iqn.1991-05.com.microsoft:asg-eut-host1	(Volume10, Initiator LUN 0);(Volume11, Initiator LUN 1)...	Delete

Deleting a LUN Map

Deleting a LUN map prevents the initiator from accessing the LUN while LUN masking is enabled.

To delete a LUN map:

1. Click the **Volume** tab.
2. Click on **LUN Mapping & Masking**.

The list of LUN maps appears.

3. Click to select the LUN map you want, then click the **Gear** icon, and select the *Delete* option
4. In the Confirmation box, type the word “confirm” in the field provided and click the **Confirm** button.

Enabling and Disabling LUN Masking

Disabling LUN masking allows all initiators to access all LUNs in your data storage. However, disabling LUN masking does not delete existing LUN maps.

These actions require **Administrator** or **Super User** privileges.

To enable or disable LUN masking:

1. Click the **Volume** tab.
2. Click on **LUN Mapping & Masking**.
3. Click on the **Enable LUN Masking** slider to toggle off (disable) or on (enable) LUN masking.

MANAGEMENT USER

Management users can view the VTrak D5000 user interface or make configuration changes according to the privilege level configured for the user. Only **Super** user level management users can add, remove or modify users. *Note that the Administrator has Super user level privilege.*

Management User list

The screenshot shows the 'Management User' page in the VTrak D5000 interface. The page title is 'Management User' and it includes a description: 'Display information about management users. Add or delete a specific user, change a specific user's password, modify a specific user's information.' Below the description are buttons for 'Change Password', 'Modify', 'Delete', and 'Add New User'. A table lists the following users:

User Name	Display Name	Privilege	Email	Status	Type
administrator	Super user	Super	admin@yourcompany.com	Enable	Local
User01	EvilJulius	Super	EvilJulius@superhugemegacorp.com	Enable	Local
User20	NotFrank	Maintenance	DefinitelyNotFrank@superhugemegacorp.com	Enable	Local
User30	URhere	View	URhere@superhugemegacorp.com	Enable	Local

Making Maintenance Mode Settings

Each controller has its own IP addresses for access when the controller goes into maintenance mode.

To make maintenance mode settings:

1. Click the **Device** tab.
2. Click the **Network Management** tab.
3. Click the **Management Portal** tab.
4. For maintenance mode, use the **Static IP** settings.



Important

Static IP settings are used when the controller is in maintenance mode.

Management Portal

Management Portal [?]

Display a summary of Floating IPs and Static IPs. View detail information, change configuration for a specific floating IP or a specific static IP.

Floating IP

	Controller ID	Port ID	Protocol Family	IP Address	IP Mask	Link Status	
<input type="checkbox"/>	1	1	IPv4 (Enabled)	192.168.201.182	255.255.255.0	Up	
<input type="checkbox"/>	1	1	IPv6 (Disabled)	2001::1	ffff::	Up	

Static IP

	Controller ID	Port ID	Protocol Family	IP Address	IP Mask	
<input type="checkbox"/>	1	1	IPv4 (Enabled)	10.0.0.3	255.0.0.0	
<input type="checkbox"/>	1	1	IPv6 (Disabled)	2001::3	ffff::	
<input type="checkbox"/>	2	1	IPv4 (Enabled)	10.0.0.5	255.255.255.0	
<input type="checkbox"/>	2	1	IPv6 (Disabled)	fd00::5	ff00::	

Adding a New User

This action requires **Administrator** or **Super User** privileges.

To create a user:

1. Click the **Administration** tab.
2. Click the **Management User** tab
3. In the **Management User** menu, click the **Add New User** button.
4. In the **Add User** dialog box, enter the information in the fields provided:
 - Name – This is the user’s login name
 - Display Name
 - Password
 - Retype Password
 - User Email – Required for event notification
5. Choose a privilege level from the drop-down menu. See the table below for a description of the privilege types.
6. (Optional) Uncheck to disable this User account.
7. Click the **Submit** button. The user is added to the list.

User Privileges	
Level	Meaning
View	Allows the user to See all status and settings but not to make any changes
Maintenance	Allows the user to perform maintenance tasks including Media Patrol, and Redundancy Check
Power	Allows the user to create (but not delete) pools and volumes, change RAID levels, change stripe size; change settings of components such as pools, volumes, physical drives, and the controller
Super	Allows the user full access to all functions including create and delete users and changing the settings of other users, and delete pools and volumes. The default “administrator” account is a Super User

Changing User Settings

This action requires **Administrator** or a **Super User** privileges.

To change user settings:

1. Click the **Administration** tab.
2. Click the **Management User** tab
3. In the **Management User** menu, choose the user and click the **Modify** button.
4. Make settings changes as required:
 - For the Status box, check to enable this user account, uncheck to disable this user account
 - In the User Settings dialog box, enter a new **Display Name** or **User Email** address
 - Choose a new **Privilege** level from the drop-down menu.
5. Click the **Save** button.

Changing User Passwords

This action requires **Administrator** or **Super User** privileges.

To change a user's password:

1. Click the **Administration** tab.
2. Click the **Management User** tab
3. In the **Management User** menu, choose the user and click the **Change Password** button.
4. In the Change Password dialog box, enter the information in the fields provided:
 - New Password
 - Retype Password
5. Click the **Save** button.

Deleting a User

This action requires **Administrator** or **Super User** privileges

To delete a user:

1. Click the **User** tab.
2. In the **Management User** menu, choose the user and click the **Delete** button.
3. In the **Confirmation** box, type the word “**confirm**” in the field provided and click the **Confirm** button.

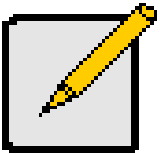

Note

The **Administrator** account cannot be deleted and the privilege level cannot be changed.

Setting User Event Subscriptions

By default, event notification is set to the Major (severity) level for all events.

Subscribing users receive notification of events at the chosen severity level and all higher levels.

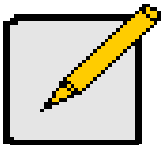

Note

Each user must have a valid **Email** address to receive events. Also, the email service must be properly configured with the **SMTP** server, including login information if necessary.

Changing a user subscription requires **Administrator** or **Super User** privileges.

To set a user event subscription:

1. Click the **User** tab.
2. In the User list, click the Gear icon for the user to configure, and choose the *Event Subscription* option.
3. Make settings changes as required:
 - For the **Enable Event Notification** box, check to enable for this user, uncheck to disable.
 - Click to change the priority options for each category of event.
4. Click the **Submit** button.

DEVICE

Use the Device menus to monitor subsystem status and make settings changes to subsystem components, drives, network settings, etc.

Device Overview

The screenshot shows the 'Device Overview' page in the Promise Technology WebPAM PROe interface. The left sidebar contains a navigation menu with options like Dashboard, Pool, Volume, User, Device, Administration, and Discovery. The main content area is titled 'Device Overview' and includes a breadcrumb trail 'Home / Device / Overview'. Below the title, there are three buttons: 'Date and Time Setting', 'NTP Setting', and 'Shutdown/Restart Subsystem'. The 'Device Status' section shows 'Enclosure Status: Enclosure 1: OK - Everything is OK' and 'Controller Status: Controller 1: OK - Active, Controller 2: OK - Active'. The 'Subsystem Information' section lists the following details:

Alias:	VT17 Edit
Model:	VTrak D5800
WWN:	2000-0001-555e-0f15
Serial Number:	SBB-JBOD-123
Redundancy Status:	Redundant
Redundancy Type:	Active-Active
System Date and Time:	2017-05-17 14:52:38
Vendor:	Promise Technology, Inc.

Viewing Subsystem Information

To view subsystem information, click the **Device** menu tab.

The list of subsystems and host controllers is displayed in **Device Overview**. Subsystem information includes:

- Alias, if assigned
- Model
- WWN – World Wide Name
- Serial number
- Redundancy status
- Redundancy Type
- System date and time
- Time Zone
- Vendor

Restarting the Subsystem

This function shuts down the subsystem and then restarts it.

To restart the subsystem:

1. Click the **Device** tab.
2. Click the **Overview** icon.
3. Click the **Shutdown/Restart Subsystem** button.
4. Choose the **Apply to** option, *Subsystem*, *Controller 1* or *Controller 2*.
5. Click the **Restart** button.
6. Type the word “confirm” in the field provided.
7. Click the **Confirm** button.

When the controller shuts down, your WebPAM PROe connection is lost.

8. Wait at least two minutes.
9. In your browser, click **Logout** in the WebPAM PROe Header, then log in again.

If you cannot log in immediately, wait 30 seconds and try again.

Shutting Down the Subsystem

This function shuts down the RAID subsystem without restarting it.

To shutdown the subsystem:

1. Click the **Device** tab.
2. Click the **Overview** icon.
3. Click the **Shutdown/Restart Subsystem** button.
4. Choose the **Apply to** option, *Subsystem, Controller 1 or Controller 2*.
5. Click the **Shutdown** button.
6. Type the word “**confirm**” in the field provided.
7. Click the **Confirm** button.

When the controller shuts down, your WebPAM PROe connection is lost.



Important

If your RAID subsystem manages JBOD expansion units, you must follow the proper startup procedure.

Restarting the Subsystem after a Shutdown

To start the RAID subsystem:

1. Press the Power button on the front left side of the device being restarted.
2. Wait at least two minutes.
3. Open your browser and log into WebPAM PROe.

If you cannot log in immediately, wait 30 seconds and try again.

Device View

The Device View menus display a real time virtual representation of the device used to check status of the subsystem and its components. Choose the Front View, Back View, and Internal View (click button in Back View menu). Hover the cursor over different components to see a summary of the status for that component.

Device Front View

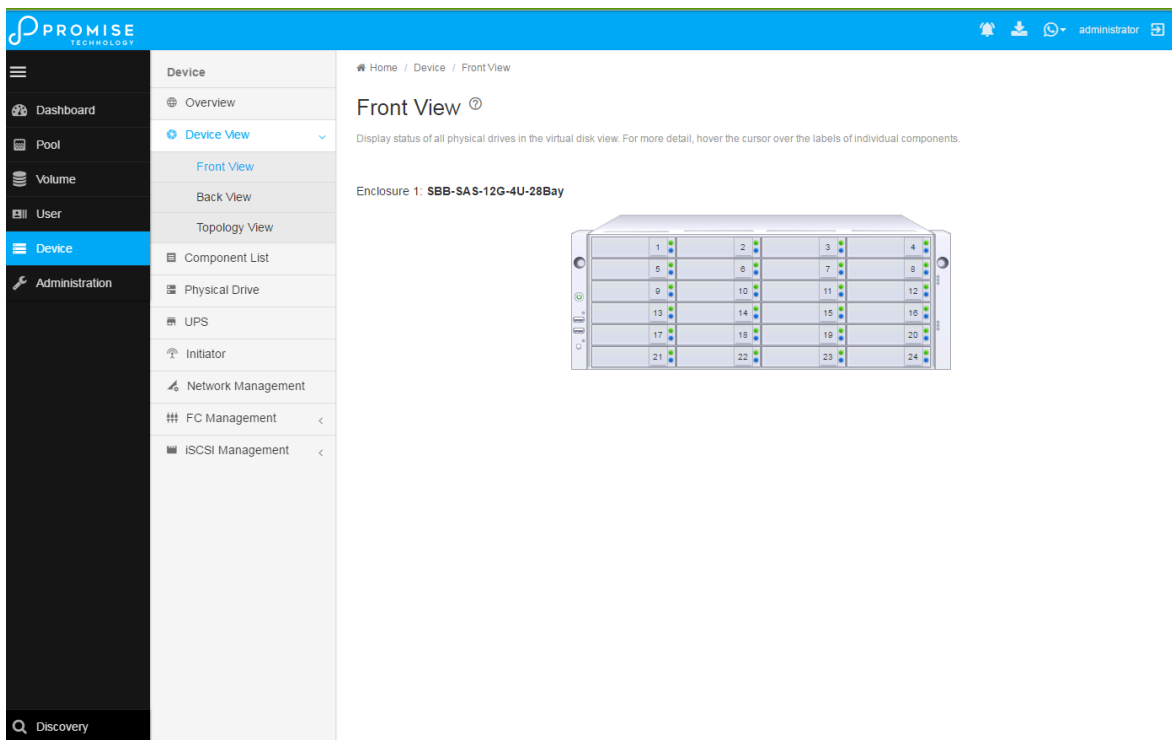

Device Back View

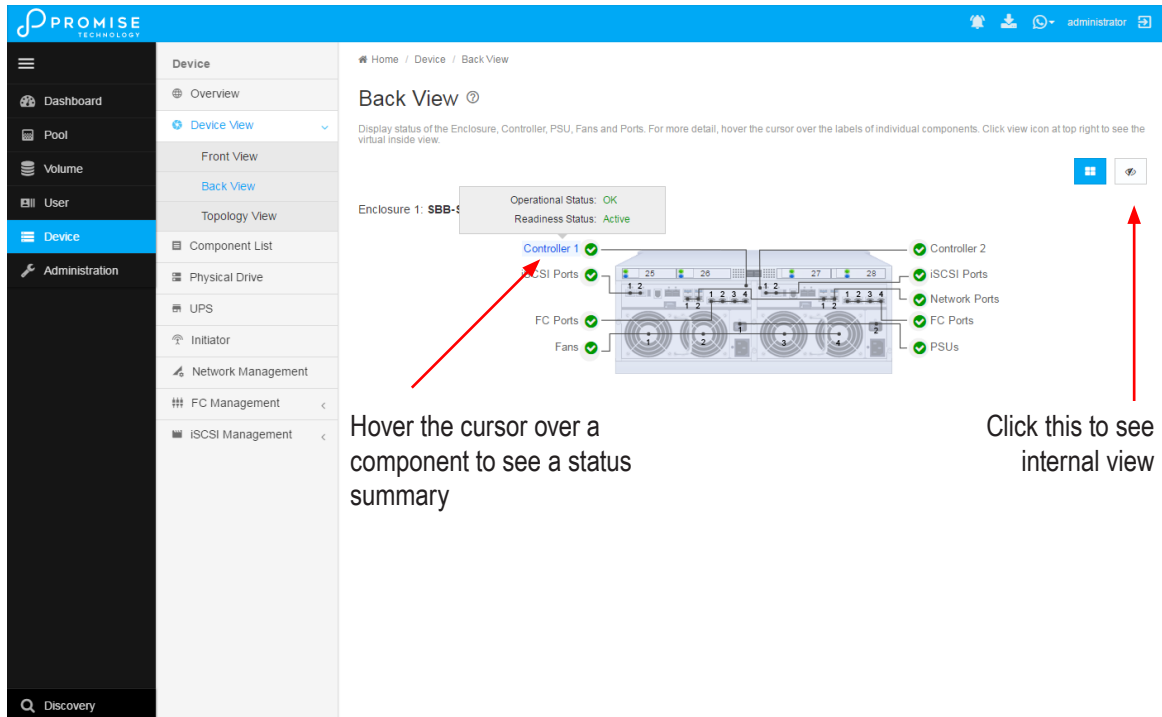

Device Internal View

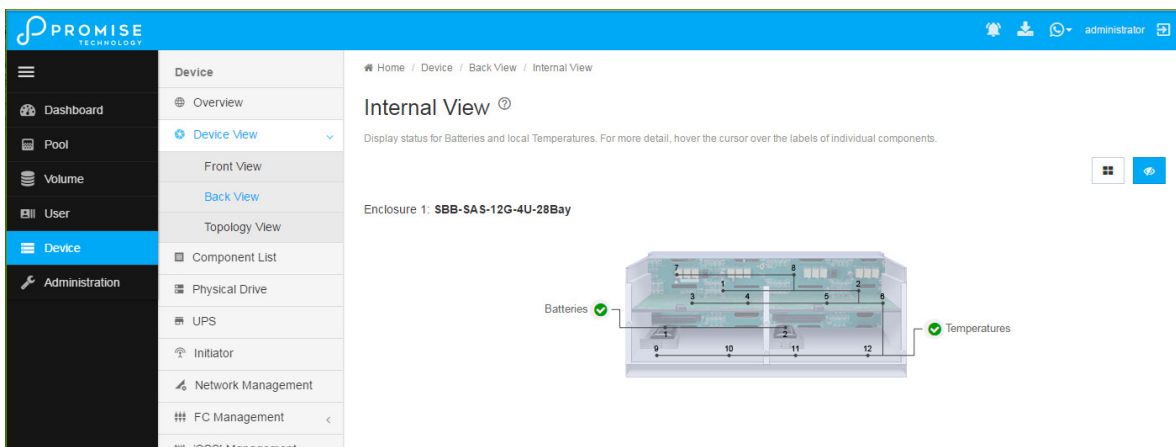

Viewing Enclosure Information

To view enclosure information:

1. Click the **Device** tab.
2. Click the **Component List** icon.
3. Click the Enclosure and select **View** in the gear icon.

Enclosure information includes:

- Enclosure ID
- Enclosure Type
- Operational Status of PSUs
- Operational Status of Fans, including Current Fan Speed and Healthy Threshold
- Temperature Sensors for Controllers, PSUs and Backplane include Location, Status and current Temperature, and Healthy Threshold
- Voltage Sensors for Controllers and PSUs, including Sensor Type, Current Voltage, and Healthy Threshold

Locating an Enclosure

To locate an enclosure:

1. Click the **Device** tab.
2. Click the **Component List** icon.
3. Click the Enclosure you want, then click the **Locate** button.

The enclosure LEDs blink for one minute.

Making Controller Settings

In a dual-controller RAID subsystem, settings made to one controller are applied to both controllers.

To make controller settings:

1. Click the **Device** tab.
2. Click the **Component List** icon.
3. For the controller you want to configure, then click the Gear icon and select the *Settings* option.
4. Make settings changes as required:
 - Enter, change or delete the alias in the **Alias** field.
 - **HDD Power Saving** – Choose time periods from the drop-down menus.
After an HDD has been idle for the set period of time:
 - * **Power Saving Idle Time** – Parks the read/write heads.
 - * **Power Saving Standby Time** – Lowers disk rotation speed.
 - * **Power Saving Stopped Time** – Spins down the disk (stops rotation).
 - **Coercion** – Check the box to enable or uncheck to disable.
 - **Coercion Method** – Choose a method from the drop-down menu:
 - * *GBTruncate*
 - * *10GBTruncate*
 - * *GrpRounding*
 - * *TableRounding*
 - **Write Back Cache Flush Interval** – Enter a value into the field, 1 to 12 seconds.
 - **Enclosure Polling Interval** – Enter a value into the field, 15 to 255 seconds.
 - **Adaptive Writeback Cache** – Check the box to enable or uncheck to disable.
 - **Host Cache Flushing** – Check the box to enable or uncheck to disable.
 - **Forced Read Ahead** (cache) – Check the box to enable or uncheck to disable.
 - **SMART Log** – Check the box to enable or uncheck to disable.
 - **SSD Trim Support** – Check the box to enable or uncheck to disable.
 - **SMART Polling Interval** – Enter a value into the field, 1 to 1440 minutes
 - **Pseudo Device Type** - From the drop-down menu, choose:
 - * *DAS*
 - * *CTRL*
5. Click the **Save** button.

Viewing Controller Information

To view controller information:

1. Click the **Device** tab.
2. Click the **Component List** icon.
3. Click the controller you want, then click the **View** button.

Basic controller information includes:

- Controller ID
- Alias – If assigned
- Readiness Status
- Power On Time
- LUN Mapping method
- Serial Number
- WWN – World Wide Name
- Dirty Cache Usage – Percentage
- Boot Loader Version
- Firmware Version
- Software Version
- Operational Status
- SCSI Protocol Supported
- Part Number
- Hardware Revision
- Cache Usage – Percentage
- Host Cache Flushing
- Boot Loader Build Date
- Firmware Build Date
- Software Build Date

Advanced controller information includes:

- Slot 1 Memory Type
- Slot 2 Memory Type
- Slot 3 Memory Type
- Slot 4 Memory Type
- M.2 Device Present 1
- M.2 Device Present 2
- LUN Affinity
- Controller Role
- Flash Size
- NVRAM Size
- Coercion *
- SMART Log
- Write Back Cache Flush Interval *
- Adaptive Writeback Cache *
- Forced Read Ahead (cache) *
- Power Saving Idle Time *
- Power Saving Stopped Time
- SSD Trim Support:
- Slot 1 Memory Size
- Slot 2 Memory Size
- Slot 3 Memory Size
- Slot 4 Memory Size
- M.2 Device Size 1
- M.2 Device Size 2
- ALUA *
- Flash Type
- NVRAM Type
- Preferred Cache Line Size
- Coercion Method *
- SMART Polling Interval *
- Enclosure Polling Interval *
- Forced Read Ahead
- Power Saving Standby Time
- Cache Line Size
- Pseudo Device Type

Items with an asterisk (*) are adjustable under Controller Settings.

Buzzer Settings

To make buzzer settings:

1. Click the **Device** tab.
2. Click the **Component List** icon.
3. Choose the *Enable Buzzer / Disable Buzzer* option to enable or disable the buzzer.
4. Choose the *Turn on Buzzer / Turn off Buzzer* option to turn the buzzer on or off. Note that while the buzzer is on, the status reads *Sounding*; when the buzzer is off, the status reads *Silent*.



Caution

If you disable the buzzer, it is disabled for all events. To stop the buzzer from sounding, you can use either the Mute Alarm button located on the front of the subsystem hardware, or follow the instructions below.

Silencing the Buzzer

To silence the buzzer, you can press the Mute Alarm button on the front of the VTrak enclosure hardware, located on the left side under the power button and USB ports. Or, click on the virtual Mute Buzzer button at the top of the user interface in WebPAM PROe. *This only appears when the buzzer is sounding.*

Managing Physical Drives

Viewing Physical Drive Information

To view physical drive information:

1. Click the **Device** tab.
2. Click the **Physical Drive** icon. Information for each drive is listed in the menu.

Physical drive information includes:

- Physical Drive ID – ID number of the physical drive
- Operational Status – OK is normal, Stale, PFA, Dead
- Model Number– Make and model of the drive
- Drive Interface Type – SATA or SAS
- Location – Enclosure number and slot number
- Configuration Status – Pool number or spare number
- Physical Capacity – Total capacity in TB

Making Global Physical Drive Settings

To make global physical drive settings:

1. Click the **Device** tab.
2. Click the **Physical Drive** icon.
3. Click the **Global Physical Drive Settings** button.
4. Check the boxes to enable, uncheck to disable.

For **SATA** drives:

- Enable Write Cache
- Enable Read Look Ahead Cache
- DMA Mode (use pull down menu to select option)
- Medium Error Threshold (Default is 64, range is 0-4294967294)

For **SAS** drives:

- Enable Write Cache
 - Enable Read Look Ahead Cache
 - Enable Read Cache
 - Medium Error Threshold
5. Click the **Save** button.

Managing UPS Units

Viewing UPS Information

To view information about a specific UPS unit:

1. Click the **Device** tab.
2. Click the **UPS** icon.

UPS information includes:

- **UPS ID**
- Status
- Model
- **Battery Capacity** – Backup capacity expressed as a percentage.
- **Run Time Remaining**

Making UPS Settings

These settings control how the VTrak D5000 subsystem detects the UPS unit and responds to data reported by the UPS unit.

To make UPS settings:

1. Click the **Device** tab.
2. Click the **UPS** icon.
3. Click the **UPS Settings** button.
4. Perform the following actions as required:
 - Choose a Detection Setting from the drop-down menu:
 - * **Auto** – Default. If a UPS is detected when the subsystem boots, the setting changes to Enable.
 - * **Enable** – Monitors UPS. Reports warnings and logs events.
 - * **Disable** – Does not monitor UPS.
 - Type values into the Threshold fields:
 - * **Running Time Remaining Threshold** – Actual time below this value resets adaptive writeback cache to writethrough. Default is 5 minutes, range is 3-20 minutes.
 - For UPS units with network cards, type the IP addresses or DNS names in fields UPS 1 and UPS 2. *See Note 2.*
5. Press **Submit** to save your settings.

Note 1: VTrak D5000 supports multiple UPS units using network or USB connections, but not a combination of both methods.

Note 2: To specify UPS units by DNS names, ask your IT administrator to add the DNS names to the DNS server, before you make UPS settings. DNS settings must first be configured in **Network Management** using the **Global Settings** menu.

MANAGING INITIATORS

Adding a Fibre Channel or iSCSI Initiator

You must add an initiator to the VTrak D5000's initiator list in order to map your LUN or logical drive to the initiator.

This action requires **Administrator** or **Super User** privileges.

To add a Fibre Channel or iSCSI initiator to the list:

1. Click the **Device** tab.
2. Click the **Initiator** icon.
3. Click the **Add Initiator** button.
4. Choose the network Type (FC or iSCSI)
5. Input the initiator name in the fields provided.

A Fibre Channel initiator name is the World Wide Port Name of the initiator, composed of a series of eight, two-digit hexadecimal numbers. The iSCSI initiator name is composed of a single text string.

6. Click the **Submit** button.

The initiator is added.

Viewing Initiators

The VTrak D5000's initiator list displays initiators available for mapping to a LUN or logical drive. You must add initiators to the VTrak D5000's initiator list to make them available for mapping to a LUN.

To view a list of initiators:

1. Click the **Device** tab.
2. Click the **Initiator** icon.

The list of initiators appears. Initiator information includes:

- **ID** – Initiator 0, Initiator 1, Initiator 2, etc.
- **Type** - Choose *FC* or *iSCSI*

Fibre Channel – WWPN: Enter the World Wide Port Name of the initiator, composed of a series of eight, two-digit hexadecimal numbers.

iSCSI – Name: Enter the iSCSI name of the initiator device, composed of a single text string.

Deleting an Initiator



Caution

If you delete an initiator, you delete the LUN map associated with that initiator. Verify that the LUN map is no longer needed before deleting the initiator

This action requires **Administrator** or **Super User** privileges.

To delete a Fibre Channel initiator:

1. Click the **Device** tab.
2. Click the **Initiator** icon.
3. Click the **trash can** icon on the initiator if you want to delete it.
4. In the Confirmation box, type the word “**confirm**” in the field provided and click the **Confirm** button

The initiator is removed from VTrak D5000's initiator list.

Managing Network Connections

Making Virtual Management Port Settings

The VTrak D5000 subsystem has a virtual management port, enabling you to log into a VTrak D5000 with dual controllers using one IP address.

You initially made these settings during subsystem setup. You can change them later as required.



Caution

Changing virtual management port settings can interrupt your WebPAM PROe connection and require you to log in again.

To make virtual management port settings:

1. Click the **Device** tab.
2. Click the **Network Management** tab.
3. Under **Floating IP**, click on the gear icon and choose the *Modify* option.
4. In the new menu, make the following settings are needed:
 - Check the **Enable DHCP** box to enable a DHCP server to make your network settings. DHCP is currently supported in IPv4 only. Note that you will have the option to enable Auto DNS.
 - For manual network settings, type the RAID subsystem's IP address, subnet mask and gateway IP address into the fields provided.
5. Click the **Save** button.

Making Maintenance Mode Port Settings

The IP settings of management ports are also configured in Network Management.

To make physical management port settings:

1. Click the **Device** tab.
2. Click the **Management Portal** icon.
3. Under **Static IP**, click on the gear icon and choose the *Modify* option.
4. In the new menu, make the following settings are needed:
 - Check the **Enable DHCP** box to enable a DHCP server to make your network settings. DHCP is currently supported in IPv4 only. Note that you will have the option to enable Auto DNS.
 - For manual network settings, type the RAID subsystem's IP address, subnet mask and gateway IP address into the fields provided.
 - You can choose to **Enable Physical IP**.
5. Click the **Save** button.

Managing Fibre Channel Connections

Viewing Fibre Channel Node Information

To view Fibre Channel node information:

1. Click the **Device** tab.
2. Click the **FC Management** tab.
3. Click the **Node** tab.

Node information includes:

- **Worldwide Node Name (WWNN)**
- **Maximum Frame Size**
- **Supported Fibre Channel Class**
- **Supported Speed**

Viewing Fibre Channel Port Information

To view Fibre Channel port information:

1. Click the **Device** tab.
2. Click the **FC Management** tab.
3. Click the **Port** tab.
4. Click the gear icon in the list of FC ports and select the *View* option.

Port information includes:

- **Controller ID**
- **Link Status**
- **Topology**
- **Alias WWNN - World Wide Node Name**
- **Fabric WWPN**
- **Current Speed**
- **Configured Link Speed**
- **Hard ALPA**
- **Port ID:**
- **Identifier - (hexadecimal)**
- **WWPN - Worldwide Port Name**
- **Number Of Current Aliases**
- **Fabric WWNN**
- **Link Type**
- **Configured Topology**

Making Fibre Channel Port Settings

To make Fibre Channel port settings:

1. Click the **Device** tab.
2. Click the **FC Management** tab.
3. Click the **Port** tab.
4. Click the gear icon in the list of FC ports and select the *Modify* option.
5. Make these changes as required:
 - Choose a configured link speed from the drop-down menu. The choices are Auto (default), 4 Gb/s, 8 Gb/s and 16 Gb/s.
 - Choose a topology from the drop-down menu.
 - Enter a Hard ALPA in the field provided. Enter 255 to disable Hard ALPA.
6. Click the **Save** button.

Port Setting Information

The examples below show the type of attached topology you achieve based on your connection type and the configured topology you select.

Example 1: If you connect the VTrak D5000 to a Fibre Channel switch and choose NL-Port topology, you create a Public Loop attached topology.

Example 2: If you have a Point-to-Point attached topology, you made a direct connection (no Fibre Channel switch) and selected N-port topology.



Note

In some cases, HBA settings to N-Port only work if connected to the switch. Refer to your HBA manual for more information.

Viewing Fibre Channel Port Statistics

To view Fibre Channel port statistics:

1. Click the **Device** tab.
2. Click the **FC Management** tab.
3. Click the **Statistics** tab.
4. Click the gear icon in the list of FC ports and select the *View* option.

Viewing Fibre Channel Logged-in Devices

Logged-in devices refers to all Fibre Channel devices currently logged into the VTrak D5000. The device list includes:

- **Fibre Channel ports**
- **Fibre Channel switches, if attached**
- **Fibre Channel initiators**

To view a list Fibre Channel logged-in devices:

1. Click the **Device** tab.
2. Click the **Fibre Channel Management** icon.
3. Click the **Logged In Device** tab.

To add a Fibre Channel initiator in the list, select it and click on the **Add to Initiator List** button. This is the method described in “Adding a Fibre Channel or iSCSI Initiator” on page 93.

Viewing Fibre Channel Initiators on the Fabric

To view a list Fibre Channel initiators on the fabric:

1. Click the **Device** tab.
2. Click the **FC Management** tab.
3. Click the **Device on Fabric** tab.

Also see “Viewing Initiators” on page 94.

To add a Fibre Channel initiator in the list, select it and click on the **Add to Initiator List** button. See “Adding a Fibre Channel or iSCSI Initiator” on page 93.

Viewing Fibre Channel SFPs

The term SFP refers to Small Form Pluggable transceivers used in Fibre Channel ports. The SFPs convert electrical signals to optical signals and send them over the Fibre Channel fabric, where another transceiver converts the optical signal back to an electrical signal again.

To view a list Fibre Channel SFPs:

1. Click the **Device** tab.
2. Click the **Fibre Channel Management** icon.
3. Click the **SFP** tab.

SFP information includes:

- **Controller ID**
- **FC Port ID**
- **Connector type**
- **Transceiver type**
- **Transceiver code**
- **Vendor name**

MANAGING iSCSI CONNECTIONS

Viewing iSCSI Target Information

To view information about the iSCSI target:

1. Click the **Device** tab.
2. Click the **iSCSI Management** icon.
3. Click the **Target** tab. (Note that you need to click *Expand Detail Information* to view the entire list)

Target information includes:

- **ID** – ID number of the target.
- **Status** – Up or down.
- **Name** – iSCSI qualified name (iqn) of this target.
- **Alias** – Maximum of 32 characters. Use letters, numbers, space between words, and underscore. An alias is optional.*
- **Error Recovery Level** – Error recovery level supported.
- **Initial R2T** – Allows initiator to begin sending data to a target without receiving a ready to transfer command.
- **Max Outstanding R2T** – Maximum number of R2T PDUs the target can have outstanding for a single iSCSI command.
- **Max Burst Length** – Maximum length of a solicited data sequence in bytes.
- **Data Digest** – Adds a data digest (CRC).*
- **Header Digest** – Enables the use of header digest (CRC).*
- **Data PDU in Order** – Enables placement of data in PDU order
- **Data Sequence in Order** – Enables placement of data in sequence order
- **Default Time to Wait** – After a dropped connection, the number of seconds to wait before attempting to reconnect
- **Default Time to Retain** – Number of seconds after time to wait (above) before reassigning outstanding commands
- **Uni-directional CHAP Authentication** – Uni-directional (peer) CHAP authentication, enabled or disabled*
- **Bi-directional CHAP Authentication** – Bi-directional (local) CHAP authentication, enabled or disabled*
- **Maximum Connections** – The maximum number of concurrent connections
- **Immediate Data** – Enables the initiator to send unsolicited data with the iSCSI command PDU.
- **First Burst Length** – In bytes.
- **Assigned Portal IDs**
- **Keep Alive** - Enable or Disable

Making iSCSI Target Settings

To make target settings:

1. Click the **Device** tab.
2. Click the **iSCSI Management** icon.
3. Click the **Target** tab.
4. Click the target you want, then click the **Modify** button.
5. Make settings changes are required:
 - **Alias**
 - **Enable/Disable Keep Alive**
 - **Enable/Disable Header Digest**
 - **Enable Data Digest**
 - **Enable Bi-directional CHAP Authentication**
 - **Enable Uni-directional CHAP Authentication**
6. Click the **Save** button.

Viewing a List of iSCSI Sessions

To view a list of iSCSI sessions:

1. Click the **Device** tab.
2. Click the **iSCSI Management** icon.
3. Click the **Session** tab.

iSCSI session information includes:

- **ID** – ID number of the session
- **Controller ID** - Controller 1 or 2
- **Target Alias** – Alias of the target
- **Initiator Alias** – Part of the IQN
- **Portal ID** – ID number of the portal
- **Portal IP** - IP address of the portal
- **Status** – Active or inactive.

Viewing iSCSI Session Information

To view a list of iSCSI sessions:

1. Click the **Device** tab.
2. Click the **iSCSI Management** icon.
3. Click the **Session** tab.
4. Click the **View** button.

Deleting an iSCSI Session

To delete an iSCSI session:

1. Click the Device tab.
2. Click the **iSCSI Management** icon.
3. Click the **Session** tab.
4. Click the iSCSI session you want and click the **Delete** button.
5. Type “**confirm**” in the field provided, then click the **Confirm** button.

Viewing iSCSI iSNS Information

To view information about iSNS:

1. Click the **Device** tab.
2. Click the **iSCSI Management** icon.
3. Click the **iSNS** tab.

The information includes:

- **IO Portal ID**
- **Type**
- **Controller**
- **Status**
- **Server IP**
- **Server Port**

Making iSCSI iSNS Settings

To make iSNS settings:

1. Click the **Device** tab.
2. Click the **iSCSI Management** icon.
3. Click the **iSNS** tab.
4. Click on a portal to select it.
5. Click the **Modify** button.
6. Make settings changes are required:
 - **Enable** (check to enable)
 - **Server Port** (1-65535)
 - **Server IP**
 - **IO Portal ID**
7. Click the **Submit** button.

Viewing a List of iSCSI CHAPs

To view a list of iSCSI CHAPs:

1. Click the **Device** tab.
2. Click the **iSCSI Management** icon.
3. Click the **CHAP** tab.

CHAP information includes:

- **ID** – ID number of the CHAP
- **Type** – Peer or local
Peer is one-way or uni-directional.
Local is two-way or bi-directional.
- **Name** – User assigned name of the CHAP

Adding iSCSI CHAPs

To add an iSCSI CHAP:

1. Click the **Device** tab.
2. Click the **iSCSI Management** icon.
3. Click the **CHAP** tab.
4. Click the **Create CHAP** button.
5. Make your choices and inputs as required:
 - **Enter** a name in the Name field.
 - **Choose a CHAP type.**
Peer is one-way or uni-directional.
Local is two-way or bi-directional.
 - **Enter** a secret of 12 to 16 characters in the Secret field.
 - **Enter** the secret again in the Retype Secret field.
6. Click the **Submit** button.

The new CHAP is added to the list.

Deleting iSCSI CHAPs

To delete an iSCSI CHAP:

1. Click the **Device** tab.
2. Click the **iSCSI Management** icon.
3. Click the **CHAP** tab.
4. Click the CHAP you want, then click the **Delete** button.
5. Type "CONFIRM" into the popup menu and click the **Confirm** button.

The CHAP is removed from the list.

Making iSCSI CHAP Settings

When you change CHAP settings, you must change the secret. You cannot change the type (peer or local).

To make iSCSI CHAP settings:

1. Click the **Device** tab.
2. Click the **iSCSI Management** icon.
3. Click the **CHAP** tab.
4. Click the CHAP you want, then click the **Modify** button.
5. Make settings changes are required:
 - **Enter** a name in the **Name** field.
 - **Enter** the current secret in the **Current Secret** field.
 - **Enter** a new secret of 12 to 16 characters in the **Secret** field.
 - **Enter** the new secret again in the **Retype Secret** field.
6. Click the **Save** button.

Viewing a List of Logged-in Devices

Logged-in devices refers to all iSCSI devices currently logged into the VTrak D5000. The device list includes:

To view a list of logged-in devices:

1. Click the **Device** tab.
2. Click the **iSCSI Management** icon.
3. Click the **Logged In Device** tab.

USING THE EVENT VIEWER

The Event Viewer displays log of subsystem events. Events are classified as:

- Runtime Events – A list of and information of up to about 300,000 of the most recent runtime events recorded since the subsystem was started.

Event Severity Levels	
Level	Description
Fatal	Non-recoverable error or failure has occurred.
Critical	Action is needed now and the implications of the condition are serious.
Major	Action is needed now.
Minor	Action is needed but the condition is not a serious at this time.
Warning	User can decide whether or not action is required.
Information	Information only, no action is required.

Viewing Events

To display Events:

1. Click the **Administration** tab.
2. Click the **Events** icon.

The log of Events appears. Events are added to the top of the list. Each item includes:

- **Index number** – Begins with 0 at system startup.
 - **Device** – Disk Array, Logical Drive, Physical Drive by its ID number.
 - **Event ID** – Hexadecimal code for the specific event
 - **Severity** – see table on previous page
 - **Time** – Date and time the event happened.
 - **Description** – A description of the event in plain language.
3. Press the up and down arrow keys to scroll through the log. Choose the page size and event log page you want to view.

Saving Events

This feature saves a plain text file of runtime events to your host PC or server using your browser.

To save the Events log:

1. Click the **Administration** tab.
2. Click the **Events** icon.
3. Click the **Save** button.
4. Follow your browser's procedure to save the event file to the desired location.

Clearing Events

To clear the Events log:

1. Click the **Administration** tab.
2. Click the **Events** icon.
3. Click the **Clear** button.
4. In the Confirmation box, type the word "**confirm**" in the field provided and click the Confirm button.

MANAGING USERS

Viewing User Information

To view user information:

1. Click the **Administration** tab.
2. Click the **Management User** tab.

The list of users displays. User information includes:

- User name
- Display Name
- Privilege level
- Email address
- Status

Creating a User

This action requires **Administrator** or **Super User** privileges.

To create a user:

1. Click the **Administration** tab.
2. Click the **Management User** tab.
3. Click the **Add New User** button.
4. In the **Add User** dialog box, enter the information in the fields provided:
 - Name – This is the user's login name
 - Display Name
 - Password
 - Retype Password
 - User Email – Required for event notification
 - Enable this user - Check box to enable the user. Click to remove check to disable.
 - Privilege - Use pull down menu to select *View*, *Maintenance*, *Power*, or *Super* user level. See the table below for a description of the privilege types.
5. Click the **Submit** button. The user is added to the list.

User Privileges	
Level	Meaning
View	Allows the user to See all status and settings but not to make any changes
Maintenance	Allows the user to perform maintenance tasks including Rebuilding, PDM, Media Patrol, and Redundancy Check
Power	Allows the user to create (but not delete) disk arrays and logical drives, change RAID levels, change stripe size; change settings of components such as disk arrays, logical drives, physical drives, and the controller
Super	Allows the user full access to all functions including create and delete users and changing the settings of other users, and delete disk arrays and logical drives. The default “administrator” account is a Super User

Making User Settings

This action requires **Administrator** or a **Super User** privileges.

To make user settings:

1. Click the **Administration** tab.
2. Click the **Management User** tab.
3. In the User list, click the user you want, then click the gear icon and select the *Modify* option.
4. Make settings changes as required:
 - For the **Enable** box, check to enable this user account, uncheck to disable this user account
 - In the User Settings dialog box, enter a new **Display Name** or **User Email** address
 - Choose a new **Privilege** level from the drop-down menu. See the table on the next page.
5. Click the **Save** button.

Changing User Passwords

This action requires **Administrator** or **Super User** privileges.

To change a user's password:

1. Click the **Administration** tab.
2. Click the **User Management** icon.
3. In the User list, click the user you want, then click **Change Password**.
4. In the Change Password dialog box, enter the information in the fields provided:
 - New Password
 - Retype Password
5. Click the **Save** button.

Deleting a User

This action requires **Administrator** or **Super User** privileges

To delete a user:

1. Click the **Administration** tab.
2. Click the **User Management** icon.
3. In the User list, click the user you want, then click the **Delete** button.
4. In the **Confirmation** box, type the word “**confirm**” in the field provided and click the **Confirm** button.

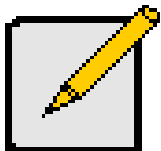

Note

The Administrator account cannot be deleted.

Setting User Event Subscriptions

By default, all users have event notification:

- Enabled
- Set to the Major (severity) level for all events

Subscribing users receive notification of events at the chosen severity level and all higher levels.

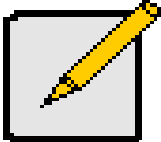

Note

Each user must have a valid Email address to receive events.

Changing a user subscription requires **Administrator** or **Super User** privileges.

To set a user event subscription:

1. Click the **Administration** tab.
2. Click the **Management User** tab.
3. In the User list, click the user you want, then click the **Subscription** button.
4. Make settings changes as required:
 - For the **Enable Event Notification** box, check to enable for this user, uncheck to disable.
 - Click to change the priority options for each category of event.
5. Click the **Save** button.

Viewing Services

This feature displays all software services running on the RAID subsystem.

To view the list of software services:

1. Click the **Administration** tab.
2. Click the **Service** icon.

The Services list displays the Status and Start Type of the services available. These services are described in the sections that follow. To view the actions available for the various services in the list, click the gear icon for the respective service.

Email Service

Email service enables the RAID subsystem to send you Email messages about events and status changes. By default, Email service is set to Automatic.

Stopping Email Service

To stop the Email service:

1. Click the **Administration** tab.
2. Click the **Service** icon.
3. Click the gear icon for Email service and select the *Stop* option.
4. Click the **Confirm** button.

To start the Email service after stopping it:

1. Click the **Administration** tab.
2. Click the **Services** icon.
3. Click the gear icon for Email service and select the *Start* option.

Restarting Email Service

To restart the Email service:

1. Click the **Administration** tab.
2. Click the **Service** icon.
3. Click the gear icon for Email service and select the *Restart* option.

Making Email Settings

To change Email service settings:

1. Click the **Administration** tab.
2. Click the **Service** icon.
3. Click the gear icon for Email service and select the *Settings* option.
4. Make settings changes as required:
 - Choose a startup type,
 - * Automatic – (default) Starts and runs with the subsystem.
 - * Manual – You start the service when you need it.
 - SMTP Server IP address
 - SMTP Server Port
 - SMTP Authentication – Choose the *Yes* radio button to enable authentication or the *No* radio button to disable authentication.
 - Authentication Username – Required if SMTP authentication is enabled.
 - Authentication Password – Required if SMTP authentication is enabled.
 - Sender (From) Address – The sender's name shown on notification messages.
 - Email Subject – The subject line of the notification message.
5. To enable SSL for the connection to the Email server, check the **Enable SSL** box.
6. To send a test email, one time, check the **Send a Test Email** box.
7. Click the **Save** button.
8. Type "CONFIRM" in the popup menu and click the **Confirm** button.



Note

To verify your settings, send a test message.

SLP Service

Service Location Protocol (SLP) discovers services over the Internet. SLP applies to IPv4 protocol only.

Stopping SLP Service

To stop the SLP service:

1. Click the **Administration** tab.
2. Click the **Service** icon.
3. Click the gear icon for SLP service and select the *Stop* option.
4. Type "CONFIRM" in the popup menu and click the **Confirm** button.

To start the SLP service after stopping it:

1. Click the **Administration** tab.
2. Click the **Services** icon.
3. Click the gear icon for SLP service and choose the *Start* option.

Restarting SLP Service

To restart the SLP service:

1. Click the **Administration** tab.
2. Click the **Service** icon.
3. Click the gear icon for SLP service and select the *Restart* option.
4. Type "CONFIRM" in the popup menu and click the **Confirm** button.

Making SLP Settings

To change SLP service settings:

1. Click the **Administration** tab.
2. Click the **Service** icon.
3. Click the gear icon for SLP service and select the *Settings* option.
4. Choose a startup type:
 - Automatic – (default) Starts and runs with the subsystem.
 - Manual – You start the service when you need it.
5. Click the **Save** button.
6. Type “CONFIRM” in the popup menu and click the **Confirm** button.

Webserver Service

Webserver service connects the WebPAM PROe interface to the RAID subsystem through your browser.

Stopping Webserver Service

To stop the Webserver service:

1. Click the **Administration** tab.
2. Click the **Service** icon.
3. Click the gear icon for Webserver service and select the *Stop* option.
4. Type “CONFIRM” in the popup menu and click the **Confirm** button.

To start the Webserver service after stopping it:

1. Click the **Administration** tab.
2. Click the Services icon.
3. Click the Webserver service and click the **Start** button.
4. Type “CONFIRM” in the popup menu and click the **Confirm** button.

Restarting Webserver Service

1. Click the **Administration** tab.
2. Click the **Service** icon.
3. Click the gear icon for SLP service and select the *Restart* option.
4. Type “CONFIRM” in the popup menu and click the **Confirm** button.

Making Webserver Settings

To change Webserver service settings:

1. Click the **Administration** tab.
2. Click the **Service** icon.
3. Click the gear icon for SLP service and select the *Settings* option.
4. Make settings changes as required:
 - Choose a startup type,
 - * Automatic – (default) Starts and runs with the subsystem.
 - * Manual – You start the service when you need it.
 - Session Time Out – Default is 24 minutes.
5. Click the **Save** button.
6. Type “CONFIRM” in the popup menu and click the **Confirm** button.

SSH Service

Secure Shell (SSH) service enables you to access the subsystem's Command Line Interface (CLI) through a network connection.

Stopping SSH Service

To stop SSH service:

1. Click the **Administration** tab.
2. Click the **Service** icon.
3. Click the gear icon for SSH service and select the *Stop* option.
4. Type "CONFIRM" in the popup menu and click the **Confirm** button.

To start SSH service after stopping it:

1. Click the **Administration** tab.
2. Click the **Services** icon.
3. Click the gear icon for SSH service and select the *Start* option.
4. Type "CONFIRM" in the popup menu and click the **Confirm** button.

Restarting SSH Service

To restart SSH service:

1. Click the **Administration** tab.
2. Click the **Service** icon.
3. Click the gear icon for SSH service and select the *Restart* option.
4. Type "CONFIRM" in the popup menu and click the **Confirm** button.

Making SSH Settings

To change SSH service settings:

1. Click the **Administration** tab.
2. Click the **Service** icon.
3. Click the gear icon for SSH service and select the *Settings* option.
4. In the SSH Settings tab, make settings changes as required:
 - Choose a startup type,
 - * Automatic – (default) Starts and runs with the subsystem.
 - * Manual – You start the service when you need it.
 - Port number - Default is 22.
 - Max Number of Concurrent Connections – Default is 4. Maximum number is 4.
 - Session Time Out - Default is 24 minutes.
5. Click the **Save** button.
6. Type “CONFIRM” in the popup menu and click the **Confirm** button.

SSH Public Key Management

To change SSH service settings:

1. Click the **Administration** tab.
2. Click the **Service** icon.
3. Click the gear icon for SSH service and select the *SSH Public Key Management* option.
4. In the SSH Public Key Management menu, make settings changes as required:
 - Click the **Choose File** button and locate the file with the SSH Public Key
 - Enter a comment
 - Enter TFTP IP and file path information
5. Click the **Upload** button.

MANAGING BACKGROUND ACTIVITIES

Background activities perform a variety of preventive and remedial functions on your physical drives, disk arrays, logical drives, and other components.

You can run a background activity immediately or schedule it to run at a later time. Scheduling options are described below.

Setting options for each activity are listed after the scheduling options. These settings determine how the background activity affects I/O performance.

View Current Background Activities

To view a list of current background activities:

1. Click the **Administration** tab.
2. Click the **Background Activities** tab.

The list of background appears.

Currently running activities show a progress bar.

View Scheduled Background Activities

To view a list of scheduled background activities:

1. Click the **Administration** tab.
2. Click the **Background Activities** tab.

The list of background appears.

3. Click the **Scheduler** button.

The list of currently scheduled background activities appears.

Add a Scheduled Background Activity

To add a new scheduled background activity:

1. Click the **Administration** tab.

2. Click the **Background Activities** tab.

The list of background appears.

3. Click the **Background Activity Scheduler** button.

The list of currently scheduled background activities appears.

4. Click the **Add Schedule** button.

5. In the new menu, choose the option (radio button) for the activity you want:

- Redundancy Check
- Spare Check

6. Check the box to **Enable This Scheduler** if you want to make the schedule active. (Remove check if you want to disable.)

7. Choose a **Start Time** from the drop-down menus.

The menus have a 24-hour clock.

8. Choose a **Recurrence Pattern** option, daily, weekly, or monthly.

- For the Daily option, enter an interval in the Every field.
- For the Weekly option, enter an interval in the Every field and choose one or more days of the week.
- For the Monthly option, choose, Day of the Month option then choose a number from the drop-down menu.
The day of the week option then choose the day of the month from the drop-down menus.

9. Choose a **Start From** date from the drop-down menus.

10. Choose an **End On** option,

- No end date or perpetual.
- End after a specific number of activity actions.
- Until date from the drop-down menus.

11. For **Redundancy Check**, choose,
 - **Auto Fix** option – Attempts to repair the problem when it finds an error. Check to enable
 - **Pause on Error** option – The process stops when it finds a non-repairable error. Check to enable
 - **Select LD** – Check the boxes for the logical drives to run Redundancy Check. Check at least one logical drive
12. Click the **Submit** button.

Change a Background Activity Schedule

To change an existing scheduled background activity:

1. Click the **Administration** tab.
2. Click the **Background Activities** tab.

The list of background appears.
3. Click the **Scheduler** button.

The list of currently scheduled background activities appears.
4. Click the background activity and click the **Settings** button.
5. Make settings changes as required:
 - Choose a **Start Time** from the drop-down menus.

The menus have a 24-hour clock.
 - Choose a **Recurrence Pattern** option, daily, weekly, or monthly.

For the Daily option, enter an interval in the Every field.
For the Weekly option, enter an interval in the Every field and choose one or more days of the week.
For the Monthly option, choose the Day of the Month option or the day of the week option, and choose the day from the drop-down menu.
 - Choose a **Start From** date from the drop-down menus.
 - Choose an **End On** option,

No end date or perpetual.
End after a specific number of activity actions.
Until date from the drop-down menus.
 - For **Redundancy Check**, choose,
 - Auto Fix** option – Attempts to repair the problem when it finds an error. Check to enable
 - Pause on Error** option – The process stops when it finds a non-repairable error. Check to enable
 - Select LD** – Check the boxes for the logical drives to run Redundancy Check. Check at least one logical drive
6. Click the **Save** button.

Enable/Disable Scheduled Background Activity

Background activity schedules are enabled by default when you create the schedule. If you want to stop a background activity now but plan to use it again in the future, disable the scheduled activity rather than deleting it.

To enable or disable change an existing scheduled background activity:

1. Click the **Administration** tab.
2. Click the **Background Activities** tab.
The list of background appears.
3. Click the **Scheduler** button.
The list of currently scheduled background activities appears.
4. Click the background activity and click the **Settings** button.
5. Uncheck the **Enable This Schedule** box to disable this schedule.
Check the box to enable this schedule.
6. Click the **Save** button.

Delete a Scheduled Background Activity

To change an existing scheduled background activity:

1. Click the **Administration** tab.
2. Click the **Background Activities** tab.
The list of background appears.
3. Click the **Scheduler** button.
The list of currently scheduled background activities appears.
4. Click the background activity and click the **Delete** button.
5. In the confirmation box, click the confirm button.

Media Patrol

Media Patrol is a routine maintenance procedure that checks the magnetic media on each disk drive. Media Patrol checks are enabled by default on all disk arrays and spare drives. Media Patrol is concerned with the media itself, not the data recorded on the media. If Media Patrol encounters a critical error, it triggers a PDM if PDM is enabled on the disk array.

Starting, Stopping, Pausing and Resuming Media Patrol

To make Media Patrol settings:

1. Click the **Administration** tab.
2. Click the **Background Activities** tab.

The list of background appears.

3. To begin Media Patrol, click the **Start** button. To Pause a running Media Patrol, click on the Gear icon and select *Pause*; click *Resume* to continue the Media Patrol. To Stop a running Media Patrol, click on the Gear icon, select *Stop*. Stopping Media Patrol requires confirmation by typing “Confirm” in the Confirmation pop up menu and clicking on the **Confirm** button.

Media Patrol actions menu

Background Activity [?]

Display current background activity status,start/stop/pause/resume background activities.

Background Activity Scheduler

<input checked="" type="checkbox"/> Media Patrol	Media Patrol is running. Last Media Patrol Start Time : 2018-09-21 15:49:55 Last Media Patrol Stop Time : 2018-09-20 18:40:30	Start		
PD ID	Status	Completed PD IDs	Queue PD IDs	
1	Paused Current 0%, Over All 0%	2,3,4,5,6,7,8,9,10,11,12,13,14,15,16,17,18,19,20,20,30,31,32,33,34,35,36,37,38,39,40		⚙️
<input checked="" type="checkbox"/> Redundancy Check	Redundancy Check is running.			
Pool ID	Pool Name	Status		

Resume
Stop

Redundancy Check

Redundancy Check is a routine maintenance procedure for fault-tolerant disk arrays (those with redundancy) that ensures all the data matches exactly. Redundancy Check can also correct inconsistencies.

Starting, Stopping, Pausing and Resuming Redundancy Check

To make Redundancy Check settings:

1. Click the **Administration** tab.
2. Click the **Background Activities** tab.

The list of background activities appears.

3. Use the check boxes to select the pools to run Redundancy Checks. Note that you can also enable/disable **Auto Fix** and **Pause on Error** for each pool.
4. To begin Redundancy Check on existing pools, click the **Start** button. To Pause a Redundancy Check for a pool, click on the Gear icon for the pool and select *Pause*; click *Resume* to continue the Redundancy Check. To Stop a running Redundancy Check, click on the Gear icon, select *Stop*. Stopping Redundancy Check requires confirmation by typing “Confirm” in the Confirmation pop up menu and clicking on the **Confirm** button.

Redundancy Check actions menu

Redundancy Check		Redundancy Check is running.		Start
Pool ID	Pool Name	Status		
1	R1_c2(RAID1)	<div style="width: 54%; background-color: #007bff; height: 10px;"></div> Running 54%		
2	R5_c1(RAID5)	<div style="width: 32%; background-color: #007bff; height: 10px;"></div> Running 32%		Pause
3	R6_c2(RAID6)	<div style="width: 36%; background-color: #007bff; height: 10px;"></div> Running 36%		Stop
4	R10_c1(RAID10)	<div style="width: 69%; background-color: #007bff; height: 10px;"></div> Running 69%		
5	R50_c2(RAID50)	<div style="width: 38%; background-color: #007bff; height: 10px;"></div> Running 38%		
6	R60_c1(RAID60)	<div style="width: 31%; background-color: #007bff; height: 10px;"></div> Running 31%		
8	R1_c1(RAID1)	<div style="width: 69%; background-color: #007bff; height: 10px;"></div> Running 69%		

Rebuild

When you rebuild a disk array, you are actually rebuilding the data on one physical drive.

- When a physical drive in a disk array fails and a spare drive of adequate capacity is available, the disk array begins to rebuild automatically using the spare drive.
- If there is no spare drive of adequate capacity, but the Auto Rebuild function is ENABLED, the disk array begins to rebuild automatically as soon as you remove the failed physical drive and install an unconfigured physical drive in the same slot. See “Making Rebuild Settings” below.
- If there is no spare drive of adequate capacity and the Auto Rebuild function is DISABLED, you must replace the failed drive with an unconfigured physical drive, then perform a **Manual Rebuild**.

Starting a Rebuild

Rebuilding a disk pool is only available if the status of a pool has been determined to be degraded or critical.

1. Click the **Administration** tab.
2. Click the **Background Activities** icon.
The list of background activities appears.
3. Choose the options in the Rebuild menu, including the Source Physical Drive and Target Physical Drive from the respective pull down menus.
4. Click the **Submit** button to begin the rebuild. A rebuild requires confirmation by typing “Confirm” in the Confirmation pop up menu and clicking on the **Confirm** button.

Restore Factory Default Settings

This feature restores settings to their default values.



Caution

Use this feature only when required and only on the settings that you must reset to default in order to set them correctly.

To restore all settings to their default values:

1. Click the **Administration** tab.
2. Click **Restore Factory Default**.
3. In the Restore factory default settings screen, check the boxes beside the settings you want to reset to default value (see **Factory Default Settings (by type)** table below). Note that you have the option to select all firmware or all software settings to factory default, or choose each setting to reset individually for both categories.
4. Click the **Submit** button.
5. In the Confirmation box, type the word “confirm” in the field provided and click the **Confirm** button.



Caution

If you apply Restore Factory Default settings to the Management Network Settings, you might lose your WebPam Pro connection.

Factory Default Settings (by type)

Firmware Settings

- Background Activities Settings
- Controller Settings
- Enclosure Settings
- FC Settings
- iSCSI Settings
- Management Network Settings
- Physical Drive Settings
- Subsystem Settings

Software Settings

- BGA Scheduler Settings
- Service Settings
- Web Server Settings
- SNMP Settings
- SSH Settings
- Email Settings
- NTP Settings
- User Settings
- UPS Settings
- Syslog Settings
- Time Zone Settings
- NAS Settings

Export User Database

You can save the user information and settings from one VTrak D5000 RAID subsystem, export it, and then import it to automatically configure your other VTrak D5000 RAID subsystems.

To export a user database:

1. Click the **Administration** tab.
2. Click the **Import/Export** tab.
3. Click the **Export** option.
4. Choose **User Database** radio button in the **Type** menu.
5. Click the **Submit** button.



Note

The user database file is not designed to be opened or edited in the field. The User.dat file is downloaded to the default download folder.

Export Service Report

You can save a service report from a VTrak D5000 RAID subsystem.

To export a Service Report:

1. Click the **Administration** tab.
2. Click the **Import/Export** tab.
3. Click the **Export** option.
4. Choose **Service Report** radio button in the **Type** menu.
5. Click the **Submit** button.

Export Configuration Script, NAS Configuration, NAS Account

You can save a system report from a VTrak D5000 RAID subsystem.

To export a user database:

1. Click the **Administration** tab.
2. Click the **Import/Export** tab.
3. Click the **Export** option.
4. Choose **the** radio button (Configuration Script, NAS Configuration or NAS Account) in the **Type** menu.
5. Click the **Submit** button.

Import User Database

You can save the user information and settings from one VTrak E5000 RAID subsystem, export it, and then import it to automatically configure your other VTrak E5000 RAID subsystems.



Caution

Importing a user database overwrites the current users and user settings on your VTrak E5000 subsystem.

To import a user database:

1. Click the **Administration** tab.
2. Click the **Import/Export** icon.
3. Click the **Import** option.
4. Choose **User Database** radio button from the **Type** menu.
5. Click the **Upload** button and navigate to the user database file and click the **OK** button.
6. Click the **Next** button.

The system verifies that the file is a valid user database and displays any errors or warnings.

7. Click the **Submit** button to continue.
8. In the **Confirmation** box, type the word “**confirm**” in the field provided and click the Confirm button.

The user database is imported and applied automatically.

Import Configuration Script, NAS Configuration, NAS Account

You can save a settings script for system configuration, NAS configuration or NAS account settings and use it to automatically configure your VTrak E5000 subsystem. The script must be a plain, non-encrypted text file. From there, you can import the script from the Host PC and perform the configuration automatically.



Cautions

Do NOT attempt to write or modify a configuration script until you receive guidance from Technical Support.

Importing a settings script overwrites the current settings on your VTrak D5000 subsystem.

Or you can save the configuration from one VTrak E5000 RAID subsystem, export it, and then import it to automatically configure your other VTrak E5000 RAID subsystems. To import a configuration script:

1. Click the **Administration** tab.
2. Click the **Import/Export** icon.
3. Click the **Import** option.
4. Choose radio button (Configuration Script, NAS Configuration or NAS Account) in the **Type** menu.
5. Click the **Choose File** button and navigate to the configuration script and click the **Upload** button.
6. Click the **Next** button.

The system verifies that the file is a valid configuration script and displays any errors or warnings.

7. Click the **Submit** button to continue.
8. In the **Confirmation** box, type the word “**confirm**” in the field provided and click the **Confirm** button.

The settings script is imported and applied automatically.

Update Firmware

Use this function to flash (update) the firmware on the VTrak D5000.

Download the latest firmware image file from PROMISE support:

<http://www.promise.com/support/> and save it to your Host PC or TFTP server.



Important

Verify that no background activities are running on the RAID subsystem.

To update the firmware on the subsystem and JBOD expansion units:

1. Click the **Administration** tab.
2. Click the **Firmware Update** tab.
3. Choose a download option:
 - **Local File through HTTP** – Click the **Choose File** button, locate the firmware image file, click the file to choose it, then click the **Open** button.
 - **TFTP Server** – Enter the TFTP Server host name or IP address, port number and file name.
4. Optional. Check the Non-disruptive Image Update (NDIU) box.

NDIU updates the RAID controllers and I/O modules one at a time, enabling I/O operations continue during the firmware update. Updates with this option take a longer period of time to complete. Only dual controller models support this feature.

5. Click the **Download** button.

The next screen shows the Flash Image (firmware image file) Version Number and Build Date.

6. Click the **Submit** button.

The progress of the update displays.



Warning

Do NOT power off the subsystem during the update!

Do NOT move to any other screen until the firmware update operation is completed!

When the update is completed a message tells you to reboot the subsystem,

7. Click the **OK** button.
 - If you chose the Disruptive Flash Method, the RAID subsystem and JBOD expansion units automatically restart.
 - If you chose the Non-Disruptive Flash Method, the system automatically flashes and restarts the RAID controllers one at a time.

Automatic Restart

If you did NOT check the NDIU box, the RAID subsystem and JBOD expansion units automatically restart. That action temporarily disrupts I/O operations and drops your WebPAM PROe connection.

To reestablish your WebPAM PROe connection:

1. Wait no less than two minutes.
2. Click **Logout** in the WebPAM PROe Header, then log in again.

If you cannot log in, wait 30 seconds and try again.

3. In your browser, click Logout in the WebPAM PROe Header, then log in again.

If you cannot log in immediately, wait 30 seconds and try again.

MANAGING WITH THE CLI

Making a Serial Connection

Before you begin, be sure the RJ11-to-DB9 serial data cable is connected between the Host PC and the VTrak D5000 enclosure, and that both machines are booted and running.

Serial port on the VTrak D5000 controller



Then do the following actions:

1. Change your terminal emulation program settings to match the following specifications:
 - Bits per second: 115200
 - Data bits: 8
 - Parity: None
 - Stop bits: 1
 - Flow control: none
2. Start your PC's terminal VT100 or ANSI emulation program.
3. Press Enter once to launch the CLI.

Logging Into the CLI

1. At the Login prompt, type the user name and press Enter.

The default user name is ***administrator***.

2. At the Password prompt, type the password and press Enter.

The default password is ***password***.

The CLI screen appears.

TABLE OF SUPPORTED COMMANDS

The table below and on the following pages provides a brief description of the CLI commands available on the VTrak D5000 Series.

Command	Action
about	View utility information.
acl	List, set, clear, cancel or refresh the ACL settings on the NAS Share
allowip	NFS allow share IP settings.
battery	View battery information or to recondition a battery.
bbm	View or clear the BBM defect list of the specified configured physical drive.
bga	View status of all current background activities. Enable or disable relevant background activities. Modify the background task rate for each of the background tasks.
bgasched	View status of all current background activities. Enable or disable relevant background activities. Modify the background task rate for each of the background tasks.
buzz	View buzzer status, enable/disable and turn on/off buzzer.
chap	View, create, edit or delete a CHAP record. iSCSI host interface product only.
clone	View logical drive clone status and progress. Start, stop a clone.
ctrl	View or edit controller information and settings.
date	View or edit system time.
domain	Domain settings

Note: Commands are NOT case sensitive.

Table of Supported Commands (Continued)

Command	Action
encldiag	View enclosure element information.
enclosure	View or edit enclosure and SEP information and settings. Locate an enclosure via LEDs.
event	View or clear events logs.
export	Subsystems only. Export files to remote TFTP host.
factorydefaults	Restore settings to factory defaults.
fc	View or edit fc information and settings. Fibre Channel host interface product only.
group	List, add, modify or delete nas group.
import	Import files or license from remote TFTP host.
initiator	View initiator list, add or delete initiator entry.
iscsi	View or edit iSCSI information and settings. iSCSI host interface product only.
isns	View or edit iSNS information and settings. iSCSI host interface product only.
logout	Logout session for the current user.
lunmap	View the LUN mapping and masking table. Enable or disable LUN mapping and masking on iSCSI and Fibre Channel host interface product. Add, delete or modify a LUN mapping and masking entry.
maintenance	Enter or exit maintenance mode.
migrate	Start or stop volume migration
mp	View media patrol status and progress. Start, stop a media patrol process.
nasconfig	List, reset or restore NAS configuration
nasshare	NAS share settings
net	View or edit ethernet network information and settings.
ntp	View or edit NTP status and settings
password	Modify a user's password

Note: Commands are NOT case sensitive.

Table of Supported Commands (Continued)

Command	Action
net	View or edit Ethernet network information and settings.
ntp	View or edit NTP status and settings.
password	Modify a user's password.
pcie	View PCIe slots information in controller.
pdm	View PDM status and progress. Start, stop, pause or resume a PDM process.
perfstats	Start and view performance statistics for controllers, logical drives, physical drives or ports.
periodsnap	List, add, modify or delete periodic snapshot task.
phydrv	View or edit physical drive information and settings. Locate a physical drive via LEDs.
ping	Ping another system through management port.
pool	View or edit pool information. Create, edit or delete a new or existing pool.
protocol	Protocol settings.
ptiflash	Update system software and firmware through tftp server.
quota	List, set, cancel or refresh the Quota settings on NAS Share.
rb	View rebuild status and progress. Start, stop, pause, or resume a rebuild process.
rc	View redundancy check status and progress. Start, stop, pause or resume redundancy check.
replication	View volume replication status. Start or stop replication.
sasdiag	SAS diagnostic command.
sc	View spare check status. Start spare check.
session	View the list of active sessions.
shutdown	Shutdown or restart system.
smart	S.M.A.R.T diagnostic for physical drives.

Note: Commands are NOT case sensitive.

Table of Supported Commands (Continued)

Command	Action
snapshot	Create snapshots or modify snapshot settings.
spare	Create or modify hot spare drives.
stats	View or reset statistics.
subscription	View, modify, enable or disable event notification.
subsys	View or edit subsystem information and settings.
swmgt	View, start or stop software component.
sync	View logical drive synchronization status and progress.
target	View the target list. Add or delete a target entry.
topology	View SAS topology, the physical connections and device information. For products that support multiple enclosures only.
transit	View transition status and progress. Start, stop, pause or resume a transition process.
trunk	List, modify, create and delete trunk information and settings. iSCSI host interface product only.
tz	View and modify timezone information..
ups	View or modify UPS information and status.
user	List, modify, create and delete user accounts on subsystem.
volume	List, add, modify, delete, export and un-export a volume.

Note: Commands are NOT case sensitive.

NOTES AND CONVENTIONS

Commands and options are NOT case sensitive.

Not all extended keys are supported. However, you can use the backspace and the left and right arrow keys for command line editing. In addition, the up and down arrow keys allow scrolling through the command history buffer.

If you need context-sensitive help, type one of the following commands:

- `<command> -h`

That action will display full context-sensitive help for the specific command. Each command when used alone, such as “array” will display a summary of relevant information. If more information is desired, the `-v` verbose mode can be used. This will provide information for all relevant aspects of that command.

Usage terminology is as follows:

- `[square braces]` depict an optional switch
- `<arrow braces>` depict user input

Type “ | more” at the end of each command, to display info page by page

about

Usage

about

Summary

Displays firmware information.

battery

Usage

```
battery [-a <action>] [-b <batId>]
```

```
battery -a recondition -b <batId>
```

Summary

Battery is used to display the current status of a battery indicating the percentage of charge left.

This command is also used to recondition a battery. Reconditioning of a battery attempts to fully discharge, and then recharge it. In addition the battery will be reconditioned automatically once per month.

-a <action>	Which action to perform.
list	(Default) List information for all batteries or a specific battery unit.
recondition	Recondition a specific battery.
-b <battery ID>	Used to specify which battery in a given enclosure.

Examples

```
battery
```

```
battery -a recondition -b 1
```

bbm

Usage

```
bbm [-a <action>] [-p <Pdid>]
```

```
bbm -a clear -p <Pdid>
```

Summary

The `bbm` command displays or clears the Bad Block Map (BBM) defect list for all configured physical drives.

Options

<code>-a <action></code>	Specifies the action to perform.
<code>list</code>	(Default) List the BBM information.
<code>clear</code>	Clears the BBM list. For configured SATA drives only.
<code>-p <Pdid></code>	Specifies the physical drive id. For the <code>-a list</code> option, the default is all physical drives. For the <code>-a clear</code> option, you must specify a physical drive id.

Examples

```
bbm -p 1
```

```
bbm -a clear -p 3
```

bga

Usage

bga [-a <action>]

bga -a mod -s "<list of settings>"

Summary

The bga command displays all current background activities and makes settings for each background activity.

Options

-a <action>	Specifies the action to perform.
list	(Default) Lists current background activities.
mod	Makes changes to one of the settings.
-s "<option>=<value>"	Specifies which background activity settings to change.
autorebuild=	Enable or disable auto-rebuild and auto-transition.
enable	Auto-rebuild initiates a rebuild of an array when an unconfigured drive is inserted into the slot of a dead drive.
disable	Auto-transition means transitioning is initiated on a used revertible spare in the following condition: <ol style="list-style-type: none"> 1. When the rebuild has been completed using the revertible spare, and 2. When an unconfigured drive is inserted into the slot of the dead drive which the was part of the array. or When a non-revertible spare has been inserted or created, and is applicable to the array This option affects all arrays on the subsystem.
<bg task>=<rate>	Background task rates are used to determine what percentage of the IO load on the controller should be dedicated to the background task. A lower number will mean the task takes longer to complete, a higher number will cause the task to complete faster, all other things being equal.

rebuildrate=	Rebuild rate determines the rate at which rebuild will run. (low=25, medium=50, high=75)
low	
medium	
high	
rcrate=	Redundancy check rate determines the rate at which redundancy check will run. (low=25, medium=50, high=75)
low	
medium	
high	
syncrate=	Synchronization rate determines the rate at which synchronization will run. (low=25, medium=50, high=75)
low	
medium	
high	

Examples

bga

```
bga -a mod -s"rebuildrate=high"
```

Type `\ | grep "word1,word2,..."` at the end of each command, to display filtered info.

buzz

Usage

buzz [-a <action>]

buzz -a list buzz -a enable buzz -a disable buzz -a on

buzz -a off

Summary

The buzz command displays the status of the buzzer, and enables, disables, turns on or turns off the buzzer.

Options

-a <action> Specifies the action to perform.

list (Default) List the status of the buzzer.

enable Enable the buzzer.

disable Disable the buzzer.

on Turn on the buzzer.

off Turn off the buzzer.

chap

Usage

```
chap [-a <action>] [-i <ChapId>]
```

```
chap -a add [-s "<list of settings>"]
```

```
chap -a mod -i <ChapId> [-s "<list of settings>"]
```

```
chap -a del -i <ChapId>
```

Summary

The chap command is used to create, modify or delete a CHAP record. CHAP authentication is used between the subsystem and an initiator for the iSCSI host interface.

Options

-a <action>	Which action to perform.
list	(Default) List the existing CHAP records.
add	Create a CHAP record.
mod	Modify an existing CHAP record. To change CHAP secret, use this operation without specifying -s.
del	Delete a CHAP.
-i <chap ID>	Used when viewing, modifying or deleting a CHAP record to uniquely identify the CHAP record which to manipulate.
-s "<option>=<value>"	
name=	Specifies chap name.
type=	Specifies chap type. Could be local or peer.
peer:	A peer CHAP record is one that the initiator must know when logging into the subsystem local: A local CHAP is one that the subsystem must know when the initiator logs into the subsystem to create a session.

Examples

```
chap
  chap -a del -i2
  chap -a mod -i1 -s "name=chap1"
  chap -a add -s "name=chap1, type=local"
  > Chap Secret: *****
```

clone

Usage

```
clone [-a <action>] [-i <clone id>] [-d <snapshot id>] [-n <clone name>] [-v]
```

```
clone -a list
```

```
clone -a add -d <snapshot id> -s "name=<clonename>"
```

```
clone -a mod -i <clone id> -s "name=<newclonename>"
```

```
clone -a del -i <clone id>
```

```
clone -a export -i <clone id>
```

```
clone -a unexport -i <clone id>
```

```
clone -a mount -i <clone id>
```

```
clone -a unmount -i <clone id>
```

Summary

The clone command allow user to view, add, delete a clone.

Can export or uexport a clone if it's type is volume. Can mount or unmount a clone if it's type is nasshare.

Options

-a <action>	Which action to perform.
list	(Default) Displays the current active Clone(s) and their status(es).
add	Add a clone based on snapshot.
mod	Modify clone setting.
del	Delete a clone.
export	Export a clone.For volume type only.
unexport	Unexport a clone.For volume type only.
mount	Mount a clone.For nasshare type only.
unmount	Unmount a clone.For nasshare type only.
-i <clone id>	Specify clone id.
-d <snapshot id> S	Specify snapshot id.
-s "<option>=<value>"	
name=	Name to clone, accept double-bytes.
-f	Force delete the clone.
-v	Verbose mode. Used with -a list.
-y	Enable non-interactive mode.

Examples

```
clone
```

```
clone -a add -d 1 -s "name=abc"
```

```
clone -a mod -i 1 -s "name=abc"
```

```
clone -a export -i 1
```

```
clone -a mount -i 1
```

ctrl

Usage

```
ctrl [-a <action>] [-i <ctrlId>] [-c <ctrl count>] [-v]
```

```
ctrl -a mod [-i <ctrlId>] -s "<list of settings>"
```

```
ctrl -a clear [-i <ctrlId>] [-t <condition type>]
```

Summary

The ctrl command displays controller information and changes controller settings.

Options

-a <action>	Which action to perform.
list	(Default) List current information of the controller(s).
mod	Make changes to one of the settings.
clear	Clear certain condition on the controller.
-i <ctrl ID>	Controller ID that information or settings are for. For high availability products, controller ID is required when setting alias of controller.
-c <ctrl count>	Controller count. Used if the user wants information for multiple controllers.
-s "<option>=<value>"	Used to specify which settings to change.
alias=	A user specified name used to identify a controller. It can be up to 47 characters long, containing alpha-numeric characters, blank spaces and underscores. The beginning and ending blank spaces will be discarded.

Following setting is shared if there are dual controllers:

`coercion=` To enable or disable disk coercion functionality. Disk coercion will truncate the size of the physical disks but will make different sized drives appear as though they are similarly sized. For example, a 90.1 GB drive would appear as the same size as an 89.8 GB drive.

This is important when using drives of different manufacturers when performing rebuilds or in use as hot spares.

Coercion settings are shared if there are dual controllers:

`enable`

`disable`

`coercionmethod=` The method of coercion.

`GBTruncate` Truncates the drive to the nearest 1-billion byte boundary.

`10GBTruncate` Truncates the drive to the nearest 10-billion byte boundary.

`GrpRounding` Truncates the drive using an intelligent algorithm. This allows the maximum amount of usable space while at the same time attempting to keep drives in the same size group the same size. For example a 253 GB drive would appear the same size as a 248 GB drive.

`TableRounding` This uses a pre-defined coercion table to determine how much will be truncated.

`smart=` Enables or disables polling drive SMART status.

`enable`

`disable`

smartpollinginterval=	(1 - 1440) Sets the time interval in number of minutes to poll the drive SMART status.
cacheflushinterval=	(1-12) Sets the time interval in seconds to flush the controller writeback cache.
pollinterval=	Polling interval in seconds to poll enclosure SEP information. 15..255
adaptivewbcache=	To enable or disable adaptive writeback cache.
enable	Writeback logical drives will change the write policy based on the availability of protection. If BBU or UPS is available, the write policy is retained as Writeback, otherwise the policy is switched to Writethru.
disable	The write policy of the writeback logical drives are not changed irrespective of the availability of BBU or UPS.
hostcacheflushing=	To enable or disable host cache flushing. When enabled, SYNCHRONIZE CACHE SCSI command from host is supported.
	For high availability products only.
enable	
disable	
forcedreadahead=	To enable or disable forced read ahead. For high availability products only.
enable	
disable	
ssdtrimsupport=	To enable or disable SSD trim. Default value is enabled.

enable

disable

`powersavingidletime=` After an HDD has been idle for the set period of time, parks the read/write heads. Set the time interval in number of minutes. Valid values are 0(never), 15, 30, 60(= 1 hour)..1440(=24 hours).

`powersavingstandbytime=` After an HDD has been idle for the set period of time, lowers disk rotation speed. Set the time interval in number of minutes. Valid values are 0(never), 15, 30, 60(= 1 hour)..1440(=24 hours).

`powersavingstoppedtime=`

Examples

```
ctrl
ctrl -v
ctrl -l
ctrl -a mod -i 1 -s "alias=ctrl1, coercion=enable"
ctrl -a mod -s "powersavingstoppedtime=180"
```

date

Usage

date

```
date -a mod [-d <date>] [-t <time>] [-z <timezone>]
```

Summary

The date command allows the user to view and modify the system time.

Options

-a <action>	Which action to perform.
list	(Default) Displays the current system time.
mod	Modifies the current system time.
-d <date>	Used to specifies date in the following format: yyyy/mm/dd where month's range is 1-12 and day's range is 1-31.
-t <time>	Used to specifies time in the following format: hh:mm:ss where hour's range is 0-23, minute's and seconds' range are 0-59.

Examples

```
date  
date -a mod -d 2004/02/25 -t 14:50:05
```

encldiag

Usage

```
encldiag -a <action> -e <EnclosureId> -t <element type>
```

Summary

The enclosure diagnostic command is used to get enclosure element information, such as PSU usage, PSU power on time.

Options

-a <action>	Which action to perform.
list	Display enclosure diagnosis information.
-e <enclosure ID>	Used to specify enclosure ID.
-t <diagnose type>	Used to specify type of diagnosis.
all	(Default) Display the all enclosure diagnosis information.
psu	Display the PSU Usage Info.
powerontime	Display the enclosure element power on time information.

Examples

```
encldiag -a list
encldiag -a list -t all
encldiag -a list -e 1 -t psu
```

enclosure

Usage

enclosure [-a <action>] -v

enclosure -a mod -s <list of settings>

enclosure -a locate [-t <FRU type> -f <FRU id>]

Summary

The enclosure command provides status and information about the various components of the enclosure unit. It is also used to set thresholds for temperature and polling. In addition when using the -v option all VPD (Vendor Provided Data) will be displayed.

Options

-a <action>	Which action to perform.
list	(Default) Displays information and status of the enclosure.
mod	Allows the user to modify settings when coupled with the -s switch.
locate	Allows the user to locate an enclosure by flashing LEDs
-e <encl id>	Enclosure ID. The default value is 1 if unspecified.
	For list action, the default is for all enclosures if unspecified.
-i <sensor id>	IOM Sensor ID. For controller temperature warning (1..6) and critical threshold. If unsepecified, only the IOM sensor 1,4 will be set, the IOM sensor 2,3,5,6 will not changed.
-s "<option>=<value>"	Used to specify which Enclosure settings to change.
tempwarning=	(47 - 51) Temperature, displayed in Celsius, that the SEP will consider as a warning threshold.
tempcritical=	(57 - 61) Temperature, in Celsius, that the SEP will consider as a critical threshold.

<code>ctrltempwarning=</code>	Controller temperature, displayed in Celsius, that the controller will consider as a warning threshold. (61-65) For IOM sensor 1,4. (66-70) For IOM sensor 2,5. (71-78) For IOM sensor 3,6.
<code>ctrltempcritical=</code>	Controller temperature, displayed in Celsius, that the controller will consider as a critical threshold. (68-72) For IOM sensor 1,4. (73-77) For IOM sensor 2,5. (81-88) For IOM sensor 3,6.
<code>-t <FRU type></code>	Used with action <code>locate</code> to indicate which type of FRU to locate. If <code>-t</code> is not specified, it indicates to locate the enclosure.
<code>ctrl</code>	To locate controller.
<code>cooling</code>	To locate cooling unit. It only works with SAS type enclosure.
<code>psu</code>	To locate power supply unit. It only works with SAS type enclosure.
<code>-f <FRU id></code>	Used with action <code>locate</code> and <code>-t <FRU type></code> option to indicate which FRU to locate. The valid values for FRU id are 1,2,3 and 4.
<code>-v</code>	Verbose mode. Used with <code>-a list</code> . VPD information will also be displayed when using this switch.

Examples

```
enclosure
enclosure -v
enclosure -a mod -s "tempwarning=40,tempcritical=70"
```

event

Usage

```
event [-a <action>] [-i <SeqNo>] [-c <event count>] [-v]
```

```
event -a clear
```

Summary

The event command displays and clears the RAM and NVRAM event logs.

Options

- | | |
|------------------|--------------------------------------------------------------------------------------------------------------------------------------|
| -a <action> | Specified the action to perform. |
| list | (Default) Displays the events for the specified location. RAM events are displayed if no location is specified. |
| clear | Clear events for a specified location. |
| -i <sequence ID> | Specifies a specific event by its sequence number. This is a starting point. Requires the -a list option. You can use the -c option. |
| -c <event count> | Specifies the number of events to retrieve when displaying events. |
| -v | Verbose mode. Requires the -a list option. |

Examples

```
event
```

```
event -v
```

```
event -c 200
```

```
event -a list -i 852 -c 200
```

Usage

```
export -t <fileType> [-s <tftpServer>] [-p <port>] [-x <fileExt>] -f <fileName>
```

Summary

The export command exports certain types of configuration files to a TFTP server.

Options

-t <file type>	Specifies the type of file to export.
userdb	User database file.
configscript	Configuration script.
servicereport	System service report file in compressed HTML format.
nasconfig	NAS configuration
nasaccount	NAS account
-f <file name>	Specifies the name of the file to be exported.
-x <file ext>	Specifies the type of the file.
txt	Saves service report as a text file.
html	Saves service report as a compressed HTML file (default).
-s <TFTP server>	Specifies tftp server's IP or host name.
-p <port num>	The port number of the TFTP server. Default is 69.

Examples

```
export -t userdb -s 192.168.1.1 -f userdb.bin
export -t servicereport -s 192.168.1.1 -f servicereport
export -t servicereport -s 192.168.1.1 -f servicereport -x txt
```

Note: Make sure that you have a file named <fileName>.<html|txt>.gz (e.g. servicereport.txt.gz or servicereport.html.gz) created on the specified TFTP server, with write permissions.

factorydefaults

Usage

```
factorydefaults -a <action> -t <type>
```

Summary

The factorydefaults command restores specified settings to the factory default values.

Options

-a <action>	Specifies the action to perform.
restore	Restore the factory default settings.
-t <type>	Specifies the type of settings to restore.
all	All settings.
allfw	All firmware settings.
allsw	Subsystems only. All software settings.

The following are individual Firmware settings:

bga	Background activity settings.
ctrl	Controller settings.
encl	Enclosure settings, including temperature thresholds, buzzer, etc.
fc	fc port settings. Fibre Channel host interface product only.
iscsi	iSCSI settings, restore operation applies to port and iSNS; erase operation applies to all iSCSI components, including target, portal, chap, trunk, etc. iSCSI host interfa

netmgmt	Subsystems only. Network settings of management ports.
phydrv	Physical drive settings.
subsyz	Subsystem settings.

The following are individual Software settings:

bgasched	bga scheduler settings.
service	service startup type settings.
webserver	web server settings.
snmp	snmp settings.
ssh	ssh settings.
email	email settings.
ntp	ntp settings.
tz	Time zone settings.
user	user settings.
ups	ups manager configuration settings.
syslog	syslog settings.
nas	nas settings.(Only valid when nas feature is enabled)

Examples

```
factorydefaults -a restore -t phydrv  
factorydefaults -a restore -t all
```

fc**Usage**

```
fc [-a <action>] [-t <Type>] [-i <CtrlId>] [-p <PortId>] [-v]
```

```
fc -a mod -t <Type> -i <CtrlId> -p <PortId> -s “<list of settings>”
```

```
fc -a reset -i <CtrlId> -p <PortId>
```

Summary

The fc command is used to view and modify Fibre Channel information and settings. Fibre Channel host interface product only.

Options

-a <action>	Which action to perform.
list	(Default) Gives summary information about Fibre Channel status.
mod	Modify Fibre Channel settings.
reset	Reset Fibre Channel port(s)
clear	Clear the port statistics.
-t <type>	Specifies what type of information to display or modify.
node	Display Fibre Channel node information.
port	(Default) Specifies Fibre Channel port as the device type to display or modify information.
SFP	Display port SFP (Small Form Factor Pluggable) information.
stats	Display port statistics information.
loggedininitiators	Display port logged in initiator information.
loggedintargets	Display port logged in target information.
device	Display port logged in devices information.
fabricdevices	Display devices list from fabric switch.

-i <ctrlld>	Controller Id. Default to be all available controllers for listing if -i is not specified. Default to be controller 1 for modifying if -i is not specified.
-p <port id>	Port Id. Default to be all ports for listing if -p is not specified. Default to be port 1 for modifying if -p is not specified.
-s "<option>=<value>"	Specifies Fibre Channel settings to change.
linkspeed=	Fibre Channel link speed.
4gb	4 GB/s
8gb	8 GB/s
16gb	16 GB/s
auto	Automatic
topology=	Fibre Channel topology method.
nlport	NL-Port
nport	N-Port
auto	Automatic
hardalpa=	Hard Arbitrated Loop Physical Address (ALPA)
0..255	Value 255 will disable hard ALPA.
-v	Verbose mode. Used with -a list.

Examples

```
fc
fc -t port -v
fc -a mod -t port -p 1 -s "linkspeed=8gb"
fc -a reset -i 1 -p 2
fc -a clear -i 1 -p 2
```

import

Usage

```
import -t <fileType> -s <tftpServer> -f <fileName> [-p <port>] [-i] [-l]
```

Summary

The import command is used to import files from a remote host.

Options

-t <file type>	Specifies what type file to import.
userdb	User database file.
configscript	Configuration script.
nasconfig	NAS configuration
-s <TFTP server>	Specifies tftp server's IP or host name.
-f <file name>	Specifies the name of the file to import.
-p <port num>	The port number of the TFTP server. Default is 69.
-i	Get format validation information about imported file only. File is not really applied to subsystem yet.
	This option is applicable for userdb file only.
-l	Do not use tftp server.

Examples

```
import -t userdb -s 192.168.10.168 -f userdb.xml
```

initiator

Usage

```
initiator [-a <action>] [-i <Index>] [-c <Count>]
```

```
initiator -a add [-i <Index>] -n <Name>
```

```
initiator -a del -i <Index>
```

Summary

Use this to display information about the current initiator list as well as to add or delete an initiator.

Options

-a <action>	Which action to perform.
list	(Default) Displays the current initiator list.
add	Add an initiator to the list.
del	Delete an initiator from the list.
-i <Index>	(0-2047) Used to specify the index of the initiator. For -a list option, it is the starting index and may be used with -c option. For other options, it is the specific index.



Caution

For -a add option, if the index specified is already in use, the existing initiator name is overwritten with new name.

-c <Count> Used to specify the number of initiators to be listed.

 Only used with -a list option.

-t <type> When used with the -a add option, this option specifies which kind of initiator to add.

 fc For a Fibre Channel host interface.

 iscsi For an iSCSI host interface.

-n <Name> Used to specify the name of the initiator.

 For an iSCSI host interface product, the name should be the initiator's iSCSI name, e.g. iqn.vendorcompany.com

 For a Fibre Channel host interface product, the name should be the initiator's WWPN in hex format, e.g. aa-bb-cc-dd-ee-ff-11-22

 For a SAS host interface product, the name should be the initiator's SAS address in hex format, e.g. aa-bb-cc-dd-ee-ff-11-22

 For slot based lun mapping product, the first byte is slot id. For example, for slot 2, the name is 02-00-00-00-00-00-00-00

Examples

```
initiator -i 1 -c 2
```

```
initiator -a add -n iqn.vendorcompany.com
```

iscsi

Usage

```
iscsi [-a <action>] [-t <Type>] [-i <componentId>] [-r <CtrlId> -p <PortId>]
      [-c <Count>] [-m <PortalInterfaceType>] [-v]
```

```
iscsi -a mod [-t <Type>] [-i <TargetId|SessionId|PortalId|DeviceId>]
      [-r <CtrlId> -p <PortId>] -s "<list of settings>"
```

Summary

The `iscsi` command is used to display and modify iSCSI information and settings. Use this to view and modify iSCSI component and global settings, and to add and delete iSCSI portals. iSCSI host interface product only.

Options

<code>-a <action></code>	Which action to perform.
<code>list</code>	(Default) Gives summary information about iSCSI status.
<code>add</code>	Add iSCSI portal.
<code>mod</code>	Modify iSCSI settings.
<code>del</code>	Delete iSCSI target, portal or session.
<code>-t <type></code>	Specifies the type of information. For list action, the default is target if unspecified. For modify action, the default is global iSCSI setting if the type is unspecified.
<code>target</code>	Specifies iSCSI target as the device type to display, add, modify or delete information.
<code>port</code>	Specifies iSCSI port as the device type to display or modify information.
<code>session</code>	Display or delete session information.
<code>portal</code>	Display, add, modify or delete portal information.
<code>device</code>	Displays the logged in devices information.

-i <component id>	
-n <target id>	Target id
-i <session id>	Session id
-g <portal id>	Portal id
<device id>	Device id for iSCSI device type.
-c <controller id>	Controller id
-p <port id>	Port id
-c <Count>	Used to specify the number of items to be listed. Only used with -a list option.
-m <portal interface type>	Valid for add iSCSI portal type.
phy	(Default)
vlan	
trunk	
-s "<option>=<value>"	Specifies which iSCSI type settings to change. The following are for target settings. Requires -t target and -n <target id> options.
alias=	Target alias. Can up to 31 characters long, containing alphanumeric characters, blank spaces and underscores. The beginning and ending blank spaces will be discarded.
headerdigest=	32bit CRC for iSCSI headers. Enabling a header digest may decrease performance.
enable	
disable	

datadigest	32bit CRC for iSCSI data. Enabling a data digest may decrease performance.
enable	
disable	
unichapauth	Unidirectional CHAP authorization. Requires the initiator to have a CHAP secret to log into the subsystem. Can be configured only when modify a target.
enable	
disable	
bichapauth	Bidirectional CHAP authorization. Requires both the subsystem and initiator to have a CHAP secret to log in. Can be configured only when modify a target.
enable	
disable	

The following setting applies to sessions and targets.

Requires -t session and -r <controller id>, -i <session id> options or -t target and -i <target id>

keepalive = Keeps an iSCSI session alive. For global setting,
enable omit -t and -i options.
disable

The following settings apply to ports.

Requires -t port and -r <controller id>, -p <port id> options.

jumboframe = Enable or Disable the jumbo frame of the port.
enable
disable

The following settings apply to portals.

Requires -t portal and -g <portal id> options.

Adding a portal also requires -m <portal interface type> option.

vlantag =	The VLAN tag of a portal in LAN-mode. Range is 1 to 4094.
trunkid =	The Trunk ID of a portal in Trunk-mode. Range is 1 to 8.
dhcp =	Enable or Disable DHCP on the portal.
enable	
disable	
iptype =	The IP address type of portal.
4	IPv4
6	IPv6
primaryip =	The primary IP address of portal. Use when DHCP is disabled.
primaryipmask =	The primary IP mask of portal. Use when DHCP is disabled.
gateway =	Specify the gateway.
tcpport =	Specify the tcp port number.
porttype =	The port type used to create portal.
	Only valid for -m phy or vlan interface type.
io	
mgmt	
attribute =	The portal mode.
io	
advanced	
-v	Verbose mode. Used with -a list.

Examples

```
iscsi
iscsi -t port -r 1 -p 2
iscsi -a del -t session -i 2 -r 1
iscsi -a mod -s "keepalive=enable"
iscsi -a mod -t target -i 1 -s "alias=vendorNode"
iscsi -a add -t portal -r 1 -p 1 -m phy -s "iptype=4,dhcp=enable, porttype=io"
iscsi -a add -t portal -r 1 -p 2 -m vlan -s "iptype=4,dhcp=enable, vlantag=4,porttype=io"
iscsi -a add -t portal -m trunk -s "iptype=4,dhcp=enable,trunkid=0"
```

isns

Usage

```
isns [-a <action>]
```

```
isns -a mod -t <Type> [-g <PortalID>] -s "<list of settings>"
```

Summary

iSCSI iSNS Information and Settings. iSCSI host interface product only.

Options

-a <action>	Which action to perform.
list	(Default) Displays a summary of iSNS settings.
mod	Allows the user to change iSNS settings
-t <port type>	The type of port to iSNS through. If -t is not specified, the default value is Mgmt port.
portal	iSCSI portal. For iSCSI host interface product only.
mgmt	Management port. For embedded only.
-g <portal id>	Portal ID
-s "<option>=<value>"	Used to specify what options to change.
isns =	Enable and disable iSNS.
enable	
disable	
serverip =	iSNS server ip address.
serverport =	iSNS server port number. The default value is 3205.
	1..65535

Examples

```
isns
```

```
isns -a mod -t mgmt -s "isns=enable,serverip=10.0.10.90"
```

logout

Usage

```
logout
```

Summary

The logout command is used to logout the current user from the session.

Examples

```
logout
```

lunmap

Usage

```
lunmap [-a <action>] [-i <InitiatorId>] [-t <type>] [-c <Count>]
```

```
lunmap -a addlun -i <InitiatorId> [-p <SourceType>] [-l <SourceIdList>] [-m <LunMapList>]
```

```
lunmap -a dellun -i <InitiatorId> [-p <SourceType>] [-l <SourceIdList>]
```

```
lunmap -a add [-i <InitiatorId>] -n <Name> -t <type> [-p <SourceType>] [-l <LddList>] [-m <LunMap>]
```

```
lunmap -a del -i <InitiatorId>
```

```
lunmap -a enable
```

```
lunmap -a disable
```

Summary

The lunmap command displays information about the current LUN mapping and masking (LMM) table information and enables you to add, modify, and delete LMM entries. LMM can be enabled or disabled.

Options

-a <action>	Which action to perform.
list	(Default) Displays the current LMM table.
enable	Enables LMM.
disable	Disables LMM.
add	Adds an LMM entry and its LUN maps to the table.
del	Deletes an LMM entry from the table.
addlun	Adds or modifies an LUN map for an existing LMM entry.
dellun	Deletes a LUN map for an existing LMM entry.
-i <InitiatorId>	(0-2047) Specifies the initiator ID for an initiator based LMM entry. For -a list option, it is the starting index. May be used with -c option.
-c <Count>	Specifies the number of LMM entries to be listed. Only used with -a list option.
-t <type>	When used with the -a add option, this option specifies which kind of initiator to add.
fc	
iscsi	
-n <Name>	Specifies the initiator name. For iSCSI host interface, the name is the initiator's iSCSI name, such as iqn.vendorcompany.com For Fibre Channel host interface, the name is the initiator's WWPN in hex format, such as aa-bb-cc-dd-ee-ff-11-22

<code>-p <source type></code>	Specifies the source type.
volume	
snapshot	
clone	
<code>-l <Source ID list></code>	(0-1023) Specifies the source IDs.
<code>-m <LUN map list></code>	(0-1023) Specifies the LUN mapping values. Please check the maximum number of LUNs supported by host OS.

Examples

```
lunmap -i 1 -c 2
lunmap -a addlun -p volume -i 1 -l 2 -m 2
lunmap -a dellun -p volume -i 1 -l 2
lunmap -a enable
lunmap -a add -i 0 -p volume -l 0,1 -m 0,1
```

maintenance

Usage

```
maintenance [-a <action>] -i <CtrlId>
```

```
maintenance -a enter -i <CtrlId>
```

Summary

The maintenance command instructs the selected RAID controller to enter maintenance mode.

Note: To bring the RAID controller out of maintenance mode, enter the command “shutdown -a restart”.

Options

-a <action>	Which action to perform.
enter	(Default)Enter maintenance mode.
-i <CtrlId>	Controller id.

Examples

```
maintenance -i 1
```

net

Usage

```
net [-a <action>] [-t <type>] [-f <protocol family>] [-c <ctrl ID>] [-p <portid>] [-s "<list of settings>"] [-m] [-v]
```

```
net -a mod -t port -s "<list of settings>"
```

```
net -a mod -t portal [-f <protocol family>] -s "<list of settings>"
```

```
net -a mod -t portal -m -c <ctrl ID> [-f <protocol family>] -s "<list of settings>"
```

```
net -a enable -t port
```

```
net -a enable -t portal [-m] [-c <ctrl ID>] -f <protocol family>
```

Summary

Net is used to display the TCP/IP specific information for the management port and portal.

In addition to displaying IP address and subnet mask, changes to DHCP and DNS settings can be changed. Most often this command will be used during initial setup to either setup a static IP address or to display what DHCP assigned IP address the enclosure is using.

Options

-a <action>	Which action to perform.
list	(Default) Displays a list of IP configurations.
mod	To modify current network settings.
enable	To enable IPv4/IPv6 for portal type. To enable IO support for port type.
disable	To disable IPv4/IPv6 for portal type. To disable IO support for port type.
-t <type>	
port	
portal	(Defaults)
-m	Physical portal IP configurations.

This option must be specified in maintenance mode

-c <ctrl ID>	Specifies the controller ID. When the action is to modify setting and -c is not specified, the value is default to be the current controller id.
-p <port ID>	Specifies the port ID.
-f <protocol family>	To specify which protocol family will be modified, enabled or disabled.
ipv4	(Default)IPv4.
ipv6	IPv6.
-y	Execute command in non-interactive mode.
	Only valid for disable, mod action.
-s "<option>=<value>"	List the various settings for the MGMT ports and portals.
	These options are comma separated.
	Works only with modify command.

The following settings apply to portal. Requires -t portal or -t portal -m and -c <controllerr id> options.

ip=	Specify the primary IP address.
ipmask=	Specify the primary subnet mask.
gateway=	Specify the gateway.
dhcp=	Enable or disable DHCP support.
	Currently only supported for ipv4.
enable	
disable	

Followings are global settings apply to portal. Requires -t portal option.

primarydns=	Set an IP address of the primary DNS server.
secondarydns=	Set an IP address of the secondary DNS server.
autodns=	Obtain DNS from DHCP server. Only valid when DHCP is enabled on the default route portal.
enable	
disable	
defaultroute=	Default route on which portal type.
floatingip	
staticip	
ioportal	
ctrl1portalid=	Default route portal ID on controller1. Valid for defaultroute as ioportal.
ctrl2portalid=	Default route portal ID on controller2. Valid for defaultroute as ioportal.
wol=	Enable or disable Wake On LAN support.
enable	
disable	

The following settings apply to port. Requires -t port, -c <controllerr id> and -p <port id> options.

jumboframe =	Enable or Disable the jumbo frame of the port.
enable	
disable	
-v	Verbose mode. Used with -a list.

Examples

```
net                *shows a list of floating IP info*
net -m            *shows a list of static IP info*
net -a enable -t port          *enable IO support
net -a enable -t portal -f ipv4
net -a enable -t portal -m -c 1 -f ipv4
net -a mod -m -c 1 -s "ip=10.0.0.2"
net -a mod -f ipv4 -s "ip=192.168.1.10, ipmask=255.255.255.0"
net -a mod -t portal -s "autodns=enable, wol=disable"
net -a mod -t port -c 1 -p 1 -s "jumboframe=enable"
```

ntp

Usage

```
ntp [-a <action>]
```

```
ntp -a list
```

```
ntp -a mod -s "<list of settings>"
```

```
ntp -a test -t <time server>
```

```
ntp -a sync
```

Summary

The ntp command enables a user to view NTP status, add an NTP server, modify NTP settings, test the NTP server connection, and synchronize subsystem time with the NTP server.

Options

-a <action>	Which action to perform.
list	(Default) Displays NTP information.
mod	Change the settings for NTP.
test	Test time server.
sync	Sync time with time server.
-s "<option>=<value>"	Used to specify what options to change.
ntp=	Enable and disable ntp service.
enable	
disable	
server1=	Specific to the time servers.
server2=	
server3=	
-t <time server>	Specifies the time server to test
	Used with -a test. Returns only failure reports.

Examples

```
ntp -a list
ntp -a mod -s "server1=ABC.123.XYZ" (adds a NTP server)
ntp -a mod -s "ntp=enable, server1=ABC.123.XYZ"
ntp -a test -t ABC.123.XYZ
ntp -a sync
```

password

Usage

```
password [-u <username>] [-t<type>] [-p<protocol>]
```

Summary

Allows a user to change their password. A normal (non super user) user will never use the -u option, as they are allowed only to change their password. For any user who wants to change its own password, it will be first prompted for their old password before inputting their new password.

For a super management user, the -u option can be used to change the password of other users. When changing the password of another user, the old password is not required.

Maximum password length is 31 characters, no spaces.

Options

<code>-u <username></code>	Whose password to change. Current management user is the default.
<code>-t <type></code>	Specified the user type.
<code>mgmt</code>	(Default)Change management user password.
<code>snmp</code>	Change snmp user password.
<code>nas</code>	Change nas user password.
<code>-p<protocol></code>	Specifies the secure protocol type. For snmp user only.
<code>auth</code>	Change authentication protocol password.
<code>priv</code>	Change privacy protocol password.

Examples

```
password
old password:*****
new password:*****
Retry password:*****
password -u snmpuser -t snmp -p auth
Input auth password:*****
Retype auth password:*****
password -u nasuser -t nas
new password:*****
Retry password:*****
```

pcie

Usage

```
pcie [-a list] [-h]
```

Summary

This command will display PCIE slot information for the controllers.

Options

-a <action>	Specifies the action to perform.
list	(Default) Displays a list of PCIE slot info.

Examples

```
pcie          Displays a list of PCIE slot information
```

perfstats

Usage

```
perfstats -a start
```

```
perfstats -a list [-t <type>]
```

Summary

The perfstats command will display performance statistics of controllers, disk pools, volumes, physical drives and ports.

Options

-a <action>	Which action to perform.
list	(Default) Displays the performance statistics.
start	Starts the performance statistics.
-t <type>	Used to specify the device type. Used with -a list.
ctrl	controller
phydrv	physical drive
port	port
all	Includes all the above options

Examples

```
perfstats -a start
```

```
perfstats -a list -t all
```

phydrv

Usage

```
phydrv [-a <action>] [-p <PdId>] [-c <Pd count>] [-v]
```

```
phydrv -a mod -p <PdId> -s “<list of settings>”
```

```
phydrv -a locate -p <PdId>
```

```
phydrv -a online -p <PdId>
```

```
phydrv -a offline -p <PdId>
```

```
phydrv -a clear -t <condition type> -p <PdId>
```

Summary

The `phydrv` command displays physical drive information, changes physical drive settings, locates individual drives, and forces a drive to an online or offline state.

Note: Forcing a drive online should only be done in extreme conditions. It will almost always cause data corruption.

Options

-a <action>	Which action to perform.
list	(Default) Displays all physical drives in the enclosure, their make, model number, and array they belong to. Their status is also shown.
mod	Allows the user to make modifications to the physical drive settings.
locate	Allows the user to flash an LED for physically identifying the location of the drive.
online	Allows the user to force a drive ONLINE from the OFFLINE state. It is highly recommended not to do this except in extreme conditions. Performing this action will in almost all cases cause data corruption.
offline	Allows the user to force a drive offline if it is misbehaving.
clear	Allows the user to clear a drive's past condition.
-p <PD ID>	Specifies the physical drive ID.

-c <count>	Used when more than one physical drive is to be specified and their ID numbers are sequential.
-l	Used with -a list option to display external drive information.
-t <condition type>	When used with the -a clear option, this option specifies which type of condition to clear.
pfa	Used to clear the PFA condition on the drive.
staleconfig	Used to clear the stale configuration on the drive.
-d <drive type>	When used with the -a mod option, this option specifies which drive type settings to modify. It defaults to be all if -d is not specified.
sata	SATA related setting(s): writecache, rllacache, dmamode. The SATA settings apply to all SATA physical drives.
sas	SAS related setting(s): writecache, rllacache, readcache. The SAS settings apply to all SAS physical drives.
all	Apply to both SATA and SAS drives where is applicable.
-s "<option>=<value>"	Used to specifies which physical drive settings to change.
alias=	A user specified name used to identify a physical drive. Currently, this is the only setting that is specific to individual drive. It can only be set on a configured drive. It can be up to 32 characters long, containing alpha-numeric characters, blank spaces and underscores. The beginning and ending blank spaces will be discarded.

The following settings are global to same type of physical drives:

`writecache=` Enables or disables write cache on the physical drive(s).

`enable`

`disable`

`rlacache=` Enables or disables read look ahead cache on the physical drive(s).

`enable`

`disable`

`temppollint=` Drive temperature polling interval in seconds.
(15..255) If value is 0, polling is disabled. For high availability products only.

`mediumerrorthreshold=` (0..4294967294) Medium error threshold. If the threshold is exceeded, the physical drive will be marked as dead. The default value is 0, indicating that physical drive will not be marked as dead for medium errors.

The following settings are only for SATA drives:

`dmamode=` For SATA drive only. Attempt to negotiate at the specified DMA transfer mode.

If a DMA transfer mode cannot be negotiate, the next slower mode will be attempted until a mode can be negotiated (udma6, udma5....udma0, mdma 2.....mdma0).

<code>udma0</code>	Ultra DMA Mode 0
<code>udma1</code>	Ultra DMA Mode 1
<code>udma2</code>	Ultra DMA Mode 2
<code>udma3</code>	Ultra DMA Mode 3
<code>udma4</code>	Ultra DMA Mode 4
<code>udma5</code>	Ultra DMA Mode 5
<code>udma6</code>	Ultra DMA Mode 6
<code>mdma0</code>	Multi DMA Mode 0
<code>mdma1</code>	Multi DMA Mode 1
<code>mdma2</code>	Multi DMA Mode 2

The following settings are only for SAS drives:

`readcache=` Applied to SAS drive only. Enables or disables read cache on the physical drive(s).

`enable`

`disable`

`-v` Verbose mode. Used with `-a` list.

Examples

```
phydrv
phydrv -v
phydrv -l -v
phydrv -a locate -p 9
phydrv -a mod -s "writecache=enable,rlacache=enable"
phydrv -a offline -p 8
phydrv -a online -p 8
phydrv -a clear -p 8
```

ping

Usage

```
ping -t <PortType> [-l <CtrlId>] [-p <PortId>] -i <ipAddr | DestinationId> [-d <DestinationType>]
```

Summary

Allows the user to ping another network device from the management port or FC port to verify that the device is able to be “seen” by the enclosure.

Options

-t <port type>	The type of port to ping through. If -t is not specified, the default value is mgmt port.
iscsi	iSCSI port. iSCSI host interface product only.
mgmt	Management port. For embedded only.
fc	FC port. FC host interface product only.
-l <CtrlId>	Controller id. It is required when port type is fc.
-p <port ID>	Physical port id. Port id is required when port type is fc.
-i <IP address DestinationId>	IP address to ping destination identifier for fc port.
-d <Destination Type>	The type of destination for the ping. It is required when port type is fc.
FCID	
WWPN	

Examples

```
ping -t mgmt -i 192.168.1.1 # for embedded
ping -t iscsi -l 1 -p 1 -i 192.168.1.1 -c 5
ping -t fc -l 1 -p 1 -d WWPN -i 26-03-00-01-55-60-01-0e
```

pool

Usage

```
pool [-a <action>] [-i <pool id>] [-v]
```

```
pool -a add [-s “<list of pool params>”] -p <pd id list>
```

```
pool -a del -i <pool id list>
```

```
pool -a mod -i <pool id> -s “<list of pool params>”
```

```
pool -a expand -p <pd id list>
```

Summary

Pool is the main command for performing advanced configuration maintenance and is used when performing tasks that are directly related to pool. It can be used to list, create, modify, delete, expand or locate the pool(s) configuration in the subsystem.

Options

-a <action>	Specifies which action to perform.
list	(Default) Displays a summary of all or a specific or a specified number of pools.
mod	Modify pool name.
add	Create new Pool by specific drives, RAID level and so on.
del	Delete an existing pool.
expand	Expand pool. The pool created by external drive can expand only with external drive. The pool created by HDD physical drive can expand with external drive.
locate	Allows the user to flash the LED for physically identifying the location of the pool.
-i <Pool ID>	The pool ID. Valid for list, mod, del and expand action.

-t <Drive type>	Specify the type of drive.
pd	Physical drive
ed	External drive
-p <PD ID list>	Used to specify which physical drives are to be used in a pool. Used in conjunction with -a add. PD IDs can be used singly or separated by a comma. Additionally a sequential group of physical drives can be specified by placing a ~ between numbers such as 1~6. This will include physical drives 1,2,3,4,5,6.
-s "<option>=<value>"	Used to specify settings for a pool. This is used when creating (add) or modifying (mod) a pool. These options are separated by commas.
name=	A user specified name used to identify a pool. It can be up to 32 characters long, containing alpha-numeric characters, blank spaces and underscores. The beginning and ending blank spaces will be discarded. Valid for add or mod action
raid=	Used to specify the RAID level of the pool Only valid for add action with physical drive type.
0	Striping.
1	Mirroring on two drives.
5	Parity, requiring 3 or more drives.
10	Mirroring on even number of drives.
50	Striping on multiple RAID 5, requiring 6 or more drives.
6	Allow two drive failure, requiring 4 or more drives.
60	Striping on multiple RAID 6, requiring 8 or more drives.

stripe=	Used to specify the stripe size of the logical drive. The possible parameters are 64KB, 128KB, 256KB, 512KB, and 1MB. If not specified, the default 64K will be used. Only valid for add action
sector=	Used to specify the desirable sector size of the logical drive. The possible parameters are 512B, 1KB, 2KB, and 4KB. It must not be greater than the Stripe size. It will be auto-adjusted not to exceed the max supported sector size of the controller, please see controller information. If not specified, the default 512 will be used. Only valid for add action
Axle=	RAID 50, 3 to 32 drives per axle. RAID 60, 4 to 32 drives per axle. Valid for add action with physical drive type or expand action on the pool created by physical drive with new drives is physical drive too.
ctrlid=	Used to specify which controller the pool is preferred for LUN affinity. Valid value is 1 or 2. If value is not specified, LUN affinity will be auto balanced. Valid for add or mod action.
all pools:	
capthreshold=	(75..95) Pool capacity nearly full warning threshold. Valid for add or mod action.
-f	Force delete the pool.
-v	Verbose mode. Used with -a list action.
-y	Enable non-interactive mode.

Examples

```
pool -v -i 1
pool -a add -s "name=MyAxxx, raid=5" -t pd -p 1,3,5~9
pool -a add -s "name=MyAxxx" -t ed -p 1,2
pool -a mod -i 1 -s "name=xxx"
pool -a del -i 3
pool -a expand -i 1 -t pd -p 1,3,5~10 -s "axle=4"
pool -a expand -i 2 -t ed -p 1,2
pool -a locate -i 1
```

ptiflash

Usage

```
ptiflash [-a <action>] [-t] [-s <ServerIP>] -f <FileName> [-p <PortNum>]
```

```
[-e <encl id>] [-i <ctrl id>] [-n] [-d <pd id>] [-l] [-y] [-v]
```

Summary

This is the flash utility for the controller and physical drives. It is used to flash images such as firmware or software for controllers and drive firmware image for physical drives. For embedded, in order to update the flash image, the user must have a TFTP server setup that is accessible from the enclosure's management port and the flash image located on the TFTP server. For in-band, the flash image located on the local host must be accessible.

Please note that only one flash process should be running at one time.

Options

-a <action>	Which action to perform.
start	(Default) To start the flash process.
versioninfo	To get the version and build information of running images of all controllers or the specified controller.
-t	Indicates that TFTP get method is to be used to obtain the file from a TFTP server.
-s <servername ipaddress>	Specifies the hostname or IP address of the TFTP server which contains the image file.
-f <filename>	Specifies the filename of the flash image. Include the folder name A flash image could be either a controller flash image or a physical drive firmware update image.
-p <port number>	Specifies the port number of the TFTP server. If no port number is given, the default value that will be used is 69.

-e <encl id>	Specifies the Enclosure ID. Only used with -a versioninfo option. If not specified, default value is all enclosures.
-i <ctrl id>	Specifies the Controller ID. Only used with -a versioninfo option. Enclosure id is required when controller id is specified. If not specified, default value is all controllers.
-v	Verbose mode. Only used with -a versioninfo option. To show the version and build information of all the flash images of all controllers or the specified controller.
-n	Start the flash process/image update in NDIU mode. This mode is applicable only if the system is in redundant state. Default mode of flash is DIU (disruptive) mode.
-d <device id>	Specifies the physical drive IDs. Only for physical drive firmware update. If not specified, all the physical drives, which are supported by the specified physical drive firmware, are selected.
-l	Display the status of currently running flash process.
-y	Enable non-interactive mode.

Examples

```
ptiflash -t -s 192.168.1.1 -f fw_multi.ptif -p 69 # for embedded
ptiflash -f fw_multi_20031010.ptif # for in-band
ptiflash -l # list currently running flash process
ptiflash -t -s 192.168.1.1 -f fw_multi.ptif -n # for NDIU mode
ptiflash -t -s 192.168.1.1 -f pd_fw.ptif -d 1,2
# update the pd firmware for pd 1 and 2 using the pd_fw.ptif image.
```

rb

Usage

```
rb [-a <action>] [-l <PoolId>] [-s <SeqNo>]
rb -a start -l <PoolId> -s <SeqNo> -p <PId>
rb -a stop -l <PoolId> -s <SeqNo>
rb -a pause -l <PoolId> -s <SeqNo>
rb -a resume -l <PoolId> -s <SeqNo>
```

Summary

This command allows the user to check on the progress of a running or paused Rebuild as well as to check on the progress of a running Rebuild..

Options

-a <action>	Which action to perform.
list	(Default) Displays the current active and their status(es).
start	Starts a manual rebuild.
stop	Stops a rebuild.
pause	Pauses a rebuild.
resume	Resumes a paused rebuild.
-l <Pool ID>	Specifies which Pool to perform rebuild action on.
-s <sequence Num>	Specifies the sequence number of the physical drive that was marked offline and will used for the rebuild.
-p <PD ID>	Identifies the physical drive ID that will be used in the rebuild process.

Examples

```
rb
rb -a start -l 0 -s 2 -p 10
rb -a stop -l 0 -s 2
```

rc

Usage

```
rc [-a <action>] [-l <Ldid>]
rc -a start -l <Ldid> [-n] [-p]
rc -a stop -l <Ldid>
rc -a pause -l <Ldid>
rc -a resume -l <Ldid>
```

Summary

The rc command is used to start and stop a Redundancy Check and monitor the progress of a running Redundancy Check.

Options

-a <action>	Specifies action to perform.
list	(Default) Displays active and paused Redundancy Checks and their status.
start	Starts a Redundancy Check.
stop	Stops a Redundancy Check.
pause	Pauses a Redundancy Check.
resume	Resumes a paused Redundancy Check.
-l <Pool ID>	Specifies the Pool ID on which to run redundancy check.
-n	Do not fix inconsistent data. This option causes Redundancy Check to run without correcting inconsistent data. All inconsistency errors are reported.
-p	Pause on error. This option causes Redundancy Check to pause when it encounters inconsistent data. The default is to continue on error.

Examples

```
rc
rc -a start -l3 -n -p
rc -a start -l3
rc -a stop -l2
```

SC

Usage

```
sc [-a <action>] [-i <SpareId>]
```

```
sc -a start [-i <SpareId>]
```

Summary

The sc command starts a Spare Check and monitors the status of a running Spare Check.

Options

-a <action>	Specifies the action to perform.
list	(Default) Displays Spare Check status.
start	Starts the Spare Check.
-i <Spare ID>	Specifies the spare ID on which to run Spare Check. Valid value range is 0~255.

Examples

```
sc
sc -a start -i 3
```

session

Usage

session

session -h (this command)

Summary

This command lists the current active sessions.

Examples

```
session
```

shutdown

Usage

```
shutdown -a <action> [-i <ctrlId>
```

```
shutdown -a shutdown
```

```
shutdown -a restart
```

```
shutdown -a restart -i 2
```

```
shutdown -a shutdown -i 1
```

Summary

Shutdown is the command used to shutdown or restart a controller or subsystem.

Options

-a <action>	Which action to perform.
shutdown	To shutdown the controller or subsystem.
restart	To restart the controller or subsystem.
-i <ctrlId>	Controller ID or subsystem. If -i is not specified, the default value is subsystem.
1	Controller 1.
2	Controller 2.
subsys	Subsystem.

smart

Usage

```
smart [-a <action>] [-p <Pdid>]
```

Options

-a <action>	Which action to perform.
list	(Default) Displays the status of S.M.A.R.T. diagnostic for phydrv drive(s).
enable	Enable S.M.A.R.T.
disable	Disable S.M.A.R.T.
-p <Pdid>	Specifies physical drive ID of the destination drive. If not specified, the destination drive will be all physical drives.
-v	Verbose mode. Used with -a list.

Summary

S.M.A.R.T diagnostic for physical drives.

Examples

```
smart
smart -v
smart -a list -p 1
smart -a enable -p 1
```

spare

Usage

spare [-a <action>]

spare -a list [-i <SpareId>] [-d <PoolId>] [-v]

spare -a add [-i <SpareId>] -p <PId> [-t g|d] [-r y|n] [-d <PoolId list>] [-s “<list of settings>”]

spare -a del -i <SpareId>

Summary

Spare is the command used to display all hot spare drives as well as to create and delete hot spare drives.

A Global hot spare is the most generic form. A global hot spare drive can replace any drive from a pool of equal size or less.

A dedicated hot spare is a spare drive that has been assigned specifically to one or more pools. It is used to replace only drives that are in these assigned pools. If a drive is marked offline that was not in one of the assigned pools, the dedicated spare will not replace that drive. This feature can be used for prioritizing pools which may have a greater need to survive disk failures.

Options

-a <action>	Specifies the action to perform.
list	(Default) Displays a list of hot spare drives.
add	Adds new hot spare drives.
del	Deletes a hot spare drive.
-i <Spare Id>	Specifies the ID of the spare drive.
-p <PD ID>	Specifies the ID of the physical drive. Requires the -a add option to configure a drive as a spare.
i <Spare Id>	The ID of the spare to list, and delete.
-p <PD ID>	The ID of the physical drive. Used with -a add to configure the drive as a spare.

- d <POOL ID or POOL ID List>** When used with **-a** list, it is used to specify a pool id. The result of the list will be the global spares and the dedicated spares to this pool. When used with other actions, it is used to specify the ids list of the pools to which the spare is dedicated.
- t <type>** Type of hot spare to manipulate.
- g** A global hot spare will replace any drive from a redundant pool of same size or smaller.
 - d** A dedicated hot spare will only replace drives from pools in which the spare is associated with. Drives that are being replaced must be of the same size or smaller.
- r <revertible>** Whether the spare drive is revertible or committed.
- y** Revertible.
 - n** Committed.
- v** Verbose mode. Used with **-a** list. spare is dedicated.
- t <type>** Type of hot spare to manipulate.
- g** A global hot spare will replace any drive from a redundant pool of same size or smaller.
 - d** A dedicated hot spare will only replace drives from pools in which the spare is associated with. Drives that are being replaced must be of the same size or smaller.
- r <revertible>** Whether the spare drive is revertible or committed.
- y** Revertible.
 - n** Committed.
- v** Verbose mode. Used with **-a** list.

Examples

```
spare
```

```
spare -a add -p 14 -t g
```

```
spare -a del -i 0
```

stats

Usage

```
stats [-t <type>] [-i <devId>] [-c <Count>]
```

```
stats -a clear
```

Summary

The stats command displays statistics of subsystem, controller, enclosure, physical drives, and logical drives; and resets the statistics count to zero.

Options

-a <action>	Specifies the action to perform.
list	(Default) Displays the statistics.
clear	Resets the statistics count to zero.
-t <type>	Specifies the device type.
ctrl	Controller.
phydrv	Physical drive.
all	All the above options.
-i <devId>	Specifies the device ID. Default is the first available device ID.
-c <Count>	Specifies the device count. Default is all devices. Used with -a list.

Examples

```
stats -t phydrv -i 0 -c 5
stats -a list -t all
stats -a clear
```

subsys

Usage

```
subsys [-a <action>] [-v]
```

```
subsys -a mod -s "<list of settings>"
```

```
subsys -a lock [-r] [-t <number of minutes>]
```

```
subsys -a unlock [-f]
```

```
subsys -a chklock
```

Summary

The subsys command is used to display and make changes to subsystem settings. This is also used to lock the subsystem so that only the current administrator can make modifications.

Options

-a <action>	Specifies the action to perform.
list	(Default) Displays information for the specified subsystem.
mod	Modifies subsystem settings.
lock	Locks the subsystem so other users cannot apply changes. No changes can be made to subsystem settings by other users until the lock expires or the system is unlocked.
unlock	Clears a subsystem lock.
chklock	Checks the status of the lock.
-s "<option>=<value>"	Specifies which subsystem settings to change.
alias=	A user specified name to identify the subsystem. It can be up to 48 characters long, containing alpha-numeric characters, blank spaces and underscores. The beginning and ending blank spaces will be discarded.

cachemirroring=	Enable and disable cache mirroring. Cache mirroring will only be available when redundancy type is active-active. The default value is enable if not specified.
enable	
disable	
-t <number of mins>	Used with -a lock. Number of minutes to lock the subsystem. Default is 30 minutes.
-r	Renew the lock timer. Used with -a lock and -t
-f	Force unlock. Only super user has the privilege to do it.
-v	Verbose mode. Used with -a list.

Examples

```
subsys
subsys -v
subsys -a mod -s "alias=MySubsystem"
subsys -a lock -t 60
subsys -a lock -r -t 35
subsys -a unlock
subsys -a chklock
```

swmgt

Usage

```
swmgt [-a <action>]
```

```
swmgt -a mod -n <component name> [-t <startup type>] [-s "<list of settings>"]
```

```
swmgt -a start -n <component name>
```

```
swmgt -a stop -n <component name>
```

```
swmgt -a restart -n <component name>
```

Summary

The swmgt command allows a user to view and modify setting of software components.

Options

-a <action>	Which action to perform.
list	(Default) Displays all software components.
start	Start a software component.
stop	Stop a software component.
restart	Restart a software component.
mod	Change a component's startup type when system boots.
add	Add trap sink for snmp, public key for ssh or recipient for netsend.
del	Delete trap sinks for snmp, public key for ssh or recipients for netsend.

-n <component name>	Specifies the component name to view setting, modify, start or stop.
email	Email notification.
slp	Service location protocol service agent. SLP service is supported for IPv4 protocol only.
webservers	Web server.
ssh	SSH.
snmp	SNMP.
advanced	Advanced feature.
-t <startup type>	Specifies the startup type.
automatic	Component is automatically started when system boots.
manual	Component has to be manually started by issuing command.
-s "<option>=<value>"	Used to specify settings for this component. This is used when modifying (mod). These options are comma separated.

email settings

smtpserver=	SMTP server IP address or SMTP server name.
serverport=	SMTP server port number.
authentication=	SMTP server authentication.
	no
	yes
username=	Username if using SMTP authentication.
password=	Password if using SMTP authentication.
senderaddr=	Sender's email address.
subject=	Email subject.

webservers settings

sessiontimeout=	Session time out in minutes. Maximum 1440.
-----------------	--------------------------------------------

ssh settings

port=	Port number for ssh daemon.
sessiontimeout=	Session time out in minutes. Maximum 1440.
maxconnection=	Max number of ssh client connection. Maximum 4.

snmp settings

port=	IPv4 Port number.
port6=	IPv6 Port number.
sysname=	System name string.
syslocation=	System location string.
syscontact=	System contact information string.
readcommunity=	IPv4 Read community name.
readcommunity6=	IPv6 Read community name.
-p "<option>=<value>"	Used to specify trap sinks for snmp or public key for ssh. Multiple -p option can be entered with -a add option for trap sink.
trapsinkserver=	Trap sink IP address or trap sink server name. For snmp only.
trapfilter=	Trap filter level. It implies the level and above. For snmp only.
info	
warning	
minor	
major	
critical	
fatal	
filename=	Ssh public key file name. For ssh only.
server=	TFTP server IP address or server name. For ssh only.
comment=	Ssh public key comment. For ssh only.

Examples

```
swmgt
swmgt -n webserver
swmgt -a start -n snmp
swmgt -a stop -n snmp
swmgt -a mod -n snmp -t automatic
swmgt -a add -n ssh -p "filename=key.pub, server=192.168.1.1, comment=root@server"
swmgt -a del -n ssh -i 1
```

For adding multiple trapsinkserver (SNMP):

```
swmgt -a add -n snmp -p "trapsinkserver=192.168.1.1,trapfilter=info"
    -p "trapsinkserver=192.168.2.1,trapfilter=critical"
```

sync

Usage

```
sync [-l <Pool Id>]
```

Summary

This command allows the user to check the status of background synchronization.

Options

- | | |
|--------------|-------------------------------------------------------------|
| -a <action> | Which action to perform. |
| list | (Default) Displays the current active and their status(es). |
| -l <Pool ID> | Specifies which Pool to perform sync action on. |

Examples

```
sync
```

topology

Usage

topology [-a <action>] [-v]

Summary

View enclosures topology, the physical connections and devices. For products that support multiple enclosures only.

Options

-a <action>	Which action to perform.
list	(Default) Displays topology information.
-v	View complete information about topology.

Examples

```
topology
```

transit

Usage

```
transit [-a <action>] [-l <PoolId>] [-s <SeqNo>]
```

```
transit -a start -l <PoolId> -s <SeqNo> -p <PId>
```

```
transit -a stop -l <PoolId> -s <SeqNo>
```

```
transit -a pause -l <PoolId> -s <SeqNo>
```

```
transit -a resume -l <PoolId> -s <SeqNo>
```

Summary

This command allows the user to start, stop, pause or resume a transition as well as to check on the progress of a running transition.

Transition is an operation to replace an used revertible spare in the pool with an appropriate physical drive, which is called the destination drive. The destination drive can be an unconfigured drive, a non-revertible global spare, or a non-revertible dedicated spare to the pool.

During transition, the data on the revertible spare is transferred to the destination drive while IO is going on.

After transition, the destination drive becomes the part of the pool; the revertible spare becomes available for later use.

Options

-a <action>	Specifies the action to perform.
list	(Default) Displays the running and paused transitions and their
start	Starts a manual transition.
stop	Stops a transition.
pause	Pauses a transition.
resume	Resumes a paused transition.
-l <pool ID>	Specifies the pool id, which contains the revertible spare.
-s <sequence Num>	Specifies the sequence number of the used revertible spare in the pool.
-p <PD ID>	Specifies the physical drive ID of the destination drive.

Examples

```
transit
```

```
transit -a start -l 0 -s 2 -p 10
```

```
transit -a stop -l 0 -s 2
```

trunk

Usage

```
trunk [-a <action>] [-i <trunk id>]
```

```
trunk -a add -s "<list of settings>"
```

Summary

The trunk command is used to display and modify port trunk settings for the iSCSI host interface.

Options

-a <action>	Specifies the action to perform.
add	Create a new trunk.
list	Displays trunk information.
mod	Modify an existing trunk setting.
del	Delete a trunk.
-i [<trunk id>]	Port trunk identifier. (1 - 8).
-s ["<option>=<value>"]	Used to specify which trunk settings to change.
ctrlid=	Controller ID of Port
masterport=	Master port of the Trunk. Range: Port ID
slaveport=	List of ports aggregated in this trunk, excluding the master port
Range:	Port ID.
trunktype=	trunk type
balance_xor	Transmits based on XOR formula. (Source MAC address is XOR'd with destination MAC address) modula slave count. This selects the same slave for each destination MAC address and provides load balancing and fault tolerance.
lacp	This mode is known as Dynamic Link Aggregation mode. It creates aggregation groups that share the same speed and duplex settings. This mode requires a switch that supports IEEE 802.3ad Dynamic link.

`active_standby` Only one slave in the bond is active. A different slave becomes active if, and only if, the active slave fails.

This mode provides fault tolerance.

`porttype =` The port type used to create trunk.

`io`

`mgmt`

Examples

```
trunk -a add -s"ctrlid=1, masterport=2, slaveport=3 4"
```

```
trunk -a del -i 2
```

ups

Usage

ups [-a <action>]

ups -a list [-v]

ups -a mod -s "<list of settings>"

Summary

The ups command allows a user to view and modify ups status and settings.

Network UPS is supported for IPv4 protocol only.

Options

-a <action>	Which action to perform.
list	(Default) Displays all current UPS status.
mod	Change the settings for UPS.
-s "<option>=<value>"	Used to specify what options to change.
detection=	Detection mode setting
auto	(Default. Whenever a UPS is detected, it changes the detection mode to "enable".)
enable	(Monitors UPS, UPS Settings changes, reports warnings and logs events.)
disable	(Monitors Serial UPS only.)
ups1=	UPS1 IP address or Domain Name.
ups2=	UPS2 IP address or Domain Name.
rtr=	Running time remaining threshold in minute. The valid value range is 3~20.
-v	Verbose mode. Used with -a list.

Examples

```
ups -v
```

```
ups -a mod -s "ups1=192.168.1.1, rtr=5"
```

user

Usage

```
user [-a <action>] [-u <username>]
```

```
user -a add -u <username> -p <privilege> [-s “<list of settings>”]
```

```
user -a mod -u <username> [-p <privilege>] [-s “<list of settings>”]
```

```
user -a del -u <username> [-t <type>]
```

Summary

The user command allows a user to view and modify an existing user account.

Both management user and SNMP user are supported.

For management, only a Superuser can create, modify, or delete a user account.

User access levels are: Superuser, Poweruser, Maintenance, and View.

If a password is not specified when the user account is created, there will be no password when you log in.

Maximum password length is 31 characters, no spaces.

For SNMP user, only permission READ_ONLY is supported now.

The minimum length of password is 8 characters.

Maximum password length is 31 characters, no spaces.

Use the password command to change a password.

Options

-a <action>	Which action to perform.
list	(Default) Displays the current users.
add	Create a new user.
mod	Modify an existing user.
del	Delete a user.
refresh	Refresh the NAS domain user. Only applicable for NAS domain user.

-t <usertype>	Specifies the type of user.
mgmt	(Default) Management user.
snmp	SNMP user, who can only view subsystem settings through SNMP.
nas	Nas user.
-u <username>	Specifies the username to display, edit or delete. Maximum username length is 25 characters, no spaces.
-p <privilege>	Specifies the privilege level to set for the user. Management user only.
super	Superuser has max control
power	Poweruser cannot modify users nor delete configs
maintenance	Maintenance user can only perform background tasks
view	View user can only view.
-f	Force delete a user.
-s "<option>=<value>"	
name=	Specifies the user's display full name.
email=	Specifies an email address for the user.
Management user settings:	
status=	Enable/disable this user's account. Default is enable.
SNMP user settings:	To provide a secure environment, following authentication and privacy protocols are available. A password is required for each protocol.

auth=	Specifies the authentication protocol.
md5	Using MD5 authentication protocol.
sha	Using SHA authentication protocol.
priv=	Specifies the privacy protocol. Only when authentication is set, can this be set.
des	Using CBC-DES privacy protocol.
aes	Using CFB-AES-128 privacy protocol.
NAS user settings:	
group=	Specifies the primary group name which the user belongs to.
department	User department.
phone	User phone.
-v	Verbose mode. Used with -a list.

Examples

```
user
user -a add -u newuser -p view -s "name=NewUser,email=MyEmail@yourcompany.com"
Input password: *****
Retype password: *****
user -a add -t snmp -u snmpuser -s "auth=md5,priv=des"
Input auth password: *****
Retype auth password: *****
Input priv password: *****
Retype priv password: *****
user -a add -t nas -u nasuser -s "email=aa@123.com"
Input password: *****
Retype password: *****
```

CONTACTING TECHNICAL SUPPORT

PROMISE Technical Support provides several support options for PROMISE users to access information and updates. We encourage you to use one of our electronic services, which provide product information updates for the most efficient service and support.

PROMISE E-Support: <https://support.promise.com>

PROMISE web site: <http://www.promise.com//>

When you contact us, please have the following information available:

- Product model and serial number
- Firmware version
- A description of the problem / situation
- System configuration information, including: motherboard and CPU type

Please refer to “Export Service Report” on page 130 to create a service report with the needed information.

United States

580 Cottonwood Drive

Milpitas, Ca 95035, USA

Technical Support (E-Support): <https://support.promise.com>

Web site: <http://www.promise.com/>

Australia

Technical Support (E-Support): <https://support.promise.com>

Web site: <http://www.promise.com/>

EMEA

Netherlands

Science Park Eindhoven 5228

5692 EG Son, The Netherlands

Technical Support (E-Support): <https://support.promise.com>

Web site: <http://www.promise.com/>

Austria

Technical Support (E-Support): <https://support.promise.com>

Web site: <http://www.promise.com/>

France

Technical Support (E-Support): <https://support.promise.com>

Web site: <http://www.promise.com/>

Germany

Europaplatz 9

44269 Dortmund, Germany

Technical Support (E-Support): <https://support.promise.com>

Web site: <http://www.promise.com/>

Sweden

Technical Support (E-Support): <https://support.promise.com>

Web site: <http://www.promise.com//>

Switzerland ITF

Technical Support (E-Support): <https://support.promise.com>

Web site: <http://www.promise.com//>

Norway ITF

Technical Support (E-Support): <https://support.promise.com>

Web site: <http://www.promise.com//>

Belgium

Technical Support (E-Support): <https://support.promise.com>

Web site: <http://www.promise.com//>

Luxembourg

Technical Support (E-Support): <https://support.promise.com>

Web site: <http://www.promise.com//>

United Kingdom

Technical Support (E-Support): <https://support.promise.com>

Web site: <http://www.promise.com//>

Taiwan

Technical Support (E-Support): <https://support.promise.com>

Web site: <http://www.promise.com//>

China

Room 1108, West Wing, Shi Chuang Plaza, 22 Information Road

Shangdi IT Park, Haidian District, Beijing 100085

Fax: 86-10-8857-8015

Technical Support (E-Support): <https://support.promise.com>

Web site: <http://www.promise.com//>

Korea

Technical Support (E-Support): <https://support.promise.com>

Web site: <http://www.promise.com/>

Hong Kong

Technical Support (E-Support): <https://support.promise.com>

Web site: <http://www.promise.com/>

Singapore

Technical Support (E-Support): <https://support.promise.com>

Web site: <http://www.promise.com/>

Japan

3F, Mura Matsu Bldg, 3-8-5, Hongo Bunkyo-ku

Tokyo 113-0033, Japan

Technical Support (E-Support): <https://support.promise.com>

Web site: <http://www.promise.com/>

Limited Warranty

PROMISE Technology, Inc. ("PROMISE") warrants that this product, from the time of the delivery of the product to the original end user:

- a) all components, except the cache backup battery, for a period of three (3) years;
- b) the cache backup battery, for a period of one (1) year;
- c) will conform to PROMISE's specifications;
- d) will be free from defects in material and workmanship under normal use and service.

This warranty:

- a) applies only to products which are new and in cartons on the date of purchase;
- b) is not transferable;
- c) is valid only when accompanied by a copy of the original purchase invoice.
- d) Is not valid on spare parts.

This warranty shall not apply to defects resulting from:

- a) improper or inadequate maintenance, or unauthorized modification(s), performed by the end user;
- b) operation outside the environmental specifications for the product;
- c) accident, misuse, negligence, misapplication, abuse, natural or personal disaster, or maintenance by anyone other than a PROMISE or a PROMISE-authorized service center.

Disclaimer of other warranties

This warranty covers only parts and labor, and excludes coverage on software items as expressly set above.

Except as expressly set forth above, PROMISE disclaims any warranties, expressed or implied, by statute or otherwise, regarding the product, including, without limitation, any warranties for fitness for any purpose, quality, merchantability, non-infringement, or otherwise. PROMISE makes no warranty or representation concerning the suitability of any product for use with any other item. You assume full responsibility for selecting products and for ensuring that the products selected are compatible and appropriate for use with other goods with which they will be used.

PROMISE does not warrant that any product is free from errors or that it will interface without problems with your computer system. It is your responsibility to back up or otherwise save important data before installing any product and continue to back up your important data regularly.

No other document, statement or representation may be relied on to vary the terms of this limited warranty.

PROMISE's sole responsibility with respect to any product is to do one of the following:

- a) replace the product with a conforming unit of the same or superior product;
- b) repair the product.

PROMISE shall not be liable for the cost of procuring substitute goods, services, lost profits, unrealized savings, equipment damage, costs of recovering, reprogramming, or reproducing of programs or data stored in or used with the products, or for any other general, special, consequential, indirect, incidental, or punitive damages, whether in contract, tort, or otherwise, notwithstanding the failure of the essential purpose of the foregoing remedy and regardless of whether PROMISE has been advised of the possibility of such damages. PROMISE is not an insurer. If you desire insurance against such damage, you must obtain insurance from another party.

Some states do not allow the exclusion or limitation of incidental or consequential damages for consumer products, so the above limitation may not apply to you.

This warranty gives specific legal rights, and you may also have other rights that vary from state to state. This limited warranty is governed by the State of California.

Your Responsibilities

You are responsible for determining whether the product is appropriate for your use and will interface with your equipment without malfunction or damage. You are also responsible for backing up your data before installing any product and for regularly backing up your data after installing the product. PROMISE is not liable for any damage to equipment or data loss resulting from the use of any product.

Returning the Product For Repair

If you suspect a product is not working properly, or if you have any questions about your product, contact our Technical Support staff, and be ready to provide the following information:

- Product model and serial number (required)
- Return shipping address
- Daytime phone number
- Description of the problem
- Copy of the original purchase invoice

The technician helps you determine whether the product requires repair. If the product needs repair, the technician issues an RMA (Return Merchandise Authorization) number.

Important

Obtain an RMA number from Technical Support **before** you return the product and write the RMA number on the label. The RMA number is essential for tracking your product and providing the proper service.

Return **ONLY** the specific product covered by the warranty. Do not ship cables, manuals, CDs, etc.

USA and
Canada: PROMISE Technology, Inc.
Customer Service Dept.
Attn.: RMA # _____
47654 Kato Road
Fremont, CA 94538

Other
Countries: Return the product to your dealer or retailer.
Contact them for instructions before shipping the product.

You must follow the packaging guidelines for returning products:

- Use the original shipping carton and packaging
- Include a summary of the product's problem(s)
- Write an attention line on the box with the RMA number
- Include a copy of your proof of purchase

You are responsible for the cost of insurance and shipment of the product to PROMISE. Note that damage incurred due to improper transport or packaging is not covered under the Limited Warranty.

When repairing returned product(s), PROMISE may replace defective parts with new or reconditioned parts, or replace the entire unit with a new or reconditioned unit. In the event of a replacement, the replacement unit is under warranty for the remainder of the original warranty term from purchase date, or 30 days, whichever is longer.

PROMISE pays for standard return shipping charges only. You must pay for any additional shipping options, such as express shipping.

Information for China RoHS



部件名稱 Products Description	Toxic or Hazardous Substances					
	鉛 (Pb)	汞 (Hg)	鎘 (Cd)	六價鉻 (Cr6+)	多溴聯苯 (PBB)	多溴二苯醚 (PBDE)
PCBA	X	○	○	○	○	○
Metal parts	X	○	○	○	○	○
Plastic parts	○	○	○	○	○	○
Cable	○	○	○	○	○	○
Power Supply	X	○	○	○	○	○
Battery	X	○	○	○	○	○
Package	○	○	○	○	○	○

本表格依據 SJ/T 11364 的規定編制。
This table is prepared in accordance with the provisions of SJ/T 11364.
○：表示該有害物質在該部件所有均質材料中的含量均在 GB/T 26572 規定的限量要求以下。
○: Indicates that said hazardous substance contained in all of the homogeneous materials for this part is under the limitation requirement of GB/T 26572.
X：表示該有害物質至少在該部件的某一均質材料中的含量超出 GB/T 26572 規定的限量要求。
X: Indicates that said hazardous substance contained in at least one of the homogeneous materials used for this part is above the limit requirement of GB/T 26572.
此產品符合 EU RoHS 指令 2011/65/EU
The product complies with EU RoHS Directive 2011/65/EU

生產日期代碼參考路徑：<http://www.promise.com/Manufacturing-Dates-of-Products>