



# Cybex™ SC Switching System

Installer/User Guide

The information contained in this document is subject to change without notice and may not be suitable for all applications. While every precaution has been taken to ensure the accuracy and completeness of this document, Vertiv assumes no responsibility and disclaims all liability for damages resulting from use of this information or for any errors or omissions. Refer to other local practices or building codes as applicable for the correct methods, tools, and materials to be used in performing procedures not specifically described in this document.

The products covered by this instruction manual are manufactured and/or sold by Vertiv. This document is the property of Vertiv and contains confidential and proprietary information owned by Vertiv. Any copying, use or disclosure of it without the written permission of Vertiv is strictly prohibited.

Names of companies and products are trademarks or registered trademarks of the respective companies. Any questions regarding usage of trademark names should be directed to the original manufacturer.

### **Technical Support Site**

If you encounter any installation or operational issues with your product, check the pertinent section of this manual to see if the issue can be resolved by following outlined procedures. Visit <https://www.VertivCo.com/en-us/support/> for additional assistance.

# TABLE OF CONTENTS

<b>1 Product Overview</b> .....	<b>1</b>
1.1 Features and Benefits .....	1
<b>2 Basic Operation</b> .....	<b>3</b>
2.0.1 Factory reset .....	3
2.1 Switch Overview .....	3
2.1.1 Switching between computers .....	9
2.1.2 Dedicated Peripheral Port (DPP) .....	10
2.1.3 KM multi-monitor support .....	10
2.2 Keyboard and Mouse Settings .....	12
2.2.1 Keyboard settings .....	12
2.2.2 Mouse settings .....	13
2.2.3 Filtered USB port (fUSB) .....	13
2.2.4 Interchangeable KVM to KM functionality .....	13
2.3 Keyboard Shortcuts .....	13
2.4 KM Configuration .....	15
2.4.1 Creating a KM configuration file .....	15
2.4.2 Loading a KM configuration file .....	21
<b>3 Troubleshooting</b> .....	<b>23</b>
3.1 General .....	23
3.2 KM Configuration File .....	23
3.3 Video .....	25
3.4 Keyboard .....	25
3.5 Mouse .....	26
3.6 DPP .....	26
<b>4 Appendices</b> .....	<b>27</b>



# 1 PRODUCT OVERVIEW

[[[Undefined variable Variables. ]]] SC switches are field-proven, secure, KVM and KM switching solutions with special support for government agencies. This switching system allows users to switch safely between computers operating at different classification levels from a single set of peripherals, providing continuous access to critical data. With multiple security features, the secure design prevents the transfer of data between the connected computers, ensuring data security is not compromised.



**WARNING! This product is equipped with active intrusion protection and tamper-evident seals. Tampering with the switch or breaking/removing the seals will permanently disable it and void the warranty. If the enclosure appears to have been tampered with or if all the port LEDs flash continuously, please contact Technical Support.**

The appliances covered in this manual include:

KM Models:

- Cybex™ SC KM 120 Secure 2-Port KM Switch
- Cybex™ SC KM 140/145 Secure 4-Port KM Switches

KVM Models:

- Cybex™ SC 820D/920D Secure 2-Port DisplayPort and HDMI KVM Switches
- Cybex™ SC 820H/920H Secure 2-Port HDMI KVM Switches
- Cybex™ SC 820DP/920DP Secure 2-Port DisplayPort KVM Switches
- Cybex™ SC 840/845/940/945 Secure 4-Port DVI-I KVM Switches
- Cybex™ SC 840D/845D/940D/945D Secure 4-Port DisplayPort and HDMI KVM Switches
- Cybex™ SC 840H/845H/940H/945H Secure 4-Port HDMI KVM Switches
- Cybex™ SC 840DP/845DP/940DP/945DP Secure 4-port DisplayPort KVM Switches
- Cybex™ SC 920XD Secure 2-Port Mixed HDMI, DisplayPort and DVI-I KVM Dual Head KVM Switch
- Cybex™ SC 945XD Secure 4-Port Mixed HDMI, DisplayPort and DVI-I KVM Dual Head KVM Switch
- Cybex™ SC 840DP/845DP/940DP/945DP Secure 4-port DisplayPort KVM Switches
- Cybex™ SC 885DP/985DP Secure 8-port DisplayPort KVM Switches

## 1.1 Features and Benefits

The SC switching system offers the following options, depending on the model:

- Support for HDMI, DVI-I, VGA and/or DisplayPort video
- Support for Common Access Card (CAC), USB biometric device and USB authentication token
- Certification to Evaluation Assurance Level (EAL) 4+
- Support for USB and PS/2 keyboard and mouse

**NOTE: Supports most keyboards and mice. For more information, contact Technical Support.**

The SC switching system is also designed to provide additional layers of security, preventing unintended data leaks between computers and providing additional USB port protection.

**Table 1.1 Security and Protection Features**

<b>FEATURE</b>	<b>DESCRIPTION</b>
Complete network segmentation	Data flow is controlled and insulated from peripheral devices using optical data diodes. EDID emulators and internal firewalls protect shared displays and prevent external memory leaks.
Protection from shared resources	The switches are designed to securely operate, even when peripheral devices are vulnerable to signaling attacks. They do not allow computer access to any shared resource and do not share controllable power sources.
Non-reprogrammable firmware	Custom firmware is not reprogrammable preventing the ability to remotely attack switch controllers.
Audio protection	Microphone switching is not supported to prevent data leaks through audio ports.
CONSOLE USB port protection	CONSOLE USB ports protect from the use of unsafe USB storage devices. Unqualified devices are rejected when connected through the switch even though keyboard and mouse data is passed through.

## 2 BASIC OPERATION

Although installation of your SC switching system is complete, ensure you have one of the following compatible operating systems:

- Microsoft® Windows®
- Red Hat®, Ubuntu® or any other Linux® platform
- Mac OS® X version 10.3 or higher

The switches are compatible with stereo headphones and amplified stereo speakers.

**NOTE: Do not connect a microphone device to the switch's audio output port. Opt to use headset devices that do not include microphone capabilities.**

Wireless devices and non-standard keyboards with integrated USB hubs and other USB-integrated devices are not fully supported for security reasons.

### 2.0.1 Factory reset

A factory reset clears the device settings and restores the device to its original configuration.

To factory reset:

Type **Ctrl + Ctrl + F11**

### 2.1 Switch Overview

The following figures and tables show the controls and connectors on the front panel and connectors on the back of the switching systems covered in this manual.

Figure 2.1 KVM Model (SC 945 Switch Shown)

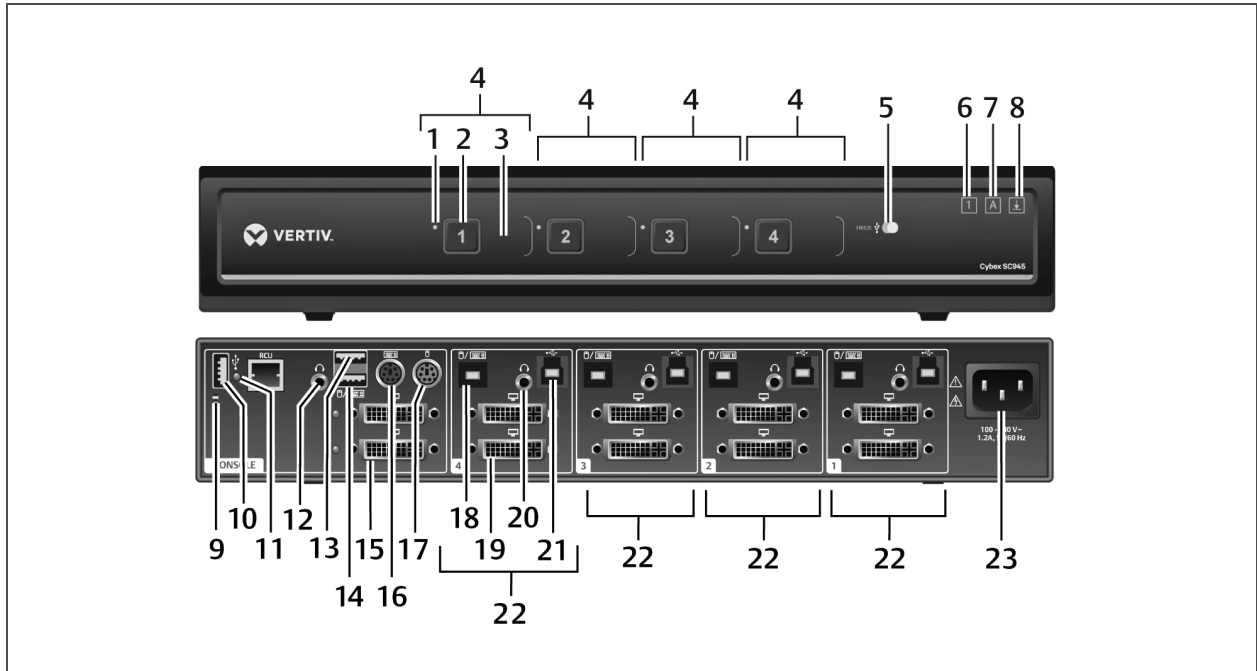

Table 2.1 KVM SC 945 Switch Description

ITEM	DESCRIPTION	ITEM	DESCRIPTION
1	LED channel indicator	13	CONSOLE high-speed USB Type-A port
2	Channel selector	14	CONSOLE full-speed USB Type-A port
3	Channel label	15	CONSOLE female video port (varies with model: DVI-I, HDMI or DisplayPort)
4	Channel configuration	16	Keyboard PS/2 mini-DIN 6-pin female port
5	Dedicated Peripheral Port (DPP) freeze button and LED	17	Mouse PS/2 mini-DIN 6-pin female port
6	Num lock indicator*	18	Keyboard and mouse USB Type-B port
7	Caps lock indicator*	19	Varies with model (DVI-I, HDMI or DisplayPort)
8	Scroll lock indicator*	20	Audio jack (3.5 mm stereo)
9	CONSOLE system reset	21	DPP USB Type-B port (CAC support: only available on some models)
10	CONSOLE DPP USB Type-A port (CAC support: only available on some models)	22	Channel configuration
11	DPP LED indicator: <ul style="list-style-type: none"> <li>Green: Functioning</li> <li>Flashing green: Rejected device (not authorized)</li> <li>None: Device not operating, non-standard USB device or device only operating in USB 3 mode</li> </ul>	23	AC input (100-200 VAC)
12	CONSOLE audio jack (3.5 mm stereo)		

\* When these LED indicators are lit, they reflect the status of the keyboard functions on the active channel.



Figure 2.2 KM Model (SC KM145 Switch Shown)

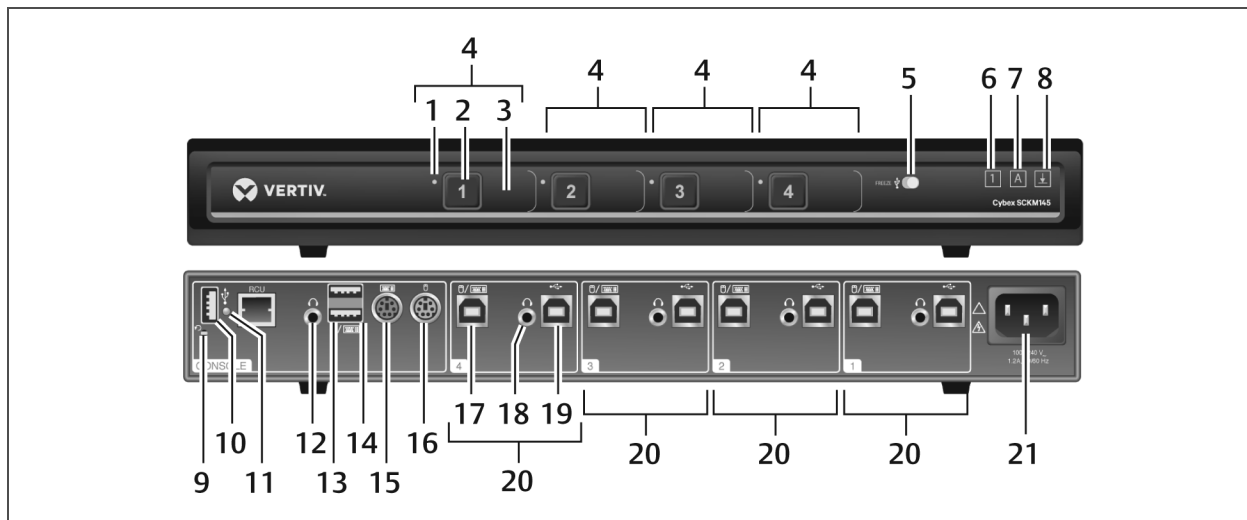

Table 2.2 KM SC KM145 Switch Description

ITEM	DESCRIPTION	ITEM	DESCRIPTION
1	LED channel indicator	12	CONSOLE audio jack (3.5 mm stereo)
2	Channel selector	13	CONSOLE keyboard and mouse full-speed USB Type-A ports
3	Channel label	14	CONSOLE keyboard and mouse high-speed USB Type-A ports
4	Channel configuration	15	Keyboard PS/2 mini-DIN 6-pin female port
5	Dedicated Peripheral Port (DPP) freeze button and LED	16	Mouse PS/2 mini-DIN 6-pin female port
6	Num lock indicator*	17	Keyboard and mouse USB Type-B port
7	Caps lock indicator*	18	Audio jack (3.5 mm stereo)
8	Scroll lock indicator*	19	DPP USB Type-B port (CAC support: only available on some models)
9	CONSOLE system reset	20	Channel configuration
10	CONSOLE DPP USB Type-A port (CAC support: only available on some models)	21	AC input (100-200 VAC)
11	DPP LED indicator: <ul style="list-style-type: none"> <li>Green: Functioning</li> <li>Flashing green: Rejected device (not authorized)</li> <li>None: Device not operating, non-standard USB device or device only operating in USB 3 mode</li> </ul>		

\* When these LED indicators are lit, they reflect the status of the keyboard functions on the active channel.

Figure 2.3 KM Model (SC KM120 Switch Shown)

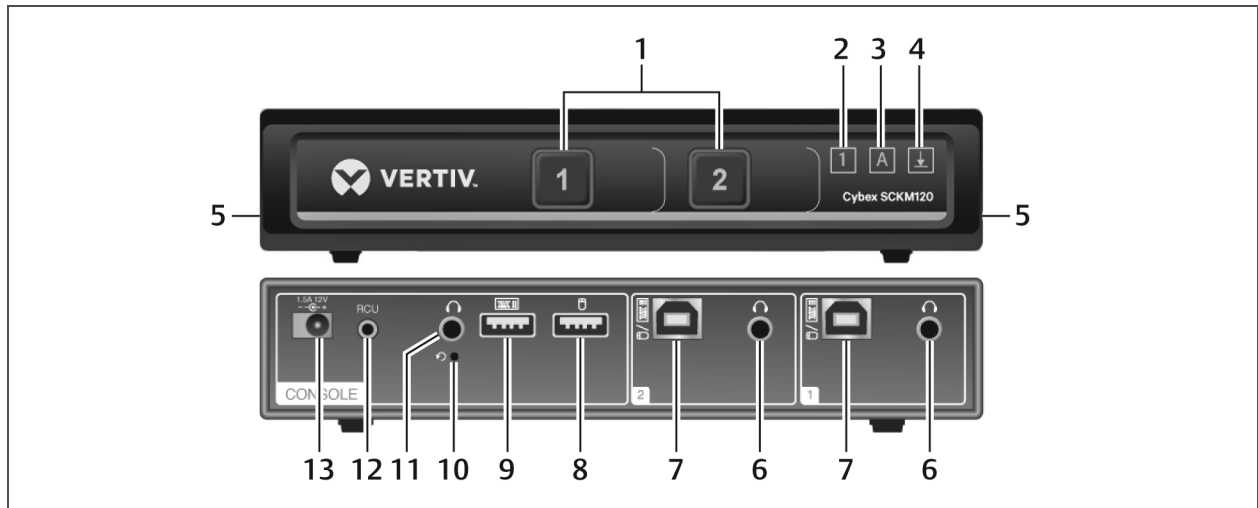

Table 2.3 KM SC KM120 Switch Description

ITEM	DESCRIPTION	ITEM	DESCRIPTION
1	LED channel select button	8	CONSOLE mouse USB Type-A port
2	Num lock indicator*	9	CONSOLE keyboard USB Type-A port
3	Caps lock indicator*	10	CONSOLE Restore to factory default button
4	Scroll lock indicator*	11	CONSOLE audio jack (3.5 mm stereo)
5	Holographic tamper-evident labels	12	Remote Control Unit (RCU) port
6	Audio jack (3.5 mm stereo)	13	DC power supply
7	Keyboard and mouse USB Type-B port		

**NOTE: The RCU port on the back panel is currently inoperable and is reserved for future use.**

\* When these LED indicators are lit, they reflect the status of the keyboard functions on the active channel.

The SC 820 models are single-head devices. They have identical ports, except for the number of ports on the device. The SC 920 models (as shown in the following figure) are dual-head devices. The SC 920D and SC 920H models are identical except for the DP and HDMI video ports, respectively.

Figure 2.4 SC Model (SC920 KVM Switch Shown)

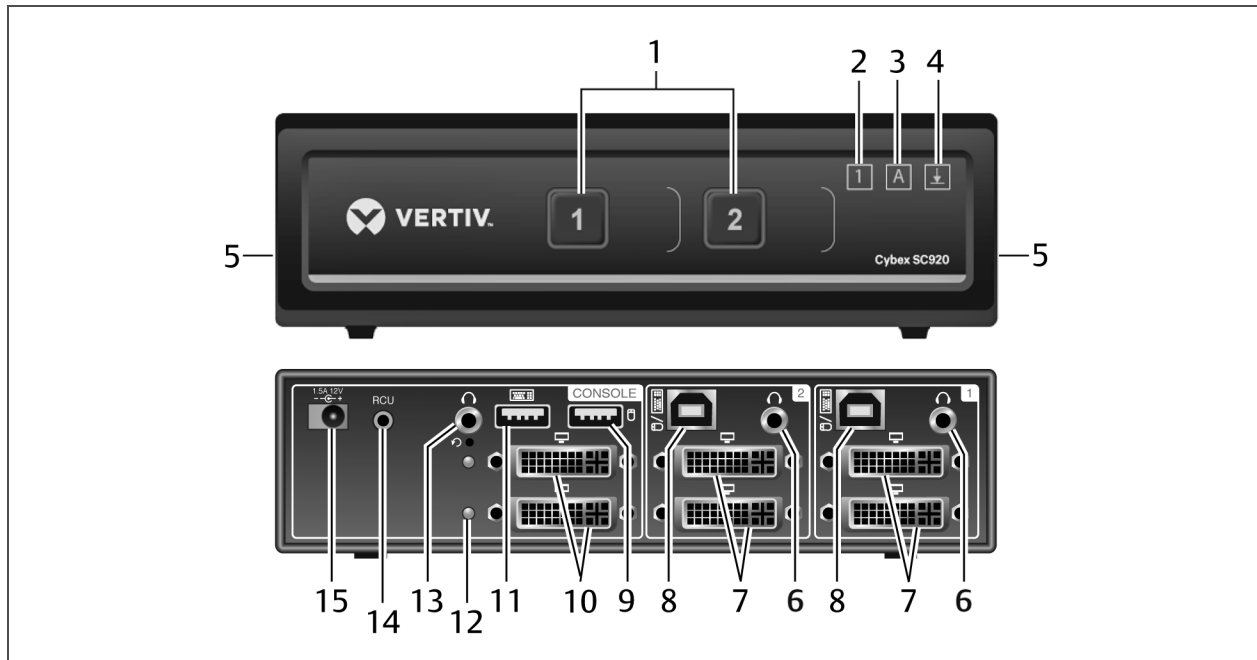

Table 2.4 SC 920 KVM Switch Description

ITEM	DESCRIPTION	ITEM	DESCRIPTION
1	LED channel select button	9	CONSOLE mouse USB Type-A port
2	Num lock indicator	10	CONSOLE DisplayPort video input port
3	Caps lock indicator	11	CONSOLE keyboard USB Type-A port
4	Scroll lock indicator	12	Status LED
5	Holographic tamper-evident labels	13	CONSOLE audio input jack (3.5 mm stereo)
6	Audio jack (3.5 mm stereo)	14	Remote Control Unit (RCU) port
7	DisplayPort video port		<b>NOTE: The RCU port on the back panel is currently inoperable and is reserved for future use.</b>
8	Keyboard and mouse USB Type-B port	15	DC Power Supply

\* When these LED indicators are lit, they reflect the status of the keyboard functions on the active channel.

Figure 2.5 KVM Model (SC 920XP Switch Shown)

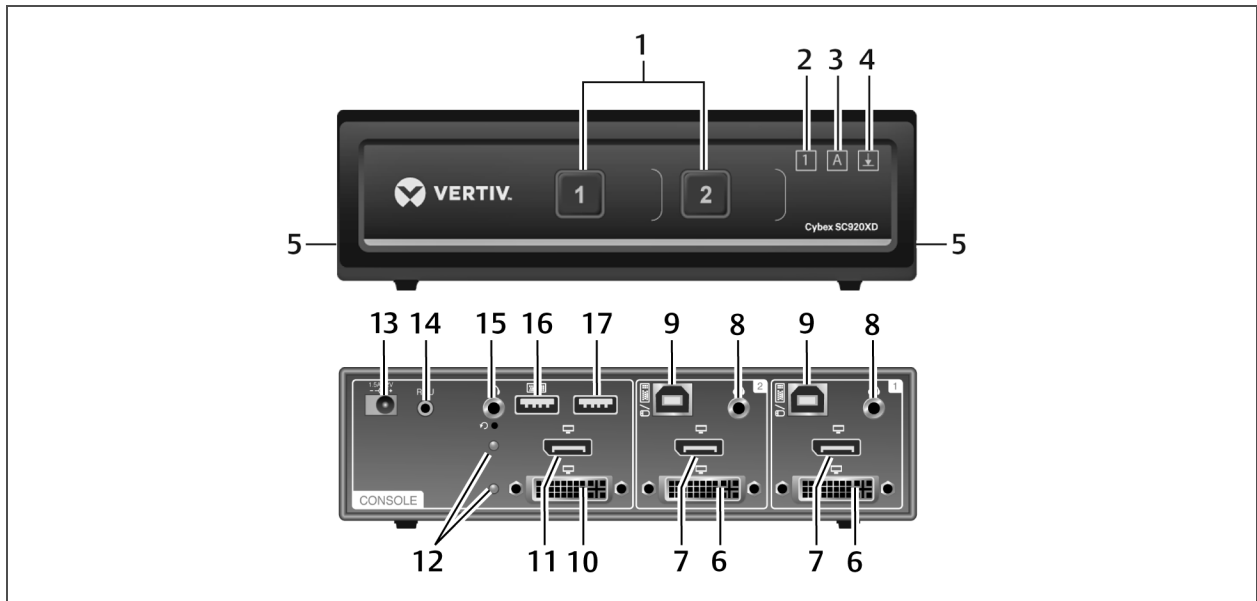

Table 2.5 SC 920XP Switch Description

ITEM	DESCRIPTION	ITEM	DESCRIPTION
1	LED channel select button	10	CONSOLE HDMI video input port
2	Num lock LED	11	CONSOLE DVI-I video input port
3	Caps lock LED	12	Status LEDs
4	Scroll lock LED	13	DC power supply
5	Holographic tamper evident labels	14	Remote Control Unit (RCU) port
6	DVI-I video port	15	CONSOLE audio input jack (3.5 mm stereo)
7	HDMI video port	16	CONSOLE keyboard USB Type-A port
8	Audio jack (3.5 mm stereo)	17	CONSOLE mouse USB Type-A port
9	USB Type-B port for keyboard and mouse		

Figure 2.6 KVM Model (SC 945XP Switch Shown)

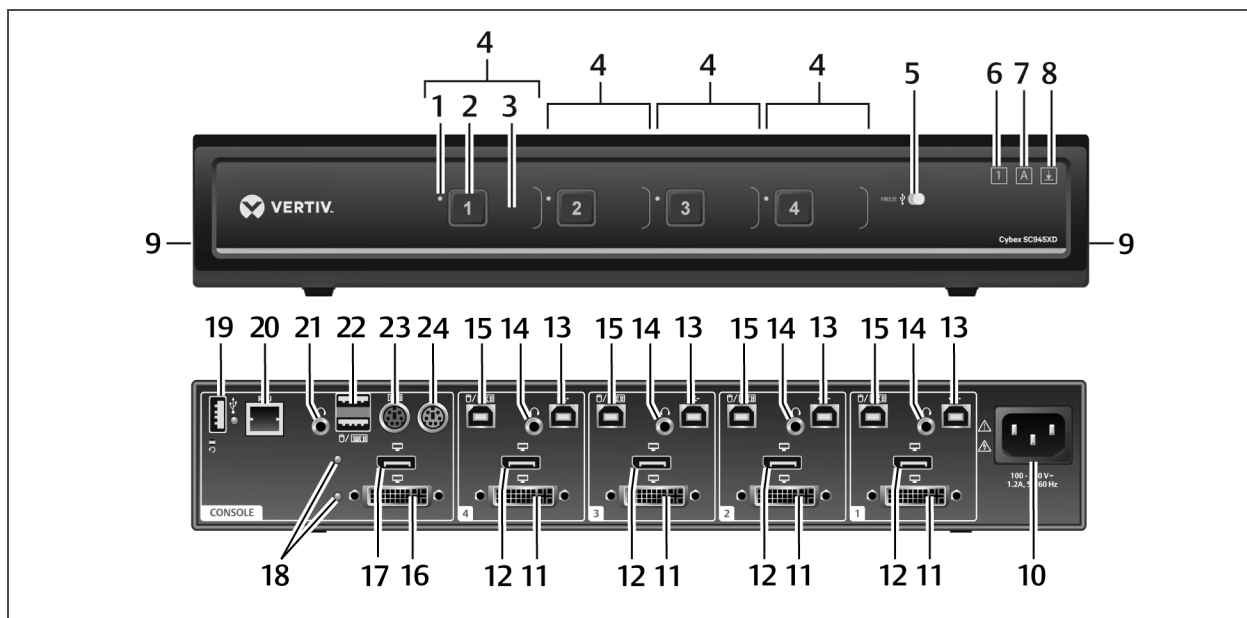

Table 2.6 SC 945XD Switch Description

ITEM	DESCRIPTION	ITEM	DESCRIPTION
1	LED channel indicator	13	USB Type-B port for computer
2	Channel selector	14	Audio jack (3.5 mm stereo)
3	Channel label	15	USB Type-B port for keyboard and mouse
4	Channel configuration	16	CONSOLE DVI-I video input port
5	Dedicated Peripheral Port (DPP) freeze button and LED	17	CONSOLE DisplayPort video input port
6	Num lock LED	18	Status LEDs
7	Caps lock LED	19	USB Type-A port for DPP and DPP status LED
8	Scroll lock LED	20	Remote Control Unit (RCU) port
9	Holographic tamper evident labels	21	CONSOLE audio input jack (3.5 mm stereo)
10	AC power cable jack	22	CONSOLE keyboard and mouse USB Type-A ports
11	DisplayPort video port	23	Keyboard PS/2 mini-DIN 6-pin female port
12	HDMI video port	24	Mouse PS/2 mini-DIN 6-pin female port

## 2.1.1 Switching between computers

After turning on the switch, the default channel is channel one. You can select which computer to operate using the front panel push-buttons. The LED number illuminates to indicate which computer is currently selected. Allow approximately one second for the video signal to sync after switching computers.

After selecting a new channel, the mouse cursor is positioned in the center of the selected computer display. When you select a new channel, the mapping for the keyboard, mouse, audio and USB device also changes to the specified channel.

To switch between computers:

Select the computer by pressing the corresponding front panel push-button on the front of the switch.

## 2.1.2 Dedicated Peripheral Port (DPP)

The DPP feature allows secure use of authentication devices such as a CAC or smartcard reader. See the Vertiv Cybex™ SC/SCM Switching System Additional Operations and Configuration Technical Bulletin for detailed DPP configuration procedures.

The host detection function of the DPP enables you to switch between ports without disconnecting the user authentication session, known as DPP freeze. When locked, switching channels does not affect processes performed by the USB device connected to the locked channel. If only one computer is using the DPP function, ensure that it is connected to channel 1.

The DPP status LED is illuminated after a qualified USB device is connected to the switch and ready for use. If the USB device is not qualified or is rejected from the switch's DPP port, the DPP status LED flashes and the USB device is inoperable. If the USB device is not detected by the port, the DPP status LED does not illuminate and the USB device is inoperable.

**NOTE: Do not connect a cable to the DPP if an authentication device is not needed. The switch will automatically detect a cable and attempt to program the DPP selection logic. If you are connecting to the DPP, your device must be fully compliant with a standard USB 1.1 or USB 2.0 and turned on.**

### Using DPP freeze

If you need to retain authentication information on one channel after switching to another, you can freeze the DPP of the first channel.

To freeze the DPP channel:

1. Select the DPP channel you want to freeze.
2. On the front panel, enable the DPP freeze button and verify the channel indicator illuminates on the selected channel and on the freeze button.

**NOTE: If you are on a channel that has a DPP enabled and you switch to a channel that is not using a DPP, then you will lose the connection and the ability to freeze the information. You must switch back to a DPP-enabled channel to reactivate the feature.**

## 2.1.3 KM multi-monitor support

The switches are configured to support one monitor per channel. The switch configuration must match the physical positioning of the display units. When configuring the switch, you can select from the setup presets or you can create a custom configuration file. To create a configuration file, see [KM Configuration](#) on page 15.

When Virtual Display Technology (VDT) switching is enabled, you can set up a multiple monitor configuration and seamlessly switch between displays by moving the mouse cursor to the desired display.

To use the multiple monitor feature, you must download and install the KM Multi-Monitor Driver from the Software Downloads section on the Vertiv website on each of the applicable computers.

### VDT switching

By default, the switch is configured to use the relative mouse setting, which confines mouse cursor movement to the screen of the selected computer. With this setting, you must use the front panel channel selection buttons to switch between computers.

Alternatively, the switch can be configured to use the absolute mouse setting, which allows you to move between isolated computer systems by moving the mouse cursor across display borders. When the mouse cursor scrolls beyond the screen border from one computer to another, the keyboard, mouse, audio and USB device mapping switch accordingly. You can enable the absolute or relative mouse settings by pressing a keyboard shortcut on the connected keyboard. See [Keyboard Shortcuts](#) on page 13 for a list of the keystroke combinations.

You can use the preset keys to configure the KM to support more than one monitor per channel. The following images detail the different preset monitor configurations.

**NOTE:** In the configurations, gray indicates a single computer and black indicates a multi-monitor display. P indicates the primary display and S indicates the secondary display in a multi-monitor display configuration.

Figure 2.7 Two-Port KM Presets

F11 F1	<b>1</b> <b>2</b>	F11 F9	<b>1P</b> <b>1S</b> <b>2P</b> <b>2S</b>	F11 1 7	<b>1</b> <b>2P</b> <b>2S</b>
F11 F2	<b>1</b> <b>2</b>	F11 F10	<b>1</b> <b>2P</b> <b>2S</b>	F11 1 8	<b>1</b> <b>2S</b> <b>2S</b> <b>2P</b> <b>2S</b>
F11 F3	<b>1P</b> <b>1S</b> <b>2P</b> <b>2S</b>	F11 1 1	<b>1P</b> <b>1S</b> <b>2</b>	F11 1 9	<b>1</b> <b>2P</b> <b>2S</b> <b>2S</b> <b>2S</b>
F11 F4	<b>1P</b> <b>2P</b> <b>1S</b> <b>2S</b>	F11 1 2	<b>1</b> <b>2P</b> <b>2S</b>	F11 1 0	<b>1P</b> <b>1S</b> <b>2P</b> <b>2S</b> <b>2S</b> <b>2S</b>
F11 F5	<b>1</b> <b>2P</b> <b>2S</b>	F11 1 3	<b>1P</b> <b>2</b> <b>1S</b>	F11 2 1	<b>1P</b> <b>1S</b> <b>1S</b> <b>1S</b> <b>2P</b> <b>2S</b>
F11 F6	<b>1P</b> <b>1S</b> <b>2</b>	F11 1 4	<b>1</b> <b>2P</b> <b>1P</b> <b>1S</b> <b>2S</b>	F11 2 2	<b>1P</b> <b>1S</b> <b>1S</b> <b>1S</b> <b>2</b>
F11 F7	<b>1P</b> <b>1S</b> <b>1S</b> <b>2</b>	F11 1 5	<b>1</b> <b>2P</b> <b>2S</b>	F11 2 3	<b>1P</b> <b>1S</b> <b>2</b> <b>1S</b> <b>1S</b>
F11 F8	<b>1</b> <b>2P</b> <b>2S</b> <b>2S</b>	F11 1 6	<b>1P</b> <b>1S</b> <b>2</b>	F11 2 4	<b>1P</b> <b>1S</b> <b>1S</b> <b>2P</b> <b>2S</b> <b>1S</b>

Figure 2.8 Four-Port KM Presets

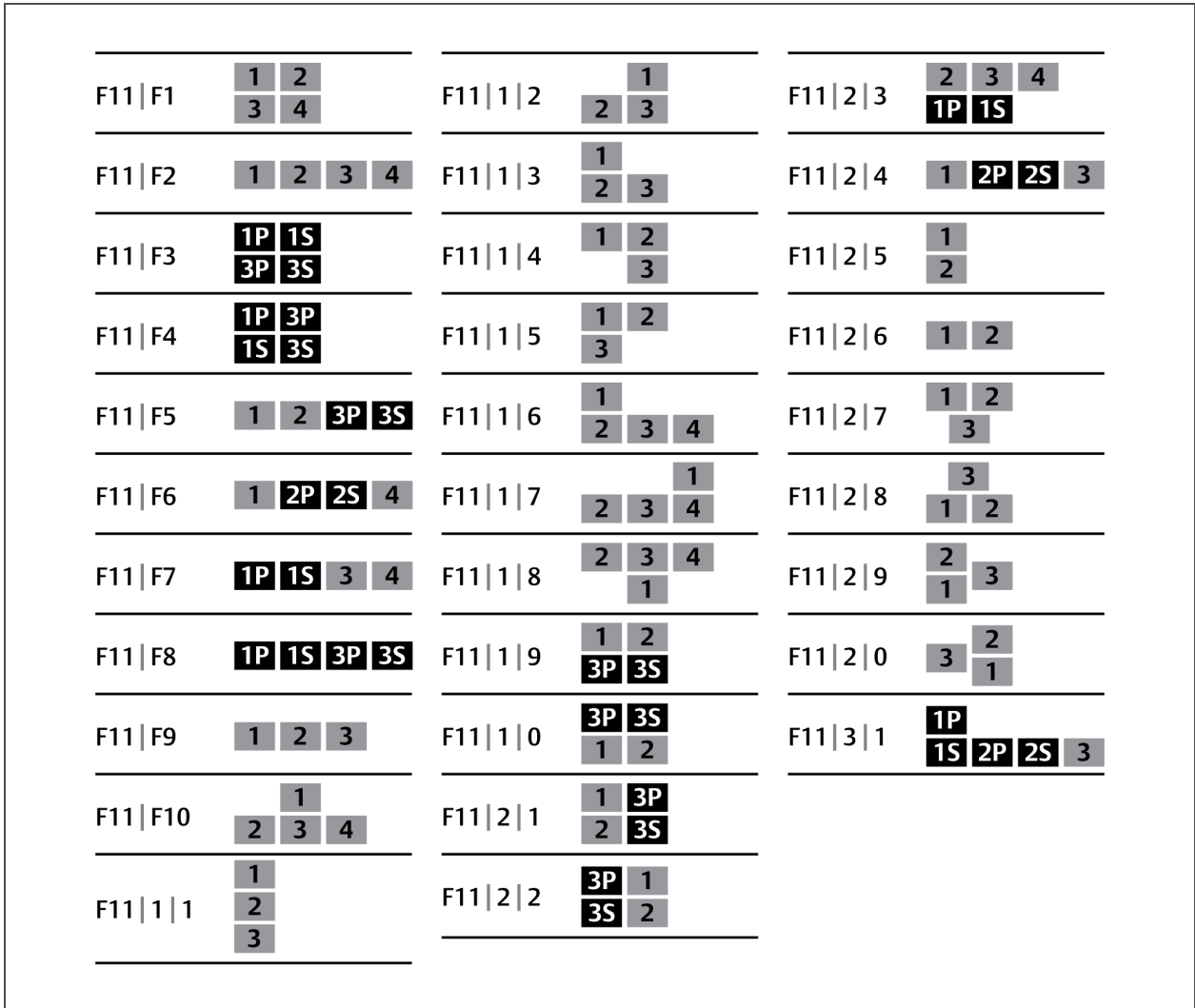

## 2.2 Keyboard and Mouse Settings

### 2.2.1 Keyboard settings

All secure switches block communication from the computers to the keyboard to prevent potential data leaks. You can enable Caps Lock, Scroll Lock or Num Lock from a connected keyboard; however, the connected keyboard status indicators do not illuminate to indicate the settings are enabled. The Caps lock, Scroll lock and Num lock LEDs on the switch illuminate to indicate the settings are enabled on a specific channel. Switching channels changes the status of the LEDs if different settings are enabled on each computer.



## 2.2.2 Mouse settings

When VDT is enabled, you can freeze mouse functionality on a selected channel to prevent inadvertently switching channels if the mouse approaches the screen border. The prevent transition feature allows you to use the mouse to move objects such as windows and icons on a screen without unintentionally dragging the object to another display. When the prevent transition feature is enabled and the left mouse button is depressed, you can move objects only within the active display.

Using keyboard shortcuts, you can freeze or unfreeze the mouse on a selected channel, or increase or decrease the speed of the mouse. See [Keyboard Shortcuts](#) on page 13 for a list of the keystroke combinations.

**NOTE: The default mouse speed is set to 5 on a 1 to 10 speed scale.**

## 2.2.3 Filtered USB port (fUSB)

Some models are equipped with a filtered USB port that only accepts authorized USB devices. When an authorized USB device is connected to the fUSB port, the status LED on the front panel illuminates green. When an un-authorized USB device is connected to the fUSB console port, the status LED on the front panel illuminates red. When switching between channels, the USB device connected to the fUSB port automatically switches. When switching to a channel that has no fUSB connection, the port remains mapped to the last channel that had a fUSB channel. To assign the fUSB port to a specific computer, press the freeze USB button. Freeze USB prevents the fUSB from switching even when the keyboard, video, mouse and audio peripherals switch between computers.

## 2.2.4 Interchangeable KVM to KM functionality

In KVM mode one display, keyboard, mouse, USB and audio peripheral set is shared between all computers. In KM mode, each computer is connected to a separate display while the keyboard and mouse are shared.

To change from KVM to KM mode:

1. Disconnect the display from the KVM console port.
2. Connect each computer directly to a separate display while keeping the keyboard, mouse, USB and audio peripherals connected to the KVM.
3. Change the mouse mode by typing **L Ctrl | L Ctrl | F11 | c**.

To change from KM to KVM mode:

1. Connect the display to the KVM console port.
2. Connect each computer to the corresponding KVM computer video port.
3. Change the mouse mode by typing **L Ctrl | L Ctrl | F11 | b**.

## 2.3 Keyboard Shortcuts

Keyboard shortcuts can be used to execute switch commands, load monitor presets and adjust mouse settings. Keyboard shortcut functionality varies depending on the firmware version and the switch model.

The style for sequential or concurrent keyboard shortcuts is typically **Ctrl + Ctrl + F11**. The following table deviates from the style by eliminating the plus symbol between keystrokes. Unless otherwise noted, the key combinations should be pressed concurrently and an L preceding Ctrl indicates the left control key while an R preceding Ctrl indicates the right control key.

The following table details keyboard shortcut options.

Table 2.7 KM Keyboard Shortcuts

KEY COMBINATION	DESCRIPTION	STANDARD SWITCHES	VERSION 10020715	VERSION 10300915	VERSION 10020316 OR HIGHER	KVM	KM	MINI-MATRIX
<b>L Ctrl L Ctrl 1</b>	Switch to channel 1	Y	Y	Y	Y	Y	Y	N
<b>L Ctrl L Ctrl 2</b>	Switch to channel 2	Y	Y	Y	Y	Y	Y	N
<b>L Ctrl L Ctrl 3</b>	Switch to channel 3	Y	Y	Y	Y	Y	Y	N
<b>L Ctrl L Ctrl 4</b>	Switch to channel 4	Y	Y	Y	Y	Y	Y	N
<b>L Ctrl L Ctrl 5</b>	Switch to channel 5	Y	Y	Y	Y	Y	Y	N
<b>L Ctrl L Ctrl 6</b>	Switch to channel 6	Y	Y	Y	Y	Y	Y	N
<b>L Ctrl L Ctrl F11 B</b>	Relative mouse mode	N	N	Y	Y	Y	Y	Y
<b>L Ctrl L Ctrl F11 C</b>	Absolute mouse mode	N	N	Y	Y	Y	Y	Y
<b>L Ctrl L Ctrl F</b>	Video follow mouse (disable/enable)	N	N	Y	Y	Y	N	N
<b>L Ctrl L Ctrl F11 R</b>	System reset to factory default	N	Y	Y	Y	Y	Y	Y
<b>L Ctrl R Ctrl B</b>	Current channel DE is relative only	N	N	N	Y	Y	Y	Y
<b>L Ctrl R Ctrl C</b>	Current channel DE is default	N	N	N	Y	Y	Y	Y
<b>L Ctrl R Ctrl Q</b>	Disable/enable the copy and paste function	Y	Y	Y	Y	Y	Y	Y
<b>L Ctrl Shift<sup>1</sup></b>	Mouse will be ABS until released	N			Y	Y	Y	Y
<b>L Ctrl R Ctrl X</b>	Exit terminal mode	N	Y	Y	Y	Y	Y	Y
<b>L Ctrl R Ctrl T</b>	Enter terminal mode	N	Y	Y	Y	Y	Y	Y
<b>L Ctrl L Ctrl F11 F</b>	Disable switching by mouse	N	Y	Y	Y	Y <sup>2</sup>	Y	Y
<b>L Ctrl L Ctrl F11 U</b>	Enable switching by mouse	N	Y	Y	Y	Y <sup>2</sup>	Y	Y
<b>L Ctrl L Ctrl F11 +</b>	Increase mouse speed	N	Y	Y	Y	Y <sup>2</sup>	Y	Y
<b>L Ctrl L Ctrl F11 -</b>	Decrease mouse speed	N	Y	Y	Y	Y <sup>2</sup>	Y	Y
<b>L Ctrl L Ctrl F11 F1</b>	Load preset 1	N	Y	Y	Y	N	Y	N
<b>L Ctrl L Ctrl F11 F2</b>	Load preset 2	N	Y	Y	Y	N	Y	N
<b>L Ctrl L Ctrl F11 F3</b>	Load preset 3	N	Y	Y	Y	N	Y	N
<b>L Ctrl L Ctrl F11 F4</b>	Load preset 4	N	Y	Y	Y	N	Y	N
<b>L Ctrl L Ctrl F11 F5</b>	Load preset 5	N	Y	Y	Y	N	Y	N
<b>L Ctrl L Ctrl F11 F6</b>	Load preset 6	N	Y	Y	Y	N	Y	N
<b>L Ctrl L Ctrl F11 F7</b>	Load preset 7	N	Y	Y	Y	N	Y	N
<b>L Ctrl L Ctrl F11 F8</b>	Load preset 8	N	Y	Y	Y	N	Y	N
<b>L Ctrl L Ctrl F11 F9</b>	Load preset 9	N	Y	Y	Y	N	Y	N
<b>L Ctrl L Ctrl F11 F10</b>	Load preset 10	N	Y	Y	Y	N	Y	N
<b>L Ctrl L Ctrl F11 1-3 1-0</b>	Load preset 1-3 or 1-0	N	Y	Y	Y	N	Y	N
<b>L Ctrl L Ctrl F11 F12</b>	Load previously loaded preset	N	Y	Y	Y	N	Y	N
<b>L Ctrl L Ctrl F11 L 1</b>	Load layout 1	N	N	N	Y	N	N	Y
<b>L Ctrl L Ctrl F11 L 2</b>	Load layout 2	N	N	N	Y	N	N	Y

**Table 2.7 KM Keyboard Shortcuts (continued)**

KEY COMBINATION	DESCRIPTION	STANDARD SWITCHES	VERSION 10020715	VERSION 10300915	VERSION 10020316 OR HIGHER	KVM	KM	MINI-MATRIX
<b>L Ctrl L Ctrl F11 L 3</b>	Load layout 3	N	N	N	Y	N	N	Y
<b>L Ctrl L Ctrl F11 L 4</b>	Load layout 4	N	N	N	Y	N	N	Y
<b>L Ctrl L Ctrl F11 L 5</b>	Load layout 5	N	N	N	Y	N	N	Y
<b>L Ctrl L Ctrl F11 L 6</b>	Load layout 6	N	N	N	Y	N	N	Y
<b>L Ctrl L Ctrl F1 1-4</b>	Display channel 1-4 on monitor 1	Y	N	N	Y	N	N	Y
<b>L Ctrl L Ctrl F2 1-4</b>	Display channel 1-4 on monitor 2	Y	N	N	Y	N	N	Y

<sup>1</sup> You must press and hold this keyboard shortcut to execute the command.

<sup>2</sup> This command is only available when the switch is in KM mode.

## 2.4 KM Configuration

The KM configuration utility is a web-based tool that allows system administrators to define custom monitor setups in a KM configuration file. The file is saved with the .kmc extension. When configuring a KM switch using a KM configuration file, you must be logged in to the switch as administrator.

The KM configuration utility allows administrators to define the number of monitors connected to each computer. Monitors can vary in size and resolution, and can be arranged in multiple layouts. You must download and install the KM configuration utility from the Software Downloads section on the Vertiv web site.

The KM configuration utility operates only with Microsoft® Windows®. Before downloading and installing the KM configuration utility, ensure at least Microsoft® Windows® XP is installed on the computers to be connected. The following browsers support the KM configuration utility:

- Google Chrome 20.0 or higher
- Microsoft® Internet Explorer®
- Mozilla® Firefox®

Before creating a KM configuration file, verify the number of computers and monitors to be connected to the KM switch and the monitors' sizes and resolutions.

### 2.4.1 Creating a KM configuration file

A KM configuration file is referred to in the KM configuration utility interface as a KM configuration project. Each customized setup requires its own project. You can create projects using the KM configuration utility project wizard. After completing the steps in the wizard, the KM configuration file is generated and downloaded to the computer.

The following table lists guidelines for entering project file information.

CONFIGURATION FIELD	DESCRIPTION
Project Name	Name of the custom monitor configuration.
Product Model	Model of the KM switch.
Mouse Speed	Default mouse cursor speed for all systems. Changes in the mouse cursor speed value on each computer do not affect the

CONFIGURATION FIELD	DESCRIPTION
	KM switch's mouse cursor speed.
Mouse Acceleration	Rate at which the mouse cursor speed increases. Changes in the mouse cursor acceleration value on each computer do not affect the KM switch's mouse cursor acceleration.
Number of Computers	Total number of computers to be connected to the KM switch for a particular configuration.

To create a new KM configuration project:

1. Log in to the KM switch as administrator, launch the KM configuration utility and click *New Project*.
2. Enter the project name and number of computers into the fields on the KM project setup window.
3. Select the product model, mouse speed and mouse acceleration from the drop-down menus and click *Next Step*.

Figure 2.9 KM Project Setup Window

The screenshot shows the 'KM Project Setup' window. The title is 'KM Project Setup' in blue. Below the title is the instruction 'Enter general information about the project configuration.' The 'General Setup' section is highlighted with a blue border and contains the following fields:

- Project Name:
- Product Model:
- Mouse Speed:
- Mouse Acceleration:
- Number of computers:

4. Enter a detailed product description that explains the configuration and click *Next Step*.
5. For each computer, select the number of monitors from the drop-down menu, enter each monitor's size and resolution and then click *Next Step*.

**NOTE:** Multiple monitor configurations require additional steps. See [Multiple monitor setup](#) on page 20 for more information.

**NOTE:** If a monitor is set to portrait orientation, enter the native resolution accordingly. For example, a monitor with 1680 x 1050 native resolution would have a 1050 x 1680 resolution in portrait orientation.

Figure 2.10 Computer Setup Window

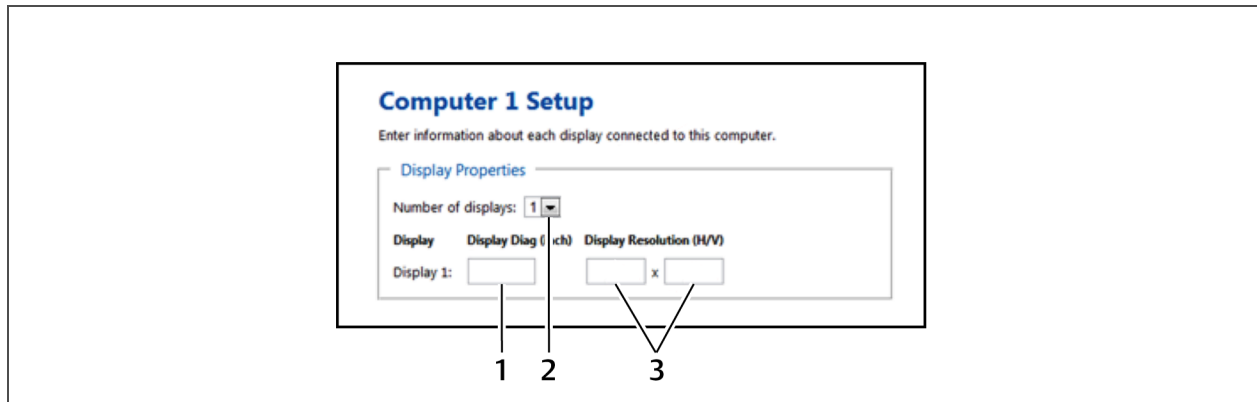

Table 2.8 Computer Setup Window

ITEM	DESCRIPTION
1	Monitor size
2	Number of displays
3	Native monitor resolution

6. Configure the location of the monitors by dragging and dropping the monitors into position. See [Configuration examples](#) on page 17 for acceptable multiple monitor setups.
7. Click *Complete Setup* to generate and download the configuration file.

### Configuration examples

Each monitor is labeled with its computer number and monitor number in the KM configuration utility. The monitors can be touching or separated by distance based on the geometry settings required.

After the monitors are placed into a layout, a bridge between the two monitors is shown in yellow to indicate the mouse cursor area for switching monitors. Clicking the yellow area removes it from the configuration and you will not be able to switch between the monitors using the mouse cursor.

### Example 1

The monitor configuration in example 1 establishes a mouse cursor bridge between the bottom left corner of display 1 and the top right corner of display 2. The mouse cursor bridge is indicated by the yellow area and it is the only area where the mouse switching between the two monitors is enabled. When the mouse cursor switches from display 1 to display 2, the active computer switches from computer 1 to computer 2, respectively. The red lines indicate areas where mouse cursor switching is disabled.

Figure 2.11 Example 1 Physical Layout

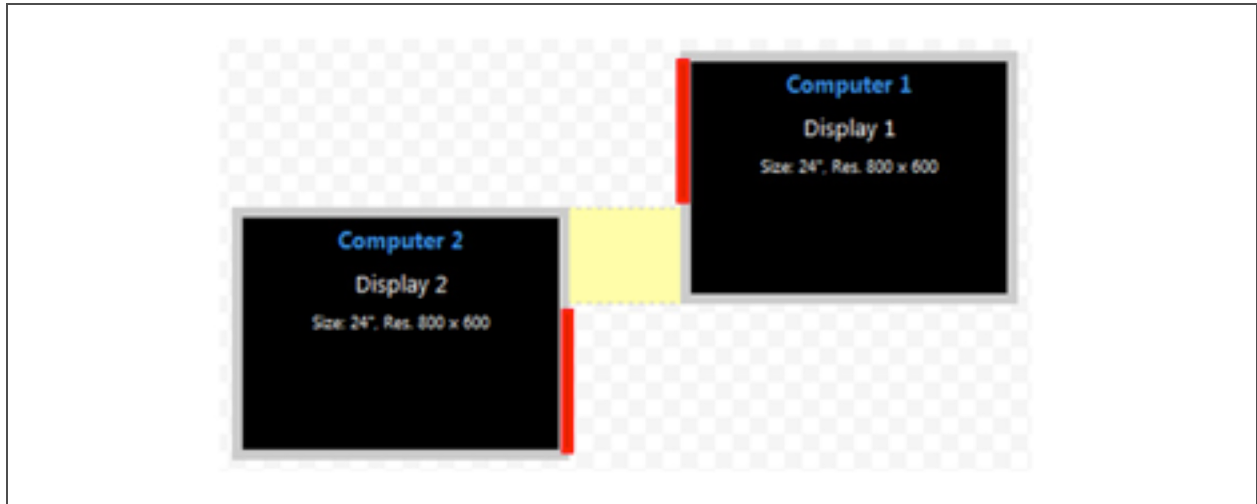

### Example 2

Both monitor configurations in example two enable you to switch between display 1 on the left and display 2 on the right. Using the mouse cursor to switch from display 1 to display 2 also switches you from computer 1 to computer 2.

Figure 2.12 Example 2 Physical Layout

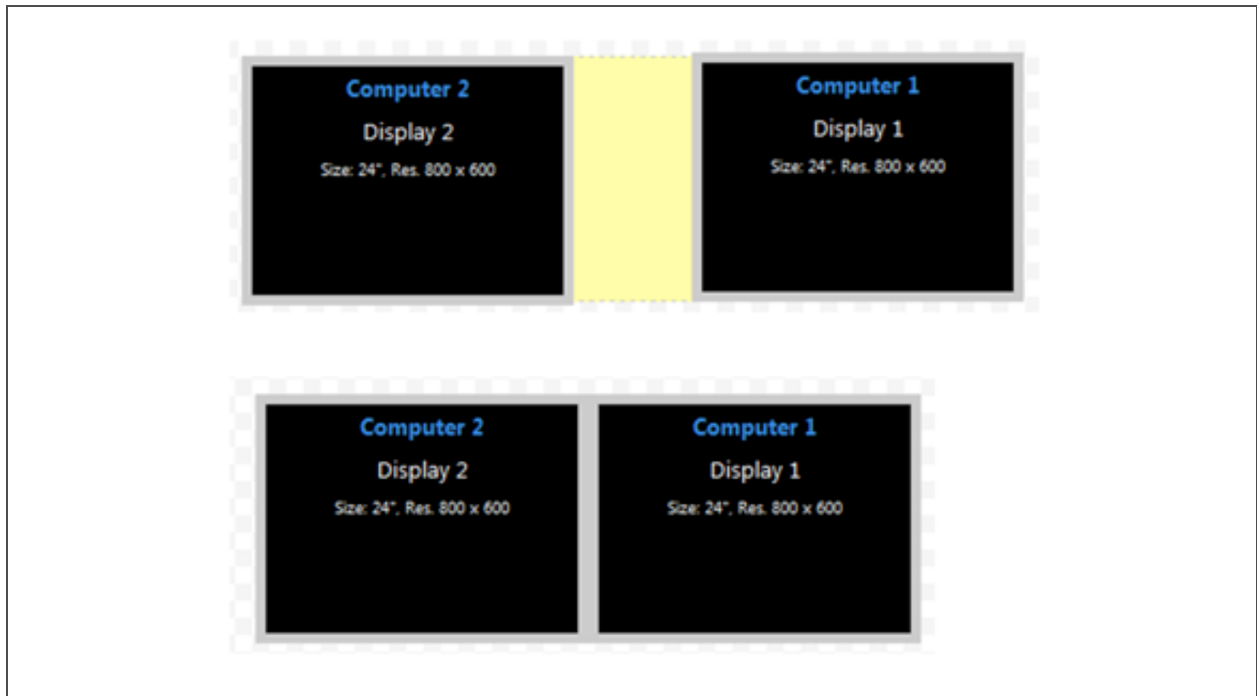

### Example 3

Example 3 depicts a multiple monitor configuration with the monitors connected at the corners. Example 3A is an invalid configuration because display 1 and display 2 do not share an overlapping area where the mouse cursor can cross. Example 3B is valid since the two monitors overlap to create an area where the mouse cursor can cross.

**Figure 2.13 Example 3A Invalid Physical Layout**



**Figure 2.14 Example 3B Valid Physical Layout**

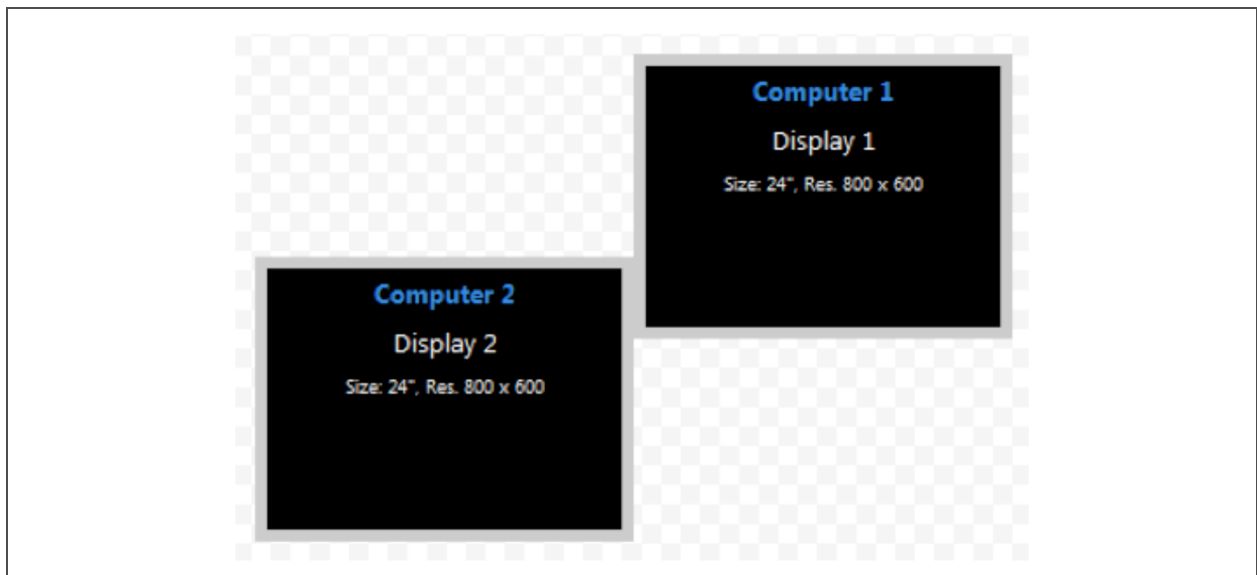

## Example 4

In example 4, the physical placement of the monitors can be configured multiple ways. In the first layout, computer 2 has two connected monitors and mouse cursor switching is enabled between computer 1 and both computer 2 monitors. In the second layout, mouse cursor switching is enabled only between computer 1 and display 1 for computer 2.

Figure 2.15 Example 4 Physical Layouts

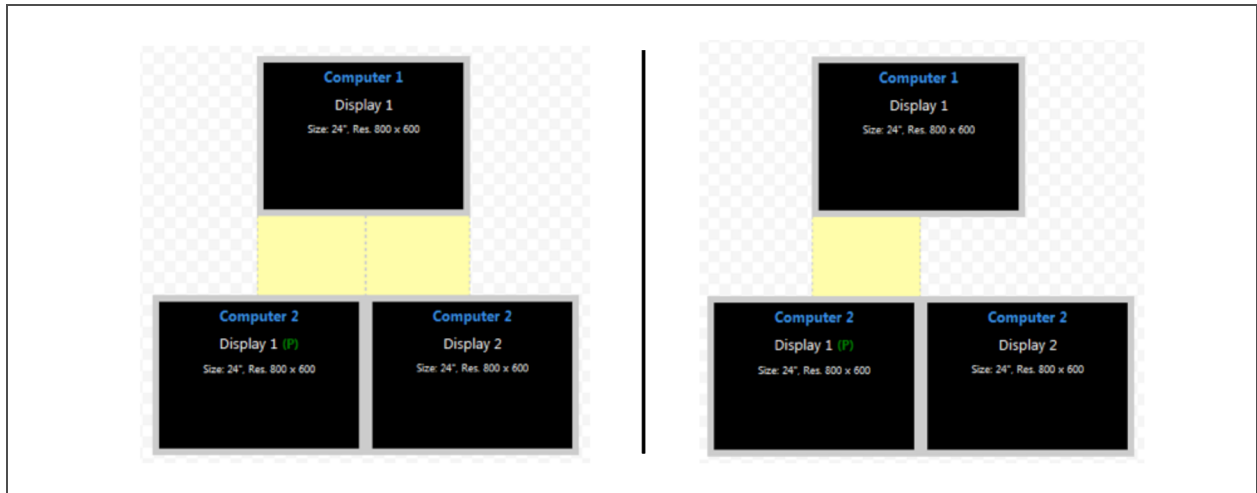

## Multiple monitor setup

In a multiple monitor configuration, the KM configuration file and the Microsoft® extended desktop settings control switching between the monitors. When setting up a multiple monitor configuration, you must enter the Microsoft® virtual desktop parameters to ensure a smooth and proportional transition among all connected monitors.

All monitors connected to the same computer must be configured next to one another with no distance between the monitors.

To set up a multiple monitor configuration:

1. From the Start menu, click *Control Panel*, then click *Appearance and Personalization - Display - Adjust Resolution*.
2. In the KM configuration utility Display Properties window, enter the size and resolution information for the primary and secondary monitors as indicated in the Microsoft® extended desktop settings.
3. Enter the vertical and horizontal coordinates for monitors.

The following figure and table list the monitor property fields to be completed when configuring multiple monitors.



**Figure 2.16** Entering Data for a Multiple Monitor Configuration

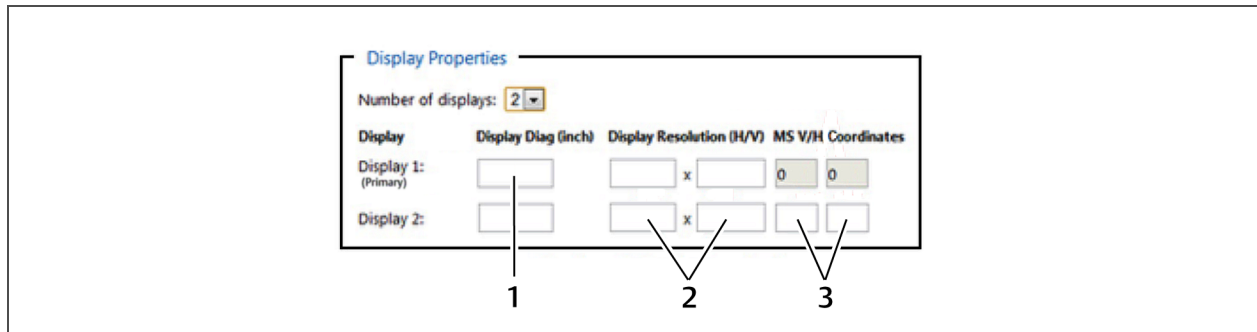

**Table 2.9** Multiple Monitor Configuration Properties

ITEM	DESCRIPTION
1	Monitor size
2	Native monitor resolution
3	Monitor coordinates per the Microsoft® extended desktop settings

## 2.4.2 Loading a KM configuration file

Before you can upload the KM configuration file, you must have the following:

- Loading driver mapping file - An .inf file that maps Microsoft® drivers to be used by the switch in administrator mode.
- USB programming cable - The cable required to load configurations onto the switch and is connected to the switch's USB mouse port.

**NOTE: The cable will not work if connected to any port other than the USB mouse port.**

- Administrator credentials - You must be logged in as administrator to load the KM configuration file onto the switch.

To load the KM configuration file:

1. Ensure power to the switch is turned on and a valid keyboard is connected to the switch's keyboard port.
2. Launch administrator mode by pressing **L CTRL + R CTRL + T** while in terminal mode.
3. Select *KM Configuration Option* and log in as administrator.
4. Connect one end of the USB programming cable to the mouse port on the switch and connect the other end to the computer that has the KM configuration file, the loading utility and the .inf mapping file.
5. Open the loading utility and verify that the switch is recognized.
6. Click *Select a new configuration file* and select the KM configuration file to be loaded.
7. Click *Update KM* and restart the switch.

The following figure and table list the items shown on the KM configuration utility load interface.

Figure 2.17 KM Configuration Utility Load Interface

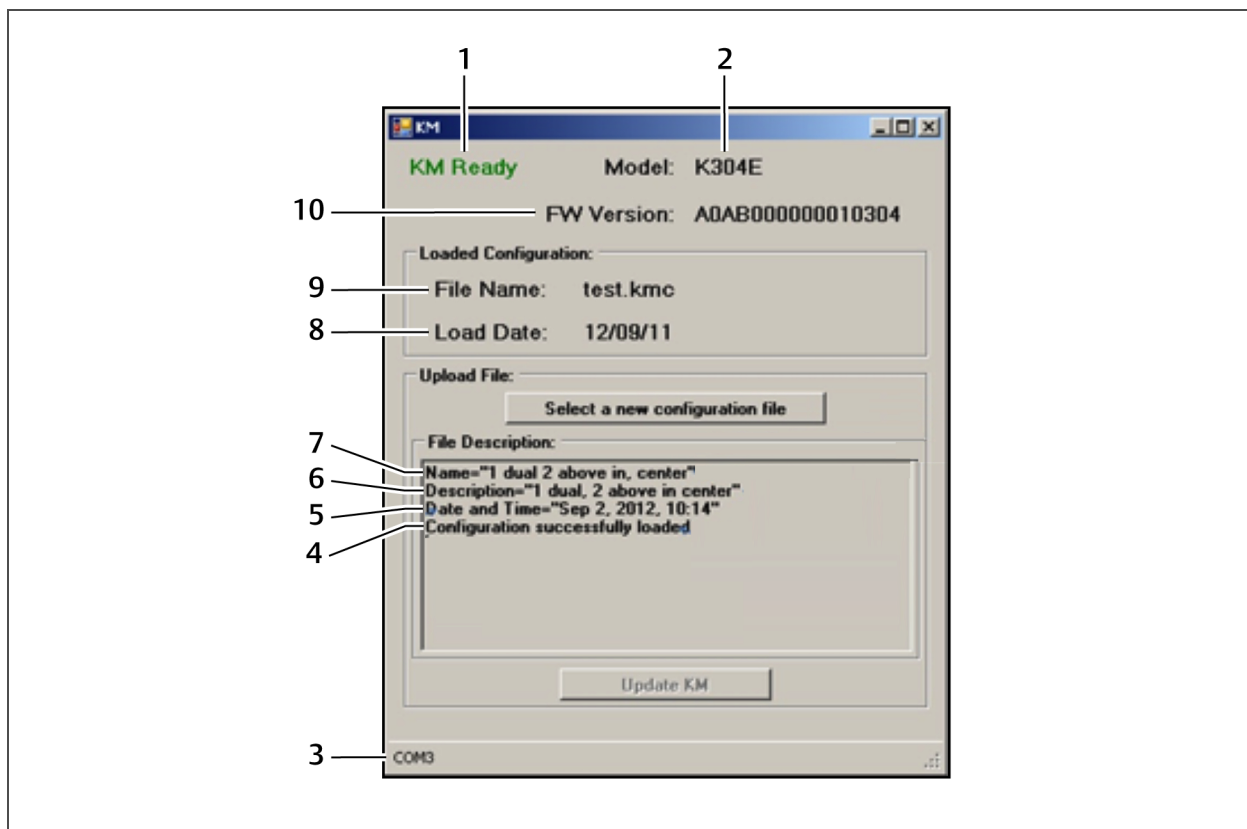

Table 2.10 KM Configuration Utility Load Interface Items

ITEM	DESCRIPTION
1	KM configuration utility status
2	Switch model detected by the KM configuration utility
3	Connected port
4	Configuration file load status
5	Date the configuration file was created
6	Description of the configuration file
7	Configuration filename
8	Load date of the configuration file
9	Filename of the last loaded configuration
10	Switch's firmware version detected by the KM configuration utility

## 3 TROUBLESHOOTING

When power is turned on to the switch, it performs a self-test to verify normal operation. If the switch fails the self-test procedure, all channel LED buttons flash on and off once and a combination of LEDs illuminate. The various combinations of illuminated LEDs indicate the fault with the switch. After a failed self-test, the switch becomes inoperable until the fault is resolved.

### 3.1 General

The following table lists general faults, the fault indicators and the actions to resolve each fault.

**Table 3.1 General Switch Faults**

FAULT	INDICATOR	RESOLUTION
The switch did not pass the self-test.	All channel LED buttons flash on and off once and a combination of LEDs illuminate to indicate the fault.	Turn power off and on to the switch.
The switch is not receiving power.	The displays do not show video output and none of the front panel LEDs illuminate.	Ensure the power cable is intact and connected to the switch and to the power source. If the cable is damaged, replace it.
The switch enclosure is compromised.	The tamper-evident seals indicate intrusion, the switch is inoperable and all channel LED buttons flash continuously.	Immediately remove the switch from service and contact Technical Support.
Remote desktop control is connected and rendering the channel select buttons is inoperable.	The switch does not respond when the channel select buttons are pressed.	Disconnect from remote desktop control, or control the KVM through remote desktop control or keyboard shortcuts.

### 3.2 KM Configuration File

The two most common errors that occur when loading the KM configuration file include:

- Incorrectly formatted configuration file - When you load an incorrectly formatted file, the KM configuration utility load interface indicates the issue in the File Description section and prompts you to load another file. Ensure the files you load are created with the KM configuration utility and have not been manually modified.

Figure 3.1 KM Configuration Utility Load Interface with Configuration File Error

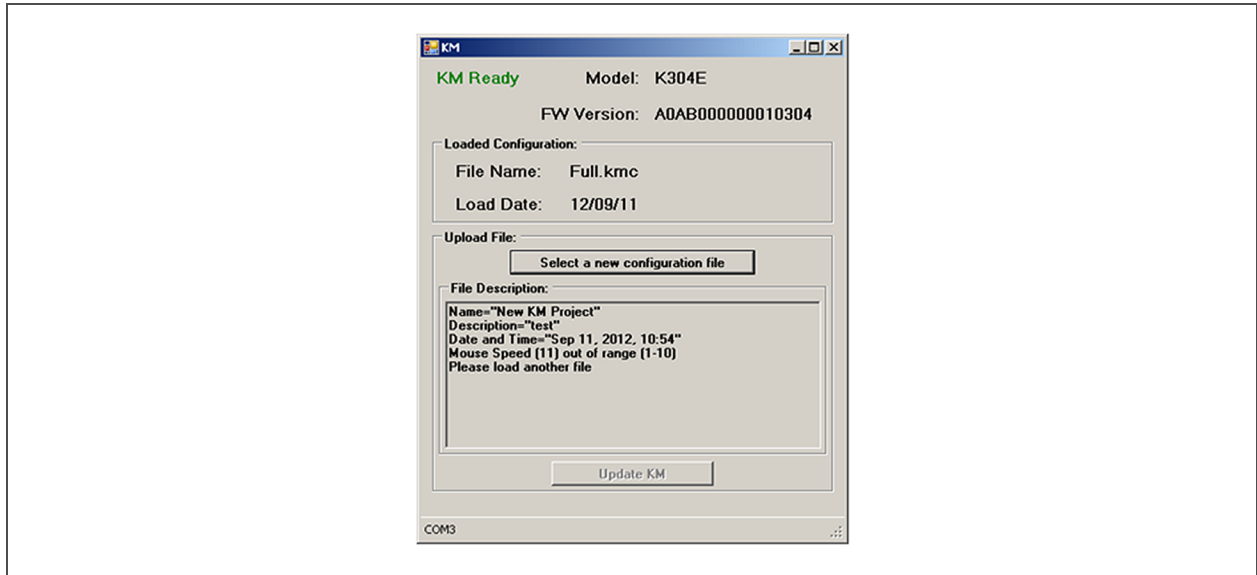

- Invalid communication connection to the switch - When communication between the switch and the utility is lost or fails, the KM configuration utility load interface status is KM Not Ready. Ensure that you use a USB programming cable to connect the switch to the computer that runs the configuration utility and the cable is connected to the switch's USB mouse port. Also verify that the loading driver mapping file is installed on the computer. If the connection continues to fail, restart the switch and relaunch administrator mode.

Figure 3.2 KM Configuration Utility Load Interface with Failed Connection Error



### 3.3 Video

The following table lists video faults, the fault indicators and the action to resolve each fault.

**Table 3.2 Video Faults**

FAULT	INDICATOR	RESOLUTION
The connected video display is not qualified.	The video diagnostic LED flashes green and the display is inoperable.	Turn off and disconnect the non-qualified display and connect and turn power on to a qualified display.
The displays or the computers are not connected to the switch properly or the connecting cables or ports are damaged.	The displays do not show video output on any channel and the display diagnostic LED does not appear solid green.	Ensure the displays are properly connected to the switch and the displays and connecting cables are not damaged. Replace damaged cables. If the displays or connecting cables are damaged, replace the damaged parts. If the issue persists, check the displays' on-screen menu to ensure the correct source is selected and verify the video mode and computer's video mode are the same. If the problem persists and the LED does not illuminate solid green, change the entire display unit or contact Technical Support.
A specific computer is not connected to the switch properly or the connecting cable or port is damaged.	The display does not show video output for a specific channel.	Ensure the connecting cable between the computer and the switch is secured and not damaged. Replace damaged cables. Ensure the displays are compatible with the computer resolution and refresh rate settings. Verify the video output is available and an image is shown when the display unit is connected directly to the computer. If the problem persists, turn power off and on to the switch, reboot the computer, replace the display unit or contact Technical Support.
The displays or computers are not connected to the switch properly or the connecting cables are not compatible with the displays.	Some or all channels are experiencing poor video image quality and the display diagnostic LED does not appear solid green.	Ensure the displays are properly connected to the switch and the displays and connecting cables are compatible with the displays and not damaged. Replace damaged cables. Video cable length should not exceed 15 feet. Ensure the displays are compatible with the computer resolution and refresh rate settings. Lower the video resolution of the computer. Verify the video output is available and an image is shown when the display unit is connected directly to the computer. If the problem persists, turn power off and on to the switch, reboot the computers and displays, replace the video displays or contact Technical Support.

### 3.4 Keyboard

The following table lists keyboard faults, the fault indicators and the action to resolve each fault.

**Table 3.3 Keyboard Faults**

FAULT	INDICATOR	RESOLUTION
The keyboard is not connected to the switch properly or the keyboard cable or port is damaged.	The keyboard does not work on any channels.	Ensure the keyboard is properly connected to the switch and the USB cable between the keyboard and the switch is not damaged. If the issue persists, connect the keyboard to a different port or use a different standard, non-wireless, qualified keyboard. Ensure the driver for the keyboard is installed on the computer.  <b>NOTE: If the computer is returning from standby mode, allow up to one minute for the computer to regain keyboard functionality.</b>
The keyboard, mouse and video cables are connected to two different computers.	The keyboard and mouse are not working on two channels.	Ensure the keyboard/mouse and video cables are connected to the correct ports on the switch. For example, the keyboard and mouse cable and the video cable for computer 1 should be connected to ports specifically designated for computer 1.
The computer does not recognize the connected keyboard.	The keyboard does not work on one channel.	Use the computer's Device Manager wizard to troubleshoot and resolve the issue.
The connected keyboard is not qualified or not connected to the switch properly	The keyboard is non-functional on any channel and you are unable to produce keystrokes on the screen when using the keyboard.	Ensure the keyboard is properly connected to the switch and the USB cable between the keyboard and the switch is not damaged. If damaged, replace the cable. Ensure the keyboard is a qualified device. If not, disconnect the non-qualified keyboard and connect a qualified keyboard. Verify that the keyboard works connected directly to the computer or when connected to a different USB port. If the problem persists, turn power off and on to the switch, reboot the computer, and replace the keyboard unit or contact Technical Support.
Caps lock, Scroll lock and Num lock LEDs do not illuminate on the keyboard.	When the Caps lock, Scroll lock or Num lock keys are pressed, the corresponding keyboard LEDs do not illuminate.	This is a normal behavior. All secure switches block communication from the computers to the keyboard to prevent potential data leaks. To determine if Caps lock, Scroll lock or Num lock are enabled on a specific computer, press the channel select button on the switch and observe the Caps lock, Scroll lock and Num lock LEDs on the switch.
The connected keyboard is not compatible with the switch.	Certain keyboard functions are inoperable once connected to the switch.	Determine if the connected keyboard is compatible with the switch. Some non-standard keyboard functions are disabled by the switch for security purposes. Contact Technical Support for compatibility information.

### 3.5 Mouse

The following table lists mouse faults, the fault indicators and the action to resolve each fault.

**Table 3.4 Device Faults**

FAULT	INDICATOR	RESOLUTION
The connected mouse is not qualified.	The mouse is non-functional and the mouse cursor is frozen on the screen. You are unable to use the mouse to move the mouse cursor.	Disconnect the non-qualified mouse and connect a qualified mouse.
The mouse is not plugged into the correct port.	The mouse does not work on any channels but the keyboard works.	Verify that the mouse is plugged into the mouse port and the connecting cable is not damaged. Plug the mouse into the mouse port if it is connected to a non-mouse port and replace the cable if it is damaged.
The mouse is not connected to the switch properly or the mouse cable or port is damaged.	The mouse does not work on any channels.	Ensure the mouse is properly connected to the switch and the USB cable between the mouse and the switch is not damaged. If the issue persists, connect the mouse to a different port or use a different standard, non-wireless, qualified mouse. Ensure the driver for the mouse is installed on the computer.  <b>NOTE: If the computer is returning from standby mode, allow up to one minute for the computer to regain mouse functionality.</b>
The computer does not recognize the connected mouse.	The mouse does not work on one channel.	Use the computer's Device Manager wizard to troubleshoot and resolve the issue.

### 3.6 DPP

The following table lists DPP device faults, the fault indicators and the action to resolve each fault.

**Table 3.5 Device Faults**

FAULT	INDICATOR	RESOLUTION
The connected USB device is not qualified.	DPP LED flashes green and the USB device is inoperable.	Disconnect the non-qualified USB device and connect a qualified USB device.
The USB device is not working properly or the connecting cable between the computer and the DPP input port on the switch is damaged or missing.	DPP USB device is not working on a channel.	Ensure the USB device is working properly when connected directly to the computer and ensure that the USB cable connecting the computer and the DPP input port on the switch is not damaged or missing.
The USB device and video cables are connected to two different computers.	DPP USB device is not working on two channels.	Ensure the USB device and video cables are connected to the correct ports on the switch. For example, the USB device cable and the video cable for computer 1 should be connected to ports specifically designated for computer 1.
The USB device is not working properly or not connected to the computer.	DPP USB device is not working on all channels.	Ensure the USB device is working properly and connected directly to the computer. Ensure there is a USB connected cable between the computer and the relevant DPP.

## 4 APPENDICES

The appendix contains technical specification tables for all the products covered in this document.

**Table A.1 SC 820/820D/820H/920/920D/920H 2-port, single or dual-head KVM Switches**

CATEGORY	VALUE
<b>Dimensions</b>	
SC 920 Series W x D x H	7 x 2.4 x 2 in (177 x 61 x 52.6 mm)
SC 820 Series W x D x H	7 x 2.4 x 1.4 in (177 x 61 x 35.2 mm)
SC 920 Series Weight	1.1 lbs (0.5 kg)
SC 820 Series Weight	1.1 lbs (0.5 kg)
<b>Ports</b>	
CPU Keyboard/Mouse Ports	USB Type-B jack
Console Keyboard Input	USB Type-A female connector
CPU Audio Input	1/8 in (3.5 mm) stereo jack
CPU Video Input Port	DVI-I video port (2 for SC 920, 1 for SC 820 model) DisplayPort video port (2 for SC 920D, 1 for SC 820D model ) HDMI video port (2 for SC 920H, 1 for SC 820 model)
Console Mouse Input	USB Type-A female connector
Console Display Port	DVI-I female connector (2 for SC 920, 1 for SC 820) DisplayPort female connector (2 for SC 920D, 1 for SC 820D) HDMI female connector (2 for SC 920H, 1 for SC 820H)
<b>Front Panel</b>	
Port Selectors and LEDs	2
<b>Resolution/Displays</b>	
Resolution	Up to 4Kx2K Ultra HD (3840 X 2160 Pixels) resolutions
Supports Displays	2 for the SC 920 series 1 for the SC 820 series
<b>Support</b>	
Secure Channels	2
Users Supported	1
Number of Computers	2
<b>Power</b>	
DC Input Range	12 VAC
<b>Ambient Atmospheric Condition Ratings</b>	
Operating Temperature	32° to 104° F (0° to 40° C)
Storage Temperature	-4° to 140° F (-20° to 60° C)
Humidity	0-80% relative humidity, non-condensing

**Table A.2 SC 840D/845D/940D/945D 4-Port DisplayPort KVM Switches**

CATEGORY	VALUE
<b>Dimensions</b>	
W x D x H	13.5 x 5 x 2.2 in (342 x 125 x 56.6 mm)
Weight	2.2 lbs. (1 kg)
<b>Ports</b>	
Console Audio Out	1/8 in (3.5 mm) stereo jack
CPU Keyboard/Mouse Ports	USB Type-B jack
CPU DPP Ports	USB Type-B jack
Console DPP Input	USB Type-A female connector
Console Video Out port	1 HDMI dual-link female connector
Console Keyboard Input	USB Type-A female connector or PS/2 Mini-DIN 6-pin female connector
CPU Audio Input	1/8 in (3.5 mm) stereo jack
CPU Video Input Port	DVI-I dual-link female connector
Console Mouse Input	USB Type-A female connector or PS/2 Mini-DIN 6-pin female connector
Console CAC Input	USB Type-A female connector
<b>Front Panel</b>	
Port Selectors	4
LED Indicators	4
<b>Resolution/Displays</b>	
Resolution	Up to 2560 x 1600
Supports Displays	1 single-link/dual-link digital DVI-D display; analog VGA display or HDMI with adaptor
<b>Support</b>	
Secure Channels	4
Users Supported	1
Number of Computers	4
<b>Power</b>	
AC Input Range	100-240 VAC
<b>Ambient Atmospheric Condition Ratings</b>	
Operating Temperature	32° to 104° F (0° to 40° C)
Storage Temperature	-4° to 140° F (-20° to 60° C)
Humidity	0-80% relative humidity, non-condensing
<b>Additional Information</b>	
Warranty	2 years; can be extended to up to 7 years at cost
Security Accreditation	Common Criteria EAL 4+



**Table A.3 SC 840H/845H/940H/945H 2- and 4-Port HDMI KVM Switches**

CATEGORY	VALUE
<b>Dimensions</b>	
W x D x H	13.5 x 5 x 2.2 in (342 x 125 x 56.6 mm)
Weight	4 lbs (1.85 kg)
<b>Ports</b>	
Console Audio Out	1/8 in (3.5 mm) stereo jack
CPU Keyboard/Mouse Ports	USB Type-B jack
CPU DPP Ports	USB Type-B jack
Console DPP Input	USB Type-A female connector
Console Video Out Port	1 HDMI dual-link female connector
Console Keyboard Input	USB Type-A female connector or PS/2 Mini-DIN 6-pin female connector
CPU Audio Input	1/8 in (3.5 mm) stereo jack
CPU Video Input Port	HDMI female connector
Console Mouse Input	USB Type-A female connector or PS/2 Mini-DIN 6-pin female connector
Console Display Port	1 HDMI female connector [2 in SC845H]
Console CAC Input	USB Type-A female connector
<b>Front Panel</b>	
Port Selectors	4
LED Indicators	4 channel + 4 DPP
<b>Resolution/Displays</b>	
Resolution	All HDMI 1.3a resolutions up to 1920 x 1200 x 30 bpp @ 60 Hz
Supports Displays	1 HDMI or 1 DVI-D display with adaptor [2 displays in SC845H]
<b>Support</b>	
Secure Channels	4
Users Supported	1
Number of Computers	4
<b>Power</b>	
AC Input Range	100-240 VAC
<b>Ambient Atmospheric Condition Ratings</b>	
Operating Temperature	32° to 104° F (0° to 40° C)
Storage Temperature	-4° to 140° F (-20° to 60° C)
Humidity	0-80% relative humidity, non-condensing
<b>Additional Information</b>	
Warranty	2 years; can be extended to up to 7 years at cost
Security Accreditation	Common Criteria EAL 4+

**Table A.4 SC 840/845/940/945 DVI-I KVM Switches**

CATEGORY	VALUE
<b>Dimensions</b>	
W x D x H	13.5 x 5 x 2.2 in (342 x 125 x 56.6 mm)
Weight	4 lbs (1.85 kg)
<b>Ports</b>	
Console Audio Out	1/8 in (3.5 mm) stereo jack
CPU Keyboard/Mouse Ports	USB Type-B jack
CPU DPP Ports	USB Type-B jack
Console DPP Input	USB Type-A female connector
Console Video Out Port	2 DVI-I dual-link female connector
Console Keyboard Input	USB Type-A female connector or PS/2 Mini-DIN 6-pin female connector
CPU Audio Input	1/8 in (3.5 mm) stereo jack
CPU Video Input Port	HDMI female
Console Mouse Input	USB Type-A female connector or PS/2 Mini-DIN 6-pin female connector
Console Display Port	1 HDMI female connector [2 in SC845H]
Console CAC Input	USB Type-A female connector
<b>Front Panel</b>	
Port Selectors	4
LED Indicators	4 channel + 4 DPP
<b>Resolution/Displays</b>	
Resolution	Dual-link DVI up to 2560 x 1600
Supports Displays	2 single-link and dual-link digital DVI-D displays; analog VGA monitors with adaptor
Target Video Connectors	All of the target video connectors and cable connectors on the switch are DVI-I. Target devices with analog connectors require an adaptor to connect to the VGA port (VAD-28). Target devices with digital only connectors must use an adaptor to match the DVI-D port (VAD-31).
<b>Support</b>	
Secure Channels	4
Users Supported	1
Number of Computers	4
Hardware	The SC switches support most DVI, HDMI, VGA monitors and video cards (with adaptors), headsets, speakers, USB and PS/2 keyboards and USB mice.
<b>Power</b>	
AC Input Range	100-240 VAC
<b>Ambient Atmospheric Condition Ratings</b>	
Operating Temperature	32° to 104° F (0° to 40° C)
Storage Temperature	-4° to 140° F (-20° to 60° C)
Humidity	0-80% relative humidity, non-condensing
<b>Additional Information</b>	
Warranty	3 years; can be extended to up to 7 years at cost
Security Accreditation	Common Criteria EAL 4+

**Table A.5 SC KM 140/KM 145 4-Port KM Switches**

CATEGORY	VALUE
<b>Dimensions</b>	
W x D x H	13.5 x 5 x 1.1 in (342 x 125 x 28 mm)
Weight	3 lbs (1.4 kg)
<b>Ports</b>	
Console Audio Out	1/8 in (3.5 mm) stereo jack
Computer Keyboard/Mouse Ports	USB Type-B jack
Console Keyboard Input	USB Type-A female connector or PS/2 Mini-DIN 6-pin female connector
CPU Audio Input	1/8 in (3.5 mm) stereo jack
Console Mouse Input	USB Type-A female connector or PS/2 Mini-DIN 6-pin female connector
Console CAC Input	USB Type-A
<b>Front Panel</b>	
Port Selectors	4
LED Indicators	4 channel + 4 DPP
User Channel Selection Methods	Front panel push-buttons, SCS
<b>Support</b>	
Users Supported	1
Number of Computers	4
<b>Power</b>	
AC Input Range	100-240 VAC
Power Requirements	100–240 VAC, 0.9A Freq. 50/60 Hz
<b>Ambient Atmospheric Condition Ratings</b>	
Operating Temperature	32° to 104° F (0° to 40° C)
Storage Temperature	-4° to 140° F (-20° to 60° C)
Humidity	0-80% relative humidity, non-condensing
Administrator Settings	Display physical size, display resolution X / Y, display orientation (portrait /landscape), display head (1st, 2nd,16th), display location (coordinates), mouse speed (1-10), mouse acceleration (1-10), SCS enable / disable, prevent transition while dragging – enable / disable.
<b>Additional Information</b>	
Warranty	2 years; can be extended to up to 7 years at cost
Security Accreditation	Common Criteria EAL 4+

**Table A.6 SC KM 120 2-Port KM Switches**

CATEGORY	VALUE
<b>Dimensions</b>	
W x D x H	6.96 x 2.9 x 1.1 in (177 x 74 x 30 mm)
<b>Ports</b>	
Console Audio Out	1/8 in (3.5 mm) stereo jack
Computer Keyboard/Mouse Ports	USB Type-B jack
Console Keyboard Input	USB Type-A female connector
CPU Audio Input	1/8 in (3.5 mm) stereo jack
Console Mouse Input	USB Type-A female connector
<b>Front Panel</b>	
Port Selectors	2
LED Indicators	2 channel
User Channel Selection Methods	Front panel push-buttons, or VDT
<b>Support</b>	
Users Supported	1
Number of Computers	2
<b>Power</b>	
Power Requirements	DC input 12 V/1.5 A maximum
<b>Ambient Atmospheric Condition Ratings</b>	
Operating Temperature	32° to 104° F (0° to 40° C)
Storage Temperature	-4° to 140° F (-20° to 60° C)
Humidity	0-80% relative humidity, non-condensing
Administrator Settings	Display physical size, display resolution X/Y, display orientation (portrait/landscape), display head (1st, 2nd, 16th), display location (coordinates), mouse speed (1-10), mouse acceleration (1-10), SCS enable/disable, prevent transition while dragging – enable/disable.
<b>Additional Information</b>	
Warranty	2 years; can be extended to up to 7 years at cost
Security Accreditation	Common Criteria EAL 4+

**Table A.7 SC 920XD 2-Port Dual-Head KVM Switches**

CATEGORY	VALUE
<b>Dimensions</b>	
W x D x H	7 x 2.4 x 2 in (177 x 61 x 52.6 mm)
<b>Ports</b>	
Console Audio Out	1/8 in (3.5 mm) stereo jack
Computer Keyboard/Mouse Ports	USB Type-B jack
Console Keyboard Input	USB Type-A female connector
CPU Audio Input	1/8 in (3.5 mm) stereo jack
Console Video Out Port	DisplayPort and DVI-I
CPU Video Input Port	DisplayPort and DVI-I
Console Mouse Input	USB Type-A female connector
<b>Front Panel</b>	
Port Selectors	2
LED Indicators	2 channel
User Channel Selection Methods	Front panel push-buttons, or VDT
<b>Support</b>	
Users Supported	1
Number of Computers	2
<b>Power</b>	
Power Requirements	DC input 12 V/1.5 A maximum
<b>Ambient Atmospheric Condition Ratings</b>	
Operating Temperature	32° to 104° F (0° to 40° C)
Storage Temperature	-4° to 140° F (-20° to 60° C)
Humidity	0-80% relative humidity , non-condensing
Administrator Settings	Display physical size, display resolution X/Y, display orientation (portrait/landscape), display head (1st, 2nd,16th), display location (coordinates), mouse speed (1-10), mouse acceleration (1-10), SCS enable/disable, prevent transition while dragging – enable/disable.
<b>Additional Information</b>	
Warranty	2 years; can be extended to up to 7 years at cost
Security Accreditation	Common Criteria EAL 4+

**Table A.8 SC 945XD 4-Port Mixed Dual-Head KVM Switches**

CATEGORY	VALUE
<b>Dimensions</b>	
W x D x H	13.5 x 5 x 2.2 in (342 x 125 x 56.6 mm)
<b>Ports</b>	
Console Audio Out	1/8 in (3.5 mm) stereo jack
Computer Keyboard/Mouse Ports	USB Type-B jack
Console Keyboard Input	USB Type-A female connector or PS/2 Mini-DIN 6-pin female connector
CPU Audio Input	1/8 in (3.5 mm) stereo jack
Console Video Out Port	DisplayPort and DVI-I
CPU Video Input Port	DisplayPort and DVI-I
Port Selectors	4
LED Indicators	4 channel
User Channel Selection Methods	Front panel push-buttons, or VDT
<b>Support</b>	
Users Supported	1
Number of Computers	4
<b>Power</b>	
AC Input Range	100-240 VAC
<b>Ambient Atmospheric Condition Ratings</b>	
Operating Temperature	32° to 104° F (0° to 40° C)
Storage Temperature	-4° to 140° F (-20° to 60° C)
Humidity	0-80% relative humidity , non-condensing
Administrator Settings	Display physical size, display resolution X/Y, display orientation (por trait/landscape), display head (1st, 2nd,16th), display location (coordinates), mouse speed (1-10), mouse acceleration (1-10), SCS enable/disable, prevent transition while dragging – enable/disable.
<b>Additional Information</b>	
Warranty	2 years; can be extended to up to 7 years at cost
Security Accreditation	Common Criteria EAL 4+





---

VertivCo.com | Vertiv Headquarters, 1050 Dearborn Drive, Columbus, OH, 43085, USA

© 2018 Vertiv Co. All rights reserved. Vertiv and the Vertiv logo are trademarks or registered trademarks of Vertiv Co. All other names and logos referred to are trade names, trademarks or registered trademarks of their respective owners. While every precaution has been taken to ensure accuracy and completeness herein, Vertiv Co. assumes no responsibility, and disclaims all liability, for damages resulting from use of this information or for any errors or omissions. Specifications are subject to change without notice.

590-1532-501B