

User Manual

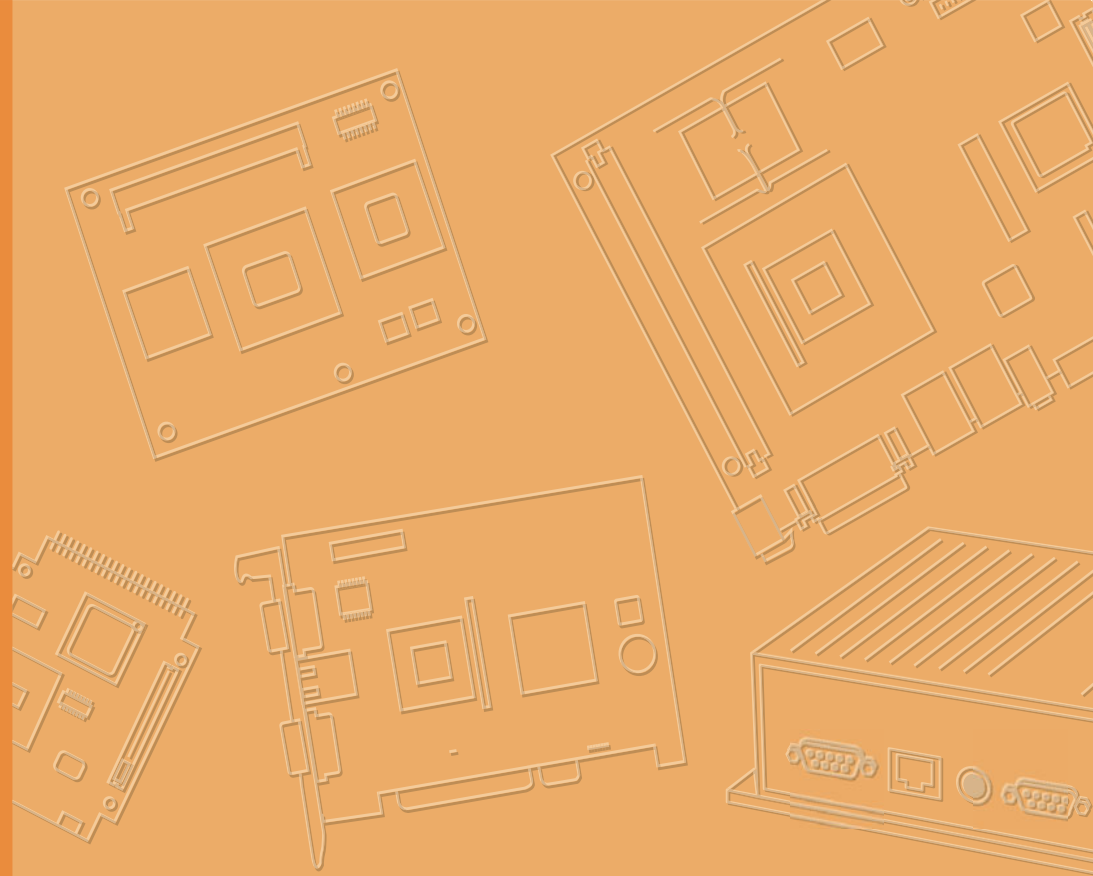

TREK-733L

**RISC All-in-One Light duty
Mobile Data Terminal**

ADVANTECH

Enabling an Intelligent Planet

Copyright

The documentation and the software included with this product are copyrighted 2016 by Advantech Co., Ltd. All rights are reserved. Advantech Co., Ltd. reserves the right to make improvements in the products described in this manual at any time without notice. No part of this manual may be reproduced, copied, translated or transmitted in any form or by any means without the prior written permission of Advantech Co., Ltd. Information provided in this manual is intended to be accurate and reliable. However, Advantech Co., Ltd. assumes no responsibility for its use, nor for any infringements of the rights of third parties, which may result from its use.

Acknowledgements

i.MX6 is trademarks of NXP (Freescale).

Android 4.4.2 is a trademark of Google Inc.

All other product names or trademarks are properties of their respective owners.

Product Warranty (2 years)

Advantech warrants to you, the original purchaser, that each of its products will be free from defects in materials and workmanship for two years from the date of purchase.

This warranty does not apply to any products which have been repaired or altered by persons other than repair personnel authorized by Advantech, or which have been subject to misuse, abuse, accident or improper installation. Advantech assumes no liability under the terms of this warranty as a consequence of such events.

Because of Advantech's high quality-control standards and rigorous testing, most of our customers never need to use our repair service. If an Advantech product is defective, it will be repaired or replaced at no charge during the warranty period. For out-of-warranty repairs, you will be billed according to the cost of replacement materials, service time and freight. Please consult your dealer for more details.

If you think you have a defective product, follow these steps:

1. Collect all the information about the problem encountered. (For example, CPU speed, Advantech products used, other hardware and software used, etc.) Note anything abnormal and list any onscreen messages you get when the problem occurs.
2. Call your dealer and describe the problem. Please have your manual, product, and any helpful information readily available.
3. If your product is diagnosed as defective, obtain an RMA (return merchandise authorization) number from your dealer. This allows us to process your return more quickly.
4. Carefully pack the defective product, a fully-completed Repair and Replacement Order Card and a photocopy proof of purchase date (such as your sales receipt) in a shippable container. A product returned without proof of the purchase date is not eligible for warranty service.
5. Write the RMA number visibly on the outside of the package and ship it prepaid to your dealer.

Part No.
Printed in Taiwan

Edition 1
October 2016

Declaration of Conformity

CE

This product has passed the CE test for environmental specifications. Test conditions for passing included the equipment being operated within an industrial enclosure. In order to protect the product from being damaged by ESD (Electrostatic Discharge) and EMI leakage, we strongly recommend the use of CE-compliant industrial enclosure products.

FCC Class B

Note: This equipment has been tested and found to comply with the limits for a Class B digital device, pursuant to part 15 of the FCC Rules. These limits are designed to provide reasonable protection against harmful interference in a residential installation. This equipment generates, uses and can radiate radio frequency energy and, if not installed and used in accordance with the instructions, may cause harmful interference to radio communications. However, there is no guarantee that interference will not occur in a particular installation. If this equipment does cause harmful interference to radio or television reception, which can be determined by turning the equipment off and on, the user is encouraged to try to correct the interference by one or more of the following measures:

- Reorient or relocate the receiving antenna.
- Increase the separation between the equipment and receiver.
- Connect the equipment into an outlet on a circuit different from that to which the receiver is connected.
- Consult the dealer or an experienced radio/TV technician for help.

This device complies with Part 15 FCC Rules.

Operation is subject to the following two conditions:

- (1) this device may not cause harmful interference, and
- (2) this device must accept any interference received, including interference may cause undesired operation.

RF Exposure Information

This device meets the government's requirements for exposure to radio waves.

This device is designed and manufactured not to exceed the emission limits for exposure to radio frequency (RF) energy set by the Federal Communications Commission of the U.S. Government.

This device complies with FCC radiation exposure limits set forth for an uncontrolled environment. In order to avoid the possibility of exceeding the FCC radio frequency exposure limits, human proximity to the antenna shall not be less than 20cm (8 inches) during normal operation.

Changes or modifications not expressly approved by the party responsible for compliance could void the user's authority to operate the equipment.

Technical Support and Assistance

1. Visit the Advantech web site at <http://support.advantech.com> where you can find the latest information about the product.
2. Contact your distributor, sales representative, or Advantech's customer service center for technical support if you need additional assistance. Please have the following information ready before you call:
 - Product name and serial number
 - Description of your peripheral attachments
 - Description of your software (operating system, version, application software, etc.)
 - A complete description of the problem
 - The exact wording of any error messages

Warnings, Cautions and Notes

Warning! *Warnings indicate conditions, which if not observed, can cause personal injury!*



Caution! *Cautions are included to help you avoid damaging hardware or losing data. e.g.*



There is a danger of a new battery exploding if it is incorrectly installed. Do not attempt to recharge, force open, or heat the battery. Replace the battery only with the same or equivalent type recommended by the manufacturer. Discard used batteries according to the manufacturer's instructions.

Note! *Notes provide optional additional information.*



Document Feedback

To assist us in making improvements to this manual, we would welcome comments and constructive criticism. Please send all such - in writing to: support@advantech.com

Packing List

Before setting up the system, check that the items listed below are included and in good condition. If any item does not accord with the table, please contact your dealer immediately.

- TREK-733L Light Duty Mobile Data Terminal
- One WWAN LTE Main & GNSS combo antenna and one WWAN LTE Aux antenna
- One High Density Cable (include Power and I/O)

Ordering Information

Part Number	Description
TREK-733L-LWBADA0E	TREK-733L NXP (Freescale) Cortex-A9 i.MX6DL Dual Core 1.0 GHz, 1GB DRAM, 4GB eMMC, Android 4.4.2, LTE MC7304 (Ext. ANT), GNSS(Ext. ANT), WLAN/BT (Int. ANT), Power and I/O Cable
TREK-733L-LWBADB0E	TREK-733L NXP (Freescale) Cortex-A9 i.MX6DL Dual Core 1.0 GHz, 1GB DRAM, 4GB eMMC, Android 4.4.2, LTE MC7354 (Ext. ANT), GNSS(Ext. ANT), WLAN/BT (Int. ANT), Power and I/O Cable

Ordering Accessories

Part Number	Description
BB-HDV100A3	RS-232 to J1708 and J1939 Converter
BB-D99Y	Y Cable of DB15 and Deutschfor 9-Pin for RS-232 to J1708 and J1939 Converter
TREK-MNT-301E	Double square plate with AMPS hole pattern
TREK-MNT-302E	Square plate with AMPS hole pattern & X-type base
TREK-MNT-303E	Square plate with AMPS hole pattern & suction cup base

Safety Instructions

1. Read these safety instructions carefully.
2. Keep this User Manual for later reference.
3. Disconnect this equipment from any AC outlet before cleaning. Use a damp cloth. Do not use liquid or spray detergents for cleaning.
4. For plug-in equipment, the power outlet socket must be located near the equipment and must be easily accessible.
5. Keep this equipment away from humidity.
6. Put this equipment on a reliable surface during installation. Dropping it or letting it fall may cause damage.
7. Do not leave this equipment in an environment unconditioned where the storage temperature under -20°C (-4°F) or above 70°C (158°F), it may damage the equipment.
8. Do not operate this equipment in an environment temperature may over 70°C (158°F). The surface temperature of metal chassis may be scorch and hot.
9. Make sure the voltage of the power source is correct before connecting the equipment to the power outlet.
10. Position the power cord so that people cannot step on it. Do not place anything over the power cord. The voltage and current rating of the cord should be greater than the voltage and current rating marked on the product.
11. All cautions and warnings on the equipment should be noted.
12. If the equipment is not used for a long time, disconnect it from the power source to avoid damage by transient overvoltage.
13. Never open the equipment. For safety reasons, the equipment should be opened only by qualified service personnel.
14. If one of the following situations arises, get the equipment checked by service personnel:
 - The power cord or plug is damaged.
 - Liquid has penetrated into the equipment.
 - The equipment has been exposed to moisture.
 - The equipment does not work well, or you cannot get it to work according to the user's manual.
 - The equipment has been dropped and damaged.
 - The equipment has obvious signs of breakage.
15. This device complies with Part 15 of the FCC rules. Operation is subject to the following two conditions:
 - (1) this device may not cause harmful interference, and
 - (2) this device must accept any interference received, including interference that may cause undesired operation.
16. CAUTION: Always completely disconnect the power cord from your chassis whenever you work with the hardware. Do not make connections while the power is on. Sensitive electronic components can be damaged by sudden power surges.
17. CAUTION: Always ground yourself to remove any static charge before touching the motherboard, backplane, or add-on cards. Modern electronic devices are very sensitive to static electric charges. As a safety precaution, use a grounding wrist strap at all times. Place all electronic components on a static-dissipative surface or in a static-shielded bag when they are not in the chassis.
18. CAUTION: Any unverified component could cause unexpected damage. To ensure the correct installation, please always use the components (ex. screws) provided with the accessory box.

Safety Precaution - Static Electricity

Follow these simple precautions to protect yourself from harm and the products from damage.

- To avoid electrical shock, always disconnect the power from your system chassis before you work on it. Don't touch any components on the main board or other cards while the system is on.
- Disconnect power before making any configuration changes. The sudden rush of power as you connect a jumper or install a card may damage sensitive electronic components.

- Warning!**
- 
1. *Input voltage rated: 9 ~ 32 Vdc (For 12/24V car power system).*
 2. *Transport: carry the unit with both hands and handle with care.*
 3. *Maintenance: to properly maintain and clean the surfaces, use only approved products or clean with a dry applicator.*
 4. *Micro SD card and SIM card: Turn off the power before inserting or removing the storage cards.*

Record of Revision

Version	Date	Page	Description	Remark
0.1	2016/09/27	All	Preliminary Release	

Contents

Chapter 1	General Information	1
1.1	Introduction	2
1.2	Features	2
1.3	Product Specifications.....	2
1.4	Dimensions	5
	Figure 1.1 TREK-733L dimensions.....	5
Chapter 2	System Setup.....	7
2.1	A Quick Tour of the TREK-733L Mobile Data Terminal	8
	Figure 2.1 Front view of TREK-733L	8
2.1.1	Power LED Behavior.....	8
2.1.2	Light Sensor.....	8
2.1.3	Reset Button	9
	Figure 2.2 Rear view of TREK-733L.....	9
	Figure 2.3 Side view of TREK-733L	9
2.2	Installation Procedures.....	10
2.2.1	Connecting the Power Cord.....	10
	Table 2.1: Pin Definition of Power Cord	10
	Figure 2.4 HDC Connector &Power/IO Cable photo (HDC)	10
2.2.2	Connecting the WWAN signal.....	11
Chapter 3	Hardware & Peripheral	13
3.1	Installing the Storage Device and SIM Card	14
3.2	Installing Optional Accessories	14
3.3	Installing Standard Wireless Options	15
3.3.1	LTE/GNSS (External Antenna)	15
Chapter 4	Pin Assignments	17
4.1	Power and I/O cable.....	18
4.1.1	RS-232-1/RS-232-2 Connector.....	20
4.1.2	ISO DI/DO Connector	21
4.1.3	USB Connector	21
4.2	Power & I/O Cable	23
Chapter 5	Welcome to Android.....	25
5.1	Navigation buttons	26
5.1.1	Organize your Home screens	26
5.1.2	Touch & type.....	27
5.2	Use the keyboard	28
5.2.1	Enter & edit text	28
5.2.2	Basic editing.....	28
5.2.3	Use next-word suggestions.....	29
5.2.4	Gesture Typing	30
5.2.5	Use Gesture Typing without the space bar.....	30
5.2.6	Keyboard dictionaries	30
5.2.7	Type by speaking.....	30
5.3	Settings	31

5.4	Accessibility	32
5.5	ADB (Android Debug Bridge).....	32
	5.5.1 ADB connect device:	33
5.6	APK install.....	33
	5.6.1 Prepare APK install disk	34
	5.6.2 How to write StartUp.sh install APK.....	34
5.7	Reload System Image.....	35
	5.7.1 eMMC Image Reload from SD Card.....	35
	5.7.2 Reset your Android One to factory settings	36
5.8	OTA update (over-the-air update).....	37
	5.8.1 Android device layout	37
	5.8.2 OTA from USB.....	38
5.9	VPM Update.....	39
	5.9.1 Install update tool.....	39
	5.9.2 Update VPM	40

Chapter 1

General Information

This chapter gives background information on the TREK-733L Mobile Data Terminal.

Sections include:

- Features
- Product Specifications
- Dimensions

1.1 Introduction

TREK-733L is an ARM based Android 4.4.2 platform with 7" display and capacitive touch screen all-in-one light duty mobile data terminal (MDT). Powered by NXP (Freescale) 1.0 GHz processor, 1GB DRAM and rich wireless communication interface include 4G LTE and WLAN/BT provide high speed data exchange with performance required by fleet management company. It offers a built-in battery to backup any emergency condition (UPS). MIL-STD-810G rated can be satisfied by most light duty vehicle shock/vibration environment. GNSS with 4G LTE can be used for location and route optimization, and the option for Beidou can cover most global navigation satellite system. There are three external antenna SMA ports for critical outdoor application to have better sensitivity and performance.

1.2 Features

- NXP (Freescale) i.MX6DL Dual Core Cortex-A9 1.0 GHz SOC, 1GB DRAM, 4GB eMMC with Android 4.4.2
- 7" WSVGA (1024 x 600) LCD with capacitive touch screen
- Built-in 4G LTE, WLAN/BT and GNSS include Beidou support. Support external antenna via SMA with better sensitivity for 4G LTE and GNSS.
- Built-in battery pack (3.6V, 2400mA) as UPS for emergency status include notification to backed office and data backup
- Design for vehicle 12/24V power system and MIL-STD-810G shock/vibration standard
- One analog video input to dedicated video processor for real-time display application
- Multiple isolation Digital Input/Output interface and support vehicle speed line input for distance measurement
- Excellent noise suppression technology for built-in voice recognition application

1.3 Product Specifications

Specifications		
Core	Processor	NXP (Freescale) Cortex-A9 i.MX6DL Dual Core 1.0 GHz
	Memory	1GB DDR3 on board
	Graphic	OpenGL® ES 2.0 3D graphics accelerator with a shader and a 2D graphics accelerator
	Operating System	Android KitKat 4.4.2
Storage	eMMC	4GB on board
	SD Card	1 x external accessible push-push type Micro-SD slot with cover
Display	Type	7" TFT LCD
	Resolution	WSVGA (1024 x 600)
	Brightness	500 cd/m2 (typical)
	Viewing Angle (H/V)	150/145 degree
	Contrast Ratio	700
	Backlight Lifetime	15000 Hrs

Touchscreen	Type	Capacitive 2 points multi-touch (Gesture)
	Construction	Glass-Film-Film
	Transparency	≥85%
Multimedia	Speaker	1 x Internal 2W Speaker
	Microphone	2 x Internal Microphone for Noise Suppression
Sensors	Ambient Light Sensor	Sensitive to visible and infrared light
	Motion Sensor	3-axis ±2g/4g/8g Accelerometer
I/O Interface	Standard I/O Port	1 x Micro-SD Slot 1 x SIM Slot
	Extended I/O Port	1 x System Power Input 2 x 2-wire RS-232 1 x USB 2.0 Host 6 x ISO DI (Dry contact) & 2 x ISO DO (Open collector output, driving by relay) 1 x Analog Video CVBS Input
	LED	1 x LED for Power
	Reset Button	1 x Hardware Reset Switch (Right Side)
Wireless Communication	WLAN/Bluetooth	IEEE 802.11 b/g/n and Bluetooth V4.0 Class 1.5 (Internal Antenna)
	WWAN (Option)	Sierra Wireless MC7304 via Mini PCIe Slot for EU - LTE: B1, B3, B7, B8, B20 / HSPA+ UMTS: B1, B2, B5, B6, B8 (*1) Sierra Wireless MC7354 via Mini PCIe Slot for US - LTE: B2, B4, B5, B13, B17, B25 / HSPA+ UMTS: B1, B2, B4, B5, B8 / CDMA EVDO: BC0, BC1, BC10(*2) (External Antenna via SMA,P/N: 1750008257-01& 1750008196-01)
GNSS	Sensitivity	GPS (-161 dBm), GLONASS (-158dBm) with 56-channel & AGPS support and Beidou by project based (External Active Antenna via SMA, P/N: 1750008257-01)
Power System	Voltage Input	Supports 12/24V Car Power System. (9~32V wide DC input)
	Intelligent Vehicle Power Management	System power on/off management Support Wake up Events: - Alarm (RTC) Wake up - Wake up by Call/SMS - Wake up by G-sensor System power protection System monitoring and diagnostic
	Backup Battery Pack (Option)	3.6V, 2400mAh - 30 Mins for Full Loading Operation - 2 Hrs for Low Power Condition Operation - Charging Time: 3 Hrs
Mechanical	Mounting	AMPS Mounting ARM Compatible
	Dimension (W x D x H)	205 mm x 139 mm x 33.5 mm
	Weight	820 g (incl. Battery)

Environment	Operating Temperature	-4 °F to +158 °F (-20 °C to +70 °C)
	Storage Temperature	-4 °F to +158 °F (-20 °C to +70 °C)
	Vibration/Shock	MIL-STD-810G
	Vehicle Regulation	E-Mark (E13) (12/24V System), ISO 7637-2, SAE J1455
	Safety	UL/cUL, CB
	Certifications	CE, FCC, CCC

■ ***1, *2 Wireless Frequency(MHz) List:**

WWAN

Sierra Wireless MC7304 via Mini PCIe Slot for EU

- LTE: B1 (2100), B3 (1800), B7 (2600), B8 (900), B20 (800)

- HSPA+ UMTS: B1 (2100), B2 (1900), B5 (850), B6 (800), B8 (900)

Sierra Wireless MC7354 via Mini PCIe Slot for US

- LTE: B2 (1900), B4 (AWS1700/2100), B5 (850), B13 (700), B17 (700), B25 (1900G)

- HSPA+ UMTS: B1 (2100), B2 (1900), B4 (AWS1700/2100), B5 (850), B8 (900) / CDMA EVDO: BC0 (800), BC1 (1900), BC10 (800)

1.4 Dimensions

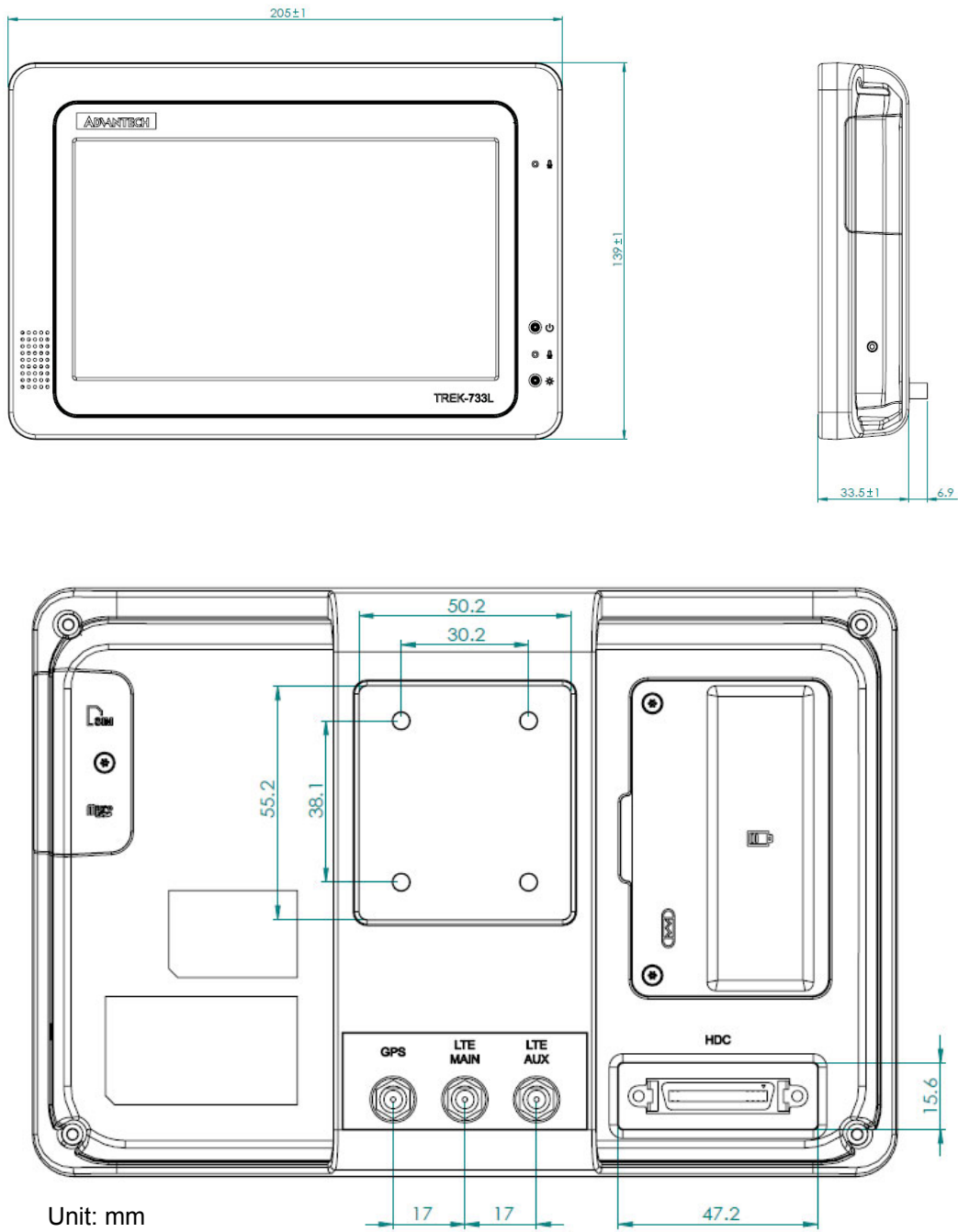

Figure 1.1 TREK-733L dimensions

Chapter 2

System Setup

This chapter details system setup on TREK-733L.

Sections include:

- A Quick Tour of the Mobile Data Terminal
- Installation Procedures

2.1 A Quick Tour of the TREK-733L Mobile Data Terminal

Before starting to set up the Mobile Data Terminal, take a moment to become familiar with the locations and functions of the controls, drives, connectors and ports, which are illustrated in the figures below. When the Mobile Data Terminal is placed inside truck glove cabinet or under the passenger's seat next to the driver, its front appears as shown in Figure 2.1.



Figure 2.1 Front view of TREK-733L

2.1.1 Power LED Behavior

System Status	Green	Red	STATUS	Note
System Off	OFF	OFF	No BLINK	
Ext. DC in & System ON	ON	OFF		
System Power On then cut external DC in	OFF	ON	BLINK*1	*1 BLINK :Light 1 sec and dark 3 sec(period is 4 sec)
VPM Boot loader update	OFF	ON	BLINK*2	*2 BLINK : Light 300ms and dark 300ms (period is 600ms)

2.1.2 Light Sensor

Auto brightness function default is disable. User can set up brightness level via Android setting.

2.1.3 Reset Button

TREK-733L is able to use reset button to reboot system. Press this switch to reset the system without power off the system.

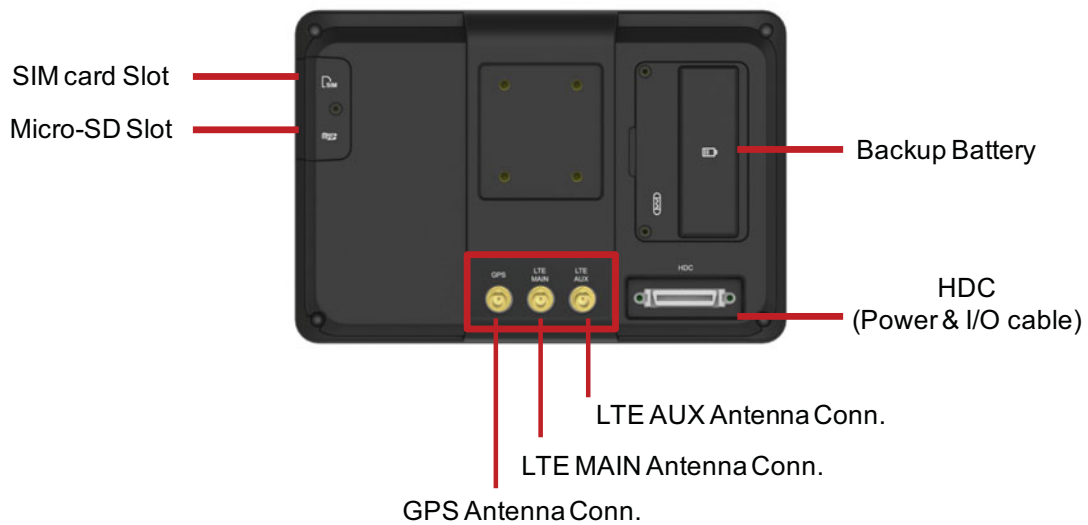

Figure 2.2 Rear view of TREK-733L

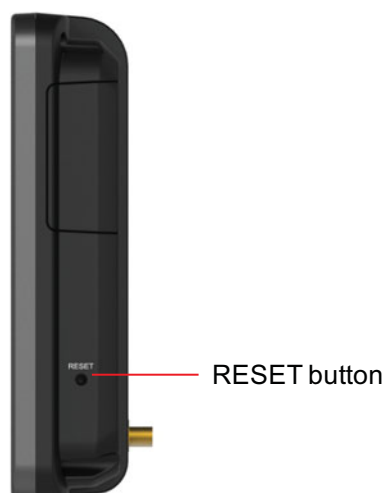

Figure 2.3 Side view of TREK-733L

2.2 Installation Procedures

STEP 1:

When you install TREK-733L, the first step will connect the power and ignition correctly. TREK-733L power cable is designed to connect battery directly. TREK-733L can be switched ON/OFF by the ignition signal. In case of OS/APP hang, reset button is available for system boot up.

2.2.1 Connecting the Power Cord

STEP 2:

Connect the High Density Cable (HDC) to the DC inlet of TREK-733L. On the open-wire end, one pin is reserved for positive voltage and is marked "B+" which needs to be connected to the power "+" side; one pin is reserved for ground and is marked "GND"; which needs to be connected to the power "-" side. And, one pin is reserved for the ignition signal with an "ACC" mark.

Table 2.1: Pin Definition of Power Cord		
Pin	Definition	Color
1	+ (B+)	Red
2	-(GND)	Black
3	Ignition (ACC)	Green



Figure 2.4 HDC Connector & Power/IO Cable photo (HDC)



HDC Connector

2.2.2 Connecting the WWAN signal

STEP 3:

After system boot up correctly, insert SIM card and start APN setting for WWAN connection.(Default APN is blank).

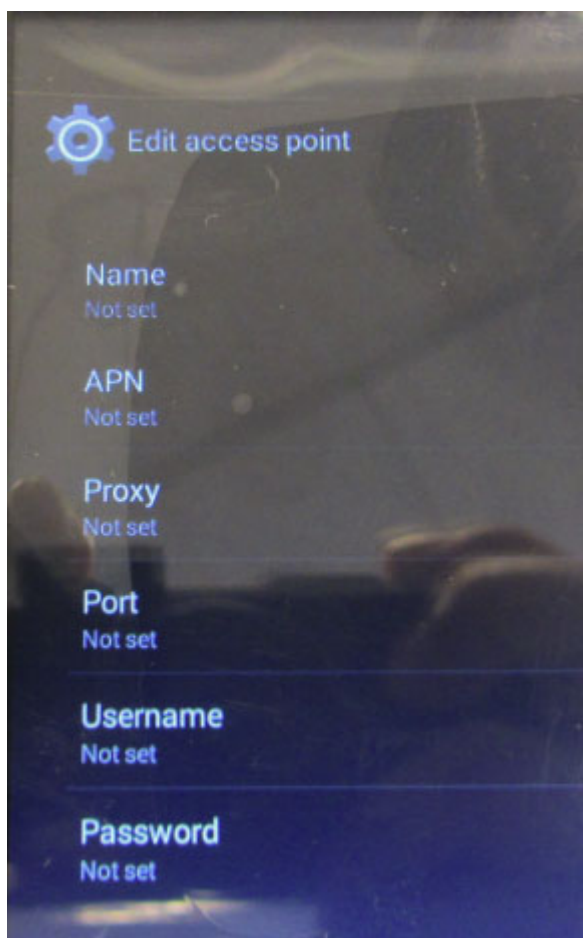

Chapter 3

Hardware & Peripheral

This chapter details the installation of hardware for TREK-733L.

Sections include:

- Installing the Storage Device and SIM Card
- Installing Optional Accessories

3.1 Installing the Storage Device and SIM Card

Users can install SIM card and storages (micro-SD card) easily on TREK-733L. Micro SD card is an optional storage. In order to access Micro-SD connector and SIM card, system has to be turned off. Then, release the side door on the right side of TREK-733L.

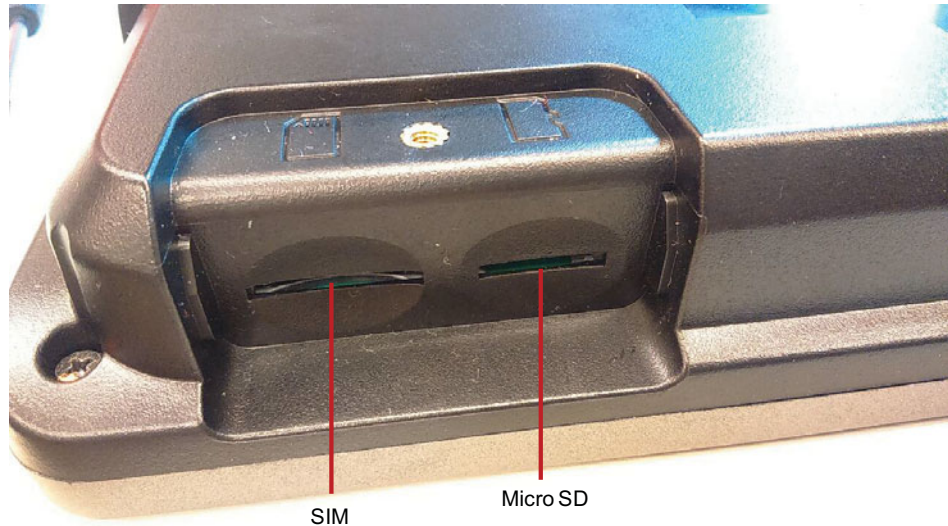

3.2 Installing Optional Accessories

Optional accessories, like RAM mount kits (TREK-MNT-301E, TREK-MNT-302E, TREK-MNT-303E) or other functional modules are available for purchase to complement TREK-733L. All of standard RAM-mount type mounting with M4 type screws only.





TREK-MNT-301E



TREK-MNT-302E



TREK-MNT-303E

3.3 Installing Standard Wireless Options

For TREK-733L, WWAN, Bluetooth/WiFi and GNSS modules are already installed inside of unit. (WWAN is available for option.)

3.3.1 LTE/GNSS (External Antenna)

Position of external LTE/GNSS antenna port is shown as below.



LTE AUX Antenna Conn.

LTE MAIN Antenna Conn.

GPS Antenna Conn.

Chapter 4

Pin Assignments

This chapter explains pin assignments of the TREK-733L.

4.1 Power and I/O cable

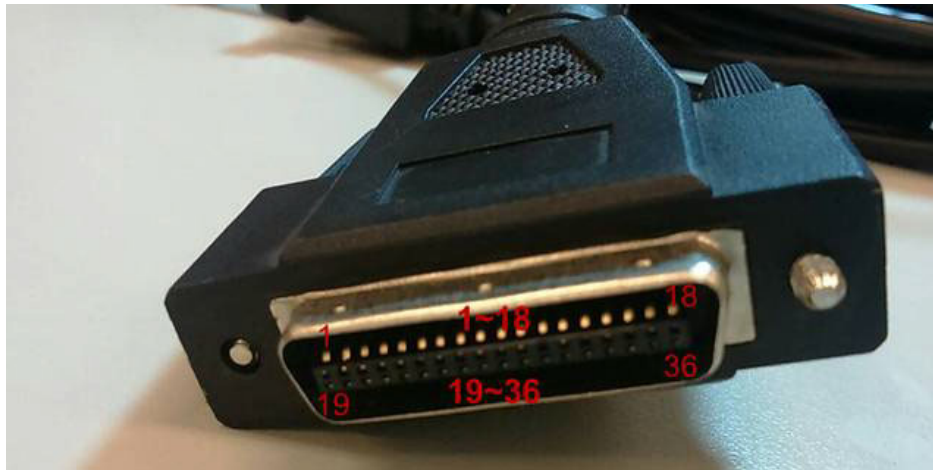
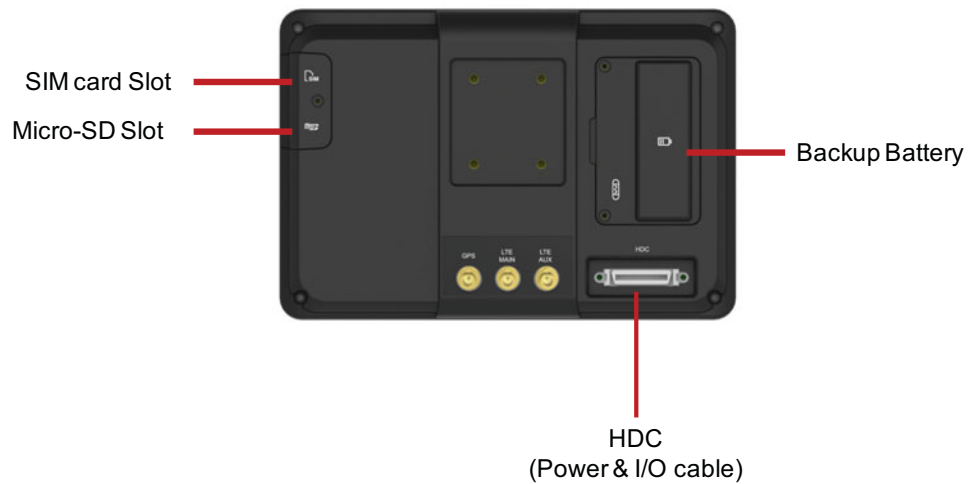

36Pin connector MB side pin define		
Pin Number	Net name	Description
1	+VCB	Car battery positive
2	+VCB	
3	+VCB	
4	+VCB	
5	+VCB	
6	IGNITION	Ignition signal input pin
7		NC
8	+V5_HD_USB	USB 5V Power (Share 5V,3A with RS232-1, RS232-2 & USB)
9	+V5_HD_RS1	RS-232 5V power (Share 5V,3A with RS232-1, RS232-2 & USB)
10	+V5_HD_RS2	RS-232 5V power (Share 5V,3A with RS232-1, RS232-2 & USB)
11	ISO_DI_5	Isolation Digital Input 5
12	ISO_DI_6	Isolation Digital Input 6 (support Speed Line)
13	USB_HD_DP_H	USB D+
14	USB_HD_DN_H	USB D-

15	GND	Digital signal GND
16	GND	Digital signal GND
17	RS232_TX2_HD	RS-232 Port 2 TX
18	RS232_RX2_HD	RS-232 Port 2 RX
19	GND_CAR_BAT	Car battery negative
20	GND_CAR_BAT	
21	GND_CAR_BAT	
22	GND_CAR_BAT	
23	GND_CAR_BAT	
24	ISO_GND	Isolation Ground
25	ISO_GND	Isolation Ground
26	ISO_DO_DRAIN1	Isolation Digital Output 1
27	ISO_DO_DRAIN2	Isolation Digital Output 2
28	ISO_DI_1	Isolation Digital Input 1
29	ISO_DI_2	Isolation Digital Input 2
30	ISO_DI_3	Isolation Digital Input 3
31	ISO_DI_4	Isolation Digital Input 4
32	GND	Digital signal GND
33	CVBS_HD	Analog Video CVBS Input
34	GND	Digital signal GND
35	RS232_TX1_HD	RS-232 Port 1 TX
36	RS232_RX1_HD	RS-232 Port 1 RX

4.1.1 RS-232-1/RS-232-2 Connector



RS-232-1 connector pin define		
Pin Number	Pin Name	Description
1		
2	RS232_RX1_HD	RS-232 Port 1 RX
3	RS232_TX1_HD	RS-232 Port 1 TX
4	?	
5	GND_RS1	RS-232 Port 1 GND
6	?	
7	?	
8	?	
9	+V5_HD_RS1	RS-232-1 5V power (Share 5V,3A with RS232-2 & USB)
RS-232-2 connector pin define		
Pin Number	Pin Name	Description
1		
2	RS232_RX2_HD	RS-232 Port 2 RX
3	RS232_TX2_HD	RS-232 Port 2 TX
4	?	
5	GND_RS2	RS-232 Port 2 GND
6		
7		
8		
9	+V5_HD_RS2	RS-232-2 5V power (Share 5V,3A with RS232-1 & USB)

4.1.2 ISO DI/DO Connector



DIO DB9 connector pin define		
Pin Number	Pin Name	Description
1	ISO_DO_1	Isolation Digital Output 1
2	ISO_DO_2	Isolation Digital Output 2
3	ISO_DI_5	Isolation Digital Input 5
4	ISO_DI_6	Isolation Digital Input 6 (support Speed Line)
5	GND	Digital signal GND
6	ISO_DI_2	Isolation Digital Input 2
7	ISO_DI_1	Isolation Digital Input 1
8	ISO_DI_4	Isolation Digital Input 4
9	ISO_DI_3	Isolation Digital Input 3

4.1.3 USB Connector



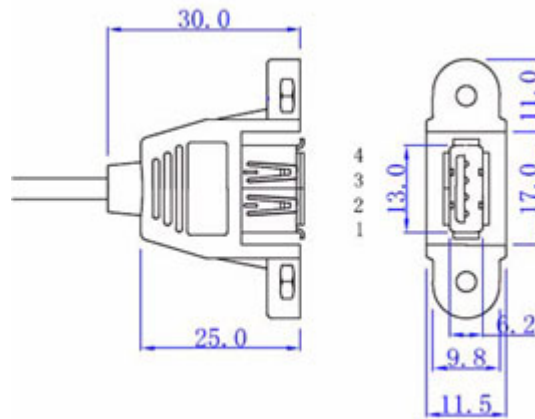

Standard USB A type female connector		
Pin Number	Pin Name	Description
1	+V5_USB	USB 5V power (Share 5V,3A with RS232-1 & RS232-2)
2	USB_D-	USB Data-
3	USB_D+	USB Data+
4	GND	Drain Wire

4.2 Power & I/O Cable

(P/N: 1700025781-01)

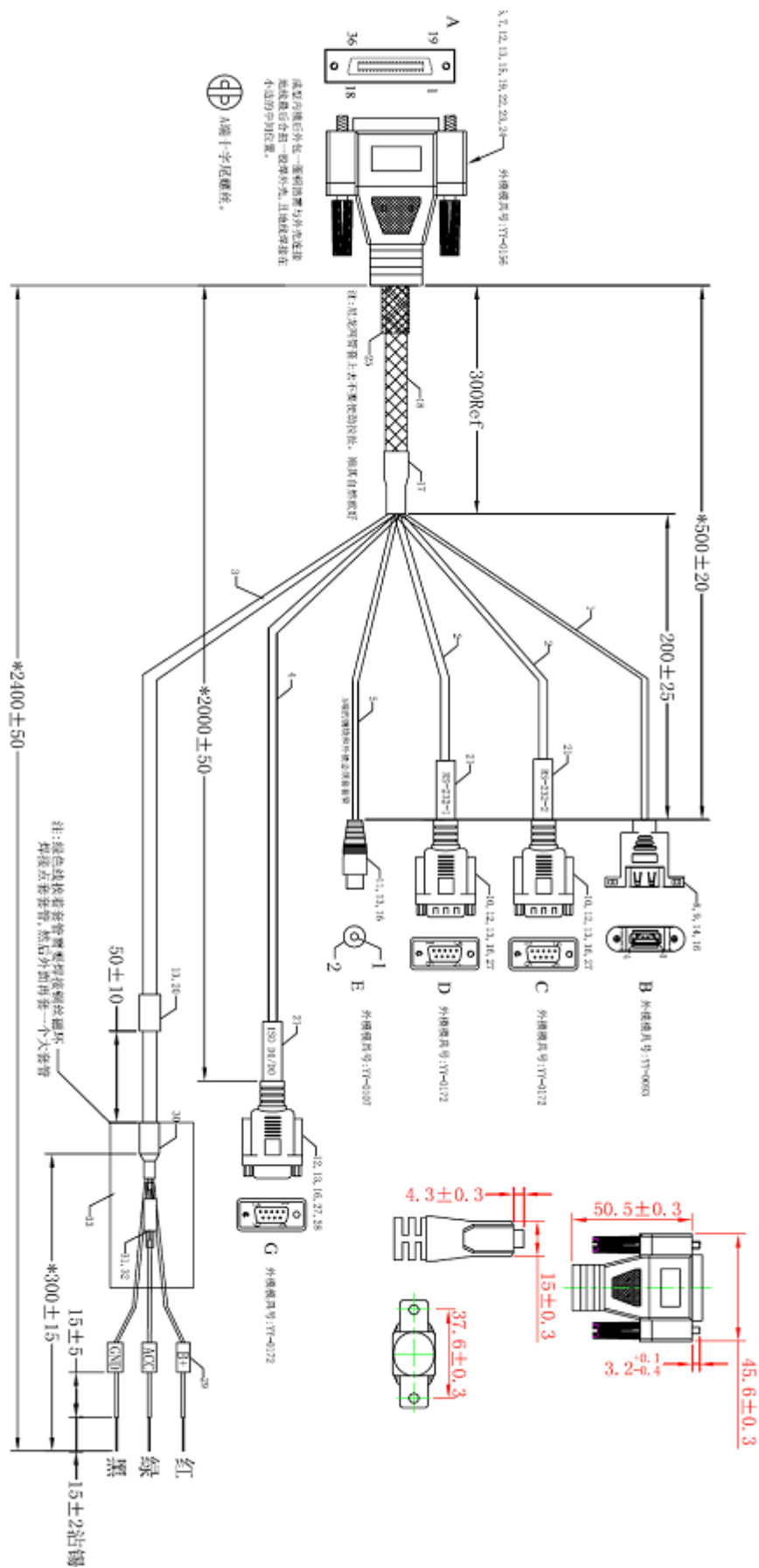

Chapter 5

Welcome to Android

About Android 4.4

This guide introduces the Android 4.4 software available on Nexus and Google Play edition mobile devices. It doesn't describe hardware details such as SIM card instructions, battery information, specs and so on.

For comprehensive information about all types of Android phones and tablets, including more details about Nexus and Google Play edition devices, visit support.google.com/android.

5.1 Navigation buttons

At the bottom of every Nexus screen, no matter what you're doing, you'll always find the navigation bar with three buttons:



Back

Opens the previous screen you were working in, even if it was in a different app. Once you back up to the Home screen, you can't go back any further.



Home

Opens the central Home screen. To open Google Now, swipe up.



Recent apps

Opens a list of thumbnail images of apps you've worked with recently. To open an app, touch it. To remove a thumbnail from the list, swipe it left or right.

Some apps hide these buttons temporarily or fade them to small dots in the same position. To bring them back, touch the dots, touch the screen in the middle or swipe up from the bottom.

5.1.1 Organize your Home screens

To change the wallpaper for your Home screens, touch & hold the background.

To add an app icon to a Home screen:

1. Go to the Home screen where you want to place the app.
2. Touch the  All Apps icon.
3. Swipe from right to left, if necessary, to find the app that you want.
4. Touch & hold the app until the Home screen appears, slide it into place and lift your finger.

5.1.2 Touch & type

To select or activate something, touch it.

To type something, such as a name, password or search terms, just touch where you want to type. A keyboard pops up that lets you type into the field.

Other common gestures include:

- **Touch & hold.** Touch & hold an item on the screen by touching it and not lifting your finger until it responds. For example, this is how you access accents and other special characters on the keyboard.
- **Touch, hold & drag.** Touch & hold an item for a moment and then, without lifting your finger, move your finger on the
- screen until you reach the target position. For example, you can move apps around on the Home screen.
- **Swipe or slide.** Quickly move your finger across the surface of the screen, without pausing when you first touch (so you don't drag something instead). For example, you can slide a Home screen left or right to view the other Home screens.
- **Double-tap.** Tap quickly twice on a web page, map or other screen to zoom. For example, double-tap a picture in Chrome to zoom in, and double-tap again to zoom out.
- **Scale.** In some apps (such as Maps, Chrome and Gallery), you can scale by placing two or more fingers on the screen at once and pinching them together (to enlarge scale) or spreading them apart (to reduce it). Alternatively, in some apps you can double-tap and then, without lifting your finger, drag up to reduce or down to enlarge the scale of the image.
- **Rotate the screen.** The orientation of most screens rotates with your device as you turn it. To lock or unlock a tablet's vertical orientation, swipe down from the top right of any screen and touch the Rotation icon in Quick Settings. To do the same thing on a phone, go to Settings > Device > Display.



You can open your device's Settings app from the All Apps screen or from Quick Settings.

For example, to change notification sounds, volumes and more, go to Settings > Device > Sound. To change brightness, font size and more, go to Settings > Device > Display.

5.2 Use the keyboard

5.2.1 Enter & edit text

Use the on-screen keyboard to enter text. Here's what it looks like on a Android device:

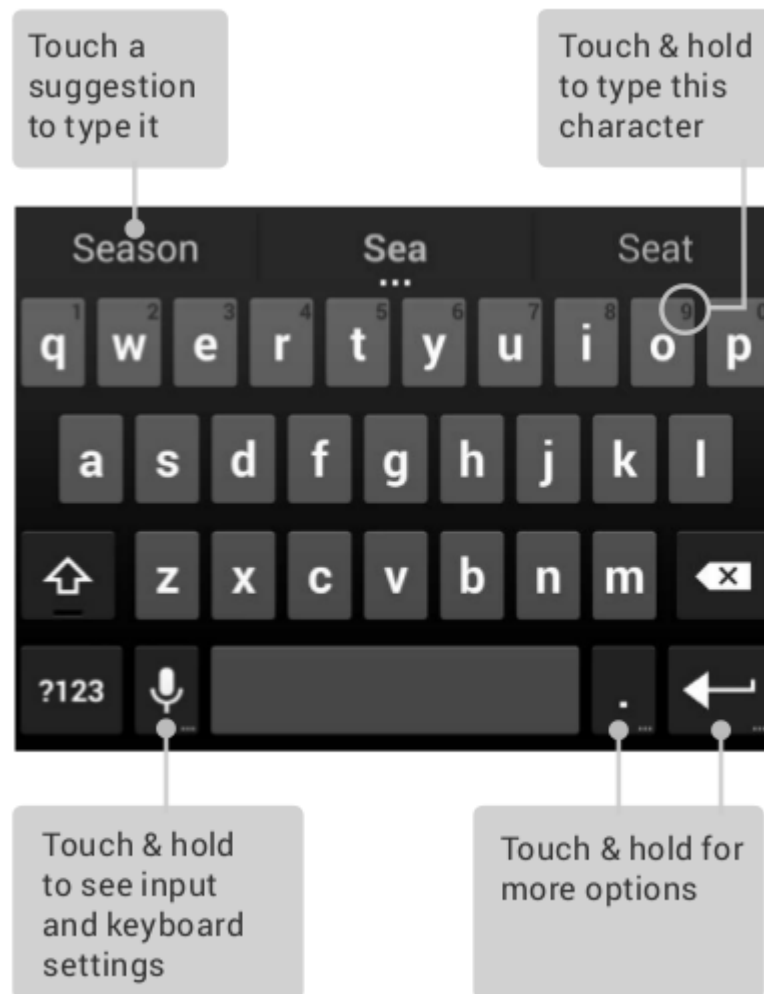







Keyboards on tablets work in a similar way. To make the keyboard go away, touch the Back button below it.

Some apps open the keyboard automatically. In others, you first need to touch where you want to type.

5.2.2 Basic editing

- **Move the insertion point.** Touch where you want to type. The cursor blinks in the new position, and a blue tab appears below it. Drag the tab to move the cursor.
- **Select text.** Touch & hold or double-tap within the text. The nearest word is highlighted, with a tab at each end of the selection. Drag the tabs to change the selection. The tab disappears after a few moments. To make it reappear, touch the text again.
- **Delete text.** Touch  to delete selected text or the characters before the cursor
- **Type capital letters.** Touch the Shift key once to switch to capital letters for one

letter. Shift key while you type. When you release Or touch & hold  the key, the lower case letters reappear.

- **Turn caps lock on.** Double-tap or touch & hold  Shift key, so it changes to . Touch  Shift key again to return to lower case.
- **Cut, copy, paste.** Select the text you want to manipulate. Then  Cut or  Copy icons. If there's something on the clipboard to paste, you'll also see a  Paste button:\.

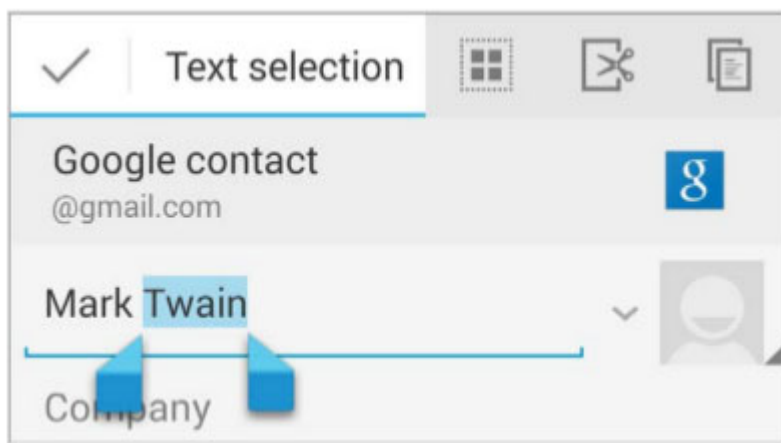

5.2.3 Use next-word suggestions

1. Touch the location where you want to input text.
2. Start typing out a word. When the word you want is displayed in a list above the keyboard, touch it.
3. Continue to touch words unless the one that you want doesn't appear. If so, type it. Android continues to suggest words as you type.



To change your keyboard and input methods, go to Settings > Personal > Language & input.

To turn next-word suggestions on or off, go to Settings > Personal > Language & input > Keyboard & input methods > Android keyboard. Touch the Settings icon, then tick the box next to Next-word suggestions.

5.2.4 Gesture Typing

Gesture Typing works best for English. Quality varies for other languages and some don't support it yet.

To input a word using Gesture Typing:

1. Touch the location where you want to type to open the keyboard.
2. Slide your finger slowly across the letters of the word you want to input.
3. Release your finger when the word that you want is displayed in the floating preview or the middle of the suggestion strip.

To select one of the other words in the suggestion strip, touch it. If the word that you want isn't shown while using Gesture Typing, you can type it out manually. If you gesture a word and want to change it, touch the word to see other choices in the suggestion strip.

5.2.5 Use Gesture Typing without the space bar

When you use Gesture Typing, there's no need to use the space bar - just continue to slide your finger across the letters you want to input, then lift your finger to start the next word.



To change Gesture Typing settings, go to Settings > Language & input > Keyboard & input methods > Android keyboard. Then touch Settings and look under Gesture Typing.

5.2.6 Keyboard dictionaries

To manage keyboard dictionaries, go to Settings > Personal > Language & input.

Personal dictionary

You can add your own words to your personal dictionary so that your device remembers them. To add a word or phrase, including an optional shortcut, touch the Settings icon beside the keyboard that you're using, then Personal dictionary and the language of the dictionary that you want to modify, then the Add icon.

Add-on dictionaries

1. Touch the  Settings icon next to Google keyboard or whatever keyboard you're using.
2. Touch Add-on dictionaries.
You'll see dictionaries for other languages that you can download to your device.
3. Touch the dictionary you want, then Install.

5.2.7 Type by speaking

You can speak to enter text in most places where you can enter text with the on-screen keyboard.

1. Touch a text field, or a location in text you've already entered in a text field.
2. Touch the  Microphone key on the on-screen keyboard.

3. When you see the microphone image, speak what you want to type. In English only, you can also say “comma”, “full stop”, “question mark” or “exclamation mark” to enter punctuation. When you pause, what you spoke is transcribed by the speech-recognition service and entered in the text field, underlined. You can touch the Delete key to erase the underlined text. If you start typing or entering more text by speaking, the underline disappears. To improve processing of your voice input, Google may record a few seconds of ambient background noise in temporary memory at any time. This recording remains on the device only fleetingly and is not sent to Google.



To change your speech settings, go to Settings > Personal > Language & input.

5.3 Settings

Most apps include their own settings, typically available from Menu > Settings on Nexus devices or from the Menu button on some Google Play edition devices.

The fastest way to adjust system settings that you access frequently, such as Wi-Fi or brightness, is through Quick Settings. Here are the Quick Settings for a Nexus phone:



To open Quick Settings:

- On tablets: Swipe down from the top right corner of any screen.
- On phones: Swipe down from the top of the screen with two fingers.

To open the Settings app from Quick Settings, touch the Settings icon.



The Settings app controls the core Android settings for networks, hardware, location, security, language, accounts and so on.

You can also open the Settings app from  All Apps. To get more information about most Settings screens, choose Help from the screen's menu.

These are the main types of system settings available. Click the links to see related help articles.

- **Wireless & networks.** Wi-Fi, Bluetooth, data usage, Android Beam and related settings.
- **Device.** Sound, battery, sleep and other display settings.
- **Personal.** Location, language and backup/reset options.
- **Personal > Security.** Passwords and certificates, app verification, screen lock and encryption.
- **Accounts.** Sync and other account settings.
- **System Date, time, accessibility and device information.**

Some useful settings are also available from the Google Settings app.

5.4 Accessibility

To use the accessibility options, open Settings > System > Accessibility.

To view detailed information about setting up these options, visit [Nexus Accessibility](#). Options for people with visual impairments include the following:

- **TalkBack** is a pre-installed screen reader from Google. It uses spoken feedback to describe events, such as notifications, and the results of your actions, such as opening an app.
- **Explore by Touch** is a system feature that works with TalkBack, allowing you to touch your device's screen and hear what's under your finger via spoken feedback. This feature is helpful to people with no vision.
- **Accessibility** settings let you modify your device's display and sound options, such as increasing the text size, changing the speed at which text is spoken and more. If you have low vision and don't plan to use Explore by Touch, visit support.google.com/android to see Help content formatted for sighted users. You can make reading and navigating this material easier by increasing the text size – just open Chrome, go to Menu > Settings > Accessibility, and drag the slider to adjust the text size.

You can also try magnification gestures, which allow you to zoom in and out, as well as temporarily magnify what's under your finger. To try magnification gestures, go to Settings > Accessibility > Magnification gestures.

5.5 ADB (Android Debug Bridge)

Android Debug Bridge (adb) is a versatile command line tool that lets you communicate with an emulator instance or connected Android-powered device. It is a client-server program that includes three components: A client, which sends commands. The client runs on your development machine.

You can invoke a client from a shell by issuing an adb command.

Other Android tools such as DDMS also create adb clients.

A daemon, which runs commands on a device.

The daemon runs as a background process on each emulator or device instance. A server, which manages communication between the client and the daemon. The server runs as a background process on your development machine.

5.5.1 ADB connect device:

- ADB via Wifi Mode
- 1. Enable ADB function on TREK-733L, to put startup folder into USB driver and connect to TREK-733L.
- 2. Open wifi on TREK-733L and check PC and TREK-733L are under wifi environment.
- 3. Execute ADB under `c:\>` and type `adb connect xxx.xxxx.xxxx:55555` (xxx is wifi IP address on TREK-733L)

```
C:\android\tools\ADB\windows_adb_command>adb connect 192.168.0.197
connected to 192.168.0.197:55555
```

- 4. Copy the apk what you want to install in same path and type `adb install xxxx.apk` (xxx is apk name).

```
C:\android\tools\ADB\windows_adb_command>adb install u-center-GPS-1.05.apk
23 KB/s (153874 bytes in 6.391s)
  pkg: /data/local/tmp/u-center-GPS-1.05.apk
Success
C:\android\tools\ADB\windows_adb_command>
```

5.6 APK install

The APK install be used USB to install/reinstall applications.

If want to install new applications to Android system which are use change `start_up.sh` file. The android was used linux command “pm” to install/reinstall not typical applications. The `start_up.sh` executed by OS automatic but need follow constant folder structure. Those structure are first layer direct must exist “StartUp” folder and create a file of “`start_up.sh`” when those structure exist on the USB. If user plug USB into the device. The system will automatic launch those commands .



5.6.1 Prepare APK install disk

1. format USB Disk to FAT32.
2. make a "StartUp" direct to storage.
3. create a file of "Start_up.sh" on the StartUp folder.
4. write command to Start_up.sh.

5.6.2 How to write StartUp.sh install APK

1. install APK
command:
pm install xxx folder /xxx.apk
2. reinstall APK
command:
pm install -r xxx folder /xxx.apk
for example:
pm install /mnt/media_rw/udisk/startup/151105/
PINCode_4G_v2.0.0_1105_1122.apk

How to remove application

1. understand application install name
usage ADB to see /data/app

```
root@trek733l_6dq:/data # cd app
root@trek733l_6dq:/data/app # ls
com.advantech.advsensortest-1.apk
com.advantech.advwwan-1.apk
com.lightmeterpro.luxmeter-1.apk
com.locosys.gpsfox-1.apk
com.ublox.ucenter-1.apk
ing
root@trek733l_6dq:/data/app #
```

2. Use linux pm command to remove applications same as install apk use Start_Up.sh command:
pm uninstall xxx folder com.xxxx.xxx|
for example:
to remove advwwan
pm uninstall com.advantech.advwwan

5.7 Reload System Image

5.7.1 eMMC Image Reload from SD Card

Use SD reload image to eMMC follow step

1. Prepare Image file seems xxx.img.md5 and xxx.img



2. Use md5sum to check file
the command was "md5sum -c xxx.img.md5"

```
root@linearog-BM6AE-BM1AE-BP1AE:/media/linearog/cd306be4-8cd1-4ce6-9a38-431dd3cc1772/Work/project/2016Q34/Seaston_Tablet/Tools/工廠/Factory_Release/GE_HIT-W101C_Factory_release_20160811/Image/eMMC_Image# md5sum -c HIT-W101C-GE_20160811_001.img.md5
HIT-W101C-GE_20160811_001.img: 正確
```

3. Use "df -h" to check disk position

```
檔案系統      容量  已用  可用  已用%  掛載點
udev          7.8G   0    7.8G   0%    /dev
tmpfs         1.6G   9.9M  1.6G   1%    /run
/dev/sda2     92G    16G   72G   18%    /
tmpfs         7.8G   286M  7.5G   4%    /dev/shm
tmpfs         5.0M   4.0K  5.0M   1%    /run/lock
tmpfs         7.8G   0    7.8G   0%    /sys/fs/cgroup
/dev/sda1     4.9G   3.6M  4.9G   1%    /boot/efi
tmpfs         1.6G   92K   1.6G   1%    /run/user/1000
/dev/sdd1     196G   147G   50G   75%    /media/linearog/0AA62B03A6
/dev/sdd5     196G   50G   146G   26%    /media/linearog/0682979E82
/dev/sdd3     206G   75G   132G   37%    /media/linearog/64F0AD0CF0
/dev/sda4     505G   182G  298G   38%    /media/linearog/cd306be4-8
/dev/sda3     276G   107G  155G   41%    /media/linearog/34c11694-9
/dev/sdb1     110G   60M   105G   1%    /media/linearog/SSD1
/dev/sdc      235G   123G  101G   56%    /media/linearog/SSD2
/dev/sdi4     14G    34M   13G   1%    /media/linearog/data
/dev/sdi5     488M   2.3M  456M   1%    /media/linearog/system
/dev/sdi6     488M   2.3M  456M   1%    /media/linearog/cache
/dev/sdi7     6.8M   45K   6.2M   1%    /media/linearog/device
```

4. Use dd command to write a Image then execute meed wait a moment
Those command was "dd if=HIT-W101C-GE_20160811_001.img of=/dev/sdi
conv=sync"

```
dd if=HIT-W101C-GE_20160811_001.img of=/dev/sdi conv=sync  
輸入 7744512+0 個紀錄  
輸出 7744512+0 個紀錄  
3965190144 bytes (4.0 GB, 3.7 GiB) copied, 1461.8 s, 2.7 MB/s
```

5.7.2 Reset your Android One to factory settings

You can remove all data from your Android One device by resetting it to factory settings, or doing a "force reset." You can do so by either using the Settings menu to erase all your data or by using the Recovery menu.

Important: By performing a factory data reset, all data — like your apps, photos, and music — will be wiped from the device. Any data stored in your Google Account will be restored when you sign in, but all apps and their data will be deleted and cannot be restored. Learn how to back up your data before performing a factory data reset.

Erase data using the Settings menu

To perform a factory data reset using the Settings menu, follow these steps:

1. Before you reset your Android One, see options for backing up your data.
 2. On your device, open the Settings menu Settings .
 3. Under "Personal," touch Backup & reset.
 4. Under "Personal data," touch Factory data reset.
 5. Read the information on the screen and touch Reset device.
 6. If you have a screen lock, you'll need to enter your pattern, PIN, or password.
 7. When prompted, touch Erase everything to erase all data from your device's internal storage.
 8. When your device has finished erasing, select the option to reboot your device.
- You'll see the Welcome screen just as you did when you turned the device on for the first time. When you're done with the setup process, follow these steps to restore your data.

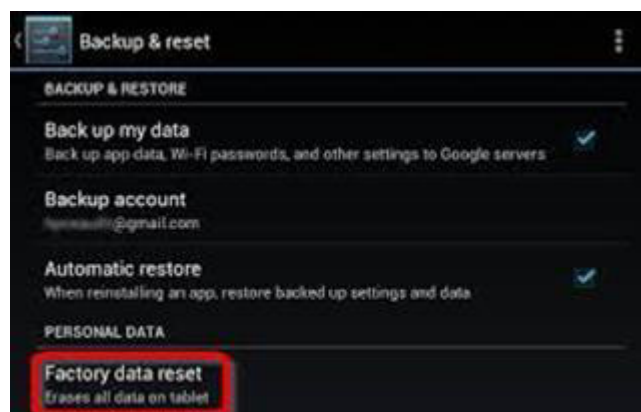

5.8 OTA update (over-the-air update)

Android devices in the field can receive and install over-the-air (OTA) updates to the system and application software. Devices have a special recovery partition with the software needed to unpack a downloaded update package and apply it to the rest of the system.

This section describes the structure of these packages and the tools provided to build them. It is intended for developers who want to make the OTA update system work on new Android devices and those who are building update packages for use with released devices.

5.8.1 Android device layout

The flash space on an Android device typically contains the following partitions.

boot

Contains the Linux kernel and a minimal root filesystem (loaded into a RAM disk). It mounts system and other partitions and starts the runtime located on the system partition.

system

Contains system applications and libraries that have source code available on Android Open Source Project (AOSP). During normal operation, this partition is mounted read-only; its contents change only during an OTA update.

vendor

Contains system applications and libraries that do not have source code available on Android Open Source Project (AOSP). During normal operation, this partition is mounted read-only; its contents change only during an OTA update.

userdata

Stores the data saved by applications installed by the user, etc. This partition is not normally touched by the OTA update process.

cache

Temporary holding area used by a few applications (accessing this partition requires special app permissions) and for storage of downloaded OTA update packages. Other programs use this space with the expectation that files can disappear at any time. Some OTA package installations may result in this partition being wiped completely.

recovery

Contains a second complete Linux system, including a kernel and the special recovery binary that reads a package and uses its contents to update the other partitions.

misc

Tiny partition used by recovery to stash some information away about what it's doing in case the device is restarted while the OTA package is being applied.

5.8.2 OTA from USB

1. Format USB Disk to FAT32.
2. Copy update.zip file to USB Disk first directory
3. Plug in USB Disk to device and wait 1x Sec
4. The system will automatically update system image



OTA from internal storage

1. Format USB Disk to FAT32.
2. Copy update.zip file to internal storage /Data/OTA

```
root@trek733l_6dq:/data/OTA #
```

3. Set system property "sys.update.start" to "1"
4. Waite 1x Sec
5. The system will automatically update system image

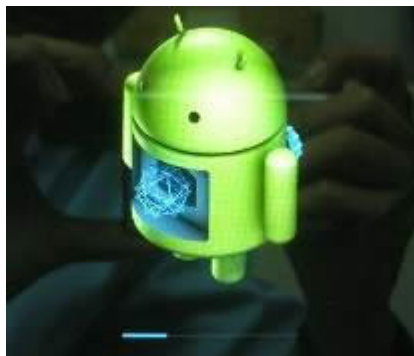

5.9 VPM Update

VPM was system power control and device periphery manager unit.

The VPM upgrade need install APK and follow some step.

Those Step are 1.Install update tool 2. select VPM version 3.Update VPM

5.9.1 Install update tool

Follow chapter "APK install" to install VPM upgrade tool of FirmwareUpdateTool_V1.0.apk .

The Command was

```
"pm install /mnt/media_rw/udisk/startup/VPM/FirmwareUpdateTool_V1.0.apk "
```



The APK installed will see FirmwareUpgrade tool on the apk list.

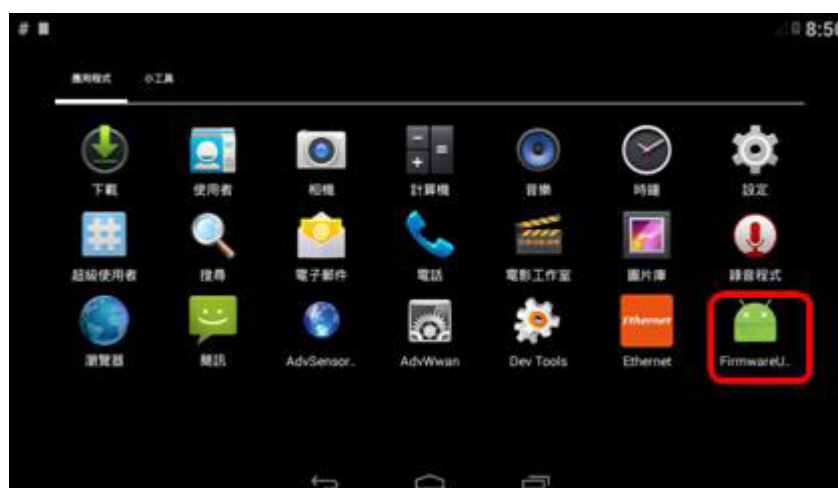

5.9.2 Update VPM

If want to upgrade firmware follow next step.

1. Double click FirmwareUpgrade to execute update tool

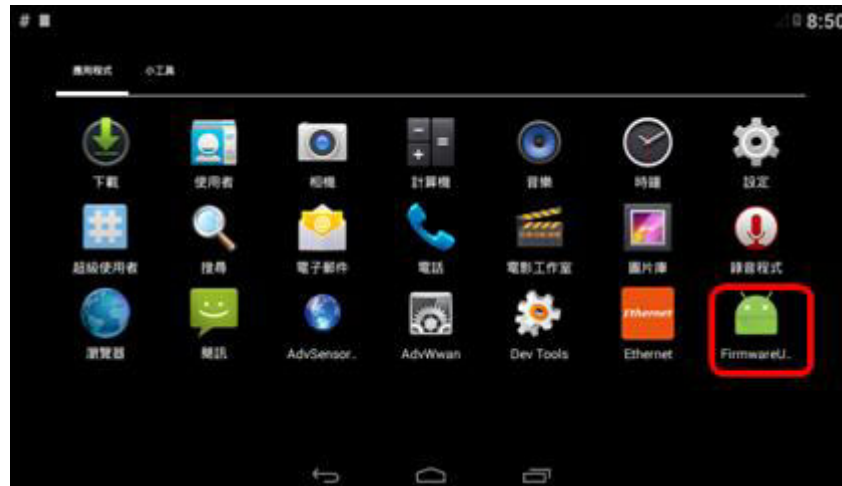

2. Use browser to select latest firmware version.

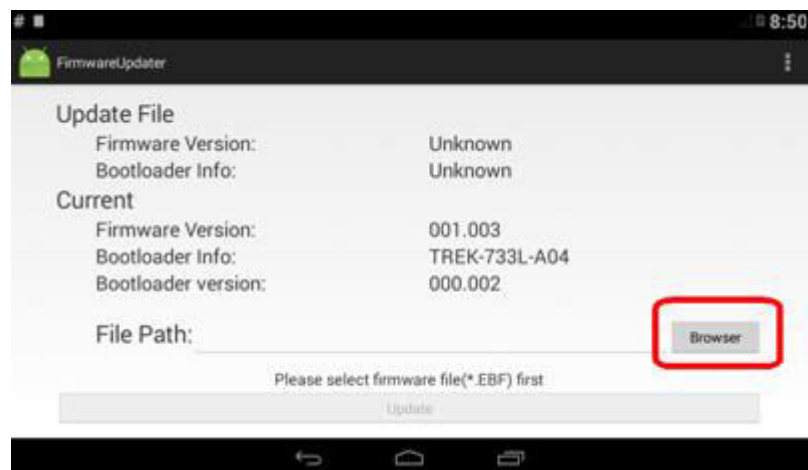

3. To select upgrade file location folder.

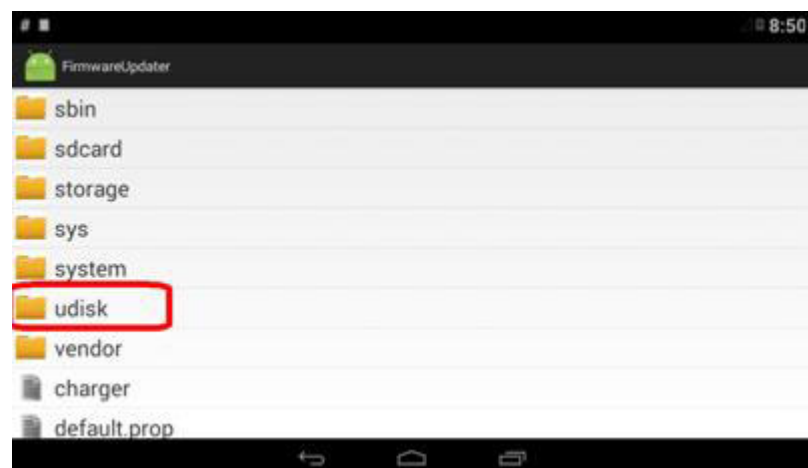

4. Select firmware file for upgrade

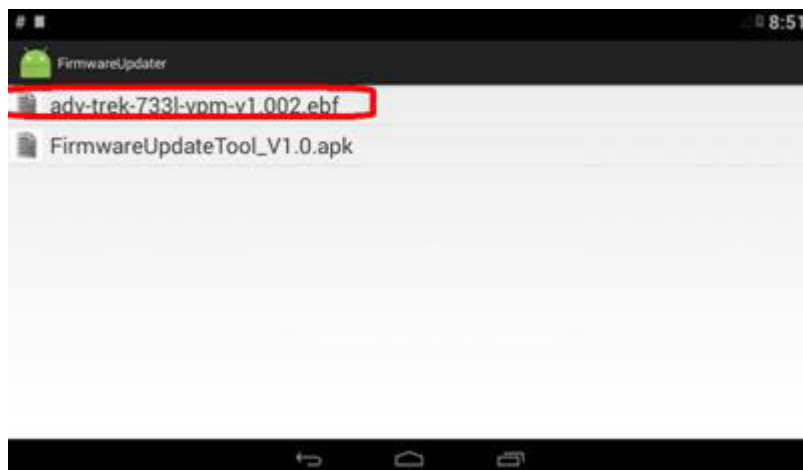

5. Press upgrade button to update firmware

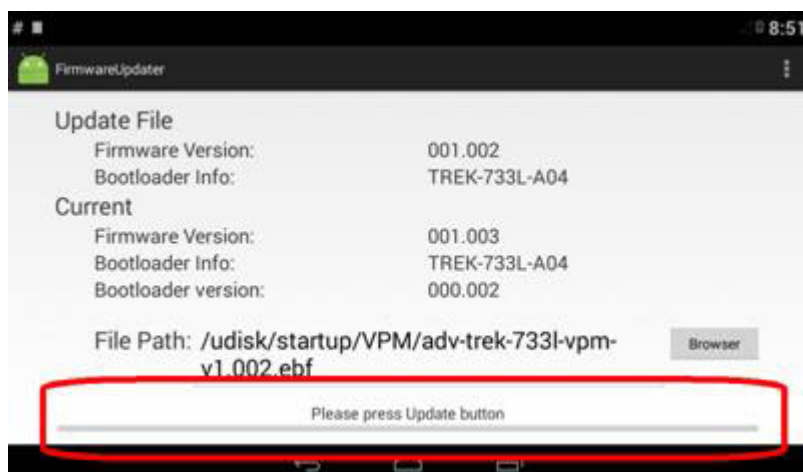

6. Wait finish the system will reboot automatically

Trusted ePlatform Services

ADVANTECH

www.advantech.com

Please verify specifications before quoting. This guide is intended for reference purposes only.

All product specifications are subject to change without notice.

No part of this publication may be reproduced in any form or by any means, electronic, photocopying, recording or otherwise, without prior written permission of the publisher.

All brand and product names are trademarks or registered trademarks of their respective companies.

© Advantech Co., Ltd. 2016

