

# Instructions for Use

## CuratOR<sup>®</sup> LX491W Full HD 49" LCD Monitor

### **Important**



Please read the safety information and all information delivered with the product carefully to familiarize yourself with safe and effective usage.



## Legal information

### Warning notice system

This manual contains notices you have to observe in order to ensure your personal safety, as well as to prevent damage to property. The notices referring to your personal safety are highlighted in the manual by a safety alert symbol, notices referring only to property damage have no safety alert symbol. These notices shown below are graded according to the degree of danger.

 <b>DANGER</b>
indicates that death or severe personal injury <b>will</b> result if proper precautions are not taken.
 <b>WARNING</b>
indicates that death or severe personal injury <b>may</b> result if proper precautions are not taken.
 <b>CAUTION</b>
indicates that minor personal injury can result if proper precautions are not taken.
<b>NOTICE</b>
indicates that material damage can result if proper precautions are not taken.

If more than one degree of danger is present, the warning notice representing the highest degree of danger will be used. A notice warning of injury to persons with a safety alert symbol may also include a warning relating to property damage.

### Qualified personnel

The product/system described in this documentation may be operated only by **personnel qualified** for the specific task in accordance with the relevant documentation, in particular its warning notices and safety instructions. Qualified personnel are those who, based on their training and experience, are capable of identifying risks and avoiding potential hazards when working with these products/systems.

### Use of EIZO products

 <b>WARNING</b>
EIZO products may only be used for the applications described in the catalog and in the relevant technical documentation. If products and components from other manufacturers are used, these must be recommended or approved by EIZO. Proper transport, storage, installation, assembly, commissioning, operation and maintenance are required to ensure that the products operate safely and without any problems. The permissible ambient conditions must be complied with. The information in the relevant documentation must be observed.

### Trademarks

All names identified by ® are registered trademarks of their respective owners. Please refer to the trademarks listed in the appendix. The remaining trademarks in this publication may be trademarks whose use by third parties for their own purposes could violate the rights of the owner.

### Disclaimer of liability

We have reviewed the contents of this publication to ensure consistency with the hardware and software described. Since variance cannot be precluded entirely, we cannot guarantee full consistency. However, the information in this publication is reviewed regularly and any necessary corrections are included in subsequent editions.

# Table of contents

<b>Legal information .....</b>	<b>2</b>
<b>1 Introduction.....</b>	<b>5</b>
1.1 Contents of this document .....	5
1.2 Intended use .....	5
1.3 User .....	5
<b>2 Safety information .....</b>	<b>6</b>
2.1 General safety instructions .....	6
2.2 Product-specific safety information.....	10
<b>3 Description.....</b>	<b>11</b>
3.1 Scope of delivery .....	11
3.2 Monitor performance features.....	12
<b>4 Setup and installation .....</b>	<b>14</b>
4.1 Installation site .....	14
4.2 Installing the monitor.....	16
<b>5 Connecting.....</b>	<b>17</b>
5.1 Safety information for connection .....	17
5.2 Connector locations .....	18
5.3 Connection panel.....	19
5.4 Connecting the signal cable.....	21
5.5 Connecting the power cable .....	22
<b>6 Commissioning.....</b>	<b>23</b>
6.1 Switching on the monitor and video source .....	23
6.2 Avoiding image sticking .....	23
6.3 Check for pixel defects .....	24
6.4 Setting the image geometry.....	24
6.5 Adjustment of monitor and video source .....	24
6.6 Adapting the monitor using Force Mode.....	26
6.6.1 Introduction to Force Mode .....	26
6.6.2 Basic information on timing.....	27
6.6.3 Entering timing data .....	28
6.6.4 Determining the timing data .....	29
<b>7 Operation.....</b>	<b>33</b>
7.1 Operator controls .....	33
7.2 Remote control .....	34
7.3 Lock or unlock OSD menu.....	35
7.4 Picture layout (PaP, PiP, PoP) .....	35

*Table of contents*

---

7.5	Overview of the OSD menu .....	37
7.6	"Picture" menu .....	37
7.7	"Image" menu .....	39
7.8	"Signal" menu .....	41
7.9	"LUT" menu .....	45
7.10	"Info" menu .....	46
7.11	"Utilities" menu.....	47
7.12	"Force Mode" menu .....	49
7.13	"Adjust LUT" menu .....	50
<b>8</b>	<b>Cleaning and maintenance .....</b>	<b>52</b>
8.1	Cleaning.....	52
8.2	Maintenance .....	53
<b>9</b>	<b>Troubleshooting .....</b>	<b>54</b>
9.1	Fault correction .....	54
<b>10</b>	<b>Technical specifications .....</b>	<b>55</b>
10.1	Monitor characteristics.....	55
10.2	Power supply .....	55
10.3	Electronics .....	56
10.4	Mechanical design .....	56
10.5	Climatic conditions.....	57
10.6	Safety regulations .....	57
<b>11</b>	<b>Dimension drawings .....</b>	<b>58</b>
11.1	View from front and side .....	58
11.2	Rear view.....	58
<b>12</b>	<b>Spare parts / accessories .....</b>	<b>59</b>
12.1	Accessories .....	59
<b>13</b>	<b>Appendix .....</b>	<b>60</b>
13.1	Information on electromagnetic compatibility (EMC) .....	60
13.2	Markings and symbols .....	63
13.3	Warranty .....	64
13.4	Repairs .....	65
13.5	Environmental protection .....	65
13.6	China RoHS (Restriction of Hazardous Substances) .....	65
13.7	Additional devices.....	66
13.8	Contact .....	67
13.9	Trademarks.....	67
	<b>Index .....</b>	<b>68</b>

# 1 Introduction

## 1.1 Contents of this document

This document explains the functionality and the approved use of the CuratOR LX491W. To ensure clarity, it does not contain all detailed information on this product.

The contents of this document are neither part of a previous or existing agreement, commitment or legal relationship, nor does it modify such.

Note
This documentation is available in electronic format only. It is included on the CD-ROM provided and can be downloaded at <a href="http://www.eizo-or.com">www.eizo-or.com</a> , or provided by the sales partner from whom you purchased the product.

## 1.2 Intended use

The EIZO CuratOR LX491W is designed specifically for viewing medical images and video data.

The LX491W is intended for use by health care professionals to display images from a variety of medical imaging devices, in particular endoscopic and PACS systems, but not mammography, on a single video monitor.

The LX491W is intended for use in the patient vicinity within the OR and other sterile medical environments, but is not intended for direct patient contact.

The LX491W can be installed in a ceiling suspension or a wall mount, or a stand.

## 1.3 User

### User

In the following, health personnel such as surgeons or medical technicians are referred to as the "user".

### Service / service personnel

"Service" or "Service personnel" identifies authorized personnel with knowledge of medical imaging technology, local standards for image quality requirements, and safety of medical products, for example a hospital technician or manufacturer of medical devices.

### Cleaning staff

"Cleaning staff" refers to personnel responsible for cleaning medical devices.

## 2 Safety information

### 2.1 General safety instructions

Correct and safe operation of EIZO devices assume professional transport, storage, installation, and connection, as well as careful operation and service.

The devices may only be used for applications for which they are intended.

For safety reasons, the following precautions must be observed:

<p> <b>DANGER</b></p> <p><b>Please observe all warning information present on the device and in the instructions for use.</b></p> <p>There is a danger to life if warnings are not obeyed. Severe personal injury or damage to property may occur.</p> <p><b>Observe the safety requirements of EN 60601-1 (IEC 60601-1)</b></p> <p>To prevent injury to patients and users, connect the electrical system in accordance with the safety requirements of EN 60601-1 (IEC 60601-1) for "Safety requirements for medical electrical systems".</p> <p><b>Connecting the protective earth conductor</b></p> <p>If the device is connected to line power, the device must be connected to a protective ground conductor. This is the only way to ensure that the touch leakage current in a first fault event does not exceed 500 <math>\mu</math>A.</p> <p>The interruption of the device's protective conductor is considered a first fault event in accordance with EN 60601-1.</p> <p>Use the following measures to ensure that the leakage currents remain below the specified limits:</p> <ul style="list-style-type: none"><li>• Separators for signal input unit or signal output unit</li><li>• Use of a safety isolating transformer</li><li>• Use of the additional protective ground terminal</li></ul> <p>Mounting of the monitor: The monitor's suspension arm must have its own protective ground conductor. This protective ground conductor guarantees, together with the protective ground conductor of the monitor, that the housing leakage current always remains less than 500 <math>\mu</math>A, even in the event of a single fault condition.</p> <p><b>No unauthorized opening of the device / no unauthorized service or maintenance work</b></p> <p>The device may only be opened by qualified personnel. Likewise, service or maintenance work may only be carried out by qualified personnel. There is a risk of electric shock.</p> <p>No liability is accepted for death and injury to persons or damage to property resulting from work carried out by non-qualified personnel.</p> <p><b>Do not touch components in the device</b></p> <p>If the device is connected to the line power, components in the device are subjected to high voltages. Touching the components may be fatal.</p> <p><b>No contact between device and patients</b></p> <p>The device is not suitable for direct contact with a patient. The device and patient must never be touched simultaneously. Otherwise there is a danger to life and limb.</p>
---

 **DANGER**

**Please observe all warning information present on the device and in the instructions for use.**

There is a danger to life if warnings are not obeyed. Severe personal injury or damage to property may occur.

**Never use defective power cables**

If a damaged or unsuitable power cable is used, it could result in a fire or electric shock. Only use power cables with PE contacts approved by the manufacturer.

**Disconnect the power cable correctly**

When disconnecting the power cable, always do so by holding the plug. Ensure that your hands are dry. There is a risk of electric shock.

**Do not insert any objects into the housing**

Objects inserted into the housing may result in an electric shock or damage to the device.

**Do not place any objects on top of the device**

If you place objects on top of the device, this can lead to overheating and fire.

**Avoid penetration of liquid**

Liquids seeping into the device may result in electric shock or device failure.

 **CAUTION**

**Extensive damage to property may result if the device is not connected correctly**

That is why you should observe the warning information:

**Connection must be carried out by specialists**

Please ensure that all steps are taken to avoid injuries or incorrect diagnoses.

- Only use the video cables specified by the manufacturer for the connection.
- Only use power cables with PE contacts.
- Only use power outlets with PE contacts.
- Do not connect too many devices to a power outlet or extension cable.
- Observe the information provided by the respective manufacturer.
- If required by the application or local regulations, QA software must be used for quality control and documentation.

**Connection in the USA and Canada**

Molded power supply plugs must comply with the requirements for "hospital grade attachments" CSA Std. C22.2 No. 21 and UL 498.

**Connection in China**

Only use power cables approved for China. These power cables are identified by the labels "CCC" or "CQC".

**Observe the country-specific regulations**

Observe all regulations of the country in which the device is used.

**NOTICE**

**Extensive damage to property may result if the device is not connected correctly**

That is why you should observe the warning information:

- Desktop installation:  
Place the device on a solid and level surface. The attached stand, as well as the installation surface, must be suitable for the weight of the device.
- For mounting on a wall or ceiling suspension:  
The mount unit must be suitable for the weight of the device.
- For installation in a rack:  
Observe the installation sequence, and provide ventilation for the device.

**Provide adequate air circulation**

When installing the device, ensure that there is adequate air circulation for operation. The permissible ambient temperature range must not be violated. Otherwise, the device could be destroyed by overheating.

**Avoid sources of heat**

Do not install the device in the vicinity of sources of heat, such as radiators, heating appliances or other devices that can generate or emit heat.

**Do not subject the device to jolting or shocks**

The device contains sensitive electronic components that could be damaged by jolting or shocks.

**Only switch on a cold device following adaptation to room temperature**

If the device is brought into a room with a higher or rising temperature, condensed water will form in and on the device. Do not switch on the device until the condensed water has evaporated. Otherwise, the device could be damaged.



**NOTICE**

**Extensive damage to property may result if the device is not connected correctly**

That is why you should observe the warning information:

**Transportation only in original packaging**

Use the original packaging for transportation, and transport in the correct shipping position. Be sure in particular to protect the monitor LCD modules from shocks.

**Care of device / cleaning agents**

- Remove water drops immediately; extended contact with water discolors the surface.
- Only clean the surfaces using the cleaning agents referred to in the Instructions for Use.
- Monitor: The screen is extremely sensitive to mechanical damage. Absolutely avoid scratches, shocks, etc.

**What to do if the device is faulty**

If the following conditions exist, the device must be disconnected from the line power supply and checked by qualified personnel:

- Damage to the plug or power cable.
- After liquid seeps into the device.
- If the device has been exposed to moisture.
- If the device does not function or if a fault cannot be eliminated using the Instructions for Use.
- If the device has been dropped and/or the housing damaged.
- If the device smells of burning or makes peculiar noises.

**Be aware of the monitors aging**

Note that monitors can fail as a result of aging, and that image properties such as brightness, contrast, and color value can change.

**Do not touch the monitor screen**

Due to mechanical pressure or electrostatic discharges, touching the screen can result in brief disturbances to the image.

## 2.2 Product-specific safety information

### CAUTION

#### Careful installation of the stand

The tilt, position, and height of the monitor can be changed when the monitor is installed on a stand. Note the following to prevent injuries or damage when installing or adjusting the stand:

- Make sure that you do not pinch or injure your fingers or any other parts of the body.
- Make sure the monitor does not collide with the table or other objects, which could result in damage.

### CAUTION

#### Ensure monitor stability

Stability must be ensured after installing the monitor on a stand. An unstable stand can cause the monitor to tip over and cause injuries or damage. Therefore make sure the stand is stable.

- Only use a stand that has been tested for the monitor's weight and that is approved for tilting up to 10°.
- The screw insertion depth into the monitor must be within the acceptable range.

### NOTICE

#### Radio interference

This is a Class B device.

The device may cause radio interference or interfere with the operation of other devices in close proximity. In this case the user is encouraged to perform appropriate measures to correct the interference.

### NOTICE

#### Medical System

- Do not connect devices that are not part of the medical system.
- If a stand is subsequently attached to the monitor, the stand must meet the requirements of standard EN 60601 so that the system, comprising the stand and monitor, meets the requirements.

### Note

#### No zero error rate

LCD monitors do not have a zero error rate. For this reason, the image parameters can change over time, e.g. reduced luminance or changing/fading colors.

### Note

#### Image quality

To maintain constant image quality, EIZO recommends cleaning the monitor on a regular basis and checking image properties in accordance with all applicable local regulations.

## 3 Description

### 3.1 Scope of delivery

The device and various components are included in the scope of delivery. After unpacking, check the scope of delivery for correctness and completeness.

<b>Note</b>
Keep the packaging material for subsequent transport of the device.

#### Device

The CuratOR LX491W is a Full HD 49" LCD Monitor. The monitor can be installed in a ceiling suspension, a wall mount, or a stand.

Product	Order number	Description
CuratOR LX491W (white)	6GF62602LA10	Full HD 49" LCD Monitor with white housing.
CuratOR LX491W (black)	6GF62602LA11	Full HD 49" LCD Monitor with black housing.

#### Components

The following components are included in the scope of delivery:

- 1 power cable for Europe
- 1 power cable for US
- 1 power cable for China
- 1 power cable for Japan
- 1 DVI cable (3 m)
- 1 CD-ROM with the documentation
- 1 set of printed safety information
- 1 set of printed information on the battery per the German battery law BattG (in German)
- 1 remote control (AAA batteries included separately)

## **3.2 Monitor performance features**

The CuratOR LX491W has the following features that permit a wide range of applications:

### **49" large screen diagonal**

With a screen diagonal of 49" and a resolution of 1920 x 1080 pixels (2 MP), the LX491W is suitable for simultaneous use of several video sources. The monitor is particularly suited to the display of DICOM radiographic images, or as a secondary monitor in the surgical or endoscopy area.

### **LED backlight**

The LX491W is equipped with an LED backlight optimized for bright environments. This enables a long service life even when operated at high luminance.

### **Fully Automated Stability**

The LX491W has a Fully Automated Stability system that keeps luminance constant in accordance with medical standards such as DICOM or Gamma 2.2, for example. The integrated stability system ensures constant luminance using a built-in light sensor in the center of the backlight.

### **Preset Look Up Tables**

The LX491W is precalibrated at the factory. A total of five practice oriented Look Up Tables (LUTs) have been preset. This calibration data makes installation and maintenance easier. As such, the monitor can be easily adapted to the respective application and local lighting conditions.

### **Adjustable LUT**

The adjustable LUT functions allows manual recalculation of the lookup table. This allows users to modify the gamma model, luminance settings, or color parameters in accordance with local needs or preferences.

The LUT is recalculated via the OSD menu without having to access external calibration software. The reset LUT is calculated immediately, saved in the device, and used internally.

### **Force Mode**

Using the Force Mode function, the LX491W can be adapted to special timing settings.

### **Video inputs**

The LX491W can be connected to the imaging system using various video inputs, such as DVI, 3G-SDI, Composite, S-Video, and VGA. BNC connectors such as RGBS, SoG, and YPbPr can be inserted in the VGA input using an adapter cable. As a result, the LX491W can process digital and analog standard video signals (PAL, NTSC).

Any adjustments to the video settings that may be required can be carried out using an OSD menu (On Screen Display).

### **Simultaneous display of different video sources**

The various video sources can be connected to the video inputs simultaneously and displayed on the monitor. The various signal inputs can be displayed either as a "Picture in Picture" (PiP) representation, or next to one another as "Picture and Picture" (PaP) using the widescreen format.

### **Protective screen**

The LX491W has an anti-glare protective screen fitted in front of the LCD panel to protect the surface from bumps and scratches. The monitor with protective screen is protected at the front against moisture (IP65 degree of protection).

The space between the protective screen and the panel is sealed to prevent dust from entering, thus helping ensure the internal surfaces remain clean.

## 4 Setup and installation

 <b>CAUTION</b>
<b>Changes to device</b> Do not make any mechanical or electric changes to the device. EIZO GmbH is not liable for changes made to the device.

### 4.1 Installation site

<b>NOTICE</b>
<b>The power switch and connections must be accessible at all times</b> When installing and connecting the monitor, ensure that the power switch and the connections are accessible at all times.

<b>NOTICE</b>
<b>Condensation</b> If the device is brought into a warm environment from a cold one, condensation may form in the device. This could result in a short circuit when switching on the device, damaging it. <ul style="list-style-type: none"><li>• Wait until the condensed water has evaporated, including that inside the device, before you switch it on. This can take several hours.</li></ul>

<b>NOTICE</b>
<b>Overheating</b> Ventilation holes are located on the rear of the housing. If the ventilation holes are covered or closed, the heat generated in the monitor will not be dissipated sufficiently. <ul style="list-style-type: none"><li>• Do not cover the ventilation holes.</li><li>• Do not close the ventilation holes.</li><li>• The minimum distance from the back and side of the monitor to the wall must be 10 cm, and at least 15 cm from other devices.</li><li>• The ambient temperature must be in the acceptable range of +5 °C to +40 °C.</li></ul>

<b>NOTICE</b>
<b>Dusty environment</b> The monitor is intended for use in the clean environment of medical diagnostics. In dusty environments, ventilation holes in the back can allow dust to penetrate into the monitor. In the worst case, deposits are possible which become evident as dark spots in a white picture and result in deterioration of the luminance. <ul style="list-style-type: none"><li>• Protect the monitor from dust, for example through appropriate construction measures at the installation site.</li></ul>

<b>Note</b>
<b>Reflections on the screen</b> The monitor has an anti-glare surface that is only effective if the screen is clean and grease-free. <ul style="list-style-type: none"><li>• Comply with the specifications for cleaning.</li><li>• Position the monitor to avoid reflections on the display area. Reflections can be caused by lights, windows, furniture with shiny surfaces, or light-colored walls.</li><li>• In order to reduce reflections on the monitor, only use non-dazzling reflector bulbs for the ceiling lighting.</li></ul>

<b>Note</b>
<b>Shocks and impacts</b> The monitor is sensitive to mechanical influences. Shocks and impacts on the panel surface can lead to total failure. <ul style="list-style-type: none"><li>• Ensure that such mechanical influences at the installation site are avoided.</li></ul>

<b>Note</b>
<b>Movable installation</b> If the monitor is installed such that it can move, make sure that persons or objects in the facility are not endangered by the monitor's range of movement.

<b>Note</b>
During transport, use the original packaging or service packaging.

## 4.2 Installing the monitor

### NOTICE

#### Holders

- Mounts must be tested and approved by the manufacturer for the weight to be supported.
- An installed stand must be sufficiently stable to withstand tilting of up to 10° without toppling the monitor.

### Note

#### Inaccessible cover

Before installing the monitor in the selected holder, check whether the screws for removing the cover of the connection panel are accessible. If not, remove the connection panel cover prior to installation.

The monitor has a VESA 400x200 mounting interface and can be installed in a suitable ceiling suspension or wall mount.

Note the following during installation:

- The maximum torque for attaching to the holder is 10 Nm.
- The screws used for attaching to the holder must meet the following requirements:

No.	4
Thread	M8
Strength	8.8 in accordance with ISO 898-1
Insertion depth	10 mm to 30 mm





## 5 Connecting

### 5.1 Safety information for connection

All safety information and warnings for the device must be observed to ensure danger-free operation.

 <b>CAUTION</b>
<b>Changes to device</b> Do not make any mechanical or electric changes to the device. EIZO GmbH is not liable for changes made to the device.

 <b>CAUTION</b>
<b>Shielding measures</b> Follow all shielding measures in accordance with local EMC directives. If these guidelines are not observed, device malfunction may result.

 <b>CAUTION</b>
<b>Grounding</b> The permissible leakage current is not exceeded during the first fault event in accordance with EN60601-1. The device is grounded with an additional protective conductor to ensure the greatest possible electric safety.

 <b>CAUTION</b>
<b>Excessive currents, short circuits, and ground faults</b> In accordance with national standards and regulations, protection against excessive currents, short circuits, and ground faults must be incorporated into the building installation.

<b>NOTICE</b>
<b>Changes to device settings</b> Device settings may only be adjusted by service personnel.

<b>NOTICE</b>
<b>Disconnecting from line power</b> Always set the power switch to "Off" before disconnecting the device from power. Otherwise the device could be destroyed.

**NOTICE****Cable installation**

Observe the following instructions:

- Only shielded cables are to be used for all signal connections.
- If the relevant facility is available on the connector, all plug connections must be screwed tight or locked.
- The connecting cables must not be kinked.
- The minimum bending radius of a connecting cable generally equals five times the cable diameter.
- Do not route signal cables and power cables next to one another. Otherwise, line power subject to heavy interference could result in reversible pixel errors.
- The device must not share a line power supply with motors or valves (interference!).
- Externally connected cables can represent a trip hazard. Make sure that all incoming cables are safely routed.
- If the device offers strain relief mechanisms for the cables, use them to prevent unintended loosening of connected cables.

## 5.2 Connector locations

The connectors are located in the connection panel behind a cover on the back of the monitor. The power switch is not covered and is freely accessible.

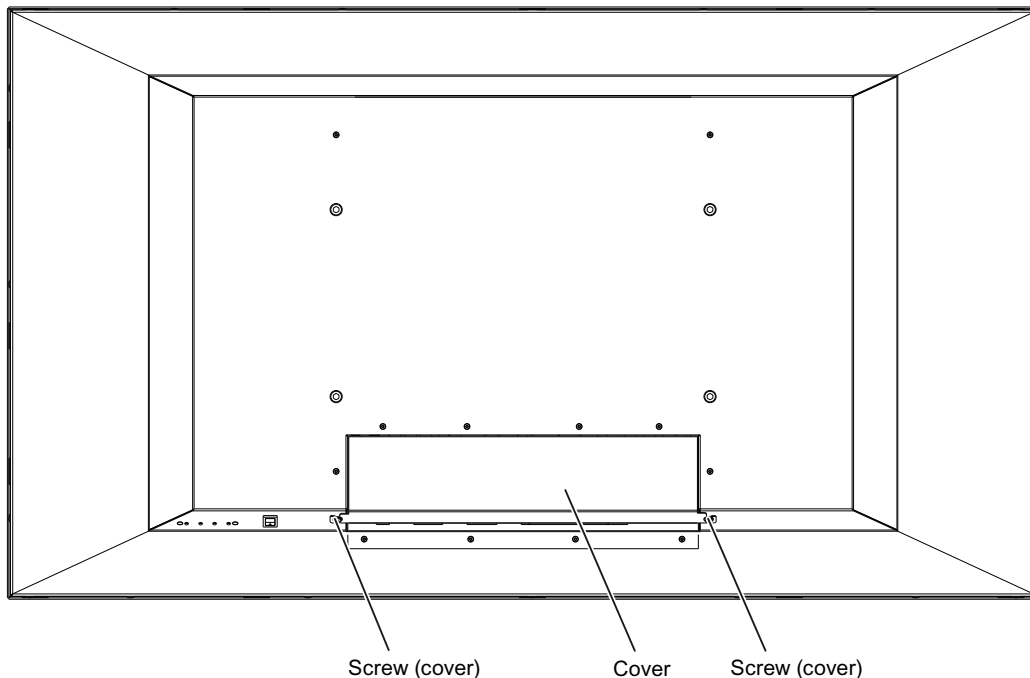

Fig.: Rear view with cover

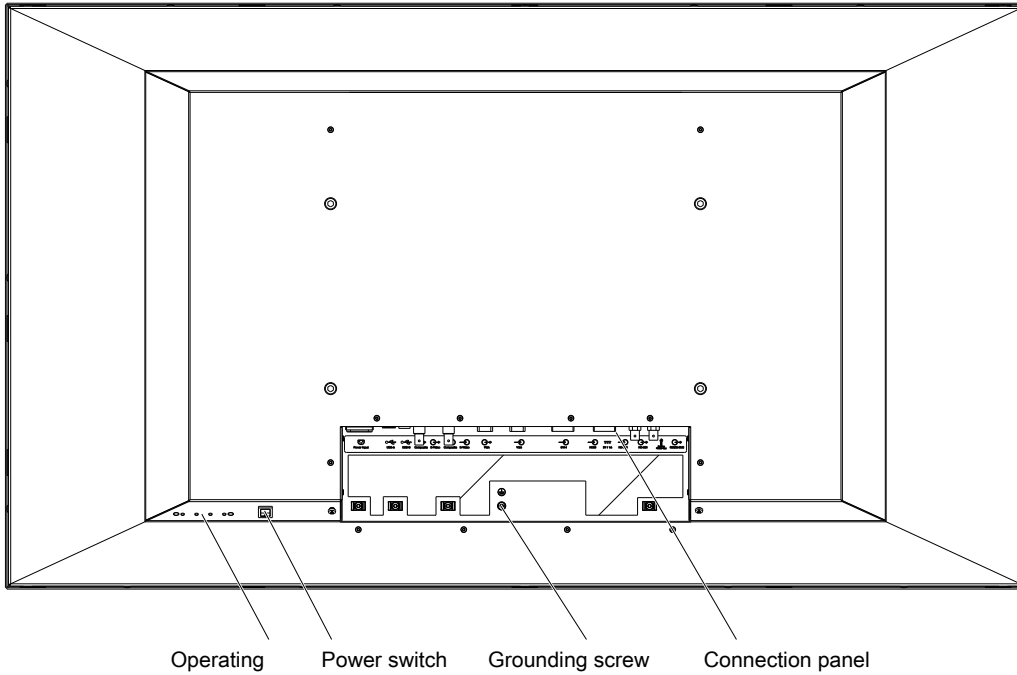

Fig.: Rear view without cover

<b>Note</b>
An additional protective conductor may be connected to the grounding screw.

### 5.3 Connection panel

The connection panel is visible after removing the cover. The LX491W has connectors for power, communication, and video input and output signals.

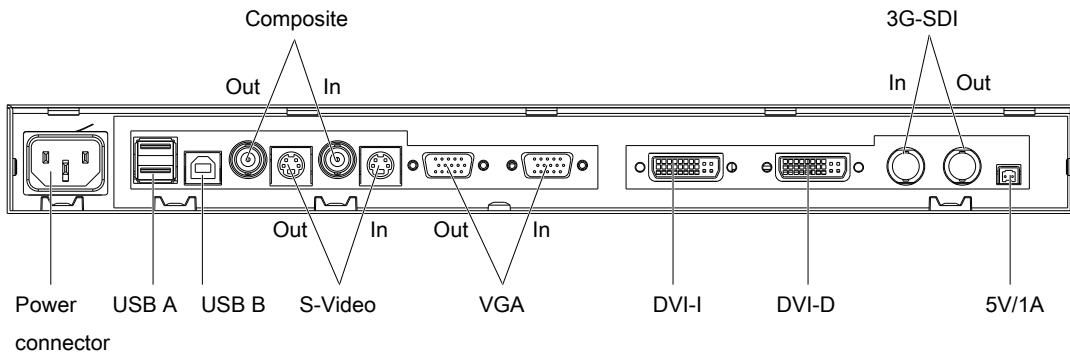

Fig.: LX491W connection panel

### Signal inputs

The following signal inputs are available on the connection panel.

- VGA input (15-pin D-sub socket): In addition to a standard VGA signal, other analog signals can be connected with a suitable adapter. Examples include component, composite, and RGB video using a multi-BNC to VGA adapter.
- DVI-I and DVI-D input
- 3G-SDI (BNC)
- S video with Y/C signal (4-pin mini-DIN socket)
- Composite (BNC)

<b>Note</b>
<b>Interlaced signals</b>
If an interlaced signal is applied to a signal input (except for the 3G-SDI input) and the "Deinterlacing" function in the "Signal" OSD menu is set to "Normal", brightness is reduced by approx. 15%. The "Field to frame" and "Static mesh" deinterlacing settings cause a slight reduction in brightness only, but can lead to comb effects. Also refer to the "Deinterlacing" function in the <a href="#">"Signal" menu [▶ 41]</a> .

### Signal outputs

The following signal outputs are available on the connection panel.

- VGA output (15-pin D-sub socket):
- 3G-SDI (BNC)
- S video with Y/C signal (4-pin mini-DIN socket)
- Composite (BNC)

### Additional connectors

- Power connector (appliance plug)
- USB: 2 downstream (type A) and 1 upstream (type B) connector.
- Voltage supply: 5V/1A connector to supply external devices.

## 5.4 Connecting the signal cable

 <b>CAUTION</b>
<b>Opening the connector panel cover</b> Only service may open the connector panel cover. Patients must not be present when the cover is open.

 <b>CAUTION</b>
<b>Connector</b> Connectors may only be plugged in or removed by Service when the device is switched off.

<b>NOTICE</b>
<b>Cable</b> <ul style="list-style-type: none"><li>• The picture quality, interference immunity, and emitted interference of the entire system depend on the cable quality and length.</li><li>• When using a BNC to VGA adapter cable, the signal cables, for example, red, green, and blue, must be of the same length to prevent a loss in image quality.</li><li>• Use only the cables specified by EIZO or the transmission links available from EIZO.</li></ul>

<b>Note</b>
<b>Video source settings</b> <ul style="list-style-type: none"><li>• The video source is set on the monitor using the EDID data transmitted via the DDC interface. If the video source cannot interpret the EDID data, the monitor automatically attempts to adjust to the signal clocking of the video source.</li><li>• Do not change these settings. Otherwise, the images will not be displayed correctly.</li></ul>

The connection panel for the signal cables and power supply is located on the back of the monitor. All signal inputs can be connected simultaneously.

### Prerequisite

- The monitor is installed in the ceiling suspension or wall mount unit, or on a stand.
- The screws for attaching the cover to the connection panel are accessible.  
See also [Connector locations \[▶ 18\]](#) and [Installing the monitor \[▶ 16\]](#).

### Procedure

1. Using a suitable tool, remove the connection panel cover.
2. Connect the signal cables to the monitor.  
**Note:** All signal inputs can be connected simultaneously.
3. Tighten the screws to secure the signal cables.
4. Place the cover back on the connection panel.

## 5.5 Connecting the power cable

 <b>DANGER</b>
<b>Connecting to line power</b> <ul style="list-style-type: none"><li>• The device is designed for line power with a grounded neutral conductor.</li><li>• To avoid risk of electric shock, this device must only be connected to line power with a protective conductor.</li><li>• Contact the responsible building technician or a qualified electrician if you are uncertain whether the line power is equipped with a protective conductor.</li></ul>

 <b>CAUTION</b>
<ul style="list-style-type: none"><li>• Only use power cables or device connection cables with protective conductors and appliance plugs according to DIN 49 547, IEC 60320 (max. length 3 m). Furthermore, the cable must adhere to all local safety regulations applicable to the specific country in which the monitor is used.</li><li>• Device fuses should only be replaced in repair centers or by service personnel.</li><li>• <b>Note for North America:</b> Molded power plugs must comply with the requirements for hospitals with respect to CSA Std. C22.2 No. 21 and UL 498.</li></ul>

 <b>CAUTION</b>
<b>Opening the connector panel cover</b> <p>Only service may open the connector panel cover. Patients must not be present when the cover is open.</p>

 <b>CAUTION</b>
<b>Connector</b> <p>Connectors may only be plugged in or removed by Service when the device is switched off.</p>

The monitor is supplied power via an appliance plug in the connection panel on the back of the monitor.

### Prerequisite

- The monitor is installed in the ceiling suspension or wall mount unit, or on a stand.
- The screws for attaching the cover to the connection panel are accessible.  
See also [Connector locations \[▶ 18\]](#) and [Installing the monitor \[▶ 16\]](#).

### Procedure

1. Using a suitable tool, remove the connection panel cover.
2. Connect the appliance plug to the monitor power socket.
3. The power cable can be secured using a cable grip.
4. Place the cover back on the connection panel.

## 6 Commissioning

<b>Note</b>
-------------

<b>Factory settings</b>
-------------------------

All monitors are optimally preset in the factory, such that changes are not usually required.
---

### 6.1 Switching on the monitor and video source

<b>Note</b>
-------------

To obtain the best possible results, the video source should support communication via the Display Data Channel (DDC).
--

The monitor and video source can be switched on in any order.

#### Switch on

- Switch on the monitor.
  - The EIZO logo appears briefly.
- Switch on the video source.
  - If there is no signal the monitor displays a black screen.
  - If there is a signal, the image is displayed accordingly.

<b>Note</b>
-------------

<b>Image not displayed?</b>
-----------------------------

If an image is not displayed after the monitor is switched on and a video signal is present:
--

- |   |
|---|
| <ul style="list-style-type: none"><li>• check the system for basic connection and operating errors before contacting service personnel.</li></ul> |
|---|

### 6.2 Avoiding image sticking

Image sticking may occur with LCD monitors. Image sticking is an effect whereby a faint image of the previous screen contents can be seen after the display contents have changed.

The following measures can reduce or prevent image sticking:

- Use a screen saver with regularly changing images
- Switch off the monitor when it is no longer needed.
- The monitor has an energy saving mode:
  - If the application in use supports the energy saving mode, activate it.

**Note**

**Energy saving (Power Management)**

The monitor supports various energy saving settings, called Power Management (PM). When PM is active, the monitor backlight switches off automatically for example, if the monitor is without a video signal for an extended period.

Also observe the operating system manufacturer's instructions regarding power management settings.

### 6.3 Check for pixel defects

Pixel defects (small bright or dark dots) can occur in LCD monitors. During the manufacturing process, all monitors are checked for the permitted number of defective pixels.

Defective pixels cannot be corrected.

### 6.4 Setting the image geometry

The monitor automatically recognizes the standard used, and has preprogrammed set-up values for each standard. However, depending on the graphics card used, it may still be necessary to align and size the picture for the selected standard.

### 6.5 Adjustment of monitor and video source

#### Adjustment of resolution and refresh rate

Every LCD monitor has certain limits, such as maximum resolution and refresh rate.

- Set the graphics card for operation of the monitor in such a way as to maintain the limit values.

#### Fine adjustment of brightness and contrast

 **CAUTION**

The exact brightness and contrast settings are only possible with a photometer.

 **CAUTION**

**Fine adjustment of analog inputs: Only via 15-pin D-sub and DVI-I sockets**

**Fine adjustment for digital input: not necessary**

- Perform the fine adjustment of the monitor only via the two analog ports (15-pin D-sub and analog signals on the DVI-I socket).
- Digital signals on the DVI-I input do not require a fine adjustment of brightness and contrast since the signal is always displayed in an optimal manner. With a fine adjustment, it is possible that gray scales are not displayed.



RGB video sources (via 15-pin D-sub or DVI-I connector) supply analog signals that are basically intended for conventional CRT monitors and that are processed directly by them.

In contrast, the analog signals must be converted into digital signals for the LCD monitor by a video digitizer. Depending on the video source, cable length, and video mode (e.g. VGA, SVGA, XGA), this conversion may cause certain deviations that cannot be fully corrected by the monitor automatically.

- Perform a manual fine adjustment to obtain the optimum image display with an analog input signal (VGA/DVI-I). During the manual fine adjustment, fine tune the monitor (or video digitizer to be more precise) to the respective video source.

### **Adjusting the monitor for optimum performance with a graphics card**

In order to optimize the monitor settings for the installed graphics card and guarantee that all gray scales can be distinguished, we recommend only adjusting the brightness and contrast for the analog inputs.

Please note that these settings have no impact on the calibration in the look up table: EIZO GmbH monitors are calibrated at the factory and maintain these settings:

- To reduce the brightness using the OSD operator controls, use a picture with 0 % gray scale (black) and a suitable measuring instrument.

Reduce the brightness until the measuring instrument displays constant values: the measured value no longer changes.

Then increase the brightness slightly until the monitor is just above the lowest black level (one step is generally sufficient).

- To set the white value, use a test pattern with 100 % gray value (white) and a suitable measuring instrument.

To ensure the black value remains unchanged, set the contrast only.

- Increase the contrast until the measuring instrument no longer registers an increase in luminance.

Then adjust the contrast regulator setting 1 or 2 steps back until the measured brightness is just under the maximum value.

- Make sure once again that the black value has not changed.

The black value can change if significant corrections were made to the contrast. In this case, repeat the steps above.

### **Result**

The monitor is now configured for optimum performance with the installed graphics card. If the luminance is still not satisfactory, you can increase the black and white values further by adjusting the backlight in the OSD menu.

 <b>CAUTION</b>
<b>Permanently higher setting for backlight</b>
The permanently higher setting for backlight reduces the service life and brightness performance.

### Setting without a measuring instrument

Precise adjustment is only possible with a measuring instrument.

If there is no measuring instrument available for fine adjustment, proceed as follows:

- Use the SMPTE test pattern.
- Adjust the brightness so that image sections with 5 % and 0 % gray value still visibly contrast.
- Adjust the contrast so that image sections with 95 % and 100 % gray value still visibly contrast. To adapt the luminosity to the ambient lighting, adjust the backlight luminance.  
**CAUTION:** the factory-set brightness is no longer maintained.

#### Note

To set the image parameters you can also use the adjustable LUT functions in the ["Adjust LUT" menu \[▶ 50\]](#).

### Automatically setting the video source

In order to automatically adjust the video source, it must support communication via the Display Data Channel (DDC), and the devices must be connected correctly. When switched on, the monitor's EDID data (Extended Display Identification Data) is read out, and the video source can detect the monitor.

#### CAUTION

##### Installation and parameterization of the video source

Please refer to the video source manufacturer's manual for detailed information about installation and configuration of the video source.

## 6.6 Adapting the monitor using Force Mode

#### NOTICE

##### Force Mode is a service tool

Force Mode should only be used by service personnel to determine an unknown timing and implement it in the monitor.

### 6.6.1 Introduction to Force Mode

Various factory-set timings are saved in the monitor. As soon as a video signal is connected, an appropriate timing is sought. "Auto In Process" is displayed during this phase. These timings are compatible with the standard video signals provided by current graphics cards.

If no image or only an unclear image is displayed on the monitor, the signal is outside the standard supported range. Such signals are common with older medical equipment. A timing of this sort can be set using the Force Mode function.

In many cases, a signal outside the standard range is displayed correctly without having to use Force Mode. This is possible because a large number of known timings are saved in the monitor.

## 6.6.2 Basic information on timing

### Scanning with interlaced and non-interlaced procedures

There are two different scanning systems. They differ in the technology used to display the image on the screen. TV signals, and monitors which are compatible with them, generally use the interlaced procedure; computer signals, and monitors compatible with them, generally use the non-interlaced procedure. These two formats are not compatible; one of them must first be converted before the signals can be processed together.

In the case of interlaced scanning, each image is divided into two separate fields. An image therefore comprises two fields. An interlaced image is output on the screen in two scans. The horizontal lines of the first field are scanned first, and then, again starting at the top of the image, the horizontal lines of the second field are scanned between the first set of lines. Field 1 consists of the lines 1 to 262 1/2, and field 2 of the lines 262 1/2 to 525. Only a few lines are displayed at the top and bottom of each field.

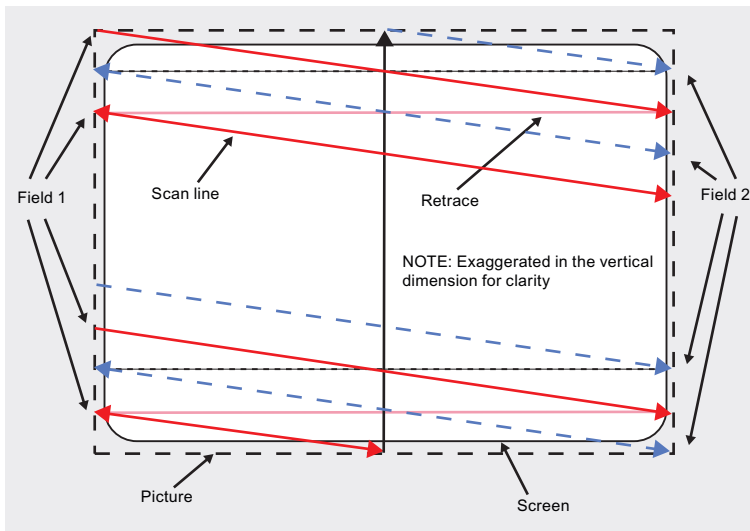

Fig.: Interlaced scanning system

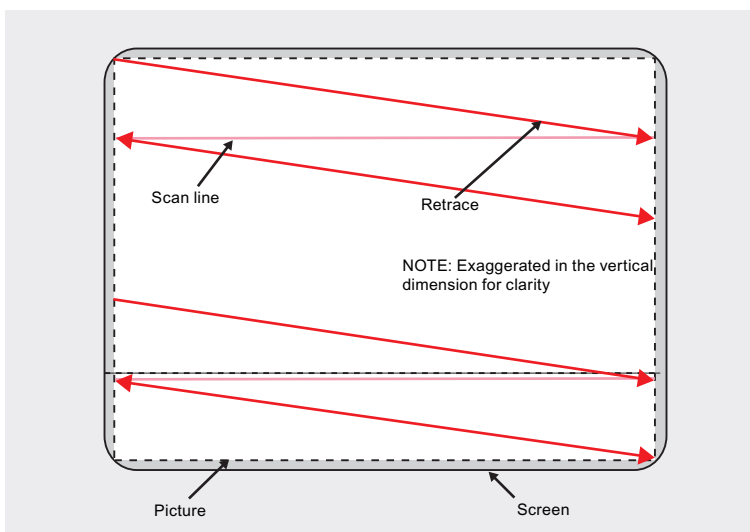

Fig.: Non-interlaced scanning system

A non-interlaced image is output to the screen such that all horizontal lines are scanned from top to bottom in a single scan.

**Horizontal timing diagram (the vertical timing diagram is identical)**

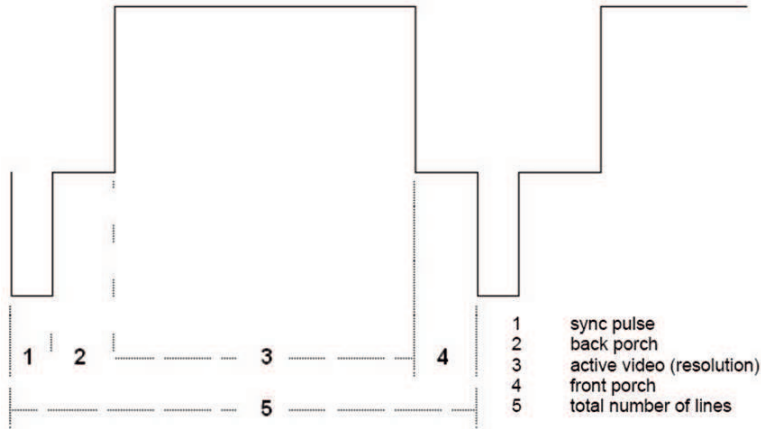

Fig.: Timing diagram

Force Mode menu	Timing diagram
Horizontal resolution	3 - Active video (horizontal resolution)
Vertical resolution	3 - Active video (vertical resolution)
Total horizontal lines	5 – Total number of lines (horizontal)
Horizontal blank pixels	4 – Front Porch (horizontal)
Vertical blank pixels	4 – Front Porch (vertical)

**6.6.3 Entering timing data**

If you know or have already determined the timing data, you can enter it directly in the OSD "Force Mode" menu.

**Entering known timing data**

1. Open a test pattern with a clearly defined border (e.g. SMPTE image).
2. Open the "Force Mode" menu in the OSD.

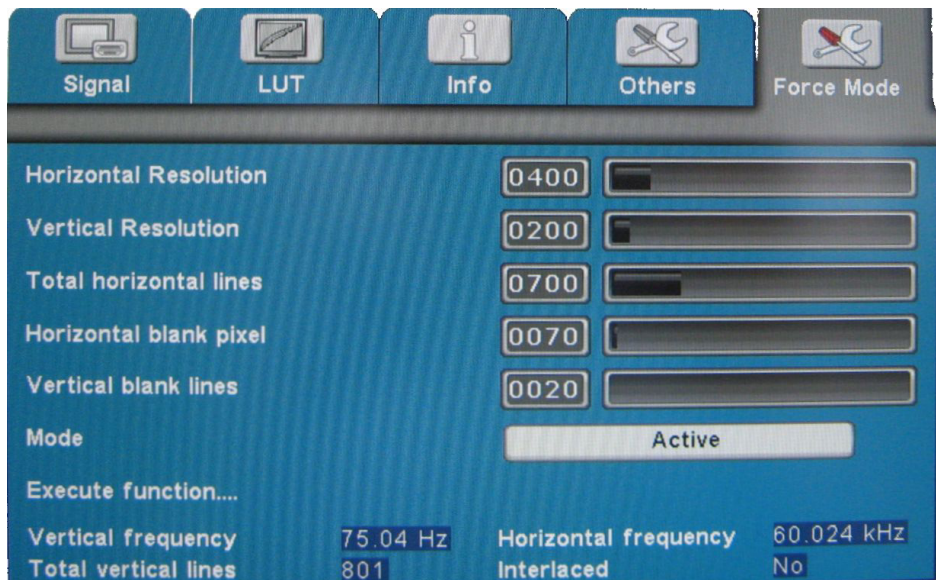

3. Use the keys to enter the timing data in the input fields.
4. Set the "Mode" to "Active".
5. Apply the entered data by selecting "Execute function..."

**Note**

**Always save the data with "Execute function..."**

The timing data are only entered into memory with the "Execute function..." command, and the image is then displayed with the new parameters.

### 6.6.4 Determining the timing data

If you know none or only part of the timing data, you can determine the data incrementally in the "Force Mode" menu.

**Note**

All settings must be implemented with the zoom factor "1 to 1" ("Geometry" menu).

#### Sequence for determining a timing

1. Determine the start values using the auto function.
2. Enter the known data.
3. Optimize the scanning frequency.
4. Optimize the geometry and resolution.

Step-by-step instructions for setting a timing can be found in the next sections.

### Determine start values using auto function

The following commands can be used to trigger automatic determination of the timing data, and provides rough approximation of the applied timing.

1. Open a test pattern with a clearly defined border (e.g., SMPTE image).
2. Open the "Force Mode" menu in the OSD.

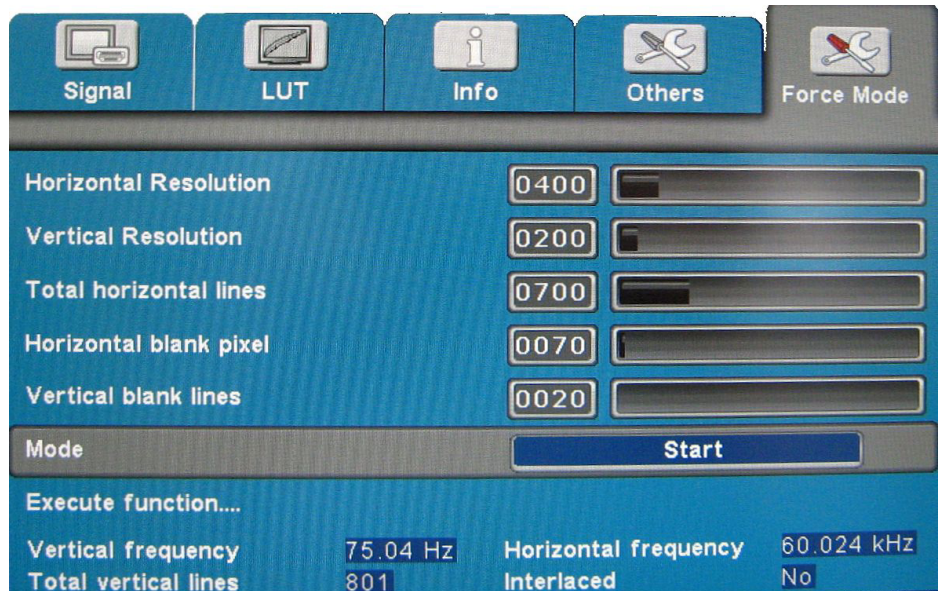

3. Set "Mode" to "Start".
4. The start values are determined when you select "Execute function..."  
**Note:** The timing data are only entered into memory with the "Execute function" command, and the image is then displayed with the new parameters.

After the "Execute function..." "Mode" switches to "Active" and you can optimize the start values.

### Entering known data

If some of the timing data are known they can be entered after determining the start values in order to simplify the subsequent steps.

If the resolution is known for example, it can be used for the approximation of "Total horizontal lines". In this case, "Total horizontal lines" has to be greater than "Horizontal Resolution". If "Total horizontal lines" is less than "Horizontal Resolution" during setting, that latter has to be reduced. A larger "Horizontal Resolution" can result in the image being split vertically.

### Optimize scanning frequency

The correct signal frequency now has to be set with "Total horizontal lines".

1. To set "Total horizontal lines" correctly, open a test pattern with a clearly defined border (e.g., SMPTE image).
2. Correct the signal frequency so that no interference is present in the picture. If the distance between interferences becomes larger, and these therefore also become fewer, you are changing the values in the correct direction.

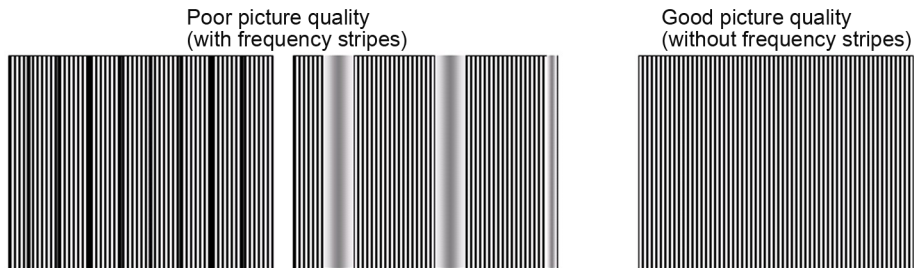

### Optimize geometry/resolution

The active resolution range is defined by the values of the "Horizontal Resolution" and "Vertical Resolution" input fields. This range is displayed in the center of the monitor in black.

The inactive resolution range is the unused range between the active resolution and the maximum resolution of the monitor. In Force Mode, this range is displayed gray (gray scale monitors) or blue (color monitors).

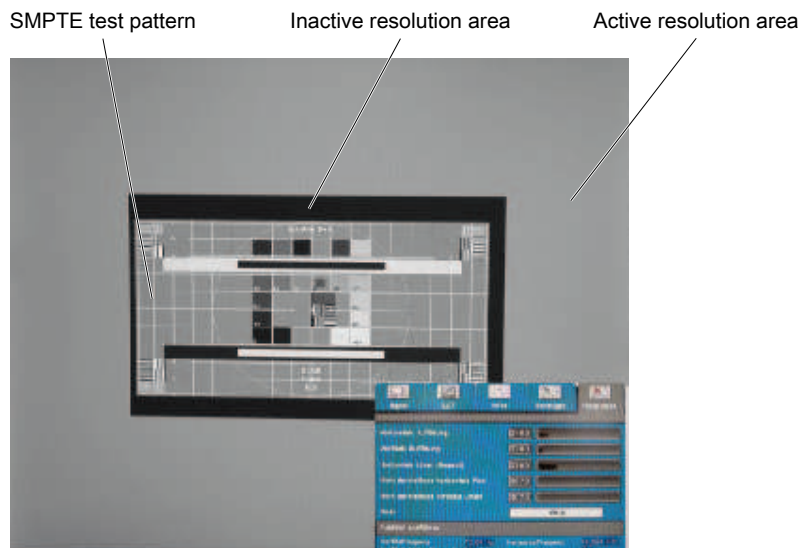

To adapt the active resolution range to the actual video signal resolution, perform the following steps:

1. Open a test pattern with a clearly defined border (e.g., SMPTE image).
2. In the "Force Mode" menu, use the "Horizontal blank pixel" input field to shift the left edge of the SMPTE image pixel-exact to the left inside edge of the gray/blue area.
3. Correct the values in the "Horizontal Resolution" input field until the right internal border of the gray/blue area is pixel-exact at the right edge of the SMPTE image.

4. Use the "Vertical blank lines" input field to shift the top edge of the SMPTE image pixel-exact to the top internal border of the gray/blue area.
5. Correct the values in the "Vertical Resolution" input field until the bottom internal border of the gray/blue area is pixel-exact at the bottom edge of the SMPTE image.
6. Apply the entered data by selecting "Execute function..."

**Note: Gray/blue range not visible**

If no gray/blue area is visible on the left and right sides of the image, reduce the "Horizontal Resolution" until the gray/blue area becomes visible. If no gray/blue area is visible on the top and bottom sides of the image, reduce the "Vertical Resolution" until the gray/blue area becomes visible.

**Timing successfully set**

The timing was set successfully. You can now exit the OSD menu. The monitor will recognize the newly set timing and select it whenever connected.

<b>Note</b>
Only one timing can be saved in Force Mode itself.

<b>Note</b>
Once all settings in Force Mode have been performed, the zoom factor can be changed in the "Geometry" menu.



## 7 Operation

This section describes the operator controls and functions of the monitor OSD menu.

### CAUTION

#### Settings in the OSD menu

Changes to the OSD menu settings can impact the image properties. For this reason, OSD menu settings should only be changed by trained personnel.

### Measures in the event of a failure

#### Note

#### Device malfunction in operation

If the device is not working properly, check the system for basic connection and operating errors before contacting service personnel.

## 7.1 Operator controls

The CuratOR LX491W has four keys for OSD operation located in the lower right corner.

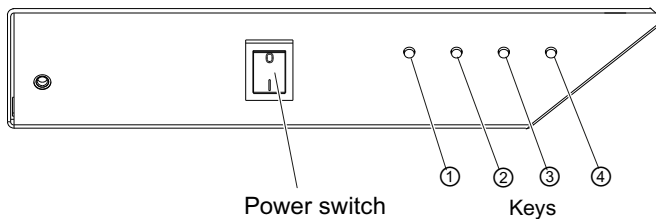

### Key functions

The keys have the following functions within the OSD menu:

Key	Function
①	<ul style="list-style-type: none"><li>• Open OSD menu</li><li>• Toggle</li></ul>
②	<ul style="list-style-type: none"><li>• Navigate between the submenu / tabs</li><li>• Decrease/change value</li></ul>
③	<ul style="list-style-type: none"><li>• Navigate between the submenu / tabs</li><li>• Increase/change value</li></ul>
④	<ul style="list-style-type: none"><li>• Exit OSD or submenu (settings are retained)</li></ul>
Power switch	<ul style="list-style-type: none"><li>• Switch the device on and off</li></ul>

## 7.2 Remote control

The CuratOR LX491W is delivered with a remote control.

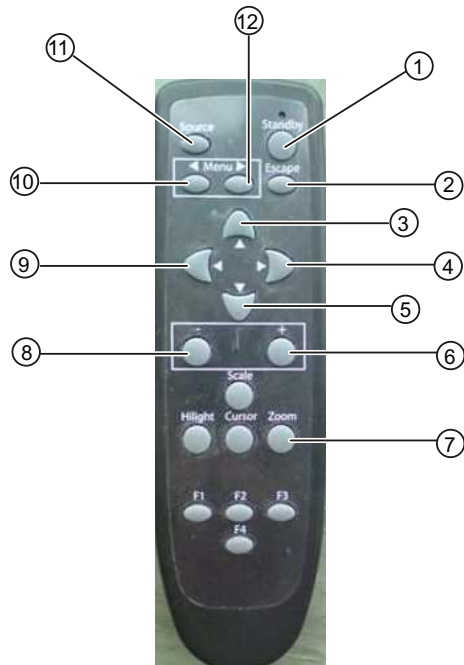

- |           |         |          |
|-----------|---------|----------|
| ① Standby | ⑤ Down  | ⑨ Left   |
| ② Escape  | ⑥ Plus  | ⑩ Menu L |
| ③ Up      | ⑦ Zoom  | ⑪ Source |
| ④ Right   | ⑧ Minus | ⑫ Menu R |

Key	Action
Menu L	<ul style="list-style-type: none"> <li>Open the OSD menu</li> <li>Navigate tab to the left</li> </ul>
Menu R	<ul style="list-style-type: none"> <li>Open the OSD menu</li> <li>Navigate tab to the right</li> </ul>
Escape	Exit OSD
Up	Navigate upwards in menu
Left	Close submenu
Right	Open submenu
Down	Navigate downwards in menu
Minus	Decrease value
Plus	Increase value
Standby	Switch the device to standby mode (this key must be held down for an extended period to avoid inadvertently turning off the monitor when accidentally pressing the standby button)
Source	Switch between connected signal sources
Zoom	Change the zoom ("One to One", "Fill all", "Fill to aspect ratio")

## 7.3 Lock or unlock OSD menu

<b>⚠ CAUTION</b>
<b>Locking and unlocking the OSD menu</b>
<ul style="list-style-type: none"><li>• Only authorized service personnel may lock or unlock the OSD menu.</li><li>• The OSD must be locked if inappropriate operation by the user can impact the intended use of the monitor.</li></ul>

The OSD menu of the LX491W is unlocked when shipped from the factory.

To lock or unlock the OSD menu, proceed as follows:

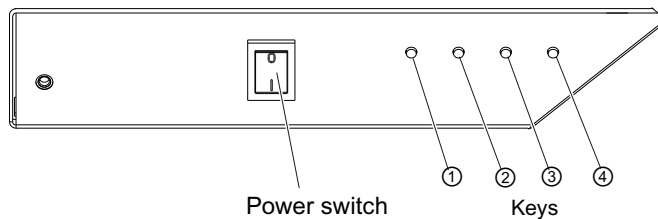

1. Press key ④ once.
2. Then press key ② three times.

The OSD menu is now locked or unlocked, depending on its initial state.

## 7.4 Picture layout (PaP, PiP, PoP)

### PaP: "Picture and Picture" arrangement

Two images from a primary and secondary video source are displayed next to one another.

### PiP "Picture in Picture" arrangement

The image content of the secondary video source is displayed on the main image, the primary video source.

### PoP "Picture over Picture" arrangement

<b>NOTICE</b>
<b>PoP image arrangement not for live operation</b>
When working with the PoP image arrangement, there is a time delay when displaying the images (snapshots).
<ul style="list-style-type: none"><li>• Do not use the PoP image arrangement for live operation.</li></ul>

Up to five images of various video sources may be displayed next to one another.

- The image from the primary video source is displayed in the larger segment in the lower section of the window.
- The other images are displayed in a smaller format in the upper section of the window.

## Operation

### 7.4 Picture layout (PaP, PiP, PoP)

The primary video source can be selected. The four additional video sources are added automatically in accordance with the following table of compatible video source combinations:

PiP / PaP Compatible combinations	DVI digital	DVI analog	VGA	S-Video	3G-SDI	Composite Video (CVBS) / SoG
DVI digital	-	-	-	o	o <sup>1</sup>	o
DVI analog	-	-	-	o	o <sup>1</sup>	o
VGA	-	-	-	o	o	o
S-Video	o	o	o	-	-	-
3G-SDI	o <sup>1</sup>	o <sup>1</sup>	o	-	-	-
Composite Video (CVBS) / SoG	o	o	o	-	-	-

- o Video sources can be displayed simultaneously
- Video sources cannot be displayed simultaneously

<sup>1</sup> **Note:** Flickering horizontal stripes may occur when the OSD is open.

#### Image settings on the PiP/PaP or PoP window

The image display and quality of the various PiP / PaP / PoP windows can be set individually.

- When "Picture layout PaP; PiP; PoP" is enabled in the "Signal" menu, an "Active adjustment window" selection appears in the main OSD menus for "Picture", "Image", and "Signal".
- The settings for the OSD window can be applied to the main or secondary window.

#### Note

##### Picture layout PaP, PiP, PoP

- In order to adjust the PiP or PaP window settings in the "Image" menu, "Active adjustment window" must be set to "PiP/PaP Window (2)".
- The number displayed on the right side of the OSD window indicates which window is currently active for the setting ("1": main window, "2": secondary window)

## 7.5 Overview of the OSD menu

You can use the OSD menu to change monitor settings or display information about the monitor.

If no input signal has been applied, the OSD only offers a limited set of functions.

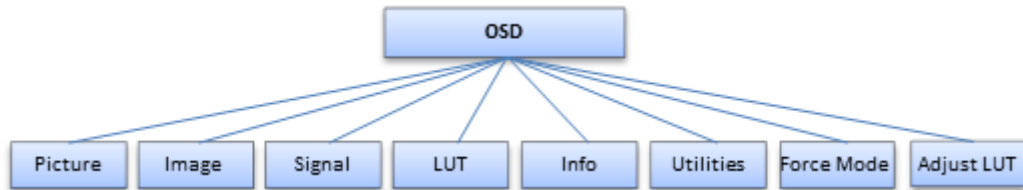
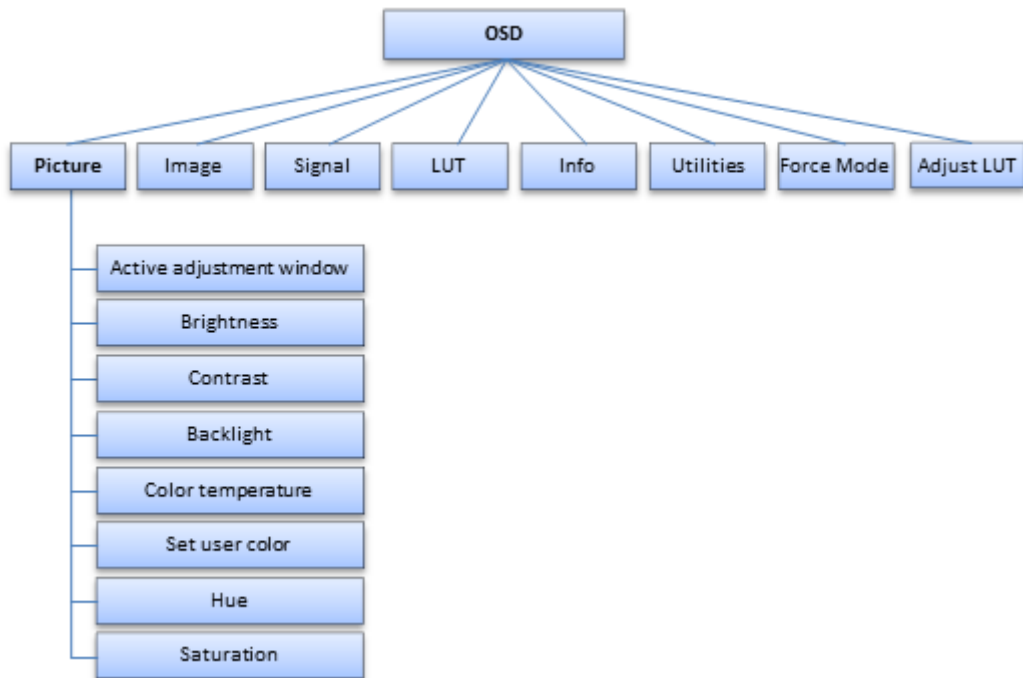

Fig.: OSD menu layout

## 7.6 "Picture" menu



Function	Values	Description
<b>Active adjustment window</b>	Main window (1) PiP window (2) <i>Default: Main window (1)</i>	<b>Selecting the active adjustment window</b> <b>Note:</b> The function is displayed only if the "Picture layout PaP, PiP, PoP" function is active within the "Signal" menu. The "Active adjustment window" establishes the window for which the settings in this menu apply.

Function	Values	Description
<b>Brightness</b>	Slider control <i>Default: 50</i>	<b>Set brightness</b> Adapting the representation of darker picture areas. <b>Note:</b> The brightness settings are already optimized for digital DVI signals. Do not change these values manually, as this can negatively impact picture quality (loss of gray scales).
<b>Contrast</b>	Slider control <i>Default: 50</i>	<b>Set contrast</b> Adapting the representation of brighter picture areas. <b>Note:</b> The contrast settings are already optimized for digital DVI signals. Do not change these values manually, as this can negatively impact picture quality (loss of gray scales).
<b>Backlight</b>	Slider control	<b>Adjust brightness of monitor backlight</b> Adjustment of overall brightness to ambient lighting. <b>Note:</b> The backlight settings always apply for all windows.
<b>Color temperature</b>	Native 9300°K 7300°K User <i>Default: Native</i>	<b>Set the desired color temperature or hue</b> The color temperatures can be selected from among three fixed settings or one adjustable setting. It is possible to define a different color temperature for each video input.
<b>Set user color</b>		<b>Define variable color temperature</b> The color setting defined here can be set in the "Color temperature" menu item using the "User" setting. <b>Note:</b> If the color coordinate is adjusted with this function, some color levels may be lost. To prevent a loss in color levels, calibrate the LUT color point with suitable QA software.
Red	Slider control <i>Default: 50</i>	Select red component of display.
Green	Slider control <i>Default: 50</i>	Select green component of display.
Blue	Slider control <i>Default: 50</i>	Select blue component of display.
<b>Hue</b>	Slider control <i>Default: 50</i>	Set the color hues for RGB and video signals. <b>Note:</b> "Hue" may only be set for S-Video or Composite signals.
<b>Saturation</b>	Slider control <i>Default: 50</i>	Set the color saturation for RGB and video signals. <b>Note:</b> This menu is not displayed for the monochrome CVBS signal.

## 7.7 "Image" menu

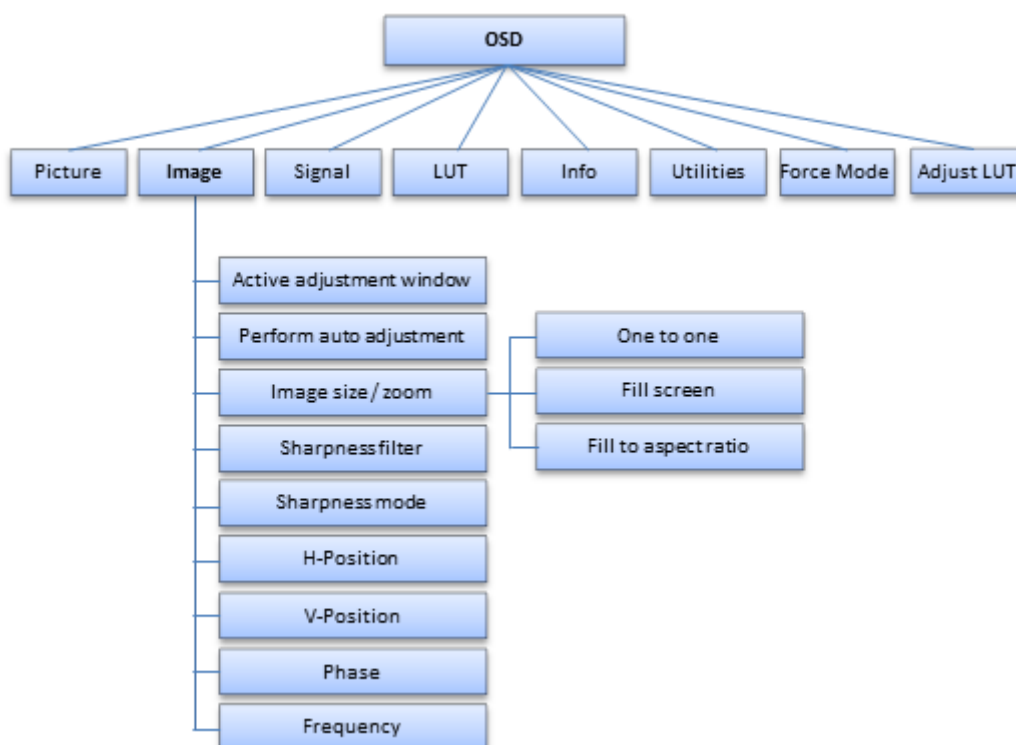

Function	Values	Description
<b>Active adjustment window</b>	Main window (1) PiP window (2) <i>Default: Main window (1)</i>	<b>Selecting the active adjustment window</b> <b>Note:</b> The function is displayed only if the "Picture layout PaP, PiP, PoP" function is active within the "Signal" menu. The "Active adjustment window" establishes the window for which the settings in this menu apply.
<b>Perform auto adjustment...</b>	Execute	<b>Perform auto adjustment</b> "Position", "Phase", and "Frequency" are set automatically upon confirmation of the selected function. <b>Note:</b> "Perform auto adjustment" can only be used for analog signal inputs.
<b>Image size / zoom</b>	One to One Fill to aspect ratio Fill screen <i>Default setting: One to One</i>	<b>Selection between different picture size settings:</b> <ul style="list-style-type: none"> <li><i>One to One:</i> The picture is displayed on screen in its original resolution.</li> <li><i>Fill to aspect ratio:</i> The picture is zoomed to the maximum screen area with retention of the aspect ratio.</li> <li><i>Fill screen:</i> The picture is displayed to fill the complete screen (1920 x 1080 pixels).</li> </ul>

Operation  
7.7 "Image" menu

Function	Values	Description
<b>Sharpness filter</b>	Slider control	<p><b>Select the sharpness setting</b></p> <p><b>Note:</b> To display the "Sharpness filter" function, "Sharpness mode" must be set to "Normal".</p> <p>Use the sharpness setting to reduce scaling artifacts or make the image "softer". A lower value creates a "soft" image impression and a higher value a "sharp" one.</p> <p><b>Note:</b> The optimum sharpness setting has to be determined visually.</p> <p>Common filters are available for the RGB sources (VGA, DVI).</p> <p>The interpolation filters depend on the input resolution. At lower resolutions, the filter calculates the value for the non-controlled pixels.</p>
<b>Sharpness mode</b>	Enhanced Normal <i>Default setting: Enhanced</i>	<p><b>Setting image sharpness mode</b></p> <p>Select "Enhanced" to display the image with the sharpest setting.</p> <p>Under "Normal", image sharpness can be set using the "Image sharpness filter" slider control.</p>
<b>H-position</b>	Slider control	Shift picture in horizontal direction
<b>V-position</b>	Slider control	Shift picture in vertical direction
<b>Phase</b>	Slider control	<p><b>Set the frequency and phase of the input signal</b></p> <p>Correct potential blur in the vertical lines by adjusting the "Frequency/Phase" setting.</p> <p><b>Note:</b> Use a vertical line in a "Pixel On/Off" test pattern to make the adjustment.</p>
<b>Frequency</b>	Slider control	



## 7.8 "Signal" menu

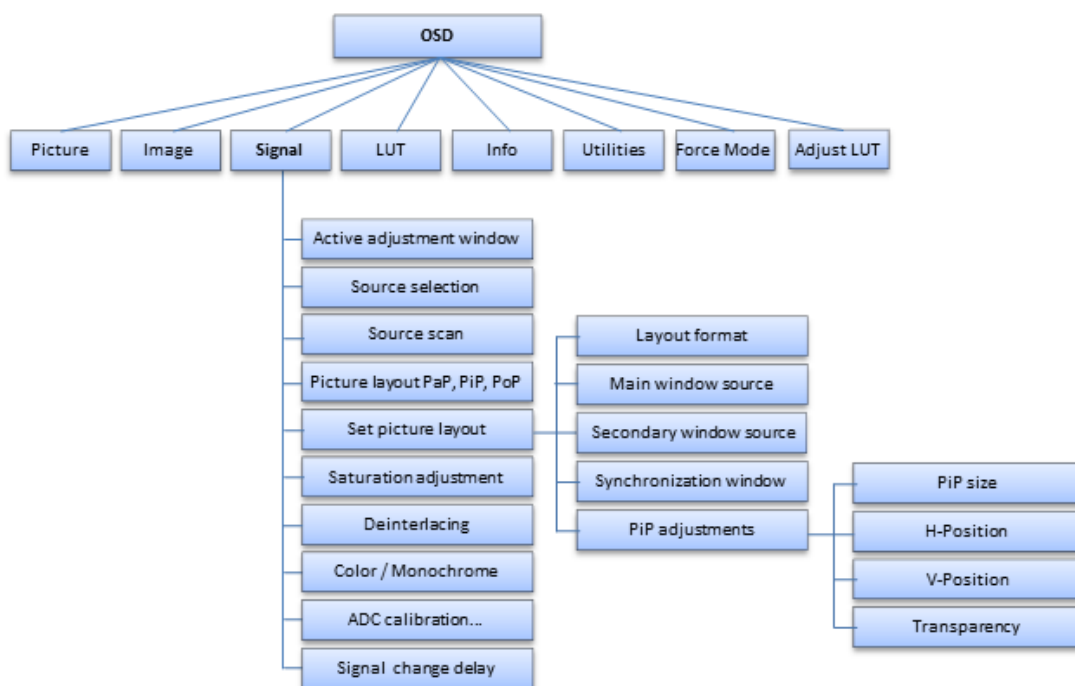

Function	Values	Description
<b>Active adjustment window</b>	Main window (1) PiP window (2) <i>Default: Main window (1)</i>	<b>Selecting the active adjustment window</b> <b>Note:</b> The function is displayed only if the "Picture layout PaP, PiP, PoP" function is active. The "Active adjustment window" establishes the window for which the settings in this menu apply.
<b>Source selection</b>	VGA / DVI 1 Analog / DVI 1 Digital / DVI 2 Digital / CVBS / S-Video / SDI /	<b>Select source for main display</b> <b>Note:</b> This function is only displayed when the "Source scan" function is set to "Disabled". Selection of picture source for full format image.
<b>Source scan</b>	Enabled / Disabled <i>Default: Enabled</i>	<b>Activate / deactivate automatic source scan</b> <ul style="list-style-type: none"> <li>Enabled: If the displayed source is no longer available, the monitor searches automatically for the next available source.</li> <li>Disabled: If the displayed source is no longer available, no image is displayed: The monitor does not search for available sources. The monitor screen appears black. An image is not displayed again unless a signal is applied to the set source or a different signal source is selected manually.</li> </ul>

Function	Values	Description
Picture layout PaP, PiP, PoP	Enabled / Disabled <i>Default: Disabled</i>	<p><b>Switch the preconfigured picture layout (PaP; PiP; PoP) on or off</b></p> <ul style="list-style-type: none"> <li>When "Picture layout PaP, PiP, PoP" is enabled, an "Active adjustment window" selection appears in the main OSD menus for "Picture", "Image", and "Signal".</li> <li>The settings for the OSD window can be applied to the main or secondary window.</li> </ul> <p><b>Note:</b> The number displayed on the right side of the OSD window indicates which window is currently active for the setting ("1": main window, "2": secondary window)</p>
<b>Set picture layout</b>		
Layout format	Picture in Picture (PiP) Picture and Picture (PaP) Picture over Picture (PoP) <i>Default: Picture in Picture (PiP)</i>	<p>The following picture layouts can be selected using this function:</p> <p><b>Picture in Picture (PiP):</b> The image content of the secondary video source is displayed on the main image (primary video source).</p> <p><b>Picture and Picture (PaP):</b> Two images from a primary and a secondary video source are displayed next to one another.</p> <p><b>Picture over Picture (PoP):</b> Up to five images of various video sources may be displayed next to one another.</p> <ul style="list-style-type: none"> <li>The image from the primary video source is magnified and displayed in the lower section of the window.</li> <li>The other images are displayed in a smaller format in the upper section of the window.</li> </ul> <p><b>Note:</b> For "Picture over Picture (PoP) images" there is a time delay when displaying images. This setting may not be used for live mode.</p>
Main window source		<p>Select the video sources displayed in the respective "Picture in Picture (PiP)", "Picture and Picture (PaP)", and "Picture over Picture (PoP)" windows.</p> <p>See also <a href="#">Picture layout (PaP, PiP, PoP) [▶ 35]</a> for compatible video source combinations.</p>
2nd Window source		
Synchronization window	Main window (1) PiP/PaP window (2) <i>Default: Main window (1)</i>	<p>Select whether the main or secondary window serves as the synchronization window.</p> <p><b>Note:</b> The "Synchronization Window" menu is only available when the "Picture in Picture (PiP)" setting is active.</p>

Function	Values	Description
<b>PiP adjustments</b>	The "PiP adjustments" menu only appears when the "Picture in Picture (PiP)" setting is active. <b>Note:</b> When initially selecting sources the "PiP adjustments" function is not always displayed. In this case, change to another OSD menu (such as "LUT") and then back to the "Signal" menu. The "PiP adjustments" function is now displayed.	
PiP size		Select the "Picture in Picture (PiP)" window size
H-position	Slider control	Set the horizontal position of the "Picture in Picture (PiP)" window
V-position	Slider control	Set the vertical position of the "Picture in Picture (PiP)" window
Transparency	Slider control	Select the "Picture in Picture (PiP)" window background ("opaque" or "transparent")
<b>Saturation adjustment</b>	Enabled / Disabled <i>Default: Disabled</i>	Activates the color adjustment of "Saturation" in the main "Picture" menu.
<b>Deinterlacing</b>	Field to frame Static mesh Normal <i>Default: Normal</i>	<b>Setting the "Deinterlacing" method</b> <b>Note:</b> The "Deinterlacing" function is shown only in conjunction with a supporting signal source. <b>Note:</b> If an interlaced signal is connected to a signal input (except for the 3G-SDI input) and the "Normal" setting is selected, brightness is reduced by approx. 15% due to the color space conversion of the deinterlacing. The deinterlacing settings "Field to frame" and "Static mesh" use other deinterlacing methods and cause only a slight reduction in brightness. The "Static mesh" setting is optimized for still images, but could cause comb effects in moving images. The "Field to frame" setting is optimized for moving images, but could cause comb effects in still images.
<b>Color / Monochrome</b>	Color Monochrome YPbPr/YCbCr <i>Default: Color</i>	<b>Switch signal between monochrome and color</b> If "Color" is set, a monochrome signal is displayed green. For correct gray scale representation, select the "Monochrome" setting.

Function	Values	Description
ADC calibration...	Execute	<p><b>Automatically calibrate A/D converter for the applied video level</b></p> <p><b>Note:</b> This function is only displayed when the "Saturation adjustment" function is disabled.</p> <p>The video level range of the system is checked, and the monitor set accordingly. This results in optimum adjustment of the individual RGB A/D converters to the video source.</p> <p>The calibration results in a larger and more flexible video level range (e.g., the full brightness is also achieved at 700 mV if the video level is limited at the value of 700 mV).</p> <p><b>Note:</b> A suitable test pattern is required. The A/D converters have been factory-set and need not be readjusted.</p> <p>The function is shown only in conjunction with a supporting signal source.</p>
Signal change delay	Slider control <i>Default: 1</i>	<p><b>Note:</b></p> <ul style="list-style-type: none"> <li>• The "Signal change delay" menu item is not available unless "Source scan" is set to "Enabled".</li> <li>• "Signal change delay" can only be set when "Picture layout PaP, PiP, PoP" is set to "Disabled".</li> </ul> <p>The following four parameters are relevant for the function:</p> <ul style="list-style-type: none"> <li>• H frequency</li> <li>• V frequency</li> <li>• V total</li> <li>• Interlaced/non Interlaced</li> </ul> <p>If one of these parameters changes, the monitor treats it as a timing change and initiates resynchronization via an "Auto in progress". To prevent this from happening as a result of each and every minor signal disturbance, the value representing the permissible number of faulty or changed borders must be increased in the case of unstable signal sources.</p> <p><b>Note:</b> The higher the slider setting, the longer it will take for a desired timing change to occur (delayed by a number of milliseconds).</p>

## 7.9 "LUT" menu

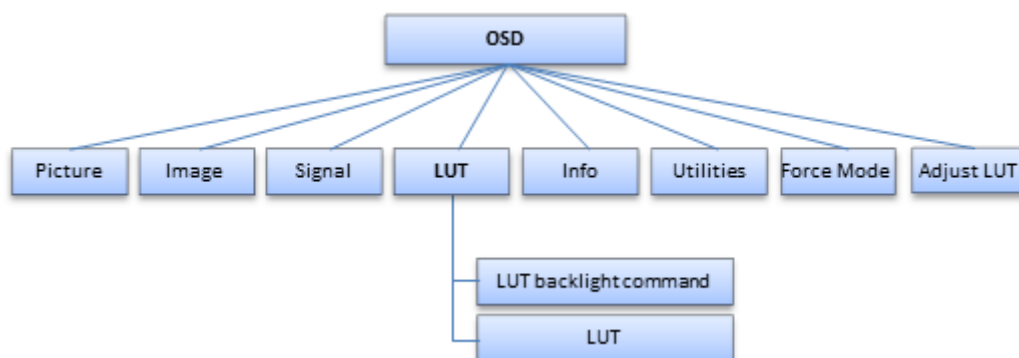

Function	Values	Description
<b>LUT backlight command</b>	Enabled Disabled <i>Default: Enabled</i>	<b>Control backlight using LUT</b> When "Enabled" is selected, the backlight setting is determined by the selected LUT. If "Disabled" is selected, the "Backlight" setting in the "Picture" menu applies. <b>Note:</b> The backlight retains this value even if the LUT is changed.
<b>LUT</b>	LUT 1-5, LUT User <i>Default: LUT 1</i>	<b>Select the Look Up Table (LUT)</b> The LUT determines the monitor's gamma curve. Using different LUTs for example, allows specific grayscale levels to be highlighted. When the "User" LUT is selected, the LUT can be individually set through the "Adjust LUT" OSD menu. See also " <a href="#">Adjust LUT</a> " menu [▶ 50]. A table with information regarding the available LUTs is displayed below the LUT selection. <b>Note:</b> Select a DICOM LUT to view radiographic images.

## 7.10 "Info" menu

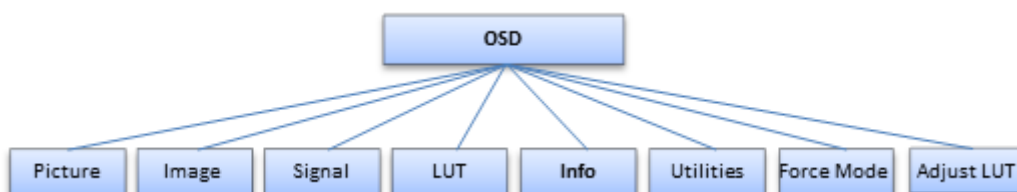

Function	Values	Description
Information	For display only	<p><b>Displays the current monitor and operating data in the respective picture mode</b></p> <ul style="list-style-type: none"> <li>• Serial number</li> <li>• Temperature [°C]</li> <li>• Operation time [h:m]</li> <li>• Backlight operation time [h:m]</li> <li>• BL on over 350 cd/m<sup>2</sup> [h]</li> <li>• Source</li> <li>• Mode</li> <li>• Source signal</li> <li>• 2nd Source</li> <li>• Mode</li> <li>• 2nd Source signal</li> <li>• FW type</li> <li>• FW version</li> <li>• OSD version</li> <li>• Config version</li> <li>• SDK version</li> </ul>

## 7.11 "Utilities" menu

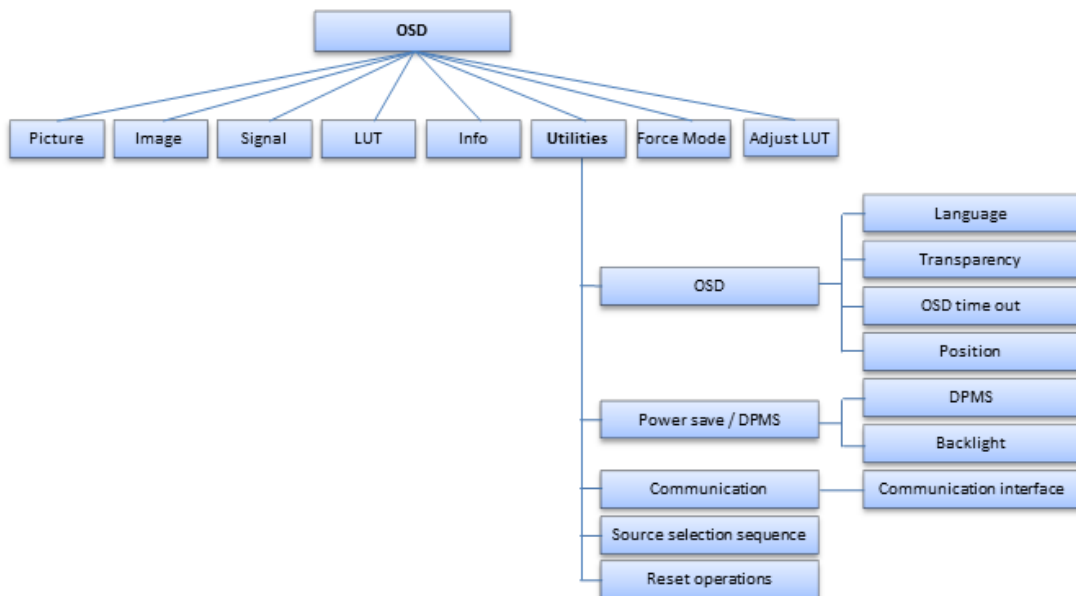

Function	Values	Description
<b>OSD</b>		
Language	German English <i>Default: English</i>	<b>Set language</b> German or English can be selected.
Transparency	Opaque Transparent Half transparent <i>Default: Opaque</i>	OSD background selection.
OSD timeout	Off / 5 sec / 10 sec / 30 sec / 1 min <i>Default: Disabled</i>	Closes the OSD menu after the specified time of inactivity.
Position	Top - left / Top - center / Top - right / Mid - left / Centered / Mid - right / Bottom - left / Bottom - center / Bottom - right <i>Default: Bottom - right</i>	Set the location of the OSD menu on the screen area using predefined positions

Function	Values	Description
<b>Power save / DPMS</b>		
DPMS	Enabled / Disabled <i>Default: Enabled</i>	<p><b>Enabling or disabling the DPMS (Display Power Management System)</b></p> <p><b>Note:</b> "Enabled" and "Disabled" modes of the DPMS standard are supported for analog signals. For digital signals, DVI-DMPM is supported at the DVI connection sockets</p> <ul style="list-style-type: none"> <li>If "DPMS" is activated and there is no input signal, the backlight is switched off or dimmed. This saves power, and increases the service life of the backlight.</li> </ul>
Backlight	Dimmed Disabled <i>Default: Disabled</i>	<p><b>The "Backlight" can be set to "Dimmed" or "Off"</b></p> <p>When the DPMS mode is active, the backlight is either dimmed or switched off. The controller board and power supply unit remain active. For digital signals, 5 V is also applied to the DVI socket for external modules.</p>
<b>Communication</b>		
Communications interface	DDC/DVI 1 digital DDC/DVI 2 digital USB <i>Default: USB</i>	<p><b>Select the interface for communication</b></p> <p>Serial communication is always active. Installers can also select between USB and DDC.</p>
Source selection sequence		The source scan is interrupted as soon as the first source with an active video signal is found. This signal is then displayed.
Reset operations	Reset to firmware defaults...	All user settings are deleted and reset to the firmware defaults.



## 7.12 "Force Mode" menu

Force Mode is used to set the timing of video sources that cannot be displayed with the timings saved in the monitor.

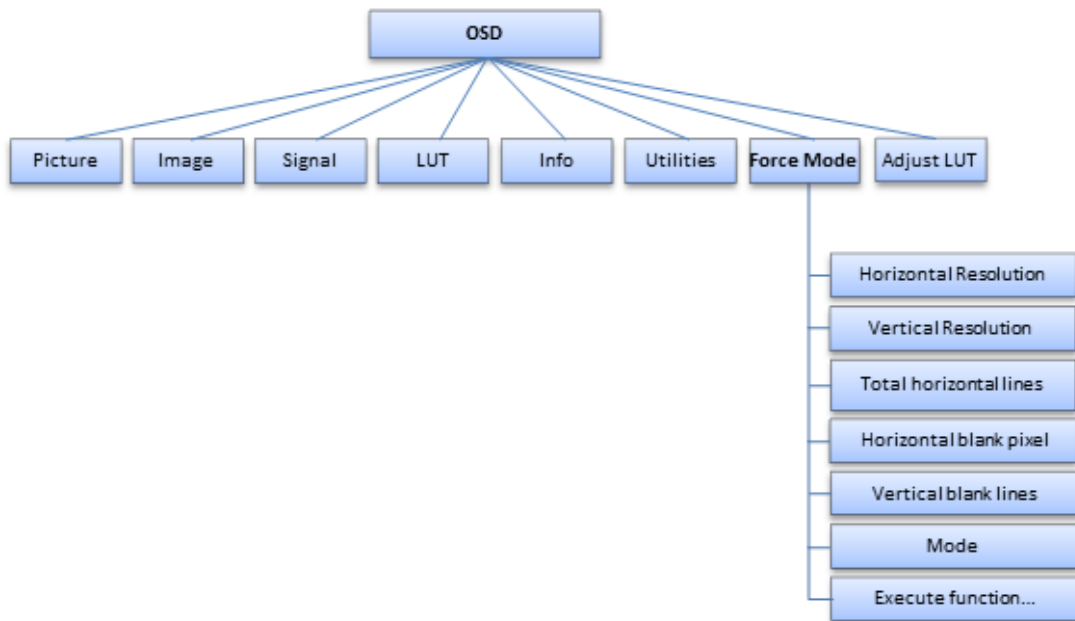

Function	Values	Description
<b>Horizontal Resolution</b>		Set the horizontal resolution in the active resolution range.
<b>Vertical Resolution</b>		Set the vertical resolution in the active resolution range.
<b>Total horizontal lines</b>		If the resolution is known, this can be used as the approximation value. The following applies: "Total horizontal lines" > "Horizontal resolution". A larger "Horizontal resolution" can result in the image being split vertically.
<b>Horizontal blank pixel</b>		Set the horizontal blanking interval.
<b>Vertical blank pixel</b>		Set the vertical blanking interval.
<b>Mode</b>	Active / Start / Inactive <i>Default: Inactive</i>	<b>Set Force Mode</b> <ul style="list-style-type: none"> <li>When "Active" is selected, the specified timing values are applied with "Execute function...".</li> <li>Force Mode is switched off when "Inactive" is selected.</li> <li>When "Start" is selected, the start values for the timing are determined using "Execute function...".</li> </ul> See also Determining the timing data
<b>Execute function...</b>		When "Start" is selected in Mode, the set video resolution is executed.

## 7.13 "Adjust LUT" menu

**Note**

- The "Adjust LUT" menu is displayed only if the "User" setting is selected in the "LUT" menu
- After each parameter change, the LUT in the device is immediately recalculated. This is indicated in the OSD menu by the message: "Gamma table being recalculated". When the calculation is complete, the message disappears from the OSD.

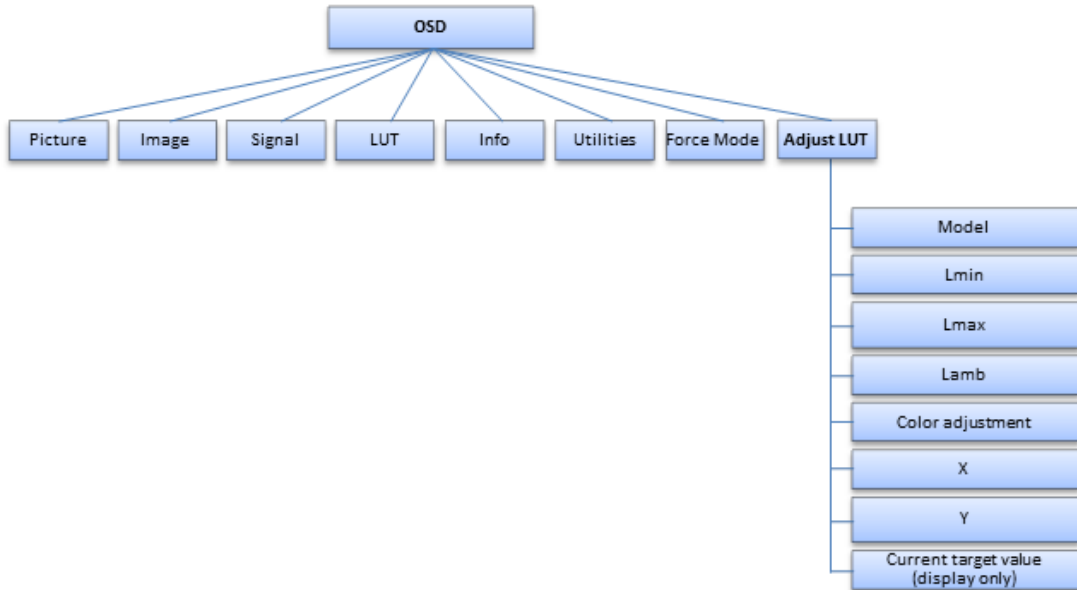

**CAUTION**

**Check the gray levels**

After each LUT recalculation performed in the "Adjust LUT" menu, it is absolutely necessary to apply an appropriate test pattern and check that all gray levels are displayed correctly.

Function	Values	Description
<b>Model</b>	<ul style="list-style-type: none"> <li>• Native</li> <li>• CIE 1976</li> <li>• CIE (DIN 6174)</li> <li>• CRT</li> <li>• DICOM</li> <li>• Gamma 2.0, 2.2, 2.5, 2.7, 3.0, 3.3</li> <li>• Log.Lum.linear</li> </ul> <p><i>Default: DICOM</i></p>	<p>The gamma model, which serves as the basis for recalculating the LUT, can be selected here.</p> <p><b>Note:</b> When "Natural" is selected, only the value for Lmax can be changed. All other functions are hidden.</p>
<b>Lmin</b>	<p>0 - 250</p> <p><i>Default: 40 (0.8 cd/m<sup>2</sup>)</i></p>	<p>Adapt the minimum black value between 0 and 5 cd/m<sup>2</sup></p>

Function	Values	Description
<b>Lmax</b>	0 - 250 <i>Default: 80 (400 cd/m<sup>2</sup>)</i>	Adapt the maximum white value between 200 and 600 cd/m <sup>2</sup>
<b>Lamb</b>	0 - 250 <i>Default: 25 (0.5 cd/m<sup>2</sup>)</i>	Takes into account the ambient light between 0 and 5 cd/m <sup>2</sup> when recalculating the LUT.
<b>Color adjustment</b>	<ul style="list-style-type: none"> <li>• Bluish</li> <li>• Intrinsic</li> <li>• Typical</li> </ul> <i>Default: Intrinsic</i>	Set the color coordinates to the following predefined values: <ul style="list-style-type: none"> <li>• Bluish: x = 0.272; y = 0.308.</li> <li>• Intrinsic: Color coordinates remain unchanged from their intrinsic values.</li> <li>• Typical: x = 0.300; y = 0.315.</li> </ul>
<b>X</b>	-100 - +100 <i>Default: 0 (x = 0.272)</i>	<b>X color coordinate correction</b> When using the color setting based on the existing defaults, it is also possible to individually modify the color coordinates. The X color coordinate can be adapted using the "X" function.
<b>Y</b>	-100 - +100 <i>Default: 0 (y = 0.308)</i>	<b>Y color coordinate correction</b> When using the color setting based on the existing defaults, it is also possible to individually modify the color coordinates. The Y color coordinate can be adapted using the "Y" function.
<b>Current target value (display only)</b>		

## 8 Cleaning and maintenance

### 8.1 Cleaning

#### Recommended cleaning agents and disinfectants

<b>NOTICE</b>		
<b>Device maintenance, cleaning and disinfecting</b>		
<ul style="list-style-type: none"> <li>• Make sure liquids do not seep into the device. Liquids that seep into the device may result in an electric shock or failure of the device.</li> <li>• The screen is extremely sensitive to mechanical influences. Absolutely avoid scratches, shocks, etc. for this reason.</li> <li>• Clean the screen when dirty using a microfiber cloth and, if necessary, a recommended cleaning agent. Clean the housing parts with a recommended cleaning agent.</li> <li>• Use only tested disinfectants.</li> <li>• If a cleaning agent is sprayed directly onto the screen surface, use a microfiber cloth to remove drops which run down before they reach the edge of the panel.</li> <li>• Remove drops of liquid from the device immediately. Contact with liquids over a longer period can cause discoloration or allow calcium deposits to form on the surface.</li> </ul>		

Agent class	Tested cleaning agents and disinfectants:	Further examples
Aldehyde	Melsitt	Aldasan 2000 Kohsolin Gigasept FF Cidex
Alcohol	Ethyl alcohol, 96%	Hospiset cloth
Peroxide compounds	Perform	Dismozon pur
Chlorine derivatives	Terralin	Quartamon Med
Disinfectants	Mikrozid liquid Nocolyse	TaskiDS5001 (Diverseylever Labs) Morning Mist Surfanios Fraicheur Citron (Anios Labs)
Guanidine derivatives	Lysoformin	
Quaternary compounds	Incidur spray, undiluted	
Standard household washing-up liquid	denk mit	Fairy Ultra, Pril, Palmolive
Pyridine derivatives	Activ spray, undiluted	
Water	Tap water Distilled water	

 <b>CAUTION</b>
<ul style="list-style-type: none"> <li>• Information on cleaning or disinfection of other system components can be obtained from the respective instructions for use.</li> </ul>

### Prohibited cleaning agents and disinfectants

The following cleaning agents and disinfectants can bleach the paint after a longer period of application:

Agent class	Tested cleaning agents and disinfectants:	Further examples
Petroleum spirit	Petroleum spirit close to boiling	Petroleum ether

## 8.2 Maintenance

<p> <b>CAUTION</b></p> <p><b>Maintenance</b></p> <ul style="list-style-type: none"> <li>• Maintenance may only be carried out by service personnel.</li> <li>• The monitor must not be serviced in the presence of patients.</li> </ul>
--

### Check the settings on a regular basis

The picture quality of the monitor changes due to aging of the LCD unit and the backlight.

- Check the monitor settings at regular intervals in accordance with the local guidelines.
- Correct the settings if necessary.

### Performing quality tests

You can check and change the monitor settings and calibrate them if necessary using a photometer and suitable software.

### Confirming the image quality visually after calibrating the monitor

After calibration, the monitor must be visually inspected to verify successful and correct completion of the calibration procedure. The following two test patterns, for example, are suitable:

- SMPTE image: The gray levels must be displayed correctly and visibly at both 5% and 95%.
- VeriLum image: The visible display of small squares in all gray scale levels confirms the correct calibration.

## 9 Troubleshooting

In normal operation, an image is displayed when the sources are set correctly. In the event of a fault, the following checks can help localize the cause, based on the screen display and the signal information in the OSD.

1. Check the device for the possible causes listed in the following.
2. Carry out the remedial measures before contacting service personnel.

### 9.1 Fault correction

Fault	Cause	Remedy
No picture appears on the monitor	Monitor is in standby	<ul style="list-style-type: none"> <li>• Check whether the monitor is in energy saving mode; for example, has Power Management been activated by the signal source and monitor?</li> <li>• End standby by holding down "Standby" on the remote control.</li> </ul>
	Power cable not connected or connected incorrectly	<ul style="list-style-type: none"> <li>• Check the power cable.</li> <li>• Is the power switch in the "On" position?</li> <li>• Can the OSD menu be activated?</li> </ul>
	No sync signal or video signal	<ul style="list-style-type: none"> <li>• Check whether source sweep has been switched on and the source chosen under source selection is connected.</li> <li>• Check the video cable.</li> </ul>
	Sync cable connected incorrectly	Exchange the sync cable connectors.
	The video source is not sending a video signal, or is sending an unknown timing.	<ul style="list-style-type: none"> <li>• Check the video source.</li> <li>• In the "Info" OSD menu, check whether the source was detected and that the source signal is in the displayable range.</li> </ul>
	The video source is sending an unknown timing	Set a different timing for the video source.
	Blown fuse	Contact service.
Fuzzy picture, interference in vertical lines	Scanning frequency or phase incorrectly set.	Set the frequency and phase.
Picture is without contrast and has a strong green shading	The video source is only transmitting a green signal	<ul style="list-style-type: none"> <li>• In the OSD "Signal" menu, switch from "Color" to "Monochrome".</li> <li>• Check the selected LUT and whether the USER settings can be changed.</li> <li>• Has the device been running for at least 20 minutes without Power Management activated?</li> </ul>
Other	Loose plug	Connect the loose plug and secure it.
	Defective cable	Replace the defective cable.

## 10 Technical specifications

<b>Note</b>
<b>Applicability of technical specifications</b> All technical specifications are valid after a warm-up period of 30 minutes.

### 10.1 Monitor characteristics

Display type	Color, TFT, IPS
Active area	1073.8 mm x 604 mm
Screen diagonal	48.5" (123.2 cm)
Resolution	1920 x 1080 pixels
Refresh rate	60 Hz
Pixel arrangement	RGB vertical stripes
Pixel distance	0.55926 mm x 0.55926 mm
Contrast ratio	1300:1 typical, 900:1 minimal
Horizontal viewing angle	Typically 178° for contrast ratio > 10:1
Vertical viewing angle	Typically 178° for contrast ratio > 10:1
Backlight type	White LEDs
Screen brightness	Typically 700 cd/m <sup>2</sup> Min. 560 cd/m <sup>2</sup>

### 10.2 Power supply

Power connector	Non-heating appliance socket
Line voltage	AC 100 - 240 V AC
Miniature fuse	2 T6.3 AH: UL 248-14, 250 V (5 x 20 mm)
Maximum current consumption	1.5 - 0.7 A
Power consumption	85 W (typical), 144 W (max)
Power consumption in Standby Mode	19 W

## 10.3 Electronics

Multi-standard technology	<ul style="list-style-type: none"> <li>• Video modes with resolutions less than 1920 x 1080 can be expanded to the TFT resolution, and thus utilize the full display area (like multi-sync CRTs)</li> <li>• For images with a resolution other than 1920 x 1080, select "One to one" for "Image size / zoom" in the "Image" menu. Otherwise, you will have to deal with scaling artifacts.</li> </ul> <p><b>Caution:</b> If the timing is frame-buffered or frame-synchronized, the picture information may be lost; the gray scales - the color hues for color images - are also reduced and may be invisible.</p>
Timing recognition	<p>The monitor detects various signals at the inputs and automatically adjusts itself to timings such as the following:</p> <ul style="list-style-type: none"> <li>• VGA: 60-85 Hz</li> <li>• SVGA: 56-85 Hz</li> <li>• XGA: 60-85 Hz</li> <li>• SXGA: 60-85 Hz</li> <li>• FHD: 60 Hz</li> <li>• UXGA: 60 Hz with vertical section</li> <li>• PAL: RGB, YUV</li> <li>• NTSC: RGB, YUV</li> <li>• SD-SDI: 487i, 576i</li> <li>• HD-SDI: 720p, 1080i, 1080p30</li> <li>• 3G-SDI: 720p, 1080i, 1080p30, 1080p60</li> </ul>
Communication interface	<ul style="list-style-type: none"> <li>• RS-232: Via RJ 11 socket</li> <li>• USB 2.0: 2 downstream (type A), 1 upstream (type B)</li> <li>• DDC: Via DVI-I</li> </ul>

## 10.4 Mechanical design

Housing components	Metal
Housing color	<ul style="list-style-type: none"> <li>• White (NCS S 1000-N)</li> <li>• Black (RAL 7021)</li> </ul>
Protective glass	Optically non-reflective protective glass on both sides
Ventilation openings	In rear panel
Degree of protection according to EN 60529	<ul style="list-style-type: none"> <li>• Front: IP65</li> <li>• Back: IP20</li> </ul>
Connection panel	On rear panel, under cover
Weight in kg	31 kg +/- 10%
Dimensions (W x H x D) in mm	1103 x 634 x 80.9



## 10.5 Climatic conditions

In operation	
Temperature range	+5 °C - +40 °C ambient temperature
Temperature gradient	Max. 5 °C/h, no condensation
Air pressure	700 - 1060 hPa (3000 m - -360 m)
For transport and storage (packed)	
Temperature range	-20 °C - +60 °C ambient temperature
Temperature gradient	Max. 5 °C/h, no condensation
Humidity	10 - 90 %, non condensing, at 25 °C
Air pressure	200 - 1060 hPa (12000 m - -360 m)

## 10.6 Safety regulations



This device bears a CE mark in accordance with the provisions of Council Directive 93/42/EEC and 2011/65/EU.

Safety standards	<ul style="list-style-type: none"> <li>• IEC 60601-1 (Edition 3.1)</li> <li>• IEC 60950-1:2005 (Second Edition) + A1:2009 + A2:2013</li> <li>• CAN/CSA - C 22.2 60601-1:08 (Third Edition)</li> <li>• GB 4943.1 (non-tropical, altitude &lt; 2000 m)</li> </ul>
Protection class	Protection class I
Degree of protection according to EN 60529	Front: IP65 Back: IP20
Medical product classification	Class I according to 93/42/EEC, Appendix IX

# 11 Dimension drawings

All dimensions in mm

## 11.1 View from front and side

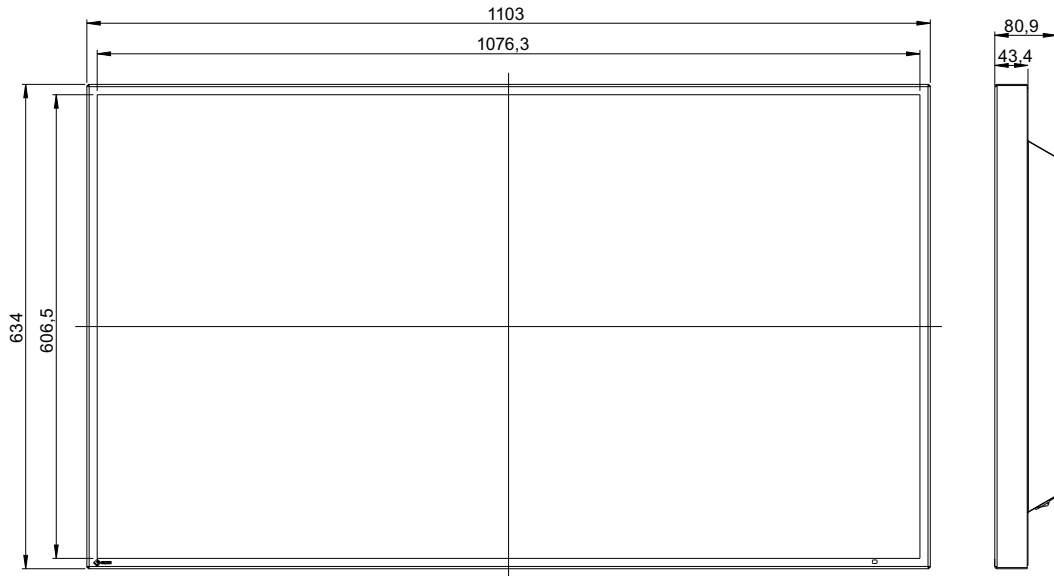

## 11.2 Rear view

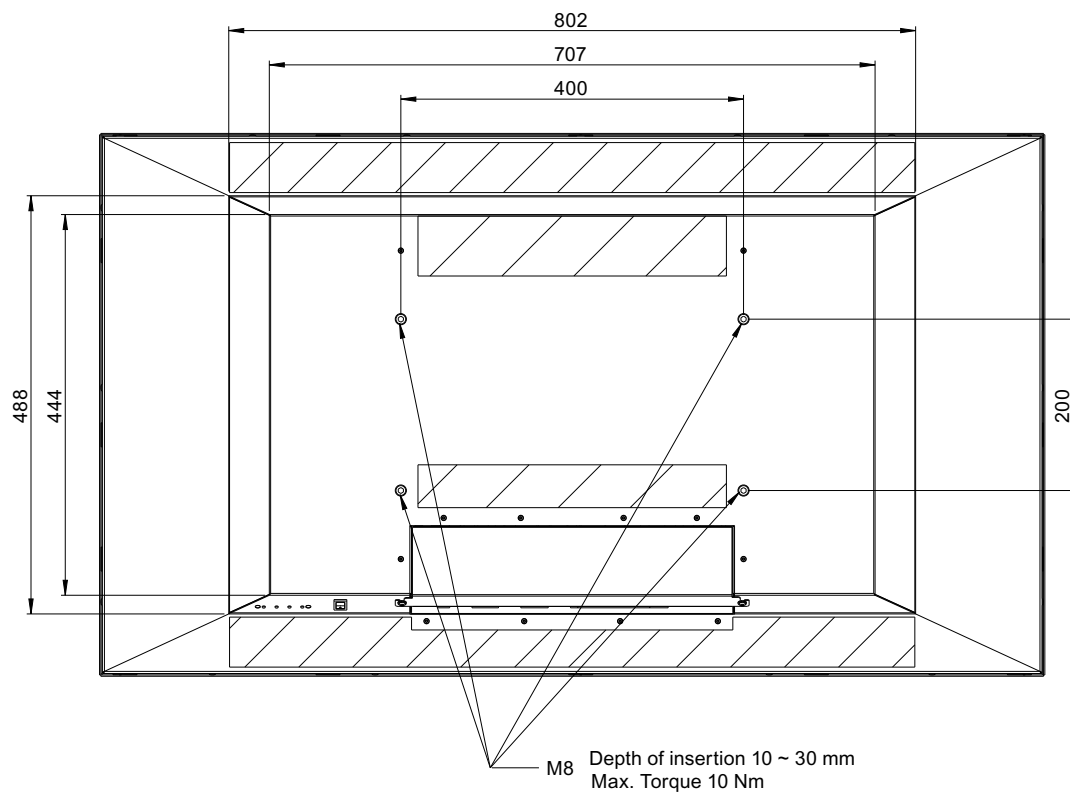

## 12 Spare parts / accessories

### 12.1 Accessories

Accessories	Order number	Description
FST4700 Black	6GF69888BA03	Stand, black
FST4700 White	6GF69888BA04	Stand, white

## 13 Appendix

### 13.1 Information on electromagnetic compatibility (EMC)

EIZO monitors were designed for the display of images and normal monitor operation.

<b>NOTICE</b>
<p>Special EMC provisions are required for use of the CuratOR LX491W. Installation, assembly, and use must take place in compliance with the following instructions.</p> <ul style="list-style-type: none"> <li>• Only use the cables included in the scope of delivery or recommended by the manufacturer. The use of other cables increases the risk of electromagnetic radiation and negatively impacts on electromagnetic interference immunity. Cable length: max. 3 m</li> <li>• Do not position any portable or mobile RF communication devices in the immediate vicinity of the monitor. Otherwise, problem-free function of the device cannot be guaranteed.</li> <li>• The monitor should not be placed on other devices or positioned in their immediate vicinity. If devices have to be operated on or in the immediate vicinity of one another, the monitor or system must be monitored to ensure proper operation for the defined configuration.</li> <li>• Persons connecting additional devices to the signal input or output when configuring a medical system are responsible for ensuring compliance with standard IEC/EN 60601-1-2.</li> </ul>

<b>Information and manufacturer's declaration – electromagnetic radiation</b>		
<p>The CuratOR LX491W is intended for use in the electromagnetic environments noted below. The customer or user of the CuratOR LX491W has to ensure that the device is used in such an environment.</p>		
<b>Radiation test</b>	<b>Conformity</b>	<b>Information regarding the electromagnetic environment</b>
RF radiation CISPR11/EN 55011	Group 1	The CuratOR LX491W uses RF radiation for internal operation only. For this reason, the RF radiation is very low and is therefore unlikely that the monitor will cause interference in electronic devices in the immediate vicinity.
RF radiation CISPR11/EN 55011 GB9254	Class B	
Harmonic currents IEC/EN 61000-3-2 GB17625.1	Class D	
Voltage fluctuations/ flicker IEC/EN 61000-3-3	fulfilled	

## 13.1 Information on electromagnetic compatibility (EMC)

<b>Information and manufacturer's declaration – electromagnetic radiation</b>			
The CuratOR LX491W is intended for use in the electromagnetic environments noted below. The customer or user of the CuratOR LX491W has to ensure that the device is used in such an environment.			
<b>Interference immunity test</b>	<b>IEC 60601 Measurement level</b>	<b>Compliance level</b>	<b>Information regarding the electromagnetic environment</b>
Electrostatic discharge (ESD) IEC/EN 61000-4-2	±8 kV contact ±15 kV air	±9 kV contact ±15 kV air	It is recommended to use the device on wood, concrete, or ceramic floors. If the floor is made of synthetic material, the relative humidity should be at least 30%.
Fast transient electric disturbances (burst) IEC/EN 61000-4-4	±2 kV (5 kHz and 100 kHz burst frequency) for power lines ±1 kV (5 kHz and 100 kHz burst frequency) for input/output lines	±3 kV (5 kHz and 100 kHz burst frequency) for power lines ±2 kV (5 kHz and 100 kHz burst frequency) for input/output lines	The power supply quality has to correspond to that of typical industrial environments or hospitals.
Surge voltage IEC/EN 61000-4-5	±1 kV line(s) against line(s) ±2 kV line(s) against ground	±2 kV line(s) against line(s) ±3 kV line(s) against ground	The power supply quality has to correspond to that of typical industrial environments or hospitals.
Voltage dips, brief interruptions, and voltage fluctuations along power supply lines IEC/EN 61000-4-11	<5 % $V_T$ (100 % dip in $V_T$ ) for 0.5 cycles 40 % $V_T$ (60 % dip in $V_T$ ) for 10 cycles 70 % $V_T$ (30 % dip in $V_T$ ) for 25 cycles <5% $V_T$ (100 % dip in $V_T$ ) for 250 cycles (5 seconds)	<5 % $V_T$ (100 % dip in $V_T$ ) for 0.5 cycles 40 % $V_T$ (60 % dip in $V_T$ ) for 10 cycles 70 % $V_T$ (30 % dip in $V_T$ ) for 25 cycles <5% $V_T$ (100 % dip in $V_T$ ) for 250 cycles (5 seconds)	The power supply quality has to correspond to that of typical industrial environments or hospitals. If the monitor has to continue operation even if the power supply is interrupted, it is recommended to connect the device to an uninterruptible power supply or battery.
Magnetic fields with energy technology frequencies (50/60 Hz) IEC/EN 61000-4-8	30 A/m	30 A/m	The magnetic fields with energy technology frequencies must be in an area that is representative of a typical location in a typical industrial environment or hospitals.
<b>Note:</b> $V_T$ is the alternating current voltage before application of the measurement level. The measurement levels were established according to IEC60601-1-2 4th Edition - Professional Healthcare.			

Appendix





13.1 Information on electromagnetic compatibility (EMC)















Information and manufacturer's declaration – electromagnetic radiation			
<p>The CuratOR LX491W is intended for use in the electromagnetic environments noted below.</p> <p>The customer or user of the CuratOR LX491W has to ensure that the device is used in such an environment.</p>			
Interference immunity test	IEC 60601 Measurement level	Compliance level	Information regarding the electromagnetic environment
<p>Conducted disturbances</p> <p>IEC/EN 61000-4-6</p>	<p>3 Vrms 150 kHz to 80 MHz</p> <p>6 Vrms ISM bands</p>	6 Vrms	<p>Portable and mobile RF communications devices may only be operated in the vicinity of the monitor when in compliance with the recommended minimum distance.</p> <p>It is determined using the formula for calculating the frequency of the transmitter.</p>
<p>High-frequency electromagnetic fields</p> <p>IEC/EN 61000-4-3</p>	<p>3 V/m 80 MHz to 2.7 GHz</p>	10 V/m	<p>Recommended minimum distance</p> <p><math>d = [3.5/6] \sqrt{P} = 0.583 \sqrt{P}</math></p> <p><math>d = [3.5/10] \sqrt{P} = 0.35 \sqrt{P}</math>, 80 MHz to 800 MHz</p> <p><math>d = [7/10] \sqrt{P} = 0.7 \sqrt{P}</math>, 800 MHz to 2.7 GHz</p> <p>In this case, "P" stands for the measured maximum nominal output power in watts (W) of the transmitter recommended by the transmitter manufacturer, and "d" for the recommended minimum distance in meters (m).</p> <p>The field strengths of fixed transmitters according to electromagnetic location measurement<sup>a</sup> have to be less than the compliance level in each individual frequency range<sup>b</sup>.</p> <p>Interference can occur when used in the vicinity of devices identified with the following symbol.</p> 
<p><b>Note:</b> The higher frequency range applies at 80 MHz and 800 MHz.</p>			
<p><b>Note:</b> This information may not be applicable in all situations. Absorption and reflection by structures, objects, and people impact the propagation of electromagnetic waves. The measurement levels were established according to IEC60601-1-2 4th Edition - Professional Healthcare.</p>			
<p><sup>a</sup> The field strengths of fixed transmitters, for example the base station for cordless and mobile telephones, radio, land mobile radio, ham radio, and television cannot be determined precisely in advance. To evaluate the electromagnetic environment using fixed transmitters, an electromagnetic location measurement should be included. If the measured field strength in the environment where the device is used exceeds the applicable RF compliance level, observe the monitor to ensure its proper operation. If improper operation is observed, in some circumstances additional measures may be necessary, such as reorienting or repositioning the device.</p>			
<p><sup>b</sup> The field strength beyond the frequency range 150 kHz to 80 MHz should be less than 3 V/m.</p>			

Recommended minimum distance between portable and mobile RF communications devices and the CuratOR LX491W			
The CuratOR LX491W is intended for use in an electromagnetic environment in which interference due to electromagnetic radiation is controlled.			
The customer or user of the monitor can help prevent electromagnetic interference by maintaining the recommended minimum distance between portable and mobile RF communications devices (transmitter) and the monitor as shown below. This is based on the maximum output power of the communication device.			
Maximum nominal output power of the transmitter (W)	Recommended minimum distance according to the frequency of the transmitter (m)		
	150 kHz to 80 MHz $d = 0.583 \sqrt{P}$	80 MHz to 800 MHz $d = 0.35 \sqrt{P}$	800 MHz to 2.7 GHz $d = 0.7 \sqrt{P}$
0.01	0.058	0.035	0.07
0.1	0.184	0.110	0.221
1	0.583	0.35	0.7
10	1.844	1.106	2.213
100	5.833	3.5	7
For transmitters whose maximum nominal output power is not shown above, the recommended minimum distance "d" in meters (m) can be determined using the formula for calculating the frequency of the transmitter. "P" here stands for the transmitter's maximum measured nominal output power in watts (W), as recommended by the transmitter's manufacturer.			
<b>Note:</b> For 80 MHz and 800 MHz, the recommended minimum distance for the higher frequency range applies.			
<b>Note:</b> This information may not be applicable in all situations. Absorption and reflection by structures, objects, and people impact the propagation of electromagnetic waves.			

## 13.2 Markings and symbols

The markings and symbols on the device indicate the following:

Marking/symbol	Description
	Symbol for "Caution, observe accompanying documents".
	CE marking (EU conformity mark).
Electrical Safety 	MET marking, in accordance with U.S. and Canadian national regulations.
	CCC marking, in accordance with for Chinese national regulations (pending).
	RCM marking for conformity with Australian EMC standards (pending).

Marking/symbol	Description
	Symbol for date of production for medical products.
	WEEE marking: Product must be disposed of separately; materials may be recycled.
	Marking according to ACPEIP (China-RoHS).
	Symbol for protective ground (ground)
	"On" symbol (voltage)
	"Off" symbol (voltage)
	Input for service calls
	Symbol for USB
	Symbol for input.
	Symbol for output.
	Symbol for direct current.
	Symbol "Comply with the instructions for use".
	Symbol for "Authorized service personnel only".
	Symbol for "Dangerous voltage".

## 13.3 Warranty

Opening of the housing, or electrical or mechanical changes on or in the device, result in cancellation of the warranty. For warranty details, please contact the sales partner from whom you purchased the product. These warranty conditions are neither extended nor limited by the contents of this instruction manual.



## 13.4 Repairs

Please contact the sales partner from whom you purchased the product.

## 13.5 Environmental protection

Comply with all local requirements and laws pertaining to the disposal of devices.

The device is in compliance with directive 2011/65/EU for limiting the use of specific hazardous materials in electric and electronic devices.

## 13.6 China RoHS (Restriction of Hazardous Substances)

### 液晶显示器 LCD Monitor

型号 Model: CuratOR LX491W

根据SJ/T11364-2014《电子电气产品有害物质限制使用标识要求》特提供如下有关污染控制方面的信息。

The following product pollution control information is provided according to SJ/T11364-2014 Marking for the restriction of the use of hazardous substances in electrical and electronic product.

### 电子信息产品污染控制标志说明 Explanation of Pollution Control Label



该标志表明本产品不含有超过中国标准GB/T26572-2011《电子电气产品中限用物质的限量要求》中限量的有毒有害物质。该标志还表示本产品废弃后可以回收利用，不应随意丢弃。

This symbol indicates the product does not contain hazardous materials in excess of the limits established by the Chinese standard GB/T26572-2011 Requirements of concentration limits for certain restricted substances in electrical and electronic products. The symbol also signifies that the product can be recycled after being discarded, and should not be casually discarded.

**有毒有害物质或元素的名称及含量****Name and Concentration of Hazardous Substances**

部件名称 Component Name	有毒有害物质或元素 Hazardous substances' name					
	铅 (Pb)	汞 (Hg)	镉 (Cd)	六价铬 (Cr(VI))	多溴联苯 (PBB)	多溴二苯醚 (PBDE)
液晶纯平屏幕 LCD Flat Screen	○	○	○	○	○	○
控制板 Controller Board	○	○	○	○	○	○
电源 Power Supply	○	○	○	○	○	○
其他 电路板 Other Circuit Boards	○	○	○	○	○	○
其他 ( 电缆等 ) Others (cables, etc.)	○	○	○	○	○	○
机架、底盘 Housing, Chassis	○	○	○	○	○	○
附件 ( 信号电缆、输电线等 ) Accessories (signal cable, power line, etc.)	○	○	○	○	○	○

本表格依据SJ/T 11364 的规定编制。

○: 表示该有害物质在该部件所有均质材料中的含量均在GB/T 26572 标准规定的限量要求以下

X: 表示该有害物质至少在该部件的某一均质材料中的含量超出GB/T 26572 标准规定的限量要求

- 此表所列数据为发布时所能获得的最佳信息。
- 由于缺少经济上或技术上合理可行的替代物质或方案，此医疗设备运用以上一些有害物质来实现设备的预期临床功能，或给人员或环境提供更好的保护效果。

This list is based on SJ/T 11364.

○: Indicates that this toxic or hazardous substance contained in all of the homogeneous materials for this part is below the limit requirement in GB/T 26572.

X: Indicates that this toxic or hazardous substance contained in at least one of the homogeneous materials used for this part is above the limit requirement in GB/T 26572.

- Data listed in the table represents best information available at the time of publication.
- Applications of hazardous substances in this medical device are required to achieve its intended clinical uses, and/or to provide better protection to human beings and/or to environment, due to lack of reasonably (economically or technically) available substitutes.

产品中有毒有害物质或元素的名称及含量 Table of hazardous substances' name and concentration.

**13.7 Additional devices**

Connected devices such as PCs must meet the relevant safety standards.

## 13.8 Contact

### Support during installation and for technical questions

[www.eizo-or.com](http://www.eizo-or.com)

## 13.9 Trademarks

The EIZO Logo is a registered trademark of EIZO Corporation in Japan and other countries.

EIZO is a registered trademark of EIZO Corporation in Japan and other countries.

RadiForce is a registered trademark of EIZO Corporation in Japan and other countries.

CuratOR is a registered trademark of the EIZO Corporation.

RadiCS is a registered trademark of EIZO Corporation in Japan and other countries.

RadiNET is a registered trademark of EIZO Corporation in Japan and other countries.

ScreenManager is a registered trademark of EIZO Corporation in Japan and other countries.

Windows is a registered trademark of Microsoft Corporation in the United States and other countries.

Apple is a registered trademark of Apple Inc.

Macintosh is a registered trademark of Apple Inc.

Mac is a registered trademark of Apple Inc.

VESA is a registered trademark of the Video Electronics Standards Association in the United States and other countries.

HDMI is a trademark or registered trademark of HDMI Licensing, LLC in the United States and other countries.

DICOM is a registered trademark of the National Electrical Manufacturers Association for the publication of standards in the area of digital communication of medical information.

TORX is a registered trademark of Acument Intellectual Properties, LLC.

All other company and product names are trademarks or registered trademarks of their respective owners.

## Index

### A

Assembly 16

### C

CE marking 57  
 Cleaning staff 5  
 Connecting 21  
 Connection panel 20  
 Contact 67

### D

Disposal 65

### E

Energy saving 23, 24

### F

Fault 54  
 Force Mode 26, 49

### G

General safety instructions 6  
 Grounding 17

### I

Image Sticking 23  
 Input 20  
 Installation site 14

### L

Line power 22  
 LUT 45  
     Adjust 50

### M

Maintenance 53  
 Monitor information 46

### O

OSD menu  
     Adjust LUT 50  
     Force Mode 49  
     Image quality 37  
     Image setting 39  
     Info 46  
     LUT 45  
     Overview 37  
     Signal 41  
     Tools 47  
 Output 20  
 Overheating 14

### P

Pixel defects 24  
 Power connector 22  
 Protective screen 13

### S

Service 5  
 Shielding measures 17  
 Signal input 20, 21  
 Signal output 20

### T

Technical specifications 55  
 Timing  
     Basic information 27  
     determining 29  
 Troubleshooting 54

### U

User 5

### W

Warranty 64





**EIZO GmbH**  
Siemensallee 84  
76187 Karlsruhe  
Germany

Copyright © 2018 EIZO GmbH. All rights reserved.



Instructions for Use, 02/2018  
CuratOR LX491W  
1084978-001