



HP ProBook 645 G4 Notebook PC

Maintenance and Service Guide

© Copyright 2018 HP Development Company, L.P.

AMD and AMD Radeon are trademarks of Advanced Micro Devices, Inc. Bluetooth is a trademark owned by its proprietor and used by HP Inc. under license. Intel and Core are trademarks of Intel Corporation in the U.S. and other countries. Microsoft and Windows are trademarks of the Microsoft group of companies.

The information contained herein is subject to change without notice. The only warranties for HP products and services are set forth in the express warranty statements accompanying such products and services. Nothing herein should be construed as constituting an additional warranty. HP shall not be liable for technical or editorial errors or omissions contained herein.

First Edition: March 2018

Document Part Number: L13016-001

Product notice

This user guide describes features that are common to most models. Some features may not be available on your computer.

Not all features are available in all editions of Windows. This computer may require upgraded and/or separately purchased hardware, drivers and/or software to take full advantage of Windows functionality. Go to <http://www.microsoft.com> for details.

Software terms

By installing, copying, downloading, or otherwise using any software product preinstalled on this computer, you agree to be bound by the terms of the HP End User License Agreement (EULA). If you do not accept these license terms, your sole remedy is to return the entire unused product (hardware and software) within 14 days for a full refund subject to the refund policy of your seller.

For any further information or to request a full refund of the price of the computer, please contact your seller.

Important Notice about Customer Self-Repair Parts

 **CAUTION:** Your computer includes Customer Self-Repair parts and parts that should only be accessed by an authorized service provider. See Chapter 5, "Removal and replacement procedures for Customer Self-Repair parts," for details. Accessing parts described in Chapter 6, "Removal and replacement procedures for Authorized Service Provider only parts," can damage the computer or void your warranty.

Safety warning notice

 **WARNING!** To reduce the possibility of heat-related injuries or of overheating the device, do not place the device directly on your lap or obstruct the device air vents. Use the device only on a hard, flat surface. Do not allow another hard surface, such as an adjoining optional printer, or a soft surface, such as pillows or rugs or clothing, to block airflow. Also, do not allow the AC adapter to contact the skin or a soft surface, such as pillows or rugs or clothing, during operation. The device and the AC adapter comply with the user-accessible surface temperature limits defined by the International Standard for Safety of Information Technology Equipment (IEC 60950-1).

Table of contents

1 Product description	1
2 Components	6
Right	6
Left	8
Display	9
Keyboard area	10
TouchPad	10
Lights	11
Buttons, speakers, and fingerprint reader	12
Special keys	13
Action keys	14
Hot keys (select products only)	15
Bottom	16
Labels	17
3 Illustrated parts catalog	18
Computer major components	18
Cable Kit	21
Display assembly subcomponents	22
Plastics	23
Mass storage devices	24
Miscellaneous parts	25
4 Removal and replacement procedures preliminary requirements	27
Tools required	27
Service considerations	27
Plastic parts	27
Cables and connectors	28
Drive handling	28
Grounding guidelines	29
Electrostatic discharge damage	29
Packaging and transporting guidelines	30
Workstation guidelines	30
Equipment guidelines	31

5 Removal and replacement procedures for Customer Self-Repair parts	32
Component replacement procedures	32
Bottom cover	33
Battery	34
Memory	35
Hard drive	37
Solid-state drive	39
6 Removal and replacement procedures for Authorized Service Provider parts	40
Component replacement procedures	40
WWAN module	40
WLAN module	42
Keyboard	43
Internal frame	47
Fan	50
Heat sink assembly	51
TouchPad button board	54
TouchPad	56
Near Field Communication (NFC) module	57
Smart card reader	59
USB board	61
Power button board	63
System board	65
RTC battery	69
Speaker	70
Fingerprint reader assembly	71
Display assembly	73
7 Computer Setup (BIOS), TPM, and HP Sure Start	81
Using Computer Setup	81
Starting Computer Setup	81
Using a USB keyboard or USB mouse to start Computer Setup (BIOS)	81
Navigating and selecting in Computer Setup	81
Restoring factory settings in Computer Setup	82
Updating the BIOS	82
Determining the BIOS version	82
Downloading a BIOS update	83
Changing the boot order using the f9 prompt	84
TPM BIOS settings (select products only)	84
Using HP Sure Start (select products only)	84

8 Using HP PC Hardware Diagnostics	85
Using HP PC Hardware Diagnostics Windows	85
Downloading HP PC Hardware Diagnostics Windows	85
Downloading the latest HP PC Hardware Diagnostics Windows version	86
Downloading HP Hardware Diagnostics Windows by product name or number (select products only)	86
Installing HP PC Hardware Diagnostics Windows	86
Using HP PC Hardware Diagnostics UEFI	86
Starting HP PC Hardware Diagnostics UEFI	87
Downloading HP PC Hardware Diagnostics UEFI to a USB flash drive	87
Downloading the latest HP PC Hardware Diagnostics UEFI version	87
Downloading HP PC Hardware Diagnostics UEFI by product name or number (select products only)	87
Using Remote HP PC Hardware Diagnostics UEFI settings (select products only)	88
Downloading Remote HP PC Hardware Diagnostics UEFI	88
Downloading the latest Remote HP PC Hardware Diagnostics UEFI version	88
Downloading Remote HP PC Hardware Diagnostics UEFI by product name or number	88
Customizing Remote HP PC Hardware Diagnostics UEFI settings	88
 9 Backing up, restoring, and recovering	 90
Creating recovery media and backups	90
Creating HP Recovery media (select products only)	90
Using Windows tools	91
Restore and recovery	92
Recovering using HP Recovery Manager	92
What you need to know before you get started	92
Using the HP Recovery partition (select products only)	93
Using HP Recovery media to recover	93
Changing the computer boot order	94
Removing the HP Recovery partition (select products only)	95
 10 Specifications	 96
Computer specifications	96
35.6-cm (14.0-in) display specifications	97
M.2 PCIe solid-state drive specifications	98
M.2 SATA solid-state drive specifications	99
Hard drive specifications	100
 11 Power cord set requirements	 101
Requirements for all countries	101

Requirements for specific countries and regions	101
12 Statement of memory volatility	103
Nonvolatile memory usage	105
Questions and answers	107
Using HP Sure Start (select models only)	108
13 Recycling	109
Index	110

1 Product description

Category	Description
Product Name	HP 645 ProBook G4 Notebook PC
Processor	AMD Ryzen™ mobile processors with Radeon™ Vega Graphics: <ul style="list-style-type: none">• AMD Ryzen 7 PRO 2700U• AMD Ryzen 5 PRO 2500U• AMD Ryzen 3 PRO 2300U
Graphics	Intergrated UMA graphics: Radeon Vega Graphics Up to three independent displays supported with HP Docking Station and with HP Docking Station HP Thunderbolt Dock G2
Panel	Supports standard bezel 35.6-cm (14.0-in), anti glare, slim, 45% CG, 220 nits, eDP 1.2, non-touch: High definition (HD)(1366×768) without camera HD (1366×768) with camera HD (1366×768) without camera, with WWAN HD (1366×768) with camera, with WWAN Full high-definition (FHD)(1920×1080) IPS without camera FHD (1920×1080) IPS with camera FHD (1920×1080) IPS with WWAN, without camera FHD (1920×1080) IPS with WWAN, with camera 35.6-cm (14.0-in), 45% CG, eDP 1.2, slim, 220 nits, touch screen: FHD (1920×1080) IPS, with WWAN, with camera
Memory	Two memory module slots Memory is customer accessible/upgradeable DDR4-2400, dual-channel support Supports up to 32 GB of system RAM in the following configurations: <ul style="list-style-type: none">• 32768 MB (16384 MB×2)• 16384 MB (16384 MB×1) or (8192 MB×2)• 12288 MB (8192 MB×1 + 4096 MB×1)• 8192 MB (8192 MB×1 or 4096 MB×2)• 4096 MB (4096 MB×1)

Category	Description
Primary storage	Hard drives, SATA, 6.35 cm (2.5-in), 7.0 mm (.28 in)
	<ul style="list-style-type: none"> • 2 TB, 5400 rpm
	<ul style="list-style-type: none"> • 1 TB, 7200 rpm
	<ul style="list-style-type: none"> • 500 GB, 7200 rpm, self-encrypting drive (SED), FIPS 140-2
	<ul style="list-style-type: none"> • 500 GB, 7200 rpm
Primary M.2 storage	M.2 solid-state drives (NGFF, 2280):
	<ul style="list-style-type: none"> • 1 TB, PCIe, Gen3×4, SS, NVMe, TLC
	<ul style="list-style-type: none"> • 512 GB, PCIe, Gen3×4, SS, NVMe, TLC
	<ul style="list-style-type: none"> • 512 GB, SATA-3, SS, TLC, FIPS-140-2
	<ul style="list-style-type: none"> • 360 GB, PCIe, Gen3×4, SS, NVMe, TLC (Intel)
	<ul style="list-style-type: none"> • 256 GB, PCIe, Gen3×4, SS, NVMe, TLC
	<ul style="list-style-type: none"> • 256 GB, PCIe, SS, NVMe, value
	<ul style="list-style-type: none"> • 256 GB, SATA-3, TLC, Opal 2
<ul style="list-style-type: none"> • 128 GB, SATA-3, SS, TLC 	
Audio and video	Audio controls
	Dual-array microphone
	Stereo speakers (2)
	Camera HD 720p
	Camera privacy shutter (only with non-touch camera panels)
	Supports WDR (Wide Dynamic Range)
	Support for models without camera
Ethernet	Realtek RTL8111EPH-CG 10/100/1000 Ethernet NIC with DASH Support
	*The following support S3/S4/S5 wake on LAN/HBMA (via out of band): embedded NIC, HP Elite USB-C Dock, HP USB-C Universal Dock, HP Thunderbolt Dock 120W/230W G2, and HP USB-C Mini Dock.
	*The following support S3 wake on LAN/HBMA (via Windows operating system): HP Thunderbolt 3 Dock, HP Elite USB-C Docking Station G2, HP USB-C Travel Dock, and HP USB Travel Dock.
Wireless networking	Wireless Personal Area Network (WPAN) Bluetooth
	Integrated wireless personal area network (PAN) supported by Bluetooth® 4.2 combo card
	Wireless Local Area Network (WLAN)
	Supports the following WLAN formats:
	<ul style="list-style-type: none"> • Intel Dual Band Wireless-AC 3168 802.11ac 1×1 WiFi + Bluetooth 4.2 combo adapter (non-vPro)
	<ul style="list-style-type: none"> • Intel Dual Band Wireless-AC 8265 802.11ac 2×2 WiFi + Bluetooth 4.2 combo adapter (non-vPro)
	<ul style="list-style-type: none"> • Realtek RTL8822BE 802.11ac 2×2 Wi-Fi + Bluetooth 4.2 combo adapter
	Realtek RTL8821CE 802.11ac 1×1 Wi-Fi + Bluetooth 4.2 combo adapter
	Integrated WLAN options with dual antennas (M.2/PCIe)

Category	Description
	Supports models without WLAN
	Compatible with Miracast-certified devices
	Bluetooth Disabled IOPT
	Supports Wireless/LAN/WAN switching
	Supports HP Connection Optimizer with WiFi Load balancing
	Near-Field Communication (NFC)
	NFC Mirage WNC XRAV-1 (NXP NPC300 I2C, 10 mm × 17 mm)
	NFC antenna
	Supports models without NFC
	Wireless Wide Area Network (WWAN)
	SIM Module (3FF/micro SIM)
	Supports the following WWAN formats via connector:
	<ul style="list-style-type: none"> Integrated WWAN options with dual antennas (M.2 30×42 socket USB2) LTE CAT4: Huawei HP Lt4132, LTE/HSPA+ w/GPS M.2 Integrated WWAN options with dual antennas (M.2 30×42 socket PCIe) LTE CAT9: Fibocom Intel XMM 7360 LTE - Advanced
	WWAN Antennas (2) (world wide 5 band, configured at top of panel on all units)
	Supports models without WWAN
	Supports WWAN after market option
	WWAN cards are compatible with a programmable removable eSIM
External media cards	Micro SD Media Reader slot supports SD, SDHC, and SDXC.
Ports	VGA (Dsub 15 pin) supporting 1920×1200 external resolution @ 60 Hz and hot plug/unplug and auto detect
	USB Type-C (PD+DP, Gen 1)
	USB 3.0 charging port
	HDMI 1.4
	RJ-45/Ethernet
	Docking connector
	Audio-out (headphone)/audio-in (microphone) combo jack
	AC port, 4.5 mm
Docking	HP Docking Station
	HP Thunderbolt Dock 120W G2
Keyboard/pointing devices	HP Advanced Keyboard:
	HP Dura Keys, dual point, backlit, spill resistant with drain
	HP Dura Keys, TouchPad, backlit, spill resistant with drain

Category	Description
	Non-backlit, TouchPad, spill-resistant with drain
	TouchPad:
	Support PTP with Miniport driver
	Settings enabled by default: 2-finger scrolling, 2-finger zoom (pinch), OSD (enabled/disabled), 3-finger tap (Cortana), 3-finger flip (app switch), 4-finger tap (Action Center)
	Gestures disabled by default: 3-finger flick, 2-finger rotate, momentum motion, 1-finger vertical scroll
	Taps enabled by default
	On/off control by driver
Power requirements	Battery:
	HP Long Life Lithium Prismatic/Polymer Battery, 3-cell, 48 WHr, 4.21 Ahr
	HP Fast Charge Technology, 90% in 90 minutes
	AC adapter:
	65 W “Smart” right angle, 4.5 mm
	65 W “Smart” right angle, 4.5 mm - EM
	65 W Straight USB Type C
	65 W Straight USB Type C
	45 W “Smart” right angle, 4.5 mm
	45 W “Smart” right angle, 4.5 mm - Argentina
	45 W “Smart” right angle, 4.5 mm, 2-prong (Japan only)
	Power cord:
	2 wire plug (C7), 1 m, conventional
	3 wire plug (C5), 1.8 m, conventional
	3 wire plug (C5), 1 m, conventional
	Duckhead power cord (C5) 1.0 m
	Duckhead power cord (C5) 1.8 m
	Duckhead power cord (C5)
Security	Security lock
	Fingerprint reader
	Supports Trusted Platform Module (TPM) 2.0 (Infineon, soldered down)
	Integrated Smart Card reader (active)
	Preboot authentication (password, smart card)
	Supports models without a Smart Card reader
	Hardware enforced firmware protection: HP Hardware Root of Trust + Sure Start Gen4; ANSSI Certified Hardware Root of Trust: Yes
Operating system	Preinstalled:





Category	Description
	Windows 10 Home 64
	Windows 10 Home 64 Single Language
	Windows 10 Home 64 Chinese Market CPPP
	Windows 10 Home 64 High End Chinese Market CPPP
	Windows 10 Home 64 Plus
	Windows 10 Home 64 Plus Single Language
	Windows 10 Professional 64
	Windows 10 Home 64 StF MSNA Standard
	Windows 10 Home 64 StF MSNA Plus
	Windows 10 Home 64 StF MSNA Strategic
	FreeDOS 2.0
	Restore Media:
	Windows 10 DRDVD
	Windows 10 DRUSB
	Windows 10 Pro 64 OSDVD
	Windows 10 Pro 64 OSUSB
	Certified:
	Microsoft WHQL
	Web-only support:
	Windows 10 Enterprise 64
	Windows 10 Enterprise 64 LTSB 1607
	Win 10 Pro 64 CBB 1703 OS
Serviceability	End user replaceable parts:
	AC adapter
	Battery
	Hard drive
	Solid-state drive
	Memory module



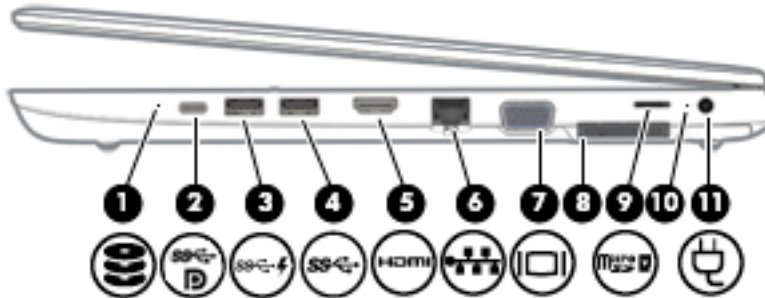

2 Components

Your computer features top-rated components. This chapter provides details about your components, where they're located, and how they work.

Right







Component	Description
(1) 	<p>Drive light</p> <ul style="list-style-type: none"> Blinking white: The hard drive is being accessed. Amber: HP 3D DriveGuard has temporarily parked the hard drive.
(2) 	<p>USB Type-C power connector port, SuperSpeed port, and DisplayPort</p> <p>Connects an AC adapter that has a USB Type-C connector, supplying power to the computer and, if needed, charging the computer battery.</p> <p>– and –</p> <p>Connects a USB device that has a Type-C connector, such as a cell phone, camera, activity tracker, or smartwatch, and provides high-speed data transfer.</p> <p>– and –</p> <p>Connects a display device that has a USB Type-C connector, providing DisplayPort output.</p> <p>NOTE: Cables and/or adapters (purchased separately) may be required.</p>
(3) 	<p>USB 3.x SuperSpeed port with HP Sleep and Charge</p> <p>Connects a USB device, provides high-speed data transfer, and even when the computer is off, charges most products such as a cell phone, camera, activity tracker, or smartwatch.</p>
(4) 	<p>USB 3.x SuperSpeed port</p> <p>Connects a USB device, such as a cell phone, camera, activity tracker, or smartwatch, and provides high-speed data transfer.</p>
(5) 	<p>HDMI port</p> <p>Connects an optional video or audio device, such as a high-definition television, any compatible digital or audio component, or a high-speed High Definition Multimedia Interface (HDMI) device.</p>

Component	Description
(6) 	<p>RJ-45 (network) jack/status lights</p> <p>Connects a network cable.</p> <ul style="list-style-type: none"> • Green (left): The network is connected. • Amber (right): Activity is occurring on the network.
(7) 	<p>External monitor port (select products only)</p> <p>Connects an external VGA monitor or projector. Select products may include an optional serial port.</p>
(8)	<p>Docking connector</p> <p>Connects an optional docking device.</p>
(9) 	<p>MicroSD memory card reader</p> <p>Reads optional memory cards that store, manage, share, or access information.</p> <p>To insert a card:</p> <ol style="list-style-type: none"> 1. Hold the card label-side up, with the connectors facing the computer. 2. Insert the card into the memory card reader, and then press in on the card until it is firmly seated. <p>To remove a card:</p> <ul style="list-style-type: none"> ▲ Press in on the card, and then remove it from the memory card reader.
(10)	<p>Battery light</p> <p>When AC power is connected:</p> <ul style="list-style-type: none"> • White: The battery charge is greater than 90 percent. • Amber: The battery charge is from 0 to 90 percent. • Off: The battery is not charging. <p>When AC power is disconnected (battery not charging):</p> <ul style="list-style-type: none"> • Blinking amber: The battery has reached a low battery level. When the battery has reached a critical battery level, the battery light begins blinking rapidly. • Off: The battery is not charging.
(11) 	<p>Power connector</p> <p>Connects an AC adapter.</p>

Left



Component	Description
(1)  Security cable slot	Attaches an optional security cable to the computer. NOTE: The security cable is designed to act as a deterrent, but it may not prevent the computer from being mishandled or stolen.
(2) Vent	Enables airflow to cool internal components. NOTE: The computer fan starts up automatically to cool internal components and prevent overheating. It is normal for the internal fan to cycle on and off during routine operation.
(3)  USB 3.x SuperSpeed port	Connects a USB device, such as a cell phone, camera, activity tracker, or smartwatch, and provides high-speed data transfer.
(4)  Audio-out (headphone)/Audio-in (microphone) combo jack (select products only)	Connects optional powered stereo speakers, headphones, earbuds, a headset, or a television audio cable. Also connects an optional headset microphone. This jack does not support optional standalone microphones. WARNING! To reduce the risk of personal injury, adjust the volume before putting on headphones, earbuds, or a headset. For additional safety information, refer to the <i>Regulatory, Safety, and Environmental Notices</i> . To access this guide: <ul style="list-style-type: none"> ▲ Select the Start button, select HP Help and Support, and then select HP Documentation. – or – ▲ Select the Start button, select HP, and then select HP Documentation. NOTE: When a device is connected to the jack, the computer speakers are disabled.
(5)  Smart card reader	Supports optional smart cards.

Display

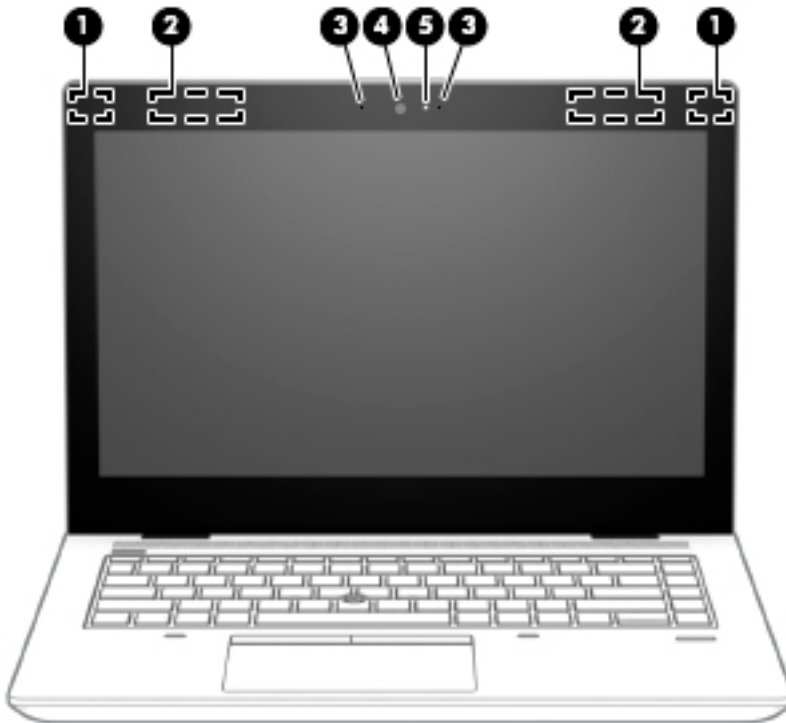

Component	Description
(1) WLAN antennas*	Send and receive wireless signals to communicate with wireless local area networks (WLANs).
(2) WWAN antennas*	Send and receive wireless signals to communicate with wireless wide area networks (WWANs).
(3) Internal microphones	Record sound.
(4) Camera	Allows you to video chat, record video, and record still images. Some cameras also allow a facial recognition logon to Windows, instead of a password logon. NOTE: Camera functions vary depending on the camera hardware and software installed on your product.
(5) Camera light(s)	On: One or more cameras are in use.

*The antennas are not visible from the outside of the computer. For optimal transmission, keep the areas immediately around the antennas free from obstructions.

For wireless regulatory notices, see the section of the *Regulatory, Safety, and Environmental Notices* that applies to your country or region.

To access this guide:

▲ Select the **Start** button, select **HP Help and Support**, and then select **HP Documentation**.

– or –

▲ Select the **Start** button, select **HP**, and then select **HP Documentation**.

Keyboard area

TouchPad

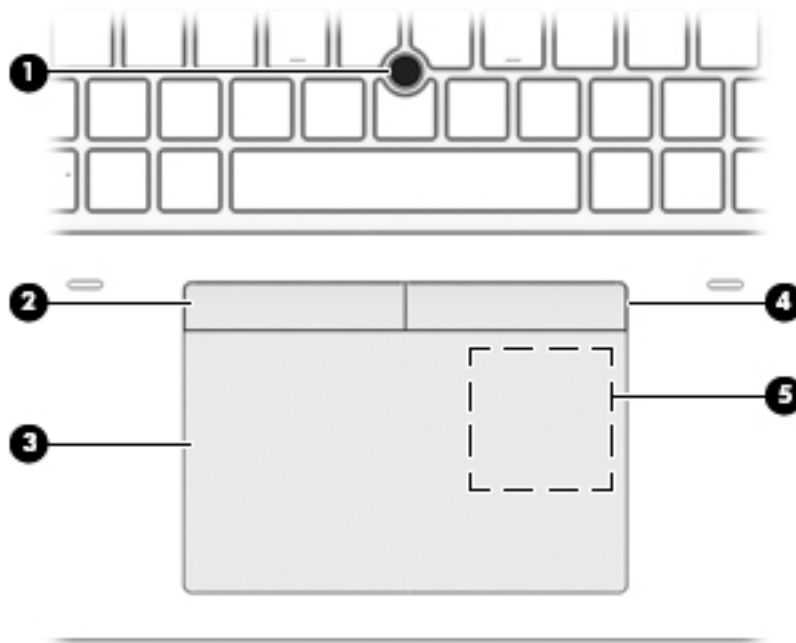

Component		Description
(1)	Pointing stick (select products only)	Moves the pointer on the screen.
(2)	Left pointing stick button (select products only)	Functions like the left button on an external mouse.
(3)	TouchPad zone	Reads your finger gestures to move the pointer or activate items on the screen.
(4)	Right pointing stick button (select products only)	Functions like the right button on an external mouse.
(5)	Near Field Communications (NFC) tapping area and antenna*	Allows you to wirelessly share information when you tap it with an NFC-enabled device.

*The antenna is not visible from the outside of the computer. For optimal transmission, keep the area immediately around the antenna free from obstructions.

For wireless regulatory notices, see the section of the *Regulatory, Safety, and Environmental Notices* that applies to your country or region.

To access this guide:





▲ Select the **Start** button, select **HP Help and Support**, and then select **HP Documentation**.

– or –

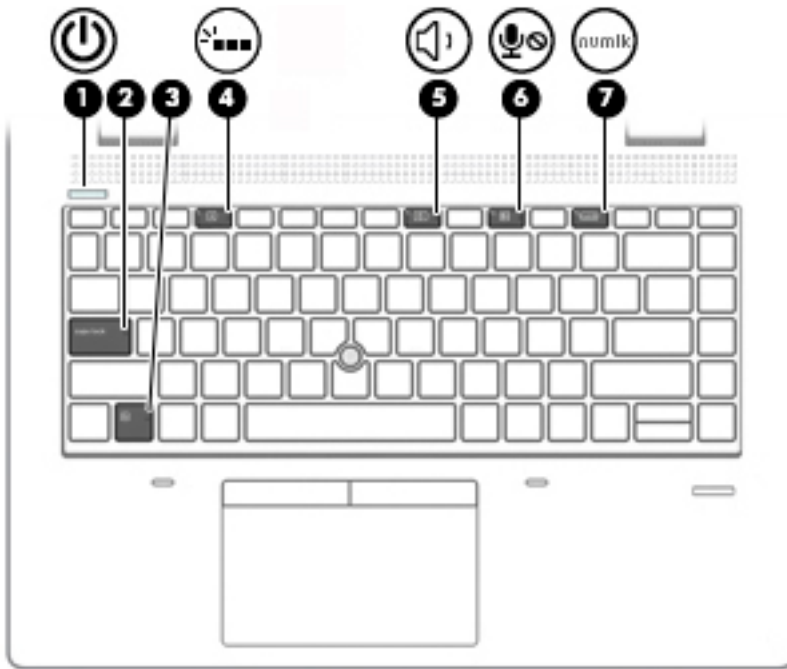
▲ Select the **Start** button, select **HP**, and then select **HP Documentation**.



Lights

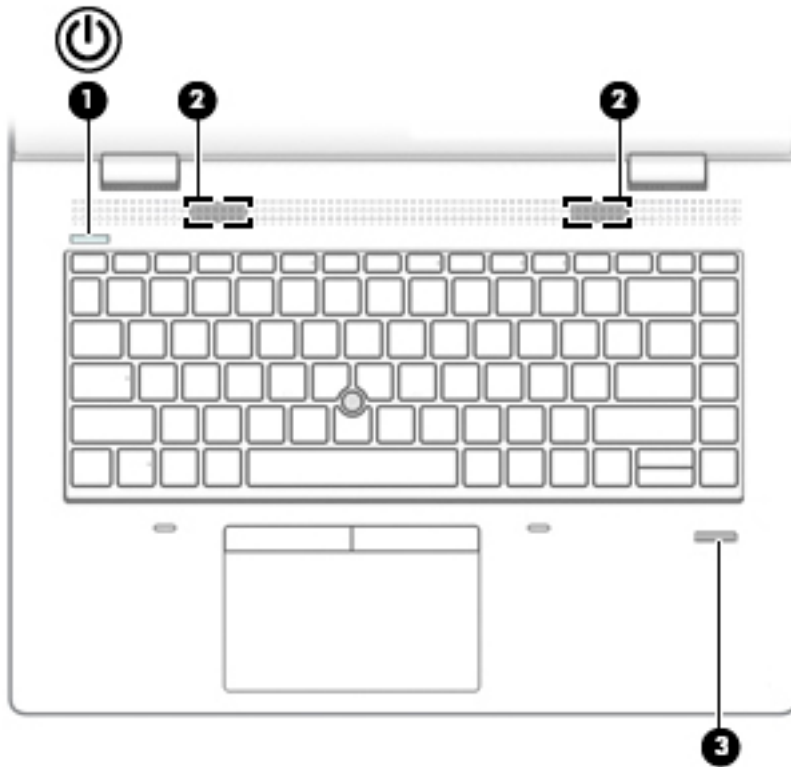

Component	Description
(1) 	<p>Power light</p> <ul style="list-style-type: none"> On: The computer is on. Blinking: The computer is in the Sleep state, a power-saving state. The computer shuts off power to the display and other unneeded components. Off: The computer is off or in Hibernation. Hibernation is a power-saving state that uses the least amount of power.
(2)	<p>Caps lock light</p> <p>On: Caps lock is on, which switches the key input to all capital letters.</p>
(3)	<p>Fn lock light</p> <p>On: The fn key is locked. For more information, see Hot keys (select products only) on page 15.</p>
(4) 	<p>Keyboard backlight</p> <p>Illuminates the keyboard for higher visibility in low-light conditions.</p>
(5) 	<p>Mute light</p> <ul style="list-style-type: none"> On: Computer sound is off. Off: Computer sound is on.
(6) 	<p>Microphone mute light</p> <ul style="list-style-type: none"> On: Microphone is off. Off: Microphone is on.
(7)	<p>Num lk light</p> <p>On: Num lock is on.</p>

Buttons, speakers, and fingerprint reader



Component	Description
(1)  Power button	<ul style="list-style-type: none"> • When the computer is off, press the button to turn on the computer. • When the computer is on, press the button briefly to initiate Sleep. • When the computer is in the Sleep state, press the button briefly to exit Sleep. • When the computer is in Hibernation, press the button briefly to exit Hibernation. <p>CAUTION: Pressing and holding down the power button results in the loss of unsaved information.</p> <p>If the computer has stopped responding and shutdown procedures are ineffective, press and hold the power button for at least 5 seconds to turn off the computer.</p> <p>To learn more about your power settings, see your power options.</p> <p>▲ Right-click the Power meter icon  and then select Power Options.</p>
(2) Speakers	Produce sound.
(3) Fingerprint reader (select products only)	Allows a fingerprint logon to Windows, instead of a password logon.

Special keys

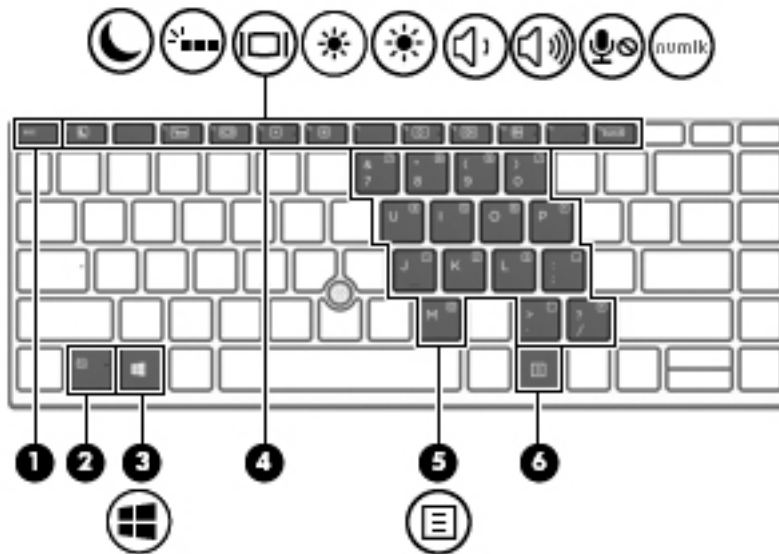





















Component	Description
(1) esc key	Displays system information when pressed in combination with the fn key.
(2) fn key	Executes frequently used system functions when pressed in combination with another key. Such key combinations are called <i>hot keys</i> . See Hot keys (select products only) on page 15 .
(3)  Windows key	Opens the Start menu. NOTE: Pressing the Windows key again will close the Start menu.
(4) Action keys	Execute frequently used system functions. See Action keys on page 14 .
(5) Embedded numeric keypad	A numeric keypad superimposed over the keyboard alphabet keys. When fn+num lk is pressed, the keypad can be used like an external numeric keypad. Each key on the keypad performs the function indicated by the icon in the upper-right corner of the key. NOTE: If the keypad function is active when the computer is turned off, that function is reinstated when the computer is turned back on.
(6) num lk key	Turns the embedded numeric keypad on and off when pressed in combination with the fn key. – or – Turns the embedded numeric keypad on and off.

Action keys

An action key performs the function indicated by the icon on the key. To determine which keys are on your product, see [Special keys on page 13](#).

- ▲ To use an action key, press and hold the key.

Icon	Description
	Helps prevent side-angle viewing from onlookers. If needed, decrease or increase brightness for well-lit or darker environments. Press the key again to turn off the privacy screen. NOTE: To quickly turn on the highest privacy setting, press fn+p .
	
	Decreases the screen brightness incrementally as long as you hold down the key.
	Increases the screen brightness incrementally as long as you hold down the key.
	Turns the keyboard backlight off or on. NOTE: To conserve battery power, turn off this feature.
	Plays the previous track of an audio CD or the previous section of a DVD or a Blu-ray Disc (BD).
	Starts, pauses, or resumes playback of an audio CD, a DVD, or a BD.
	Plays the next track of an audio CD or the next section of a DVD or a BD.
	Stops audio or video playback of a CD, a DVD, or a BD.
	Decreases speaker volume incrementally while you hold down the key.
	Increases speaker volume incrementally while you hold down the key.
	Mutes the microphone.
	Mutes or restores speaker sound.
	Turns the wireless feature on or off. NOTE: A wireless network must be set up before a wireless connection is possible.

Icon	Description
	Turns the TouchPad and TouchPad light on and off.
	Switches the screen image among display devices connected to the system. For example, if a monitor is connected to the computer, repeatedly pressing the key alternates the screen image from computer display to monitor display to simultaneous display on both the computer and monitor.
	Initiates Sleep, which saves your information in system memory. The display and other system components turn off and power is conserved. To exit Sleep, briefly press the power button. CAUTION: To reduce the risk of information loss, save your work before initiating Sleep.
	Provides quick access to your Skype for Business calendar. NOTE: This feature requires Skype® for Business or Lync® 2013 running on Microsoft Exchange or Office 365® servers.
	Turns the screen sharing function on or off. NOTE: This feature requires Skype for Business or Lync 2013 running on Microsoft Exchange or Office 365 servers.
	<ul style="list-style-type: none"> • Answers a call. • Starts a call during a 1-on-1 chat. • Places a call on hold. NOTE: This feature requires Skype for Business or Lync 2013 running on Microsoft Exchange or Office 365 servers.
	<ul style="list-style-type: none"> • Ends a call. • Declines incoming calls. • Ends screen sharing. NOTE: This feature requires Skype for Business or Lync 2013 running on Microsoft Exchange or Office 365 servers.

 **NOTE:** The action key feature is enabled at the factory. You can disable this feature by pressing and holding the **fn** key and the left **shift** key. The **fn** lock light will turn on. After you have disabled the action key feature, you can still perform each function by pressing the **fn** key in combination with the appropriate action key.

Hot keys (select products only)

A hot key is the combination of the **fn** key and another key.

To use a hot key:

- ▲ Press the **fn** key, and then press one of the keys listed in the following table.

Key	Description
C	Turns on scroll lock.
E	Turns on the insert function.
R	Breaks the operation.
S	Sends a programming query.
W	Pauses the operation.

Bottom

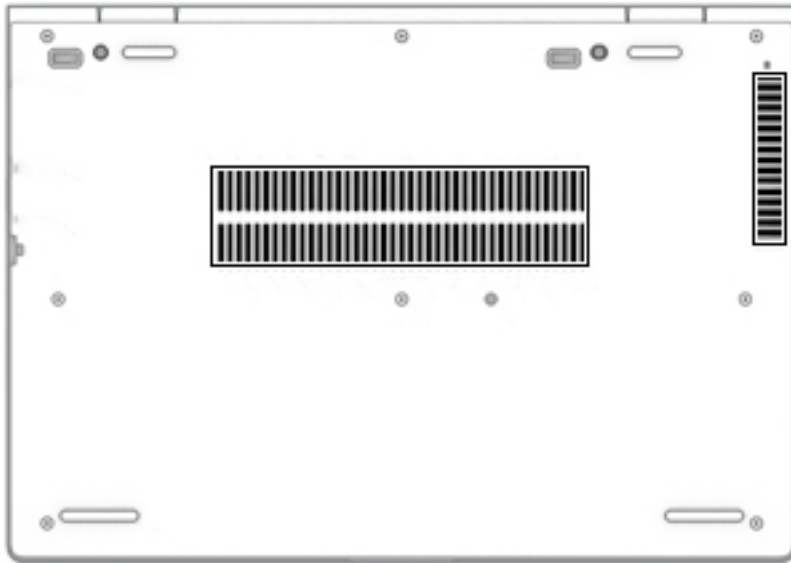

Component	Description
Vents	Enable airflow to cool internal components. NOTE: The computer fan starts up automatically to cool internal components and prevent overheating. It is normal for the internal fan to cycle on and off during routine operation.

Labels

The labels affixed to the computer provide information you may need when you troubleshoot system problems or travel internationally with the computer. Labels may be in paper form or imprinted on the product.

 **IMPORTANT:** Check the following locations for the labels described in this section: the bottom of the computer, inside the battery bay, under the service door, on the back of the display, or on the bottom of a tablet kickstand.

- **Service label**—Provides important information to identify your computer. When contacting support, you may be asked for the serial number, the product number, or the model number. Locate this information before you contact support.

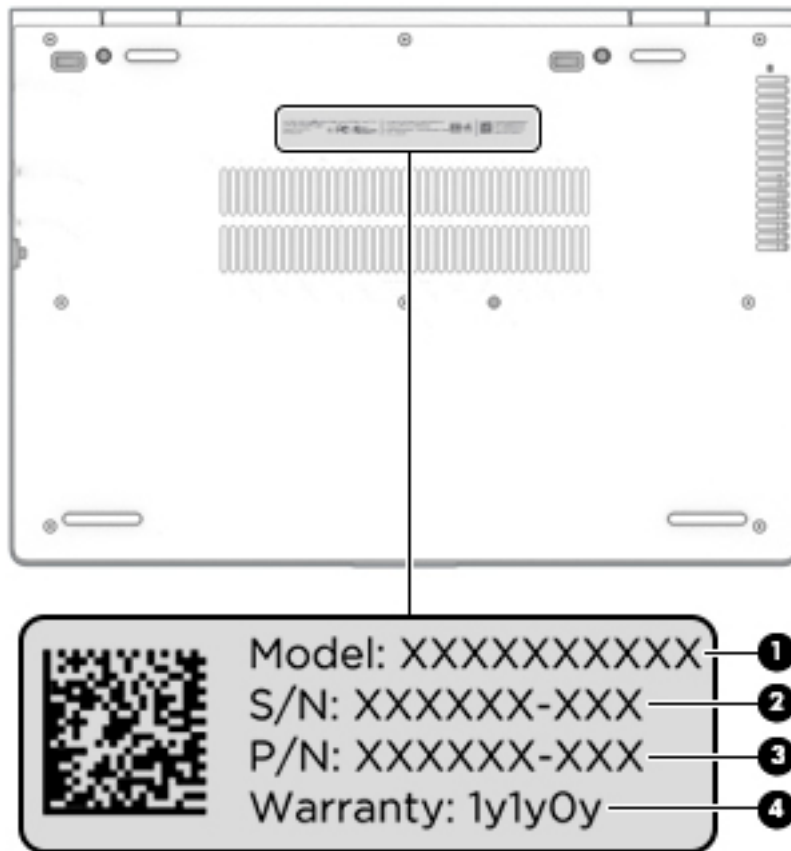

Component

(1) Model number

(2) Serial number

(3) Part number

(4) Warranty period

- **Regulatory label(s)**—Provide(s) regulatory information about the computer.
- **Wireless certification label(s)**—Provide(s) information about optional wireless devices and the approval markings for the countries or regions in which the devices have been approved for use.

3 Illustrated parts catalog

Computer major components

 **NOTE:** HP continually improves and changes product parts. For complete and current information on supported parts for your computer, go to <http://partsurfer.hp.com>, select your country or region, and then follow the on-screen instructions.

 **NOTE:** Details about your computer, including model, serial number, product key, and length of warranty, are on the service tag at the bottom of your computer. See [Labels on page 17](#) for details.

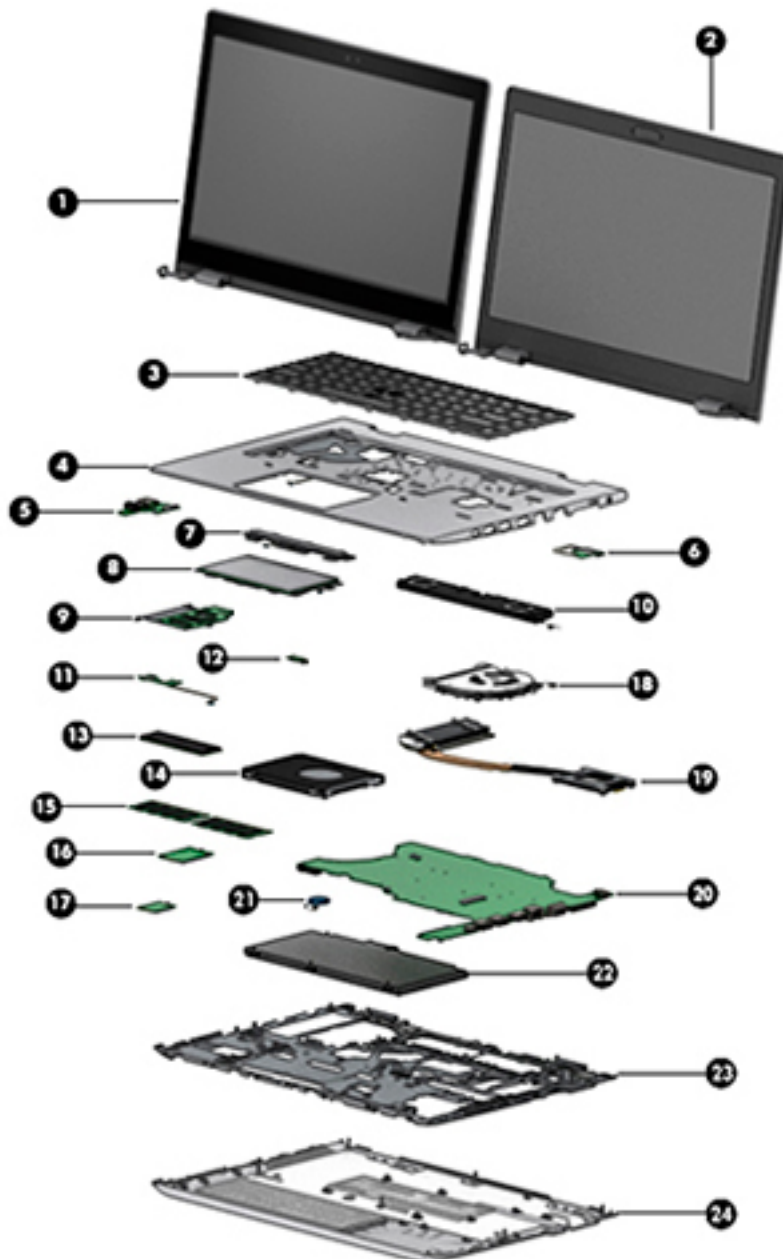

Item	Component	Spare part number
	Display	
	NOTE: Displays are not spared as whole units. Display subcomponent spare parts are available.	
	For spare part information, see Display assembly subcomponents on page 22 .	
(1)	Touch screen	Not spared
(2)	Non-touch	Not spared
(3)	Keyboard	
	NOTE: For a detailed list of country codes, see Keyboard on page 43 .	
	Backlit with pointing stick	L09548-xx1
	Backlit	L09546-xx1
	No backlight	L09547-xx1
(4)	Top cover	
	For use in models with a pointing stick	L09559-001
	For use in models without a pointing stick	L09560-001
(5)	USB board	L09553-001
(6)	Power button board (includes cable)	L09552-001
(7)	TouchPad button board	L09541-001
(8)	TouchPad	L09561-001
(9)	Smart card reader board	L09550-001
(10)	Speaker (includes cable)	L09558-001
(11)	Fingerprint reader board (includes cable)	L09538-001
(12)	NFC module	L09554-001
(13)	Solid-state drive	
	NOTE: For spare part information, see Mass storage devices on page 24 .	
(14)	Hard drive	
	NOTE: For spare part information, see Mass storage devices on page 24 .	
(15)	Memory modules (2400 MHz DDR4)	
	16 GB	865396-850
	8 GB	862398-850
	4 GB	862397-850
(16)	WWAN module	
	LTE CAT4: Huawei HP Lt4132, LTE/HSPA+ with GPS	845710-003
	LTE CAT9: Fibocom Intel XMM 7360 LTE - Advanced	917823-001
(17)	WLAN module	
	Intel Dual Band Wireless-AC 3168 802.11ac 1x1 WiFi + BT4.2 Combo Adapter (non-vPro)	852511-001

Item	Component	Spare part number
	Intel Dual Band Wireless-AC 8265 802.11ac 2x2 Wi-Fi + Bluetooth 4.2 Combo Adapter (non-vPro)	851594-001
	Realtek RTL8822BE 802.11ac 2x2 Wi-Fi + Bluetooth 4.2 Combo Adapter	915623-001
	Realtek RTL8821CE 802.11ac 1x1 Wi-Fi + Bluetooth 4.2 Combo Adapter	915621-001
(18)	Fan	L09535-001
(19)	Heat sink	L09537-001
(20)	System board	
	NOTE: All system board spare part kits include replacement thermal material.	
	All system boards use the following part numbers:	
	xxxxxx-001: Non-Windows operating systems	
	xxxxxx-601: Windows operating system	
	AMD Ryzen 7 PRO 2700U	L12802-xx1
	AMD Ryzen 5 PRO 2500U	L12801-xx1
	AMD Ryzen 3 PRO 2300U	L12800-xx1
(21)	RTC battery (includes cable)	857798-001
(22)	Battery (3-cell, 48 WHr, 4.212 Ahr)	931719-850
(23)	Internal frame	L09540-001
(24)	Bottom cover	L23633-001

Cable Kit

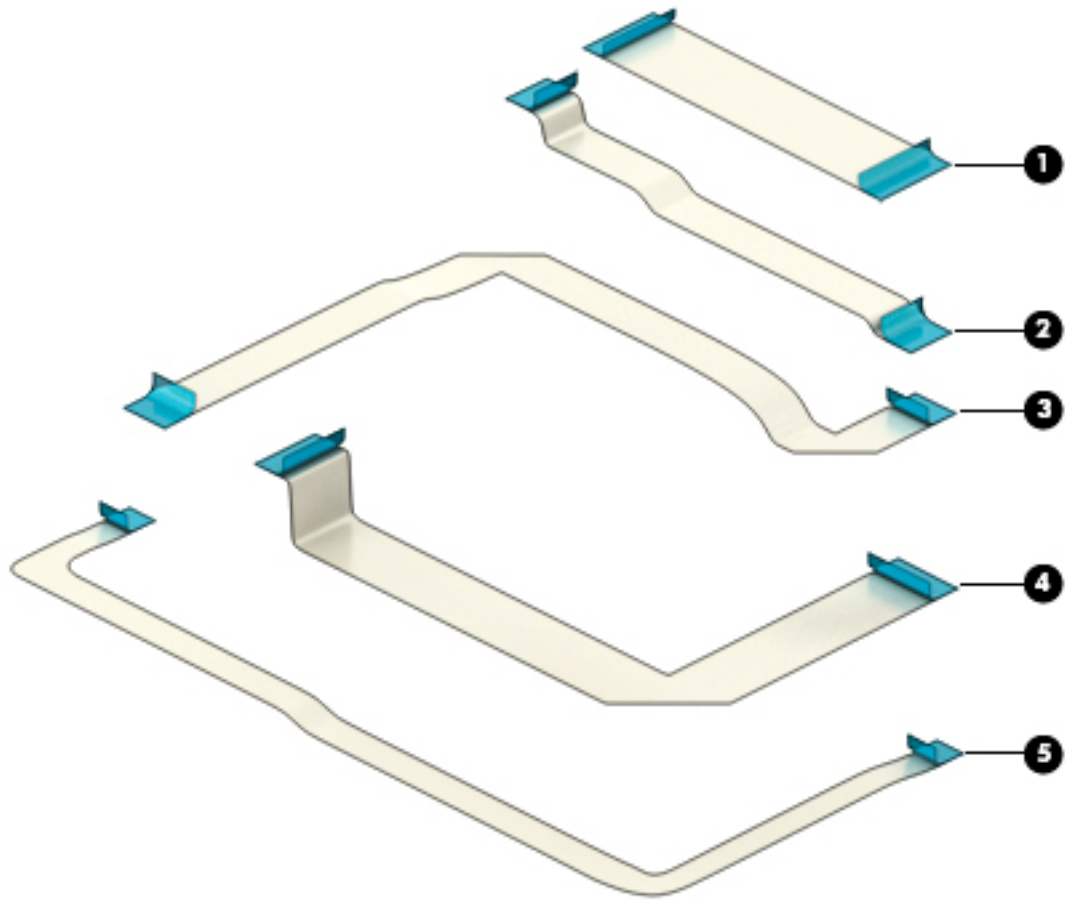

Item	Component	Spare part number
	Cable Kit	L09534-001
(1)	Pointing stick cable	
(2)	NFC module cable	
(3)	Smart card board cable	
(4)	TouchPad button board cable	
(5)	USB board cable	

Display assembly subcomponents

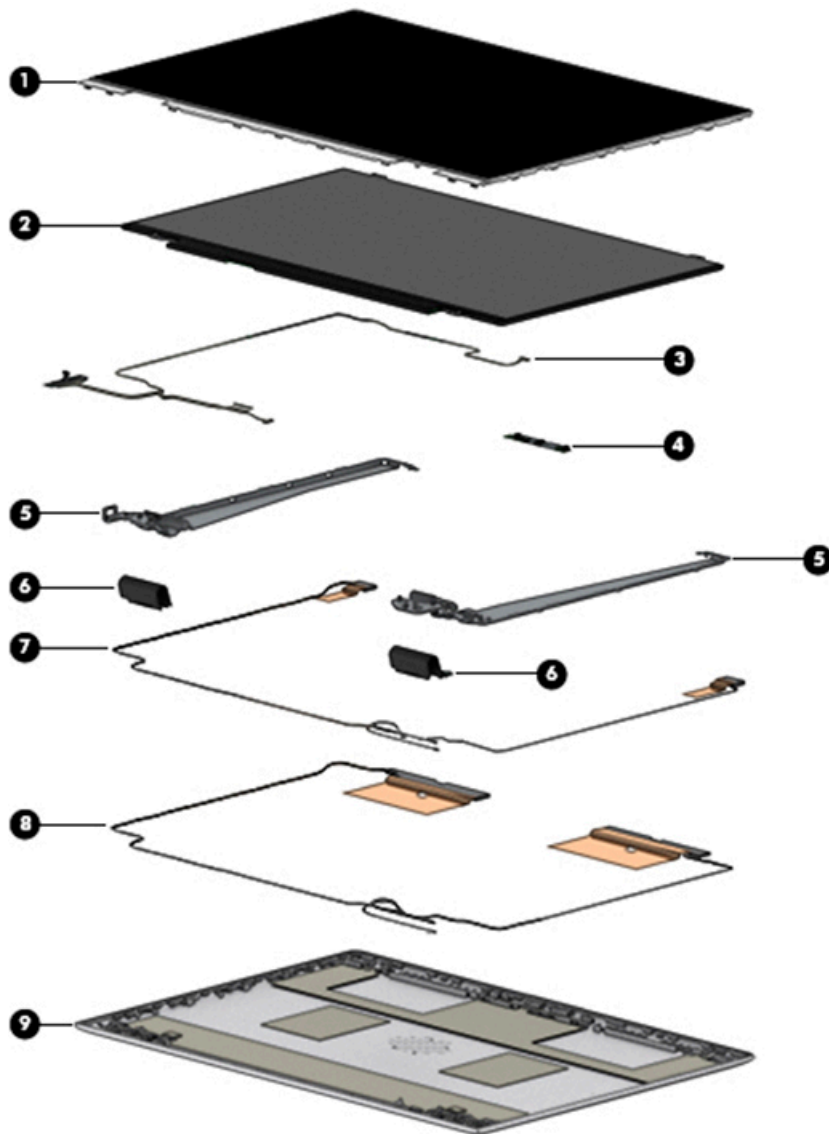

Item	Component	Spare part number
(1)	Display bezel	
	For use with non-touch displays with a camera module	L09530-001
	For use with non-touch displays with a microphone module	L09531-001
	For use in touch screen models	L19830-001
	Camera shutter (for use in non-touch models; not illustrated)	L09542-001
(2)	Display panel	
	Non-touch, FHD	L12814-001
	Non-touch, HD	L12813-001
	Touch	L18411-001

Item	Component	Spare part number
(3)	Display cable	
	For use in non-touch models	L09533-001
	For use in touch models	L19834-001
(4)	Camera module	L23432-001
	Microphone module (not illustrated)	L09551-001
(5)	Hinge Kit (includes left and right hinges)	
	For use in non-touch models	L09544-001
	For use in touch models	L23433-001
(6)	Hinge covers (right and left)	L09545-001
(7)	WLAN antenna cable (included in Antenna Kit)	L09523-001
(8)	WWAN antenna cable (included in Antenna Kit)	L09523-001
(9)	Back cover	
	For use in non-touch models	L09526-001
	For use in touch models	L19831-001

Plastics

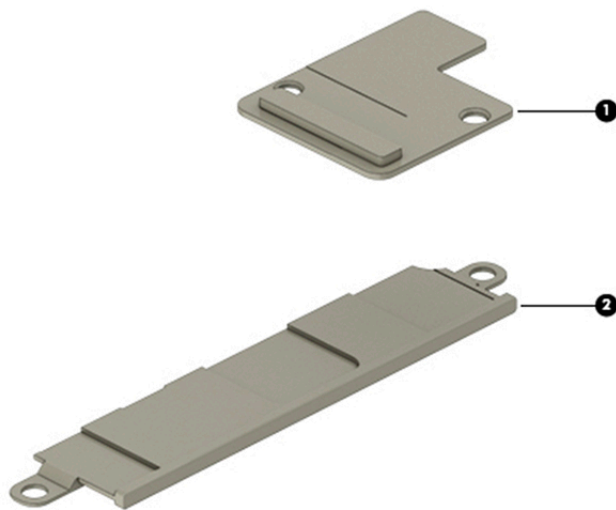

Item	Component	Spare part number
	Plastics Kit	
(1)	Smart card reader insert	L09555-001
(2)	Fingerprint reader insert (for use in models without a fingerprint reader)	L09556-001

Mass storage devices

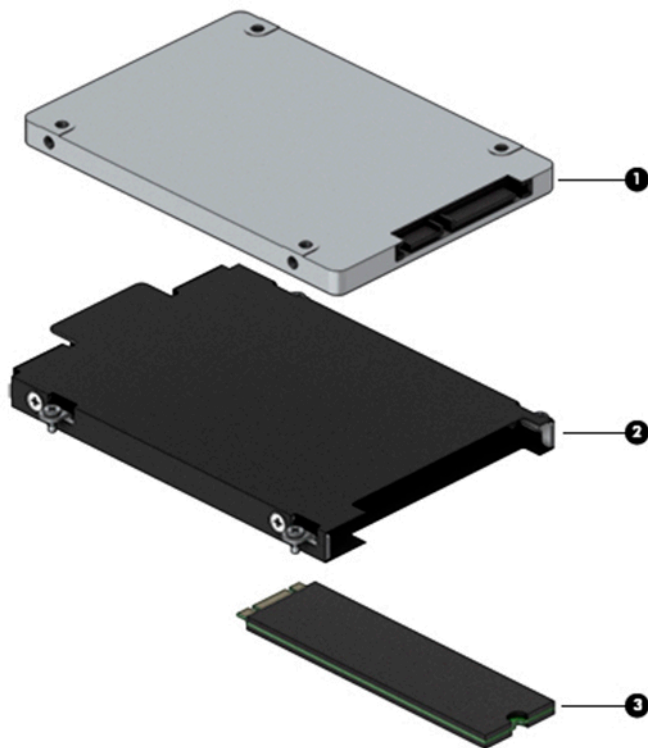

Item	Component	Spare part number
(1)	Hard drive	
	1 TB, 7200 rpm	L06427-850
	500 GB, 7200 rpm	703267-001
	500 GB, 7200 rpm, FIPS 140-2	820572-001
(2)	Hard drive cover (included in Bracket Kit)	L09539-001
(3)	Solid-state drive (M.2)	
	1 TB, PCIe, NVMe, TLC	L12805-001
	512 GB, SATA-3, FIPS 140-2	L12810-001
	512 GB, PCIe, NVMe, TLC	L12811-001
	360 GB, PCIe, NVMe, TLC	L12809-001
	256 GB, PCIe, NVMe, TLC, self-encrypting drive (SED), Opal 2	L12806-001
	256 GB, PCIe, NVMe, TLC	L12807-001
	256 GB, PCIe, NVMe, value	L12808-001
	256 GB, SATA-3, self-encrypting drive (SED), Opal 2	L12803-001
	128 GB, SATA-3, TLC	L12804-001

Miscellaneous parts

Component	Spare part number
AC adapter	
65 W AC adapter, nPFC, S-3P, 4.5 mm	710412-001
65 W AC adapter, nPFC, SMART, RC, 4.5 mm, EM	913691-850
45 W AC adapter, nPFC, SMART, RC, 4.5 mm, non-slim	741727-001
45 W AC adapter, nPFC, SMART, RC, 4.5 mm, 2P	742436-001
Power cord, C5, conventional, 1.0 m	
For use in Argentina	931249-001
For use in Australia	923430-001
For use in Brazil	923430-002
For use in Denmark	923430-003
For use in Europe	923430-004
For use in India	923430-006
For use in Israel	923430-005
For use in Italy	923430-007
For use in Japan	931252-001
For use in North America	923430-008
For use in the People's Republic of China	931251-001
For use in South Africa	923430-009
For use in South Korea	931250-001
For use in Switzerland	923430-010
For use in Thailand	923430-011
For use in Taiwan	923430-012
For use in the United Kingdom	923430-013
Power cord, C5, conventional, 1.8 m	
For use in Argentina	931257-001
For use in Australia	931265-001
For use in Brazil	931258-001
For use in Denmark	931261-001
For use in Europe	931259-001
For use in India	931270-001
For use in Israel	931262-001
For use in Italy	931256-001
For use in Japan	931271-001

Component	Spare part number
For use in North America	931255-001
For use in the People's Republic of China	931268-001
For use in South Africa	931264-001
For use in South Korea	931267-001
For use in Switzerland	931263-001
For use in Thailand	931266-001
For use in Taiwan	931269-001
For use in the United Kingdom	931260-001
Power cord, C7, conventional, 1.0 m	
For use in Japan	931325-001
Plastics	
Smart card reader insert	L09555-001
Fingerprint reader insert (for use in models without a fingerprint reader)	L09556-001
Bracket Kit (includes fingerprint reader bracket, hard drive cover, and smart card bracket)	L09539-001
Pointing stick covers (20 pieces)	L15396-001
Screw Kit	L09557-001

4 Removal and replacement procedures preliminary requirements

Tools required

You will need the following tools to complete the removal and replacement procedures:

- Phillips P1 magnetic screwdriver
- Plastic, non-marking pry tool

Service considerations

The following sections include some of the considerations that you must keep in mind during disassembly and assembly procedures.

 **NOTE:** As you remove each subassembly from the computer, place the subassembly (and all accompanying screws) away from the work area to prevent damage.

Plastic parts

 **CAUTION:** Using excessive force during disassembly and reassembly can damage plastic parts. Use care when handling the plastic

Cables and connectors

⚠ CAUTION: When servicing the computer, be sure that cables are placed in their proper locations during the reassembly process. Improper cable placement can damage the computer.

Cables must be handled with extreme care to avoid damage. Apply only the tension required to unseat or seat the cables during removal and insertion. Handle cables by the connector whenever possible. In all cases, avoid bending, twisting, or tearing cables. Be sure that cables are routed in such a way that they cannot be caught or snagged by parts being removed or replaced. Handle flex cables with extreme care; these cables tear easily.

Drive handling

⚠ CAUTION: Drives are fragile components that must be handled with care. To prevent damage to the computer, damage to a drive, or loss of information, observe these precautions:

Before removing or inserting a hard drive, shut down the computer. If you are unsure whether the computer is off or in Hibernation, turn the computer on, and then shut it down through the operating system.

Before handling a drive, be sure that you are discharged of static electricity. While handling a drive, avoid touching the connector.

Before removing an optical drive, be sure that a disc is not in the drive and be sure that the optical drive tray is closed.

Handle drives on surfaces covered with at least one inch of shock-proof foam.

Avoid dropping drives from any height onto any surface.

After removing a hard drive or an optical drive, place it in a static-proof bag.

Avoid exposing an internal hard drive to products that have magnetic fields, such as monitors or speakers.

Avoid exposing a drive to temperature extremes or liquids.

If a drive must be mailed, place the drive in a bubble pack mailer or other suitable form of protective packaging and label the package “FRAGILE.”

Grounding guidelines

Electrostatic discharge damage

Electronic components are sensitive to electrostatic discharge (ESD). Circuitry design and structure determine the degree of sensitivity. Networks built into many integrated circuits provide some protection, but in many cases, ESD contains enough power to alter device parameters or melt silicon junctions.

A discharge of static electricity from a finger or other conductor can destroy static-sensitive devices or microcircuitry. Even if the spark is neither felt nor heard, damage may have occurred.

An electronic device exposed to ESD may not be affected at all and can work perfectly throughout a normal cycle. Or the device may function normally for a while, then degrade in the internal layers, reducing its life expectancy.

CAUTION: To prevent damage to the computer when you are removing or installing internal components, observe these precautions:

Keep components in their electrostatic-safe containers until you are ready to install them.

Before touching an electronic component, discharge static electricity by using the guidelines described in this section.

Avoid touching pins, leads, and circuitry. Handle electronic components as little as possible.

If you remove a component, place it in an electrostatic-safe container.

The following table shows how humidity affects the electrostatic voltage levels generated by different activities.

CAUTION: A product can be degraded by as little as 700 V.

Typical electrostatic voltage levels			
Event	Relative humidity		
	10%	40%	55%
Walking across carpet	35,000 V	15,000 V	7,500 V
Walking across vinyl floor	12,000 V	5,000 V	3,000 V
Motions of bench worker	6,000 V	800 V	400 V
Removing DIPS from plastic tube	2,000 V	700 V	400 V
Removing DIPS from vinyl tray	11,500 V	4,000 V	2,000 V
Removing DIPS from plastic foam	14,500 V	5,000 V	3,500 V
Removing bubble pack from PCB	26,500 V	20,000 V	7,000 V
Packing PCBs in foam-lined box	21,000 V	11,000 V	5,000 V

Packaging and transporting guidelines

Follow these grounding guidelines when packaging and transporting equipment:

- To avoid hand contact, transport products in static-safe tubes, bags, or boxes.
- Protect ESD-sensitive parts and assemblies with conductive or approved containers or packaging.
- Keep ESD-sensitive parts in their containers until the parts arrive at static-free workstations.
- Place items on a grounded surface before removing items from their containers.
- Always be properly grounded when touching a component or assembly.
- Store reusable ESD-sensitive parts from assemblies in protective packaging or nonconductive foam.
- Use transporters and conveyors made of antistatic belts and roller bushings. Be sure that mechanized equipment used for moving materials is wired to ground and that proper materials are selected to avoid static charging. When grounding is not possible, use an ionizer to dissipate electric charges.

Workstation guidelines

Follow these grounding workstation guidelines:

- Cover the workstation with approved static-shielding material.
- Use a wrist strap connected to a properly grounded work surface and use properly grounded tools and equipment.
- Use conductive field service tools, such as cutters, screwdrivers, and vacuums.
- When fixtures must directly contact dissipative surfaces, use fixtures made only of static safe materials.
- Keep the work area free of nonconductive materials, such as ordinary plastic assembly aids and plastic foam.
- Handle ESD-sensitive components, parts, and assemblies by the case or PCM laminate. Handle these items only at static-free workstations.
- Avoid contact with pins, leads, or circuitry.
- Turn off power and input signals before inserting or removing connectors or test equipment.

Equipment guidelines

Grounding equipment must include either a wrist strap or a foot strap at a grounded workstation.

- When seated, wear a wrist strap connected to a grounded system. Wrist straps are flexible straps with a minimum of one megohm $\pm 10\%$ resistance in the ground cords. To provide proper ground, wear a strap snugly against the skin at all times. On grounded mats with banana-plug connectors, use alligator clips to connect a wrist strap.
- When standing, use foot straps and a grounded floor mat. Foot straps (heel, toe, or boot straps) can be used at standing workstations and are compatible with most types of shoes or boots. On conductive floors or dissipative floor mats, use foot straps on both feet with a minimum of one megohm resistance between the operator and ground. To be effective, the conductive equipment must be worn in contact with the skin.

The following grounding equipment is recommended to prevent electrostatic damage:

- Antistatic tape
- Antistatic smocks, aprons, and sleeve protectors
- Conductive bins and other assembly or soldering aids
- Nonconductive foam
- Conductive tabletop workstations with ground cords of one megohm resistance
- Static-dissipative tables or floor mats with hard ties to the ground
- Field service kits
- Static awareness labels
- Material-handling packages
- Nonconductive plastic bags, tubes, or boxes
- Metal tote boxes
- Electrostatic voltage levels and protective materials

The following table lists the shielding protection provided by antistatic bags and floor mats.

Material	Use	Voltage protection level
Antistatic plastics	Bags	1,500 V
Carbon-loaded plastic	Floor mats	7,500 V
Metallized laminate	Floor mats	5,000 V

5 Removal and replacement procedures for Customer Self-Repair parts

This chapter provides removal and replacement procedures for Customer Self-Repair parts.

 **NOTE:** The Customer Self-Repair program is not available in all locations. Installing a part not supported by the Customer Self-Repair program may void your warranty. Check your warranty to determine if Customer Self-Repair is supported in your location.

Component replacement procedures

 **NOTE:** Details about your computer, including model, serial number, product key, and length of warranty, are on the service tag at the bottom of your computer. See [Labels on page 17](#) for details.

 **NOTE:** HP continually improves and changes product parts. For complete and current information on supported parts for your computer, go to <http://partsurfer.hp.com>, select your country or region, and then follow the on-screen instructions.

There are as many as 24 screws that must be removed, replaced, and/or loosened when servicing Customer Self-Repair parts. Make special note of each screw size and location during removal and replacement.

Bottom cover

Description	Spare part number
Bottom cover	L23633-001

1. Turn off the computer. If you are unsure whether the computer is off or in Hibernation, turn the computer on, and then shut it down through the operating system.
2. Disconnect the power from the computer by unplugging the power cord from the computer.
3. Disconnect all external devices from the computer.

Remove the bottom cover:

1. Loosen the eight Phillips screws (1) that secure the cover to the computer.
2. Using a plastic tool, starting near a hinge under the display, pry the bottom cover up to remove it (2).

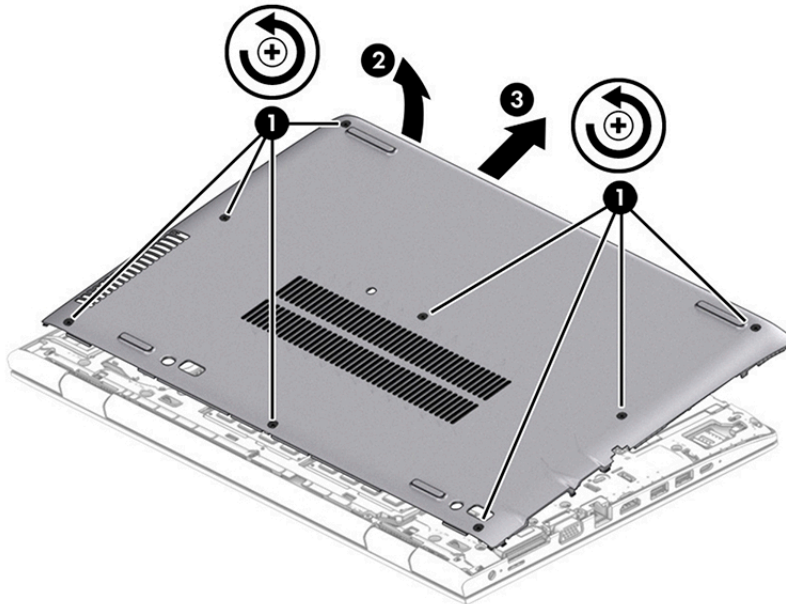

Battery

Description	Spare part number
Battery (3-cell, 48 WHr, 4.212 Ahr)	931719-850

Before removing the battery, follow these steps:

1. Shut down the computer.
2. Disconnect all external devices connected to the computer.
3. Disconnect the power from the computer by first unplugging the power cord from the AC outlet and then unplugging the AC adapter from the computer.
4. Remove the bottom cover (see [Bottom cover on page 33](#)).

Remove the battery:

1. Loosen the six captive screws **(1)** that secure the battery to the computer.
2. Lift the top of the battery, and then remove it from the computer **(2)**.

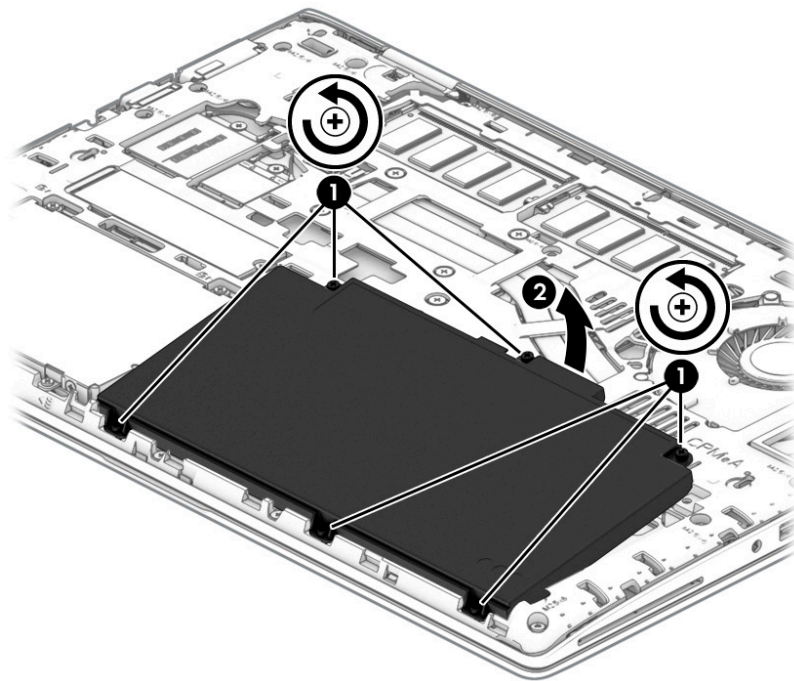

Reverse this procedure to install the battery.

Memory

Description	Spare part number
Memory module, 16 GB	865396-850
Memory module, 8 GB	862398-850
Memory module, 4 GB	862397-850

Before removing the memory module, follow these steps:

1. Shut down the computer.
2. Disconnect all external devices connected to the computer.
3. Disconnect the power from the computer by first unplugging the power cord from the AC outlet and then unplugging the AC adapter from the computer.
4. Remove the bottom cover (see [Bottom cover on page 33](#)).
5. Remove the battery (see [Battery on page 34](#)).

Remove the memory modules:

1. Spread the two retention clips outward **(1)** until the memory module tilts up at a 45-degree angle.
2. Grasp the edge of the memory module **(2)**, and then gently pull the module out of the slot. Use the same procedure to remove both memory modules.

CAUTION: To prevent damage to the memory module, hold the memory module by the edges only. Do not touch the components on the memory module.

To protect a memory module after removal, place it in an electrostatic-safe container.

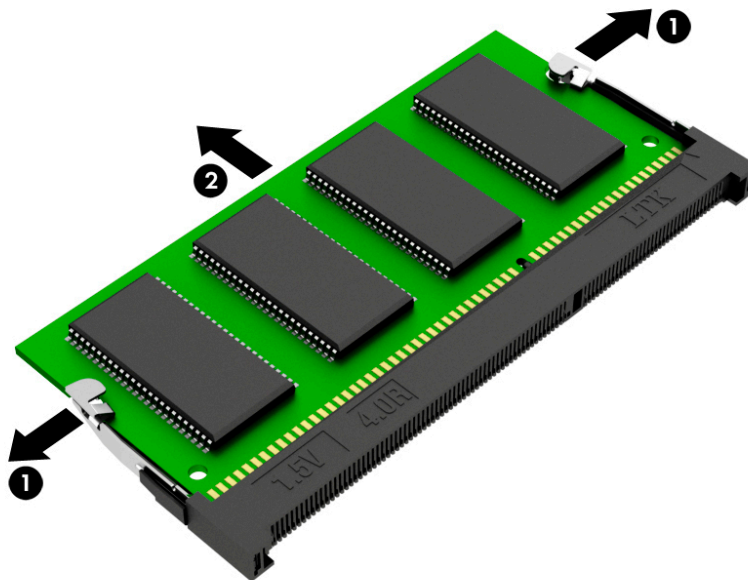

Install the memory modules:

 **IMPORTANT:** To prevent damage to the memory module, hold the memory module by the edges only. Do not touch the components on the memory module. Do not bend the memory module.

1. Align the notched edge of the memory module with the tab in the memory module slot **(1)**.
2. Press the module into the slot until seated **(2)**.
3. Gently press down on the module edges until the side retention clips snap into place **(3)**.

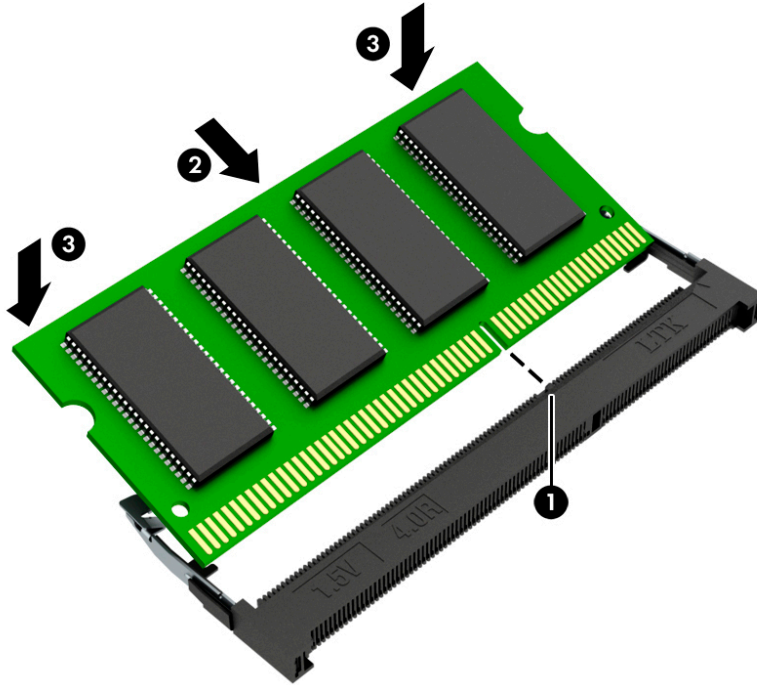

Hard drive

Description	Spare part number
Hard drive, 1 TB, 7200 rpm	L06427-850
Hard drive, 500 GB, 7200 rpm	703267-001
Hard drive, 500 GB, 7200 rpm, FIPS 140-2	820572-001
Hard drive cover (included in Bracket Kit)	L09539-001

Before removing the hard drive, follow these steps:

1. Shut down the computer.
2. Disconnect all external devices connected to the computer.
3. Disconnect the power from the computer by first unplugging the power cord from the AC outlet and then unplugging the AC adapter from the computer.
4. Remove the bottom cover (see [Bottom cover on page 33](#)).
5. Remove the battery (see [Battery on page 34](#)).

Remove the hard drive:

1. Loosen the four captive Phillips screws **(1)** that secure the drive assembly to the computer.
2. Pull the plastic tab to disconnect the hard drive from the connector and remove the drive from the computer **(2)**.

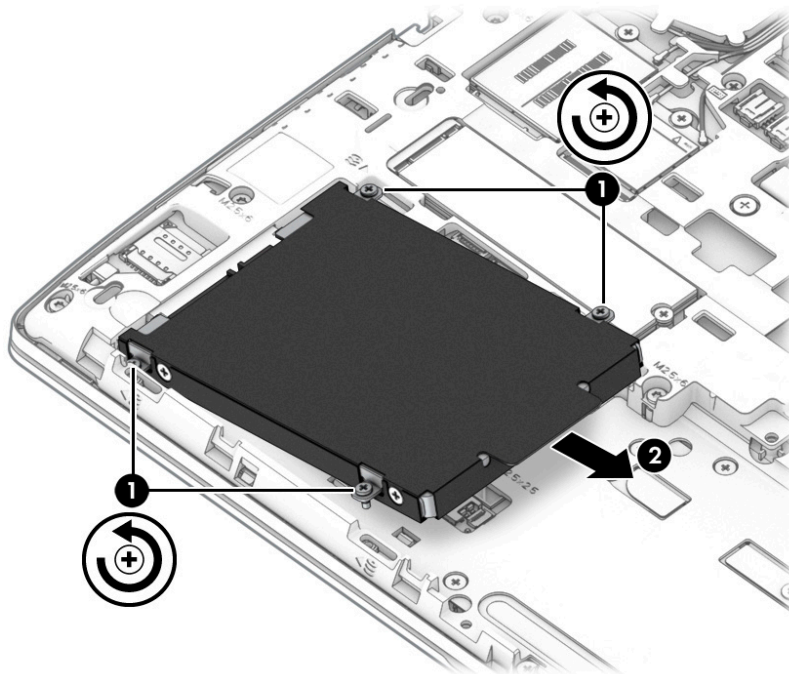

3. If it is necessary to disassemble the hard drive, remove the four Phillips M3.0×3.0 screws (1), and then slide the drive out of the drive cover (2).

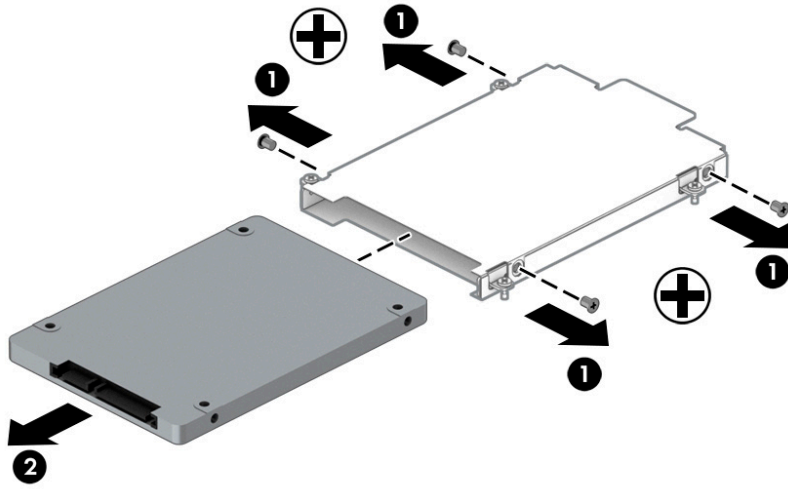

Reverse this procedure to reassemble and install the hard drive.

Solid-state drive

Description	Spare part number
Solid-state drive, 1 TB, PCIe, NVMe, TLC	L12805-001
Solid-state drive, 512 GB, SATA-3, FIPS 140-2	L12810-001
Solid-state drive, 512 GB, PCIe, NVMe, TLC	L12811-001
Solid-state drive, 360 GB, PCIe, NVMe, TLC	L12809-001
Solid-state drive, 256 GB, PCIe, NVMe, TLC, self-encrypting drive (SED), Opal 2	L12806-001
Solid-state drive, 256 GB, PCIe, NVMe, TLC	L12807-001
Solid-state drive, 256 GB, PCIe, NVMe, value	L12808-001
Solid-state drive, 256 GB, SATA-3, self-encrypting drive (SED), Opal 2	L12803-001
Solid-state drive, 128 GB, SATA-3, TLC	L12804-001

Before removing the solid-state drive, follow these steps:

1. Shut down the computer.
2. Disconnect all external devices connected to the computer.
3. Disconnect the power from the computer by first unplugging the power cord from the AC outlet and then unplugging the AC adapter from the computer.
4. Remove the bottom cover (see [Bottom cover on page 33](#)).
5. Remove the battery (see [Battery on page 34](#)).

Remove the solid-state drive:

- ▲ Remove the Phillips M2.0×3.0 screw **(1)**, and then pull the solid-state drive module from the socket **(2)**.

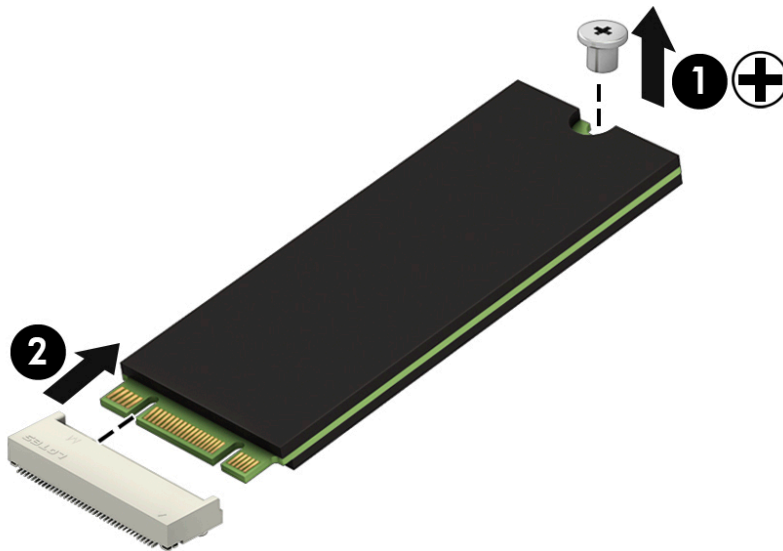

Reverse this procedure to install the solid-state drive.

6 Removal and replacement procedures for Authorized Service Provider parts

This chapter provides removal and replacement procedures for Authorized Service Provider only parts.

CAUTION: Components described in this chapter should only be accessed by an authorized service provider. Accessing these parts can damage the computer or void the warranty.

CAUTION: This computer does not have user-replaceable parts. Only HP authorized service providers should perform the removal and replacement procedures described here. Accessing the internal part could damage the computer or void the warranty.

Component replacement procedures

NOTE: Details about your computer, including model, serial number, product key, and length of warranty, are on the service tag at the bottom of your computer. See [Labels on page 17](#) for details.

NOTE: HP continually improves and changes product parts. For complete and current information on supported parts for your computer, go to <http://partsurfer.hp.com>, select your country or region, and then follow the on-screen instructions.

There are as many as 64 screws that must be removed, replaced, and/or loosened when servicing Authorized Service Provider only parts. Make special note of each screw size and location during removal and replacement.

WWAN module

Description	Spare part number
LTE CAT4: Huawei HP lt4132, LTE/HSPA+ with GPS	845710-003
LTE CAT9: Fibocom Intel XMM 7360 LTE - Advanced	917823-001

Before removing the WWAN module, follow these steps:

1. Shut down the computer.
2. Disconnect all external devices connected to the computer.
3. Disconnect the power from the computer by first unplugging the power cord from the AC outlet and then unplugging the AC adapter from the computer.
4. Remove the bottom cover (see [Bottom cover on page 33](#)).
5. Remove the battery (see [Battery on page 34](#)).

Remove the WWAN module:

1. Disconnect the two antenna cables from the module **(1)**.

2. Remove the Phillips M2.0×3.0 screw (2), and then pull the module out of the socket (3).

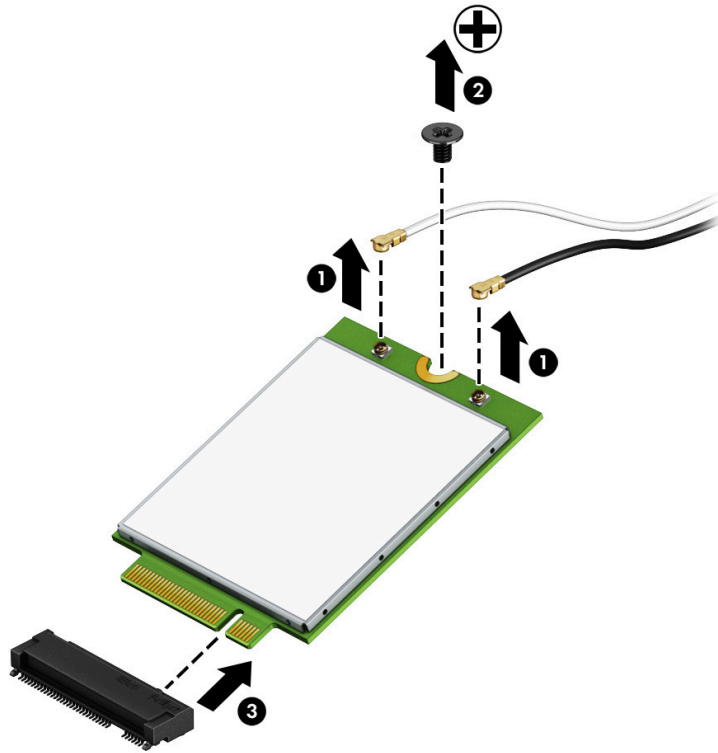

Reverse this procedure to install the WWAN module.

WLAN module

Description	Spare part number
Intel Dual Band Wireless-AC 3168 802.11ac 1x1 Wi-Fi + BT4.2 Combo Adapter (non-vPro)	852511-001
Intel Dual Band Wireless-AC 8265 802.11ac 2x2 Wi-Fi + Bluetooth 4.2 Combo Adapter (non-vPro)	851594-001
Realtek RTL8822BE 802.11ac 2x2 Wi-Fi + Bluetooth 4.2 Combo Adapter	915623-001
Realtek RTL8821CE 802.11ac 1x1 Wi-Fi + Bluetooth 4.2 Combo Adapter	915621-001

Before removing the WLAN, follow these steps:

1. Shut down the computer.
2. Disconnect all external devices connected to the computer.
3. Disconnect the power from the computer by first unplugging the power cord from the AC outlet and then unplugging the AC adapter from the computer.
4. Remove the bottom cover (see [Bottom cover on page 33](#)).
5. Remove the battery (see [Battery on page 34](#)).

Remove the WLAN module:

1. Disconnect the two antenna cables from the module **(1)**.
2. Remove the Phillips M2.0×3.0 screw **(2)**, and then pull the module out of the socket **(3)**.

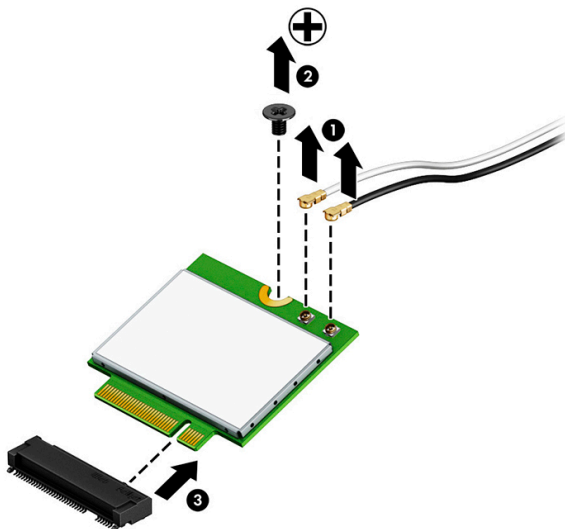

Reverse this procedure to install the WLAN module.

Keyboard

In this section, the first table provides the main spare part numbers for the keyboard. The second table provides the country codes.

Description	Spare part number
Keyboard, backlit with pointing stick	L09548-xx1
Keyboard, backlit	L09546-xx1
Keyboard, no backlight	L09547-xx1
Pointing stick cable (included in Cable Kit)	L09534-001

For use in country or region	Spare part number	For use in country or region	Spare part number	For use in country or region	Spare part number
Belgium	-A41	India	-D61	Saudi Arabia	-171
Brazil	-201	Israel	-BB1	Slovenia	-BA1
Bulgaria	-261	Italy	-061	South Korea	-AD1
Canada	-DB1	Japan	-291	Spain	-071
Czech Republic and Slovakia	-FL1	Latin America	-161	Sweden and Finland	-B71
Denmark	-081	The Netherlands	-B31	Switzerland	-BG1
France	-051	Northern Africa	-FP1	Taiwan	-AB1
Germany	-041	Norway	-091	Thailand	-281
Greece	-151	Portugal	-131	Turkey	-141
Hungary	-211	Romania	-271	United Kingdom	-031
Iceland	-DD1	Russia	-251	United States	-001

Before removing the keyboard, follow these steps:

1. Turn off the computer. If you are unsure whether the computer is off or in Hibernation, turn the computer on, and then shut it down through the operating system.
2. Disconnect the power from the computer by unplugging the power cord from the computer.
3. Disconnect all external devices from the computer.
4. Remove the bottom cover (see [Bottom cover on page 33](#)).
5. Remove the battery (see [Battery on page 34](#)).

Remove the keyboard:

1. Loosen the two captive Phillips screws that secure the keyboard to the computer.

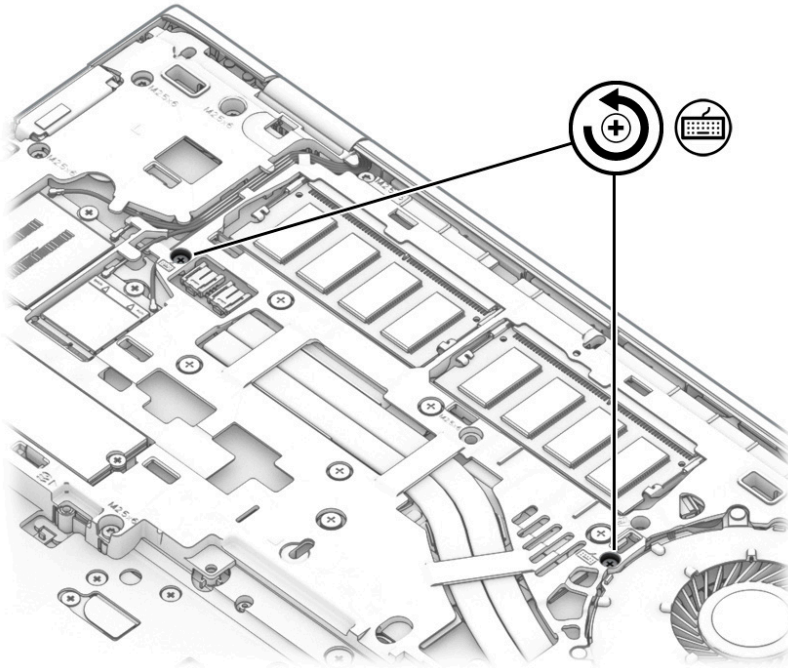

2. Position the computer on its side and open so you can access the bottom.
3. Insert a blunt tool into the keyboard release opening near the fan, and then press gently on the back of the keyboard until it disengages from the computer.

CAUTION: Press gently to avoid damaging the keyboard.

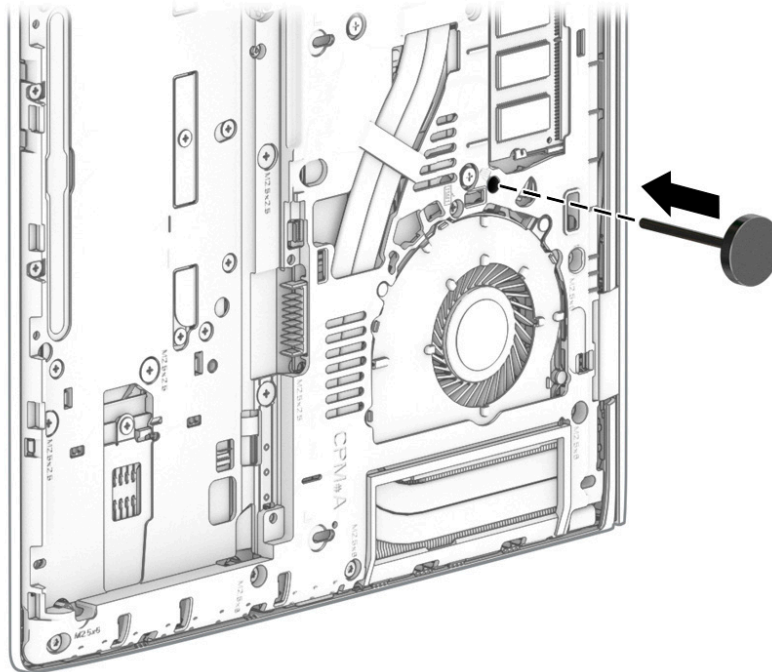

4. Position the computer upright and open the display as far as possible.

5. Press the keyboard downward slightly so you can disengage the top **(1)**, and then lift and rotate the keyboard up and over onto the palm rest **(2)**.

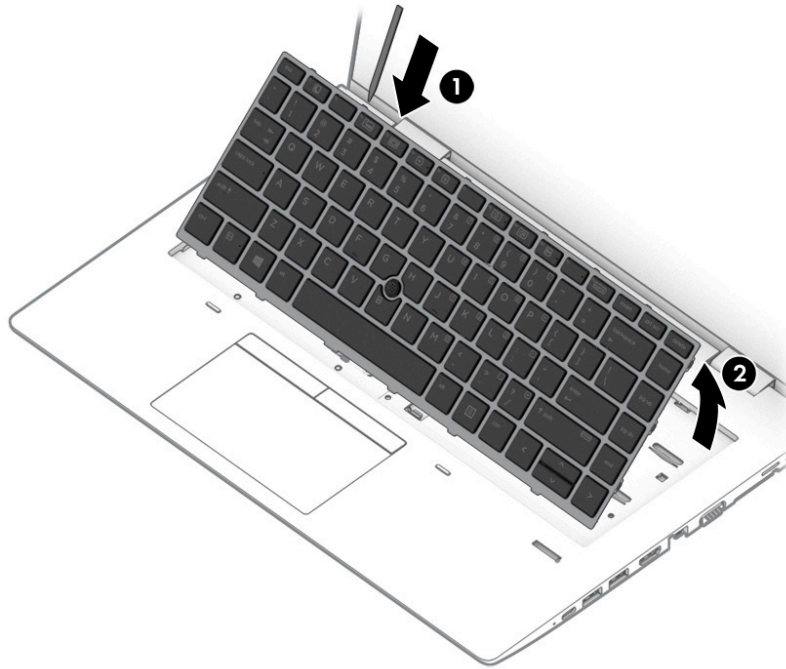

6. Release and disconnect the following connectors and cables located underneath the installed keyboard:
- Release the keyboard cable connector **(1)** and then remove the cable **(2)**.
 - Release the pointing stick cable connector **(3)**, and then remove the cable **(4)**.
 - For products with a backlit keyboard, release the backlight cable connector **(5)** and then remove the cable **(6)**.

7. Remove the keyboard from the computer (7).

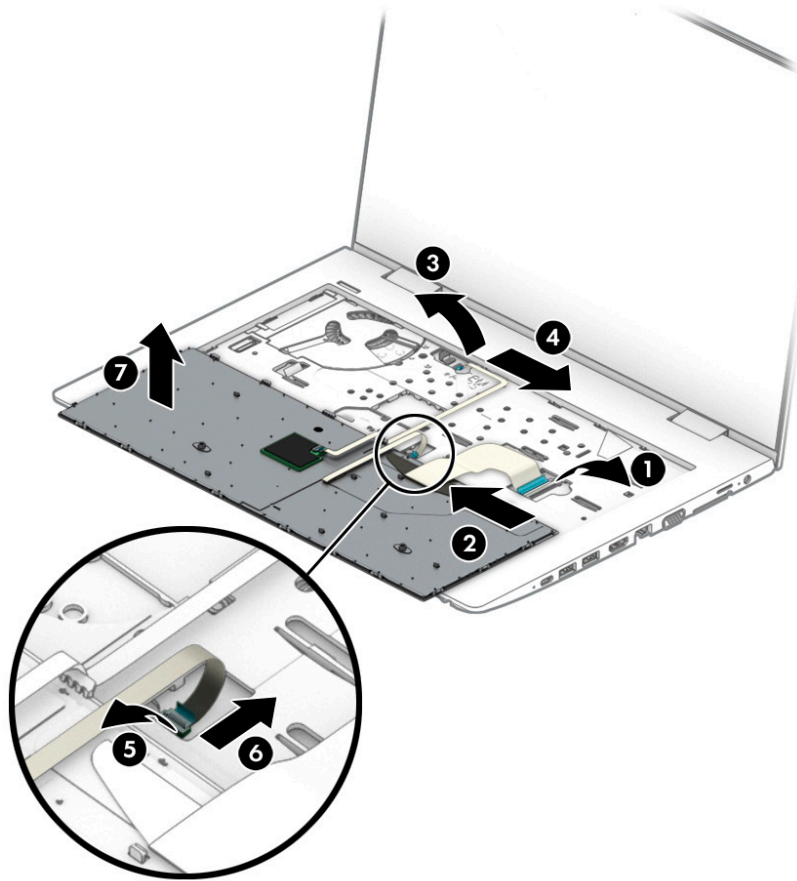

Reverse this procedure to install the keyboard.

Internal frame

Description	Spare part number
Internal frame	L09540-001

Before removing the internal frame, follow these steps:

1. Shut down the computer.
2. Disconnect all external devices connected to the computer.
3. Disconnect the power from the computer by first unplugging the power cord from the AC outlet and then unplugging the AC adapter from the computer.
4. Remove the following components:
 - a. Bottom cover (see [Bottom cover on page 33](#))
 - b. Battery (see [Battery on page 34](#))
 - c. Hard drive (see [Hard drive on page 37](#))
 - d. Keyboard (see [Keyboard on page 43](#))

Remove the internal frame:

 **IMPORTANT:** Make special note of each screw size and location during removal and replacement

1. Remove the antenna cables from clips in the frame **(1)**, and then remove the cables from the frame **(2)**.

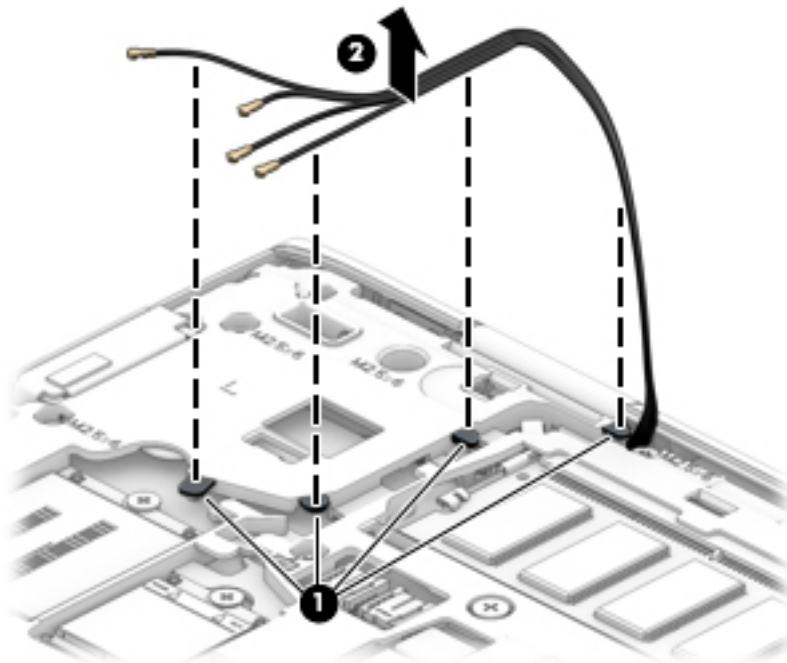

2. Remove the 14 Torx T8M 2.5×6.0 screws that secure the frame to the computer.

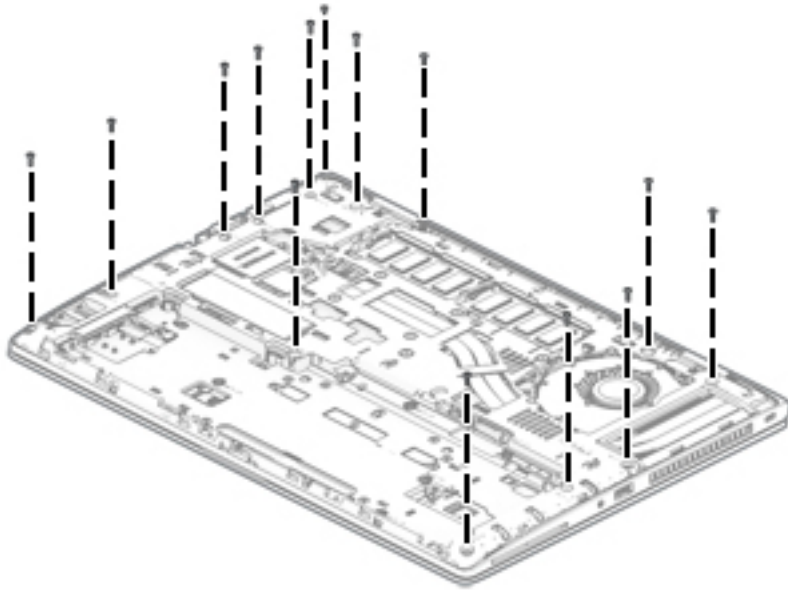

3. Remove the following screws that secure the frame to the computer:

(1): Two Phillips M 2.0×2.5 screws

(2): Five broad head Phillips M2.5×2.5 screws

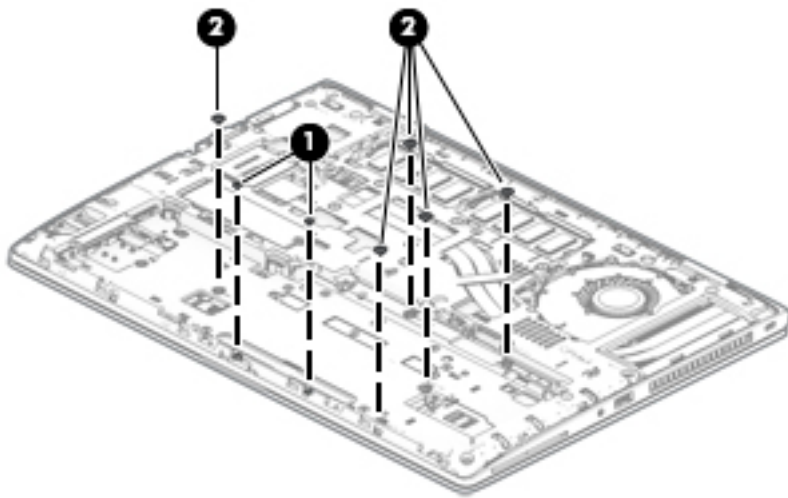

4. Remove the frame from the computer.

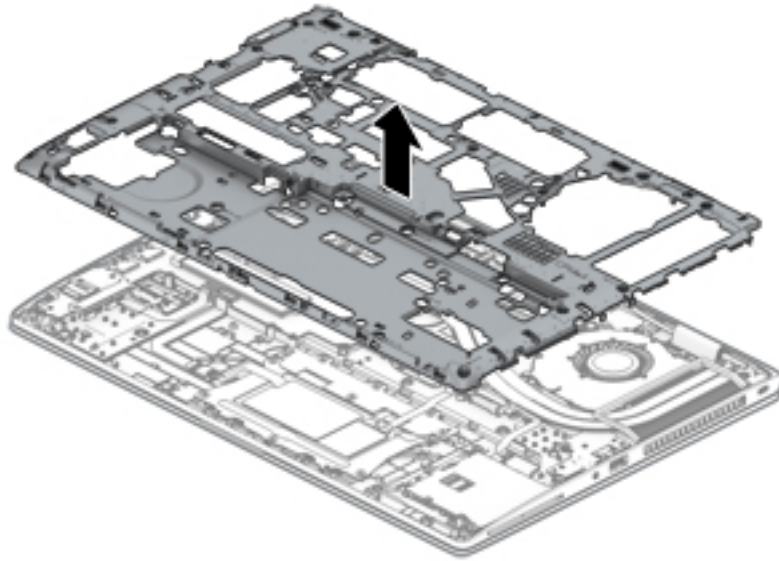

Reverse this procedure to install the internal frame.

Fan

Description	Spare part number
Fan	L09535-001

Before removing the fan, follow these steps:

1. Shut down the computer.
2. Disconnect all external devices connected to the computer.
3. Disconnect the power from the computer by first unplugging the power cord from the AC outlet and then unplugging the AC adapter from the computer.
4. Remove the following components:
 - a. Bottom cover (see [Bottom cover on page 33](#))
 - b. Battery (see [Battery on page 34](#))
 - c. Hard drive (see [Hard drive on page 37](#))
 - d. Solid-state drive (see [Solid-state drive on page 39](#))
 - e. WWAN module (see [WWAN module on page 40](#))
 - f. Keyboard (see [Keyboard on page 43](#))
 - g. Internal frame (see [Internal frame on page 47](#))

Remove the fan:

1. Disconnect the fan cable from the system board **(1)**.
2. Loosen the three captive Phillips screws that secure the fan to the computer **(2)**.
3. Remove the fan from the computer **(3)**.

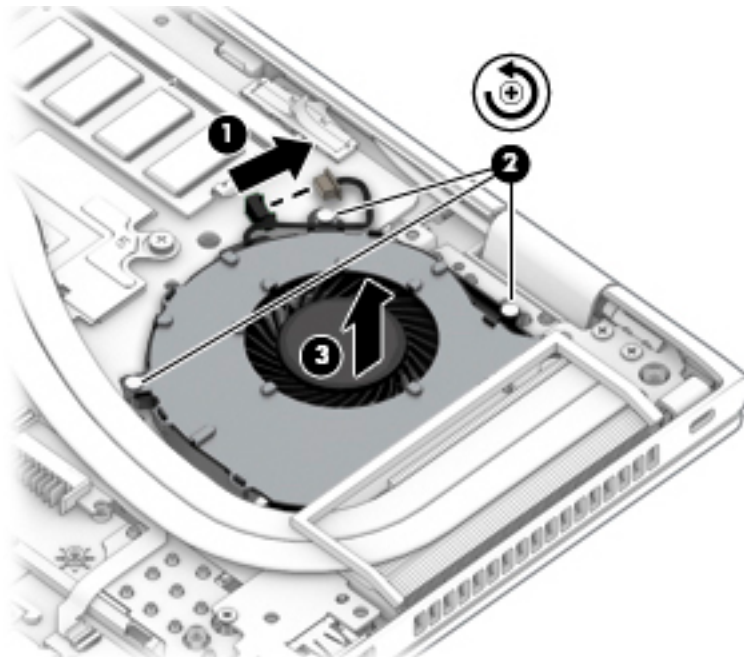

Reverse this procedure to install the fan.

Heat sink assembly

Description	Spare part number
Heat sink assembly	L09537-001

Before removing the heat sink, follow these steps:

1. Shut down the computer.
2. Disconnect all external devices connected to the computer.
3. Disconnect the power from the computer by first unplugging the power cord from the AC outlet and then unplugging the AC adapter from the computer.
4. Remove the following components:
 - a. Bottom cover (see [Bottom cover on page 33](#))
 - b. Battery (see [Battery on page 34](#))
 - c. Hard drive (see [Hard drive on page 37](#))
 - d. Solid-state drive (see [Solid-state drive on page 39](#))
 - e. WWAN module (see [WWAN module on page 40](#))
 - f. Keyboard (see [Keyboard on page 43](#))
 - g. Internal frame (see [Internal frame on page 47](#))

To remove the heat sink assembly:

1. In the order indicated on the heat sink assembly, loosen the four captive Phillips screws that secure the assembly to the computer **(1)**.

2. Lift the heat sink assembly from the computer (2).

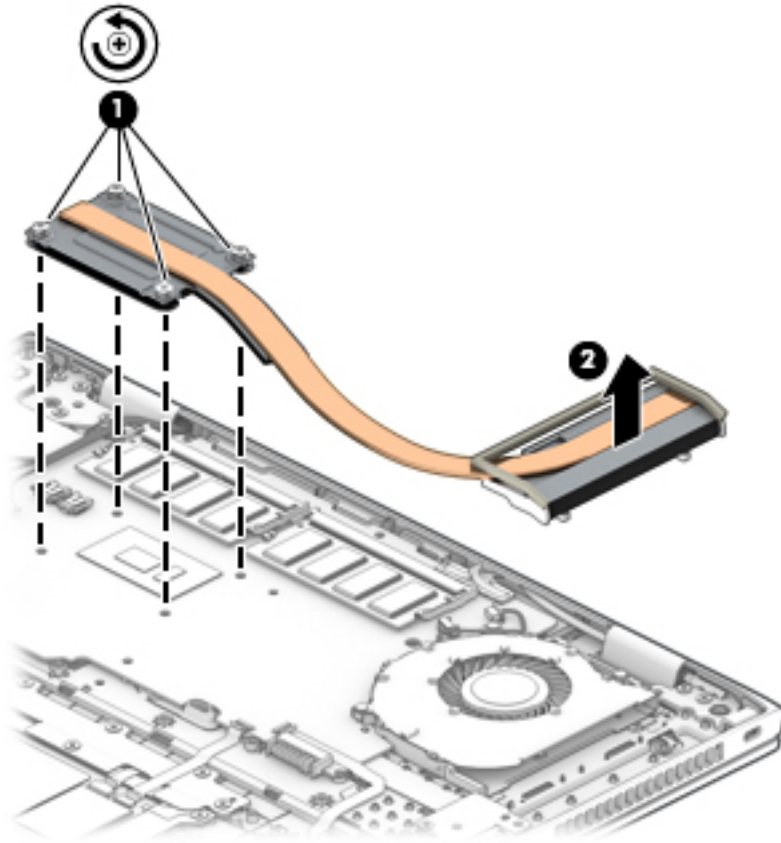

3. Thoroughly clean the thermal material from the surfaces of the system board components **(1)** and the heat sink **(2)** each time the heat sink is removed. Replacement thermal material is included with the heat sink and system board spare part kits.

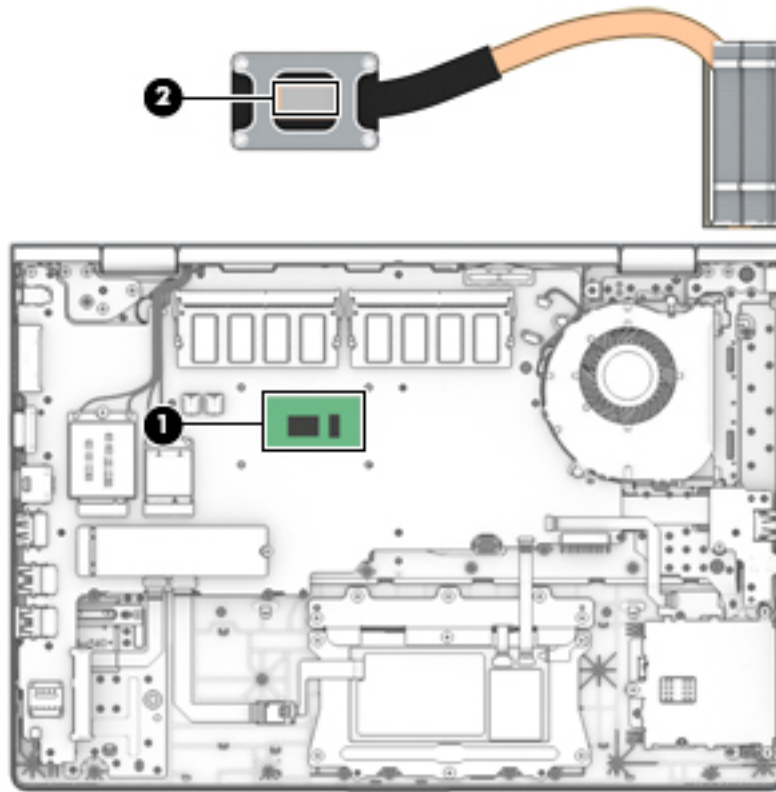

Reverse this procedure to install the heat sink assembly.

TouchPad button board

Description	Spare part number
TouchPad button board	L09541-001
TouchPad button board cable (included in Cable Kit)	L09534-001

Before removing the TouchPad button board, follow these steps:

1. Shut down the computer.
2. Disconnect all external devices connected to the computer.
3. Disconnect the power from the computer by first unplugging the power cord from the AC outlet and then unplugging the AC adapter from the computer.
4. Remove the following components:
 - a. Bottom cover (see [Bottom cover on page 33](#))
 - b. Battery (see [Battery on page 34](#))
 - c. Hard drive (see [Hard drive on page 37](#))
 - d. Solid-state drive (see [Solid-state drive on page 39](#))
 - e. WWAN module (see [WWAN module on page 40](#))
 - f. Keyboard (see [Keyboard on page 43](#))
 - g. Internal frame (see [Internal frame on page 47](#))

Remove the TouchPad button board:

1. Disconnect the system board cable from the ZIF connector on the TouchPad **(1)**.
2. Disconnect the TouchPad button board cable from the ZIF connector on the TouchPad **(2)**.

3. Remove the five Phillips M2.0×2.0 screws (3), and then remove the TouchPad button board from the computer (4).

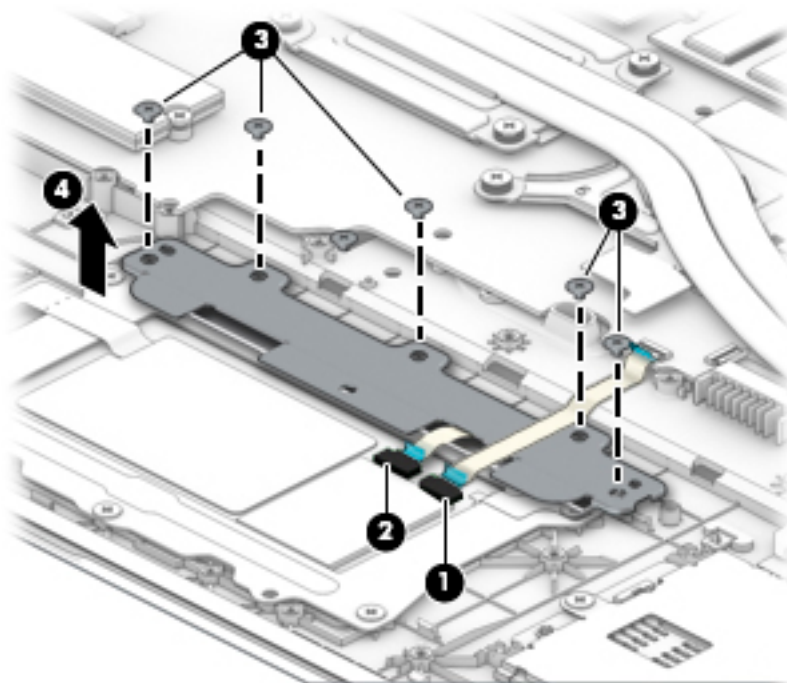

Reverse this procedure to install the TouchPad button board.

TouchPad

Description	Spare part number
TouchPad module for use in models with a pointing stick	L09561-001

Before removing the TouchPad, follow these steps:

1. Shut down the computer.
2. Disconnect all external devices connected to the computer.
3. Disconnect the power from the computer by first unplugging the power cord from the AC outlet and then unplugging the AC adapter from the computer.
4. Remove the following components:
 - a. Bottom cover (see [Bottom cover on page 33](#))
 - b. Battery (see [Battery on page 34](#))
 - c. Hard drive (see [Hard drive on page 37](#))
 - d. Solid-state drive (see [Solid-state drive on page 39](#))
 - e. WWAN module (see [WWAN module on page 40](#))
 - f. Keyboard (see [Keyboard on page 43](#))
 - g. Internal frame (see [Internal frame on page 47](#))
 - h. TouchPad button board (see [TouchPad button board on page 54](#))

To remove the TouchPad:

1. Disconnect the NFC antenna cable from the NFC module reverse ZIF connector **(1)**
2. Remove the five Phillips M2.0×2.0 screws **(2)**, and then remove the TouchPad **(3)**.

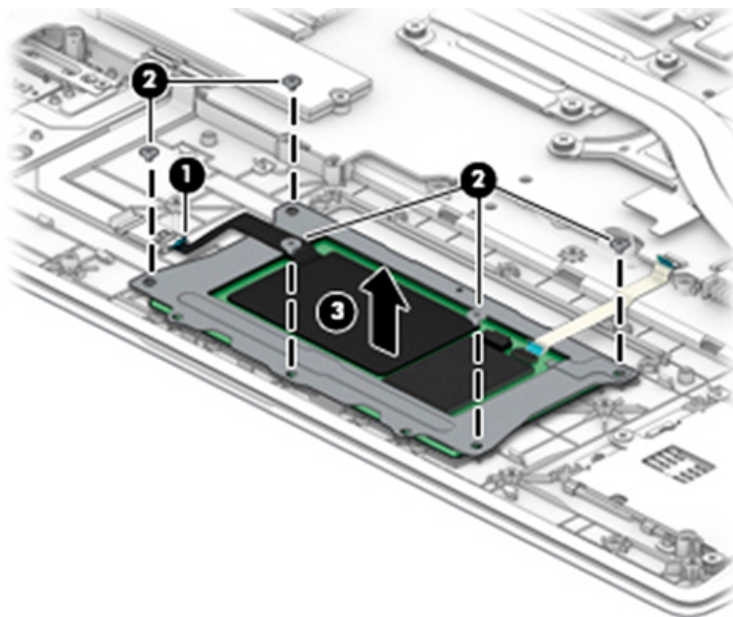

Reverse this procedure to install the TouchPad.

Near Field Communication (NFC) module

Description	Spare part number
NFC module	L09554-001
NFC antenna	L09524-001
NFC cable (included in Cable Kit)	L09534-001

Before removing the NFC module, follow these steps:

1. Turn off the computer. If you are unsure whether the computer is off or in Hibernation, turn the computer on, and then shut it down through the operating system.
2. Disconnect the power from the computer by unplugging the power cord from the computer.
3. Disconnect all external devices from the computer.
4. Remove the following components:
 - a. Bottom cover (see [Bottom cover on page 33](#))
 - b. Battery (see [Battery on page 34](#))
 - c. Hard drive (see [Hard drive on page 37](#))
 - d. Solid-state drive (see [Solid-state drive on page 39](#))
 - e. WWAN module (see [WWAN module on page 40](#))
 - f. Keyboard (see [Keyboard on page 43](#))
 - g. Internal frame (see [Internal frame on page 47](#))

Remove the NFC module:

1. Disconnect the system board cable from the NFC module ZIF connector **(1)**.
2. Disconnect the NFC antenna cable (that connects to the TouchPad) from the NFC module reverse ZIF connector **(2)**.

3. Use a tool to disengage the NFC module from the computer **(3)**.

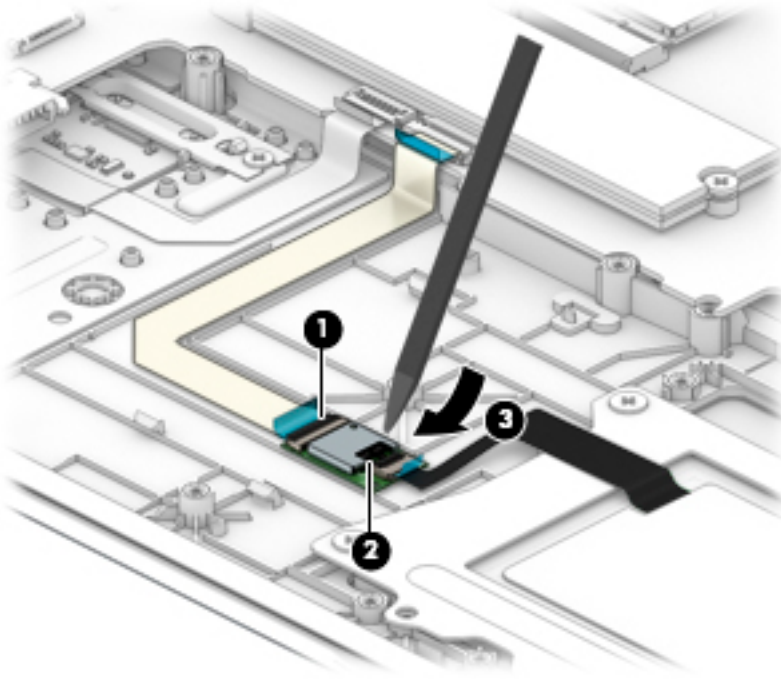

Reverse this procedure to replace the NFC module.

Smart card reader

Description	Spare part number
Smart card reader board	L09550-001
Smart card reader bracket (included in Bracket Kit)	L09539-001
Smart card reader cable (included in Cable Kit)	L09534-001

Before removing the smart card reader, follow these steps:

1. Shut down the computer.
2. Disconnect all external devices connected to the computer.
3. Disconnect the power from the computer by first unplugging the power cord from the AC outlet and then unplugging the AC adapter from the computer.
4. Remove the following components:
 - a. Bottom cover (see [Bottom cover on page 33](#))
 - b. Battery (see [Battery on page 34](#))
 - c. Hard drive (see [Hard drive on page 37](#))
 - d. Solid-state drive (see [Solid-state drive on page 39](#))
 - e. WWAN module (see [WWAN module on page 40](#))
 - f. Keyboard (see [Keyboard on page 43](#))
 - g. Internal frame (see [Internal frame on page 47](#))

Remove the smart card reader:

1. Disconnect the system board cable from the smart card reader board ZIF connector **(1)**.

2. Remove the three Phillips M2.0×2.5 screws **(2)**, and then remove the smart card reader board from the computer **(3)**.

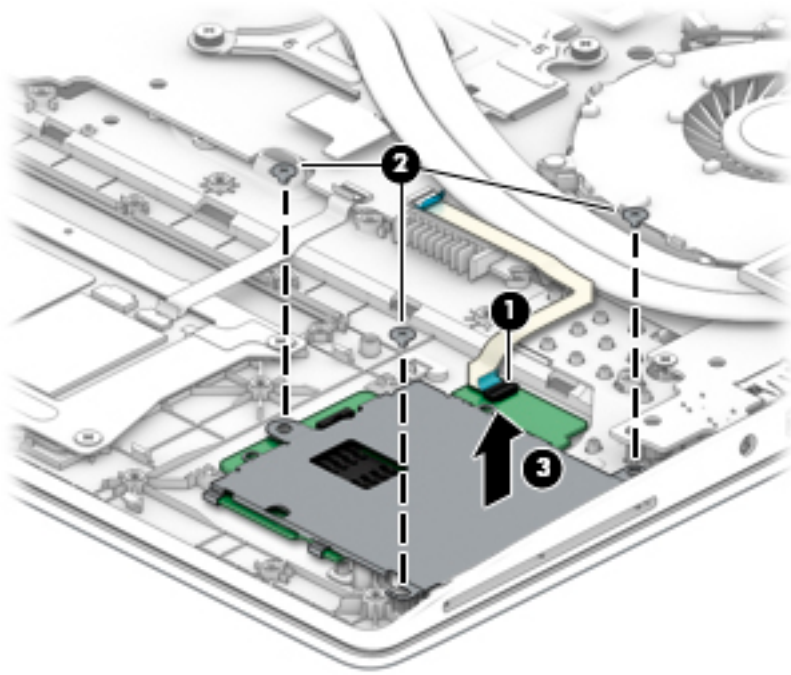

Reverse this procedure to install the smart card reader.

USB board

Description	Spare part number
USB board	L09553-001
USB board cable (included in Cable Kit)	L09534-001

Before removing the USB board, follow these steps:

1. Turn off the computer. If you are unsure whether the computer is off or in Hibernation, turn the computer on, and then shut it down through the operating system.
2. Disconnect the power from the computer by unplugging the power cord from the computer.
3. Disconnect all external devices from the computer.
4. Remove the following components:
 - a. Bottom cover (see [Bottom cover on page 33](#))
 - b. Battery (see [Battery on page 34](#))
 - c. Hard drive (see [Hard drive on page 37](#))
 - d. Solid-state drive (see [Solid-state drive on page 39](#))
 - e. WWAN module (see [WWAN module on page 40](#))
 - f. Keyboard (see [Keyboard on page 43](#))
 - g. Internal frame (see [Internal frame on page 47](#))

Remove the USB board:

1. Position the computer upright and open as far as possible.

2. Disconnect the USB board cable from the system board (1).

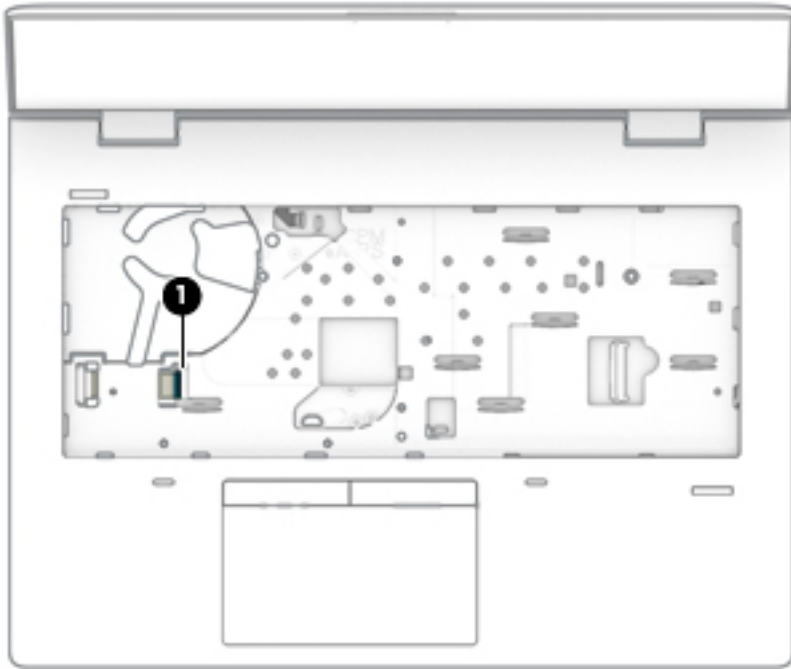

3. Position the computer upside down.
4. Remove the Phillips M2.0×3.0 screw (2), and then remove the board from the computer (3).

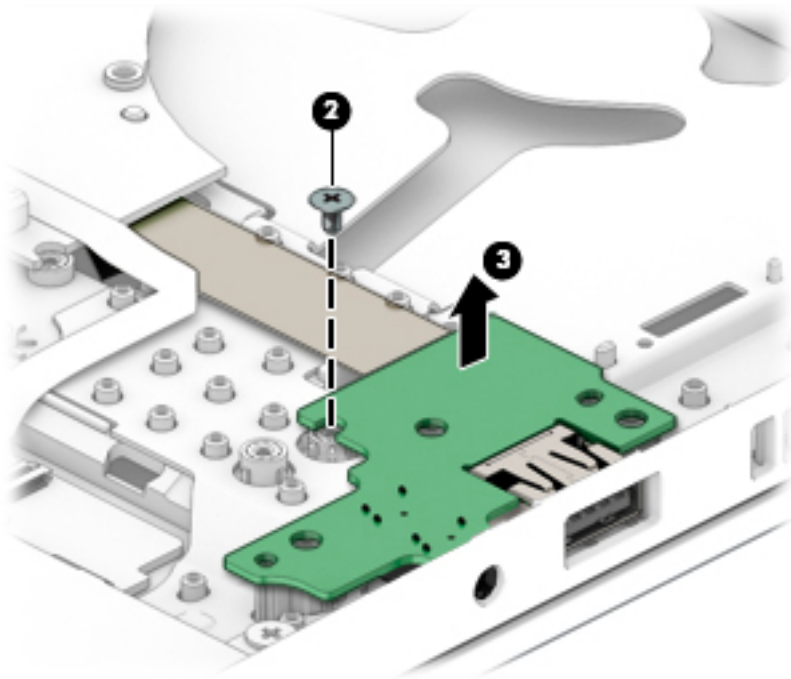

Reverse this procedure to replace the USB board.

Power button board

Description	Spare part number
Power button board (includes cable)	L09552-001

Before removing the power button board, follow these steps:

1. Turn off the computer. If you are unsure whether the computer is off or in Hibernation, turn the computer on, and then shut it down through the operating system.
2. Disconnect the power from the computer by unplugging the power cord from the computer.
3. Disconnect all external devices from the computer.
4. Remove the following components:
 - a. Bottom cover (see [Bottom cover on page 33](#))
 - b. Battery (see [Battery on page 34](#))
 - c. Hard drive (see [Hard drive on page 37](#))
 - d. Solid-state drive (see [Solid-state drive on page 39](#))
 - e. WWAN module (see [WWAN module on page 40](#))
 - f. Keyboard (see [Keyboard on page 43](#))
 - g. Internal frame (see [Internal frame on page 47](#))

Remove the power button board:

1. Position the computer upright and open as far as possible.
2. Disconnect the power button board cable from the system board **(1)**.

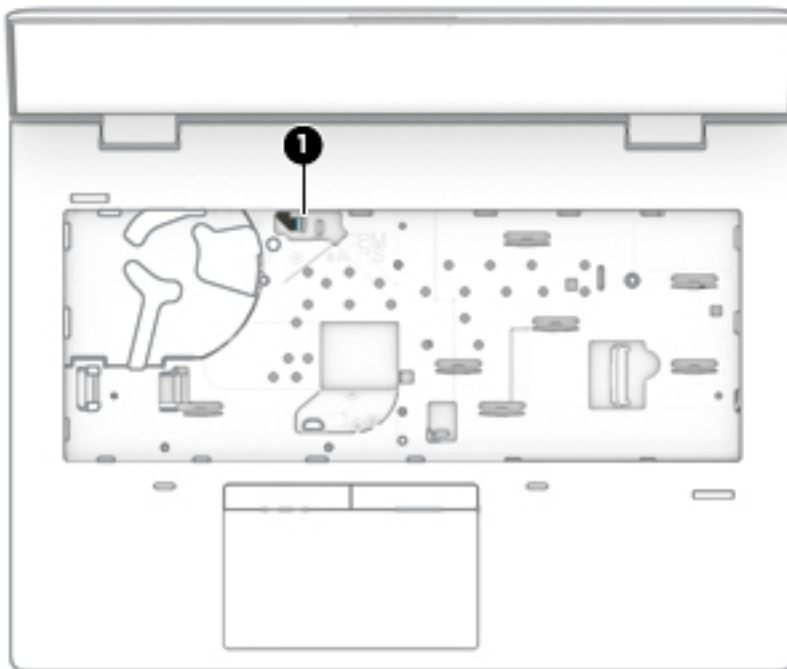

3. Position the computer upside down.
4. Lift the cable up to disengage it from the adhesive that secures it to the chassis **(2)**.
5. Remove the Phillips M2.0×3.0 screw **(3)** that secures the board to the computer.
6. Remove the board and cable from the computer **(4)**.

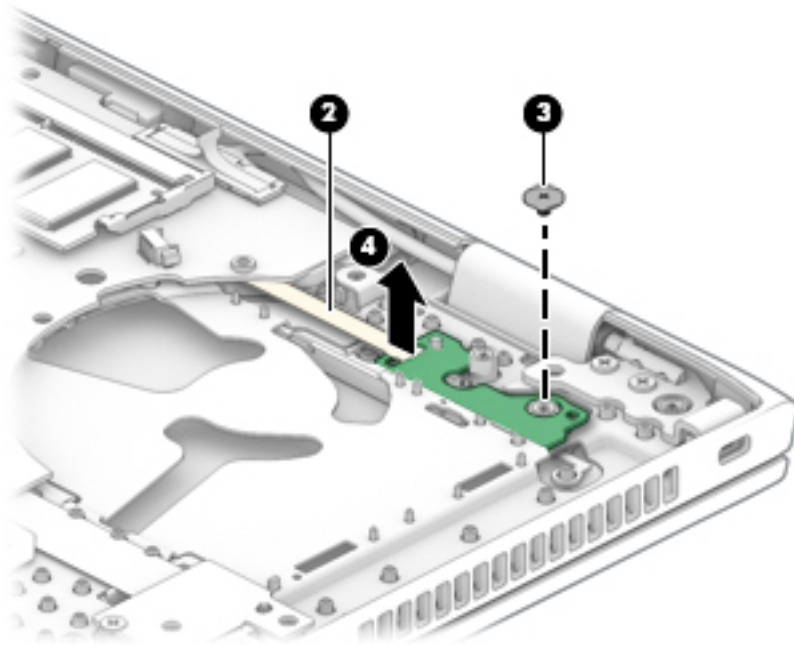

Reverse this procedure to install the power button board.

System board



NOTE: All system board spare part kits include replacement thermal material.

All system boards use the following part numbers:

xxxxxx-001: Non-Windows operating systems

xxxxxx-601: Windows operating system

Description	Spare part number
System board with integrated AMD Ryzen 7 PRO 2700U mobile processor	L12802-xx1
System board with integrated AMD Ryzen 5 PRO 2500U mobile processor	L12801-xx1
System board with integrated AMD Ryzen 3 PRO 2300U mobile processor	L12800-xx1

Before removing the system board, follow these steps:

1. Turn off the computer. If you are unsure whether the computer is off or in Hibernation, turn the computer on, and then shut it down through the operating system.
2. Disconnect the power from the computer by unplugging the power cord from the computer.
3. Disconnect all external devices from the computer.
4. Remove the following components:
 - a. Bottom cover (see [Bottom cover on page 33](#))
 - b. Battery (see [Battery on page 34](#))
 - c. Hard drive (see [Hard drive on page 37](#))
 - d. Solid-state drive (see [Solid-state drive on page 39](#))
 - e. WWAN module (see [WLAN module on page 42](#))
 - f. WLAN module (see [WWAN module on page 40](#))
 - g. Memory modules (see [Memory on page 35](#))
 - h. Keyboard (see [Keyboard on page 43](#))
 - i. Internal frame (see [Internal frame on page 47](#))

Remove the system board:



IMPORTANT: Make special note of each screw size and location during removal and replacement

1. Position the computer upright and open.

2. Disconnect the following cables from the system board:

(1): Power button board cable

(2): USB cable

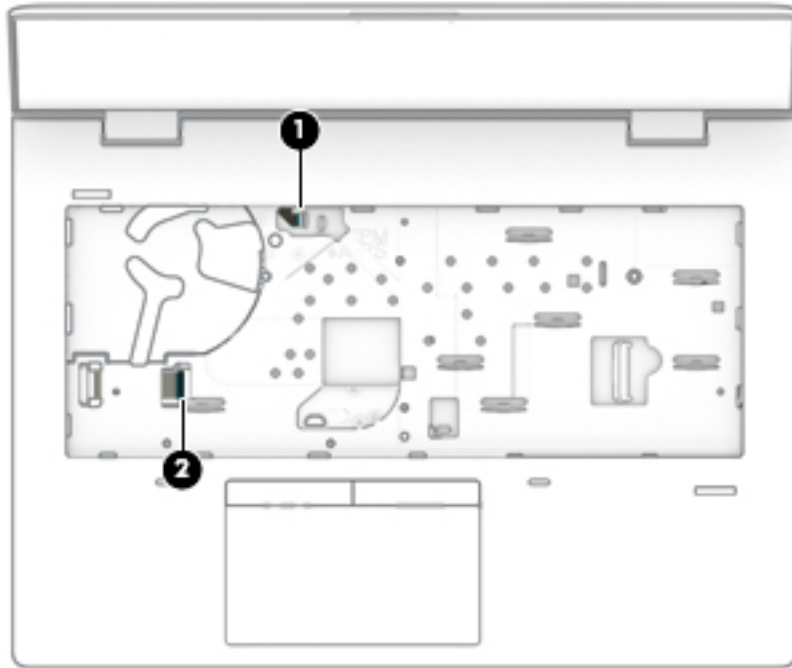

3. Position the computer upside down.

4. Disconnect the following cables from the system board:

(1): Display cable

(2): Smart card reader cable

(3): TouchPad cable

(4): NFC module cable

(5): Fingerprint reader board cable

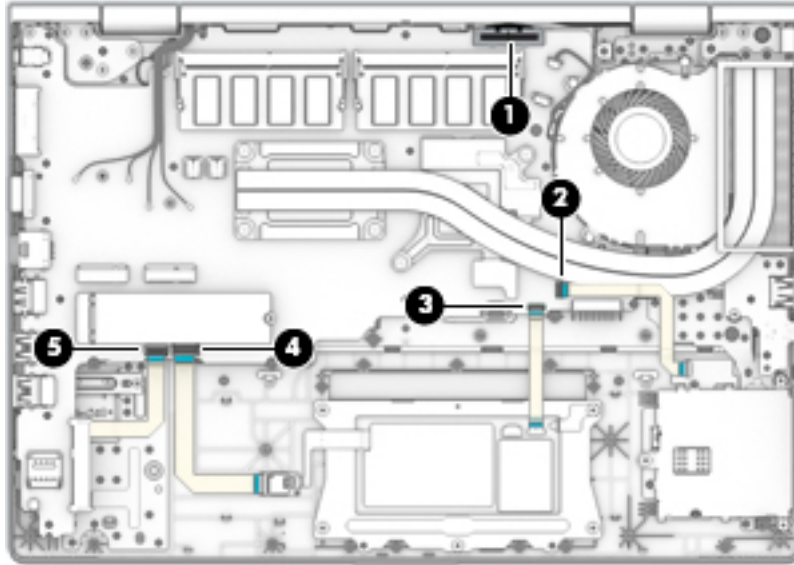

5. Remove the Phillips M2.0×3.0 screw (1), and then loosen captive Phillips screw (2) on the fan.

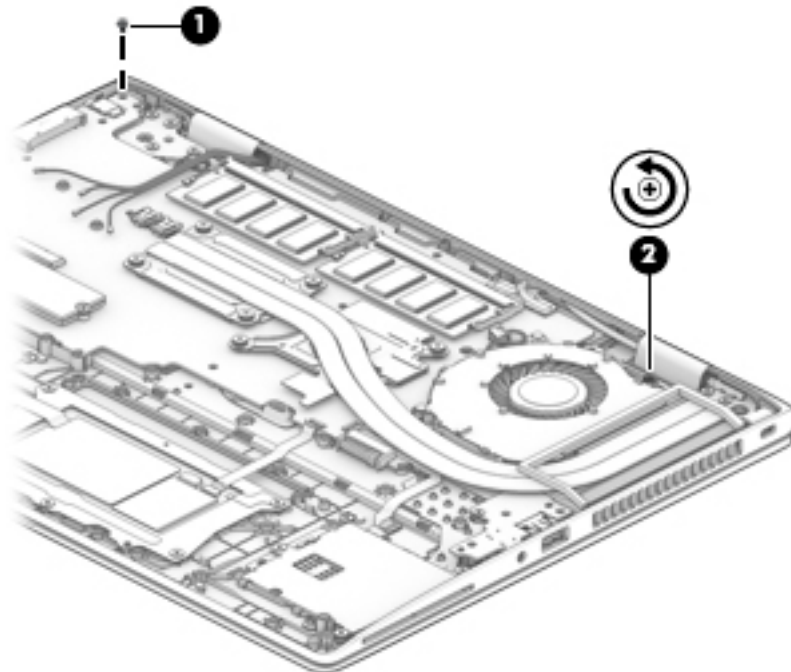

6. Lift the right side of the system board **(1)**, and then pull it to the right to remove it from the computer **(2)**.

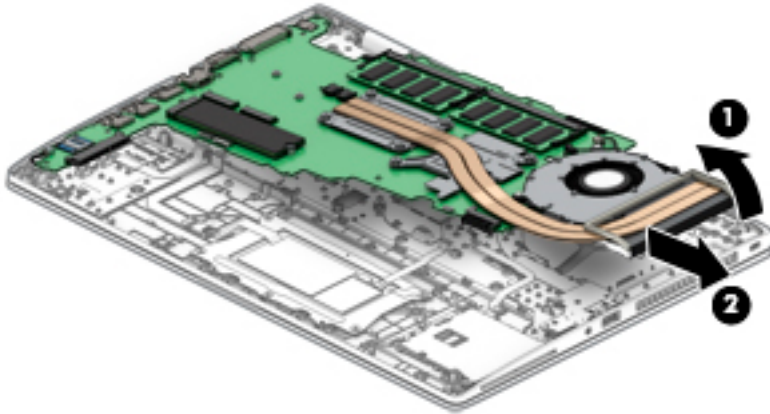

Reverse this procedure to install the system board.

RTC battery

Description	Spare part number
RTC battery	857798-001

Before removing the RTC battery, follow these steps:

1. Turn off the computer. If you are unsure whether the computer is off or in Hibernation, turn the computer on, and then shut it down through the operating system.
2. Disconnect the power from the computer by unplugging the power cord from the computer.
3. Disconnect all external devices from the computer.
4. Remove the following components:
 - a. Bottom cover (see [Bottom cover on page 33](#))
 - b. Battery (see [Battery on page 34](#))
 - c. Hard drive (see [Hard drive on page 37](#))
 - d. Solid-state drive (see [Solid-state drive on page 39](#))
 - e. WWAN module (see [WWAN module on page 40](#))
 - f. Keyboard (see [Keyboard on page 43](#))
 - g. Internal frame (see [Internal frame on page 47](#))
 - h. System board (see [System board on page 65](#))

To remove the RTC battery:

- ▲ Disconnect the RTC battery cable from the system board **(1)**, and then pry the RTC battery from the system board **(2)**.

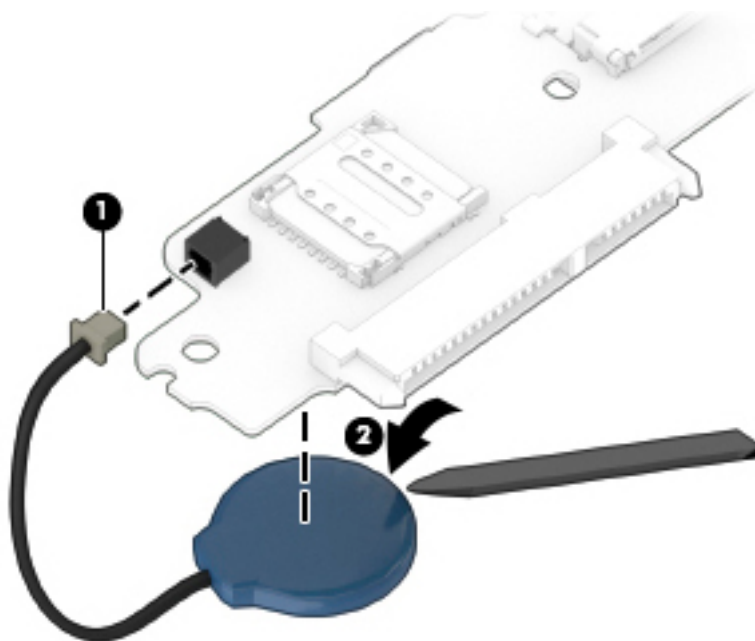

Reverse this procedure to install the RTC battery.

Speaker

Description	Spare part number
Speaker Kit	L09558-001

Before removing the speaker, follow these steps:

1. Turn off the computer. If you are unsure whether the computer is off or in Hibernation, turn the computer on, and then shut it down through the operating system.
2. Disconnect the power from the computer by unplugging the power cord from the computer.
3. Disconnect all external devices from the computer.
4. Remove the following components:
 - a. Bottom cover (see [Bottom cover on page 33](#))
 - b. Battery (see [Battery on page 34](#))
 - c. Hard drive (see [Hard drive on page 37](#))
 - d. Solid-state drive (see [Solid-state drive on page 39](#))
 - e. WWAN module (see [WWAN module on page 40](#))
 - f. Keyboard (see [Keyboard on page 43](#))
 - g. Internal frame (see [Internal frame on page 47](#))
 - h. System board (see [System board on page 65](#))

Remove the speaker:

1. Remove the two Phillips M2.5×3.0 screws **(1)** that secure the speaker to the computer.
2. Lift the speaker assembly up enough to access and remove the antenna cables connected to it **(2)**, and then remove the speaker from the computer **(3)**.

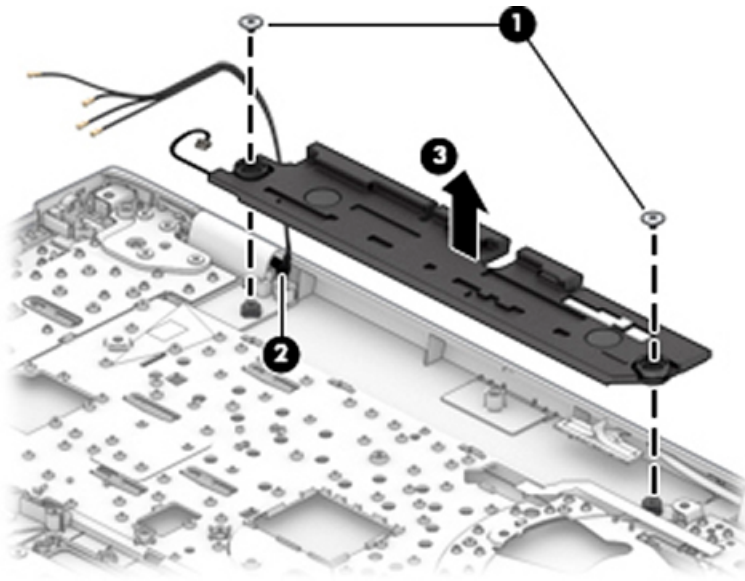

Reverse this procedure to install the speaker.

Fingerprint reader assembly

Description	Spare part number
Fingerprint reader assembly (includes cable)	L09538-001
Fingerprint reader bracket (included in Bracket Kit)	L09539-001

Before removing the fingerprint reader assembly, follow these steps:

1. Turn off the computer. If you are unsure whether the computer is off or in Hibernation, turn the computer on, and then shut it down through the operating system.
2. Disconnect the power from the computer by unplugging the power cord from the computer.
3. Disconnect all external devices from the computer.
4. Remove the following components:
 - a. Bottom cover (see [Bottom cover on page 33](#))
 - b. Battery (see [Battery on page 34](#))
 - c. Hard drive (see [Hard drive on page 37](#))
 - d. Solid-state drive (see [Solid-state drive on page 39](#))
 - e. WWAN module (see [WWAN module on page 40](#))
 - f. Keyboard (see [Keyboard on page 43](#))
 - g. Internal frame (see [Internal frame on page 47](#))
 - h. System board (see [System board on page 65](#))

Remove the fingerprint reader assembly:

1. Remove the Phillips M2.0×2.0 screw **(1)** from the fingerprint reader bracket.
2. Slide the bracket toward the right, and then lift the right side up and pull the bracket toward the right and off the fingerprint reader board **(2)**.

3. Use a tool to disengage the fingerprint reader board from the computer (3).

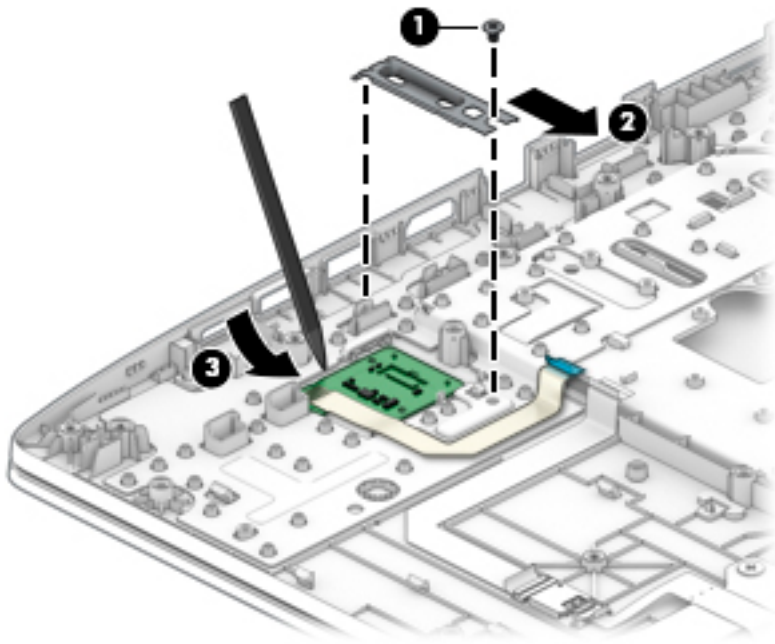

Reverse this procedure to install the fingerprint reader assembly.

Display assembly

Full hinge-up displays are not spared. Displays are spared only at the subcomponent level.

Before removing the display panel, follow these steps:

1. Turn off the computer. If you are unsure whether the computer is off or in Hibernation, turn the computer on, and then shut it down through the operating system.
2. Disconnect the power from the computer by unplugging the power cord from the computer.
3. Disconnect all external devices from the computer.
4. Remove the following components:
 - a. Bottom cover (see [Bottom cover on page 33](#))
 - b. Battery (see [Battery on page 34](#))
 - c. Hard drive (see [Hard drive on page 37](#))
 - d. Solid-state drive (see [Solid-state drive on page 39](#))
 - e. WWAN module (see [WWAN module on page 40](#))
 - f. Keyboard (see [Keyboard on page 43](#))
 - g. Internal frame (see [Internal frame on page 47](#))

Remove the display assembly:

1. Disconnect the antenna cables from the WLAN module **(1)** and the WWAN module **(2)** (select models only).
2. Disconnect the display cable from the system board **(3)**.
3. Remove the antenna cables from the clips in the speaker **(4)**.

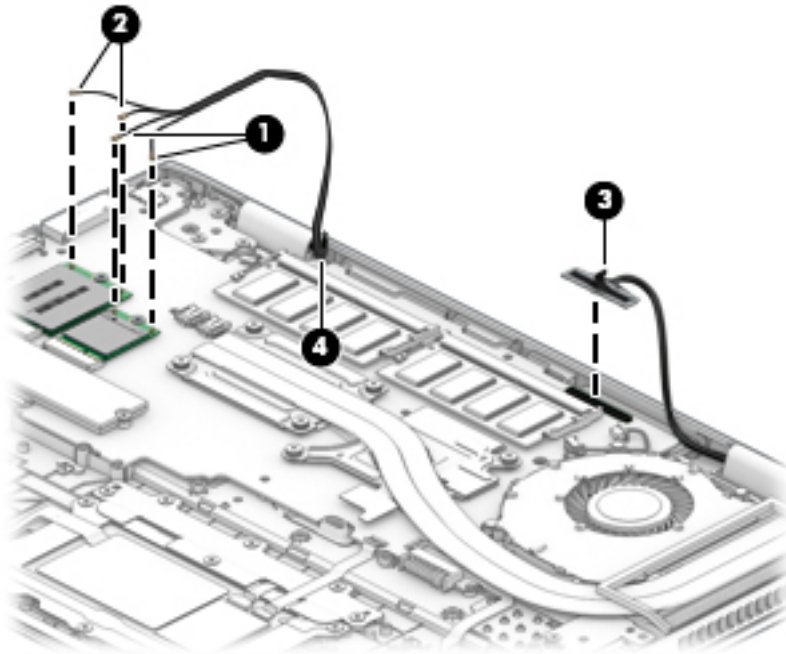

4. Rotate the display to open the hinges as far as possible (about 145 degrees) **(1)**.

5. Remove the six Phillips M2.5×5.0 screws (2) from the display hinges.
6. Pull the display away from the computer (3).

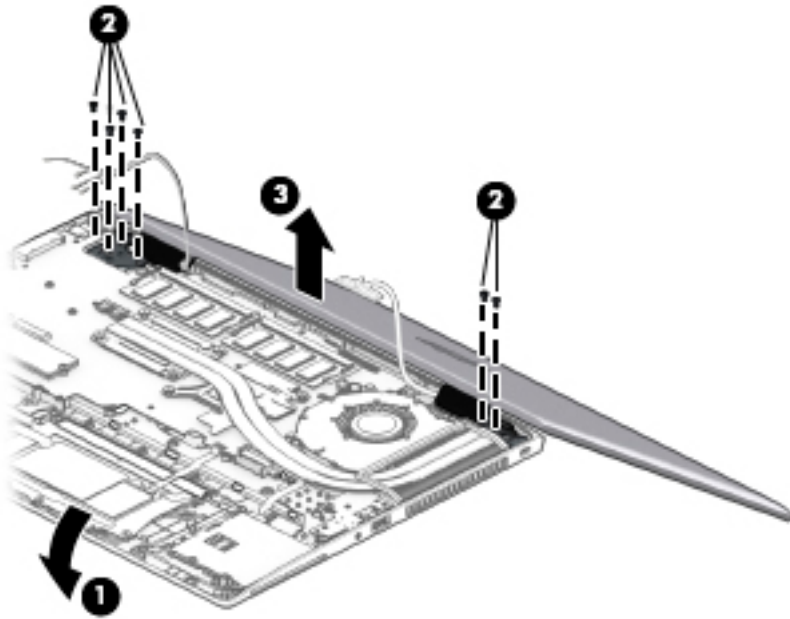

Remove the display assembly components:

1. If it is necessary to replace the display bezel:
 - a. Use a non-marking tool to separate the display from the display cover (1).
 - b. Rotate the display over and place it next to the display cover (2).
- Display bezels are available using the following spare part numbers:
- Non-touch displays with camera module: L09530-001
 - Non-touch displays with microphone module: L09531-001
 - Touch displays: L19830-001

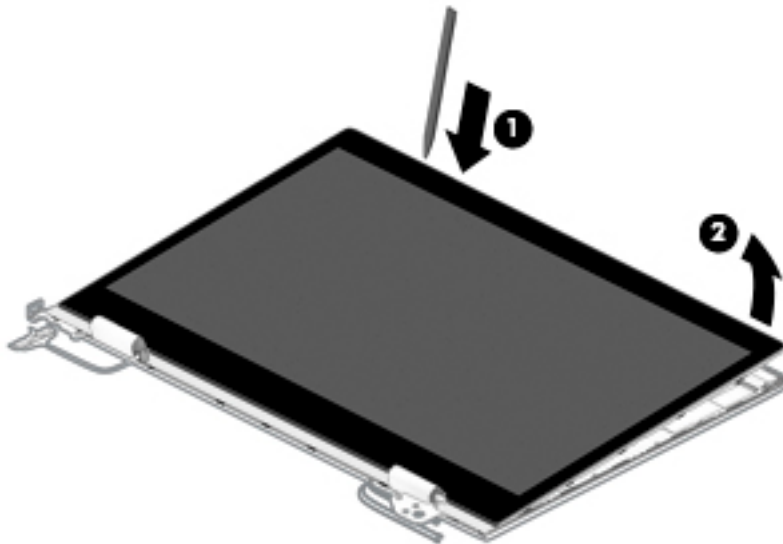

2. If it is necessary to replace the camera or microphone module:
 - a. Use a tool to detach the camera **(1)** from the display cover.
 - b. Disconnect the cable **(2)** from the camera.

The camera module is available using spare part number L23432-001.

The microphone module is available using spare part number L09551-001.

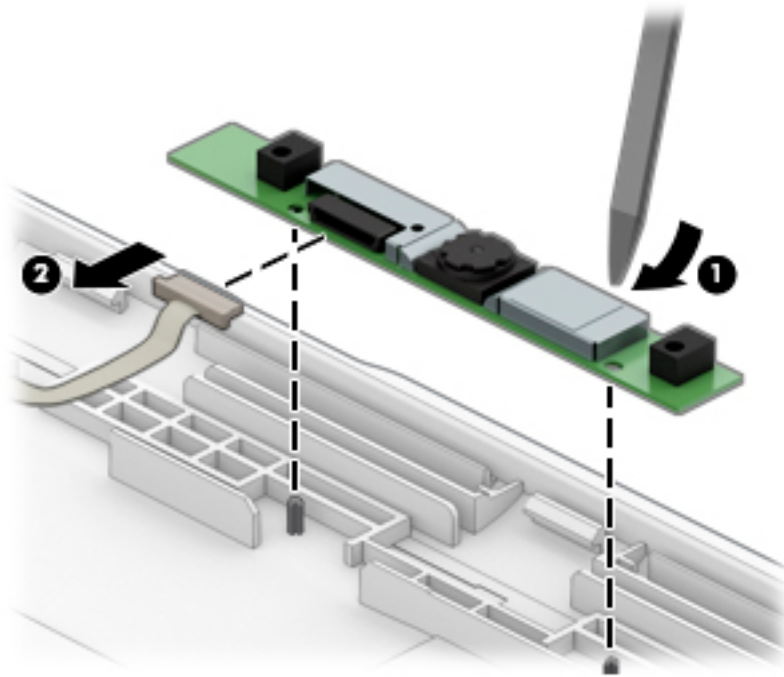

3. If it is necessary to replace the display panel:
 - a. Lift the tape on the main connector **(1)**.
 - b. Squeeze both sides of main connector on the panel, and then pull the cable from the connector **(2)**.

- c. (Touch models only) Lift the tape on the touch board connector **(3)**, and then pull the cable from the connector **(4)**.

Raw display panels are available using the following spare part numbers:

- Non-touch, FHD: L12814-001
- Non-touch, HD: L12813-001
- Touch, FHD: L18411-001

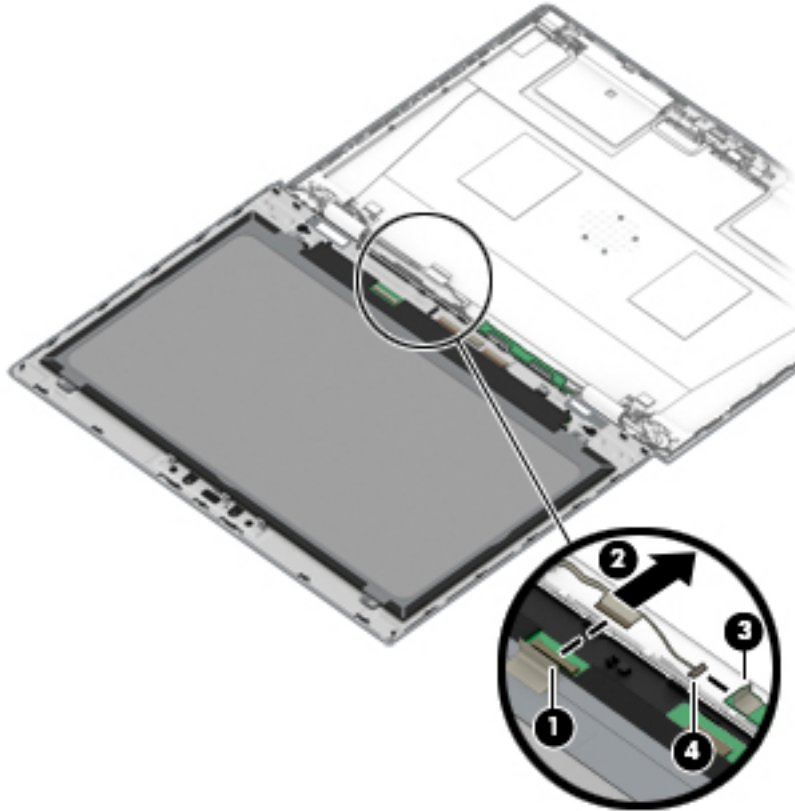

- d. Remove the four Phillips M2.0×1.6 screws **(1)** that secure the display panel to the display cover.

- e. Lift the panel from the display cover **(2)**.

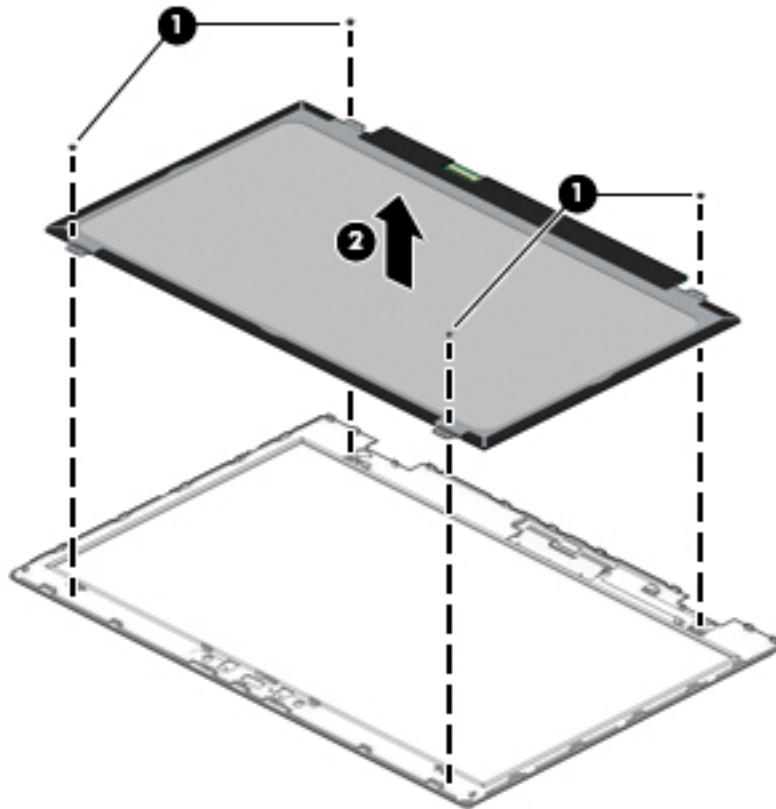

4. If it is necessary remove the hinge covers, remove the Phillips M2.0×3.0 screw from each hinge cover **(1)**.
5. Use a thin tool to pry up at the seam under each hinge cover, between the hinge cover and bottom of the display cover **(2)**.

6. Remove the hinge covers from the display cover (3).

Display hinge covers are available using spare part number L09545-001.

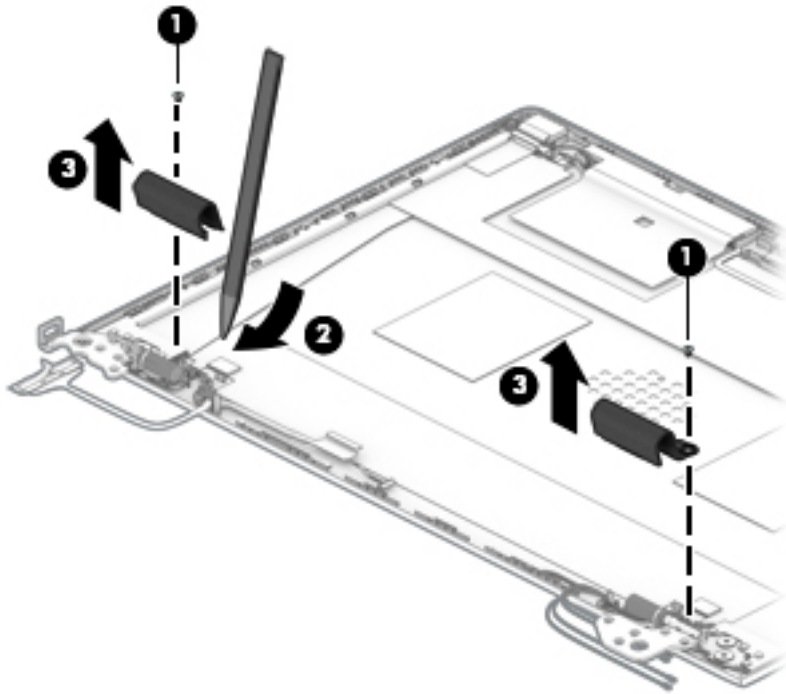

7. If it is necessary to replace the hinge brackets, remove the three Phillips M2.5×3.0 screws from the bottom of each hinge (1) and the Phillips M2.0×3.0 screw from the top of each hinge (2).
8. Remove the hinges from the display cover (3).

Display hinges are available using spare part number L09544-001 for non-touch models or L23433-001 for touch models.

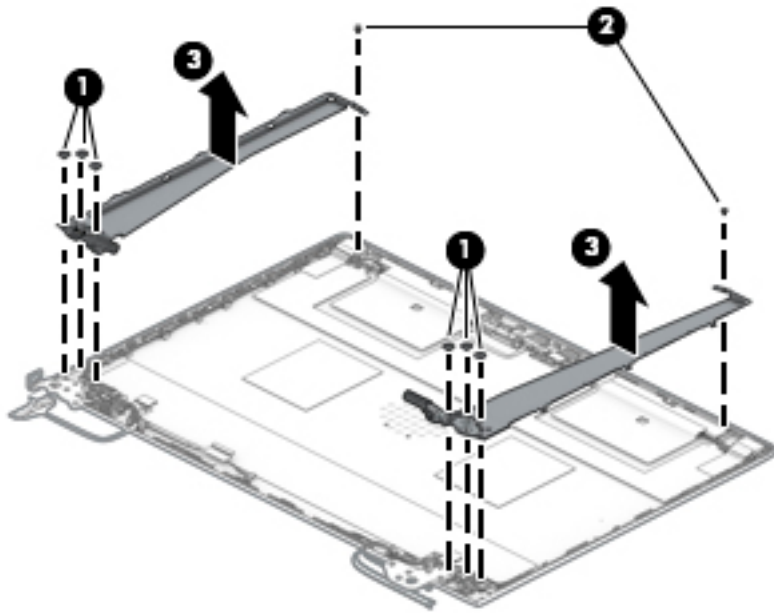

9. If it is necessary to replace the WLAN antenna cables, note the proper cable routing through the right hinge (1).
10. Peel the antennas from the top of the display cover (2), and then remove the WLAN antenna cables from the channels along the sides of the display cover (3).
11. Remove the antenna cables from the display cover (4).

WLAN antennas are available in the Antenna Kit using spare part number L09523-001.

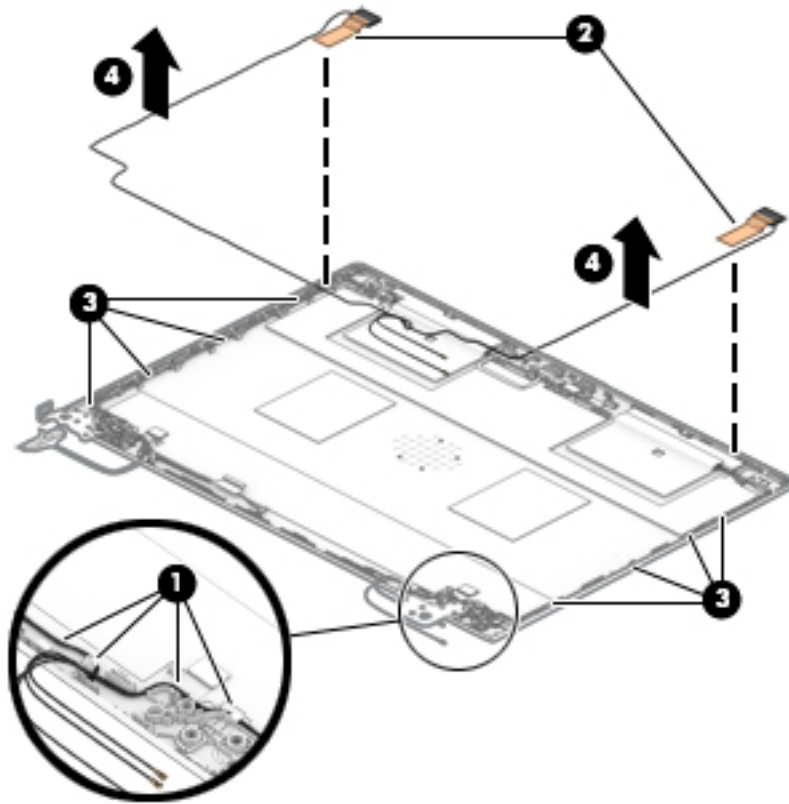

12. If it is necessary to replace the WWAN antenna cables, note the proper cable routing through the right hinge (1).
13. Peel the antennas from the top of the display cover (2), and then remove the WWAN antenna cables from the channels along the sides of the display cover (3).

14. Remove the antenna cables from the display cover **(4)**.

WWAN antennas are available in the Antenna Kit using spare part number L09523-001.

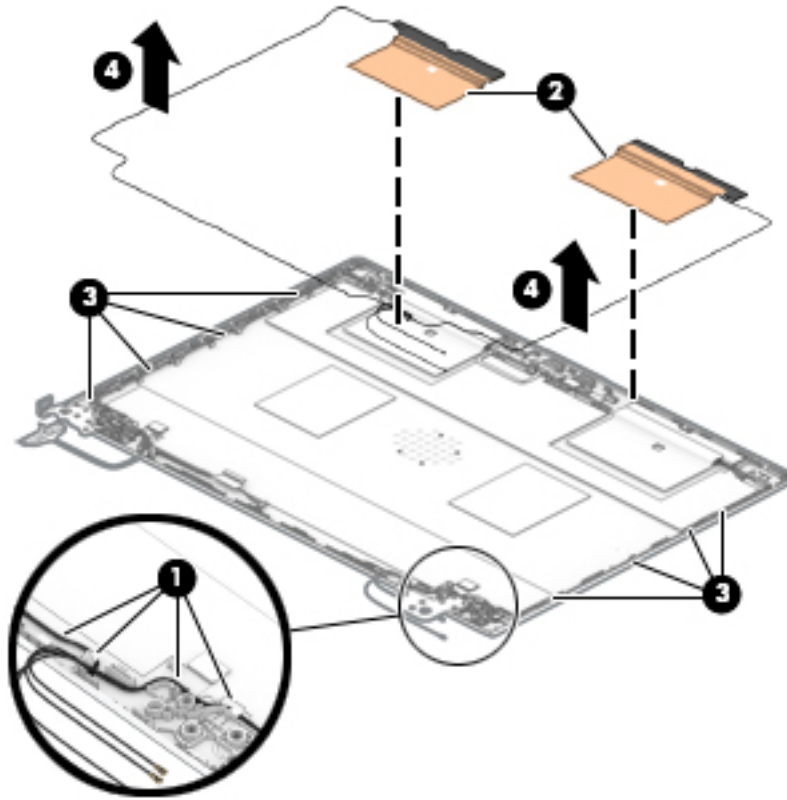

The display rear cover is available using spare part number L09526-001 for non-touch models or L19831-001 for touch models.

The display cable is available using spare part number L09533-001 for non-touch models or L19834-001 for touch models.

Reverse these procedures to reassemble and install the display assembly components.

7 Computer Setup (BIOS), TPM, and HP Sure Start

Using Computer Setup

Computer Setup, or Basic Input/Output System (BIOS), controls communication between all the input and output devices on the system (such as disk drives, display, keyboard, mouse, and printer). Computer Setup includes settings for the types of devices installed, the startup sequence of the computer, and the amount of system and extended memory.



NOTE: Use extreme care when making changes in Computer Setup. Errors can prevent the computer from operating properly.

Starting Computer Setup

- ▲ Turn on or restart the computer, and when the HP logo appears, press **f10** to enter Computer Setup.

Using a USB keyboard or USB mouse to start Computer Setup (BIOS)

You can start Computer Setup by using a keyboard or mouse connected to a USB port, but you must first disable FastBoot.

1. Turn on or restart the computer, and when the HP logo appears, press **f9** to enter the Boot Device Options menu.
2. Clear the check box for **Fast Boot**.
3. To save your changes and exit, select the **Save** icon in the lower-right corner of the screen, and then follow the on-screen instructions.

– or –

Select **Main**, select **Save Changes and Exit**, and then press **enter**.

Your changes go into effect when the computer restarts.

Navigating and selecting in Computer Setup

- To select a menu or a menu item, use the **tab** key and the keyboard arrow keys and then press **enter**, or use a pointing device to select the item.
- To scroll up and down, select the up arrow or the down arrow in the upper-right corner of the screen, or use the up arrow key or the down arrow key on the keyboard.
- To close open dialog boxes and return to the main Computer Setup screen, press **esc**, and then follow the on-screen instructions.

To exit Computer Setup menus, choose one of the following methods:

- To exit Computer Setup menus without saving your changes:
Select the **Exit** icon in the lower-right corner of the screen, and then follow the on-screen instructions.
– or –
Select **Main**, select **Ignore Changes and Exit**, and then press **enter**.
- To save your changes and exit Computer Setup menus:
Select the **Save** icon in the lower-right corner of the screen, and then follow the on-screen instructions.
– or –
Select **Main**, select **Save Changes and Exit**, and then press **enter**.

Your changes go into effect when the computer restarts.

Restoring factory settings in Computer Setup

 **NOTE:** Restoring defaults will not change the hard drive mode.

To return all settings in Computer Setup to the values that were set at the factory, follow these steps:

1. Start Computer Setup. See [Starting Computer Setup on page 81](#).
2. Select **Main**, and then select **Apply Factory Defaults and Exit**.

 **NOTE:** On select products, the selections may display **Restore Defaults** instead of **Apply Factory Defaults and Exit**.

3. Follow the on-screen instructions.
4. To save your changes and exit, select the **Save** icon in the lower-right corner of the screen, and then follow the on-screen instructions.
– or –
Select **Main**, select **Save Changes and Exit**, and then press **enter**.

Your changes go into effect when the computer restarts.

 **NOTE:** Your password settings and security settings are not changed when you restore the factory settings.

Updating the BIOS

Updated versions of the BIOS may be available on the HP website.

Most BIOS updates on the HP website are packaged in compressed files called *SoftPaqs*.

Some download packages contain a file named *Readme.txt*, which contains information regarding installing and troubleshooting the file.

Determining the BIOS version

To decide whether you need to update Computer Setup (BIOS), first determine the BIOS version on your computer.

BIOS version information (also known as *ROM date* and *System BIOS*) can be accessed by pressing **fn+esc** (if you are already in Windows) or by using Computer Setup.

1. Start Computer Setup. See [Starting Computer Setup on page 81](#).
2. Select **Main**, and then select **System Information**.
3. To exit Computer Setup without saving your changes, select the **Exit** icon in the lower-right corner of the screen, and then follow the on-screen instructions.

– or –

Select **Main**, select **Ignore Changes and Exit**, and then press [enter](#).

To check for later BIOS versions, see [Downloading a BIOS update on page 83](#).

Downloading a BIOS update

 **CAUTION:** To reduce the risk of damage to the computer or an unsuccessful installation, download and install a BIOS update only when the computer is connected to reliable external power using the AC adapter. Do not download or install a BIOS update while the computer is running on battery power, docked in an optional docking device, or connected to an optional power source. During the download and installation, follow these instructions:

Do not disconnect power on the computer by unplugging the power cord from the AC outlet.

Do not shut down the computer or initiate Sleep.

Do not insert, remove, connect, or disconnect any device, cable, or cord.

1. Type `support` in the taskbar search box, and then select the HP Support Assistant app.
– or –
Select the question mark icon in the taskbar.
2. Select **Updates**, and then select **Check for updates and messages**.
3. Follow the on-screen instructions.
4. At the download area, follow these steps:
 - a. Identify the most recent BIOS update and compare it to the BIOS version currently installed on your computer. Make a note of the date, name, or other identifier. You may need this information to locate the update later, after it has been downloaded to your hard drive.
 - b. Follow the on-screen instructions to download your selection to the hard drive.

Make a note of the path to the location on your hard drive where the BIOS update is downloaded. You will need to access this path when you are ready to install the update.

 **NOTE:** If you connect your computer to a network, consult the network administrator before installing any software updates, especially system BIOS updates.

BIOS installation procedures vary. Follow any instructions that are displayed on the screen after the download is complete. If no instructions are displayed, follow these steps:

1. Type `file` in the taskbar search box, and then select **File Explorer**.
2. Select your hard drive designation. The hard drive designation is typically Local Disk (C:).
3. Using the hard drive path you recorded earlier, open the folder that contains the update.
4. Double-click the file that has an `.exe` extension (for example, *filename.exe*).

The BIOS installation begins.
5. Complete the installation by following the on-screen instructions.



NOTE: After a message on the screen reports a successful installation, you can delete the downloaded file from your hard drive.

Changing the boot order using the f9 prompt

To dynamically choose a boot device for the current startup sequence, follow these steps:

1. Access the Boot Device Options menu:
 - Turn on or restart the computer, and when the HP logo appears, press **f9** to enter the Boot Device Options menu.
2. Select a boot device, press **enter**, and then follow the on-screen instructions.

TPM BIOS settings (select products only)



IMPORTANT: Before enabling Trusted Platform Module (TPM) functionality on this system, you must ensure that your intended use of TPM complies with relevant local laws, regulations and policies, and approvals or licenses must be obtained if applicable. For any compliance issues arising from your operation/usage of TPM which violates the above mentioned requirement, you shall bear all the liabilities wholly and solely. HP will not be responsible for any related liabilities.

TPM provides additional security for your computer. You can modify the TPM settings in Computer Setup (BIOS).



NOTE: If you change the TPM setting to Hidden, TPM is not visible in the operating system.

To access TPM settings in Computer Setup:

1. Start Computer Setup. See [Starting Computer Setup on page 81](#).
2. Select **Security**, select **TPM Embedded Security**, and then follow the on-screen instructions.

Using HP Sure Start (select products only)

Select computer models are configured with HP Sure Start, a technology that monitors the computer's BIOS for attacks or corruption. If the BIOS becomes corrupted or is attacked, HP Sure Start automatically restores the BIOS to its previously safe state, without user intervention.

HP Sure Start is configured and already enabled so that most users can use the HP Sure Start default configuration. The default configuration can be customized by advanced users.

To access the latest documentation on HP Sure Start, go to <http://www.hp.com/support>. Select **Find your product**, and then follow the on-screen instructions.

8 Using HP PC Hardware Diagnostics

Using HP PC Hardware Diagnostics Windows

HP PC Hardware Diagnostics Windows is a Windows-based utility that allows you to run diagnostic tests to determine whether the computer hardware is functioning properly. The tool runs within the Windows operating system in order to diagnose hardware failures.

If HP PC Hardware Diagnostics Windows is not installed on your computer, first you must download and install it. To download HP PC Hardware Diagnostics Windows, see [Downloading HP PC Hardware Diagnostics Windows on page 85](#).

After HP PC Hardware Diagnostics Windows is installed, follow these steps to access it from HP Help and Support or HP Support Assistant.

1. To access HP PC Hardware Diagnostics Windows from HP Help and Support:
 - a. Select the **Start** button, and then select **HP Help and Support**.
 - b. Right-click **HP PC Hardware Diagnostics Windows**, select **More**, and then select **Run as administrator**.

– or –

To access HP PC Hardware Diagnostics Windows from HP Support Assistant:

- a. Type `support` in the taskbar search box, and then select the **HP Support Assistant** app.

– or –

Select the question mark icon in the taskbar.
 - b. Select **Troubleshooting and fixes**.
 - c. Select **Diagnostics**, and then select **HP PC Hardware Diagnostics Windows**.
2. When the tool opens, select the type of diagnostic test you want to run, and then follow the on-screen instructions.



NOTE: If you need to stop a diagnostic test at any time, select **Cancel**.

3. When HP PC Hardware Diagnostics Windows detects a failure that requires hardware replacement, a 24-digit Failure ID code is generated. For assistance in correcting the problem, contact support, and then provide the Failure ID code.

Downloading HP PC Hardware Diagnostics Windows

- The HP PC Hardware Diagnostics Windows download instructions are provided in English only.
- You must use a Windows computer to download this tool because only .exe files are provided.

Downloading the latest HP PC Hardware Diagnostics Windows version

To download HP PC Hardware Diagnostics Windows, follow these steps:

1. Go to <http://www.hp.com/go/techcenter/pcdiags>. The HP PC Diagnostics home page is displayed.
2. In the **HP PC Hardware Diagnostics** section, select **Download**, and then select the installation location:
To run the tool on your computer, download it to the computer desktop.
– or –
To run the tool from a USB flash drive, download it to a USB flash drive.
3. Select **Run**.

Downloading HP Hardware Diagnostics Windows by product name or number (select products only)



NOTE: For some products, it may be necessary to download the software to a USB flash drive by using the product name or number.

To download HP PC Hardware Diagnostics Windows by product name or number (select products only), follow these steps:

1. Go to <http://www.hp.com/support>.
2. Select **Get software and drivers**, and then enter the product name or number.
3. In the **HP PC Hardware Diagnostics** section, select **Download**, and then select the installation location:
To run the tool on your computer, download it to the computer desktop.
– or –
To run the tool from a USB flash drive, download it to a USB flash drive.
4. Select **Run**.

Installing HP PC Hardware Diagnostics Windows

To install HP PC Hardware Diagnostics Windows, follow these steps:

- ▲ Navigate to the folder on your computer or the flash drive where the .exe file was downloaded, double-click the .exe file, and then follow the on-screen instructions.

Using HP PC Hardware Diagnostics UEFI

HP PC Hardware Diagnostics UEFI (Unified Extensible Firmware Interface) allows you to run diagnostic tests to determine whether the computer hardware is functioning properly. The tool runs outside the operating system so that it can isolate hardware failures from issues that are caused by the operating system or other software components.

If your PC will not boot into Windows, you can use HP PC Hardware Diagnostics UEFI to diagnose hardware issues.

When HP PC Hardware Diagnostics UEFI detects a failure that requires hardware replacement, a 24-digit Failure ID code is generated. For assistance in correcting the problem, contact support, and provide the Failure ID code.



NOTE: To start diagnostics on a convertible computer, your computer must be in notebook mode, and you must use the attached keyboard.

 **NOTE:** If you need to stop a diagnostic test, press [esc](#).

Starting HP PC Hardware Diagnostics UEFI

To start HP PC Hardware Diagnostics UEFI, follow these steps:

1. Turn on or restart the computer, and quickly press [esc](#).
2. Press [f2](#).

The BIOS searches three places for the diagnostic tools, in the following order:

- a. Connected USB flash drive



NOTE: To download the HP PC Hardware Diagnostics UEFI tool to a USB flash drive, see [Downloading the latest HP PC Hardware Diagnostics UEFI version on page 87](#).

- b. Hard drive
- c. BIOS

3. When the diagnostic tool opens, select the type of diagnostic test you want to run, and then follow the on-screen instructions.

Downloading HP PC Hardware Diagnostics UEFI to a USB flash drive

Downloading HP PC Hardware Diagnostics UEFI to a USB flash drive can be useful in the following situations:

- HP PC Hardware Diagnostics UEFI is not included in the preinstall image.
- HP PC Hardware Diagnostics UEFI is not included in the HP Tool partition.
- The hard drive is damaged.



NOTE: The HP PC Hardware Diagnostics UEFI download instructions are provided in English only, and you must use a Windows computer to download and create the HP UEFI support environment because only .exe files are provided.

Downloading the latest HP PC Hardware Diagnostics UEFI version

To download the latest HP PC Hardware Diagnostics UEFI version to a USB flash drive:

1. Go to <http://www.hp.com/go/techcenter/pcdiags>. The HP PC Diagnostics home page is displayed.
2. In the **HP PC Hardware Diagnostics UEFI** section, select **Download UEFI Diagnostics**, and then select **Run**.

Downloading HP PC Hardware Diagnostics UEFI by product name or number (select products only)



NOTE: For some products, it may be necessary to download the software to a USB flash drive by using the product name or number.

To download HP PC Hardware Diagnostics UEFI by product name or number (select products only) to a USB flash drive:

1. Go to <http://www.hp.com/support>.
2. Enter the product name or number, select your computer, and then select your operating system.
3. In the **Diagnostics** section, follow the on-screen instructions to select and download the specific UEFI Diagnostics version for your computer.

Using Remote HP PC Hardware Diagnostics UEFI settings (select products only)

Remote HP PC Hardware Diagnostics UEFI is a firmware (BIOS) feature that downloads HP PC Hardware Diagnostics UEFI to your computer. It can then execute the diagnostics on your computer, and it may upload results to a preconfigured server. For more information on Remote HP PC Hardware Diagnostics UEFI, go to <http://www.hp.com/go/techcenter/pcdiags>, and then select **Find out more**.

Downloading Remote HP PC Hardware Diagnostics UEFI

 **NOTE:** HP Remote PC Hardware Diagnostics UEFI is also available as a Softpaq that can be downloaded to a server.

Downloading the latest Remote HP PC Hardware Diagnostics UEFI version

To download the latest Remote HP PC Hardware Diagnostics UEFI version, follow these steps:

1. Go to <http://www.hp.com/go/techcenter/pcdiags>. The HP PC Diagnostics home page is displayed.
2. In the **HP PC Hardware Diagnostics UEFI** section, select **Download Remote Diagnostics**, and then select **Run**.

Downloading Remote HP PC Hardware Diagnostics UEFI by product name or number

 **NOTE:** For some products, it may be necessary to download the software by using the product name or number.

To download HP Remote PC Hardware Diagnostics UEFI by product name or number, follow these steps:

1. Go to <http://www.hp.com/support>.
2. Select **Get software and drivers**, enter the product name or number, select your computer, and then select your operating system.
3. In the **Diagnostics** section, follow the on-screen instructions to select and download the **Remote UEFI** version for the product.

Customizing Remote HP PC Hardware Diagnostics UEFI settings

Using the Remote HP PC Hardware Diagnostics setting in Computer Setup (BIOS), you can perform the following customizations:

- Set a schedule for running diagnostics unattended. You can also start diagnostics immediately in interactive mode by selecting **Execute Remote HP PC Hardware Diagnostics**.
- Set the location for downloading the diagnostic tools. This feature provides access to the tools from the HP website or from a server that has been preconfigured for use. Your computer does not require the traditional local storage (such as a disk drive or USB flash drive) to run remote diagnostics.
- Set a location for storing the test results. You can also set the user name and password settings used for uploads.
- Display status information about the diagnostics run previously.

To customize Remote HP PC Hardware Diagnostics UEFI settings, follow these steps:

1. Turn on or restart the computer, and when the HP logo appears, press **f10** to enter Computer Setup.
2. Select **Advanced**, and then select **Settings**.

3. Make your customization selections.
4. Select **Main**, and then **Save Changes and Exit** to save your settings.

Your changes take effect when the computer restarts.

9 Backing up, restoring, and recovering

This chapter provides information about the following processes. The information in the chapter is standard procedure for most products.

- Creating recovery media and backups
- Restoring and recovering your system

For additional information, refer to the HP Support Assistant app.

▲ Type `support` in the taskbar search box, and then select the **HP Support Assistant** app.

– or –

Select the question mark icon in the taskbar.



IMPORTANT: If you will be performing recovery procedures on a tablet, the tablet battery must be at least 70% charged before you start the recovery process.

IMPORTANT: For a tablet with a detachable keyboard, connect the tablet to the keyboard base before beginning any recovery process.

Creating recovery media and backups

The following methods of creating recovery media and backups are available on select products only. Choose the available method according to your computer model.

- Use HP Recovery Manager to create HP Recovery media after you successfully set up the computer. This step creates a backup of the HP Recovery partition on the computer. The backup can be used to reinstall the original operating system in cases where the hard drive is corrupted or has been replaced. For information on creating recovery media, see [Creating HP Recovery media \(select products only\) on page 90](#). For information on the recovery options that are available using the recovery media, see [Using Windows tools on page 91](#).
- Use Windows tools to create system restore points and create backups of personal information.

For more information, see [Recovering using HP Recovery Manager on page 92](#).



NOTE: If storage is 32 GB or less, Microsoft System Restore is disabled by default.

Creating HP Recovery media (select products only)

If possible, check for the presence of the Recovery partition and the Windows partition. From the **Start** menu, select **File Explorer**, and then select **This PC**.

- If your computer does not list the Windows partition and the Recovery partition, you can obtain recovery media for your system from support. See the *Worldwide Telephone Numbers* booklet included with the computer. You can also find contact information on the HP website. Go to <http://www.hp.com/support>, select your country or region, and follow the on-screen instructions.

You can use Windows tools to create system restore points and create backups of personal information, see [Using Windows tools on page 91](#).

- If your computer does list the Recovery partition and the Windows partition, you can use HP Recovery Manager to create recovery media after you successfully set up the computer. HP Recovery media can be used to perform system recovery if the hard drive becomes corrupted. System recovery reinstalls the original operating system and software programs that were installed at the factory and then configures the settings for the programs. HP Recovery media can also be used to customize the system or restore the factory image if you replace the hard drive.
 - Only one set of recovery media can be created. Handle these recovery tools carefully, and keep them in a safe place.
 - HP Recovery Manager examines the computer and determines the required storage capacity for the media that will be required.
 - To create recovery discs, your computer must have an optical drive with DVD writer capability, and you must use only high-quality blank DVD-R, DVD+R, DVD-R DL, or DVD+R DL discs. Do not use rewritable discs such as CD±RW, DVD±RW, double-layer DVD±RW, or BD-RE (rewritable Blu-ray) discs; they are not compatible with HP Recovery Manager software. Or, instead, you can use a high-quality blank USB flash drive.
 - If your computer does not include an integrated optical drive with DVD writer capability, but you would like to create DVD recovery media, you can use an external optical drive (purchased separately) to create recovery discs. If you use an external optical drive, it must be connected directly to a USB port on the computer; the drive cannot be connected to a USB port on an external device, such as a USB hub. If you cannot create DVD media yourself, you can obtain recovery discs for your computer from HP. See the *Worldwide Telephone Numbers* booklet included with the computer. You can also find contact information on the HP website. Go to <http://www.hp.com/support>, select your country or region, and follow the on-screen instructions.
 - Be sure that the computer is connected to AC power before you begin creating the recovery media.
 - The creation process can take an hour or more. Do not interrupt the creation process.
 - If necessary, you can exit the program before you have finished creating all of the recovery DVDs. HP Recovery Manager will finish burning the current DVD. The next time you start HP Recovery Manager, you will be prompted to continue.

To create HP Recovery media:

 **IMPORTANT:** For a tablet with a detachable keyboard, connect the tablet to the keyboard base before beginning these steps.

1. Type `recovery` in the taskbar search box, and then select **HP Recovery Manager**.
2. Select **Create recovery media**, and then follow the on-screen instructions.

If you ever need to recover the system, see [Recovering using HP Recovery Manager on page 92](#).

Using Windows tools

You can create recovery media, system restore points, and backups of personal information using Windows tools.

 **NOTE:** If storage is 32 GB or less, Microsoft System Restore is disabled by default.

For more information and steps, see the Get started app.

- ▲ Select the **Start** button, and then select the **Get started** app.

Restore and recovery

There are several options for recovering your system. Choose the method that best matches your situation and level of expertise:

 **IMPORTANT:** Not all methods are available on all products.

- Windows offers several options for restoring from backup, refreshing the computer, and resetting the computer to its original state. For more information see the Get started app.
 - ▲ Select the **Start** button, and then select the **Get started** app.
- If you need to correct a problem with a preinstalled application or driver, use the Reinstall drivers and/or applications option (select products only) of HP Recovery Manager to reinstall the individual application or driver.
 - ▲ Type `recovery` in the taskbar search box, select **HP Recovery Manager**, select **Reinstall drivers and/or applications**, and then follow the on-screen instructions.
- If you want to recover the Windows partition to original factory content, you can choose the System Recovery option from the HP Recovery partition (select products only) or use the HP Recovery media. For more information, see [Recovering using HP Recovery Manager on page 92](#). If you have not already created recovery media, see [Creating HP Recovery media \(select products only\) on page 90](#).
- On select products, if you want to recover the computer's original factory partition and content, or if you have replaced the hard drive, you can use the Factory Reset option of HP Recovery media. For more information, see [Recovering using HP Recovery Manager on page 92](#).
- On select products, if you want to remove the Recovery partition to reclaim hard drive space, HP Recovery Manager offers the Remove Recovery Partition option.

For more information, see [Removing the HP Recovery partition \(select products only\) on page 95](#).

Recovering using HP Recovery Manager

HP Recovery Manager software allows you to recover the computer to its original factory state by using the HP Recovery media that you either created or that you obtained from HP, or by using the HP Recovery partition (select products only). If you have not already created recovery media, see [Creating HP Recovery media \(select products only\) on page 90](#).

What you need to know before you get started

- HP Recovery Manager recovers only software that was installed at the factory. For software not provided with this computer, you must either download the software from the manufacturer's website or reinstall the software from the media provided by the manufacturer.

 **IMPORTANT:** Recovery through HP Recovery Manager should be used as a final attempt to correct computer issues.

- HP Recovery media must be used if the computer hard drive fails. If you have not already created recovery media, see [Creating HP Recovery media \(select products only\) on page 90](#).
- To use the Factory Reset option (select products only), you must use HP Recovery media. If you have not already created recovery media, see [Creating HP Recovery media \(select products only\) on page 90](#).
- If your computer does not allow the creation of HP Recovery media or if the HP Recovery media does not work, you can obtain recovery media for your system from support. See the *Worldwide Telephone Numbers* booklet included with the computer. You can also find contact information from the HP

website. Go to <http://www.hp.com/support>, select your country or region, and follow the on-screen instructions.

 **IMPORTANT:** HP Recovery Manager does not automatically provide backups of your personal data. Before beginning recovery, back up any personal data you want to retain.

Using HP Recovery media, you can choose from one of the following recovery options:

 **NOTE:** Only the options available for your computer display when you start the recovery process.

- System Recovery—Reinstalls the original operating system, and then configures the settings for the programs that were installed at the factory.
- Factory Reset—Restores the computer to its original factory state by deleting all information from the hard drive and re-creating the partitions. Then it reinstalls the operating system and the software that was installed at the factory.

The HP Recovery partition (select products only) allows System Recovery only.

Using the HP Recovery partition (select products only)

The HP Recovery partition allows you to perform a system recovery without the need for recovery discs or a recovery USB flash drive. This type of recovery can be used only if the hard drive is still working.

To start HP Recovery Manager from the HP Recovery partition:

 **IMPORTANT:** For a tablet with a detachable keyboard, connect the tablet to the keyboard base before beginning these steps (select products only).

1. Type `recovery` in the taskbar search box, select **Recovery Manager**, and then select **HP Recovery Environment**.

– or –

For computers or tablets with keyboards attached, press **f11** while the computer boots, or press and hold **f11** as you press the power button.

For tablets without keyboards:

- Turn on or restart the tablet, and then quickly hold down the volume up button; then select **f11**.
- or –
- Turn on or restart the tablet, and then quickly hold down the volume down button; then select **f11**.
2. Select **Troubleshoot** from the boot options menu.
 3. Select **Recovery Manager**, and then follow the on-screen instructions.

Using HP Recovery media to recover

You can use HP Recovery media to recover the original system. This method can be used if your system does not have an HP Recovery partition or if the hard drive is not working properly.

1. If possible, back up all personal files.
2. Insert the HP Recovery media, and then restart the computer.

 **NOTE:** If the computer does not automatically restart in HP Recovery Manager, change the computer boot order. See [Changing the computer boot order on page 94](#).

3. Follow the on-screen instructions.

Changing the computer boot order

If your computer does not restart in HP Recovery Manager, you can change the computer boot order, which is the order of devices listed in BIOS where the computer looks for startup information. You can change the selection to an optical drive or a USB flash drive.

To change the boot order:



IMPORTANT: For a tablet with a detachable keyboard, connect the tablet to the keyboard base before beginning these steps.

1. Insert the HP Recovery media.
2. Access the system **Startup** menu.

For computers or tablets with keyboards attached:

- ▲ Turn on or restart the computer or tablet, quickly press **esc**, and then press **f9** for boot options.

For tablets without keyboards:

- ▲ Turn on or restart the tablet, and then quickly hold down the volume up button; then select **f9**.

– or –

Turn on or restart the tablet, and then quickly hold down the volume down button; then select **f9**.

3. Select the optical drive or USB flash drive from which you want to boot.
4. Follow the on-screen instructions.

Removing the HP Recovery partition (select products only)

HP Recovery Manager software allows you to remove the HP Recovery partition to free up hard drive space.



IMPORTANT: After you remove the HP Recovery partition, you will not be able to perform System Recovery or create HP Recovery media from the HP Recovery partition. So before you remove the Recovery partition, create HP Recovery media; see [Creating HP Recovery media \(select products only\) on page 90](#).



NOTE: The Remove Recovery Partition option is only available on products that support this function.

Follow these steps to remove the HP Recovery partition:

1. Type `recovery` in the taskbar search box, and then select **HP Recovery Manager**.
2. Select **Remove Recovery Partition**, and then follow the on-screen instructions.

10 Specifications

Computer specifications

	Metric	U.S.
Dimensions		
Length	257.0 mm	10.12 in
Width	377.0 mm	14.85 in
Height (non-touch)	23.95 mm	0.95 in
Height (touch)	24.95 mm	0.99 in
Weight		
3-cell battery, UMA, no fingerprint reader, 1 SODIMM, WLAN, SSD, TouchPad, no camera, no WWAN, non-touch display	2.18 kg	4.8 lbs
3-cell battery, UMA, no fingerprint reader, no smart card, 1 SODIMM, WLAN, with WWAN antenna, SSD, TouchPad, camera, no WWAN, no NFC, touch display	2.40 kg	5.29 lbs
Input power		
Operating voltage	19.0 V dc @ 4.74 A – 90 W or 18.5 V dc @ 3.5 A - 65 W or 45 W	
Operating current	4.74 A or 3.5 A	
Temperature		
Operating (not writing to optical disc)	0°C to 35°C	32°F to 95°F
Operating (writing to optical disc)	5°C to 35°C	41°F to 95°F
Nonoperating	-20°C to 60°C	-4°F to 140°F
Relative humidity		
Operating	10% to 90%	
Nonoperating	5% to 95%	
Maximum altitude (unpressurized)		
Operating (14.7 to 10.1 psia)	-15 m to 3,048 m	50 ft to 10,000 ft
Nonoperating (14.7 to 4.4 psia)	-15 m to 12,192 m	-50 ft to 40,000 ft
Shock		
Operating	125 g, 2 ms, half-sine	
Nonoperating	200 g, 2 ms, half-sine	
Random vibration		
Operating	0.75 g zero-to-peak, 10 Hz to 500 Hz, 0.25 oct/min sweep rate	

	Metric	U.S.
Nonoperating	1.50 g zero-to-peak, 10 Hz to 500 Hz, 0.5 oct/min sweep rate	

NOTE: Applicable product safety standards specify thermal limits for plastic surfaces. The computer operates well within this range of temperatures.

35.6-cm (14.0-in) display specifications

	Metric	U.S.
Active diagonal size	35.6-cm	14.0-in
Resolution	FHD: 1920×1080 HD: 1366×768	
Surface treatment	Anti-glare (except touch screen)	
Brightness	45% CG: 220 nits	
Viewing angle	SVA IPS	
Backlight	LED	
Aspect ratio	16:9	
Display panel interface	eDP 1.2	

M.2 PCIe solid-state drive specifications

	256-GB*	512-GB*	1-TB*
Dimensions			
Height	1 mm	1 mm	1 mm
Length	50.8 mm	50.8 mm	50.8 mm
Width	28.9 mm	28.9 mm	28.9 mm
Weight	< 10 g	< 10 g	< 10 g
Interface type	ATA-7	ATA-7	ATA-7
Transfer rate			
Sequential Read	Up to 2150 MB/s	Up to 2150 MB/s	Up to 2150 MB/s
Random Read	Up to 300,000 IOPs	Up to 300,000 IOPs	Up to 300,000 IOPs
Sequential Write	Up to 1260 MB/s	Up to 1550 MB/s	Up to 1550 MB/s
Random Write	Up to 100,000 IOPs	Up to 100,000 IOPs	Up to 100,000 IOPs
Ready time, Maximum (to not busy)	1.0 s	1.0 s	1.0 s
Access times			
Logical	0.1	0.1	0.1
Total logical sectors	500,118,192	1,000,215,216	1,500,336,388
Operating temperature			
Operating	0° to 70°C (32°F to 158°F)	0° to 70°C (32°F to 158°F)	0° to 70°C (32°F to 158°F)
Non-operating	-40° to 80°C (-40°F to 176°F)	-40° to 85°C (-40°F to 185°F)	-40° to 85°C (-40°F to 185°F)
*1 GB = 1 billion bytes when referring to hard drive storage capacity. Actual accessible capacity is less.			
NOTE: Certain restrictions and exclusions apply. Contact technical support for details.			

M.2 SATA solid-state drive specifications

	128-GB*	256-GB*	512-GB*
Height	1.35 mm	1.35 mm	1.35 mm
Weight	< 10 g	< 10 g	< 10 g
Form factor	M.2 2280-D2-B-M	M.2 2280-D2-B-M	M.2 2280-D2-B-M
Transfer rate	up to 540 MB/sec	up to 540 MB/sec	up to 540 MB/sec
Interface type	SATA-3	SATA-3	SATA-3
Ready time, maximum (to not busy)	1.0 ms	< 1.0 ms	< 1.0 ms
Access times, logical	0.1 ms	0.1 ms	0.1 ms
Total logical sectors	234,441,648	468,883,296	937,766,592
Operating temperature	0°C to 70°C (32°F to 158°F)		

*1 GB = 1 billion bytes when referring to hard drive storage capacity. Actual accessible capacity is less. Actual drive specifications may differ slightly.

NOTE: Certain restrictions and exclusions apply. Contact technical support for details.

Hard drive specifications

	1-TB*	500-GB*
Dimensions		
Height	7.0 mm or 9.5 mm	7.0 mm
Length	100.4 mm	100.6 mm
Width	69.9 mm	70.1 mm
Weight	107.0 g	92.0 g
Interface type	SATA	SATA
Transfer rate		
Synchronous (maximum)	300 MB/sec	300 MB/sec
Security	ATA security	ATA security
Seek times (typical read, including setting)		
Single track	2.0 ms	3 ms
Average (read/write)	12 ms	13 ms
Maximum	22 ms	24 ms
Logical blocks	1,953,525,168	1,048,576,000
Disk rotational speed	5400 rpm	5400 rpm
Operating temperature		
*1 GB = 1 billion bytes when referring to hard drive storage capacity. Actual accessible capacity is less.		
NOTE: Certain restrictions and exclusions apply. Contact technical support for details.		

11 Power cord set requirements

The wide-range input feature of the computer permits it to operate from any line voltage from 100 to 120 volts AC, or from 220 to 240 volts AC.

The 3-conductor power cord set included with the computer meets the requirements for use in the country or region where the equipment is purchased.

Power cord sets for use in other countries and regions must meet the requirements of the country or region where the computer is used.

Requirements for all countries

The following requirements are applicable to all countries and regions:

- The length of the power cord set must be at least **1.0 m** (3.3 ft) and no more than **2.0 m** (6.5 ft).
- All power cord sets must be approved by an acceptable accredited agency responsible for evaluation in the country or region where the power cord set will be used.
- The power cord sets must have a minimum current capacity of 10 amps and a nominal voltage rating of 125 or 250 V AC, as required by the power system of each country or region.
- The appliance coupler must meet the mechanical configuration of an EN 60 320/IEC 320 Standard Sheet C13 connector for mating with the appliance inlet on the back of the computer.

Requirements for specific countries and regions

Country/region	Accredited agency	Applicable note number
Australia	EANSW	1
Austria	OVE	1
Belgium	CEBC	1
Canada	CSA	2
Denmark	DEMKO	1
Finland	FIMKO	1
France	UTE	1
Germany	VDE	1
Italy	IMQ	1
Japan	METI	3
The Netherlands	KEMA	1
Norway	NEMKO	1
The People's Republic of China	COC	5
South Korea	EK	4

Country/region	Accredited agency	Applicable note number
Sweden	SEMKO	1
Switzerland	SEV	1
Taiwan	BSMI	4
The United Kingdom	BSI	1
The United States	UL	2

1. The flexible cord must be Type H05VV-F, 3-conductor, 1.0-mm² conductor size. Power cord set fittings (appliance coupler and wall plug) must bear the certification mark of the agency responsible for evaluation in the country or region where it will be used.
2. The flexible cord must be Type SPT-3 or equivalent, No. 18 AWG, 3-conductor. The wall plug must be a two-pole grounding type with a NEMA 5-15P (15 A, 125 V) or NEMA 6-15P (15 A, 250 V) configuration.
3. The appliance coupler, flexible cord, and wall plug must bear a “T” mark and registration number in accordance with the Japanese Dentori Law. The flexible cord must be Type VCT or VCTF, 3-conductor, 1.00-mm² conductor size. The wall plug must be a two-pole grounding type with a Japanese Industrial Standard C8303 (7 A, 125 V) configuration.
4. The flexible cord must be Type RVV, 3-conductor, 0.75-mm² conductor size. Power cord set fittings (appliance coupler and wall plug) must bear the certification mark of the agency responsible for evaluation in the country or region where it will be used.
5. The flexible cord must be Type VCTF, 3-conductor, 0.75-mm² conductor size. Power cord set fittings (appliance coupler and wall plug) must bear the certification mark of the agency responsible for evaluation in the country or region where it will be used.

12 Statement of memory volatility

The purpose of this chapter is to provide general information regarding nonvolatile memory in HP Business computers. This chapter also provides general instructions for restoring nonvolatile memory that can contain personal data after the system has been powered off and the hard drive has been removed.

HP Business computer products that use Intel®-based or AMD®-based system boards contain volatile DDR memory. The amount of nonvolatile memory present in the system depends upon the system configuration. Intel-based and AMD-based system boards contain nonvolatile memory subcomponents as originally shipped from HP, assuming that no subsequent modifications have been made to the system and assuming that no applications, features, or functionality have been added to or installed on the system.

Following system shutdown and removal of all power sources from an HP Business computer system, personal data can remain on volatile system memory (DIMMs) for a finite period of time and will also remain in nonvolatile memory. Use the steps below to remove personal data from the computer, including the nonvolatile memory found in Intel-based and AMD-based system boards.

 **NOTE:** If your tablet has a keyboard base, connect to the keyboard base before beginning steps in this chapter.

Current BIOS steps

1. Follow steps (a) through (l) below to restore the nonvolatile memory that can contain personal data. Restoring or reprogramming nonvolatile memory that does not store personal data is neither necessary nor recommended.
 - a. Turn on or restart the computer, and then press **esc** while the “Press the ESC key for Startup Menu” message is displayed at the bottom of the screen.

 **NOTE:** If the system has a BIOS administrator password, enter the password at the prompt.
 - b. Select **Main**, select **Apply Factory Defaults and Exit**, and then select **Yes** to load defaults.
The computer will reboot.
 - c. During the reboot, press **esc** while the “Press the ESC key for Startup Menu” message is displayed at the bottom of the screen.

 **NOTE:** If the system has a BIOS administrator password, enter the password at the prompt.
 - d. Select the **Security** menu, select **Restore Security Settings to Factory Defaults**, and then select **Yes** to restore security level defaults.
The computer will reboot.
 - e. During the reboot, press **esc** while the “Press the ESC key for Startup Menu” message is displayed at the bottom of the screen.

 **NOTE:** If the system has a BIOS administrator password, enter the password at the prompt.
 - f. If an asset or ownership tag is set, select the **Security** menu and scroll down to the **Utilities** menu. Select **System IDs**, and then select **Asset Tracking Number**. Clear the tag, and then make the selection to return to the prior menu.

- g.** If a DriveLock password is set, select the **Security** menu, and scroll down to **Hard Drive Utilities** under the **Utilities** menu. Select **Hard Drive Utilities**, select **DriveLock**, then uncheck the checkbox for **DriveLock password on restart**. Select **OK** to proceed.
- h.** Select the **Main** menu, and then select **Reset BIOS Security to factory default**. Click **Yes** at the warning message.
The computer will reboot.
- i.** During the reboot, press **esc** while the “Press the ESC key for Startup Menu” message is displayed at the bottom of the screen.



NOTE: If the system has a BIOS administrator password, enter the password at the prompt.

- j.** Select the **Main** menu, select **Apply Factory Defaults and Exit**, select **Yes** to save changes and exit, and then select **Shutdown**.
 - k.** Reboot the system. If the system has a Trusted Platform Module (TPM) and/or fingerprint reader, one or two prompts will appear—one to clear the TPM and the other to Reset Fingerprint Sensor; press or tap **F1** to accept or **F2** to reject.
 - l.** Remove all power and system batteries for at least 24 hours.
- 2.** Complete one of the following:
- Remove and retain the storage drive.
 - or –
 - Clear the drive contents by using a third party utility designed to erase data from an SSD.
 - or –
 - Clear the contents of the drive by using the following BIOS Setup Secure Erase command option steps:



IMPORTANT: If you clear data using Secure Erase, it cannot be recovered.

- a.** Turn on or restart the computer, and then press **esc** while the “Press the ESC key for Startup Menu” message is displayed at the bottom of the screen.
- b.** Select the **Security** menu and scroll down to the **Utilities** menu.
- c.** Select **Hard Drive Utilities**.
- d.** Under **Utilities**, select **Secure Erase**, select the hard drive storing the data you want to clear, and then follow the on-screen instructions to continue.

Nonvolatile memory usage

Nonvolatile Memory Type	Amount (Size)	Does this memory store customer data?	Does this memory retain data when power is removed?	What is the purpose of this memory?	How is data input into this memory?	How is this memory write-protected?
HP Sure Start flash (select models only)	8 MBytes	No	Yes	Provides protected backup of critical System BIOS code, EC firmware, and critical computer configuration data for select platforms that support HP Sure Start. For more information, see Using HP Sure Start (select models only) on page 108 .	Data cannot be written to this device via the host processor. The content is managed solely by the HP Sure Start Embedded Controller.	This memory is protected by the HP Sure Start Embedded Controller.
Real Time Clock (RTC) battery backed-up CMOS configuration memory	256 Bytes	No	Yes	Stores system date and time and noncritical data.	RTC battery backed-up CMOS is programmed using the Computer Setup (BIOS), or changing the Microsoft Windows date & time.	This memory is not write-protected.
Controller (NIC) EEPROM	64 KBytes (not customer accessible)	No	Yes	Stores NIC configuration and NIC firmware.	NIC EEPROM is programmed using a utility from the NIC vendor that can be run from DOS.	A utility is required to write data to this memory and is available from the NIC vendor. Writing data to this ROM in an inappropriate manner will render the NIC non-functional.
DIMM Serial Presence Detect (SPD) configuration data	256 Bytes per memory module, 128 Bytes programmable (not customer accessible)	No	Yes	Stores memory module information.	DIMM SPD is programmed by the memory vendor.	Data cannot be written to this memory when the module is installed in a computer. The specific write-protection method varies by memory vendor.
System BIOS	9 MBytes	Yes	Yes	Stores system BIOS code and computer configuration data.	System BIOS code is programmed at the factory. Code is updated when the system BIOS is updated. Configuration data and settings are input using the Computer Setup (BIOS) or a custom utility.	NOTE: Writing data to this ROM in an inappropriate manner can render the computer non-functional. A utility is required for writing data to this memory and is available on the HP website; go to http://www.hp.com/support . Select Find your

Nonvolatile Memory Type	Amount (Size)	Does this memory store customer data?	Does this memory retain data when power is removed?	What is the purpose of this memory?	How is data input into this memory?	How is this memory write-protected?
Intel Management Engine Firmware (present only in select Elite or Z models. For more information, go to http://www.hp.com/support . Select Find your product , and then follow the on-screen instructions.)	1.5 MBytes or 7 MBytes	Yes	Yes	Stores Management Engine Code, Settings, Provisioning Data and iAMT third-party data store.	Management Engine Code is programmed at the factory. Code is updated via Intel secure firmware update utility. Unique Provisioning Data can be entered at the factory or by an administrator using the Management Engine (MEBx) setup utility. The third party data store contents can be populated by a remote management console or local applications that have been registered by an administrator to have access to the space.	product , and then follow the on-screen instructions. The Intel chipset is configured to enforce hardware protection to block all direct read/write access to this area. An Intel utility is required for updating the firmware. Only firmware updates digitally signed by Intel can be applied using this utility.
Bluetooth flash (select products only)	2 Mbit	No	Yes	Stores Bluetooth configuration and firmware.	Bluetooth flash is programmed at the factory. Tools for writing data to this memory are not publicly available but can be obtained from the silicon vendor.	A utility is required for writing data to this memory and is made available through newer versions of the driver whenever the flash requires an upgrade.
802.11 WLAN EEPROM	4 Kbit to 8 Kbit	No	Yes	Stores configuration and calibration data.	802.11 WLAN EEPROM is programmed at the factory. Tools for writing data to this memory are not made public.	A utility is required for writing data to this memory and is typically not made available to the public unless a firmware upgrade is necessary to address a unique issue.
Camera (select products only)	64 Kbit	No	Yes	Stores camera configuration and firmware.	Camera memory is programmed using a utility from the device manufacturer that can be run from Windows.	A utility is required for writing data to this memory and is typically not made available to the public unless a firmware upgrade is necessary to address a unique issue.
Fingerprint reader (select products only)	512 KByte flash	Yes	Yes	Stores fingerprint templates.	Fingerprint reader memory is programmed by user enrollment in HP ProtectTools Security Manager.	Only a digitally signed application can make the call to write to the flash.

Questions and answers

1. How can the BIOS settings be restored (returned to factory settings)?



IMPORTANT: Restore defaults does not securely erase any data on your hard drive. See question and answer 6 for steps to securely erase data.

Restore defaults does not reset the Custom Secure Boot keys. See question and answer 7 for information about resetting the keys.

- a. Turn on or restart the computer, and then press **esc** while the “Press the ESC key for Startup Menu” message is displayed at the bottom of the screen.
- b. Select **Main**, and then select **Apply Factory Defaults and Exit**.
- c. Follow the on-screen instructions.
- d. Select **Main**, select **Save Changes and Exit**, and then follow the on-screen instructions.

2. What is a UEFI BIOS, and how is it different from a legacy BIOS?

The Unified Extensible Firmware Interface (UEFI) BIOS is an industry-standard software interface between the platform firmware and an operating system (OS). It is a replacement for the older BIOS architecture, but supports much of the legacy BIOS functionality.

Like the legacy BIOS, the UEFI BIOS provides an interface to display the system information and configuration settings and to change the configuration of your computer before an OS is loaded. BIOS provides a secure run-time environment that supports a Graphic User Interface (GUI). In this environment, you can use either a pointing device (Touchscreen, TouchPad, pointing stick, or USB mouse) or the keyboard to navigate and make menu and configuration selections. The UEFI BIOS also contains basic system diagnostics.

The UEFI BIOS provides functionality beyond that of the legacy BIOS. In addition, the UEFI BIOS works to initialize the computer’s hardware before loading and executing the OS; the run-time environment allows the loading and execution of software programs from storage devices to provide more functionality, such as advanced hardware diagnostics (with the ability to display more detailed system information) and advanced firmware management and recovery software.

HP has provided options in Computer Setup (BIOS) to allow you to run in legacy BIOS, if required by the operating system. Examples of this requirement would be if you upgrade or downgrade the OS.

3. Where does the UEFI BIOS reside?

The UEFI BIOS resides on a flash memory chip. A utility is required to write to the chip.

4. What kind of configuration data is stored on the DIMM Serial Presence Detect (SPD) memory module? How would this data be written?

The DIMM SPD memory contains information about the memory module, such as size, serial number, data width, speed/timing, voltage, and thermal information. This information is written by the module manufacturer and stored on an EEPROM. This EEPROM cannot be written to when the memory module is installed in a computer. Third-party tools do exist that can write to the EEPROM when the memory module is not installed in a computer. Various third-party tools are available to read SPD memory.

5. What is meant by “Restore the nonvolatile memory found in Intel-based system boards”?

This message relates to clearing the Real Time Clock (RTC) CMOS memory that contains computer configuration data.

6. How can the BIOS security be reset to factory defaults and data erased?

 **IMPORTANT:** Resetting will result in the loss of information.

These steps will not reset Custom Secure Boot Keys. See question and answer 7 for information about resetting the keys.

- a. Turn on or restart the computer, and then press **esc** while the “Press the ESC key for Startup Menu” message is displayed at the bottom of the screen.
- b. Select **Main**, and then select **Reset Security to Factory Defaults**.
- c. Follow the on-screen instructions.
- d. Select **Main**, select **Save Changes and Exit**, and then follow the on-screen instructions.

7. How can the Custom Secure Boot Keys be reset?

Secure Boot is a feature to ensure that only authenticated code can start on a platform. If you enabled Secure Boot and created Custom Secure Boot Keys, simply disabling Secure Boot will not clear the keys. You must also select to clear the Custom Secure Boot Keys. Use the same Secure Boot access procedure you used to create the Custom Secure Boot Keys, but make the selection to clear or delete all Secure Boot Keys.

- a. Turn on or restart the computer, and then press **esc** while the “Press the ESC key for Startup Menu” message is displayed at the bottom of the screen.
- b. Select the **Security** menu, select **Secure Boot Configuration**, and then follow the on-screen instructions.
- c. At the **Secure Boot Configuration** window, select **Secure Boot**, select **Clear Secure Boot Keys**, and then follow the on-screen instructions to continue.

Using HP Sure Start (select models only)

Select computer models are configured with HP Sure Start, a technology that continuously monitors your computer's BIOS for attacks or corruption. If the BIOS becomes corrupted or is attacked, HP Sure Start restores the BIOS to its previously safe state, without user intervention. Those select computer models ship with HP Sure Start configured and enabled. HP Sure Start is configured and already enabled so that most users can use the HP Sure Start default configuration. The default configuration can be customized by advanced users.

To access the latest documentation on HP Sure Start, go to <http://www.hp.com/support>. Select **Find your product**, and then follow the on-screen instructions.

13 Recycling

When a non-rechargeable or rechargeable battery has reached the end of its useful life, do not dispose of the battery in general household waste. Follow the local laws and regulations in your area for battery disposal.

HP encourages customers to recycle used electronic hardware, HP original print cartridges, and rechargeable batteries. For more information about recycling programs, see the HP Web site at <http://www.hp.com/recycle>.

Index

- A**
 - AC adapter, spare part numbers 25
 - action keys 14
 - identifying 14
 - keyboard backlight 14
 - mute 14
 - next 14
 - pause 14
 - play 14
 - privacy screen 14
 - screen brightness 14
 - speaker volume 14
 - stop 14
 - switch screen image 15
 - using 14
 - wireless 14
 - audio
 - adjusting volume 14
 - audio, product description 2
 - audio-out (headphone)/audio-in (microphone) combo jack, identifying 8
- B**
 - back cover
 - spare part number 23
 - backups 90
 - battery
 - removal 34
 - spare part number 20, 34
 - battery light 7
 - BIOS
 - determining version 82
 - downloading an update 83
 - updating 82
 - Bluetooth label 17
 - boot order
 - changing 94
 - changing using the f9 prompt 84
 - bottom 17
 - bottom cover
 - removal 33
 - spare part number 20, 33
 - buttons
 - left TouchPad 10
 - power 12
 - right TouchPad 10
- C**
 - camera 9
 - identifying 9
 - removal 75
 - camera light, identifying 9
 - camera module
 - spare part number 23
 - camera shutter
 - spare part number 22
 - caps lock light, identifying 11
 - chipset, product description 1
 - components
 - bottom 16
 - display 9
 - keyboard area 10
 - left side 8
 - right side 6
 - computer major components 18
 - Computer Setup
 - navigating and selecting 81
 - restoring factory settings 82
 - using a USB keyboard or USB mouse to start Computer Setup 81
 - computer setup 81
 - computer specifications 96
 - connector, power 7
- D**
 - Display assembly
 - spare part numbers 19
 - display assembly
 - removal 73
 - subcomponents 22
 - display assembly components
 - removal 73
 - spare part numbers 73
 - display bezel
 - removal 74
 - spare part numbers 22, 74
 - display cable, spare part number 23
 - display components 9
 - display panel
 - product description 1
 - removal 75
 - display specifications 97
 - docking
 - product description 3
 - docking connector, identifying 7
 - drive light, identifying 6
- E**
 - embedded numeric keypad, identifying 13
 - esc key, identifying 13
 - ethernet
 - product description 2
 - external monitor port, identifying 7
- F**
 - fan
 - removal 50
 - spare part number 20, 50
 - fingerprint reader assembly
 - removal 71
 - spare part numbers 71
 - fingerprint reader board
 - spare part numbers 19
 - fingerprint reader, identifying 12
 - fn key, identifying 13
 - fn lock light, identifying 11
- H**
 - hard drive
 - M.2 storage 2
 - product description 2
 - removal 37
 - spare part number 19, 24
 - spare part numbers 37
 - specifications 100
 - hard drive cover
 - spare part number 24
 - HDMI port, identifying 6
 - heat sink
 - spare part numbers 20

- heat sink assembly
 - removal 51
 - spare part numbers 51
 - hinge
 - spare part number 23
 - hinge brackets
 - removal 78
 - hinge cover
 - removal 77
 - Hinge Kit
 - spare part number 23
 - hot keys
 - microphone mute 14
 - hotkeys, using 15
 - HP PC Hardware Diagnostics UEFI
 - downloading 87
 - starting 87
 - using 86
 - HP PC Hardware Diagnostics Windows
 - downloading 85
 - installing 86
 - using 85
 - HP Recovery Manager
 - correcting boot problems 94
 - starting 93
 - HP Recovery media
 - creating 90
 - recovery 93
 - HP Recovery partition
 - recovery 93
 - removing 95
 - HP Sure Start 108
- I**
- internal frame
 - removal 47
 - spare part number 20, 47
 - internal microphones, identifying 9
- J**
- jacks
 - audio-out (headphone)/audio-in (microphone) combo 8
 - network 7
 - RJ-45 (network) 7
- K**
- Keyboard
 - spare part numbers 19
 - keyboard
 - product description 3
 - removal 43
 - spare part numbers 43
 - keyboard backlight
 - action key 14
 - keypad
 - embedded numeric 13
 - keys
 - action 14
 - esc 13
 - fn 13
 - num lock 13
 - Windows 13
- L**
- labels
 - Bluetooth 17
 - regulatory 17
 - serial number 17
 - service 17
 - wireless certification 17
 - WLAN 17
 - left side components 8
 - lights
 - AC adapter and battery 7
 - battery 7
 - camera 9
 - caps lock 11
 - fn lock 11
 - hard drive 6
 - microphone mute 11
 - num lock 11
 - power 11
 - RJ-45 (network) 7
- M**
- M.2 solid-state drive
 - specifications 98
 - memory
 - nonvolatile 103
 - product description 1
 - removal 35
 - spare part number 19
 - spare part numbers 35
 - volatile 103
 - memory card reader, identifying 7
 - microphone
 - product description 2
 - microphone module
 - spare part number 23
 - microphone mute key, identifying 14
 - microphone mute light, identifying 11
 - MicroSD memory card reader, identifying 7
 - minimized image recovery 93
 - minimized image, creating 92
 - model name 1
 - mute volume action key 14
- N**
- near field communication (NFC)
 - antenna
 - spare part number 57
 - near field communication (NFC) cable
 - spare part number 57
 - near field communication (NFC) module
 - spare part number 57
 - network jack, identifying 7
 - next track action key 14
 - NFC
 - removal 57
 - spare part numbers 57
 - NFC module
 - spare part number 19
 - NFC tapping area, identifying 10
 - nonvolatile memory 103
 - num lock light 11
- O**
- operating system, product description 4
 - original system recovery 92
- P**
- panel
 - spare part numbers 22
 - pause action key 14
 - play action key 14
 - pointing device, product description 3
 - pointing stick, identifying 10
 - ports
 - external monitor 7
 - HDMI 6
 - product description 3
 - USB 3.x SuperSpeed 6, 8
 - USB 3.x SuperSpeed port with HP Sleep and Charge 6

- USB Type-C DisplayPort 6
 - USB Type-C power connector 6
 - USB Type-C SuperSpeed 6
 - power button board
 - removal 63
 - spare part number 19
 - spare part numbers 63
 - power button, identifying 12
 - power connector
 - identifying 6, 7
 - power cord
 - set requirements 101
 - power lights 11
 - power requirements, product
 - description 4
 - privacy screen action key,
 - identifying 14
 - processor 1
 - product description
 - audio 2
 - chipset 1
 - display panel 1
 - docking 3
 - ethernet 2
 - external media cards 3
 - hard drive 2
 - keyboard 3
 - M.2 storage 2
 - memory 1
 - microphone 2
 - operating system 4
 - pointing device 3
 - ports 3
 - power requirements 4
 - processor 1
 - product name 1
 - security 4
 - serviceability 5
 - video 2
 - wireless networking 2
 - product name 1
 - product name and number,
 - computer 17
- R**
- recover
 - options 92
 - recovery
 - discs 91, 93
 - HP Recovery Manager 92
 - media 93
 - starting 93
 - supported discs 91
 - system 92
 - USB flash drive 93
 - using HP Recovery media 91
 - recovery media
 - creating 90
 - creating using HP Recovery
 - Manager 91
 - recovery partition
 - removing 95
 - regulatory information
 - regulatory label 17
 - wireless certification labels 17
 - Remote HP PC Hardware Diagnostics
 - UEFI settings
 - customizing 88
 - using 88
 - removal/replacement
 - procedures 32, 40
 - removing personal data from volatile
 - system memory 103
 - right side components 6
 - RJ-45 (network) jack, identifying 7
 - RJ-45 (network) lights, identifying
 - 7
 - RTC battery
 - removal 69
 - spare part number 20, 69
 - Rubber Kit, spare part number 26
- S**
- screen brightness action keys 14
 - Screw Kit, spare part numbers 26
 - security cable slot, identifying 8
 - security, product description 4
 - serial number, computer 17
 - service labels, locating 17
 - serviceability, product description 5
 - setup utility
 - navigating and selecting 81
 - restoring factory settings 82
 - slots
 - security cable 8
 - smart card 8
 - smart card reader
 - removal 59
 - spare part number 59
 - smart card reader board
 - spare part number 19
 - smart card slot, identifying 8
 - solid-state drive
 - removal 39
 - spare part number 19, 24
 - spare part numbers 39
 - specifications 99
 - speaker
 - removal 70
 - spare part number 19
 - spare part numbers 70
 - speaker volume action keys 14
 - speakers, identifying 12
 - special keys, using 13
 - specifications
 - computer 96
 - display 97
 - hard drive 100
 - M.2 solid-state drive 98
 - solid-state drive 99
 - stop action key 14
 - supported discs, recovery 91
 - Sure Start
 - using 84
 - switch screen image action key 15
 - system board
 - removal 65
 - spare part number 20
 - spare part numbers 65
 - system memory, removing personal
 - data from volatile 103
 - system recovery 92
 - system restore point
 - creating 91
 - system restore point, creating 90
- T**
- top cover
 - spare part numbers 19
 - TouchPad
 - buttons 10
 - removal 56
 - spare part numbers 19, 56
 - TouchPad button board
 - removal 54
 - spare part number 19
 - spare part numbers 54
 - TouchPad zone
 - identifying 10

TPM settings 84
traveling with the computer 17

U

USB 3.x SuperSpeed port with HP
Sleep and Charge, identifying 6
USB 3.x SuperSpeed port,
identifying 6, 8
USB board
removal 61
spare part number 19, 61
USB Type-C power connector port,
identifying 6
USB Type-C SuperSpeed port,
identifying 6

V

vents, identifying 8, 16
VGA port
identifying 7
video, product description 2
volume
adjusting 14
mute 14

W

Windows
system restore point 90, 91
Windows key, identifying 13
Windows tools
using 91
wireless action key 14
wireless antennas, identifying 9
wireless certification label 17
wireless networking
product description 2
WLAN
removal 42
spare part numbers 42
WLAN antenna cables
removal 79
WLAN antennas, identifying 9
WLAN cable
spare part number 23
WLAN device 17
WLAN label 17
WLAN module
spare part number 19
WWAN
removal 40
spare part numbers 40

WWAN antenna cable
spare part number 23
WWAN antenna cables
removal 79
WWAN antennas, identifying 9
WWAN module
spare part number 19