

4-Port Dual HDMI KVM Switch - 4K 60Hz

SV431DHD4KU

FR: Guide de l'utilisateur - fr.startech.com

DE: Bedienungsanleitung - de.startech.com

ES: Guía del usuario - es.startech.com

NL: Gebruiksaanwijzing - nl.startech.com

PT: Guia do usuário - pt.startech.com

IT: Guida per l'uso - it.startech.com

JP: 取扱説明書 - jp.startech.com

Product diagram

*actual product may vary from photos

Front view

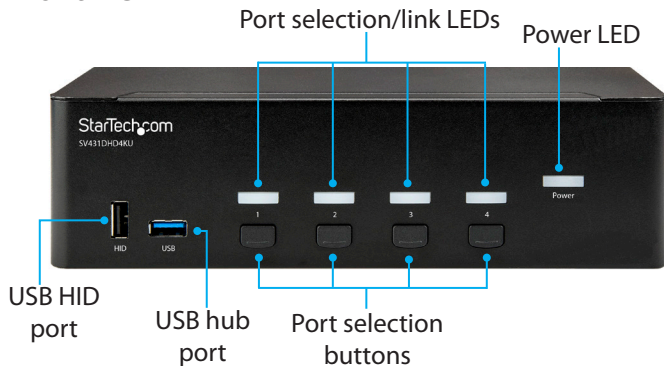

Back view

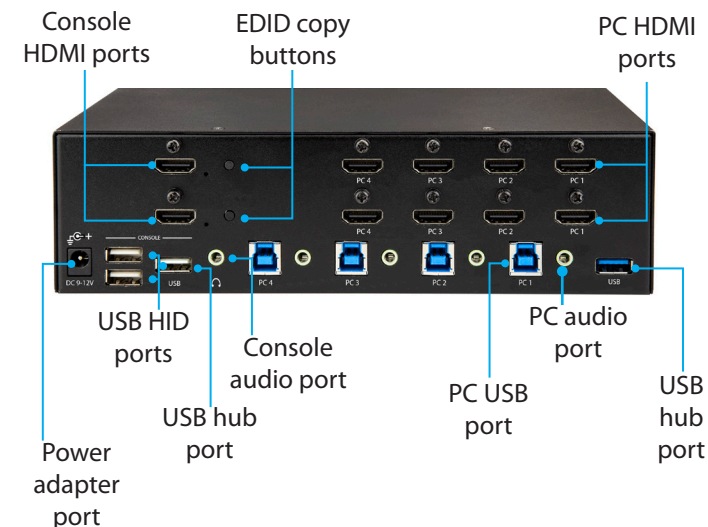

Package contents

- 1 x KVM switch
- 1 x universal power adapter (NA/JP, EU, UK, ANZ)
- 4 x rubber feet
- 1 x quick-start guide

Requirements

- HDMI cables
- USB-A to USB-B or USB-C to USB-B cables
- 3.5 mm audio cables
- Computer system or video card enabled with HDMI
- Computer system enabled with USB
- Display device (for example, monitor, projector, TV, and so on) enabled with HDMI
- Standard USB keyboard and mouse (wired or wireless)

Requirements are subject to change. For the latest requirements, please visit www.StarTech.com/SV431DHD4KU.

Installation

Connect the console to the KVM switch

1. Turn off your computer and any devices or peripherals that are connected to it (for example, printers, external hard drives, and so on).
2. Connect two monitors or displays to the Console HDMI ports.
3. Do one of the following:
 - Connect a keyboard and a mouse to two of the USB HID ports.
 - If you're using a combination wireless keyboard and mouse, connect the wireless receiver one of the USB HID ports.
4. If necessary, do any of the following:
 - Connect speakers to the Console audio port.
 - Connect USB peripherals to the USB hub ports.
 - Connect additional HID devices (touchpads, touchscreens, number pads, etc.) to available HID ports.

Connect a computer to the KVM switch

Notes:

- No software or driver installation is required.
- The cables for each individual computer must be connected to the same port set on the KVM switch.

1. Turn off the computers that you want to connect to the KVM switch and any devices or peripherals that are connected to the computers (e.g. printers, external hard drives, etc.)
2. Connect an HDMI video cable to each of the HDMI ports on your computer and to the PC HDMI ports of the same set, on the KVM switch.
3. Connect a USB cable to the USB port on your computer and to the PC USB port on the KVM switch.
4. Optional: Connect an audio cable to the audio output on your computer and the PC audio port on the KVM switch.
5. To connect additional computers, repeat steps 1 to 4.

6. Connect the universal power adapter to a power source and to the Power adapter port on the KVM switch. The Power LED illuminates to confirm the switch is receiving power.
7. Turn on any devices or peripherals that are connected to the KVM switch.
8. Turn on the connected computer. Wait for the computer to finish loading and then test the functionality of the keyboard and mouse of the connected computer.
9. If additional computers are connected to the KVM switch, select a different port and repeat step 7 until you have tested the functionality of all of the connected computers.

Using hotkey commands

You can use keyboard key combinations, called hotkeys, to operate the KVM switch.

Notes:

- Your keyboard must be connected to one of the HID ports on the KVM switch to use hotkey commands.
- The Scroll Lock key can be used as an alternative to the left ctrl key.

Basic hotkey combinations:

Hotkeys	Function
Left Ctrl, Left Ctrl, (1, 2, 3 or 4)	Switches KVM port selection between the computer that's connected to port 1, 2, 3 or 4, respective to the number button that's pressed.

About the LED indicators

The KVM switch features a Port selection/link LED for each port, as well as a power LED. For more information about the LEDs, consult the table below.

LED	Behavior	Scenario
Power LED	Illuminated	KVM switch is receiving power
Port LEDs	Illuminated green	Connected computer is turned on
	Illuminated red	Connected computer is currently selected
	Blinking	Auto scan process is in progress

FCC Compliance Statement

This equipment has been tested and found to comply with the limits for a Class B digital device, pursuant to part 15 of the FCC Rules. These limits are designed to provide reasonable protection against harmful interference in a residential installation. This equipment generates, uses and can radiate radio frequency energy and, if not installed and used in accordance with the instructions, may cause harmful interference to radio communications. However, there is no guarantee that interference will not occur in a particular installation. If this equipment does cause harmful interference to radio or television reception, which can be determined by turning the equipment off and on, the user is encouraged to try to correct the interference by one or more of the following measures:

- Reorient or relocate the receiving antenna.
- Increase the separation between the equipment and receiver.
- Connect the equipment into an outlet on a circuit different from that to which the receiver is connected.
- Consult the dealer or an experienced radio/TV technician for help

This device complies with part 15 of the FCC Rules. Operation is subject to the following two conditions: (1) This device may not cause harmful interference, and (2) this device must accept any interference received, including interference that may cause undesired operation. Changes or modifications not expressly approved by StarTech.com could void the user's authority to operate the equipment.

Industry Canada Statement

This Class B digital apparatus complies with Canadian ICES-003.
Cet appareil numérique de la classe [B] est conforme à la norme NMB-003 du Canada.
CAN ICES-3 (B)/NMB-3(B)

Use of Trademarks, Registered Trademarks, and other Protected Names and Symbols

This manual may make reference to trademarks, registered trademarks, and other protected names and/or symbols of third-party companies not related in any way to StarTech.com. Where they occur these references are for illustrative purposes only and do not represent an endorsement of a product or service by StarTech.com, or an endorsement of the product(s) to which this manual applies by the third-party company in question. Regardless of any direct acknowledgement elsewhere in the body of this document, StarTech.com hereby acknowledges that all trademarks, registered trademarks, service marks, and other protected names and/or symbols contained in this manual and related documents are the property of their respective holders.

Technical Support

StarTech.com's lifetime technical support is an integral part of our commitment to provide industry-leading solutions. If you ever need help with your product, visit www.startech.com/support and access our comprehensive selection of online tools, documentation, and downloads. For the latest drivers/software, please visit www.startech.com/downloads

Warranty Information

This product is backed by a two-year warranty.

StarTech.com warrants its products against defects in materials and workmanship for the periods noted, following the initial date of purchase. During this period, the products may be returned for repair, or replacement with equivalent products at our discretion. The warranty covers parts and labor costs only. StarTech.com does not warrant its products from defects or damages arising from misuse, abuse, alteration, or normal wear and tear.

Limitation of Liability

In no event shall the liability of StarTech.com Ltd. and StarTech.com USA LLP (or their officers, directors, employees or agents) for any damages (whether direct or indirect, special, punitive, incidental, consequential, or otherwise), loss of profits, loss of business, or any pecuniary loss, arising out of or related to the use of the product exceed the actual price paid for the product. Some states do not allow the exclusion or limitation of incidental or consequential damages. If such laws apply, the limitations or exclusions contained in this statement may not apply to you.