

Lenovo ideapad 330

ideapad 330-14IGM | ideapad 330-15IGM

ideapad 330-15ICN | ideapad 330-15ARR

ideapad 330-15ARR Touch

User Guide



Read the safety notices and important tips in the included manuals before using your computer.

Lenovo™

Notes

- Before using the product, be sure to read *Lenovo Safety and General Information Guide* first.
- The latest electronic compliance and environmental information are available from the Lenovo compliance information Web sites.
 - To view compliance information go to: <http://www.lenovo.com/compliance>
 - To download environmental information go to: <http://www.lenovo.com/ecodeclaration>
- Some instructions in this guide may assume that you are using Windows® 10. If you are using another Windows operating system, some operations may be slightly different. If you are using other operating systems, some operations may not apply to you.
- The features described in this guide are common to most models. Some features may not be available on your computer or your computer may include features that are not described in this user guide.
- The illustrations used in this manual are for the Lenovo ideapad 330-15ICN unless otherwise stated.
- The illustrations in this manual may differ from the actual product. Please refer to the actual product.

Regulatory Notice

- For details, refer to **Guides & Manuals** at <http://support.lenovo.com>.

First Edition (February 2018)

© Copyright Lenovo 2018.

LIMITED AND RESTRICTED RIGHTS NOTICE: If data or software is delivered pursuant to a General Services Administration "GSA" contract, use, reproduction, or disclosure is subject to restrictions set forth in Contract No. GS-35F-05925.

Lenovo

User Guide

Instructions and technical information in this manual are applicable to the following Lenovo notebook computers unless otherwise stated.

Model name	MT	Model name	MT
Lenovo ideapad 330-14IGM	81D0, 81FM*	Lenovo ideapad 330-15ICN	81EY
Lenovo ideapad 330-14IGM U	81D0	Lenovo ideapad 330H-15ICN	
Lenovo ideapad 330E-14IGM U		Lenovo ideapad 330L-15ICN	
Lenovo ideapad 330H-14IGM		Lenovo ideapad 330E-15ICN	
Lenovo ideapad 330L-14IGM		Lenovo ideapad 330R-15ICN	
Lenovo ideapad 330E-14IGM		81D1, 81FN*	Lenovo ideapad 330-15ARR
Lenovo ideapad 330R-14IGM	Lenovo ideapad 330-15ARR D		
Lenovo ideapad 330-15IGM	81D1	Lenovo ideapad 330-15ARR U	
Lenovo ideapad 330-15IGM D		Lenovo ideapad 330E-15ARR D	
Lenovo ideapad 330-15IGM U		Lenovo ideapad 330E-15ARR U	
Lenovo ideapad 330E-15IGM D		Lenovo ideapad 330H-15ARR	
Lenovo ideapad 330E-15IGM U		Lenovo ideapad 330L-15ARR	
Lenovo ideapad 330H-15IGM		Lenovo ideapad 330E-15ARR	
Lenovo ideapad 330L-15IGM		Lenovo ideapad 330R-15ARR	
Lenovo ideapad 330E-15IGM		Lenovo ideapad 330-15ARR Touch	81D3
Lenovo ideapad 330R-15IGM			

* This machine type is only for Brazil.

Contents

Chapter 1. Getting to know your computer	1
Top view.....	1
Left-side view	8
Right-side view.....	13
Bottom view.....	14
Chapter 2. Starting to use Windows 10.....	16
Configuring the operating system for the first time.....	16
Operating system interface.....	16
Putting the computer to sleep or shutting it down.....	18
Task and desktop management.....	20
Connecting to a wireless network.....	21
Touch screen operation (Lenovo ideapad 330-15ARR Touch).....	22
Chapter 3. Recovery system	25
Reset this PC.....	25
Chapter 4. Troubleshooting.....	26
Frequently asked questions.....	26
Troubleshooting.....	28
Trademarks.....	32

Chapter 1. Getting to know your computer

■ ■ Top view

■ Lenovo ideapad 330-14IGM

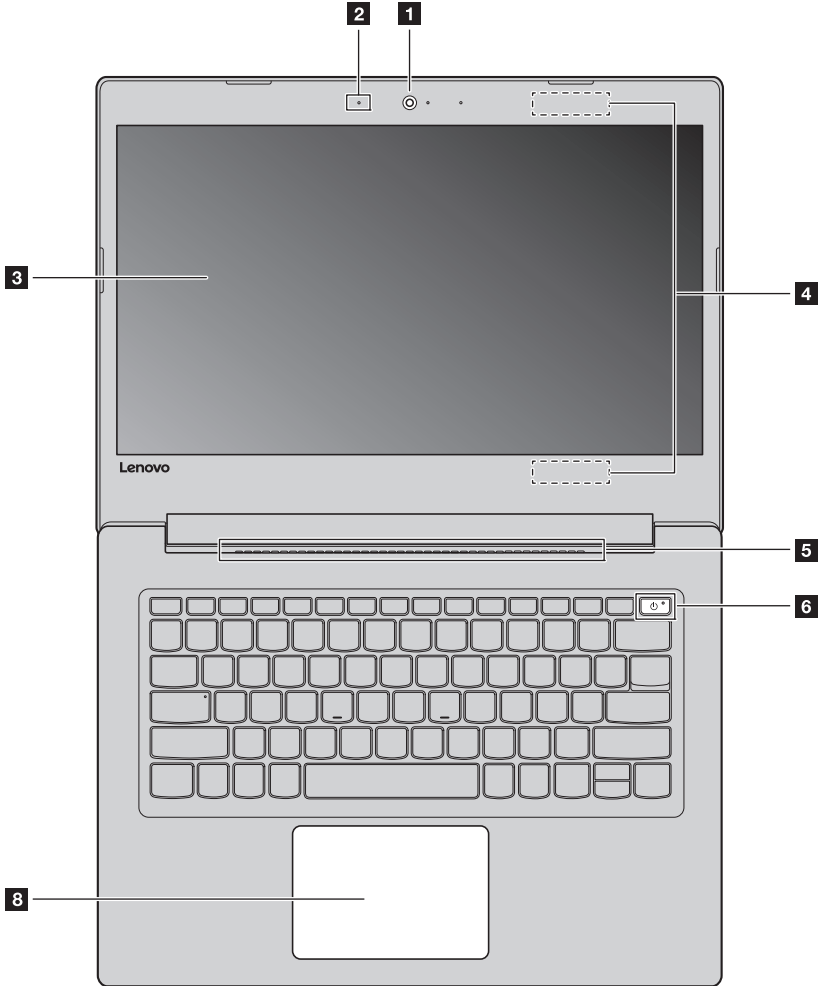

Chapter 1. Getting to know your computer

■ Lenovo ideapad 330-15IGM/ideapad 330-15ICN/ideapad 330-15ARR/ideapad 330-15ARR Touch

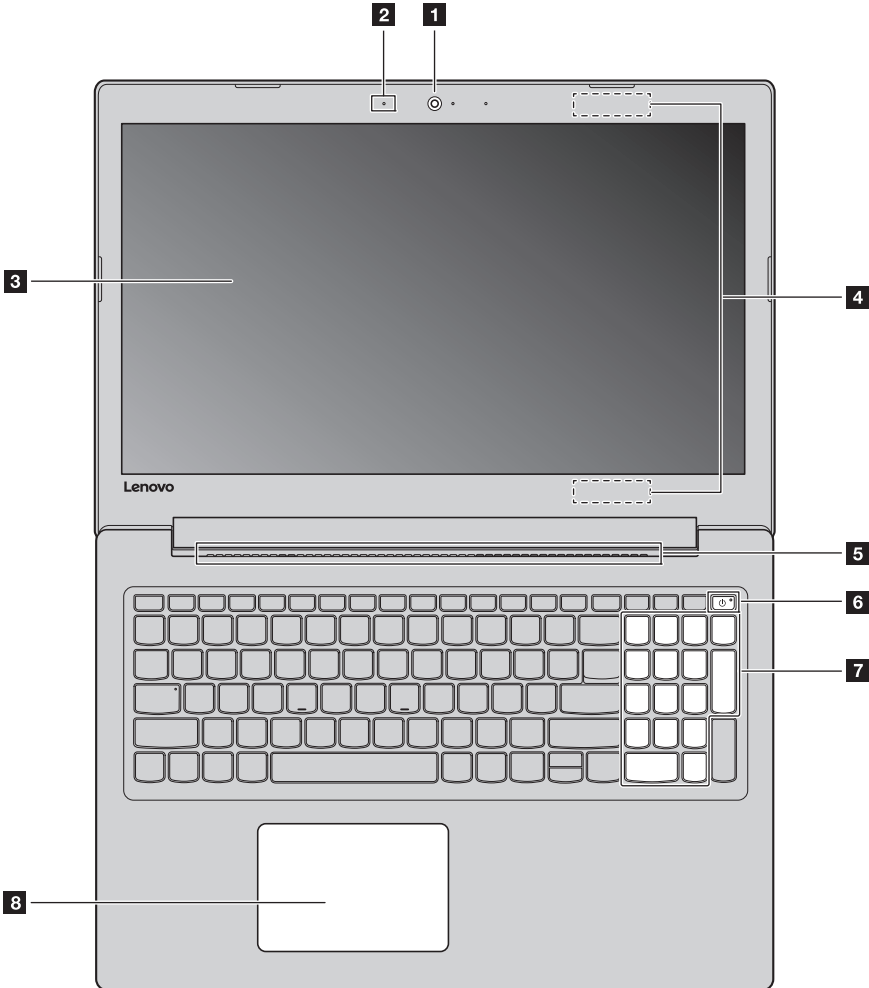

Note: The dashed areas indicate parts that are not visible externally.

⊙ **Attention:**

- Do *not* open the display panel beyond 180 degrees. When closing the display panel, be careful *not* to leave pens or any other objects in between the display panel and the keyboard. Otherwise, the display panel may be damaged.

- 1 Integrated camera** Use the camera for video communication or taking photos.

Note: The position of the camera indicator on select models may vary slightly. Please refer to the actual product.

- 2 Built-in microphone** Captures sound which can be used for video conferencing, voice narration, or audio recording.

- 3 Computer display** Provides brilliant visual output.

- 4 Wireless LAN antennas** Connect to a wireless LAN adapter to send and receive wireless radio signals.

- 5 Ventilation slots** Dissipate internal heat.

Note: Make sure that the ventilation slots are not blocked or else the computer may overheat.

- 6 Power button** Press this key to turn on/off the computer.

- 7 Numeric keypad** For details, see “Numeric keypad (Lenovo ideapad 330-15IGM/ideapad 330-15ICN/ideapad 330-15ARR/ideapad 330-15ARR Touch)” on page 4.

- 8 Touchpad** The touchpad functions as a conventional mouse.
One piece multi-touch ClickPad: To move the pointer on the screen, slide your fingertip over the pad in the direction in which you want the pointer to move.
Left-click area: Clicking in this area corresponds to the functions of clicking the left button on a conventional mouse.
Right-click area: Clicking in this area corresponds to the functions of clicking the right button on a conventional mouse.

Note: You can enable/disable the touchpad by pressing **F6** ().

Chapter 1. Getting to know your computer

■ Using the keyboard

Numeric keypad (Lenovo ideapad 330-15IGM/ideapad 330-15ICN/ideapad 330-15ARR/ideapad 330-15ARR Touch)

The keyboard has a separate numeric keypad. To enable or disable the numeric keypad, press the **Num Lock** key.

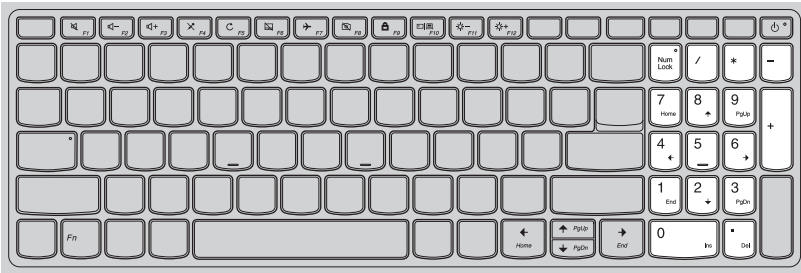

Function key combinations

Through the use of the function keys, you can change operational features instantly. To use this function, press and hold **Fn** **1**; then press one of the function keys **2**.

Lenovo ideapad 330-14IGM

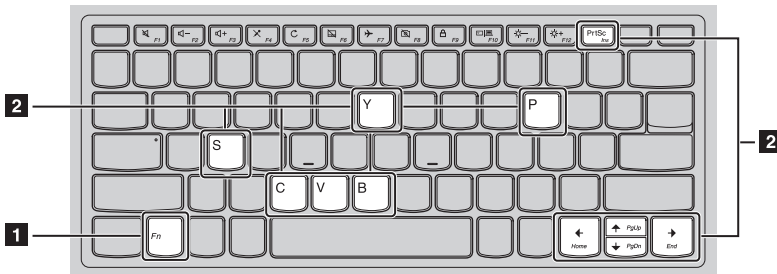

Lenovo ideapad 330-15IGM/ideapad 330-15ICN/ideapad 330-15ARR/
ideapad 330-15ARR Touch

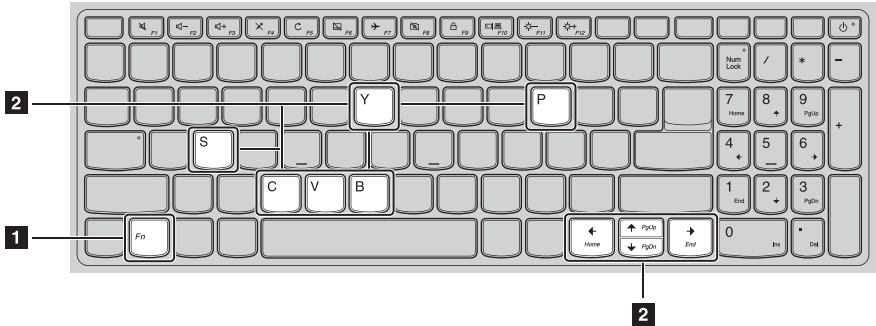

The following describes the features of each function key.

- | | |
|---|-----------------------------------|
| Fn + PrtSc (Lenovo ideapad 330-14IGM): | Activates the insert function. |
| Fn + B: | Activates the break function. |
| Fn + P: | Activates the pause function. |
| Fn + C: | Enables/disables the scroll lock. |
| Fn + Y: | Activates the system request. |
| Fn + S + V: | Set the battery Ship Mode. |
| Fn + ↑: | Activates the Pgup key function. |
| Fn + ↓: | Activates the Pgdn key function. |
| Fn + ←: | Activates the home key function. |
| Fn + →: | Activates the end key function. |

Chapter 1. Getting to know your computer

Hotkeys





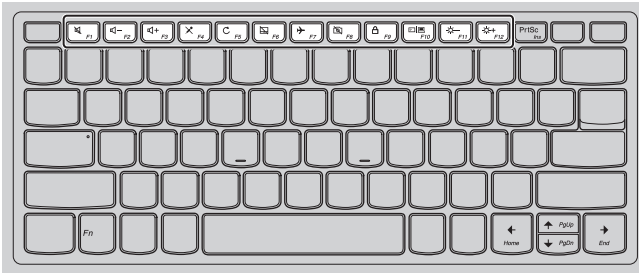



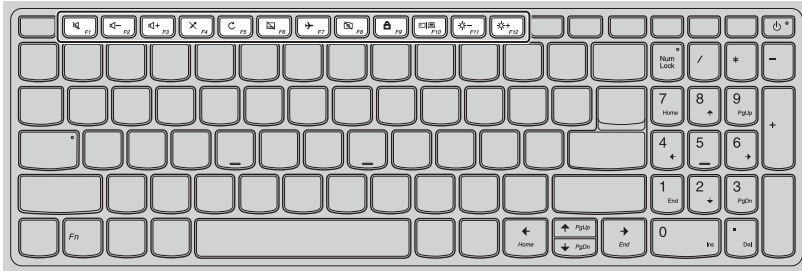



You can access certain system settings quickly by pressing the appropriate hotkeys.

Lenovo ideapad 330-14IGM



**Lenovo ideapad 330-15IGM/ideapad 330-15ICN/ideapad 330-15ARR/
ideapad 330-15ARR Touch**



 : Mutes/unmutes the sound.	 : Enables/disables Airplane mode.
 : Decreases the volume level.	 : Enables/disables the integrated camera.
 : Increases the volume level.	 : Locks the screen.
 : Enables/disables the microphone.	 : Toggles the display between the computer and an external display device.
 : Refreshes the desktop or the currently active window.	 : Decreases the display brightness.
 : Enables/disables the touchpad.	 : Increases the display brightness.

Setting hotkey mode

By default, the hotkey functions are accessible by pressing the appropriate hotkey. However, you can disable the hotkey mode in the BIOS setup utility.

To disable the hotkey mode:

- ❶ Shut down the computer.
- ❷ Press the Novo button and then select **BIOS Setup**.
- ❸ In the BIOS setup utility, open the **Configuration** menu, and change the setting of **HotKey Mode** from **Enabled** to **Disabled**.
- ❹ Open the **Exit** menu, and select **Exit Saving Changes**.

Note: When hotkey mode is disabled, press the **Fn** key and the appropriate hotkey to access the corresponding hotkey function.

■ ■ Left-side view

■ Lenovo ideapad 330-14IGM

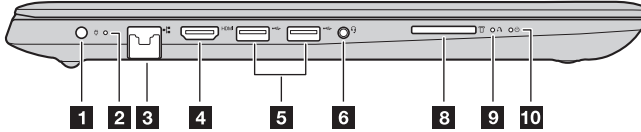

■ Lenovo ideapad 330-15IGM

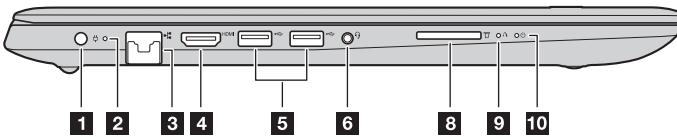

■ Lenovo ideapad 330-15ICN/ideapad 330-15ARR/ideapad 330-15ARR Touch

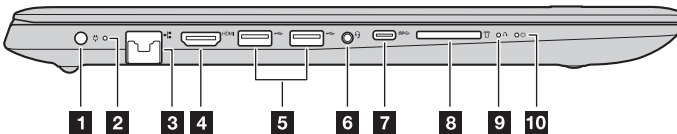

- 1 AC power adapter jack Connects to the AC power adapter.
- 2 Battery status indicator

AC power adapter status	Indicator status	Meaning
Disconnected	Off	The computer is in sleep mode or turned off; The battery has more than 20% charge.
	Solid amber	The battery has between 5% and 20% charge.
	Fast blinking amber	The battery has between 1% and 5% charge.
Connected	Slow blinking amber	The battery is being charged. When battery charge reaches 20%, the blinking color changes to white.
	Slow blinking white	The battery has between 20% and 80% charge and is still charging. When the battery reaches 80% charge the light will stop blinking.
	Solid white	The battery has more than 80% charge, charging will continue until the battery is fully charged.

3 RJ-45 port Connects the computer to an Ethernet network.

Note: For details, see “Connecting network cables” on page 10.

4 HDMI 1.4 port Connects to devices with HDMI input such as a TV or an external display.

5 USB ports Connect to USB devices.

Note: For details, see “Connecting USB device” on page 11.

6 Combo audio jack Connects to headsets.

Notes:

- The combo audio jack does not support conventional microphones.
- The recording function might not be supported if third-party headphones or headsets are connected, due to different industry standards.

7 Type-C port Type-C port supports:
 • USB 3.0, 1.5A DC

8 Memory card slot Accepts memory cards (not supplied).

Note: For details, see “Using memory cards (not supplied)” on page 12.

9 Novo button When the computer is off, press this button to start the recovery system or the BIOS setup utility, or to enter the boot menu.

Note: For details, see “Recovery system” on page 25.

10 Power status indicator

Indicator	Indicator status	Meaning
Power	On (solid white)	The computer is powered on.
	Blinking	The computer is in sleep mode.
	Off	The computer is powered off.

Chapter 1. Getting to know your computer

■ Connecting network cables

To insert a network cable, do the following:

- ❶ Hold one connector of the network cable to press the RJ-45 cover down gently **1**.
- ❷ Insert the connector into the RJ-45 port **2**.

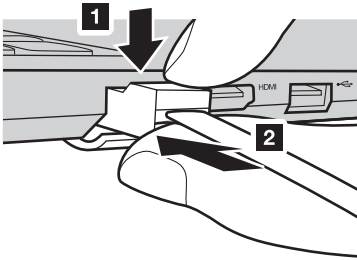

Software configuration

Consult your Internet Service Provider (ISP) for details on how to configure your computer.

■ Connecting USB device

You can connect a USB device to your computer by inserting its USB plug (Type A/Type C) into the USB port on your computer.

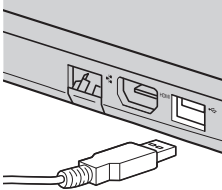

The first time you plug a USB device into a particular USB port on your computer, Windows automatically installs a driver for that device. After the driver has been installed, you can disconnect and reconnect the device without performing any additional steps.

Note: Typically, Windows detects a new device after it has been connected, and then installs the driver automatically. However, some devices may require you to install the driver before connecting. Check the documentation provided by the device's manufacturer before connecting the device.

Before disconnecting a USB storage device, make sure your computer has finished transferring data to that device. Click the **Safely Remove Hardware and Eject Media** icon in the Windows notification area to remove the device before disconnecting.

Note: If your USB device uses a power cord, connect the device to a power source before connecting it. Otherwise, the device may not be recognized.

Chapter 1. Getting to know your computer

■ Using memory cards (not supplied)

Your computer supports the following types of memory cards:

- Secure Digital (SD) card
- Secure Digital High Capacity (SDHC) card
- Secure Digital eXtended Capacity (SDXC) card
- MultiMediaCard (MMC)

Notes:

- Insert *only* one card in the slot at a time.
- This card reader does not support SDIO devices (e.g., SDIO Bluetooth, etc.).

Inserting a memory card

Insert the memory card until it touches the bottom of the slot.

Removing a memory card

Gently pull the memory card out of the memory card slot.

Note: Before removing the memory card, disable it by using the Windows safely remove hardware and eject media utility to avoid data corruption.

■ ■ Right-side view

■ Lenovo ideapad 330-14IGM

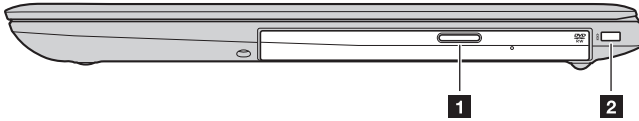

■ Lenovo ideapad 330-15IGM/ideapad 330-15ICN/ideapad 330-15ARR/ ideapad 330-15ARR Touch

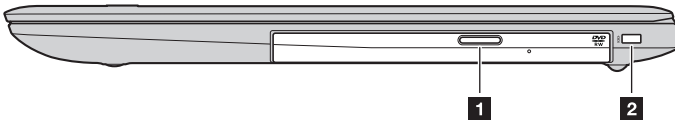

1 **Optical drive**
(on select models)

Reads/burns optical discs.

2 **Kensington mini security slot**

For attaching a Kensington MiniSaver™ Mobile (or compatible) lock.

Note: Lock is not supplied. When purchasing a lock, choose one that utilizes the Cleat™ locking mechanism and verify its compatibility with the slot before purchase. A lock utilizing the T-Bar™ locking mechanism is not compatible with the Kensington mini security slot.

■ ■ Bottom view

■ Lenovo ideapad 330-14IGM

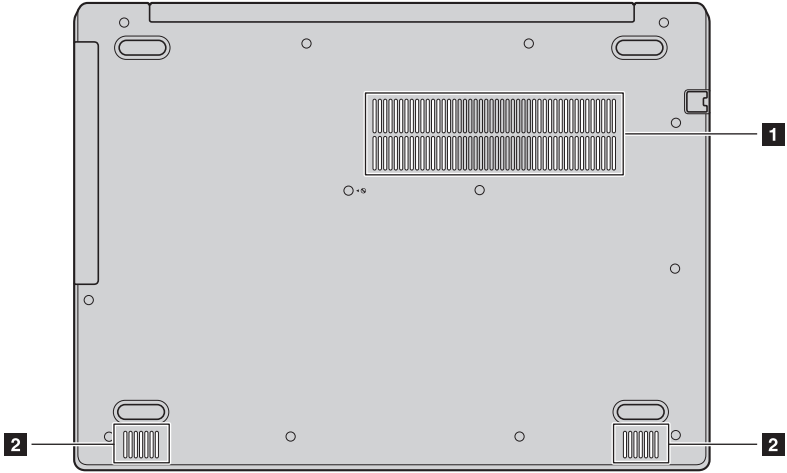

- Lenovo ideapad 330-15IGM/ideapad 330-15ICN/ideapad 330-15ARR/
ideapad 330-15ARR Touch

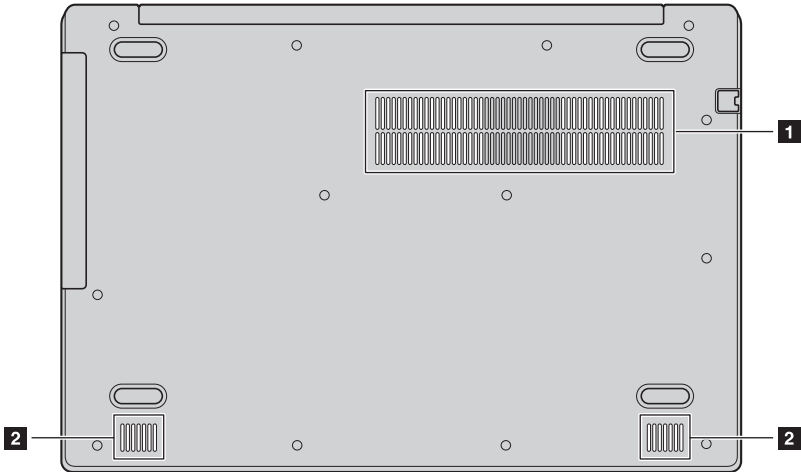

1 Louvers

Allow air to enter the computer for cooling.

2 Speakers

Provide audio output.

Chapter 2. Starting to use Windows 10

Note: Windows® 10 has an updated version. If you are using the updated version, some operations may be different. Please refer to the actual product.



■ ■ Configuring the operating system for the first time

You may need to configure the operating system when it is first used. The configuration process may include the procedures below:

- Accepting the end user license agreement
- Configuring the Internet connection
- Registering the operating system
- Creating a user account

■ ■ Operating system interface

Windows 10 comes with a powerful and useful start menu. To open the start menu, do one of the following:

- Press the Windows key  on the keyboard.
- Select **Start**  on the lower-left corner of the desktop.



- 1** Settings button
- 2** Power button
- 3** Start button

- 4** Search box
- 5** Task view button

■ Settings

Settings lets you perform basic tasks. You can also search for more settings with the settings search box in the upper-right corner.

To open the settings, do the following:

- Open the start menu, and then select **Settings** .

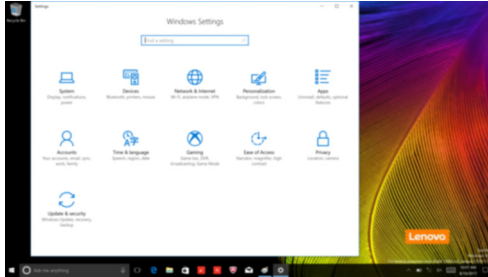

■ Personalize the start menu

You can personalize the start menu with your favorite apps.

To personalize the start menu, do the following:

- 1 Open the start menu and find the apps list on the left.
- 2 Right click the app you want to add to the start menu, and then select **Pin to Start**.



Note: You can also drag apps from the apps list to add them to the start menu.

■ ■ Putting the computer to sleep or shutting it down

When you have finished working with your computer, you can put it to sleep or shut it down.

■ Putting your computer to sleep

If you will be away from your computer for only a short time, put the computer to sleep. When the computer is in sleep mode, you can quickly wake it to resume use, bypassing the startup process.

To put the computer to sleep, do one of the following:

- Close the display lid.
- Press the Power button.
- Open the start menu, and then select **Power**  → **Sleep**.

Note: Wait until the power indicator light starts blinking (indicating that the computer is in sleep mode) before you move your computer. Moving your computer while the hard disk is spinning can damage the hard disk, causing loss of data.

To wake the computer, do one of the following:

- Press any key on the keyboard.
- Press the Power button.

■ **Shutting down the computer**

If you are not going to use your computer for a long time, shut it down. To shut down the computer, do one of the following:

- Open the start menu, and then select **Power**  → **Shut down**.



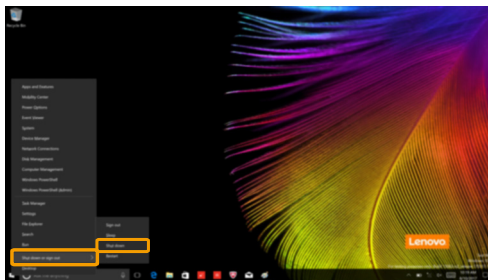

- Right-click the **Start** button in the lower-left corner and select **Shut down or sign out** → **Shut down**.



■ ■ Task and desktop management

■ Task view

To open the task view, do one of the following:

- Select the Task view button  on the task bar.
- Press the Windows key  + Tab.

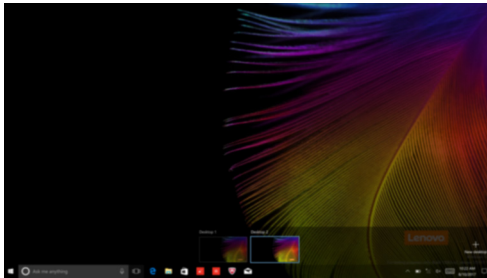



■ Virtual desktop management

Windows 10 supports the ability to create, manage and switch between virtual desktops.

To create a new virtual desktop, do one of the following:

- Open the task view, and then select **New desktop**.
- Press the Windows key  + Ctrl + D.



To switch between different desktops, do one of the following:

- Open the task view and select the desktop you want active.
- Press the Windows key  + Ctrl +  /  to scroll through the desktops you've created.

■ ■ Connecting to a wireless network

Enabling wireless connection

To enable wireless functions, do the following:

- 1 Press F7 () to disable airplane mode.
- 2 Click  on the lower-right corner of the task bar to open the network configuration page.

Connecting to a wireless network

After wireless has been enabled, the computer will automatically scan for available wireless networks and display them in the wireless network list. To connect to a wireless network, click the network name in the list, and then click **Connect**.

Note: Some networks require a network security key or passphrase for connection. To connect to one of those networks, ask the network administrator or the Internet service provider (ISP) for the security key or passphrase.

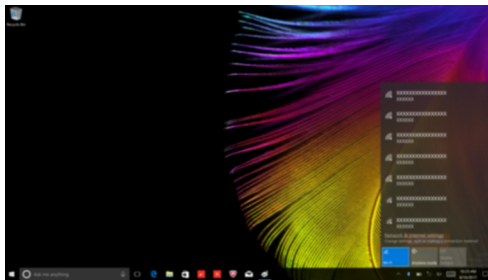

■ ■ Touch screen operation (Lenovo ideapad 330-15ARR Touch)



The display panel can accept inputs like a tablet, using the multi-touch screen, or like a traditional notebook computer, using the keyboard and touchpad.

■ Multi-touch gestures

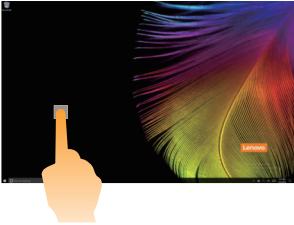
You can touch the screen with one or more fingertips to perform a variety of tasks.

Frequently used gestures	Tasks performed
<p>Tap Tap once on an item.</p>  An illustration showing a hand with the index finger touching a screen. The screen displays a colorful, abstract background with a 'Lenovo' logo in the bottom right corner.	<p>Performs an action, such as starting an app, opening a link, or performing a command. Similar to left-clicking with a mouse.</p>
<p>Press and hold Press your finger down and leave it there for a moment.</p>  An illustration showing a hand with the index finger pressing down on a screen. The screen displays a colorful, abstract background with a 'Lenovo' logo in the bottom right corner.	<p>Enables you to see detailed information before selecting an action. Can also open a menu with more options. Similar to right-clicking with a mouse.</p>

(continued)

Frequently used gestures	Tasks performed
<p>Zoom Move two fingers together or apart while touching the screen.</p> 	<p>Zooms in and out on visual apps, such as pictures and maps. Can also jump to the beginning or end of a list.</p>
<p>Rotate Place two or more fingers on an item and then turn your hand.</p> 	<p>Rotates an object (Note: Not all items can be rotated, depending upon the app.).</p>
<p>Slide Drag your finger across the screen.</p> 	<p>Pans or scrolls through lists and pages. Can also move an object or be used to draw or write, depending upon the app. Similar to pressing and holding to pan and to scrolling with a mouse.</p>

Chapter 2. Starting to use Windows 10

(continued)

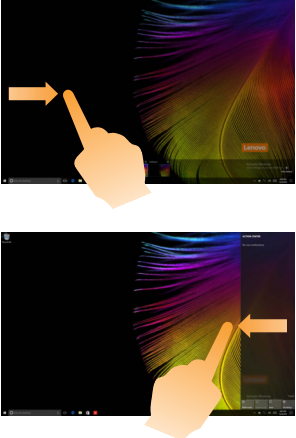
Frequently used gestures	Tasks performed
<p data-bbox="140 322 210 347">Swipe</p> <p data-bbox="140 352 554 403">Start from left/right edge of the screen, then swipe inwards toward the center.</p> 	<p data-bbox="610 408 1013 459">Swiping in from the left edge of the screen can open the task view.</p> <p data-bbox="610 651 1024 702">Swiping in from the right edge of the screen displays the action center.</p>

Chapter 3. Recovery system

■ ■ Reset this PC

■ Introduction

Reset this PC is a built-in recovery tool that enables users to restore their operating system to its original state. This preserves their data and important customizations, without the need to back up their data in advance.

The following **Reset this PC** features are available to users from multiple locations within Windows:

Keep my files

Fixes software problems by reinstalling the factory default configuration. This preserves personal files, and deletes apps and settings.

Remove everything

Prepares the computer for recycling or transfer of ownership. This reinstalls the factory default configuration and returns all user data and applications to the state of their original Out-of-Box Experience (OOBE).

■ Using Reset this PC

Reset this PC can be launched using one of the following methods:

- Novo Menu:
 - Shut down the computer and wait at least five seconds. Press the Novo button to open the Novo Menu, then select **System Recovery** → **Troubleshoot** → **Reset this PC**.
- Windows PC settings:
 - Windows PC settings → **Update & security** → **Recovery** → **Reset this PC** → select **Get started**.

For more instructions, see the Windows Help and Support file on your computer.

Chapter 4. Troubleshooting

■ ■ Frequently asked questions

This section lists frequently asked questions by category.

■ Finding information

What safety precautions should I follow when using my computer?

Read and follow all safety precautions included in *Lenovo Safety and General Information Guide*.

Note: To view *Lenovo Safety and General Information Guide*, select the **Companion** (or **Lenovo PC Manager**) icon on the taskbar. You can also download it from the Lenovo Support Web site.

What is the address of the Lenovo support Web site?

<http://support.lenovo.com>

Where can I find warranty information?

Visit the Lenovo Support Web site and type the serial number for your computer to look up warranty information.

■ Lenovo preinstalled operating system and software

What is the Lenovo preinstalled operating system?

Some Lenovo computers come with copies of the operating system installed at factory. Lenovo provides computers with a preinstalled operating system for your convenience. If you purchased such a computer, you can use your computer out of the box and do not need to install a separate operating system.

What is Lenovo preinstalled software?

This is software (developed by Lenovo or other software vendors) installed and licensed at the factory for your convenience. The license for some preinstalled software may be for trial versions. When the trial period expires, you may need to purchase a license if you want to continue to use the software.

Note: If a license agreement is displayed when you first start the software, read the agreement carefully. If you don't accept the terms of the agreement, do not use the software.

When I purchased my computer, it included a copy of Windows. How can I determine whether the copy of Windows is preinstalled by Lenovo?

On the outside of the sales package of your computer, you should find a label containing configuration information for your computer. Check the printed string next to **OS**. If it contains **Windows** or **WIN**, the copy of Windows was preinstalled by Lenovo.

I uninstalled a preinstalled software, but there is no significant increase in the free drive space.

The copy of Windows running on your computer may be Compact-enabled. For computers with Compact-enabled Windows, the majority of files needed for preinstalled software are installed on the Recovery Partition and won't be deleted through normal uninstallation.

How can I determine whether the Windows running on my computer is Compact enabled?

Compact technology is normally enabled on copies of Windows 10 Update running on SSD (or eMMC) -only computer models. To check your computer,

- 1 Right-click the Start button in the lower-left corner and select **Disk Management**.
- 2 The Disk Management program starts.

If **Compact** is labeled on the Windows partition, Compact is enabled on your copy of Windows.

Where can I find drivers for the various hardware devices of my computer?

If your computer is preinstalled with a Windows operating system, first check the installation program on the C partition of your hard disk (for select models, on the D partition). If you cannot find the drivers for all the hardware devices that you need there, download the drivers from the Lenovo consumer support web site.

Note: The Lenovo support Web site contains the latest drivers.

■ BIOS setup utility

What is the BIOS setup utility?

The BIOS setup utility is ROM-based software. It communicates basic computer information and provides options for setting boot devices, security, hardware mode, and other preferences.

How can I start the BIOS setup utility?

To start the BIOS setup utility:

- 1 Shut down the computer.
- 2 Press the Novo button and then select **BIOS Setup**.

How can I change the boot mode? (on select models)

There are two boot modes: **UEFI** and **Legacy Support**. To change the boot mode, start the BIOS setup utility and set boot mode to **UEFI** or **Legacy Support** on the boot menu.

When do I need to change the boot mode? (on select models)

The default boot mode for your computer is **UEFI** mode. If you need to install a legacy Windows operating system on your computer, you must change the boot mode to **Legacy Support**. The legacy Windows operating system cannot be installed if you don't change the boot mode.

■ Getting help

How can I contact the customer support center?

See "Chapter 3. Getting help and service" of *Lenovo Safety and General Information Guide*.

■ ■ Troubleshooting

Display problems

When I turn on the computer, nothing appears on the screen.

- If the screen is blank, make sure that:
 - The AC power adapter is connected to the computer, and plugged into a working electrical outlet.
 - The computer power is on. (Press the Power button again for confirmation.)
- If these items are properly set, and the screen remains blank, have the computer serviced.

When I turn on the computer, only a white cursor appears on a blank screen.

- Restore backed-up files to your Windows environment or the entire contents of your hard disk to its original factory contents using Reset this PC. If you still see only the cursor on the screen, have the computer serviced.

The screen goes blank while the computer is on.

- Your screen saver or power management may be enabled. Do one of the following to exit from the screen saver or to resume from sleep mode:
 - Touch the touchpad.
 - Press any key on the keyboard.
 - Press the Power button.

BIOS password problems

I forgot my password.

- If you forget your user password, ask the system administrator to clear your user password.
- If you forget your hard disk drive password, a Lenovo authorized servicer cannot reset your password or recover data from the hard disk. You must take your computer to a Lenovo authorized servicer or a marketing representative to have the hard disk drive replaced. Proof of purchase is required, and a fee will be charged for parts and service.
- If you forget your administrator password, a Lenovo authorized servicer cannot reset your password. You must take your computer to a Lenovo authorized servicer or a marketing representative to have the system board replaced. Proof of purchase is required, and a fee will be charged for parts and service.

Sleep problems

The critical low-battery error message appears, and the computer immediately turns off.

- The battery power is getting low. Connect the AC power adapter to the computer.

The computer enters sleep mode immediately after Power-on self-test (POST).

- Make sure that:
 - The battery pack is charged.
 - The operating temperature is within the acceptable range. See “Chapter 2. Use and care Information” in the *Lenovo Safety and General Information Guide*.

Note: If the battery pack is charged and the temperature is within range, have the computer serviced.

The computer does not return from sleep mode, and the computer does not work.

- If your computer is in sleep mode, connect the AC power adapter to the computer, then press any key or the Power button.
- If the system still does not return from sleep mode, stops responding, or cannot be turned off, reset the computer. Unsaved data may be lost. To reset the computer, press and hold the Power button for four seconds or more. If the computer is still not reset, remove the AC power adapter.

Display panel problems

The screen is blank.

- Do the following:
 - If you are using the AC power adapter or the battery pack, and the battery status indicator is on, press **F12** () to make the screen brighter.
 - If the power indicator is blinking, press the Power button to resume from sleep mode.
 - If the problem persists, follow the solution in the next problem “The screen is unreadable or distorted.”

The screen is unreadable or distorted.

- Make sure that:
 - The display device driver is installed correctly.
 - The screen resolution and color quality are correctly set.
 - The monitor type is correct.

Incorrect characters appear on the screen.

- Is the operating system or programs installed correctly? If they are installed and configured correctly, have the computer serviced.

Chapter 4. Troubleshooting

Sound problems

No sound can be heard from the speaker even when the volume is turned up.

- Make sure that:
 - The Mute function is off.
 - The combo audio jack is not being used.
 - Speakers are selected as the playback device.

Battery pack problems

Your computer shuts down before the battery status indicator shows empty.

-or-

Your computer operates after the battery status indicator shows empty.

The computer does not operate with a fully charged battery pack.

- Discharge and recharge the battery pack.
- The surge protector in the battery pack might be active. Turn off the computer for one minute to reset the protector; then turn on the computer again.

A hard disk drive problem

The hard disk drive does not work.

- Make sure that the hard disk drive is included in the **Boot** menu in the BIOS setup utility correctly.

Other problems

Your computer does not respond.

- To turn off your computer, press and hold the Power button for four seconds or more. If the computer still does not respond, remove the AC power adapter.
- Your computer might lock when it enters sleep mode during a communication operation. Disable the sleep timer when you are working on the network.

The computer does not start from a device you want.

- See the **Boot** menu of the BIOS setup utility. Make sure that the BIOS setup utility is set so that the computer starts from the device you want.
- Also make sure that the device from which the computer starts is enabled. Make sure that the device is included in the **Boot** menu in the BIOS setup utility correctly.
- While turned off, press the Novo button to select the device you want the computer to start from.

The connected external device does not work.

- Do *not* connect or disconnect any external device cables other than USB while the computer power is on. Otherwise, you might damage your computer.
- When using high power consumption external devices such as an external USB optical disk drive, use an external device power adapter. Otherwise, the device may not be recognized, or the system may shut down as a result.

Trademarks

The following terms are trademarks or registered trademarks of Lenovo in the United States, other countries, or both.

Lenovo
ideapad

Microsoft and Windows are trademarks of Microsoft Corporation in the United States, other countries, or both.

Other company, product, or service names may be trademarks or service marks of others.

