

USER MANUAL

MODEL:

SL-240C

**Master / Room Controller
& Kramer Control Brain**

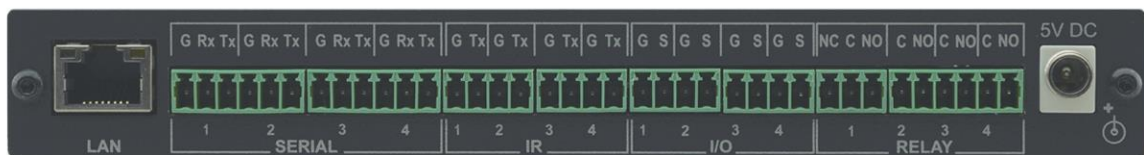

Contents

Introduction	1
Getting Started	1
Overview	2
Typical Applications	3
Controlling your SL-240C	3
Defining the SL-240C Master / Room Controller & Kramer Control Brain	4
Installing in a Rack	6
Connecting SL-240C	7
Connecting the Relay Ports	8
Remote Operation via the Web Pages	9
Loading and Saving Configurations	10
Viewing Connected Clients Information	11
Modifying Device Settings	11
Defining IP Settings	13
Configuring the Serial Ports	14
Configuring I/O Ports	15
Changing the State of a Relay Port	19
Teaching IR Commands	20
Activating Device Security	21
Using the Log	23
About Us Page	24
Resetting and Upgrading Firmware	25
Resetting to Factory Default Settings	25
Upgrading the Firmware	25
Technical Specifications	26
Default Communication Parameters	27
Default Security Parameters	27
Protocol 3000	28
Understanding Protocol 3000	29
Kramer Protocol 3000 Syntax	30
Protocol 3000 Commands	31
License Information	61

Introduction

Welcome to Kramer Electronics! Since 1981, Kramer Electronics has been providing a world of unique, creative, and affordable solutions to the vast range of problems that confront the video, audio, presentation, and broadcasting professional on a daily basis. In recent years, we have redesigned and upgraded most of our line, making the best even better!

Our 1,000-plus different models now appear in 14 groups that are clearly defined by function: GROUP 1: Distribution Amplifiers; GROUP 2: Switchers and Routers; GROUP 3: Control Systems; GROUP 4: Format & Standards Converters; GROUP 5: Range Extenders & Repeaters; GROUP 6: Specialty AV Products; GROUP 7: Scalers; GROUP 8: Cables and Connectors; GROUP 9: Room Connectivity; GROUP 10: Mounting and Rack Adapters; GROUP 11: Sierra Video; GROUP 12: Digital Signage; GROUP 13: Audio; GROUP 14: Collaboration; and GROUP 15: KM & KVM Switches.

Getting Started

We recommend that you:

- Unpack the equipment carefully and save the original box and packaging materials for possible future shipment.
- Review the contents of this user manual.



Go to www.kramerav.com/downloads/SL-240C to check for up-to-date user manuals, application programs, and to check if firmware upgrades are available (where appropriate).

Achieving the Best Performance

- Use only good quality connection cables (we recommend Kramer high-performance cables) to avoid interference, deterioration in signal quality due to poor matching, and elevated noise levels (often associated with low quality cables).
- Do not secure the cables in tight bundles or roll the slack into tight coils.
- Avoid interference from neighbouring electrical appliances that may adversely influence signal quality.
- Position your Kramer **SL-240C** away from moisture, excessive sunlight and dust.



This equipment is to be used only inside a building. It may only be connected to other equipment that is installed inside a building.

Safety Instructions



- Caution: There are no operator serviceable parts inside the unit
- Warning: Use only the Kramer Electronics power supply that is provided with the unit
- Warning: Disconnect the power and unplug the unit from the wall before installing

Recycling Kramer Products

The Waste Electrical and Electronic Equipment (WEEE) Directive 2002/96/EC aims to reduce the amount of WEEE sent for disposal to landfill or incineration by requiring it to be collected and recycled. To comply with the WEEE Directive, Kramer Electronics has made arrangements with the European Advanced Recycling Network (EARN) and will cover any costs of treatment, recycling and recovery of waste Kramer Electronics branded equipment on arrival at the EARN facility. For details of Kramer's recycling arrangements in your particular country go to our recycling pages at www.kramerav.com/support/recycling.

Overview

SL-240C is a compact master space controller (Kramer Control brain) with PoE. It can operate over Ethernet with control interfaces that include: four bidirectional RS-232, four IR, four GPI/O, and four relays. It controls devices such as scalers, video displays, audio amplifiers, Blu-ray players, sensors, screens, shades, door locks, and lights. Multiple Kramer Ethernet control gateways can be used to add remote I/O ports.

Main Features

- Kramer Control Space Controller – Controls any AV device/display with its corresponding logic.
- High Performance Architecture – Enables a scalable and flexible programming platform.
- 4 RS-232 Bidirectional Control Ports – For controlling devices via bi-directional serial control protocols.
- 4 IR Emitter & 1 IR Learning Control Port – Control devices via IR control protocols and learn commands from IR remotes.
- 4 GPI/O Control Ports – Control devices via general purpose I/O ports, program configured as digital input, digital output or analog input interface for controlling sensors, door locks, and lighting control devices.
- 4 Relay Control Ports – Control devices via low voltage relay contact closure, such as opening and closing drapes, shades, blinds, and projection screen scrolling.
- Resilient powering with PoE and optional PSU (not included).
- Network Support – 10/100/1000Mbps Ethernet.
- LED Indicators – Power, link, and system status.
- Software Management Support – Kramer Control, API, K-Upload.

Typical Applications

SL-240C is ideal for the following typical applications:

- Small to large spaces
- Retail stores
- Class rooms and lecture halls
- Auditoriums
- Government meeting rooms
- Court rooms
- Command and control applications

Controlling your SL-240C

Control your SL-240C directly via one of the following:

- Ethernet using built-in, user-friendly web pages (see [Remote Operation via the Web Pages](#) on page 9).
- Kramer Control Builder
- Kramer Control Client App
- Micro USB and Ethernet using Kramer Protocol 3000

Defining the SL-240C Master / Room Controller & Kramer Control Brain

This section defines SL-240C.

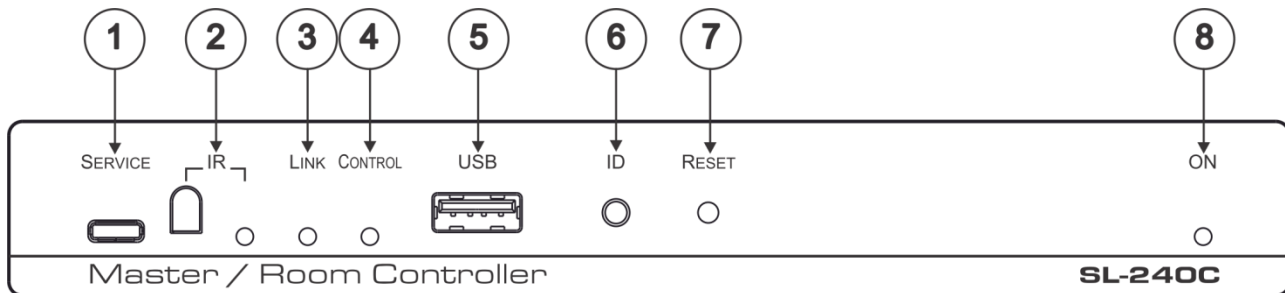

Figure 1: SL-240C Master / Room Controller & Kramer Control Brain Front Panel

#	Feature	Function
①	SERVICE Micro USB Connector	Connect to a PC to send P3K commands and perform a firmware upgrade (see Upgrading the Firmware on page 25).
②	IR Receiver and LED	Detects IR signals for IR learning. Lights blue when in IR learning mode.
③	LINK LED	Lights blue to indicate Ethernet activity: <ul style="list-style-type: none"> • On – good connection • Flashing – no connection • Off – before first connection
④	CONTROL LED	Lights to indicate control states of the control application (Brain): <ul style="list-style-type: none"> • Flashing – sending data • Green – ready and working • White – no devices are assigned • Blue – synchronizing • Yellow – one or more controlled devices are disconnected • Red – an error occurred • Purple – Brain booting up
⑤	USB Connector	For future use.
⑥	ID Button	For self-identification over the network. Press the button to send (broadcast) the #BEACON-INFO Protocol 3000 command. Reply includes: IP address, UDP port number, TCP port number, MAC address, and Model Name.
⑦	RESET Button	Press while performing a factory default reset (see Resetting to Factory Default Settings on page 25).
⑧	ON LED	Lights green when powered on.

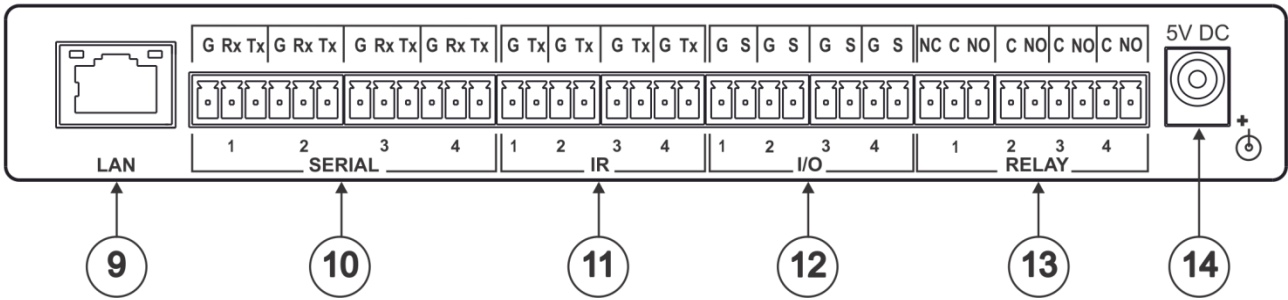

Figure 2: SL-240C Master / Room Controller & Kramer Control Brain Rear Panel

#	Feature	Function
9	LAN RJ-45 Connector	Connect to a local area network (supports PoE). Indications: LINK LED lights amber – 1000/100/10MB connection. DATA LED flashes green – Ethernet data link activity.
10	SERIAL Ports (1–4) Terminal Block	Connect to up to 4 serial controlled devices, for Ethernet-to-RS232 bidirectional tunneling.
11	IR Ports (1–4) Terminal Block	Connect to up to 4 IR emitters or blasters.
12	I/O Ports (1–4) Terminal Block	Connect to up to 4 sensors or devices to be controlled, for example, a motion sensor. Port may be configured as a digital input, digital output, or analog input (see Configuring I/O Ports on page 15).
13	RELAY Ports (1–4) Terminal Block	Connect to up to 4 devices to be controlled by relay for example, a motorized projection screen. 3 of the ports are NO and 1 port can be connected as NO or NC (see Connecting the Relay Ports on page 8).
14	5V DC Power Socket	Connect to the power adapter and to the mains electricity.

Installing in a Rack

This section provides instructions for rack mounting **SL-240C**. Before installing in a rack, verify that the environment is within the recommended range:

- Operation temperature – 0° to 40°C (32 to 104°F).
- Storage temperature – -40° to +70°C (-40 to +158°F).
- Humidity – 10% to 90%, RHL non-condensing.



When installing on a 19" rack, avoid hazards by taking care that:

- It is located within recommended environmental conditions. Operating ambient temperature of a closed or multi-unit rack assembly may exceed ambient room temperature.
- Once rack mounted, there is enough air flow around **SL-240C**.
- **SL-240C** is placed upright in the correct horizontal position.
- You do not overload the circuit(s). When connecting **SL-240C** to the supply circuit, overloading the circuits may have a detrimental effect on overcurrent protection and supply wiring. Refer to the appropriate nameplate ratings for information. For example, for fuse replacement, see the value printed on the product label.
- **SL-240C** is earthed (grounded) and connected only to an electricity socket with grounding. Pay particular attention when electricity is supplied indirectly (for example, when the power cord is not plugged directly into the wall socket but to an extension cable or power strip). Use only the supplied power cord.

To rack-mount SL-240C:

- Mount the unit in a rack using an optional **RK-T2B** rack adapter (see the RK-1T2PT, RK-2T1PT, RK-3T, RK-6T, RK-9T, RK-3TR, RK-4PT, **RK-T2B**, RK-T2SB User Manual at: www.kramerav.com/product/RK-T2B#Tab_Resources).
- Always mount **SL-240C** in the rack before connecting any cables or power.

Connecting SL-240C



Always switch off the power to each device before connecting it to your **SL-240C**. After connecting your **SL-240C**, connect its power and then switch on the power to each device.

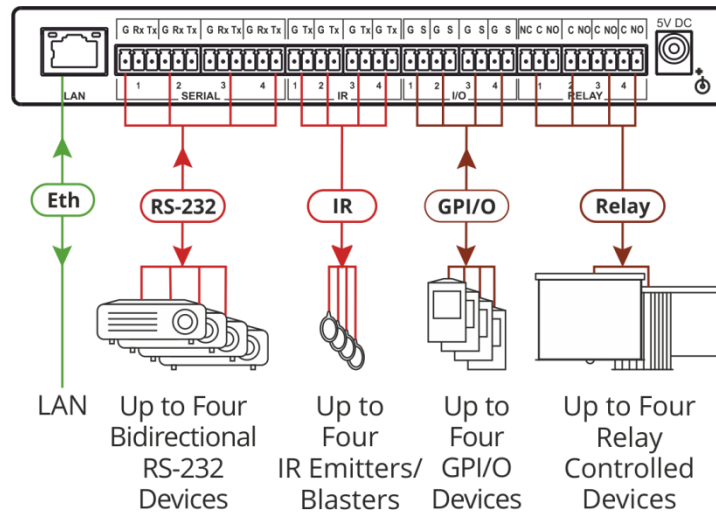

Figure 3: Connecting SL-240C

To connect SL-240C as illustrated in the example in [Figure 3](#), do the following:

1. Connect up to four bidirectional RS-232 devices to the SERIAL terminal block ports ⑩.
2. Connect up to four IR emitters or blasters to the IR terminal block ports ⑪.
3. Connect up to four GPIO (General Purpose I/O) devices to the I/O terminal block ports ⑫. No more than 30V can be connected.
4. Connect up to four relay controlled devices to the RELAY terminal block ports ⑬ (see [Connecting the Relay Ports](#) on page 8).
5. Connect to a LAN through the LAN RJ-45 connector ⑨.
6. Use a PoE enabled Ethernet cable to receive power from the network connection
OR
connect the 5V DC power adapter to the power socket ⑭ and to the mains electricity.

Connecting the Relay Ports

The normal state of the relay ports is as follows:

- Port 1 – can be connected as NO or NC (Normally Closed)
- Ports 2, 3 and 4 – NO (Normally Open)

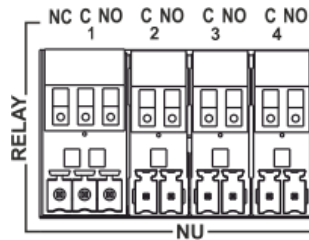

Figure 4: Relay Ports

To connect a ports as NO:

- Connect the device to the C (Common) and NO terminals of the relevant port.

To connect port 1 as NC:

- Connect the device to the C and NC terminal of port 1.

Remote Operation via the Web Pages

SL-240C embedded webpages enable you to define device settings, configure communication parameters, configure port settings, define security parameters, and view activity logs.



The specific parameter values shown in screenshots of this manual are merely representative.

To access the web pages:

1. Enter the IP address of the device (see [Default Communication Parameters](#) on page [27](#)) in the address bar of your browser.
The Loading page appears followed shortly by the General Info page.

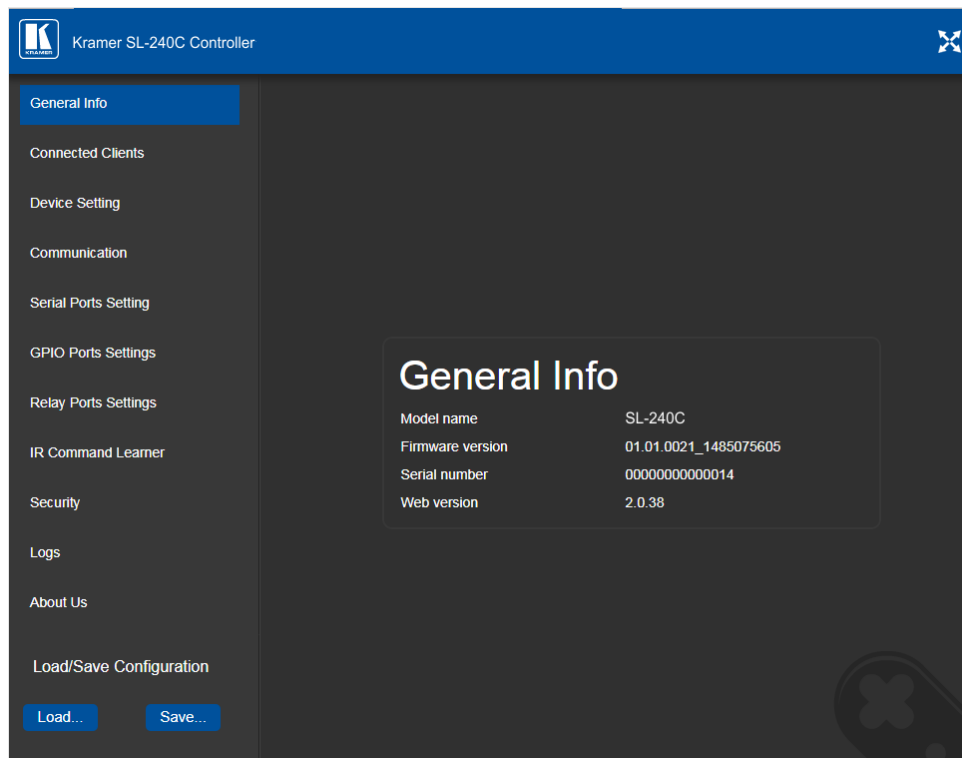

Figure 5: Embedded Web Pages – General Info Page

The General Info page displays the following:

- Model name
- Firmware version
- Serial number
- Web pages version

2. Click the tabs on the left side of the screen to access the relevant web page.

Loading and Saving Configurations

You can save a configuration for easy recall in the future.

At the bottom left hand side of all web pages there is a Load and a Save button. These enable you to save the current configuration and load any pre-saved configurations.

To load a configuration:

1. Click **Load**.
An Explorer window opens.
2. Select the required file and click **Open**.
The device is configured according to the saved preset.

To save the current configuration:

1. Configure the device as required.
2. Click **Save**.
The Save File window opens.
3. Browse to the required location to which to save the file.
4. Enter the required name for the saved preset.
5. Click **OK**.
The current configuration is saved.



When using Chrome, the file is automatically saved in the Downloads folder.

Viewing Connected Clients Information

SL-240C web pages enable you to view information for client devices that are connected to SL-240C via Ethernet.

To view connected clients information:

1. Click **Connected Clients** on the left side of the web page ([Figure 5](#)). The Connected Clients page appears.

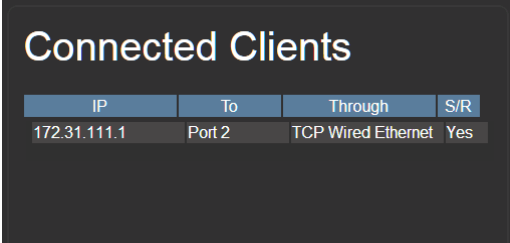

IP	To	Through	S/R
172.31.111.1	Port 2	TCP Wired Ethernet	Yes

Figure 6: Connected Clients Page

2. View the following connected clients information:
 - IP – IP address
 - To – The RS-232 port to which it is connected
 - Through – Method of connection
 - S/R – Whether or not Send Replies is enabled for the port (see [Configuring the Serial Ports](#) on page [14](#)).

Modifying Device Settings

SL-240C web pages enable you to modify the following device settings:

- Device Name
- Time and Date Settings

Changing the Device Name

SL-240C device name is used by DNS when addressing the device and is necessary for accessing the device for the first time using a Web browser.

To change the name of your device:

1. Click **Device Settings** on the left side of the web page ([Figure 5](#)). The Device Settings page appears.

Figure 7: Device Settings Page

2. In the General info area, enter a new name in the Device name field. The device name cannot include any spaces, can be up to 14 characters and can include letters, numbers, hyphens and underscores only.
3. Click **Save Changes**.

Setting the Date and Time

SL-240C web pages enable you to manually set the date and time for your **SL-240C** device or to use a time server to automatically set the date and time. Date and time settings are used by the device for logging purposes (see [Using the Log](#) on page 23), for time driven events as defined through Kramer Control Builder, and for successfully connecting to the Kramer Control cloud for provisioning, publishing, and dashboard support.

To set the date and time for your device:

1. Click **Device Settings** on the left side of the web page ([Figure 5](#)). The Device Settings page appears ([Figure 7](#)).
2. In the Time and Date area, if Use time server (NTP) is set to ON, click **OFF** and click in the relevant fields to define the date, time and time zone.

–OR–

3. Click the **ON** button, enter the time server address in the Time server address field, and click **Set**.

4. Click **Save Changes**.

Defining IP Settings



The default IP address setting for the device is DHCP ON.

To define static IP settings:

1. Click **Communication** on the left side of the web page ([Figure 5](#)). The Communication page appears.

A screenshot of a web interface titled "Communication". The page has a dark background with white text. It contains several input fields and buttons. At the top, "UDP Port" is set to "50000" and "TCP Port" is set to "5000", each with a "Set" button to its right. Below these is the "Ethernet" section. It shows "MAC" as "00-1d-56-03-13-b7". The "DHCP" setting is currently "ON", with "OFF" also visible. Below that, "IP address" is "192.168.0.112", "Mask" is "255.255.255.0", "Gateway" is "192.168.0.1", and "DNS 1" is "192.168.0.1". There is an empty field for "DNS 2". A "Set" button is located at the bottom right of the form.

Figure 8: Communication Page

2. In the Ethernet section, view the MAC address.
3. Click the DHCP **OFF** button.
4. Enter the required IP settings in the relevant fields.
5. Click **Set**.

Configuring the Serial Ports

SL-240C web pages enable you to configure each of the serial ports ⁽¹⁰⁾.

To configure a serial port:

1. Click **Serial Ports Setting** on the left side of the web page ([Figure 5](#)). The Serial Ports Setting page appears.

Figure 9: Serial Ports Setting Page

2. In the Port area, click a port number (1–4).
3. In the Settings area, click **UDP** or **TCP**.
4. Enter the IP Port number.
5. Enter a TCP Keepalive value between 0 and 3600 seconds. This value defines how often the unit sends a “keep alive” signal to the client. The default value is 60 seconds.
6. Define the serial settings as necessary (see [Default Communication Parameters](#) on page [27](#)).
7. Select whether or not to send replies on the port to a new connected client by default, (see [Viewing Connected Clients Information](#) on page [11](#)).
8. Click **Save Changes**.

Configuring I/O Ports

SL-240C web pages enable you to configure each of the I/O ports (12). The I/O ports control devices such as sensors, door locks, audio volume and lighting control devices.

To configure an I/O port:

1. Click **GPIO Ports Settings** on the left side of the web page ([Figure 5](#)). The GPIO Ports Settings page appears.

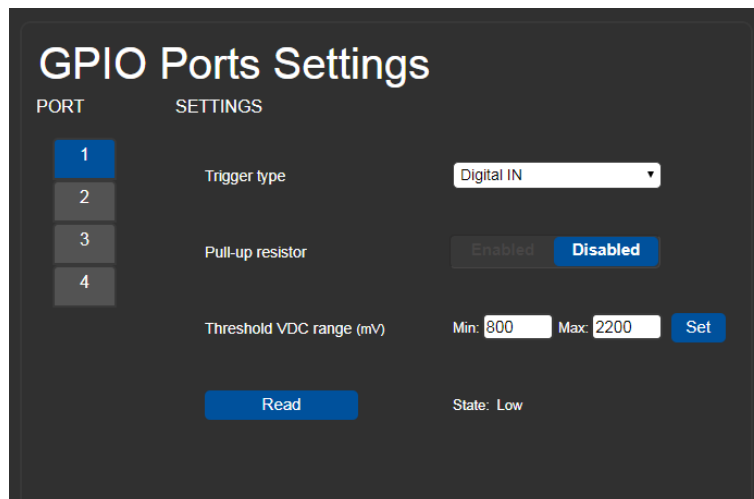

Figure 10: GPIO Ports Settings Page – Digital IN Trigger Type

2. In the Port area, click the number (1–4) of the port to be configured.
3. In the Settings area, select one of the following from the Trigger type option box:
 - **Digital Input** (see [Configuring a Digital Input Trigger Type](#) on page 16)
 - **Digital Output** (see [Configuring a Digital Out Trigger Type](#) on page 17)
 - **Analog Input** (see [Configuring an Analog In Trigger Type](#) on page 18)



The settings available on the page change depending on which trigger type is selected.

Configuring a Digital Input Trigger Type

Digital Input trigger mode reads the digital input of an external sensor device that is connected to the GPIO port, and detects High (upon passing Max threshold from Low state) or Low (upon passing Min threshold from High state) port states according to the user defined voltage threshold levels.

To configure a digital input trigger type:

1. On the GPIO Ports Settings page, select Digital IN from the Trigger type option box ([Figure 10](#)).
The Digital IN options appear ([Figure 10](#)).
2. Select one of the following for the Pull-up resistor setting:
 - **Enabled**
Detection of an open circuit as High, or a short to ground as Low. This is suitable for example, for a pushbutton switch (connecting one terminal of the switch to ground, and the other to the input) or for an alarm closing a circuit that activates a series of actions. When the pull-up resistor is enabled, the port state is high and to be triggered it must be pulled low by the externally connected sensor.
 - **Disabled**
Suitable, for example, for a high temperature alarm that exceeds the maximum voltage threshold. When the pull-up resistor is disabled, the port state is low and to be triggered it must be pulled high by the externally connected sensor.
3. Define the Min and Max for the Threshold VDC range (threshold voltage at which the port changes state) and click **Set**.

Configuring a Digital Out Trigger Type

To configure a digital output trigger type:

1. On the GPIO Ports Settings page, select Digital OUT from the Trigger type option box ([Figure 10](#)).
A Warning message appears.

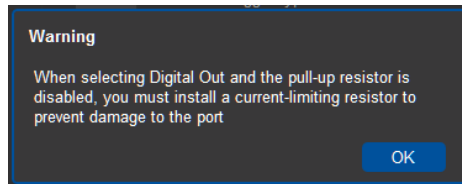

Figure 11: Digital Out Selection Warning

2. Click **OK**.
The Digital OUT options appear.

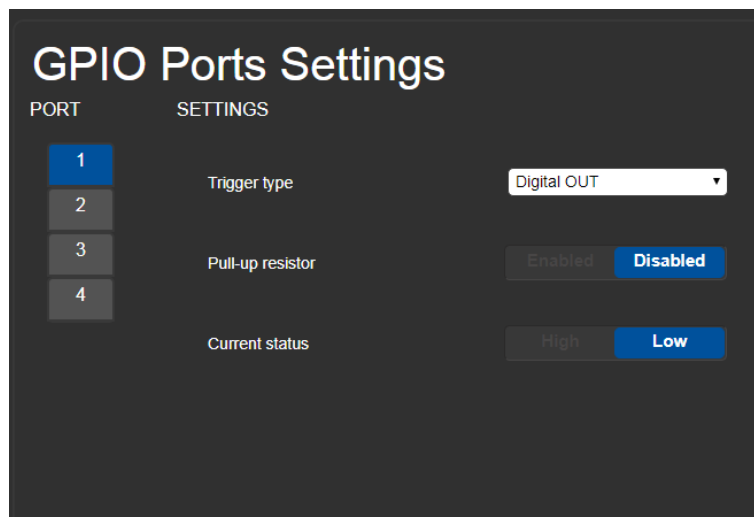

Figure 12: GPIO Ports Settings Page – Digital OUT Trigger Type

3. Select one of the following for the Pull-up resistor setting:
 - Pullup resistor enabled:
The port can be used for controlling devices that accept a TTL signal such as for powering LEDs. The voltage output is TTL positive logic: high: ~ 3.5V; low: ~ 0.3V. When the pull-up resistor is enabled, the port state is high. For the state to be low, you must click **Low** for the Current Status.
 - Pullup resistor disabled:
The port is used for controlling external devices such as room or light switches. The external source device determines the voltage output; the maximum voltage is 30V DC and the maximum current is 100mA. When the pull-up resistor is disabled, the port state is low and to set it high, you must click **High** for the Current Status.



Make sure that the current in this configuration does not exceed 100mA.

Configuring an Analog In Trigger Type

When you select the Analog IN trigger type, the port is triggered by an external analog device, such as a volume control device. The trigger is activated once when the detected voltage is within the 0 to 30V DC voltage range.



When the Analog IN trigger type is selected, the Pullup resistor and Threshold settings are disabled.

To configure an analog input trigger type:

1. On the GPIO Ports Settings page, select **Analog IN** from the Trigger type option box ([Figure 10](#)).
The Analog IN options appear.

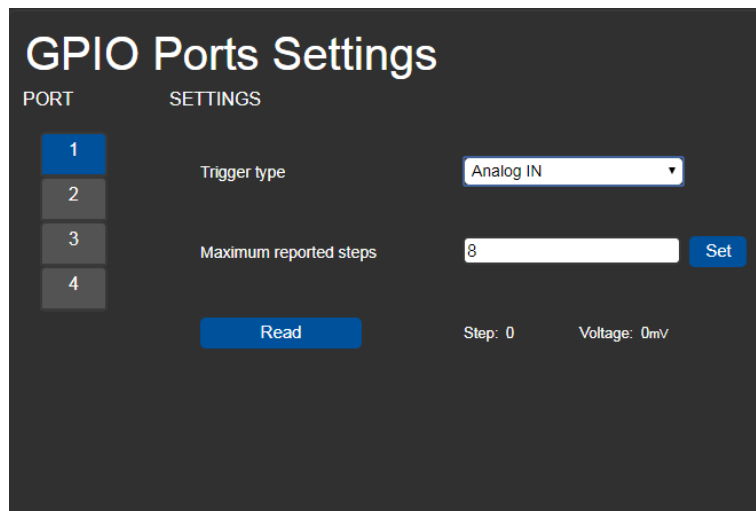

Figure 13: GPIO Port Settings Page Analog IN

2. Enter or use the arrows to scroll to a value (1–100) for the Maximum reported steps. This value is the number of steps that the analog input signal is divided into. To calculate the voltage of each step, use the following formula:
Voltage of one step = 30V / number of steps

Changing the State of a Relay Port

SL-240C web pages enable you to change the state of each of the relay ports ⁽¹³⁾.

The SL-240C relay ports have the following characteristics:

- Default state of relays 2–4 is NO (normally open)
- Default state of relay 1 can be NO or NC (normally closed), depending on how it is connected to the device (see [Connecting the Relay Ports](#) on page 8)
- Rated at 30V DC and 1A
- A non-latching relay function – the contact is left in its default state when unpowered or in power up state. This means that if a relay is in its non-default state and power is lost, the relay returns to its default state. To return it to its pre-power loss state, the setting must be changed using either the web pages or a Protocol 3000 command.

To change the state of a relay, (for example, relay 2):

1. Click **Relay Ports Settings** on the left side of the web page ([Figure 5](#)).
The Relay Ports Settings page appears.

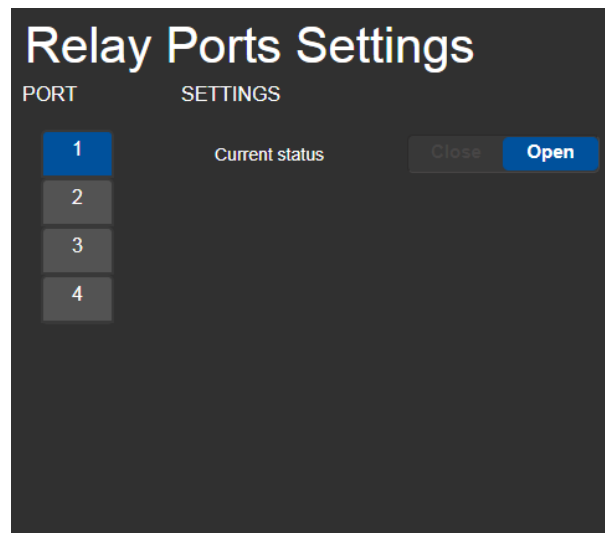

Figure 14: Relay Ports Settings Page

2. In the Port section, click the number (1–4) of the relay port to be changed.
The current status of the selected relay appears.
3. Click **Close/Open**.
The relay changes to the selected state.





When relay 1 is connected as NC (see [Connecting the Relay Ports](#) on page 8), the Current status buttons are reversed.

Clicking Open closes the relay and clicking Close opens the relay.

Teaching IR Commands

SL-240C web pages enable you to teach SL-240C IR commands. These can be saved for later use. The IR learning commands are in Pronto format.

-  While learning is in progress, the relevant IR LED  on the front panel lights and SL-240C is not available for normal operation.
-  At the start and end of learning a message is sent to all attached clients.

To teach a command to SL-240C:

1. Click **IR Command Learner** on the left side of the web page ([Figure 5](#)). The IR Command Learner page appears.

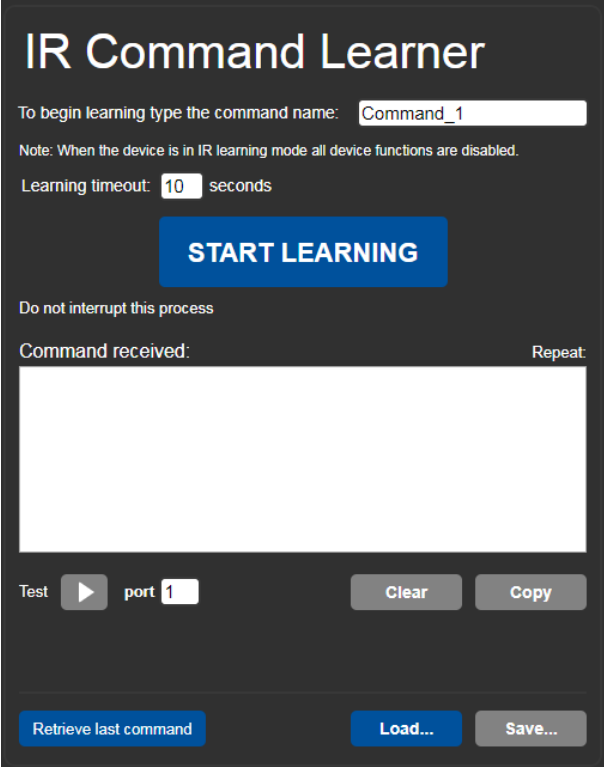

Figure 15: IR Command Learner Page

2. Enter a name for the command in the first field.
3. Enter a value in the Learning timeout field.
This value defines how long the system waits to receive a command before exiting learning mode.
4. Click **Start Learning**.
5. Position the IR remote control approximately 5cm to 7cm (2in to 2.7in) from the SL-240C front panel.
6. Send a command with the remote control.
The command string received during the process appears in the Command received box.

7. Click **Copy**.
The command string is copied to the clip board.
8. Paste the command string into a control application.



Depending on the application, the format of the command string may have to be modified.

9. (Optional) Select the port on which to test the learned command and press the Test **play** button.
The command runs on the selected port.
10. Click **Save** to save the new command.
11. To delete the current command, click **Clear**.
12. To retrieve a previously saved command, click **Load**.

Activating Device Security

SL-240C web pages enable you to turn logon security (authentication) on or off. When security is on, access to the Web pages is granted only on submission of a valid user name and password. For default logon credentials see [Default Security Parameters](#) on page [27](#).

To activate Web page security:

1. Click **Security** on the left side of the web page ([Figure 5](#)).
The **Security** page appears.

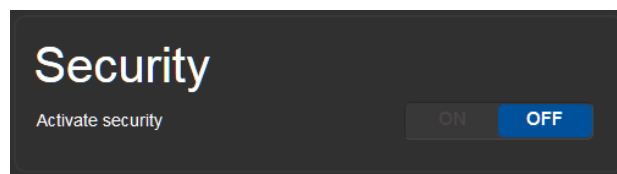

Figure 16: Security Page

2. Click **ON**.
A confirmation message appears.

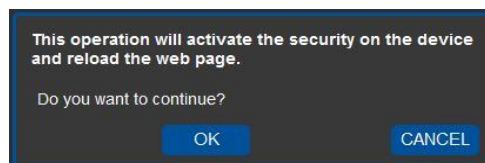

Figure 17: Security Confirmation Message

3. Click **OK**.
The **Authentication Required** window appears.

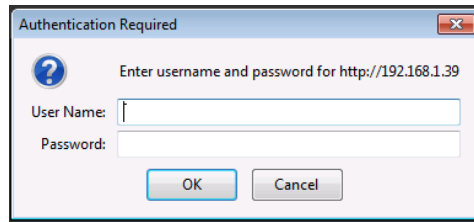

Figure 18: Authentication Required Window

4. Enter the default username and password (see [Default Security Parameters](#) on page [27](#)).
5. Click **OK**.
The web pages reload and the General Info page ([Figure 5](#)) appears.
6. Click **Security** on the left side of the web page.
The **Security** page appears with the Change Password settings.

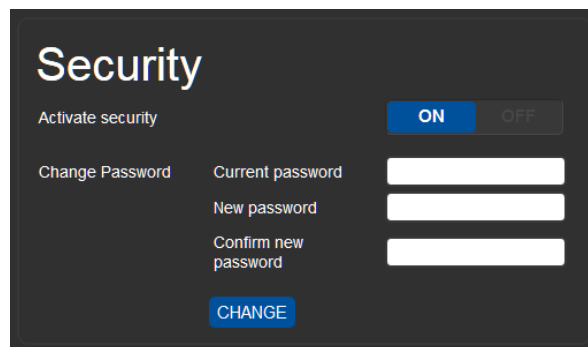

Figure 19: Security Activated Page

7. If required, change the password and click **Change**.

Using the Log



This feature is for future use and is not yet available.

SL-240C web pages enable you to view the current log entries, search log entries with filters and configure the types of events the log records.

The log file is updated once per minute.

To use the log:

1. Click **Logs** on the left side of the web page ([Figure 5](#)). The **Logs** page appears.

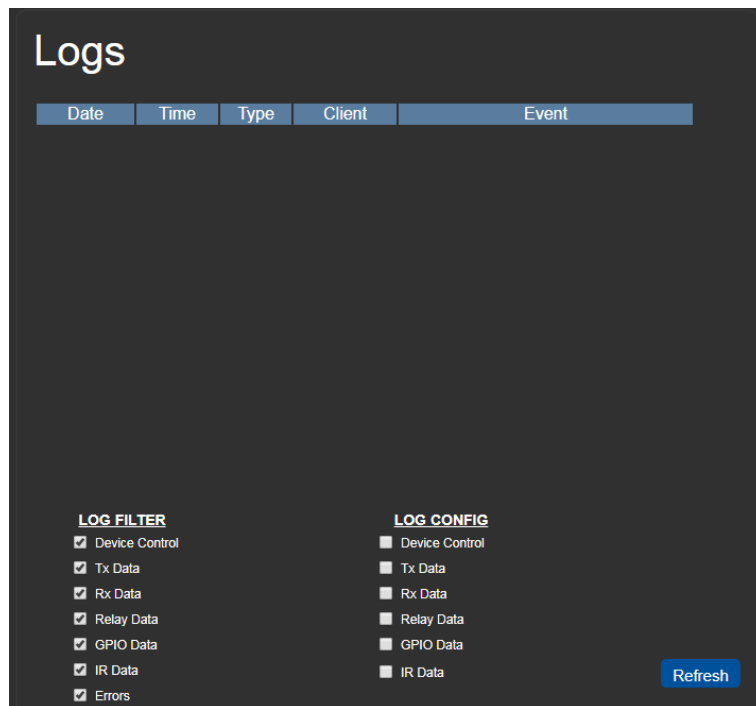

Figure 20: Logs Page

2. Select any of the options in the Log Filter list to define which types of events are displayed.
3. Select any of the options in the Log Config list to define which types of events are recorded.



The display may not update automatically. Click **Refresh** to update the display.

About Us Page

Click **About** on the left side of the web page ([Figure 5](#)).to display the web page version and Kramer company information.



Figure 21: About Us Page – Example

Resetting and Upgrading Firmware

Resetting to Factory Default Settings

To reset the device to its factory default settings:

1. Press and hold the *RESET* button  on the rear panel for 6 seconds.
2. Release the *RESET* button.
Wait for the reset process to complete.
The device is reset to the factory default settings.

Upgrading the Firmware

SL-240C enables upgrading the device firmware via Ethernet or USB using the K-Upload software application, available at <http://www.kramerav.com/product/SL-240C>. For instructions on upgrading the firmware using K-Upload, see the *K-Upload User Manual*.



It is recommended to upgrade the firmware via Ethernet.

Technical Specifications

Inputs	1 IR	Built-in sensor (for learning)
Outputs	4 IR	On 2-pin terminal block connectors
	4 Relays	1 (NC or NO) on a 3-pin terminal block connector 3 (NO) on 2-pin terminal block connectors
Ports	4 RS-232 Serial	On 3-pin terminal blocks
	4 GPI/O	On 2-pin terminal blocks
	1 Ethernet	On an RJ-45 connector
	1 USB	On a USB Type-A connector (for future use)
Processing	Processor Speed	1GHz
	Memory	512MB RAM, 4GB Flash
Electrical	Power Consumption	5V DC, 2A
Environmental Conditions	Operating Temperature	0° to +40°C (32° to 104°F)
	Storage Temperature	-40° to +70°C (-40° to 158°F)
	Humidity	10% to 90%, RHL non-condensing
Regulatory Compliance	Safety	CE
Enclosure	Size	MegaTOOLS® — Mount 2 units side-by-side in a 1U rack space with the optional RK-T2B rack adapter.
	Type	Aluminum
General	Net Dimensions (W, D, H)	18.75cm x 11.50cm x 2.54cm (7.38" x 4.53" x 1.00") W, D, H
	Shipping Dimensions (W, D, H)	34.50cm x 16.50cm x 5.20cm (13.58" x 6.50" x 2.05") W, D, H
	Net Weight	0.4kg (1.0lbs) approx.
	Shipping Weight	1.0kg (2.2lbs) approx.
Accessories	Included	5V DC power adapter, bracket set
	Optional	RK-T2B rack adapter. For optimum range and performance use the recommended USB, Ethernet, serial and IR Kramer cables available at www.kramerav.com/product/SL-240C
Specifications are subject to change without notice at www.kramerav.com		

Default Communication Parameters

RS-232 over Micro USB	
Baud Rate:	115200
Data Bits:	8
Stop Bits:	1
Parity:	None
Command Format:	ASCII
Example (Set configuration for I/O port number 1 to digital input with the pull-up enabled): #GPIO-CFG 1,1,0,1<CR>	
Ethernet	
DHCP is enabled by factory default, the following are the default addresses if no DHCP server is found.	
IP Address:	192.168.1.39
Subnet Mask:	255.255.0.0
Default Gateway:	192.168.0.1
TCP Port #:	5000
Concurrent TCP Connections:	500
Full Factory Reset	
Front panel buttons	Press and hold the <i>RESET</i> button  on the rear panel for 6 seconds. See Resetting to Factory Default Settings on page 25.

Default Security Parameters

- Default User Name: Admin
- Default Password: adminpw

Protocol 3000

The **SL-240C** Master / Room Controller & Kramer Control Brain can be operated using the Kramer Protocol 3000 serial commands.

The command framing varies according to how you interface with a device. For example, a basic video input switching command that routes a layer 1 video signal to HDMI out 1 from HDMI input 2 (`ROUTE 1, 1, 2`), is entered as follows:

- Terminal communication software, such as Hercules:

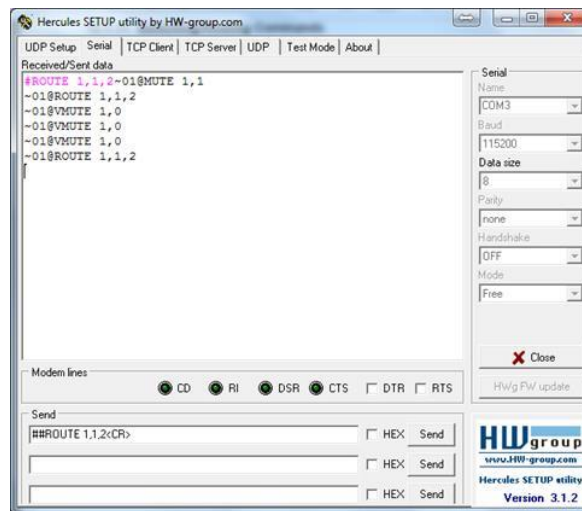

 The above image is for illustration purposes only.

 The framing of the command varies according to the terminal communication software.

You can enter commands directly using terminal communication software (e.g., Hercules) by connecting a PC to the serial or Ethernet port on **SL-240C**. To enter `CR` press the Enter key (`LF` is also sent but is ignored by the command parser).

Commands sent from various non-Kramer controllers (e.g., Crestron) may require special coding for some characters (such as, `/x##`). For more information, refer to your controller's documentation.

For more information about:

- Using Protocol 3000 commands, see [Understanding Protocol 3000](#) on page [29](#)
- General syntax used for Protocol 3000 commands, see [Kramer Protocol 3000 Syntax](#) on page [30](#)
- Protocol 3000 commands available for **SL-240C**, see [Protocol 3000 Commands](#) on page [31](#)

Understanding Protocol 3000

Protocol 3000 commands are structured according to the following:

- **Command** – A sequence of ASCII letters (A–Z, a–z and –). A command and its parameters must be separated by at least one space.
- **Parameters** – A sequence of alphanumeric ASCII characters (0–9, A–Z, a–z and some special characters for specific commands). Parameters are separated by commas.
- **Message string** – Every command entered as part of a message string begins with a message starting character and ends with a message closing character.

 A string can contain more than one command. Commands are separated by a pipe (|) character. The maximum string length is 64 characters.

- **Message starting character:**
 - # – For host command/query
 - ~ – For device response
- **Query sign** –? follows some commands to define a query request
- **Message closing character:**
 - `CR` – Carriage return for host messages (ASCII 13)
 - `CR LF` – Carriage return for device messages (ASCII 13) and line-feed (ASCII 10)
- **Command chain separator character** – Multiple commands can be chained in the same string. Each command is delimited by a pipe character (|). When chaining commands, enter the message starting character and the message closing character only at the beginning and end of the string.

 Spaces between parameters or command terms are ignored. Commands in the string do not execute until the closing character is entered. A separate response is sent for every command in the chain.

Kramer Protocol 3000 Syntax

The Kramer Protocol 3000 syntax uses the following delimiters:

- **CR** = Carriage return (ASCII 13 = 0x0D)
- **LF** = Line feed (ASCII 10 = 0x0A)
- **SP** = Space (ASCII 32 = 0x20)

Some commands have short name syntax in addition to long name syntax to enable faster typing. The response is always in long syntax.

The Protocol 3000 syntax is in the following format:

- Host Message Format:

Start	Address (optional)	Body	Delimiter
#	<i>Device_id@</i>	Message	CR

- **Simple Command** – Command string with only one command without addressing:

Start	Body	Delimiter
#	Command SP <i>Parameter_1,Parameter_2,...</i>	CR

- **Command String** – Formal syntax with command concatenation and addressing:

Start	Address	Body	Delimiter
#	<i>Device_id@</i>	Command_1 <i>Parameter1_1,Parameter1_2,...</i> Command_2 <i>Parameter2_1,Parameter2_2,...</i> Command_3 <i>Parameter3_1,Parameter3_2,...</i> ...	CR

- Device Message Format:

Start	Address (optional)	Body	Delimiter
~	<i>Device_id@</i>	Message	CR LF

- Device Long Response – Echoing command:

Start	Address (optional)	Body	Delimiter
~	<i>Device_id@</i>	Command SP [<i>Param1 ,Param2</i> <i>...</i>] result	CR LF

Protocol 3000 Commands

This section includes the following commands:

- [System Commands](#) (page 31)
- [Communication Commands](#) (page 38)
- [I/O Gateway Commands](#) (page 45)
- [File System Commands](#) (page 54)
- [Authentication Commands](#) (page 58)

System Commands

Command	Description
#	Protocol handshaking
BUILD-DATE	Get device build date
FACTORY	Reset to factory default configuration
HELP	Get command list
LOG-TAIL	Get the last lines of message logs
MODEL	Get device model
NAME	Set/get machine (DNS) name
NAME-RST	Reset machine (DNS) name to factory default
PROT-VER	Get device protocol version
RESET	Reset device
SN	Get device serial number
TIME	Get/set device time and date
TIME-LOC	Get/set local time offset from UTC/GMT
VERSION	Get device firmware version

BUILD-DATE

Functions	Permission	Transparency
Set: -	-	-
Get: BUILD-DATE?	End User	Public
Description	Syntax	
Set: -	-	
Get: Get device build date	#BUILD-DATE? <code>CR</code>	
Response		
~nn@ BUILD-DATE <code>SP</code> date <code>SP</code> time <code>CR LF</code>		
Parameters		
date – Format: <i>YYYY/MM/DD</i> where <i>YYYY</i> = Year, <i>MM</i> = Month, <i>DD</i> = Day		
time – Format: <i>hh:mm:ss</i> where <i>hh</i> = hours, <i>mm</i> = minutes, <i>ss</i> = seconds		
Response Triggers		
Notes		
Example		
#BUILD-DATE? <code><CR></code>		

FACTORY

Functions		Permission	Transparency
Set:	FACTORY	End User	Public
Get:	-	-	-
Description		Syntax	
Set:	Reset device to factory default configuration	# FACTORY <CR>	
Get:	-	-	
Response			
~nn@ FACTORY <SP>ok<CR Lf>			
Parameters			
Response Triggers			
Notes			
This command deletes all user data from the device. The deletion can take some time. Power cycle the device after performing the reset to apply the changes.			
Example			
# FACTORY <CR>			

HELP

Functions		Permission	Transparency
Set:	-	-	-
Get:	HELP	End User	Public
Description		Syntax	
Set:	-	-	
Get:	Get command list or help for specific command	1. # HELP <CR> 2. # HELP <SP>command_name<CR>	
Response			
1. Multi-line: ~nn@Device available protocol 3000 commands:<CRLF> command,<SP>command...<CR Lf>			
2. Multi-line: ~nn@ HELP <SP>command:<CR Lf>description<CR Lf>USAGE:usage<CR Lf>			
Parameters			
command_name – name of a specific command			
Response Triggers			
Notes			
Example			
1. Get a list of all SL-240C commands: # HELP <CR>			
2. Get help for the ETH-PORT command: # HELP ETH-PORT<CR>			

LOG-TAIL

Function		Permission	Transparency
Set:	–	–	–
Get:	LOG-TAIL?	End User	Public
Description		Syntax	
Set:	–	–	
Get:	Get the last lines of message logs	#LOG-TAIL? <input type="text"/> <i>line_num</i> <input type="text"/>	
Response			
Multi-line:			
~ <input type="text"/> @LOG-TAIL? <input type="text"/>			
<i>Line #1 content</i> <input type="text"/>			
<i>Line #2 content</i> <input type="text"/>			
Etc...			
Parameters			
<i>line_num</i> : the number of lines to display 1–n (n = the number of lines in the entire log). If this parameter is omitted, it returns the last 20 lines of the log by default.			
Response Triggers			
Notes			
Used for advanced troubleshooting. Helps find error root causes and gets details not displayed in the error code number.			
Example			
Get the last 20 lines of message logs: #LOG-TAIL?<CR>			
Get the last 50 lines of message logs: #LOG-TAIL? 50<CR>			

MODEL

Functions		Permission	Transparency
Set:	-	-	-
Get:	MODEL?	End User	Public
Description		Syntax	
Set:	-	-	
Get:	Get device model	# MODEL? <code>[CR]</code>	
Response			
~ <code>[nn]</code> @ MODEL? <code>[SP]</code> <i>model_name</i> <code>[CR LF]</code>			
Parameters			
<i>model_name</i> – String of up to 19 printable ASCII chars			
Response Triggers			
Notes			
Example			
# MODEL? <CR>			

NAME

Functions		Permission	Transparency
Set:	NAME	Administrator	Public
Get:	NAME?	End User	Public
Description		Syntax	
Set:	Set machine (DNS) name	# NAME <code>[SP]</code> <i>machine_name</i> <code>[CR]</code>	
Get:	Get machine (DNS) name	# NAME? <code>[CR]</code>	
Response			
~ <code>[nn]</code> @ NAME? <code>[SP]</code> <i>machine_name</i> <code>[CR LF]</code>			
Parameters			
<i>machine_name</i> —String of up to 14 alpha-numeric characters (can include hyphens but not at the beginning or end)			
Response Triggers			
Notes			
The machine name is not the same as the model name. The machine name is used to identify a specific machine or a network in use (with DNS feature on).			
Example			
Set the DNS name of the device to “room-442”: # NAME room-442<CR>			

NAME-RST

Functions		Permission	Transparency
Set:	NAME-RST	Administrator	Public
Get:	-	-	-
Description		Syntax	
Set:	Reset machine (DNS) name to factory default	# NAME-RST <CR>	
Get:	-	-	
Response			
~nn@ NAME-RST <SP>OK<CR LF>			
Parameters			
Response Triggers			
Notes			
Factory default of machine (DNS) name is "SL-240C-XXXXXX", where XXXXXX = the last 6 digits of the serial number.			
Example			
Reset the DNS name of the device to the factory default: # NAME-RST <CR>			

PROT-VER

Functions		Permission	Transparency
Set:	-	-	-
Get:	PROT-VER?	End User	Public
Description		Syntax	
Set:	-	-	
Get:	Get device protocol version	# PROT-VER? <CR>	
Response			
~nn@ PROT-VER <SP>3000:version<CR LF>			
Parameters			
version-XX.XX where X is a digit			
Response Triggers			
Notes			
Example			
# PROT-VER? <CR>			

RESET

Functions		Permission	Transparency
Set:	RESET	Administrator	Public
Get:	-	-	-
Description		Syntax	
Set:	Reset device	# RESET <CR>	
Get:	-	-	
Response			
~nn@ RESET <SP>OK<CR LF>			
Parameters			
Response Triggers			
Notes			
Example			
# RESET <CR>			

SN

Functions		Permission	Transparency
Set:	-	-	-
Get:	SN?	End User	Public
Description		Syntax	
Set:	-	-	
Get:	Get device serial number	# SN? <CR>	
Response			
~nn@ SN <SP>serial_number<CR LF>			
Parameters			
serial_number–14 digits, factory assigned			
Response Triggers			
Notes			
This device has a 14 digit serial number.			
Example			
# SN? <CR>			

TIME

Functions		Permission	Transparency
Set:	TIME	Administrator	Public
Get:	TIME?	End User	Public
Description		Syntax	
Set:	Set device time and date	# TIME [SP] <i>day_of_week,date,time</i> [CR]	
Get:	Get device time and date	# TIME? [CR]	
Response			
~[nn]@ TIME [SP] <i>day_of_week,date,time</i> [CR LF]			
Parameters			
<i>day_of_week</i> – options: SUN, MON, TUE, WED, THU, FRI, SAT <i>date</i> – format: DD-MM-YYYY <i>time</i> – format: hh:mm:ss			
Response Triggers			
Notes			
The year must be 4 digits The device does not validate the day of week from the date Time format – 24 hours Date format – Day, Month, Year			
Example			
Set device time to Monday, August 8, 2017 at 3:00pm: #TIME MON,29-08-2017,15:00:00<CR>			

TIME-LOC

Functions		Permission	Transparency
Set:	TIME-LOC	End User	Public
Get:	TIME-LOC?	End User	Public
Description		Syntax	
Set:	Set local time offset from UTC/GMT	# TIME-LOC [SP] <i>UTC_off,DayLight</i> [CR]	
Get:	Get local time offset from UTC/GMT	# TIME-LOC? [CR]	
Response			
~[nn]@ TIME-LOC [SP] <i>UTC_off,DayLight</i> [CR LF]			
Parameters			
<i>UTC_off</i> – offset of device local time from UTC/GMT (without daylight time correction): -12 (subtract 12 hours from UTC/GMT) – 14 (add 14 hours to UTC/GMT) <i>DayLight</i> – use 0, see notes.			
Response Triggers			
Notes			
This command is relevant only if the time server is configured. Device time calculates by adding <i>UTC_off</i> to UTC time (that it got from the time server) + 1 hour if daylight savings time is in effect. The <i>DayLight</i> parameter is no longer in use, because daylight savings time information is received from the time server. This parameter is maintained only for backward compatibility. The TIME command sets the device time without considering these settings.			
Example			
Set device local time to US EST (Eastern Standard Time = -5 UTC/GMT): #TIME-LOC -5,0<CR>			

VERSION

Functions		Permission	Transparency
Set:	-	-	-
Get:	VERSION?	End User	Public
Description		Syntax	
Set:	-	-	
Get:	Get firmware version number	# VERSION? <input type="checkbox"/> CR	
Response			
~ <input type="checkbox"/> nn@ VERSION <input type="checkbox"/> SPfirmware_version <input type="checkbox"/> CR LF			
Parameters			
<i>firmware_version</i> – XX.XX.XXXX where the digit groups are: major.minor.build version			
Response Triggers			
Notes			
Example			
# VERSION? <CR>			

Communication Commands

Command	Description
BEACON-INFO	Get beacon information, including IP address, UDP control port, TCP control port, MAC address, model, name
ETH-PORT	Set/get Ethernet port protocol
NET-CONFIG	Set a network configuration
NET-DHCP	Set/get DHCP mode
NET-DNS	Get DNS name server
NET-GATE	Set/get gateway IP
NET-IP	Set/get IP address
NET-MAC	Get MAC address
NET-MASK	Set/get subnet mask
TIME-SRV	Get/set time server
UART	Get/set com port configuration

BEACON-INFO

Functions		Permission	Transparency
Set:	–	–	–
Get:	BEACON-INFO?	End User	Public
Description		Syntax	
Set:	–	–	
Get:	Get beacon information, including IP address, UDP control port, TCP control port, MAC address, model, name	# BEACON-INFO? <code>[SP]</code> <i>port_id</i> <code>[CR]</code>	
Response			
~ <code>[nn]</code> @ BEACON-INFO <code>[SP]</code> <i>port_id</i> , <i>ip_string</i> , <i>udp_port</i> , <i>tcp_port</i> , <i>mac_address</i> , <i>model</i> , <i>name</i> <code>[CR LF]</code>			
Parameters			
<i>port_id</i> – ID of the Ethernet port, 0 (wired Ethernet connection). 1 and higher (for future use). <i>ip_string</i> – dot-separated representation of the IP address <i>udp_port</i> – UDP control port <i>tcp_port</i> – TCP control port <i>mac_address</i> – dash-separated MAC address <i>model</i> – device model <i>name</i> – device name			
Response Triggers			
After execution, notification is sent containing beacon information.			
Notes			
There is no Set command. The <i>port_id</i> parameter is not necessary and can be omitted.			
Example			
Get beacon information for port 0: # BEACON-INFO? 0< <code>CR</code> >			

ETH-PORT

Functions		Permission	Transparency
Set:	ETH-PORT	Administrator	Public
Get:	ETH-PORT?	End User	Public
Description		Syntax	
Set:	Set Ethernet port protocol	# ETH-PORT [SP] <i>portType</i> , <i>ETHPort</i> CR	
Get:	Get Ethernet port protocol	# ETH-PORT? [SP] <i>portType</i> CR	
Response			
~ nn @ ETH-PORT [SP] <i>portType</i> , <i>ETHPort</i> CR LF			
Parameters			
<i>portType</i> – string of 3 letters indicating the port type: TCP, UDP <i>ETHPort</i> – TCP / UDP port number: 0–65535			
Response Triggers			
Notes			
If the port number you enter is already in use, an error is returned The port number must be within the following range: 0–(2 ¹⁶ -1)			
Example			
Set the Ethernet port protocol for TCP to port 12457: #ETH-PORT TCP,12457<CR>			

NET-CONFIG

Functions		Permission	Transparency
Set:	NET-CONFIG	End User	Public
Get:	NET-CONFIG?	End User	Public
Description		Syntax	
Set:	Set a network configuration.	# NET-CONFIG [SP] <i>id</i> , <i>ip</i> , <i>net_mask</i> , <i>gateway</i> , <i>dns1</i> , <i>dns2</i> CR LF	
Get:	Get a network configuration.	# NET-CONFIG? [SP] <i>id</i> CR LF	
Response			
Get: ~ nn @ NET-CONFIG [SP SP] <i>id</i> , <i>ip</i> , <i>net_mask</i> , <i>gateway</i> , <i>dns1</i> , <i>dns2</i> CR LF			
Parameters			
<i>id</i> – Ethernet connection ID number: 0 <i>ip</i> – network IP address, in the following format: xxx.xxx.xxx.xxx <i>net_mask</i> – network mask, in the following format: xxx.xxx.xxx.xxx <i>gateway</i> – network gateway, in the following format: xxx.xxx.xxx.xxx <i>dns1</i> – optional, dns address, in the following format: xxx.xxx.xxx.xxx <i>dns2</i> – optional, second dns address, in the format: xxx.xxx.xxx.xxx			
Response Triggers			
Notes			
<i>dns</i> shows as 0.0.0.0 if not defined.			
Example			
Set the device network parameters to IP address 192.168.113.10, net mask 255.255.0.0, gateway 192.168.0.1 and dns address 192.168.0.1: #NET-CONFIG 0,192.168.113.10,255.255.0.0,192.168.0.1,192.168.0.1,0.0.0.0<CR>			

NET-DHCP

Functions		Permission	Transparency
Set:	NET-DHCP	Administrator	Public
Get:	NET-DHCP?	End User	Public
Description		Syntax	
Set:	Set DHCP mode	# NET-DHCP [SP] <i>mode</i> [CR]	
Get:	Get DHCP mode	# NET-DHCP? [CR]	
Response			
~ <i>nn</i> @ NET-DHCP [SP] <i>mode</i> [CR LF]			
Parameters			
<i>mode</i> – 0 (do not use DHCP. Use the IP address set by the factory, the NET-IP command, or the NET-CONFIG command), 1 (try to use DHCP. If unavailable, fallback to the fallback ip address).			
Response Triggers			
Notes			
To connect with an assigned IP by DHCP, specify the device DNS name (if available) using the NAME command. You can also get an assigned IP by direct connection to RS-232 protocol port if available.			
Example			
Enable DHCP mode, if available: # NET-DHCP 1<CR>			

NET-DNS

Functions		Permission	Transparency
Set:	-	-	-
Get:	NET-DNS?	End User	Public
Description		Syntax	
Set:	-	-	
Get:	Get DNS name server	# NET-DNS? [SP] <i>dns_id</i> [CR]	
Response			
~ <i>nn</i> @ NET-DNS [SP] <i>dns_id</i> , <i>ip</i> [CR LF]			
Parameters			
<i>dns_id</i> – ID of the DNS name server to retrieve: 0 (DNS server 1), 1 (DNS server 2) <i>ip</i> – IP address of the DNS server			
Response Triggers			
After execution, response is sent to the com port that sent the Get command			
Notes			
There is no “Set” command. Use the NET-CONFIG command to setup the network, including DNS name servers. If <i>dns_id</i> is out of the defined DNS range, Error Code #3 (ERR_PARAMETER_OUT_OF_RANGE) is returned. If no <i>dns_id</i> is defined, Error Code #3 is returned for any <i>dns_id</i> .			
Example			
Get the IP address of DNS name server 1: # NET-DNS? 0<CR>			

NET-GATE

Functions		Permission	Transparency
Set:	NET-GATE	Administrator	Public
Get:	NET-GATE?	End User	Public
Description		Syntax	
Set:	Set gateway IP	# NET-GATE <u>SP</u> <i>ip_address</i> <u>CR</u>	
Get:	Get gateway IP	# NET-GATE? <u>CR</u>	
Response			
~ <u>nn</u> @ NET-GATE <u>SP</u> <i>ip_address</i> <u>CR LF</u>			
Parameters			
<i>ip_address</i> – gateway IP address, in the following format: xxx.xxx.xxx.xxx			
Response Triggers			
Notes			
A network gateway connects the device via another network, possibly over the Internet. Be aware of security issues. Consult your network administrator for correct settings.			
Example			
Set the gateway IP address to 192.168.0.1: #NET-GATE 192.168.000.001<CR>			

NET-IP

Functions		Permission	Transparency
Set:	NET-IP	Administrator	Public
Get:	NET-IP?	End User	Public
Description		Syntax	
Set:	Set IP address	# NET-IP <u>SP</u> <i>ip_address</i> <u>CR</u>	
Get:	Get IP address	# NET-IP? <u>CR</u>	
Response			
~ <u>nn</u> @ NET-IP <u>SP</u> <i>ip_address</i> <u>CR LF</u>			
Parameters			
<i>ip_address</i> – IP address, in the following format: xxx.xxx.xxx.xxx			
Response Triggers			
Notes			
Consult your network administrator for correct settings.			
Example			
Set the IP address to 192.168.1.39: #NET-IP 192.168.001.039<CR>			

NET-MAC

Functions		Permission	Transparency
Set:	-	-	-
Get:	NET-MAC?	End User	Public
Description		Syntax	
Set:	-	-	
Get:	Get MAC address	# NET-MAC? <code>[CR]</code>	
Response			
~ <code>[nn]</code> @ NET-MAC <code>[SP]</code> <i>mac_address</i> <code>[CR LF]</code>			
Parameters			
<i>mac_address</i> – unique MAC address. Format: <i>xx-xx-xx-xx-xx-xx</i> where <i>x</i> is hex digit			
Response Triggers			
Notes			
Example			
#NET-MAC? <code><CR></code>			

NET-MASK

Functions		Permission	Transparency
Set:	NET-MASK	Administrator	Public
Get:	NET-MASK?	End User	Public
Description		Syntax	
Set:	Set subnet mask	# NET-MASK <code>[SP]</code> <i>net_mask</i> <code>[CR]</code>	
Get:	Get subnet mask	# NET-MASK? <code>[CR]</code>	
Response			
~ <code>[nn]</code> @ NET-MASK <code>[SP]</code> <i>net_mask</i> <code>[CR LF]</code>			
Parameters			
<i>net_mask</i> – Subnet mask address. Format: <i>xxx.xxx.xxx.xxx</i>			
Response Triggers			
The subnet mask limits the Ethernet connection within the local network. Consult your network administrator for correct settings.			
Notes			
Example			
Set the subnet mask to 255.255.0.0: #NET-MASK 255.255.000.000 <code><CR></code>			

TIME-SRV

Functions		Permission	Transparency
Set:	TIME-SRV	Administrator	Public
Get:	TIME-SRV?	End User	Public
Description		Syntax	
Set:	Set time server	# TIME-SRV _{SP} <i>mode,time_server,time_server_sync_hour</i> _{CR}	
Get:	Get time server	# TIME-SRV? _{CR}	
Response			
~ _{nn} @ TIME-SRV _{SP} <i>mode,time_server,time_server_sync_hour,server_status</i> _{CR LF}			
Parameters			
<i>mode</i> – 0 (OFF), 1 (ON) <i>time_server</i> – time server IP address or hostname. IP must be, in the following format: xxx.xxx.xxx.xxx <i>time_server_sync_hour</i> – not in use: 0 <i>server_status</i> – ON/OFF			
Response Triggers			
Notes			
This command sets up the NTP server.			
Example			
Set time server with IP address of 128.138.140.44 to ON: #TIME-SRV 1, 128.138.140.44, 0<CR>			

UART

Functions		Permission	Transparency
Set:	UART	Administrator	Public
Get:	UART?	End User	Public
Description		Syntax	
Set:	Set <i>SERIAL</i> port configuration	# UART _{SP} <i>COM_Num,baud_rate,data_bits,parity,stop_bits</i> _{CR}	
Get:	Get <i>SERIAL</i> port configuration	# UART? _{SP} <i>COM_Num</i> _{CR}	
Response			
Set: ~ _{nl} @ UART _{SP} <i>COM_Num,baud_rate,data_bits,parity,stop_bits</i> _{CR LF}			
Get: ~ _{nl} @ UART? _{SP} <i>COM_Num,baud_rate,data_bits,parity,stop_bits</i> _{CR LF}			
Parameters			
<i>COM_Num</i> – The number of the relevant <i>SERIAL</i> port:1–4			
<i>baud_rate</i> – 300–115200 (default: 9600)			
<i>data_bits</i> – 5–8			
<i>parity</i> – 0 (no parity), 1 (Odd), 2 (Even), 3 (Mark), or 4 (Space)			
<i>stop_bits</i> – 1, 1.5, 2			
Response Triggers			
Notes			
<i>stop_bits</i> = 1.5 only when <i>data_bits</i> = 5.			
Example			
Set <i>SERIAL</i> port number 1 configuration to baud rate 9600, data bits 8, parity 'None', stop bits 1: #UART 1,9600,8,0,1<CR>			

I/O Gateway Commands

Command	Description
COM-ROUTE	Get tunneling port routing
COM-ROUTE-ADD	Add communication route tunnel connection
COM-ROUTE-REMOVE	Remove communication route tunnel connection
ETH-TUNNEL	Get opened tunnel parameters
GPIO-CFG	Set/get HW GPIO configuration
GPIO-STATE	Set/get HW GPIO state
GPIO-STEP	Set/get HW GPIO step
GPIO-THR	Set/get HW GPIO threshold voltage
GPIO-VOLT	Get HW GPIO voltage level
IR-LEARN	Send IR learning command
IR-SND	Send IR command to port
IR-STOP	Send IR stop command to port
RELAY-STATE	Set/get relay state

COM-ROUTE

Functions		Permission	Transparency
Set:			
Get:	COM-ROUTE?	End User	Internal
Description		Syntax	
Set:			
Get:	Get tunneling port routing	# COM-ROUTE? <input type="checkbox"/> <i>COM_Num</i> <input type="checkbox"/>	
Response			
~ <input type="checkbox"/> @ COM-ROUTE <input type="checkbox"/> <i>COM_Num,portType,ETHPort,ETH_rep_en,TCP_keep_alive_timing</i> <input type="checkbox"/> <input type="checkbox"/>			
Parameters			
<i>COM_Num</i> – <i>SERIAL</i> port number: 1–4, * (get all route tunnels) <i>portType</i> – 1 (UDP), 2 (TCP) <i>ETHPort</i> – TCP/UDP port number: default = 5001–5004 <i>ETH_rep_en</i> – 1 (COM port sends replies to new clients) 0 (COM port does not send replies to new clients) <i>TCP_keep_alive_timing</i> – every x seconds the device sends an empty string to TCP client (""): 0–3600 seconds			
Response Triggers			
Notes			
This command gets tunneling port routing. Every <i>SERIAL</i> port can send or receive data from the ETH port.			
Example			
Get tunneling port routing through <i>SERIAL</i> port number 1: #COM-ROUTE? 1<CR>			

COM-ROUTE-ADD

Functions		Permission	Transparency
Set:	COM-ROUTE-ADD	Administrator	Internal
Get:	-	-	-
Description		Syntax	
Set:	Add a communication route tunnel connection	# COM-ROUTE-ADD <input type="text"/> <i>ComNum, PortType, EthPort, EthRepEn, Timeout</i> <input type="text"/>	
Get:	-	-	
Response			
~ <input type="text"/> @ COM-ROUTE-ADD <input type="text"/> <i>ComNum, PortType, EthPort, EthRepEn, TCP_keep_alive_timing</i> <input type="text"/> <input type="text"/>			
Parameters			
<i>COM_Num</i> – SERIAL port number: 1–4 <i>portType</i> – 1 (UDP), 2 (TCP) <i>ETHPort</i> – TCP/UDP port number: default = 5001–5004 <i>ETH_rep_en</i> – 1 (COM port sends replies to new clients) 0 (COM port does not send replies to new clients) <i>TCP_keep_alive_timing</i> – every x seconds the device sends an empty string to TCP client ("0"): 0–3600 seconds			
Response Triggers			
Notes			
Example			
Add a communication route tunnel connection through SERIAL port number 1 and TCP port number 5025, COM port sends replies to new clients and the device sends a keep alive signal every 10 minutes (600 seconds): #COM-ROUTE-ADD 1, TCP, 5025, 1, 600<CR>			

COM-ROUTE-REMOVE

Functions		Permission	Transparency
Set:	COM-ROUTE-REMOVE	Administrator	Internal
Get:	-	-	-
Description		Syntax	
Set:	Remove a communication route tunnel connection	# COM-ROUTE-REMOVE <input type="text"/> <i>ComNum</i> <input type="text"/>	
Get:	-	-	
Response			
~ <input type="text"/> @ COM-ROUTE-REMOVE <input type="text"/> <i>Com_Num</i> <input type="text"/> <input type="text"/>			
Parameters			
<i>Com_Num</i> – SERIAL port number: 1–4			
Response Triggers			
Notes			
Example			
Remove communication route tunnel connection from SERIAL port number 3: #COM-ROUTE-REMOVE 3<CR>			

ETH-TUNNEL

Functions		Permission	Transparency
Set:	-	-	-
Get:	ETH-TUNNEL?	Administrator	Internal
Description		Syntax	
Set:			
Get:	Get parameters for open tunnels	# ETH-TUNNEL? <input type="checkbox"/> <i>TunnelId</i> <input type="checkbox"/>	
Response			
~ <input type="checkbox"/> @ ETH-TUNNEL? <input type="checkbox"/> <i>TunnelId</i> , <i>ComNum</i> , <i>PortType</i> , <i>EthPort</i> , <i>EthIp</i> , <i>RemotPort</i> , <i>ETH_rep_en</i> , <i>Wired</i> <input type="checkbox"/> <input type="checkbox"/>			
Parameters			
<i>TunnelId</i> – tunnel ID number : * (get all open tunnels), or type a number corresponding to one of the existing tunnels <i>ComNum</i> – SERIAL port number: 1–4 <i>PortType</i> – 1 (UDP), 2 (TCP) <i>ETHPort</i> – TCP/UDP port number: default = 5001–5004 <i>EthIp</i> – client IP address in the following format: xxx.xxx.xxx.xxx <i>RemotPort</i> – remote port number <i>ETH_rep_en</i> – 1 (COM port sends replies to new clients) 0 (COM port does not send replies to new clients) <i>Wired</i> – 1 (wired connection), 0 (not wired connection)			
Response Triggers			
Notes			
Example			
Get parameters for all open tunnels: #ETH-TUNNEL? * <input type="checkbox"/> Get parameters for tunnel 1: #ETH-TUNNEL? <i>1</i> <input type="checkbox"/>			

GPIO-CFG

Functions		Permission	Transparency
Set:	GPIO-CFG	End User	Public
Get:	GPIO-CFG?	End User	Public
Description		Syntax	
Set:	Set I/O port configuration	# GPIO-CFG _[SP] <i>HwGpioNumber, HwGpioType, HwGpioDir, Pullup</i> _[CR]	
Get:	Get I/O port configuration	# GPIO-CFG? _[SP] <i>HwGpioNumber</i> _[CR]	
Response			
~ _[nn] @ GPIO-CFG _[SP] <i>HwGpioNum, HwGpioType, HwGpioDir</i> _[CR LF]			
Parameters			
<i>HwGpioNum</i> – I/O port number: 1–4			
<i>HwGpioType</i> – I/O port type: 0 (analog), 1 (digital)			
<i>HwGpioDir</i> – I/O port direction: 0 (input), 1 (output)			
<i>Pullup</i> – 0 (disable), 1 (enable)			
Response Triggers			
Notes			
Example			
Set configuration for I/O port number 1 to digital input with the pull-up enabled: #GPIO-CFG 1,1,0,1<CR>			

GPIO-STATE

Functions		Permission	Transparency
Set:	GPIO-STATE	End User	Public
Get:	GPIO-STATE?	End User	Public
Description		Syntax	
Set:	Set I/O port state	# GPIO-STATE _[SP] <i>HwGpioNumber, HwGpioState</i> _[CR]	
Get:	Get I/O port state	# GPIO-STATE _[SP] <i>HwGpioNumber</i> _[CR]	
Response			
~ _[nn] @ GPIO-STATE _[SP] <i>HwGpioNum, HwGpioState</i> _[CR LF]			
Parameters			
<i>HwGpioNum</i> – I/O port number (1–4)			
<i>HwGpioState</i> – I/O port state – See note below			
Response Triggers			
Notes			
GPIO-STATE? can only be sent in digital mode and the answer is 0=Low, 1=High. In analog mode an error message is sent.			
GPIO-STATE can only be sent in digital out mode and the parameter is 0=Low, 1=High. In all other modes an error message is sent.			
The device uses this command to notify the user of whenever there is a change regarding the state.			
Example			
Set state for digital I/O port number 1 to high: #GPIO-STATE 1,1<CR>			

GPIO-STEP

Functions		Permission	Transparency
Set:	GPIO-STEP	End User	Public
Get:	GPIO-STEP?	End User	Public
Description		Syntax	
Set:	Set I/O port maximum step	# GPIO-STEP _[SP] <i>HwGpioNumber, NumOfStep</i> _[CR]	
Get:	Get I/O port current step	# GPIO-STEP? _[SP] <i>HwGpioNumber</i> _[CR]	
Response			
~ _[nn] @ GPIO-STEP _[SP] <i>HwGpioNumber, NumOfStep, CurrentStep</i> _[CR LF]			
Parameters			
<i>HwGpioNum</i> – I/O port number: 1–4			
<i>NumOfStep</i> – the maximum number of steps: for analog = 0–255, for digital= 2 (see notes)			
<i>CurrentStep</i> – the actual step depending on the measured voltage			
Response Triggers			
Notes			
The Set command can only be used for analog.			
In digital in mode the response is 2 and the current state: 0, 1			
In analog mode the response is 0 to [<i>NumOfStep</i> minus 1].			
In digital out mode an error is returned.			
Example			
Set I/O port number 1 number of steps to 5: #GPIO-STEP 1, 5<CR>			

GPIO-THR

Functions		Permission	Transparency
Set:	GPIO-THR	End User	Public
Get:	GPIO-THR?	End User	Public
Description		Syntax	
Set:	Set HW GPIO voltage levels	# GPIO-THR _[SP] <i>HwGpioNumber, LowLevel, HighLevel</i> _[CR]	
Get:	Get HW GPIO voltage levels that were set	# GPIO-THR? _[SP] <i>HwGpioNumber</i> _[CR]	
Response			
~ _[nn] @ GPIO-THR _[SP] <i>HwGpioNumber, LowLevel, HighLevel</i> _[CR LF]			
Parameters			
<i>HwGpioNum</i> – I/O port number: 1–4			
<i>LowLevel</i> – voltage: 500 to 28000 millivolts			
<i>HighLevel</i> – voltage: 2000 to 30000 millivolts or 2000 to 4000 when pullup is enabled.			
Response Triggers			
Notes			
This command is only relevant for digital input. There must be a minimum of 800 millivolts between the low and the high levels.			
Example			
Set I/O port number 1 voltage low level to 500 millivolts and high level to 2000 millivolts: #GPIO-THR 1, 500, 2000<CR>			

GPIO-VOLT

Functions		Permission	Transparency
Set:	-	-	-
Get:	GPIO-VOLT?	End User	Public
Description		Syntax	
Set:			
Get:	Get active voltage levels of HW GPIO	# GPIO-VOLT? _[SP] <i>HwGpioNumber</i> _[CR]	
Response			
~ _[nn] @ GPIO-VOLT _[SP] <i>HwGpioNumber</i> , <i>Voltage</i> _[CR LF]			
Parameters			
<i>HwGpioNum</i> – hardware GPIO number: 1-4			
<i>Voltage</i> – voltage 0 to 30000 millivolts			
Response Triggers			
Notes			
This command is not available in digital out mode			
Example			
Get HW GPIO #1 active voltage level: #GPIO-VOLT? 1<CR>			

IR-LEARN

Functions		Permission	Transparency
Set:	IR-LEARN	End User	Public
Get:	-	-	-
Description		Syntax	
Set:	Send IR learning command	# IR-LEARN _[SP] <i>CommandName</i> , <i>Timeout</i> _[CR]	
Get:	-	-	
Response			
~ _[nn] @ IR-LEARN _[SP] <i>CommandName</i> , <i>IR_Status</i> _[CR LF]			
Parameters			
<i>CommandName</i> – String: IR command name limited to 15 chars (white space or commas not allowed).			
<i>Timeout</i> – Timeout in seconds: 1-60			
<i>IR_Status</i> – 0 (Sent), 1 (Stop), 2 (Done), 3 (Busy), 4 (Wrong Parameter), 5 (Nothing to Stop), 6 (Start), 7 (Timeout), 8 (Error)			
Response Triggers			
Notes			
Example			
Send IR learning command PowerToggle, with a 30 second timeout: #IR-LEARN PowerToggle, 30<CR>			

IR-SND

Functions		Permission	Transparency
Set:	IR-SND	End User	Public
Get:	-	-	-
Description		Syntax	
Set:	Send IR command to port	# IR-SND _{SP} <i>PortNum,Cmd_id,CmdName,Repeat,TotalPackets,PacketNum,<pronto command...></i> _{CR}	
Get:	-	-	
Response			
~ _{nn} @ IR-SND _{SP} <i>PortNum,Cmd_id,CmdName,Status</i> _{CR LF}			
Parameters			
<p><i>PortNum</i> – IR port transmitting the command: 1–4, * (broadcast to all ports)</p> <p><i>Cmd_id</i> – command ID, numeric string of up to 9 digits for flow control and response commands from device</p> <p><i>CmdName</i> – command name, string of up to 15 alpha-numeric characters</p> <p><i>Repeat</i> – number of times the IR repeat command is transmitted 1 (default) – 50 (repeats > 50 are truncated to 50)</p> <p><i>TotalPackets</i> – number of messages the original command was divided into, default = 1</p> <p><i>PacketNum</i> – chunk serial number (only valid when <i>Total_packets</i> > 1), <i>PacketNum</i> must be <= <i>TotalPackets</i>.</p> <p><i>Pronto command</i> – Pronto format command (in HEX format, no leading zeros, no '0x' prefix, values must be separated by commas)</p> <p><i>Status</i> – 0 (no error)</p>			
Response Triggers			
Notes			
Example			
<p>Transmit IR Power button command with ID of 25 and name PowerTog from port 1; command is repeated 1 time, the total packets is 1,packet/chunk serial number is 1:</p> <pre>#IR-SND 1,25,PowerTog,1,1,1,0000,006e,0022,0002,0156,00ae,0016,0016,0016,0041,0016,0016,0016,0041,0016,0016,0016,0016,0016,0016,0016,0016,0016,0016,0016,0016,0041,0016,0016,0016,0041,0016,0016,0016,0016,0016,0016,0016,0016,0016,0016,0016,0016,0016,0016,0041,0016,0016,0016,0041,0016,0041,0016,0041,0016,0041,0016,0041,0016,069c,0156,0057,0016,0e56<CR></pre>			

IR-STOP

Functions		Permission	Transparency
Set:	IR-STOP	End User	Public
Get:	-	-	-
Description		Syntax	
Set:	Send IR stop command to port	# IR-STOP <input type="checkbox"/> <i>PortNum, Cmd_id, CmdName</i> <input type="checkbox"/>	
Get:	-	-	
Response			
~ <input type="checkbox"/> @ IR-STOP <input type="checkbox"/> <i>PortNum, Cmd_id, CmdName, Status</i> <input type="checkbox"/> <input type="checkbox"/>			
Parameters			
<i>PortNum</i> – IR port transmitting the command: 1–4, * (broadcast to all ports)			
<i>Cmd_id</i> – command ID, numeric string of up to 9 digits for flow control and response commands from device			
<i>CmdName</i> – command name, string of up to 15 alpha-numeric characters			
<i>Status</i> – 0 (no error)			
Response Triggers			
Notes			
Example			
Send IR stop command for IR port number 1, for PowerTog command with ID of 25: #IR-STOP 1,25,PowerTog<CR>			

RELAY-STATE

Functions		Permission	Transparency
Set:	RELAY-STATE	End User	Public
Get:	RELAY-STATE?	End User	Public
Description		Syntax	
Set:	Set relay state	# RELAY-STATE <input type="checkbox"/> <i>RelayNumber, RelayState</i> <input type="checkbox"/>	
Get:	Get relay state	# RELAY-STATE? <input type="checkbox"/> <i>RelayNumber</i> <input type="checkbox"/>	
Response			
~ <input type="checkbox"/> @ RELAY-STATE <input type="checkbox"/> <i>RelayNum, RelayState</i> <input type="checkbox"/> <input type="checkbox"/>			
Parameters			
<i>RelayNumber</i> – Relay port number: 1–4			
<i>RelayState</i> – relay state: 0 (open), 1 (closed), see note			
Response Triggers			
Notes			
When relay 1 is connected as NC (Normally Closed) (see Connecting the Relay Ports on page 8), the <i>RelayState</i> parameter is reversed: 0 (closed), 1 (open).			
Example			
Set Relay port number 2 state to closed: #RELAY-STATE 2,1<CR>			

File System Commands

Command	Description
DEL	Delete file
DIR	List files in device
FORMAT	Format file system
FS-FREE	Get file system free space
GET	Get file

DEL

Functions		Permission	Transparency
Set:	DEL	Administrator	Public
Get:	-	-	-
Description		Syntax	
Set:	Delete file	#DEL <code>[SP]</code> <i>file_name</i> <code>[CR]</code>	
Get:			
Response			
~ <code>[nn]</code> @DEL <code>[SP]</code> <i>file_name</i> <code>[CR LF]</code>			
Parameters			
<i>file_name</i> – name of file to delete			
Response Triggers			
Notes			
File names are case-sensitive.			
Example			
Delete Setup file: #DEL Setup<CR>			

DIR

Functions		Permission	Transparency
Set:	DIR	Administrator	Public
Get:	-	-	-
Description		Syntax	
Set:	List files in device	#DIR<CR>	
Get:	-	-	
Response			
Multi-line:			
~<n><n>@DIR<CR><LF>			
file_name<TAB>file_size<SP>bytes,<SP>ID:<SP>file_id<CR><LF>			
<TAB>free_size<SP>bytes.<CR><LF>			
Parameters			
file_name – name of file			
file_size – file size in bytes. A file can take more space on device memory			
file_id – internal ID for file in file system			
free_size – free space in bytes in device file system			
Response Triggers			
Notes			
Example			
List files in device: #DIR<CR>			

FORMAT

Functions		Permission	Transparency
Set:	FORMAT	Administrator	Public
Get:	-	-	-
Description		Syntax	
Set:	Format file system	# FORMAT <input type="checkbox"/> CR	
Get:	-	-	
Response			
~nn@ FORMAT <input type="checkbox"/> SPOK <input type="checkbox"/> CR LF			
Parameters			
Response Triggers			
Notes			
Response could take several seconds until formatting completes.			
Example			
Format file system: # FORMAT <CR>			

FS-FREE?

Functions		Permission	Transparency
Set:	-	-	-
Get:	FS-FREE?	Administrator	Public
Description		Syntax	
Set:	-	-	
Get:	Get file system free space	# FS-FREE? <input type="checkbox"/> CR	
Response			
~nn@ FS_FREE <input type="checkbox"/> SPfree_size <input type="checkbox"/> CR LF			
Parameters			
free_size – free size in device file system in bytes			
Response Triggers			
Notes			
Example			
Get file system free space: # FS-FREE? <CR>			

GET

Functions		Permission	Transparency
Set:	-	-	-
Get:	GET	Administrator	Public
Description		Syntax	
Set:	-	-	
Get:	Get file	# GET <input type="checkbox"/> <i>file_name</i> <input type="checkbox"/>	
Response			
Multi-line:			
~ <input type="checkbox"/> @ GET <input type="checkbox"/> <i>file_name</i> , <i>file_size</i> <input type="checkbox"/> READY <input type="checkbox"/> <i>contents</i>			
~ <input type="checkbox"/> @ GET <input type="checkbox"/> <i>file_name</i> <input type="checkbox"/> OK <input type="checkbox"/>			
Parameters			
<i>file_name</i> – name of file to get contents			
<i>contents</i> – byte stream of file contents			
<i>file_size</i> – size of file (device sends it in response to give user a chance to get ready)			
Response Triggers			
Notes			
Example			
Get file: #GET <i>file_name</i> <CR>			

Authentication Commands

Command	Description
LOGIN	Set/get protocol permission
LOGOUT	Cancel current permission level
PASS	Set/get password for login level
SECUR	Set/get current security state

LOGIN

Functions		Permission	Transparency
Set:	LOGIN	Not Secure	Public
Get:	LOGIN?	Not Secure	Public
Description		Syntax	
Set:	Set protocol permission	#LOGIN SP login_level, password CR	
Get:	Get current protocol permission level	#LOGIN? CR	
Response			
Set: ~nn@LOGIN SP login_level, password SP OK CR LF			
or			
~nn@LOGIN SP ERR SP 004 CR LF (if bad password entered)			
Get: ~nn@LOGIN SP login_level CR LF			
Parameters			
<i>login_level</i> – level of permissions required: User, Admin			
<i>password</i> – predefined password (by PASS command). Default password is an empty string.			
Response Triggers			
Notes			
When the permission system is enabled, LOGIN enables running commands with the User or Administrator permission level.			
When set, login must be performed upon each connection.			
The permission system works only if security is enabled with the SECUR command. It is not mandatory to enable the permission system in order to use the device.			
Example			
Set the protocol permission level to Admin (when the password defined in the PASS command is 33333): #LOGIN Admin,33333<CR>			

LOGOUT

Functions		Permission	Transparency
Set:	LOGOUT	Not Secure	Public
Get:	-	-	-
Description		Syntax	
Set:	Cancel current permission level	# LOGOUT <code>[CR]</code>	
Get:	-	-	
Response			
~ <code>[nn]</code> @ LOGOUT <code>[SP]OK</code> <code>[CR LF]</code>			
Parameters			
Response Triggers			
Notes			
Logs out from User or Administrator permission levels			
Example			
# LOGOUT <CR>			

PASS

Functions		Permission	Transparency
Set:	PASS	Administrator	Public
Get:	PASS?	Administrator	Public
Description		Syntax	
Set:	Set password for login level	# PASS <code>[SP]</code> <i>login_level,password</i> <code>[CR]</code>	
Get:	Get password for login level	# PASS? <code>[SP]</code> <i>login_level</i> <code>[CR]</code>	
Response			
~ <code>[nn]</code> @ PASS <code>[SP]</code> <i>login_level,password</i> <code>[CR LF]</code>			
Parameters			
<i>login_level</i> – level of login to set: User, Admin <i>password</i> – password for the <i>login_level</i> . Up to 15 printable ASCII chars.			
Response Triggers			
Notes			
The default password is an empty string			
Example			
Set the password for the Admin protocol permission level to 33333: # PASS Admin,33333<CR>			

SECUR

Functions		Permission	Transparency
Set:	SECUR	Administrator	Public
Get:	SECUR?	Not Secure	Public
Description		Syntax	
Set:	Start/stop security	# SECUR [SP] <i>security_mode</i> [CR]	
Get:	Get current security state	# SECUR? [CR]	
Response			
~[nn]@ SECUR [SP] <i>security_mode</i> [CR LF]			
Parameters			
<i>security_mode</i> – 1 (On / enable security), 0 (Off / disable security)			
Response Triggers			
Notes			
The permission system works only if security is enabled with the SECUR command.			
Example			
Enable the permission system: # SECUR 0<CR>			

License Information

OpenSSL License

Copyright (c) 1998-2017 The OpenSSL Project. All rights reserved.

Redistribution and use in source and binary forms, with or without modification, are permitted provided that the following conditions are met:

1. Redistributions of source code must retain the above copyright notice, this list of conditions and the following disclaimer.
2. Redistributions in binary form must reproduce the above copyright notice, this list of conditions and the following disclaimer in the documentation and/or other materials provided with the distribution.
3. All advertising materials mentioning features or use of this software must display the following acknowledgment: "This product includes software developed by the OpenSSL Project for use in the OpenSSL Toolkit. (www.openssl.org/)".
4. The names "OpenSSL Toolkit" and "OpenSSL Project" must not be used to endorse or promote products derived from this software without prior written permission. For written permission, please contact openssl-core@openssl.org.
5. Products derived from this software may not be called "OpenSSL" nor may "OpenSSL" appear in their names without prior written permission of the OpenSSL Project.
6. Redistributions of any form whatsoever must retain the following acknowledgment: "This product includes software developed by the OpenSSL Project for use in the OpenSSL Toolkit (<http://www.openssl.org/>)".

THIS SOFTWARE IS PROVIDED BY THE OpenSSL PROJECT ``AS IS'' AND ANY EXPRESSED OR IMPLIED WARRANTIES, INCLUDING, BUT NOT LIMITED TO, THE IMPLIED WARRANTIES OF MERCHANTABILITY AND FITNESS FOR A PARTICULAR PURPOSE ARE DISCLAIMED. IN NO EVENT SHALL THE OpenSSL PROJECT OR ITS CONTRIBUTORS BE LIABLE FOR ANY DIRECT, INDIRECT, INCIDENTAL, SPECIAL, EXEMPLARY, OR CONSEQUENTIAL DAMAGES (INCLUDING, BUT NOT LIMITED TO, PROCUREMENT OF SUBSTITUTE GOODS OR SERVICES; LOSS OF USE, DATA, OR PROFITS; OR BUSINESS INTERRUPTION) HOWEVER CAUSED AND ON ANY THEORY OF LIABILITY, WHETHER IN CONTRACT, STRICT LIABILITY, OR TORT (INCLUDING NEGLIGENCE OR OTHERWISE) ARISING IN ANY WAY OUT OF THE USE OF THIS SOFTWARE, EVEN IF ADVISED OF THE POSSIBILITY OF SUCH DAMAGE.

- This product includes cryptographic software written by Eric Young (ey@cryptsoft.com).
- This product includes software written by Tim Hudson (tjh@cryptsoft.com).

Original SSLeay License

Copyright (C) 1995-1998 Eric Young (ey@cryptsoft.com) all rights reserved.

This package is an SSL implementation written by Eric Young (ey@cryptsoft.com).

The implementation was written so as to conform with Netscapes SSL.

This library is free for commercial and non-commercial use as long as the following conditions are adhered to. The following conditions apply to all code found in this distribution, be it the RC4, RSA, lhash, DES, etc., code; not just the SSL code. The SSL documentation included with this distribution is covered by the same copyright terms except that the holder is Tim Hudson (tjh@cryptsoft.com).

Copyright remains Eric Young's, and as such any Copyright notices in the code are not to be removed.

If this package is used in a product, Eric Young should be given attribution as the author of the parts of the library used.

This can be in the form of a textual message at program startup or in documentation (online or textual) provided with the package.

Redistribution and use in source and binary forms, with or without modification, are permitted provided that the following conditions are met:

1. Redistributions of source code must retain the copyright notice, this list of conditions and the following disclaimer.
2. Redistributions in binary form must reproduce the above copyright notice, this list of conditions and the following disclaimer in the documentation and/or other materials provided with the distribution.
3. All advertising materials mentioning features or use of this software must display the following acknowledgement: "This product includes cryptographic software written by Eric Young (ey@cryptsoft.com)". The word 'cryptographic' can be left out if the routines from the library being used are not cryptographic related.
4. If you include any Windows specific code (or a derivative thereof) from the apps directory (application code) you must include an acknowledgement: "This product includes software written by Tim Hudson (tjh@cryptsoft.com)".

THIS SOFTWARE IS PROVIDED BY ERIC YOUNG ``AS IS'' AND ANY EXPRESS OR IMPLIED WARRANTIES, INCLUDING, BUT NOT LIMITED TO, THE IMPLIED WARRANTIES OF MERCHANTABILITY AND FITNESS FOR A PARTICULAR PURPOSE ARE DISCLAIMED. IN NO EVENT SHALL THE AUTHOR OR CONTRIBUTORS BE LIABLE FOR ANY DIRECT, INDIRECT, INCIDENTAL, SPECIAL, EXEMPLARY, OR CONSEQUENTIAL DAMAGES (INCLUDING, BUT NOT LIMITED TO, PROCUREMENT OF SUBSTITUTE GOODS OR SERVICES; LOSS OF USE, DATA, OR PROFITS; OR BUSINESS INTERRUPTION) HOWEVER CAUSED AND ON ANY THEORY OF LIABILITY, WHETHER IN CONTRACT, STRICT LIABILITY, OR TORT (INCLUDING NEGLIGENCE OR OTHERWISE) ARISING IN ANY WAY OUT OF THE USE OF THIS SOFTWARE, EVEN IF ADVISED OF THE POSSIBILITY OF SUCH DAMAGE.

The license and distribution terms for any publically available version or derivative of this code cannot be changed. i.e. this code cannot simply be copied and put under another distribution license [including the GNU Public License.]

GNU General Public License

Version 2, June 1991

Copyright (C) 1989, 1991 Free Software Foundation, Inc. 51 Franklin Street, Fifth Floor, Boston, MA 02110-1301, USA
Everyone is permitted to copy and distribute verbatim copies of this license document, but changing it is not allowed.

PREAMBLE

The licenses for most software are designed to take away your freedom to share and change it. By contrast, the GNU General Public License is intended to guarantee your freedom to share and change free software--to make sure the software is free for all its users. This General Public License applies to most of the Free Software Foundation's software and to any other program whose authors commit to using it. (Some other Free Software Foundation software is covered by the GNU Lesser General Public License instead.) You can apply it to your programs, too.

When we speak of free software, we are referring to freedom, not price. Our General Public Licenses are designed to make sure that you have the freedom to distribute copies of free software (and charge for this service if you wish), that you receive source code or can get it if you want it, that you can change the software or use pieces of it in new free programs; and that you know you can do these things.

To protect your rights, we need to make restrictions that forbid anyone to deny you these rights or to ask you to surrender the rights. These restrictions translate to certain responsibilities for you if you distribute copies of the software, or if you modify it.

For example, if you distribute copies of such a program, whether gratis or for a fee, you must give the recipients all the rights that you have. You must make sure that they, too, receive or can get the source code. And you must show them these terms so they know their rights.

We protect your rights with two steps: (1) copyright the software, and (2) offer you this license which gives you legal permission to copy, distribute and/or modify the software.

Also, for each author's protection and ours, we want to make certain that everyone understands that there is no warranty for this free software. If the software is modified by someone else and passed on, we want its recipients to know that what they have is not the original, so that any problems introduced by others will not reflect on the original authors' reputations.

Finally, any free program is threatened constantly by software patents. We wish to avoid the danger that redistributors of a free program will individually obtain patent licenses, in effect making the program proprietary. To prevent this, we have made it clear that any patent must be licensed for everyone's free use or not licensed at all.

The precise terms and conditions for copying, distribution and modification follow.

TERMS AND CONDITIONS FOR COPYING, DISTRIBUTION AND MODIFICATION

0. This License applies to any program or other work which contains a notice placed by the copyright holder saying it may be distributed under the terms of this General Public License. The "Program", below, refers to any such program or work, and a "work based on the Program" means either the Program or any derivative work under copyright law: that is to say, a work containing the Program or a portion of it, either verbatim or with modifications and/or translated into another language. (Hereinafter, translation is included without limitation in the term "modification".) Each licensee is addressed as "you".

Activities other than copying, distribution and modification are not covered by this License; they are outside its scope. The act of running the Program is not restricted, and the output from the Program is covered only if its contents constitute a work based on the Program (independent of having been made by running the Program). Whether that is true depends on what the Program does.

1. You may copy and distribute verbatim copies of the Program's source code as you receive it, in any medium, provided that you conspicuously and appropriately publish on each copy an appropriate copyright notice and disclaimer of warranty; keep intact all the notices that refer to this License and to the absence of any warranty; and give any other recipients of the Program a copy of this License along with the Program.

You may charge a fee for the physical act of transferring a copy, and you may at your option offer warranty protection in exchange for a fee.

2. You may modify your copy or copies of the Program or any portion of it, thus forming a work based on the Program, and copy and distribute such modifications or work under the terms of Section 1 above, provided that you also meet all of these conditions:

- a) You must cause the modified files to carry prominent notices stating that you changed the files and the date of any change.
- b) You must cause any work that you distribute or publish, that in whole or in part contains or is derived from the Program or any part thereof, to be licensed as a whole at no charge to all third parties under the terms of this License.
- c) If the modified program normally reads commands interactively when run, you must cause it, when started running for such interactive use in the most ordinary way, to print or display an announcement including an appropriate copyright notice and a notice that there is no warranty (or else, saying that you provide a warranty) and that users may redistribute the program under these conditions, and telling the user how to view a copy of this License. (Exception: if the Program itself is interactive but does not normally print such an announcement, your work based on the Program is not required to print an announcement.)

These requirements apply to the modified work as a whole. If identifiable sections of that work are not derived from the Program, and can be reasonably considered independent and separate works in themselves, then this License, and its terms, do not apply to those sections when you distribute them as separate works. But when you distribute the same sections as part of a whole which is a work based on the Program, the distribution of the whole must be on the terms of this License, whose permissions for other licensees extend to the entire whole, and thus to each and every part regardless of who wrote it.

Thus, it is not the intent of this section to claim rights or contest your rights to work written entirely by you; rather, the intent is to exercise the right to control the distribution of derivative or collective works based on the Program.

In addition, mere aggregation of another work not based on the Program with the Program (or with a work based on the Program) on a volume of a storage or distribution medium does not bring the other work under the scope of this License.

3. You may copy and distribute the Program (or a work based on it, under Section 2) in object code or executable form under the terms of Sections 1 and 2 above provided that you also do one of the following:

- a) Accompany it with the complete corresponding machine-readable source code, which must be distributed under the terms of Sections 1 and 2 above on a medium customarily used for software interchange; or,

- b) Accompany it with a written offer, valid for at least three years, to give any third party, for a charge no more than your cost of physically performing source distribution, a complete machine-readable copy of the corresponding source code, to be distributed under the terms of Sections 1 and 2 above on a medium customarily used for software interchange; or,
- c) Accompany it with the information you received as to the offer to distribute corresponding source code. (This alternative is allowed only for noncommercial distribution and only if you received the program in object code or executable form with such an offer, in accord with Subsection b above.)

The source code for a work means the preferred form of the work for making modifications to it. For an executable work, complete source code means all the source code for all modules it contains, plus any associated interface definition files, plus the scripts used to control compilation and installation of the executable. However, as a special exception, the source code distributed need not include anything that is normally distributed (in either source or binary form) with the major components (compiler, kernel, and so on) of the operating system on which the executable runs, unless that component itself accompanies the executable.

If distribution of executable or object code is made by offering access to copy from a designated place, then offering equivalent access to copy the source code from the same place counts as distribution of the source code, even though third parties are not compelled to copy the source along with the object code.

4. You may not copy, modify, sublicense, or distribute the Program except as expressly provided under this License. Any attempt otherwise to copy, modify, sublicense or distribute the Program is void, and will automatically terminate your rights under this License. However, parties who have received copies, or rights, from you under this License will not have their licenses terminated so long as such parties remain in full compliance.

5. You are not required to accept this License, since you have not signed it. However, nothing else grants you permission to modify or distribute the Program or its derivative works. These actions are prohibited by law if you do not accept this License. Therefore, by modifying or distributing the Program (or any work based on the Program), you indicate your acceptance of this License to do so, and all its terms and conditions for copying, distributing or modifying the Program or works based on it.

6. Each time you redistribute the Program (or any work based on the Program), the recipient automatically receives a license from the original licensor to copy, distribute or modify the Program subject to these terms and conditions. You may not impose any further restrictions on the recipients' exercise of the rights granted herein. You are not responsible for enforcing compliance by third parties to this License.

7. If, as a consequence of a court judgment or allegation of patent infringement or for any other reason (not limited to patent issues), conditions are imposed on you (whether by court order, agreement or otherwise) that contradict the conditions of this License, they do not excuse you from the conditions of this License. If you cannot distribute so as to satisfy simultaneously your obligations under this License and any other pertinent obligations, then as a consequence you may not distribute the Program at all. For example, if a patent license would not permit royalty-free redistribution of the Program by all those who receive copies directly or indirectly through you, then the only way you could satisfy both it and this License would be to refrain entirely from distribution of the Program.

If any portion of this section is held invalid or unenforceable under any particular circumstance, the balance of the section is intended to apply and the section as a whole is intended to apply in other circumstances.

It is not the purpose of this section to induce you to infringe any patents or other property right claims or to contest validity of any such claims; this section has the sole purpose of protecting the integrity of the free software distribution system, which is implemented by public license practices. Many people have made generous contributions to the wide range of software distributed through that system in reliance on consistent application of that system; it is up to the author/donor to decide if he or she is willing to distribute software through any other system and a licensee cannot impose that choice.

This section is intended to make thoroughly clear what is believed to be a consequence of the rest of this License.

8. If the distribution and/or use of the Program are restricted in certain countries either by patents or by copyrighted interfaces, the original copyright holder who places the Program under this License may add an explicit geographical distribution limitation excluding those countries, so that distribution is permitted only in or among countries not thus excluded. In such case, this License incorporates the limitation as if written in the body of this License.

9. The Free Software Foundation may publish revised and/or new versions of the General Public License from time to time. Such new versions will be similar in spirit to the present version, but may differ in detail to address new problems or concerns.

Each version is given a distinguishing version number. If the Program specifies a version number of this License which applies to it and "any later version", you have the option of following the terms and conditions either of that version or of any later version published by the Free Software Foundation. If the Program does not specify a version number of this License, you may choose any version ever published by the Free Software Foundation.

10. If you wish to incorporate parts of the Program into other free programs whose distribution conditions are different, write to the author to ask for permission. For software which is copyrighted by the Free Software Foundation, write to the Free Software Foundation; we sometimes make exceptions for this. Our decision will be guided by the two goals of preserving the free status of all derivatives of our free software and of promoting the sharing and reuse of software generally.

NO WARRANTY

11. BECAUSE THE PROGRAM IS LICENSED FREE OF CHARGE, THERE IS NO WARRANTY FOR THE PROGRAM, TO THE EXTENT PERMITTED BY APPLICABLE LAW. EXCEPT WHEN OTHERWISE STATED IN WRITING THE COPYRIGHT HOLDERS AND/OR OTHER PARTIES PROVIDE THE PROGRAM "AS IS" WITHOUT WARRANTY OF ANY KIND, EITHER EXPRESSED OR IMPLIED, INCLUDING, BUT NOT LIMITED TO, THE IMPLIED WARRANTIES OF MERCHANTABILITY AND FITNESS FOR A PARTICULAR PURPOSE. THE ENTIRE RISK AS TO THE QUALITY AND PERFORMANCE OF THE PROGRAM IS WITH YOU. SHOULD THE PROGRAM PROVE DEFECTIVE, YOU ASSUME THE COST OF ALL NECESSARY SERVICING, REPAIR OR CORRECTION.

12. IN NO EVENT UNLESS REQUIRED BY APPLICABLE LAW OR AGREED TO IN WRITING WILL ANY COPYRIGHT HOLDER, OR ANY OTHER PARTY WHO MAY MODIFY AND/OR REDISTRIBUTE THE PROGRAM AS PERMITTED ABOVE, BE LIABLE TO YOU FOR DAMAGES, INCLUDING ANY GENERAL, SPECIAL, INCIDENTAL OR CONSEQUENTIAL DAMAGES ARISING OUT OF THE USE OR INABILITY TO USE THE PROGRAM (INCLUDING BUT NOT LIMITED TO LOSS OF DATA OR DATA BEING RENDERED INACCURATE OR LOSSES SUSTAINED BY YOU OR THIRD PARTIES OR A FAILURE OF THE PROGRAM TO OPERATE WITH ANY OTHER PROGRAMS), EVEN IF SUCH HOLDER OR OTHER PARTY HAS BEEN ADVISED OF THE POSSIBILITY OF SUCH DAMAGES.

The warranty obligations of Kramer Electronics Inc. ("Kramer Electronics") for this product are limited to the terms set forth below:

What is Covered

This limited warranty covers defects in materials and workmanship in this product.

What is Not Covered

This limited warranty does not cover any damage, deterioration or malfunction resulting from any alteration, modification, improper or unreasonable use or maintenance, misuse, abuse, accident, neglect, exposure to excess moisture, fire, improper packing and shipping (such claims must be presented to the carrier), lightning, power surges, or other acts of nature. This limited warranty does not cover any damage, deterioration or malfunction resulting from the installation or removal of this product from any installation, any unauthorized tampering with this product, any repairs attempted by anyone unauthorized by Kramer Electronics to make such repairs, or any other cause which does not relate directly to a defect in materials and/or workmanship of this product. This limited warranty does not cover cartons, equipment enclosures, cables or accessories used in conjunction with this product.

Without limiting any other exclusion herein, Kramer Electronics does not warrant that the product covered hereby, including, without limitation, the technology and/or integrated circuit(s) included in the product, will not become obsolete or that such items are or will remain compatible with any other product or technology with which the product may be used.

How Long this Coverage Lasts

The standard limited warranty for Kramer products is seven (7) years from the date of original purchase, with the following exceptions:

1. All Kramer VIA hardware products are covered by a standard three (3) year warranty for the VIA hardware and a standard three (3) year warranty for firmware and software updates.
2. All Kramer fiber optic cables and adapters, active cables, cable retractors, all Kramer speakers and Kramer touch panels are covered by a standard one (1) year warranty.
3. All Kramer Cobra products, all Kramer Calibre products, all Kramer Minicom digital signage products, all HighSecLabs products, all streaming, and all wireless products are covered by a standard three (3) year warranty.
4. All Sierra Video MultiViewers are covered by a standard five (5) year warranty.
5. Sierra switchers & control panels are covered by a standard seven (7) year warranty (excluding power supplies and fans that are covered for three (3) years).
6. K-Touch software is covered by a standard one (1) year warranty for software updates.
7. All Kramer passive cables are covered by a ten (10) year warranty.

Who is Covered

Only the original purchaser of this product is covered under this limited warranty. This limited warranty is not transferable to subsequent purchasers or owners of this product.

What Kramer Electronics Will Do

Kramer Electronics will, at its sole option, provide one of the following three remedies to whatever extent it shall deem necessary to satisfy a proper claim under this limited warranty:

1. Elect to repair or facilitate the repair of any defective parts within a reasonable period of time, free of any charge for the necessary parts and labor to complete the repair and restore this product to its proper operating condition. Kramer Electronics will also pay the shipping costs necessary to return this product once the repair is complete.
2. Replace this product with a direct replacement or with a similar product deemed by Kramer Electronics to perform substantially the same function as the original product.
3. Issue a refund of the original purchase price less depreciation to be determined based on the age of the product at the time remedy is sought under this limited warranty.

What Kramer Electronics Will Not Do Under This Limited Warranty

If this product is returned to Kramer Electronics or the authorized dealer from which it was purchased or any other party authorized to repair Kramer Electronics products, this product must be insured during shipment, with the insurance and shipping charges prepaid by you. If this product is returned uninsured, you assume all risks of loss or damage during shipment. Kramer Electronics will not be responsible for any costs related to the removal or re-installation of this product from or into any installation. Kramer Electronics will not be responsible for any costs related to any setting up this product, any adjustment of user controls or any programming required for a specific installation of this product.

How to Obtain a Remedy Under This Limited Warranty

To obtain a remedy under this limited warranty, you must contact either the authorized Kramer Electronics reseller from whom you purchased this product or the Kramer Electronics office nearest you. For a list of authorized Kramer Electronics resellers and/or Kramer Electronics authorized service providers, visit our web site at www.kramerav.com or contact the Kramer Electronics office nearest you.

In order to pursue any remedy under this limited warranty, you must possess an original, dated receipt as proof of purchase from an authorized Kramer Electronics reseller. If this product is returned under this limited warranty, a return authorization number, obtained from Kramer Electronics, will be required (RMA number). You may also be directed to an authorized reseller or a person authorized by Kramer Electronics to repair the product.

If it is decided that this product should be returned directly to Kramer Electronics, this product should be properly packed, preferably in the original carton, for shipping. Cartons not bearing a return authorization number will be refused.

Limitation of Liability

THE MAXIMUM LIABILITY OF KRAMER ELECTRONICS UNDER THIS LIMITED WARRANTY SHALL NOT EXCEED THE ACTUAL PURCHASE PRICE PAID FOR THE PRODUCT. TO THE MAXIMUM EXTENT PERMITTED BY LAW, KRAMER ELECTRONICS IS NOT RESPONSIBLE FOR DIRECT, SPECIAL, INCIDENTAL OR CONSEQUENTIAL DAMAGES RESULTING FROM ANY BREACH OF WARRANTY OR CONDITION, OR UNDER ANY OTHER LEGAL THEORY. Some countries, districts or states do not allow the exclusion or limitation of relief, special, incidental, consequential or indirect damages, or the limitation of liability to specified amounts, so the above limitations or exclusions may not apply to you.

Exclusive Remedy

TO THE MAXIMUM EXTENT PERMITTED BY LAW, THIS LIMITED WARRANTY AND THE REMEDIES SET FORTH ABOVE ARE EXCLUSIVE AND IN LIEU OF ALL OTHER WARRANTIES, REMEDIES AND CONDITIONS, WHETHER ORAL OR WRITTEN, EXPRESS OR IMPLIED. TO THE MAXIMUM EXTENT PERMITTED BY LAW, KRAMER ELECTRONICS SPECIFICALLY DISCLAIMS ANY AND ALL IMPLIED WARRANTIES, INCLUDING, WITHOUT LIMITATION, WARRANTIES OF MERCHANTABILITY AND FITNESS FOR A PARTICULAR PURPOSE. IF KRAMER ELECTRONICS CANNOT LAWFULLY DISCLAIM OR EXCLUDE IMPLIED WARRANTIES UNDER APPLICABLE LAW, THEN ALL IMPLIED WARRANTIES COVERING THIS PRODUCT, INCLUDING WARRANTIES OF MERCHANTABILITY AND FITNESS FOR A PARTICULAR PURPOSE, SHALL APPLY TO THIS PRODUCT AS PROVIDED UNDER APPLICABLE LAW.

IF ANY PRODUCT TO WHICH THIS LIMITED WARRANTY APPLIES IS A "CONSUMER PRODUCT" UNDER THE MAGNUSON-MOSS WARRANTY ACT (15 U.S.C.A. §2301, ET SEQ.) OR OTHER APPLICABLE LAW, THE FOREGOING DISCLAIMER OF IMPLIED WARRANTIES SHALL NOT APPLY TO YOU, AND ALL IMPLIED WARRANTIES ON THIS PRODUCT, INCLUDING WARRANTIES OF MERCHANTABILITY AND FITNESS FOR THE PARTICULAR PURPOSE, SHALL APPLY AS PROVIDED UNDER APPLICABLE LAW.

Other Conditions

This limited warranty gives you specific legal rights, and you may have other rights which vary from country to country or state to state.

This limited warranty is void if (i) the label bearing the serial number of this product has been removed or defaced, (ii) the product is not distributed by Kramer Electronics or (iii) this product is not purchased from an authorized Kramer Electronics reseller. If you are unsure whether a reseller is an authorized Kramer Electronics reseller, visit our web site at www.kramerav.com or contact a Kramer Electronics office from the list at the end of this document.

Your rights under this limited warranty are not diminished if you do not complete and return the product registration form or complete and submit the online product registration form. Kramer Electronics thanks you for purchasing a Kramer Electronics product. We hope it will give you years of satisfaction.

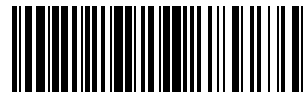

P/N: 2900-300955



Rev: 1



SAFETY WARNING

Disconnect the unit from the power supply before opening and servicing

For the latest information on our products and a list of Kramer distributors, visit our Web site where updates to this user manual may be found.

We welcome your questions, comments, and feedback.