

## IOLAN SDS4 GR/SDS4T GR/STS4D GR Hardware Installation Guide



THE SPECIFICATIONS AND INFORMATION REGARDING THE PRODUCTS IN THIS GUIDE ARE SUBJECT TO CHANGE WITHOUT NOTICE. ALL STATEMENTS, INFORMATION, AND RECOMMENDATIONS IN THIS GUIDE ARE BELIEVED TO BE ACCURATE BUT ARE PRESENTED WITHOUT WARRANTY OF ANY KIND, EXPRESS OR IMPLIED. USERS MUST TAKE FULL RESPONSIBILITY FOR THEIR APPLICATION OF ANY PRODUCTS.

This equipment has been tested and found to comply with the limits for a Class A digital device, pursuant to part 15 of the FCC rules. These limits are designed to provide reasonable protection against harmful interference when the equipment is operated in a commercial environment. This equipment generates, uses, and can radiate radio-frequency energy and, if not installed and used in accordance with this hardware guide may cause harmful interference to radio communications. Operation of this equipment in a residential area is likely to cause harmful interference, in which case users will be required to correct the interference at their own expense.

Modifications to this product not authorized by Perle could void the FCC approval and negate your authority to operate the product.

Perle reserves the right to make changes without further notice, to any products to improve reliability, function, or design.

Perle, the Perle logo, and IOLAN SDS4 GR/SDS4T GR/STS4D GR are trademarks of Perle Systems Limited.

©2017. Perle Systems Limited.

# Table of Contents

Preface .....	2
Overview .....	3
IOLAN SDS4 GR/SDS4T GR/STS4D GR .....	3
IOLAN SDS4 GR/STS4D GR (Back View with socket for Barrel connector) .....	4
IOLAN SDS4T GR (Back View with Terminal Block Connector) .....	4
Ethernet and Serial Port .....	4
Button/Switch Functions .....	4
LED Indicators .....	4
Power/Ready .....	5
Installation .....	6
Connecting the Power .....	6
Connecting the Console Port .....	8
Rebooting/Resetting the IOLAN .....	9
Connecting Data Ports .....	9
Configuring the IOLAN .....	10
Appendix A - Technical Specifications .....	11
Appendix B - Mechanical Drawing .....	13
Appendix C - Labels (Sample) .....	14
Appendix D - Cabling and Connectors .....	15
Appendix E - IOLAN Maintenance .....	17

# Preface

## Audience

This guide is for the network or computer technician responsible for installing the Perle IOLAN SDS4 GR/SDS4T GR/STS4D GR. Familiarity with the concepts and terminology of Ethernet and local area networks is required.

## Purpose

This document describes the hardware and physical characteristics of the Perle IOLAN SDS4 GR/SDS4T GR/STS4T GR. It covers hardware features as well as installation and operation of the IOLAN. This document does not cover how to configure your Perle IOLAN SDS4 GR/SDS4T GR/STS4D GR.

Information to configure your Perle IOLAN SDS can be found in the IOLAN User's Guide.

## Document Conventions

This document contains the following conventions:

Most text is presented in the typeface used in this paragraph. Other typefaces are used to help you identify certain types of information. The other typefaces are:

**Note:** *Means reader take note:* notes contain helpful suggestions.

**Caution:** Means reader be careful. In this situation, you might perform an action that could result in equipment damage or loss of data.

### **Warning: IMPORTANT SAFETY INSTRUCTIONS**

Means danger. You are in a situation that could cause bodily injury. Before you work on any equipment, be aware of the hazards involved with electrical circuitry and be familiar with standard practices for preventing accidents. Only qualified personnel should connect power to this unit.



Warning – more information is contained within this guide



Warning – equipment rated above 40°C. Equipment may be very hot.

## Overview

The IOLAN 4 port comes in these models.

- SDS4 GR - 4 port model with four RJ45 serial ports
- SDS4T GR - 4 port model (Extended Temperature) with four RJ45 serial ports
- STS4D GR - 4 port model with four RJ45 serial ports (RS232 only)

This chapter discusses the following topics:

[IOLAN SDS4 GR/SDS4T GR/STS4D GR](#)

[IOLAN SDS4 GR/STS4D GR \(Back View with socket for Barrel connector\)](#)

[IOLAN SDS4T GR \(Back View with Terminal Block Connector\)](#)

[Ethernet and Serial Port](#)

[Button/Switch Functions](#)

[Connecting the Power](#)

[Connecting the Console Port](#)

[Rebooting/Resetting the IOLAN](#)

[Configuring the IOLAN](#)

## IOLAN SDS4 GR/SDS4T GR/STS4D GR

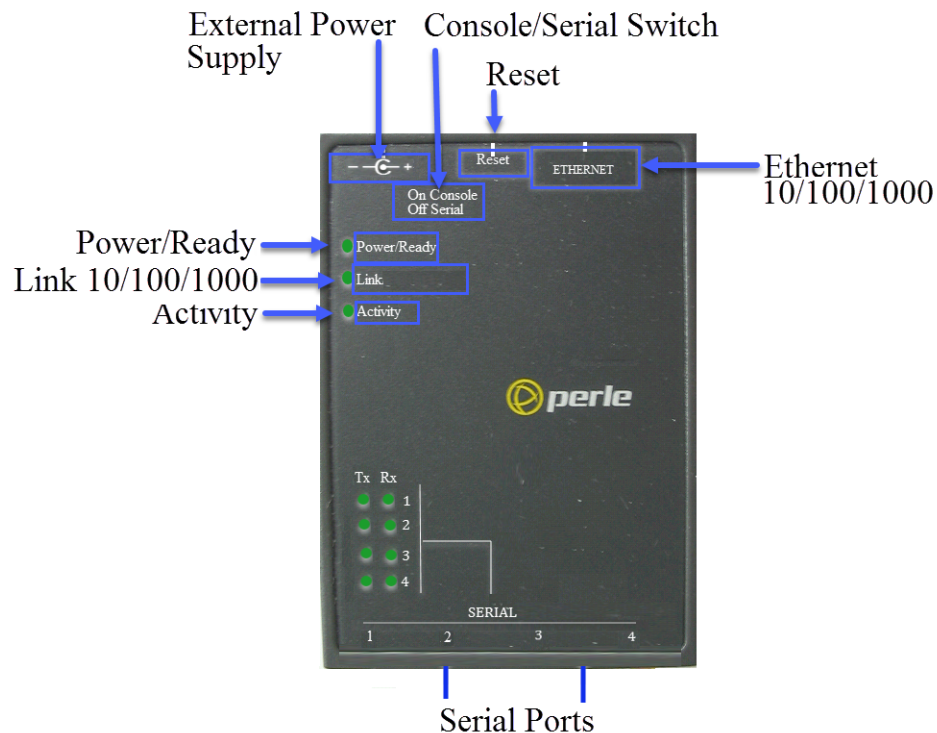

The IOLAN STS4D GR only supports RS-232 on RJ45-10 pin.

## IOLAN SDS4 GR/STS4D GR (Back View with socket for Barrel connector)

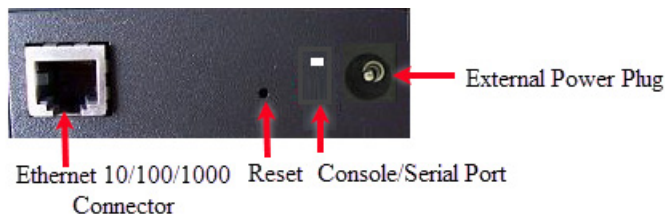

## IOLAN SDS4T GR (Back View with Terminal Block Connector)

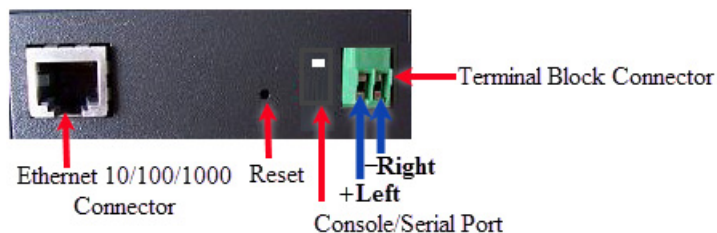

**Note:** Terminal Block is fixed to the IOLAN

## Ethernet and Serial Port

### 10/100/1000Base-T Port

The Ethernet port provides the standard gigabit Ethernet interface speeds of 10/100/1000 Mbps through twisted pair (UTP) cables of up to 100 meters (328ft) in length.

### Serial Port / Console Port (RJ45)

The dip switch on the IOLAN is set in the factory to serial (up position). Unless you plan to attach a console to the IOLAN, leave the dip switch in the serial position (see [Connecting Serial Devices](#)). In console mode, this port can also be used as a console management port providing access to the IOLAN management function using the industry standard CLI command set (see [Appendix D - Cabling and Connectors](#)).

## Button/Switch Functions

### Reset Button

The inset RESET button will reboot the IOLAN if pushed in and released quickly. It will reset the IOLAN to factory defaults if pushed in and held for more than three seconds.

### Console / Serial Switch (RJ45)

The IOLAN can be fully configured and managed from the console port. The IOLAN is set in the factory to serial (up position). Unless you plan to attach a console to the IOLAN, leave the dip switch in the serial position. If this DIP switch is set to the down position, then the serial port is in console mode. In console mode, the port provides access to the IOLAN management function using the industry standard CLI command set. See the IOLAN Command Line Interface Reference Guide.

## LED Indicators

### Power/Ready

State	Description
<b>Green - solid</b>	System Ready
<b>Green - flashing</b>	System is booting or DIP switch is in console mode
<b>Red</b>	Error condition

### Link 10/100/1000

State	Description
<b>Green</b>	1000 Mbps
<b>Amber</b>	100 /10 Mbps
<b>Off</b>	No LAN connection

### Activity

State	Description
<b>Green</b>	Flashes with activity
<b>Amber</b>	Flashes with activity
<b>Off</b>	No LAN connection

# Installation

This chapter discusses the following topics:

*General Cautions and Warnings*

*Connecting the Power*

*Connecting the barrel connector*

*Connecting the terminal block connector*

*Grounding and Power Cord Relief clip*

*Connecting the Console Port*

*Rebooting/Resetting the IOLAN*

*Connecting Data Ports*

*Configuring the IOLAN*

*CLI*

*Web Device Manager*

*DeviceManager*

## General Cautions and Warnings

**Warning:** Power sources must be off prior to beginning the power connection steps.

Read the installation instructions before you connect the unit to its power source.

**Warning:** Ensure that the voltage and current ratings of the intended power source are appropriate for the IOLAN as indicated on the product label.

**Warning:** Ensure that the installation and electrical wiring of the equipment is performed by trained and qualified personnel and that the installation complies with all local and national electrical codes.

**Warning:** The working voltage inputs are designed for operation with Safety extra low Voltage (SELV). Connect only to SELV circuits with voltage restrictions in line with IEC/EN 60950-1:2005 (2nd Edition) + A1:2009 and EN 60950-1: 2006 + A11:2009

**Warning:** If this equipment is used in a manner not specified by the manufacturer, the protection provided by the equipment may be impaired.

## Connecting the Power

The SDS4 GR and the STS4D GR models connect to power using the power adapter that came with your IOLAN. If using a SDS4T GR with the Terminal Block connector use the instructions below to connect to power. The Terminal Block cannot be removed from the IOLAN.

### Connecting the barrel connector

Plug the power adapter into a power socket and connect the barrel connector end into the IOLAN. The IOLAN will perform a power up sequence. The Power/Ready LED should show a solid green. See [LED Indicators Power/Ready](#) for power up sequence.



## Connecting the terminal block connector

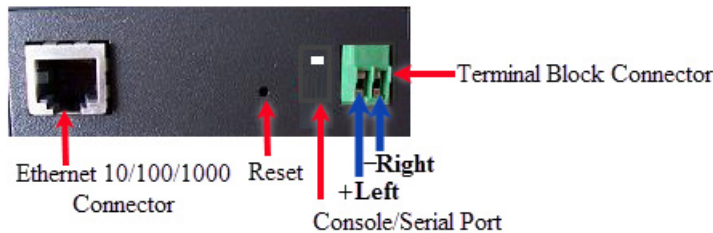

1. Ensure power is NOT applied to the wires prior to connection.
2. On each end wire (12-20 AWG), remove the insulation from the copper wire 5 mm (3/16 of an inch).
3. Loosen the left screw on the top of the terminal connector block, then insert your positive (+) wire into the left terminal and screw it down tight (.51Nm torque). Loosen the right screw on the top of the terminal connector block, then insert your negative (-) wire into the right terminal and screw it down tight (.51Nm torque).
4. Connect the Ethernet cable from the RJ-45 plug (10/100/1000) to the HUB or switch that will provide network connectivity (if applicable to your application).
5. The console dip switch on the IOLAN should be set to the down position for serial mode.
6. Connect the power cord strain relief, if desired. (Figure 2)
7. Connect the grounding lug (not provided) to the grounding screw, if desired. (Figure 1)
8. Turn on power at source. See [LED Indicators Power/Ready](#) for power up sequence.

## Grounding and Power Cord Relief clip

If your installation requires additional grounding, follow this procedure.

Grounding the chassis requires the following items:

- One grounding lug (not provided)
- One 12AWG wire (not provided)

Follow the manufacturers instructions for attaching the ground wire to the grounding lug.

1. Attach the grounding lug to the chassis and secure with the grounding screw provided. See Figure 1.
2. Attach the power cord relief clip as shown in Figure 2.

Grounding Screw



Figure 1

Power Cord Strain Relief Clip



Figure 2

## Connecting the Console Port

The IOLAN can be fully configured and managed from the console port. The IOLAN is set in the factory to serial (up position). Unless you plan to attach a console to the IOLAN, leave the dip switch in the serial position. If this DIP switch is set to the down position, then the serial port is in console mode. In console mode, the port provides access to the IOLAN management function using the industry standard CLI command set. See the IOLAN Command Line Interface Reference Guide.

### Console Port Mode (RJ45)

To connect to the console port, follow instructions below.

See [Appendix D - Cabling and Connectors](#) for information on cabling requirements.

1. Power off the IOLAN and set the console switch to the down position.
2. Connect the power and allow the IOLAN to complete the boot up sequence.
3. Connect an RJ45 cable directly from the IOLAN to the COM port on your PC using the RJ45-DB9 adapter that was shipped with your IOLAN.
4. Choose Start > Control Panel > Systems or equivalent on the Windows Operating System you are using.
5. Click the Hardware tab and choose Device Manager, Expand the Ports (COM & LPT) section. This will expand the drop down to show the number of com ports on your system. Connect the cable to one of these ports (probably COM1 or COM2).
6. Start a terminal-emulation program (such as Putty or SecureCRT) on the COM port where you have connected the cable PC.
7. Configure this COM port within the terminal emulation program with the following parameters:
  - 9600 baud
  - 8 data bits
  - 1 stop bit
  - No parity
  - None (flow control)
8. Connect power to the unit as described in Connecting Power to the IOLAN.
9. The PC will display the boot-loader sequence

### Serial Port Mode

Serial mode is used when the IOLAN acts as a communication sever, or anytime you are not connecting directly to the IOLAN to configure it. You can connect directly to the IOLAN in serial mode, but the IOLAN will not display all the messages/information you will get in Console mode. See the IOLAN User's Guide for more information on the serial port.

## Rebooting/Resetting the IOLAN

To reset the IOLAN insert a paper clip into the reset hole, then gently press inwards. If the button is released quickly the IOLAN will reboot, if the button is pressed for more than three seconds the IOLAN will be returned to factory defaults.

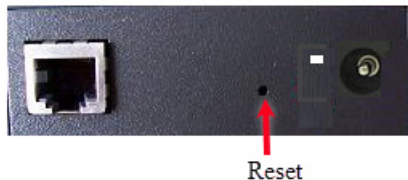

## Connecting Data Ports

### Ethernet Connection

By default the 10/100/1000 Ethernet port will automatically set itself up to match the speed of the port it is connected to. If auto negotiation is not supported by that port then, the port can be configured to operate at a fixed speed and duplex settings.

To connect to 10Base-T, 100Base-TX or 1000Base-T follow these steps:

1. Connect a straight through Ethernet cable from the IOLAN's Ethernet port to an 10/100/1000 RJ45 port on the network hub/switch.
2. Once the IOLAN is connected and the link is established, the link LEDs will turn on. These LEDs will indicate whether you have a 10, 100 or 1000 Mbps link to your hub/switch. See. ([LED Indicators Power/Ready](#)) for more details.

### Ethernet Connector - 8-pin RJ-45

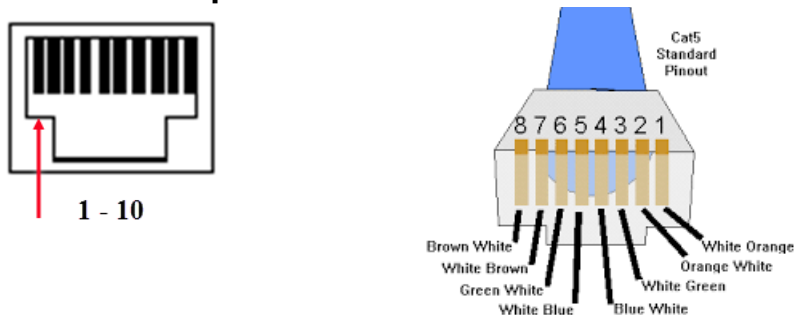

### MDI Port Pinouts

Pin	Signal
1	Tx+
2	Tx-
3	Rx+
6	Rx-

### MDI-X Port Pinouts

Pin	Signal
1	Rx+
2	Rx-
3	Tx+
6	Tx-

## Configuring the IOLAN

The IOLAN can be configured, operated and monitored using any of the following methods. See IOLAN User's Guide for more details.

### CLI

A text-based Command Line Interface based on industry standard syntax and structure. The CLI can be accessed from the console port without a valid IP address for the initial setup. Once an IP address has been assigned the IOLAN can also be accessed by Telnet, SSH, SNMP or the Web interface.

### Web Device Manager

The Perle Web Device Manager is an embedded Web based application that provides an easy to use browser interface for configuring and managing the IOLAN. The IOLAN can be accessed through any standard desktop web browser. The IOLAN must have a valid IP address.

### DeviceManager

This is a Windows based utility that provides the ability to do either an initial setup (out of the box) or to configure and manage the IOLAN. In order to use this utility the IOLAN must be connected to your network. You can download the DeviceManager software from our website at [www.perle.com](http://www.perle.com).

# Appendix A - Technical Specifications

## IOLAN SDS4 GR/SDS4T GR/STS4D GR Port Technical Specifications

Power Input	12/24VDC (9-30VDC)
Power Supply Options	Power via external power 9-30v DC (SDS4 GR/ STS4 GR), 4.8 Watts, terminal block connector (STS4T GR)
Power Consumption@24V DC (Watts)	4.8 Watts
Power IOLAN over Serial	9-30v DC with RJ45 model SDS4 GR/SDS4T GR models
Operating Temperature	-0°C to 55°C -32°F to 131°F
Operating Temperature - Extended Temperature (T model)	-40°C to 74°C -40°F to 165°F
Storage Temperature	-40°C to 66°C -40°F to 150°F
Operating and Storage Humidity	5 to 95% (non condensing)
<b>Regulatory Approvals</b>	
<b>Emissions</b>	
	CFR47 FCC Part 15 Subpart B:2016 ICES-003:2016 EN550032:2015 (CISPR32:2015)
<b>Immunity</b>	
	EN61000-4-2:2009 EN61000-4-3:2006/A2:2010: RF Electromagnetic Field Modulated EN61000-4-4:2004 Fast Transients EN61000-4-5:2006 Surge EN61000-4-6:2009 RF Continuous Conducted EN61000-4-8:2010 Power-Frequency Magnetic Field EN61000-4-11:2004 Voltage Dips and Voltage Interruptions EN61000-3-2:2014, Limits for Harmonic Current Emissions EN61000-3-3:2013, Limits of Voltage Fluctuations and Flicker EN55024:2010/CISPR24:2010
<b>Safety</b>	
	IEC 62368-1:2014 (second edition) EN 62368-1:2014 CSA/UL 62368-1:2014

**Contacting Technical Support**

Contact information for the Perle Technical Assistance Center (PTAC) can be found at the link below.

[https://www.perle.com/support\\_services/support\\_request.shtm](https://www.perle.com/support_services/support_request.shtm)

**Warranty / Registration**

This product is covered by the Perle IOLAN SDS Warranty. Details can be found at:

[https://www.perle.com/support\\_services/warranty.shtml](https://www.perle.com/support_services/warranty.shtml)



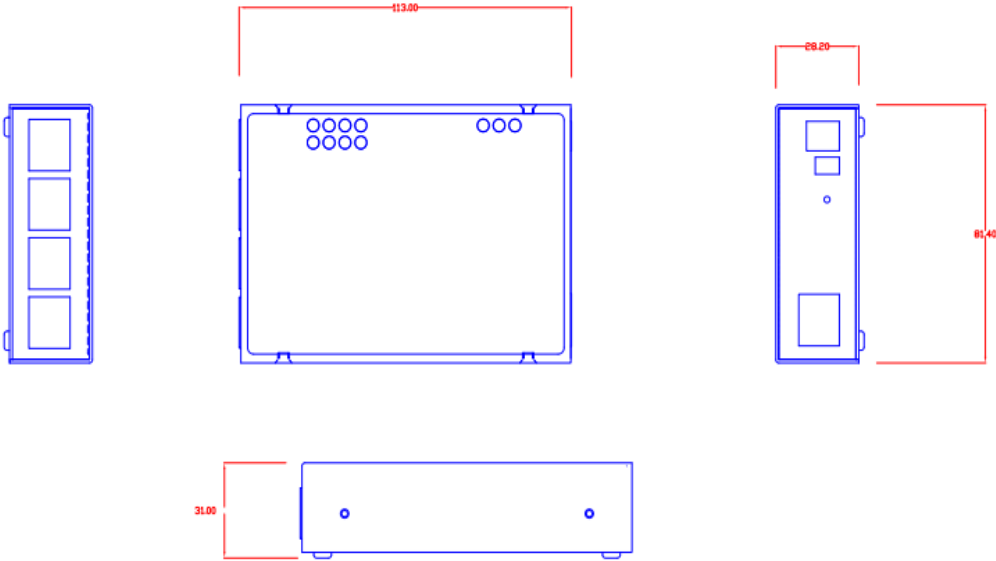



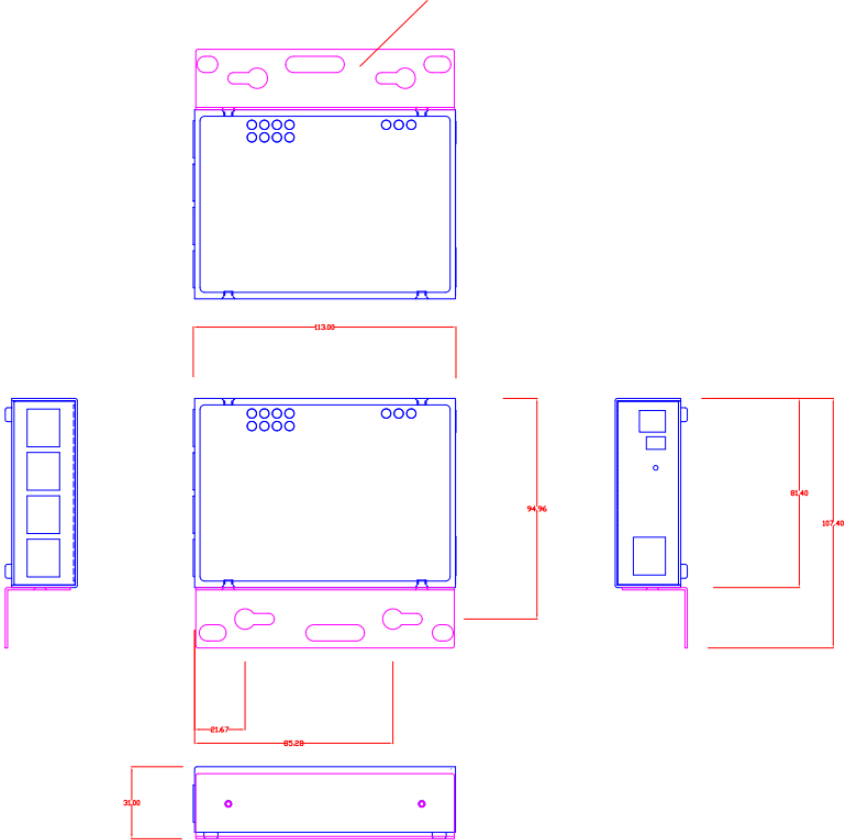

# Appendix B - Mechanical Drawing











The Wall/Rack Bracket can attach to either side of the IOLAN



# Appendix C - Labels (Sample)

 Model: IOLAN SDS4 GR  
P/N: 04031850  
S/N: 80-370917T00062  
  
Input: 9-30VDC 1.0A max, Class2  
  
**LISTED E160409**  
Ethernet to Serial Device  
MAC : 0080D49107AE      Made in Canada

 Model: IOLAN SDS4T GR  
P/N: 04031870  
S/N: 80-400917T00065  
  
Input: 9-30VDC 1.0A max, Class2  
  
**LISTED E160409**  
Ethernet to Serial Device  
MAC : 0080D49107CC      Made in Canada



# Appendix D - Cabling and Connectors

This appendix provides pinouts for the serial RJ45 ports and the Ethernet cable.

## Connecting Serial Devices

Ensure you have the appropriate cable for connecting your serial devices to the serial ports on the IOLAN.

### IOLAN RJ45 Connector

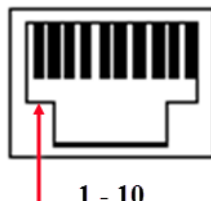

Pinout	EIA-232	EIA-422	EIA-485 Full Duplex	EIA-485 Half Duplex
1	Power In	Power In	Power In	Power In
2 (in)	DCD			
3 (out)	RTS	TxD+	TxD+	TxD+/RxD+
4 (in)	DSR			
5 (out)	TxD	TxD-	TxD-	TxD-/RxD-
6 (in)	RxD	RxD+	RxD+	
7	GND	GND	GND	GND
8 (in)	CTS	RxD-	RxD-	
9 (out)	DTR			
10	Power Out	Power Out	Power Out	Power Out

The Power In pin, pin 1 can be 9-30V DC. STS4D-GR is a RS-232 RJ45 model only.

### Hardware Options (IOLAN SDS4 GR /SDS4T GR)

The IOLAN contains jumpers that you might need to set before you configure it and put it into production. You can set the Power Out pin, pin 10 to a fixed 5V DC output or to the external adapter output; this can range from 9-30V DC (if an external adapter is shipped with the IOLAN, it has a 12V DC output). The Power Out pin is only supported on the SDS4/SDS4T model

The serial port on the IOLAN SDS4 GR/SDS4T GR can also operate in either EIA 232, 422 or 485 mode. This is a software configuration (See the IOLAN User's Guide for information on setting this parameter in your IOLAN firmware). If EIA 422 or 485 is selected, the line termination may need to be set.

Line Termination is not necessary unless the IOLAN's are the end points.

To change the hardware settings, do the following:

1. Unplug the IOLAN from the electrical outlet and disconnect everything from the unit.
2. Open the case by unscrewing the four side screws, two on each side, and lifting off the top of the case.

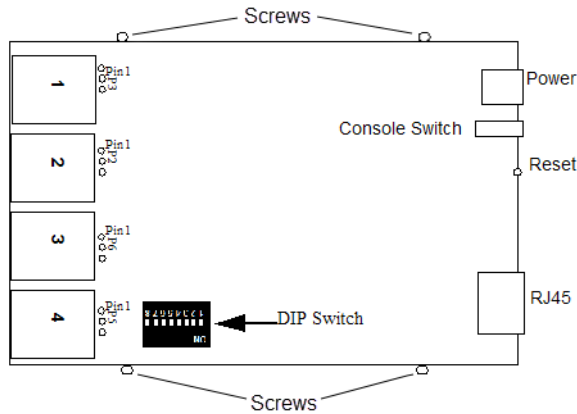

3. To change the power pin out, locate the set of three pins associated with the line you want to set (Serial port 1 is P3; Serial port 2 is P2, Serial port 3 is P6 and Serial Port 4 is P5. For fixed 5V DC output, jumper pins 1 and 2. For the output to equal the external adapter input, jumper pins 2 and 3.
4. To turn line termination ON, locate the DIP switches above Serial Port 4.
  - To terminate Serial Port 1 for Full Duplex set DIP switch 1 ON. To terminate for Half Duplex set DIP switch 2 to ON.
  - To terminate Serial Port 2 for Full Duplex set DIP switch 3 ON. To terminate for Half Duplex set DIP switch 4 to the ON position.
  - To terminate Serial Port 3 for Full Duplex set DIP switch 5 ON. To terminate for Half Duplex set DIP switch 6 ON.
  - To terminate Serial Port 4 for Full Duplex set DIP switch 7 ON. To terminate for Half Duplex set DIP switch 8 to ON.
5. Close the IOLAN case by replacing the case lid and the four screws. You can now power the IOLAN with the new settings.

## Appendix E - IOLAN Maintenance

- Ensure there is clearance of 50.8mm (2 inches) on all sides of the IOLAN to provide proper airflow through the unit
- Do not use solvents or cleaning agents on this unit
- Keep vent holes clear of debris
- If case gets dirty wipe with a dry cloth
- Ensure all cables are in working condition