



**Para Systems, Inc.**  
1455 Lemay Dr.  
Carrollton, TX 75007  
Phone: 1-972-446-7363  
Fax: 1-972-446-9011  
Internet: [minutemanups.com](http://minutemanups.com)  
UPS Sizing: [sizemyups.com](http://sizemyups.com)



---

## **Encompass RT On-Line UPS Series**

---

### **User's Manual**

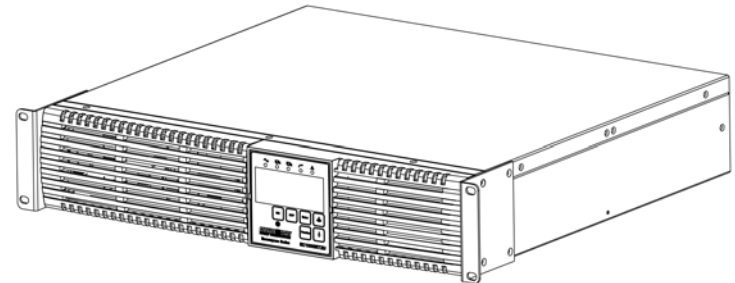

# Table Of Contents

<b>1.</b>	<b>Introduction</b>	<b>2</b>
<b>2.</b>	<b>Controls and Indicators</b>	<b>6</b>
<b>3.</b>	<b>Installation</b>	<b>9</b>
<b>4.</b>	<b>Operation</b>	<b>14</b>
<b>5.</b>	<b>Configurable Parameters &amp; Settings</b>	<b>19</b>
<b>6.</b>	<b>Obtaining Service</b>	<b>20</b>
<b>7.</b>	<b>Troubleshooting</b>	<b>21</b>
<b>8.</b>	<b>Replacing the Battery</b>	<b>22</b>
<b>9.</b>	<b>Specifications</b>	<b>25</b>
<b>10.</b>	<b>Limited Product Warranty</b>	<b>27</b>
<b>A1.</b>	<b>Declaration of Conformity</b>	<b>28</b>

## Chapter 1: Introduction

Thank you for purchasing this power protection product. It has been designed and manufactured to provide many years of trouble free service. Please read this manual before installing your Encompass On-Line Series UPS, models [EC1000RT2U](#), [EC1500RT2U](#), [EC2000RT2U](#), [EC3000RT2U](#) as it provides important information that should be followed during the installation and the maintenance of the UPS system allowing you to correctly set up your system for the maximum safety and performance. Included is information on customer support and factory service, if it is required. If you experience a problem with the UPS system please refer to the Troubleshooting guide in this manual to correct the problem or collect enough information so that the Technical Support Department can assist you.

**IMPORTANT SAFETY INSTRUCTIONS**  
**SAVE THESE INSTRUCTIONS !**  
**CONSIGNES DE SÉCURITÉ IMPORTANTES**  
**SAUVEGARDEZ CES CONSIGNES!**

Veuillez lire ce manuel avant l'installation de l'onduleur modèles [EC1000RT2U](#), [EC1500RT2U](#), [EC2000RT2U](#), [EC3000RT2U](#). Il contient de l'information importante qui doit être respectée au cours de l'installation et de l'entretien de l'onduleur et des batteries. Cette information vous permettra de correctement installer le système pour atteindre son rendement maximum en toute sécurité.

**CAUTION!** The maximum ambient operating temperature for this UPS series is 40°C ("0 ~ 40°C" for Ambient Operation).

- The external vents and openings on the UPS are provided for ventilation. To ensure reliable operation of the UPS and to protect the UPS from overheating, these vents and openings must not be blocked or covered. Do not insert any object into any of the vents or openings that may hinder the ventilation.
- Install the UPS system in a well ventilated area, away from excess moisture, heat, dust, flammable gas or explosives.
- Leave adequate space (at least 20cm) in the front and at the rear of the UPS system for proper ventilation.
- Do not mount the UPS system with its front or rear panel facing down at any angle.
- Before usage, you must allow the UPS system to adjust to room temperature (20°C~25°C or 68°F~77°F) for at least one hour to avoid moisture condensing inside the UPS.

**CAUTION!** This UPS series is **ONLY** intended to be installed in an indoor temperature controlled environment that is free of conductive contaminants. This UPS series is not intended for use in a computer room as defined in the Standard for the Protection of Electronic Computer/Data Processing Equipment ANSI/NFPA 75.

**CAUTION!** Connect the UPS to a two pole, three wire grounded AC wall outlet. The receptacle must be connected to the appropriate branch protection (circuit breaker or fuse). Connection to any other type of receptacle may result in a shock hazard and violate local electrical codes. Do not plug the UPS into extension cords, adapter plugs or surge strips.

**CAUTION!** To reduce the risk of fire, connect only to a utility powered circuit provided with 20 / 30 amperes maximum branch circuit over-current protection in accordance with the National Electric Code, ANSI/NFPA 70.

**CAUTION!** To reduce the risk of electrical shock with the installation of this UPS equipment and the connected equipment, the user must ensure that the combined sum of the AC leakage current does not exceed 3.5mA.

**CAUTION!** To reduce the risk of electrical shock in conditions where the load equipment grounding cannot be verified, disconnect the UPS from the AC wall outlet before installing a computer interface cable. Reconnect the power cord only after all signaling connections are made.

**WARNING:** This Uninterruptible Power Supply contains potentially hazardous voltages. Do not attempt to disassemble the UPS beyond the battery replacement procedure. This UPS contains no user serviceable parts. Repairs and Battery replacement must be performed by **QUALIFIED SERVICE PERSONNEL ONLY**.

**WARNING: Qualified Service Personnel ONLY** must perform the Installation and Servicing of these UPS systems. MINUTEMAN accepts no liabilities and is not limited to: injury to the Service Personnel, or damages to; the UPS, or the connected equipment caused by the incorrect installation or servicing of the UPS system.

**WARNING:** Risk of Electrical Shock. Hazardous live parts inside these power supplies are energized from the battery even when the AC input is disconnected.

**CAUTION! DO NOT USE THE MOUNTING BRACKETS TO LIFT THE UPS.** The mounting brackets are **ONLY** for securing the UPS to the rack.

**NOTE:** These UPSs are shipped with the batteries disconnected. The batteries must be connected before putting these UPSs into service. Refer to Section 3 "Installation" for connecting the batteries.

**CAUTION!** To de-energize the outputs of the UPS:

1. If the UPS is on press and then release the OFF button after the audible alarm beeps twice to turn the UPS off.
2. Disconnect the UPS from the AC wall outlet.
3. To de-energize the UPS completely, disconnect the battery.

**ON BUTTON:** When the UPS is connected to an AC source and there is an acceptable AC voltage present; Press and then release the ON button after the audible alarm beeps twice to turn the UPS on and power the load.



**DC START:** Press and then release the ON button after the audible alarm beeps twice. Then within 10-seconds press and then release the ON button after the audible alarm beeps twice to DC start the UPS and power the load.

**OFF BUTTON:** When the UPS is in the AC normal mode; Press and then release the OFF button after the audible alarm beeps twice to turn the UPS off. The UPS will continue to charge the batteries whenever it is plugged into a wall outlet and there is acceptable AC voltage present.



**NOTICE:** This equipment has been tested and found to comply with the limits for a Class A and/or B computing device in accordance with the specifications in Subpart J of Part 15 of FCC Rules and the Class A and/or B limits for radio noise emissions from digital apparatus set out in the Radio Interference of the Canadian Department of Communications. These limits are designed to provide reasonable protection against such interference in a residential installation. This equipment generates and uses radio frequency and if not installed and used properly, that is, in strict accordance with the manufacturer's instructions, this equipment may cause interference to radio and television reception. If this equipment does cause interference to radio or television reception, which can be determined by turning the equipment off and on, the user is encouraged to try to correct the interference by one or more of the following measures:

- Re-orient the receiving antenna.
- Relocate the computer with respect to the receiver.
- Move the computer away from the receiver.
- Plug the computer into a different outlet so that the computer and receiver are on different branch circuits.
- Shielded communications interface cables must be used with this product.

**WARNING:** Changes or modifications to this unit not expressly approved by the party responsible for compliance could void the user's authority to operate the equipment.

**Receiving Inspection**

After removing your UPS from its carton, it should be inspected for damage that may have occurred in shipping. Immediately notify the carrier and place of purchase if any damage is found. Warranty claims for damage caused by the carrier will not be honored. The packing materials that your UPS was shipped in are carefully designed to minimize any shipping damage. In the unlikely case that the UPS needs to be returned to the manufacturer, please use the original packing material. Since the manufacturer is not responsible for shipping damage incurred when the system is returned, the original packing material is inexpensive insurance. **PLEASE SAVE THE PACKING MATERIALS!**



**Life Support Policy**

As a general policy, we do not recommend the use of any of our products in life support applications where failure or malfunction of the product can be reasonably expected to cause failure of the life support device or to significantly affect its safety or effectiveness. We do not recommend the use of any of our products in direct patient care. We will not knowingly sell our products for use in such applications unless it receives in writing assurances satisfactory to us that (a) the risks of injury or damage have been minimized, (b) the customer assumes all such risks, and (c) our liability is adequately protected under the circumstances.

**© COPYRIGHT 2017 BY PARA SYSTEMS, INC.**

All Rights Reserved. All rights of this User's Manual ("Manual"), including but not limited to the content, information, and figures are solely owned and reserved by Para Systems, Inc. ("Para Systems"). The Manual can only be applied to the operation or the use of this product. Any disposition, duplication, dissemination, reproduction, modification, translation, extraction, or usage of this Manual in whole or in part is prohibited without the prior written permission of Para Systems. Given that Para Systems will continuously improve and develop the product, changes may be made to the information in this Manual at any time without obligation to notify any person of such revision or changes. Para Systems will make all possible efforts to secure the accuracy and the integrity of this Manual. Para Systems disclaims any kinds or forms of warranty, guarantee, or undertaking, either expressly or implicitly, including but not limited to the completeness, faultlessness, accuracy, non-infringement, merchantability or fitness for a particular purpose of the Manual.

## Chapter 2: Controls and Indicators

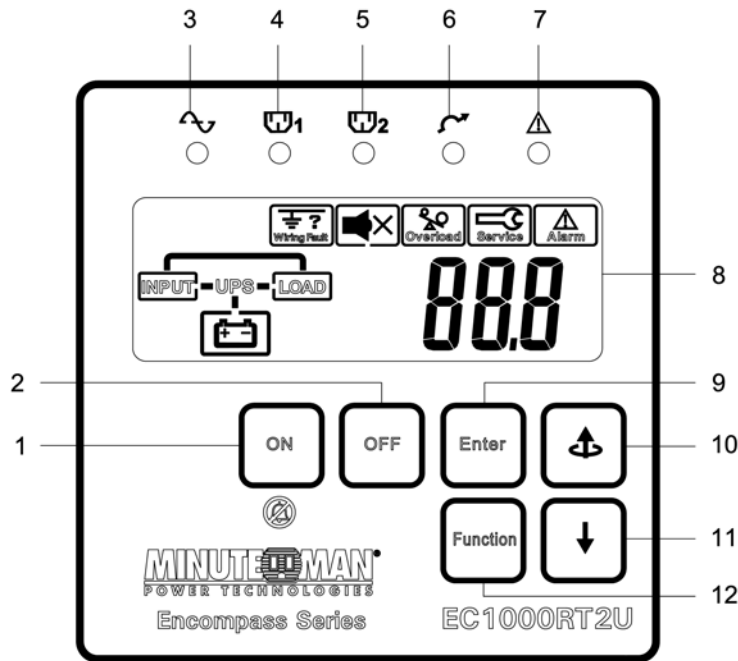

1. The ON button is to turn the UPS on. Pressing the ON button during the Battery mode will silence the alarm.
2. The OFF button is to turn the UPS off.
3. The Utility Power (Green) LED illuminates when Utility Power is present and extinguishes during the Battery mode.
4. The Load Bank 1 (Green) LED is illuminated when the Load Bank is on.
5. The Load Bank 2 (Green) LED is illuminated when the Load Bank is on.
6. The Bypass Active (Yellow) LED illuminates when the UPS is in the Bypass mode.
7. The Weak/Bad Battery (Red) LED illuminates when the UPS detects a weak battery, bad battery or if the battery is disconnected. The Weak/Bad Battery icon is extinguished when the battery's condition is good.
8. The LCD displays the status of the UPS.
9. Pressing the Enter button saves the changes made to the UPS settings.
10. Pressing the Page Up button goes to the previous page or will change the UPS settings.
11. Pressing the Page Down button goes to the next page.
12. Pressing the Function button and then the Page Up button will initiate a 10-second battery test.

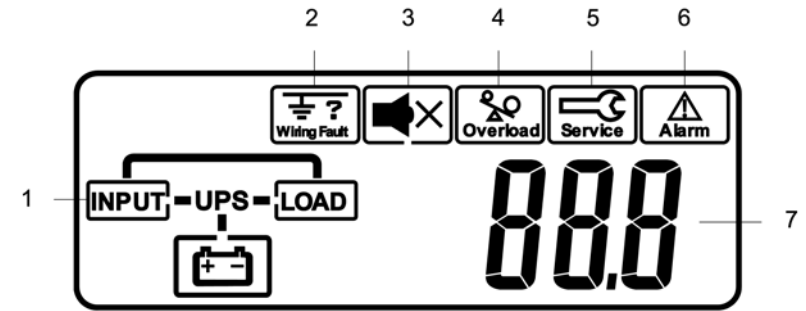

1. Displays the power flow of the UPS:

AC Mode Power Flow

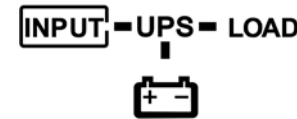

Bypass Mode Power Flow

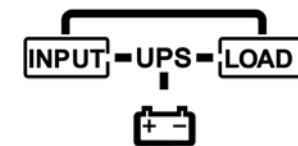

Battery Mode Power Flow

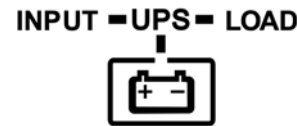

2. The Site Wiring Fault icon illuminates when the UPS detects a site wiring problem. The SWF icon is extinguished when the UPS is connected to properly wired wall outlet.
3. The Alarm Silencer icon illuminates when the audible alarm has been silenced.
4. The Overload icon will illuminate when the amount of load attached to the UPS is  $\geq 106\%$  of its power rating.
5. The Service icon illuminates when the UPS requires service.
6. The Alarm (Fault) icon illuminates when the UPS detects an internal fault.
7. Numerical values of the UPS parameters and error codes.

The UPS reports the following parameters on the LCD screen:

Input:	Voltage, Frequency
Output:	Voltage, Frequency, Current, Percentage of load
Battery:	Voltage
Runtime:	The time operating on the Battery mode in minutes
Temperature:	The internal temperature of the UPS in degrees C

**NOTE:** The LCD backlight will illuminate for 20-seconds when the UPS is connected to utility power, when the UPS is turned ON/OFF, when any of the buttons on the LCD panel are touched and when the UPS switches to the Battery mode. When the UPS has an event and/or an error code the LCD backlight will turn on and remain on to alert the user that an event has occurred.

**REAR PANEL**

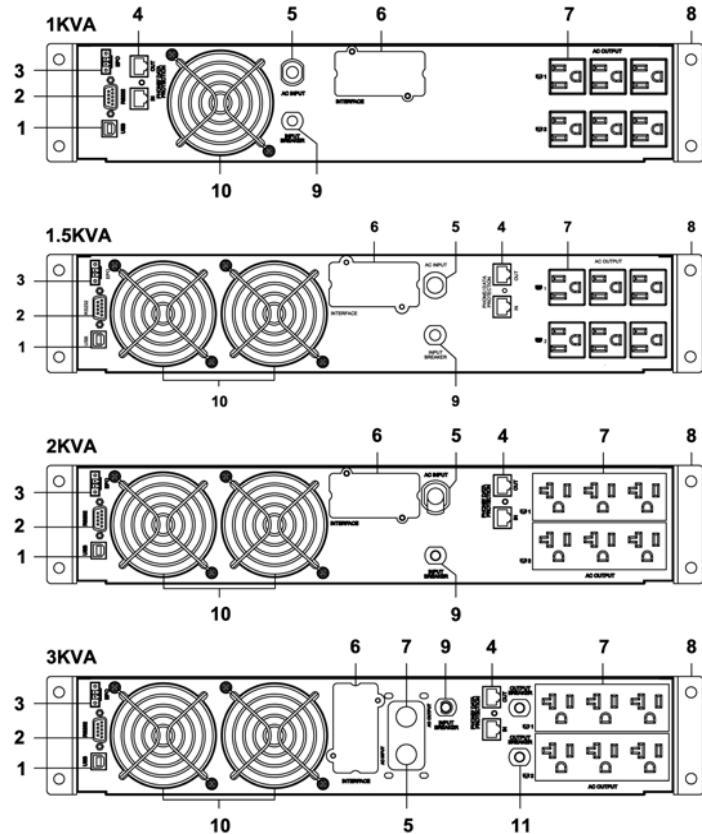

1. The USB Communications Port is for UPS monitoring and control.
2. The RS232 Communications Port is for UPS monitoring and control.
3. The EPO (Emergency Power Off) Port is for UPS control.
4. The R-J11/R-J45 modular connectors are used for 10/100/1000 Base-T Network/single line Phone/Fax/Modem protection.
5. The input power cord is for connecting to utility power.
6. The option slot is for option cords.
7. The Battery Backup output receptacles. The output receptacles are electrically wired into two segments to support the "Load Shedding Function" (Labeled 1 & 2). The 3KVA has a locking receptacle (Always On) that does not support the "Load Shedding Function". **NOTE:** The locking receptacle is not on all models.
8. The rackmount brackets.
9. The input circuit breaker will trip in the event the load exceeds the UPS's power rating.
10. The fan is for ventilation.
11. The output circuit breaker will trip in the event the load exceeds the UPS's power rating. **NOTE:** The output circuit breaker is not on all models.

Model #	Input Power Plug (All power cords are 10ft)	Output Power Receptacles
EC1000RT2U	NEMA 5-15P	6-NEMA 5-15R (Controllable)
EC1500RT2U	NEMA 5-15P	6-NEMA 5-15R (Controllable)
EC2000RT2U	NEMA 5-20P	6-NEMA 5-15/20R (Controllable)
EC3000RT2U	NEMA L5-30P	6-NEMA 5-15/20R (Controllable) 1-NEMA L5-30R (Always On)

**Chapter 3: Installation**

**INSTALLATION PLACEMENT**

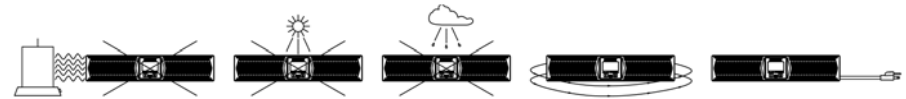

This UPS series is **ONLY** intended to be installed in an indoor temperature controlled environment that is free of conductive contaminants. DO NOT operate the UPS in: extremely dusty and/or unclean areas, locations near heating devices, water or excessive humidity, or where the UPS is exposed to direct sunlight. Select a location, which will provide good air circulation for the UPS at all times. Route power cords so they cannot be walked on or damaged. This UPS series is not intended for use in a computer room as defined in the Standard for the Protection of Electronic Computer/Data Processing Equipment ANSI/NFPA 75. Typical battery life is 3 to 5 years. Environmental factors do affect battery life. High temperatures, poor utility power, and frequent, short duration discharges have a negative impact on battery life.

- Operating Temperature (Maximum): 0 to 40°C (+32 to +104°F)
- Operating Elevation: 0 to 3,000m (0 to +10,000 ft)
- Operating and Storage Relative Humidity: 10% to 90%, non-condensing
- Storage Temperature: -15 to +45°C (+5 to +113°F)
- Storage Elevation: 0 to 15,000m (0 to +50,000 ft)

**INSTALLATION**

Be sure to read the installation placement and all the cautions before installing the UPS. Place the UPS in the final desired location and complete the rest of the installation procedure. These UPSs are shipped with the internal batteries disconnected. The batteries must be connected before putting these UPSs into service. See the "Connecting the Batteries" procedure to connect the batteries and then the "Rackmount Configuration" to install the UPS into the rack. **USE CAUTION:** The UPS is heavy. Use the appropriate number of personnel when installing the UPS.

**CAUTION! DO NOT USE THE MOUNTING BRACKETS TO LIFT THE UPS.** The mounting brackets are **ONLY** for securing the UPS to the rack.

## CONNECTING THE BATTERIES

(QUALIFIED SERVICE PERSONNEL ONLY)

Please read all of the **WARNINGS** and **CAUTIONS** before attempting to connect the batteries.

**CAUTION! DO NOT USE THE MOUNTING BRACKETS TO LIFT THE UPS.** The mounting brackets are **ONLY** for securing the UPS to the rack.

**WARNING:** Use two or more people when installing the UPS, the UPS is extremely heavy.

1. Remove the UPS from the shipping box and place on a flat surface.
2. Grasp the battery door on the left hand side, pull it outward and then set it aside (FIG. 1).
3. Press down to unlock the battery connector holder. Verify proper polarity. Connect the battery connectors (red and black) together. Place the battery connectors in the battery connector holder and then relock the battery connector holder (FIG. 2).

**NOTE:** Some sparking may occur this is normal.

4. Re-install the battery door on the UPS.
5. Connecting the Batteries is complete. See the Rackmount Configuration.

**FIG. 1**

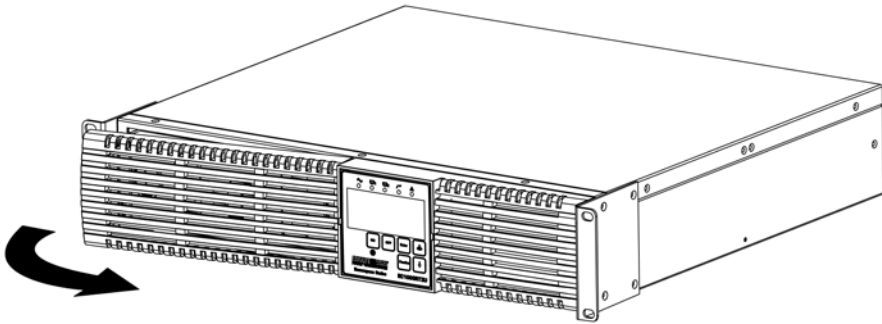

**FIG. 2**

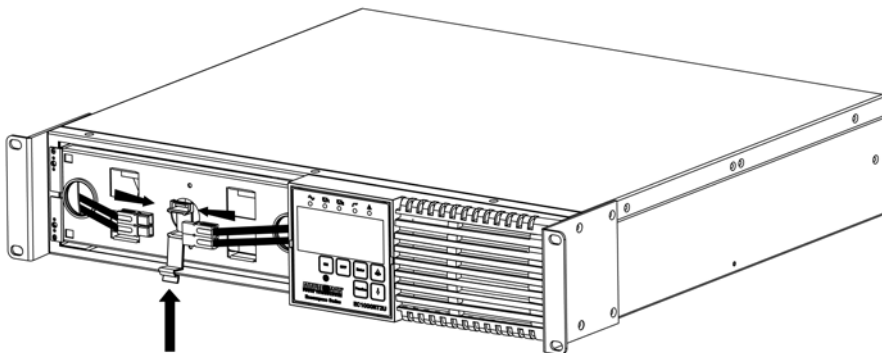

## RACKMOUNT CONFIGURATION

This UPS series comes with mounting brackets for the standard 19" (46.5cm) rack pre-installed on the UPS. There are optional Rail Kits for the 4-post racks and cabinets available. The screws for mounting the UPS to the rack are included. **NOTE:** The Rail Kit for a 4-post rack and/or cabinet is included with the EC3000RT2U.

**CAUTION! DO NOT USE THE MOUNTING BRACKETS TO LIFT THE UPS.** The mounting brackets are **ONLY** for securing the UPS to the rack.

1. Mount the UPS into the rack and secure with the retaining screws (provided). **WARNING:** Use two or more people when installing the UPS, the UPS is extremely heavy. Do not move the rack after the units have been installed. The rack may become unstable due to the weight distribution.
2. The Rackmount Configuration is complete. See Connecting your Equipment.

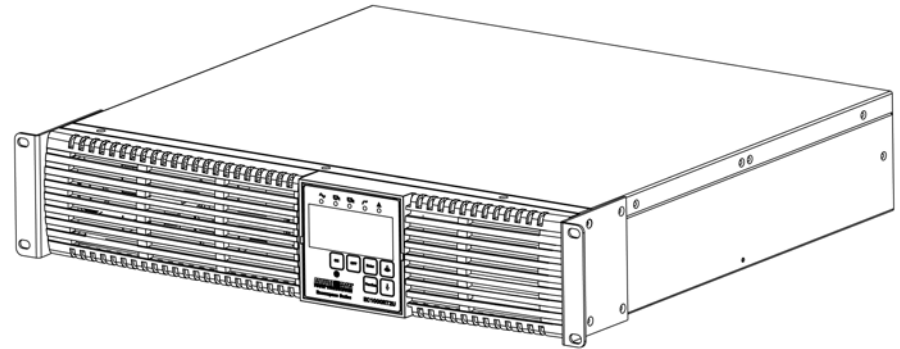

## **TOWER CONFIGURATION**

The tower configuration allows the user to install the UPS in the up-right position. The tower brackets are provided with the UPS. **WARNING:** Use two or more people when installing the UPS, the UPS is extremely heavy.

1. Once the location of the UPS has been determined, place the UPS on a flat surface, remove the rackmount brackets from the UPS and then attach the four (4) tower brackets as shown below.
2. Stand the UPS in the up-right position and place it in the desired location. Make sure that the UPS is stable.
3. The LCD panel can be rotated to read in the up-right position. There are two small slots, one on each side of the LCD panel. Insert a small flat screwdriver into the slot to pop out the LCD panel. Position the LCD panel so that it reads in the up-right position. Press the LCD panel back into the front panel.

**WARNING:** The UPS must be installed in the proper up-right position. If the UPS is not installed in the proper up-right position the Batteries will be damaged. Once the UPS is placed in the tower brackets, looking at the front panel the YELLOW Battery disconnected label on the top cover of the UPS MUST be on your left hand side.

4. The Tower Configuration is complete. See Connecting your Equipment.

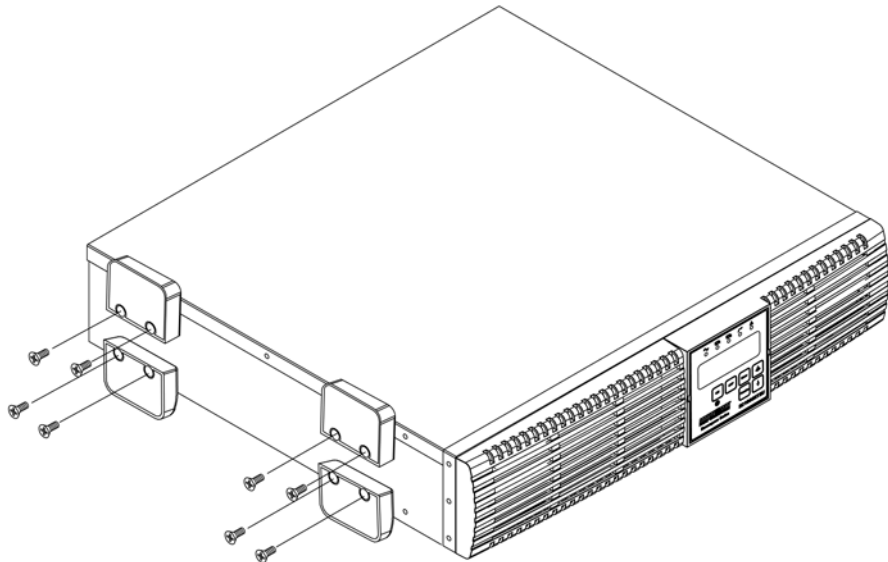

## **CONNECTING YOUR EQUIPMENT**

Plug the equipment into the output receptacles on the rear panel of the UPS. Ensure that you do not exceed the maximum output rating of the UPS (refer to the information label or the Electrical Specifications in this manual). **DO NOT PLUG EXTENSION CORDS, ADAPTER PLUGS OR SURGE STRIPS INTO THE OUTPUT RECEPTACLES OF THE UPS.**

**CAUTION! DO NOT** connect a laser printer to the output receptacles on the UPS, unless the UPS is rated 2000VA or greater. A laser printer draws significantly more power when printing than at idle and may overload the UPS.

## **CONNECTING THE UPS TO AN AC SOURCE**

Plug the UPS into a two pole, three wire, grounded AC wall outlet. The AC wall outlet shall be near the UPS and shall be easily accessible. The plug on the input power cord on this UPS series is intended to serve as a disconnect device. **DO NOT PLUG THE UPS INTO EXTENSION CORDS, ADAPTER PLUGS OR SURGE STRIPS. DO NOT CUT THE INPUT PLUG OFF AND ATTEMPT TO HARDWIRE THIS UPS, DOING SO WILL VOID THE WARRANTY.**

## **CHECKING THE SITE WIRING FAULT**

After plugging the UPS into the AC wall outlet, check the Site Wiring Fault icon on the front panel of the UPS. If the Site Wiring Fault icon is illuminated and error code Er16 is displayed, the UPS is plugged into an improperly wired AC wall outlet. If the UPS indicates a Site Wiring Fault have a Qualified Electrician correct the problem.

## **CHARGING THE BATTERY**

The UPS will charge the internal batteries whenever the UPS is connected to an AC source and there is an acceptable AC voltage present (55V (load dependent) - 150VAC). It is recommended that the UPS's batteries be charged for a minimum of 4 hours before use. The UPS may be used immediately, however, the "On-Battery" runtime may be less than normally expected. **NOTE:** If the UPS is going to be out of service or stored for a prolonged period of time, the batteries must be recharged for at least twenty-four hours every ninety days.

## **NETWORK/PHONE/FAX/MODEM PROTECTION CONNECTION (OPTIONAL)**

Connect a 10/100/1000 Base-T network, single line phone, Fax or Modem line to the RJ11/45 modular connectors on the rear panel of the UPS. This connection will require another length of telephone or network cable. The cable coming from the telephone service or networked system is connected to the port marked "IN". The equipment to be protected is connected to the port marked "OUT". **NOTE:** Connecting to the Network/Phone/Fax/Modem modular connectors is optional. The UPS works properly without this connection.



**COMMUNICATIONS PORT CONNECTION (OPTIONAL)**

The Power Monitoring Software and interface cables can be used with the UPS. Use only the interface cables that come with these UPSs. Connect the interface cable (Serial or USB) to the appropriate communications port on the rear panel of the UPS. Connect the other end of the cable to the device that will be monitoring/controlling the UPS. **NOTE:** Connecting to the Communications Port is optional. The UPS works properly without this connection.

**EMERGENCY POWER OFF (EPO) FUNCTION**

Connect one end of a two (2) wire cable to the EPO port on the rear panel of the UPS and the other end of the two (2) wire cable to an EPO switch. To shutdown the UPS in the AC or the Battery mode short pin1 to pin2 for approximately 0.5-seconds. In the AC mode; the UPS must be turned off and then back on again to restart the UPS. In the Battery mode; once the utility power returns the UPS must be turned on to restart the UPS. The LCD will display EPo for this function.

**OPTION SLOT (OPTIONAL)**

The option slot on the rear panel of the UPS is for the SNMP and the Relay cards. Remove the cover plates from the option slot. Install the SNMP card or the Relay card. Connect the appropriate interface cable to the SNMP card or the Relay card on the rear panel of the UPS. Connect the other end of the cable to the device that will be monitoring/controlling the UPS. **NOTE:** Using the Option Slot optional. The UPS works properly without this connection.

**Chapter 4: Operation**

**SYSTEM OVERVIEW**

This double conversion On-Line UPS protects computers, servers, telecommunications, security and other electronic equipment from blackouts, brownouts, overvoltages, and surges. This On-Line UPS converts the input AC to DC and then back to a true sine wave AC output. The true sine wave output is regulated within 2% of the nominal output voltage. The Power Factor Correction (PFC) circuitry corrects the input power factor to within 99% of unity and blocks the load generated harmonic distortion from getting back on the input AC line. This On-Line UPS provides a continuous true sine wave output with zero transfer time and great regulation to protect your mission critical equipment. The UPS will quietly and confidently protect your system from power anomalies.

The UPS will charge the batteries when the UPS is in the on or off position as long as the UPS is plugged into the wall outlet and there is an acceptable AC voltage present (55V (load dependent) - 150VAC). When a blackout, brownout, or an overvoltage condition occurs while the UPS is in the On-Line mode or the Economy mode; the UPS will transfer to the battery mode, the On-Battery indicator will illuminate and the audible alarm will sound once every ten-seconds indicating that the utility power is lost or unacceptable. When the utility power returns or is at an acceptable level, the UPS will automatically transfer back to the On-Line mode or the Economy mode and start recharging the batteries. During an extended outage when there is approximately two-minutes of backup time remaining the audible alarm will sound twice every five-seconds. This Low Battery Warning is letting the user know that they should save all open files and turn off their equipment. When the batteries reach the predetermined level the UPS will automatically shutdown protecting the batteries from over discharging. Once the utility power returns the UPS will automatically restart providing safe usable power to the connected equipment and start recharging the batteries.

The Economy mode operation: The input utility power 'bypasses' the inverter circuit and is connected directly to the output of the UPS powering the connected equipment while simultaneously charging the batteries. When a blackout, brownout, or an overvoltage condition occurs the UPS will transfer to the battery mode, the inverter will turn on powering the connected equipment, the On-Battery indicator will illuminate and the audible alarm will sound once every ten-seconds indicating that the utility power is lost or unacceptable. When the utility power returns or is at an acceptable level, the UPS will automatically transfer back to the Economy mode and start recharging the batteries.

**Block Diagram of the Basic Wiring and Internal Circuit Configuration**

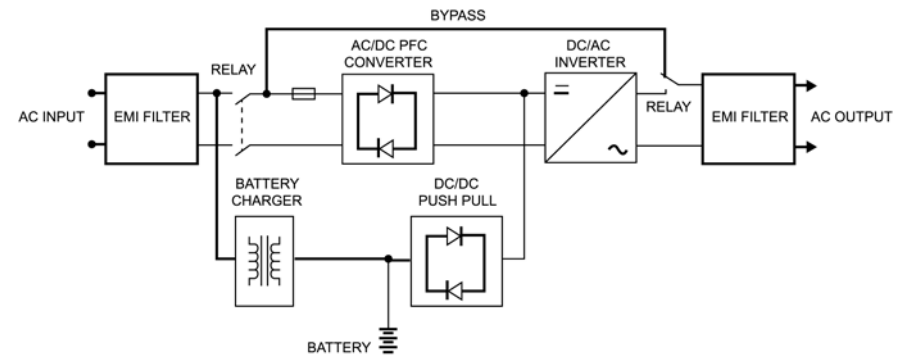

## TURNING THE UNIT ON/OFF

### Turning the unit On

When the UPS is connected to an AC source and there is an acceptable AC voltage present; Press and then release the ON button after the audible alarm beeps twice to turn the UPS On and power the load.



**DC START:** Press and then release the ON button after the audible alarm beeps twice. Then within 10-seconds press and then release the ON button after the audible alarm beeps twice to DC start the UPS and power the load.

### Turning the unit Off

When the UPS is in the AC normal mode; Press and then release the OFF button after the audible alarm beeps twice to turn the UPS Off. The UPS will continue to charge the batteries whenever it is plugged into a wall outlet and there is acceptable AC voltage present.



## ALARM SILENCER

When the UPS is operating in the Battery mode press the ON button to silence the audible alarm. Once the UPS reaches the Low Battery Warning (LBW) threshold the audible alarm will start beeping again. When the UPS returns to the normal AC mode the audible alarm will reset to default. The audible alarm cannot be silenced during the LBW or any Fault/error event.

## USER INVOKED BATTERY TEST

The user invoked battery test feature is useful to verify the correct operation of the UPS and the condition of the batteries. With the UPS in the AC normal mode; Press the Function button and then the Page Up button. The UPS will perform a ten-second battery test to measure the battery's capability to support the connected load. During the battery test, the UPS will switch to the battery mode, the Battery mode power flow will illuminate and the audible alarm will sound. If the UPS fails a battery test, one of the icons and/or error codes will remain illuminated indicating the type of problem.

## LOAD SHEDDING FUNCTION

The output receptacles are electrically wired into two segments to support the "Load Shedding Function" (Labeled 1 & 2). The user can control the two segments individually or both at the same time. The Load Shedding Function is controllable by the Power Monitoring Software or the SNMP card. **NOTE:** The locking receptacle (Always On) does not support the "Load Shedding Function".

## ECONOMY MODE (ECO) FUNCTION

The UPS must be turned on and in the normal AC mode. The Economy mode option must be Enabled through the SNMP card or the Power Monitoring software. Once the Economy mode has been Enabled the LCD will display ECO and the Bypass (Yellow) LED will be illuminate. Turn on the connected equipment one at a time.

## EMERGENCY POWER OFF (EPO) FUNCTION

Connect one end of a two (2) wire cable to the EPO port on the rear panel of the UPS and the other end of the two (2) wire cable to an EPO switch. To shutdown the UPS in the AC or the Battery mode short pin1 to pin2 for approximately 0.5-seconds. In the AC mode; the UPS must be turned off and then back on again to restart the UPS. In the Battery mode; once the utility power returns the UPS must be turned on to restart the UPS. The LCD will display EPO for this function.

## CHANGING THE OUTPUT VOLTAGE

The output voltage can be configured for 110V, 120V, or 127V. The default setting for the output voltage is 120V. To change the output voltage follow the steps below:

1. Connect the UPS to utility power. **DO NOT** turn on the UPS.
2. Press the ON button and the Page Down button simultaneously until the audible alarm beeps once and then release.
3. Use the Page Up button to select the desired output voltage setting and then press the Enter button to save the changes.
4. Press the ON button to turn on the UPS and verify the output voltage. Changing the output voltage is complete. The UPS is ready for normal operation.

## COMMUNICATIONS PORTS (RS232 and USB)

The RS232 communication port is a standard DB9 female. The pinout for the port is below:

Pin 2: /TXD

Pin 3: /RXD

Pin 5: Ground

The USB protocol is HID. The HID USB driver is the standard for the Windows OS. Simply plug the USB cable into the UPS and the computer then follow the prompts on the screen. **NOTE: When using the UPS's USB port with Windows XP, 7,8 or 10 the Power Options in the Control Panel may need to be configured.**

## POWER MONITORING SOFTWARE

The UPS comes with a Power Monitoring Software CD or you can go to our web site at [www.minutemanups.com/support](http://www.minutemanups.com/support), then look under Downloads, and then Software Download Center. Please download (Free of Charge) the latest version of the Minuteman SentryHD software. See the software CD for the installation of the Power Monitoring Software.

## OPTION SLOT

The option slot on the rear panel of the UPS is for option cards. Contact your local dealer or visit our Web site at [www.minutemanups.com](http://www.minutemanups.com) for the available option cards for this series.

## ALARMS

### ON BATTERY

When the UPS is operating on the batteries, the On-Battery icon will illuminate, the Utility power LED (Green) will extinguish and the audible alarm will sound one beep every ten-seconds. The audible alarm can be silenced during this condition. The alarm will stop once the UPS returns to the AC normal mode.

### LOW BATTERY WARNING

When the UPS is operating on the batteries and the battery reserve is running low, the audible alarm will sound two beeps every five-seconds and error code Er17 will be displayed. This condition will continue until AC returns or the UPS shuts down from battery exhaustion. **NOTE:** The audible alarm cannot be silenced during this condition.

### WEAK/BAD/DISCONNECTED BATTERY

The UPS automatically tests the battery's condition. If the battery is weak, bad or disconnected, the Weak/Bad/Disconnected Battery icon will illuminate, error code Er15 will be displayed and the audible alarm will beep three times every five-minutes until the battery is reconnected, replaced or passes a self test. It is recommended that the UPS be allowed to charge overnight before performing a battery test to confirm a Weak/Bad Battery condition. **NOTE:** The audible alarm cannot be silenced during this condition.

### OVERLOAD

When the amount of load attached to the UPS is  $\geq 106\%$  of its power rating; the Overload icon will illuminate, the error code Er02 will be displayed and the audible alarm will beep continuously. This alarm will remain on until the excess load is removed or the UPS's self protection circuit shuts the UPS down. If the UPS shuts down because of an Overload condition, the UPS must perform an Inverter function or a Self Test to clear the Overload Alarm. **NOTE:** The audible alarm cannot be silenced during this condition.

### UPS FAULT

When the UPS detects a hardware and/or internal fault, the Fault icon will illuminate and the audible alarm will beep continuously. The fault condition, in some instances, may be reset by turning the UPS off and then on again. **NOTE:** The audible alarm cannot be silenced during this condition.

### SITE WIRING FAULT

If the Site Wiring Fault icon is illuminated and error code Er16 is displayed, the UPS is plugged into an improperly wired AC wall outlet. If the UPS indicates a Site Wiring Fault have a Qualified Electrician correct the problem.

## Chapter 5: Configurable Parameters and Settings

(These items may require optional software or hardware)

Function	Factory Default	User Choices	Description
Battery install date	Date of manufacture	Date of battery replacement - month/day/year XX/XX/XXXX	Enter the current date when replacing batteries.
Battery replace date	5 years from the install date	Date of the next battery replacement - month/day/year XX/XX/XXXX	Enter the date of the next battery replacement.
Enable/Disable auto restart	Enabled	Enable or Disable	When <u>enabled</u> , the UPS will automatically restart from a low battery shutdown when normal AC returns.
Set audible alarm state	Enabled	Enabled, at low battery, disabled	<u>Enabled</u> - the UPS will emit a short beep when in the battery mode. <u>At Low Battery</u> the UPS will emit two beeps from low battery warning until shutdown. <u>Disabled</u> - Use only when software is controlling the UPS or to silence the alarm.
Shutdown Type	Entire UPS	Entire UPS or UPS output	<u>Entire UPS</u> - Turns off the entire UPS. <u>UPS Output</u> - Turns off the UPS's output receptacles only.
Set inverter output voltage	120VAC	110, 120, 127VAC	Changes the output voltage.
Enable/Disable ECO	Disabled	Enable or Disable	<u>Enabled</u> - the UPS will operate in the Economy mode.
Enable/Disable Load Shedding	Disabled	Enable, Disable or Configure	<u>Enabled</u> - the specified outlet bank will turn off. <u>Configure</u> - the specified outlet bank will turn on or off based on the selected event.

## Chapter 6: Obtaining Service

### IF THE UPS REQUIRES SERVICE

1. Use the Troubleshooting section to eliminate obvious causes.
2. Verify there are no tripped circuit breakers and that the batteries are good. A tripped circuit breaker and defective batteries are the most common issues.
3. Call your dealer for assistance. If you cannot reach your dealer, or if they cannot resolve the issue call or fax the Technical Support department at the following numbers; Voice phone (972) 446-7363, FAX line (972) 446-9011 or visit our Web site at [www.minutemanups.com](http://www.minutemanups.com) the "Discussion Board". Before calling the Technical Support Department have the following information available:
  - a) Contact name and address.
  - b) Where and when the unit was purchased.
  - c) All of the model information about your unit.
  - d) The serial number of your unit.
  - e) Any information on the failure, including LEDs that may be illuminated or error codes displayed.
  - f) A description of the protected equipment including model numbers, if possible.
  - g) A technician will ask you for the above information and if possible, help solve the issue over the phone. In the event that the unit requires factory service, the Technical Support Representative will issue you a Return Material Authorization Number (RMA #). **NOTE: We must have the model number and the serial number of the product to issue an RMA #.**
  - h) If the unit is under warranty, the repairs will be done at no charge. If the unit is not under warranty there will be a charge for the repair.
4. Pack the unit in its original packaging. If the original packaging is no longer available, ask the Technical Support Representative about obtaining a new set. It is important to pack the unit properly in order to avoid damage in transit. Never use Styrofoam beads for a packing material.
  - a) Include a letter with your name, address, day time phone number, RMA number, a copy of your original sales receipt, and a brief description of the problem.
5. Mark the RMA # on the outside of all packages. The factory cannot accept any package without the RMA # marked on the outside of the package.
6. Return the unit by insured, prepaid carrier to:

Para Systems Inc.  
 MINUTEMAN UPS  
 1809 W. Frankford Road, Suite 150  
 Carrollton, TX 75007  
 ATTN: RMA # \_\_\_\_\_

## Chapter 7: Troubleshooting

Symptom / Error Code	Cause / What To Do
Only the AC normal LED is illuminated.	The UPS has not been turned on. Press the On button and release after the audible alarm beeps twice.
UPS only operates in battery mode, even though there is AC present.	Reset the input circuit breaker by pressing the plunger back in. If the input circuit breaker trips after UPS restarts, reduce the load on the UPS.
UPS does not provide the expected runtime.	Charge the batteries for 8-hours and retest. If the runtime is still less than expected, the batteries may need to be replaced.
The AC normal icon is illuminated, but there is no output.	Disconnect the computer cable from the UPS, press the On button. If UPS works normally, the software has control of the UPS.
The Fault icon is illuminated and a constant alarm.	The UPS has an internal problem. Call for service.
Er01: UPS is shutdown.	The UPS has detected a short-circuit on its output. Check the attached load.
Er02: The Overload icon is illuminated and a constant alarm.	Check the specifications and remove part of the load. If the UPS shuts down because of an Overload, the UPS must perform an Inverter function or a Self Test to clear the Overload Alarm.
Er03: UPS Over Temperature.	The internal temperature has exceeded the safe operating range for the UPS. Check the specifications.
Er08: DC BUS voltage abnormal (High).	Turn the UPS off, unplug the power cord, wait for 5-minutes and then restart the UPS. If the error did not clear call for service.
Er09: DC BUS voltage abnormal (Low).	Turn the UPS off, unplug the power cord, wait for 5-minutes and then restart the UPS. If the error did not clear call for service.
Er10: Inverter Over Current.	Check the specifications and remove part of the load.
Er11: Inverter/Output Failure Shutdown.	The UPS has an internal fault. Call for service.
Er12: DC BUS Pre-charge abnormal.	Turn the UPS off, unplug the power cord, wait for 5-minutes and then restart the UPS. If the error did not clear call for service.
Er13: Fan Failure.	The fan has either failed or has stopped due to excessive dirt. If the fan has failed, call for service. If the fan is dirty, use a can of "Canned Air" to clean the fan.
Er14: Charger Failure.	The charger has failed, call for service.
Er15: Weak/Bad Battery icon is illuminated.	Check the battery connections, charge the batteries for 8-hours and retest. The batteries may need to be replaced.
Er16: Site Wiring Fault.	Have a qualified electrician correct the service wiring.
Er17: Low Battery Warning.	The UPS's battery reserve is low. This condition will continue until AC returns or the UPS shuts down from battery exhaustion.
Er18: EEPROM data error.	Turn the UPS off, unplug the power cord, wait for 1-minute and then restart the UPS. If the error does not clear call for service.
Er26: Input Over Current.	Check the specifications and remove part of the load. If the error did not clear call for service.
Er28: Bypass mode Overload.	Check the specifications and remove part of the load. If the error did not clear call for service.
Er29: Charger overcharges the battery.	The UPS has an internal fault. Call for service.
Er38: Failed to synchronize with utility input.	Turn the UPS off, unplug the power cord, wait for 5-minutes and then restart the UPS. If the error did not clear call for service.
Er39: Low Battery Capacity.	The UPS's battery capacity is low. Charge the batteries for 24-hours. If the error does not clear call for service.

## Chapter 8: Replacing the Battery

### QUALIFIED SERVICE PERSONNEL ONLY

Please read all of the **WARNINGS** and **CAUTIONS** before attempting to service the batteries. Typical battery life is 3 to 5 years. Environmental factors do affect battery life. High temperatures, poor utility power, and frequent, short duration discharges have a negative impact on battery life.

**WARNING!** This UPS contains potentially hazardous voltages. Do not attempt to disassemble the UPS beyond the battery replacement procedure. This UPS contains no user serviceable parts. Repairs and battery replacement must be performed by **QUALIFIED SERVICE PERSONNEL ONLY**.

**CAUTION:** Do not open or mutilate batteries. Released electrolyte is harmful to the skin and eyes and may be toxic.

**CAUTION:** Do not dispose of batteries in a fire. The batteries may explode. The batteries in this UPS are recyclable. Dispose of the batteries properly. The batteries contain lead and pose a hazard to the environment and human health if not disposed of properly. Refer to local codes for proper disposal requirements or return the battery to the supplier.

**CAUTION:** The battery system can present a risk of electrical shock. These batteries produce sufficient current to burn wire or tools very rapidly, producing molten metal. Observe these precautions when replacing the batteries:

1. Remove watches, rings, or other metal objects.
2. Use hand tools with insulated handles.
3. Wear protective eye gear (goggles), rubber gloves and boots.
4. Do not lay tools or other metal parts on top of batteries.
5. Disconnect the charging source prior to connecting or disconnecting the battery terminals.
6. Determine if the battery is inadvertently grounded. If the battery is, remove the source of the grounding. Contact with any part of a grounded battery can result in an electrical shock. The likelihood of such shock will be reduced, if such grounds are removed during installation and maintenance.

**CAUTION:** Replace batteries with the same number and type as originally installed in the UPS. These batteries have pressure operated vents. These UPSs contain sealed non-spillable maintenance-free lead acid batteries.

Model #	EC1000RT2U	EC1500RT2U	EC2000RT2U	EC3000RT2U
Internal Battery Module Part #	BM0069	BM0070	BM0070	BM0071

## BATTERY REPLACEMENT PROCEDURE

### PLEASE READ THE CAUTIONS AND WARNINGS BEFORE ATTEMPTING TO REPLACE THE BATTERY MODULE

Hot-swappable batteries mean that the battery modules can be replaced without powering down the whole UPS system.

**NOTE:** If there is a power interruption while replacing the hot-swappable battery module, with the UPS on, the load will not be backed up. To hot-swap the battery module start with step number 6.

1. Turn off the equipment that is plugged into the output receptacles of the UPS.
2. Press and release the OFF button on the front panel to turn the UPS Off.
3. Unplug the UPS's AC power cord from the AC wall outlet.
4. Unplug the equipment from the output receptacles of the UPS.
5. Unplug the computer interface cable from the rear panel of the UPS.
6. Grasp the battery door on the left hand side, pull it outward and then set it aside (FIG. 1).
7. Press down to unlock the battery connector holder. Disconnect the Battery connectors (red and black). (FIG. 2)
8. Remove the two retaining screws for the battery retaining bracket. (FIG. 2)
9. Remove the battery retaining bracket.

**FIG. 1**

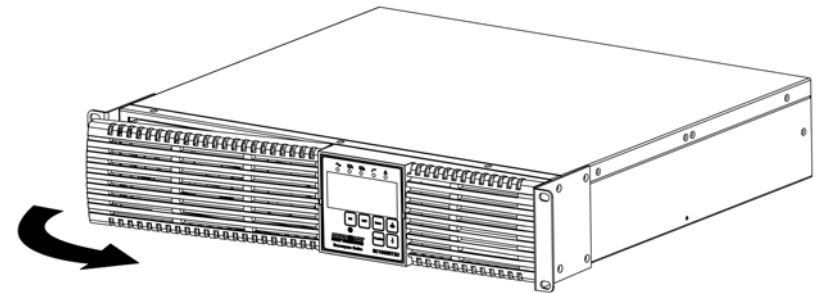

**FIG. 2**

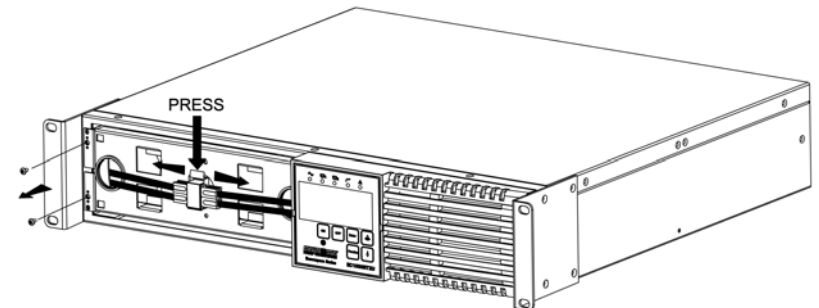

10. Grasp the battery pull tab and gently pull the battery module out of the UPS and set it aside. (FIG. 3)

**NOTE:** Use Caution, the battery module is heavy.

11. Slide the new battery module into the UPS.

12. Re-install the battery retaining bracket.

13. Re-install the two retaining screws for the battery retaining bracket.

14. Verify proper polarity. Reconnect the battery connectors (red and black). (FIG. 4)

**NOTE:** Some sparking may occur this is normal.

15. Place the battery connectors in the holder and then lock in place. (FIG. 4)

16. Re-install the battery door on the UPS.

17. The UPS is now ready for the normal operation.

18. Properly dispose of the old battery module at an appropriate recycling facility or return them to the supplier in the packing material that the new battery module came in.

**NOTE:** If the UPS has a Weak/Bad Battery Alarm after replacing the battery module, the user must initiate a battery test to clear the Weak/Bad Battery Alarm. To initiate a self test see section 4 "**USER INVOKED BATTERY TEST**".

**FIG. 3**

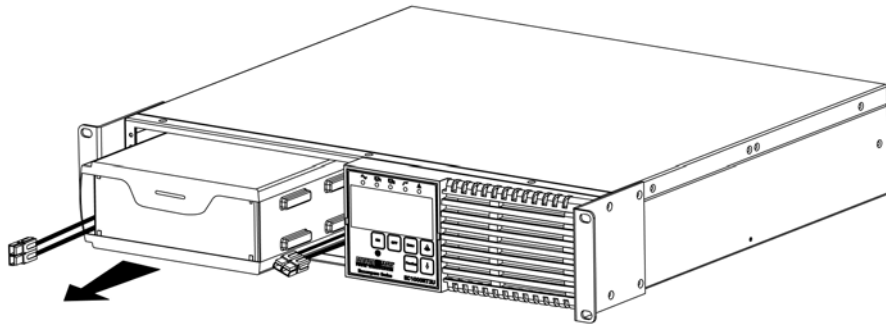

**FIG. 4**

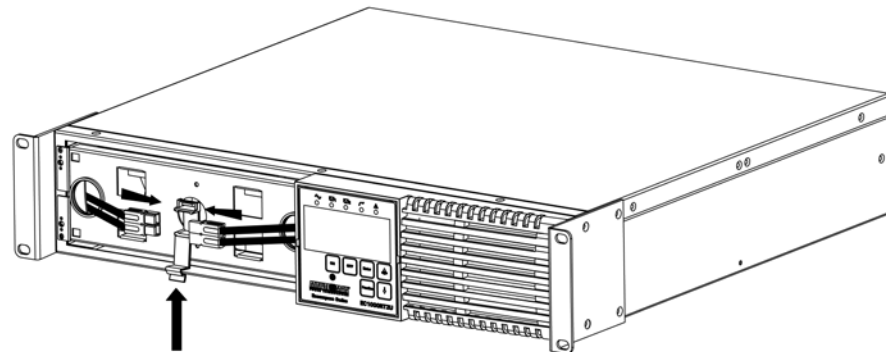

## Chapter 9: Specifications

SYSTEM SPECIFICATIONS				
Model Number	EC1000RT2U	EC1500RT2U	EC2000RT2U	EC3000RT2U
Maximum Power Capacity	1000VA 900W	1500VA 1350W	2000VA 1800W	3000VA 2700W
Topology	Double Conversion On-Line, True Sine Wave			
INPUT				
Number of Phase	Single (1Ø 2W +G)			
Nominal Voltage	120VAC			
Acceptable Input voltage	0 - 160VAC			
Voltage Range	55V (load dependent) - 150VAC			
Frequency Limits	50 or 60 Hz, +/-6Hz, autosensing			
Power Factor Correction	≥99% at Full Load			
Low Voltage Transfer Point	55V (load dependent) resets to Utility Power at 75V or higher			
High Voltage Transfer Point	150V resets to Utility Power at 145V or lower			
Input Protection	Resettable Circuit Breaker			
OUTPUT NON-BATTERY OPERATION				
Voltage Regulation	Nominal +/-2%			
Frequency Range	60Hz: 54 - 66Hz or 50Hz: 44 - 56Hz			
Efficiency (Line Mode)	>90% (Full Load)			
OUTPUT BATTERY OPERATION				
Waveform Type	True Sine Wave			
Nominal Voltage (Adjustable)	120VAC (110, 127VAC)			
Voltage Regulation	Nominal +/-2% (until Low Battery Warning)			
Frequency	50/60Hz, +/-0.2Hz (unless synchronized to utility)			
Voltage T.H.D.	≤3% (Full Linear Load)			
Dynamic Response	+/-5% @ 100% Load change in 30 ms			
Transfer Time	0 ms Typical			
Slew Rate	≤1Hz / second			
Crest Factor	3 : 1			
Overload Capacity	≥106 to ≤110% for 2-mins; AC mode: Transfer to Bypass, DC Mode: Shutdown ≥111 to ≤125% for 1-min; AC mode: Transfer to Bypass, DC Mode: Shutdown ≥126 to ≤150% for 30-secs; AC mode: Transfer to Bypass, DC Mode: Shutdown ≥151% Immediately; AC mode: Transfer to Bypass, DC Mode: Shutdown			
Protection	Over-Current, Short-Circuit Protected and Latching Shutdown			
ECONOMY MODE OPERATION				
Switches from Bypass to Inverter	+/-10% Of the rated input voltage			
Switches from Inverter to Bypass	Resets 5VAC from Switch Point			
Transfer Time	8 ms Typical			

BATTERY SYSTEM				
Battery Type	Sealed, Non-Spillable, Maintenance Free, Value Regulated Lead Acid			
Typical Recharge Time	8-hours to 90% after full load discharge			
Typical Battery Life	3-5 years, depending on discharge cycles and ambient temp			
Battery Module	BM0069	BM0070		BM0071
Runtime: Half Load (minutes)	10	15	10	10
Runtime: Full Load (minutes)	2	5	3	3
SURGE PROTECTION AND FILTERING				
Surge Energy Rating	140 Joules	254 Joules		
Surge Current Capability	6500 Amps total			
Surge Response Time	0 ns (instantaneous) normal mode; <5 ns common mode			
Surge voltage let-through (as a percentage of an applied +/-2 kV)	<5%			
10/100/1000 Base-T surge protection let-through (as a percentage of an applied +/-2 kV 1.2/50 us, 500 a 8/20 uS test)	<5%			
Telephone line surge protection let-through (as a percentage of an applied +/-2 kV 1.2/50 us, 500a 8/20 uS test)	<1%			
Noise Filter	normal and common mode EMI/RFI suppression			
Audible Noise at 1 m (3 ft.)	<55 dBA			
ENVIRONMENTAL				
Operating Temperature (max)	0 to 40°C (+32 to +104°F)			
Storage Temperature	-10 to +50°C (+14 to +122°F)			
Operating/Storage Humidity	10% to 90% Non-Condensing			
Operating Elevation	0 to 3,000m (0 to +10,000 ft)			
Storage Elevation	0 to 15,000m (0 to +50,000 ft)			
PHYSICAL				
Size - Net L X W X H (rackmount brackets installed)	16.0 x 18.9 x 3.5" 407x479x88mm	19.2 x 18.9 x 3.5" 487 x 479 x 88mm	23.7 x 18.9 x 3.5" 602x479x88mm	
Weight - Net	24.3 lbs 11.0 Kgs	44.1 lbs 20.0 Kgs	44.1 lbs 20.0 Kgs	59.5 lbs 27.0 Kgs
Size - Shipping L X W X H	22.4 x 21.4 x 9.0" 570x544x228mm	25.6 x 21.4 x 9.0" 650 x 544 x 228mm	30.9 x 23.2 x 9.0" 785x590x228mm	
Weight - Shipping	29.5 lbs 13.4 Kgs	49.6 lbs 22.5 Kgs	49.6 lbs 22.5 Kgs	65.7 lbs 29.8 Kgs
REGULATORY COMPLIANCE				
Safety and Approvals	cTUVus (Conforms to UL1778 5th Edition & CSA 22.2 no. 107.3-14 / R: 2014), FCC Class A, CE certified, Energy Star certified, RoHS2 (EU Directive 2011/65/EU)			

## Chapter 10: Limited Product Warranty

Para Systems, Inc. (Para Systems) warrants this equipment, when properly applied and operated within specified conditions, against faulty materials or workmanship for a period of three years from the date of purchase. For equipment sites within the United States and Canada, this warranty covers depot repair or replacement of defective equipment at the discretion of Para Systems. Depot repair will be from the nearest authorized service center. The customer pays for shipping the product to Para Systems. Para Systems pays ground freight to ship the product back to the customer. Replacement parts and warranty labor will be borne by Para Systems. For equipment located outside of the United States and Canada, Para Systems only covers faulty parts. Para Systems products that are depot repaired or replaced pursuant to this warranty shall only be warranted for the unexpired portion of the warranty applying to the original product. This warranty applies only to the original purchaser who must have properly registered the product within 10 days of purchase.

The warranty shall be void if (a) the equipment is damaged by the customer, is improperly used, is subjected to an adverse operating environment, or is operated outside the limits of its electrical specifications; (b) the equipment is repaired or modified by anyone other than Para Systems or Para Systems approved personnel; or (c) has been used in a manner contrary to the product's User's Manual or other written instructions.

Any technical advice furnished before or after delivery in regard to use or application of Para Systems' equipment is furnished without charge and on the basis that it represents Para Systems' best judgment under the circumstances, but it is used at the recipient's sole risk.

EXCEPT AS PROVIDED HEREIN, PARA SYSTEMS MAKES NO WARRANTIES, EXPRESSED OR IMPLIED, INCLUDING WARRANTIES OF MERCHANTABILITY AND FITNESS FOR A PARTICULAR PURPOSE. Some states do not permit limitation of implied warranties; therefore, the aforesaid limitation(s) may not apply to the purchaser.

EXCEPT AS PROVIDED ABOVE, IN NO EVENT WILL PARA SYSTEMS BE LIABLE FOR DIRECT, INDIRECT, SPECIAL, INCIDENTAL, OR CONSEQUENTIAL DAMAGES ARISING OUT OF THE USE OF THIS PRODUCT, EVEN IF ADVISED OF THE POSSIBILITY OF SUCH DAMAGE. Specifically, Para Systems is not liable for any costs, such as; labor for on-site installation, on-site maintenance or on-site service, lost profits or revenue, loss of equipment, loss of use of equipment, loss of software, loss of data, cost of substitutes, claims by third parties, or otherwise. The sole and exclusive remedy for breach of any warranty, expressed or implied, concerning Para Systems' products and the only obligation of Para Systems hereunder, shall be depot repair or replacement of defective equipment, components, or parts; or, at Para Systems' option, refund of the purchase price or substitution with an equivalent replacement product. This warranty gives you specific legal rights and you may also have other rights which vary from state to state.

No employee, salesman, or agent of Para Systems is authorized to add to or vary the terms of this warranty.

**A1. DECLARATION OF CONFORMITY**

**Notes:**

Application of Council Directive(s): 2014/30/EU

Standard(s) to which Conformity is declared: EN62040-2, IEC61000-2-2, IEC61000-4-2, IEC61000-4-3, IEC61000-4-4, IEC61000-4-5, IEC61000-4-6, IEC61000-4-8, UL1778, CSA 22.2 no. 107.3-14, FCC Class A

Manufacturer's Name: Para Systems, Inc. (MINUTEMAN UPS)

Manufacturer's Address: 1455 LeMay Drive  
Carrollton, Texas 75007 USA

Type of Equipment: Uninterruptible Power Supplies (UPS)

Model No: EC1000RT2U (Y), EC1500RT2U (Y), EC2000RT2U (Y), EC3000RT2U (Y)

Year of Manufacture: Beginning July 2017

I hereby declare that the equipment specified above conforms to the above Directive(s).

Robert Calhoun  
(Name)

Manager Engineering  
(Position)

Place: Carrollton, Texas, USA

Date: July 10, 2017