

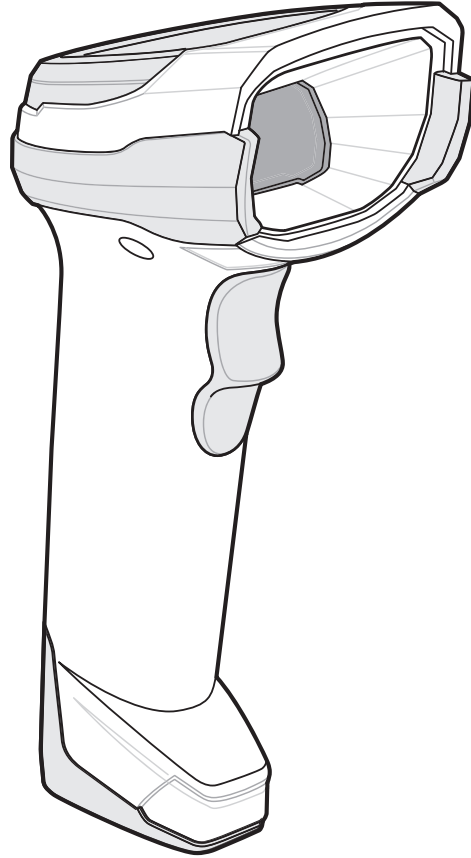

# DS8178



## Digital Scanner

---

## Product Reference Guide





# **DS8178 DIGITAL SCANNER PRODUCT REFERENCE GUIDE**

MN-002752-01

Revision A

January 2017

No part of this publication may be reproduced or used in any form, or by any electrical or mechanical means, without permission in writing from Zebra. This includes electronic or mechanical means, such as photocopying, recording, or information storage and retrieval systems. The material in this manual is subject to change without notice.

The software is provided strictly on an “as is” basis. All software, including firmware, furnished to the user is on a licensed basis. Zebra grants to the user a non-transferable and non-exclusive license to use each software or firmware program delivered hereunder (licensed program). Except as noted below, such license may not be assigned, sub-licensed, or otherwise transferred by the user without prior written consent of Zebra. No right to copy a licensed program in whole or in part is granted, except as permitted under copyright law. The user shall not modify, merge, or incorporate any form or portion of a licensed program with other program material, create a derivative work from a licensed program, or use a licensed program in a network without written permission from Zebra. The user agrees to maintain Zebra’s copyright notice on the licensed programs delivered hereunder, and to include the same on any authorized copies it makes, in whole or in part. The user agrees not to decompile, disassemble, decode, or reverse engineer any licensed program delivered to the user or any portion thereof.

Zebra reserves the right to make changes to any software or product to improve reliability, function, or design.

Zebra does not assume any product liability arising out of, or in connection with, the application or use of any product, circuit, or application described herein.

No license is granted, either expressly or by implication, estoppel, or otherwise under any Zebra Technologies Corporation, intellectual property rights. An implied license only exists for equipment, circuits, and subsystems contained in Zebra products.

---

## Warranty

For the complete Zebra hardware product warranty statement, go to:  
<http://www.zebra.com/warranty>.

---

## Revision History

Changes to the original guide are listed below:

Change	Date	Description
Rev. A	01/2017	Initial Release

# TABLE OF CONTENTS

Warranty .....	ii
Revision History .....	ii

## About This Guide

Introduction .....	xix
Configurations .....	xix
Digital Scanner .....	xix
Cradles .....	xx
Related Product Line Configurations .....	xx
Cables .....	xx
Chapter Descriptions .....	xxi
Notational Conventions .....	xxii
Related Documents .....	xxiii
Service Information .....	xxiii

## Chapter 1: Getting Started

Introduction .....	1-1
Interfaces .....	1-1
Unpacking .....	1-1
DS8178 Features .....	1-2
Cradle Features .....	1-2
Standard Cradle .....	1-3
Presentation Cradle .....	1-4
Connecting the Cradle .....	1-4
Changing the Host Interface .....	1-4
Using a DC Power Supply .....	1-5
Mounting the Cradle .....	1-5
Using the Document Capture Stand .....	1-6
Charging the DS8178 Battery .....	1-7
Recovering a Discharged Battery .....	1-7
Shutting Off the Digital Scanner Battery .....	1-8
Inserting the Battery .....	1-9
Removing the Battery .....	1-11
Inserting the Scanner in the Cradles .....	1-12

Sending Data to the Host Computer .....	1-13
Pairing .....	1-13
Lost Connection to Host .....	1-13
Configuring the Scanner .....	1-13
Radio Communications .....	1-13
Accessories .....	1-14

## Chapter 2: Data Capture

Introduction .....	2-1
Beeper and LED Indications .....	2-1
Digital Scanner Indications .....	2-1
Cradle LED Indications .....	2-4
Scanning .....	2-5
Hand-Held Scanning .....	2-5
Hands-Free Scanning .....	2-6
Aiming with Digital Scanner .....	2-7
Decode Ranges .....	2-9

## Chapter 3: Maintenance and Technical Specifications

Introduction .....	3-1
Maintenance .....	3-1
Known Harmful Ingredients .....	3-1
Approved Cleaners for Standard DS8178 Digital Scanners and CR8178 Cradles .....	3-2
Approved Disinfectant Cleaners for Healthcare Configurations of the DS8178 Digital Scanners and CR8178 Cradles .....	3-2
Cleaning the Digital Scanner .....	3-3
Troubleshooting .....	3-4
Report Software Version Bar Code .....	3-7
Technical Specifications .....	3-8
Cradle Signal Descriptions .....	3-12

## Chapter 4: Radio Communications

Introduction .....	4-1
Setting Parameters .....	4-1
Scanning Sequence Examples .....	4-2
Errors While Scanning .....	4-2
Radio Communications Parameter Defaults .....	4-2
Wireless Beeper Definitions .....	4-4
Radio Communication Host Types .....	4-4
Bluetooth Classic vs. Low Energy Bluetooth .....	4-4
Cradle .....	4-4
Human Interface Device (HID) Keyboard Emulation .....	4-5
Simple Serial Interface (SSI) .....	4-6
Serial Port Profile (SPP) .....	4-8
Bluetooth Technology Profile Support .....	4-9
Master/Slave Set Up .....	4-9
Master .....	4-9

Slave .....	4-9
Bluetooth Friendly Name .....	4-9
Discoverable Mode .....	4-10
Wi-Fi Friendly Mode .....	4-11
Notes .....	4-11
Wi-Fi Friendly Channel Exclusion .....	4-11
Wi-Fi Channel Exclusion .....	4-11
Radio Output Power .....	4-13
Link Supervision Timeout .....	4-14
Bluetooth Radio State .....	4-15
HID Host Parameters .....	4-15
Bluetooth HID - Wait for Connection .....	4-15
HID Features for Apple iOS .....	4-16
HID Keyboard Keystroke Delay .....	4-17
HID CAPS Lock Override .....	4-17
HID Ignore Unknown Characters .....	4-18
Emulate Keypad .....	4-18
Fast HID Keyboard .....	4-19
Quick Keypad Emulation .....	4-19
HID Keyboard FN1 Substitution .....	4-20
HID Function Key Mapping .....	4-20
Simulated Caps Lock .....	4-21
Convert Case .....	4-21
Auto-Reconnect Feature .....	4-22
Reconnect Attempt Beep Feedback .....	4-22
Reconnect Attempt Interval .....	4-23
Auto-Reconnect .....	4-24
Out of Range Indicator .....	4-24
Beep on Insertion .....	4-25
Beep on <BEL> .....	4-25
Digital Scanner(s) To Cradle Support .....	4-26
Modes of Operation .....	4-26
Point-to-Point Communication .....	4-26
Multipoint-to-Point Communication .....	4-26
Parameter Broadcast (Cradle Host Only) .....	4-27
Pairing .....	4-27
Pairing Modes .....	4-27
Lock Override .....	4-28
Pairing Methods .....	4-29
Unpairing .....	4-29
Toggle Pairing .....	4-30
Pairing Bar Code Format .....	4-30
Pairing Bar Code Example .....	4-30
Connection Maintenance Interval .....	4-31
Considerations .....	4-31
Batch Mode .....	4-33
Modes of Operation .....	4-33
Persistent Batch Storage .....	4-35
Page Button .....	4-36
Page Options .....	4-37

Page Mode .....	4-37
Page State Timeout .....	4-37
Bluetooth Classic and/or Low Energy (Cradle Host Only) .....	4-38
Bluetooth Security .....	4-38
PIN Code .....	4-38
Variable PIN Code .....	4-39
Bluetooth Security Levels .....	4-40
Bluetooth Radio, Linking, and Batch Operation .....	4-41
Setting Up an iOS or Android Product To Work With The Digital Scanner .....	4-41

## Chapter 5: User Preferences

Introduction .....	5-1
Scanning Sequence Examples .....	5-2
Errors While Scanning .....	5-2
User Preferences Parameter Defaults .....	5-2
Parameters .....	5-5
Default Parameters .....	5-5
Parameter Bar Code Scanning .....	5-6
Beep After Good Decode .....	5-6
Direct Decode Indicator .....	5-7
Beeper Volume .....	5-8
Beeper Tone .....	5-9
Beeper Duration .....	5-10
Suppress Power Up Beeps .....	5-10
Decode Pager Motor (DS8178-HC Only) .....	5-11
Decode Pager Motor Duration (DS8178-HC Only) .....	5-11
Night Mode Trigger (DS8178-HC Only) .....	5-13
Night Mode Toggle .....	5-13
Lamp Mode .....	5-13
Lamp Mode Control .....	5-14
Lamp Mode Timeout .....	5-15
Low Power Mode .....	5-16
Time Delay to Low Power Mode .....	5-17
Timeout to Low Power Mode from Auto Aim .....	5-19
Hand-Held Trigger Mode .....	5-20
Hands-Free Mode .....	5-21
Hand-Held Decode Aiming Pattern .....	5-22
Hands-Free Decode Aiming Pattern .....	5-23
Picklist Mode .....	5-24
FIPS Mode .....	5-25
Continuous Bar Code Read .....	5-25
Unique Bar Code Reporting .....	5-26
Decode Session Timeout .....	5-26
Hands-free Decode Session Timeout .....	5-27
Timeout Between Decodes, Same Symbol .....	5-28
Timeout Between Decodes, Different Symbols .....	5-28
Triggered Timeout, Same Symbol .....	5-29
Decode Mirror Images (Data Matrix Only) .....	5-30
Mobile Phone/Display Mode .....	5-31



PDF Prioritization .....	5-32
PDF Prioritization Timeout .....	5-33
Presentation Mode Field of View .....	5-33
Decoding Illumination .....	5-34
Motion Tolerance (Hand-Held Trigger Modes Only) .....	5-34
Battery Threshold .....	5-35
Add an Enter Key .....	5-36
Transmit Code ID Character .....	5-36
Prefix/Suffix Values .....	5-38
Scan Data Transmission Format .....	5-39
FN1 Substitution Values .....	5-40
Transmit “No Read” Message .....	5-41
Unsolicited Heartbeat Interval .....	5-42

## Chapter 6: Imaging Preferences

Introduction .....	6-1
Scanning Sequence Examples .....	6-2
Errors While Scanning .....	6-2
Imaging Preferences Parameter Defaults .....	6-2
Imaging Preferences .....	6-4
Operational Modes .....	6-4
Decode Mode .....	6-4
Snapshot Mode .....	6-4
Image Capture Illumination .....	6-5
Image Capture Autoexposure .....	6-5
Fixed Exposure .....	6-6
Fixed Gain .....	6-6
Gain/Exposure Priority for Snapshot Mode .....	6-7
Snapshot Mode Timeout .....	6-8
Snapshot Aiming Pattern .....	6-9
Silence Operational Mode Changes .....	6-9
Image Cropping .....	6-10
Crop to Pixel Addresses .....	6-11
Image Size (Number of Pixels) .....	6-12
Image Brightness (Target White) .....	6-13
JPEG Image Options .....	6-13
JPEG Target File Size .....	6-14
JPEG Quality and Size Value .....	6-14
Image Enhancement .....	6-15
Image File Format Selector .....	6-16
Image Rotation .....	6-17
Bits Per Pixel .....	6-18
Signature Capture .....	6-19
Output File Format .....	6-19
Signature Capture File Format Selector .....	6-20
Signature Capture Bits Per Pixel .....	6-21
Signature Capture Width .....	6-22
Signature Capture Height .....	6-22
Signature Capture JPEG Quality .....	6-22

**Chapter 7: USB Interface**

Introduction .....	7-1
Connecting a USB Interface .....	7-1
USB Parameter Defaults .....	7-3
USB Host Parameter .....	7-4
USB Device Type .....	7-4
Symbol Native API (SNAPI) Status Handshaking .....	7-6
USB Keystroke Delay .....	7-6
USB CAPS Lock Override .....	7-7
USB Ignore Unknown Characters .....	7-7
USB Convert Unknown to Code 39 .....	7-8
Emulate Keypad .....	7-8
Emulate Keypad with Leading Zero .....	7-8
Quick Keypad Emulation .....	7-9
USB Keyboard FN 1 Substitution .....	7-9
Function Key Mapping .....	7-10
Simulated Caps Lock .....	7-10
Convert Case .....	7-11
USB Static CDC .....	7-11
Optional USB Parameters .....	7-12
Ignore Beep .....	7-12
Ignore Bar Code Configuration .....	7-12
USB Polling Interval .....	7-13
USB Fast HID .....	7-15
IBM Specification Version .....	7-15
ASCII Character Sets for USB .....	7-16

**Chapter 8: SSI Interface**

Introduction .....	8-1
Communications .....	8-1
SSI Transactions .....	8-3
General Data Transactions .....	8-3
ACK/NAK Handshaking .....	8-3
Transfer of Decode Data .....	8-4
ACK/NAK Enabled and Packeted Data .....	8-4
ACK/NAK Enabled and Unpacketed ASCII Data .....	8-4
ACK/NAK Disabled and Packeted DECODE_DATA .....	8-5
ACK/NAK Disabled and Unpacketed ASCII Data .....	8-5
Communication Summary .....	8-5
RTS/CTS Lines .....	8-5
ACK/NAK Option .....	8-5
Number of Data Bits .....	8-5
Serial Response Time-out .....	8-6
Retries .....	8-6
Baud Rate, Stop Bits, Parity, Response Time-out, ACK/NAK Handshake .....	8-6
Errors .....	8-6
Things to Remember When Using SSI Communication .....	8-6
Using Time Delay to Low Power Mode with SSI .....	8-7
Encapsulation of RSM Commands/Responses over SSI .....	8-8

Command Structure .....	8-8
Response Structure .....	8-8
Example Transaction .....	8-9
Command from Host to Query Packet Size Supported by Device .....	8-9
Response from Device with Packet Size Information .....	8-9
Command from Host to Retrieve Diagnostic Information .....	8-9
Response from Device with Diagnostic Information .....	8-9
Simple Serial Interface Default Parameters .....	8-10
SSI Host Parameters .....	8-11
Select SSI Host .....	8-11
Baud Rate .....	8-12
Parity .....	8-13
Check Parity .....	8-14
Stop Bits .....	8-14
Software Handshaking .....	8-15
Host RTS Line State .....	8-16
Decode Data Packet Format .....	8-16
Host Serial Response Time-out .....	8-17
Host Character Time-out .....	8-18
Multipacket Option .....	8-19
Interpacket Delay .....	8-20
Event Reporting .....	8-21
Decode Event .....	8-21
Boot Up Event .....	8-22
Parameter Event .....	8-22

## Chapter 9: RS-232 Interface

Introduction .....	9-1
Connecting an RS-232 Interface .....	9-2
RS-232 Parameter Defaults .....	9-3
RS-232 Host Parameters .....	9-4
RS-232 Host Types .....	9-6
Baud Rate .....	9-8
Parity .....	9-9
Stop Bit Select .....	9-10
Data Bits .....	9-10
Check Receive Errors .....	9-11
Hardware Handshaking .....	9-11
Software Handshaking .....	9-13
Host Serial Response Time-out .....	9-15
RTS Line State .....	9-16
Beep on <BEL> .....	9-16
Intercharacter Delay .....	9-17
Nixdorf Beep/LED Options .....	9-18
Ignore Unknown Characters .....	9-18
ASCII Character Set for RS-232 .....	9-18

**Chapter 10: IBM 468X / 469X Interface**

Introduction .....	10-1
Connecting to an IBM 468X/469X Host .....	10-2
IBM Parameter Defaults .....	10-3
IBM 468X/469X Host Parameters .....	10-4
Port Address .....	10-4
Convert Unknown to Code 39 .....	10-5
RS-485 Beep Directive .....	10-5
RS-485 Bar Code Configuration Directive .....	10-6
IBM-485 Specification Version .....	10-6

**Chapter 11: Keyboard Wedge Interface**

Introduction .....	11-1
Connecting a Keyboard Wedge Interface .....	11-2
Keyboard Wedge Parameter Defaults .....	11-3
Keyboard Wedge Host Parameters .....	11-4
Keyboard Wedge Host Types .....	11-4
Ignore Unknown Characters .....	11-4
Keystroke Delay .....	11-5
Intra-Keystroke Delay .....	11-5
Alternate Numeric Keypad Emulation .....	11-6
Quick Keypad Emulation .....	11-6
Simulated Caps Lock .....	11-7
Caps Lock Override .....	11-7
Convert Wedge Case .....	11-8
Function Key Mapping .....	11-8
FN1 Substitution .....	11-9
Send Make and Break .....	11-9
Keyboard Maps .....	11-10
ASCII Character Set for Keyboard Wedge .....	11-10

**Chapter 12: Symbologies**

Introduction .....	12-1
Scanning Sequence Examples .....	12-1
Errors While Scanning .....	12-2
Symbology Parameter Defaults .....	12-2
Enable/Disable All Code Types .....	12-7
UPC/EAN .....	12-8
Enable/Disable UPC-A .....	12-8
Enable/Disable UPC-E .....	12-8
Enable/Disable UPC-E1 .....	12-9
Enable/Disable EAN-8/JAN-8 .....	12-9
Enable/Disable EAN-13/JAN-13 .....	12-10
Enable/Disable Bookland EAN .....	12-10
Decode UPC/EAN/JAN Supplementals .....	12-11
User-Programmable Supplementals .....	12-14
UPC/EAN/JAN Supplemental Redundancy .....	12-14
UPC/EAN/JAN Supplemental AIM ID Format .....	12-15
UPC Reduced Quiet Zone .....	12-16

Transmit UPC-A Check Digit .....	12-16
Transmit UPC-E Check Digit .....	12-17
Transmit UPC-E1 Check Digit .....	12-17
UPC-A Preamble .....	12-18
UPC-E Preamble .....	12-19
UPC-E1 Preamble .....	12-20
Convert UPC-E to UPC-A .....	12-21
Convert UPC-E1 to UPC-A .....	12-21
EAN-8/JAN-8 Extend .....	12-22
Bookland ISBN Format .....	12-22
UCC Coupon Extended Code .....	12-23
Coupon Report .....	12-23
ISSN EAN .....	12-24
Code 128 .....	12-24
Enable/Disable Code 128 .....	12-24
Set Lengths for Code 128 .....	12-25
Enable/Disable GS1-128 (formerly UCC/EAN-128) .....	12-27
Enable/Disable ISBT 128 .....	12-27
ISBT Concatenation .....	12-28
Check ISBT Table .....	12-29
ISBT Concatenation Redundancy .....	12-29
Code 128 Security Level .....	12-30
Code 128 Reduced Quiet Zone .....	12-31
Ignore Code 128 <FNC4> .....	12-31
Code 39 .....	12-32
Enable/Disable Code 39 .....	12-32
Enable/Disable Trioptic Code 39 .....	12-32
Convert Code 39 to Code 32 .....	12-33
Code 32 Prefix .....	12-33
Set Lengths for Code 39 .....	12-34
Code 39 Check Digit Verification .....	12-35
Transmit Code 39 Check Digit .....	12-35
Code 39 Full ASCII Conversion .....	12-36
Code 39 Security Level .....	12-37
Code 39 Reduced Quiet Zone .....	12-38
Code 93 .....	12-38
Enable/Disable Code 93 .....	12-38
Set Lengths for Code 93 .....	12-39
Code 11 .....	12-40
Code 11 .....	12-40
Set Lengths for Code 11 .....	12-40
Code 11 Check Digit Verification .....	12-42
Interleaved 2 of 5 (ITF) .....	12-43
Enable/Disable Interleaved 2 of 5 .....	12-43
Set Lengths for Interleaved 2 of 5 .....	12-43
I 2 of 5 Check Digit Verification .....	12-45
Convert I 2 of 5 to EAN-13 .....	12-46
I 2 of 5 Security Level .....	12-46
I 2 of 5 Reduced Quiet Zone .....	12-47
Discrete 2 of 5 (DTF) .....	12-48

Enable/Disable Discrete 2 of 5 .....	12-48
Set Lengths for Discrete 2 of 5 .....	12-48
Codabar (NW - 7) .....	12-50
Enable/Disable Codabar .....	12-50
Set Lengths for Codabar .....	12-50
CLSI Editing .....	12-52
NOTIS Editing .....	12-52
Codabar Upper or Lower Case Start/Stop Characters Detection .....	12-53
MSI .....	12-53
Enable/Disable MSI .....	12-53
Set Lengths for MSI .....	12-54
MSI Check Digits .....	12-55
Transmit MSI Check Digit(s) .....	12-55
MSI Check Digit Algorithm .....	12-56
MSI Reduced Quiet Zone .....	12-56
Chinese 2 of 5 .....	12-57
Enable/Disable Chinese 2 of 5 .....	12-57
Matrix 2 of 5 .....	12-57
Enable/Disable Matrix 2 of 5 .....	12-57
Set Lengths for Matrix 2 of 5 .....	12-58
Matrix 2 of 5 Check Digit .....	12-59
Transmit Matrix 2 of 5 Check Digit .....	12-59
Korean 3 of 5 .....	12-60
Enable/Disable Korean 3 of 5 .....	12-60
Inverse 1D .....	12-61
GS1 DataBar .....	12-62
GS1 DataBar-14 .....	12-62
GS1 DataBar Limited .....	12-62
GS1 DataBar Expanded .....	12-63
Convert GS1 DataBar to UPC/EAN .....	12-63
GS1 DataBar Limited Margin Check .....	12-64
GS1 DataBar Security Level .....	12-65
Composite .....	12-66
Composite CC-C .....	12-66
Composite CC-A/B .....	12-66
Composite TLC-39 .....	12-67
Composite Inverse .....	12-67
UPC Composite Mode .....	12-68
Composite Beep Mode .....	12-68
GS1-128 Emulation Mode for UCC/EAN Composite Codes .....	12-69
2D Symbolologies .....	12-69
Enable/Disable PDF417 .....	12-69
Enable/Disable MicroPDF417 .....	12-70
Code 128 Emulation .....	12-70
Data Matrix .....	12-71
GS1 Data Matrix .....	12-71
Data Matrix Inverse .....	12-72
Maxicode .....	12-72
QR Code .....	12-73
GS1 QR .....	12-73

MicroQR .....	12-74
Aztec .....	12-74
Aztec Inverse .....	12-75
Han Xin .....	12-75
Han Xin Inverse .....	12-76
Postal Codes .....	12-76
US Postnet .....	12-76
US Planet .....	12-77
Transmit US Postal Check Digit .....	12-77
UK Postal .....	12-78
Transmit UK Postal Check Digit .....	12-78
Japan Postal .....	12-79
Australia Post .....	12-79
Australia Post Format .....	12-80
Netherlands KIX Code .....	12-81
USPS 4CB/One Code/Intelligent Mail .....	12-81
UPU FICS Postal .....	12-82
Mailmark .....	12-82
Symbology-Specific Security Levels .....	12-83
Redundancy Level .....	12-83
Redundancy Level 1 .....	12-83
Redundancy Level 2 .....	12-83
Redundancy Level 3 .....	12-83
Redundancy Level 4 .....	12-84
Security Level .....	12-85
1D Quiet Zone Level .....	12-86
Intercharacter Gap Size .....	12-87
Report Version .....	12-87
Macro PDF Features .....	12-88
Flush Macro Buffer .....	12-88
Abort Macro PDF Entry .....	12-88

### Chapter 13: Intelligent Document Capture

Introduction .....	13-1
The IDC Process .....	13-1
Bar Code Acceptance Test .....	13-2
Capture Region Determination .....	13-2
IDC Operating Mode = Anchored .....	13-2
IDC Operating Mode = Free-Form or Linked .....	13-3
Image Post Processing .....	13-3
Data Transmission .....	13-3
PC Application and Programming Support .....	13-3
Parameters .....	13-4
IDC Operating Mode .....	13-5
IDC Symbology .....	13-6
IDC X Coordinate .....	13-7
IDC Y Coordinate .....	13-7
IDC Width .....	13-8
IDC Height .....	13-8

IDC Aspect .....	13-9
IDC File Format Selector .....	13-9
IDC Bits Per Pixel .....	13-10
IDC JPEG Quality .....	13-10
IDC Find Box Outline .....	13-11
IDC Minimum Text Length .....	13-11
IDC Maximum Text Length .....	13-12
IDC Captured Image Brighten .....	13-12
IDC Captured Image Sharpen .....	13-13
IDC Border Type .....	13-14
IDC Delay Time .....	13-15
IDC Zoom Limit .....	13-15
IDC Maximum Rotation .....	13-16
Quick Start .....	13-16
Sample IDC Setup .....	13-16
IDC Demonstrations .....	13-17
Anchored Mode Demo .....	13-17
Free-Form Mode Demo .....	13-18
Linked Mode Demo .....	13-18
Other Suggestions .....	13-18
Quick Start Form .....	13-19

## Chapter 14: OCR Programming

Introduction .....	14-1
Setting Parameters .....	14-1
Scanning Sequence Examples .....	14-2
Errors While Scanning .....	14-2
OCR Parameter Defaults .....	14-3
OCR Programming Parameters .....	14-4
OCR-A .....	14-4
OCR-A Variant .....	14-4
OCR-B .....	14-6
OCR-B Variant .....	14-7
MICR E13B .....	14-10
US Currency Serial Number .....	14-11
OCR Orientation .....	14-11
OCR Lines .....	14-13
OCR Minimum Characters .....	14-13
OCR Maximum Characters .....	14-14
OCR Subset .....	14-14
OCR Quiet Zone .....	14-15
OCR Bright Illumination .....	14-15
OCR Template .....	14-16
Required Digit (9) .....	14-16
Required Alpha (A) .....	14-16
Require and Suppress (0) .....	14-17
Optional Alphanumeric (1) .....	14-17
Optional Alpha (2) .....	14-17
Alpha or Digit (3) .....	14-17



Any Including Space & Reject (4)	14-18
Any except Space & Reject (5)	14-18
Optional Digit (7)	14-18
Digit or Fill (8)	14-19
Alpha or Fill (F)	14-19
Optional Space ( )	14-19
Optional Small Special (.)	14-20
Other Template Operators	14-20
Repeat Previous (R)	14-23
Multiple Templates	14-25
Template Examples	14-25
OCR Check Digit Modulus	14-25
OCR Check Digit Multiplier	14-26
OCR Check Digit Validation	14-27
None	14-27
Product Add Left to Right	14-27
Digit Add Left to Right	14-28
Digit Add Right to Left	14-29
Product Add Right to Left Simple Remainder	14-29
Digit Add Right To Left Simple Remainder	14-30
Health Industry - HIBCC43	14-31
Inverse OCR	14-32
<b>Chapter 15: Driver's License Set Up (DS8178-DL)</b>	
Introduction	15-1
Driver's License Parsing	15-2
Parsing Driver's License Data Fields	
(Embedded Driver's License Parsing)	15-3
Embedded Driver's License Parsing Criteria - Code Type	15-3
Driver's License Parse Field Bar Codes	15-4
AAMVA Parse Field Bar Codes	15-7
User Preferences	15-17
Set Default Parameter	15-17
Output Gender as M or F	15-17
Date Format	15-18
No Separator	15-19
Send Keystroke (Control Characters and Keyboard Characters)	15-20
Control Characters	15-20
Keyboard Characters	15-26
Parsing Rule Example	15-41
Embedded Driver's License Parsing ADF Example	15-45
<b>Chapter 16: 123Scan and Software Tools</b>	
Introduction	16-1
123Scan	16-1
Communication with 123Scan	16-2
123Scan Requirements	16-2
123Scan Information	16-3
Scanner SDK, Other Software Tools, and Videos	16-3

Scanner Control App .....	16-4
Advanced Data Formatting (ADF) .....	16-4
Multicode Data Formatting (MDF) .....	16-5
Programming Options .....	16-5
MDF Terms and Definitions .....	16-5
Preferred Symbol .....	16-6
Programming Options .....	16-6

**Appendix A: Standard Parameter Defaults**

**Appendix B: Country Codes**

Introduction .....	B-1
USB, BT HID, and Keyboard Wedge Country Keyboard Types (Country Codes) .....	B-2

**Appendix C: Country Code Pages**

Introduction .....	C-1
Country Code Page Defaults .....	C-1
Country Code Page Bar Codes .....	C-5

**Appendix D: CKJ Decode Control**

Introduction .....	D-1
CJK Control Parameters .....	D-2
Unicode Output Control .....	D-2
CJK Output Method to Windows Host .....	D-3
Non-CJK UTF Bar Code Output .....	D-5
Country Keyboard Type Missing Characters .....	D-5
Unicode/CJK Decode Setup with Windows Host .....	D-7
Setting Up the Windows Registry Table for Unicode Universal Output .....	D-7
Adding CJK IME on Windows .....	D-7
Selecting the Simplified Chinese Input Method on the Host .....	D-8
Selecting the Traditional Chinese Input Method on the Host .....	D-8

**Appendix E: Programming Reference**

Symbol Code Identifiers .....	E-1
AIM Code Identifiers .....	E-3

**Appendix F: Sample Bar Codes**

Code 39 .....	F-1
Code 93 .....	F-1
UPC/EAN .....	F-2
UPC-A, 100% .....	F-2
UPC-E .....	F-2
EAN-8 .....	F-2
EAN-13, 100% .....	F-3

Code 128 .....	F-3
Interleaved 2 of 5 .....	F-3
GS1 DataBar .....	F-4
GS1 DataBar-14 .....	F-4
GS1 DataBar Omnidirectional .....	F-4
GS1 DataBar Expanded .....	F-4
GS1 DataBar Limited .....	F-5
PDF417 .....	F-5
Data Matrix .....	F-5
Maxicode .....	F-6
QR Code .....	F-6
US Postnet .....	F-6
UK Postal .....	F-7
Interleaved 2 of 5 .....	F-7
PDF417 .....	F-7
Aztec .....	F-8

## Appendix G: Numeric Bar Codes

Numeric Bar Codes .....	G-1
-------------------------	-----

## Appendix H: Alphanumeric Bar Codes

Cancel .....	H-1
Alphanumeric Bar Codes .....	H-1

## Appendix I: ASCII Character Sets

## Appendix J: Communication Protocol Functionality

Functionality Supported via Communication (Cable) Interface .....	J-1
Functionality Supported via Radio Communication .....	J-2

## Appendix K: Signature Capture Code

Introduction .....	K-1
Code Structure .....	K-1
Signature Capture Area .....	K-1
CapCode Pattern Structure .....	K-2
Start / Stop Patterns .....	K-2
Dimensions .....	K-3
Data Format .....	K-3
Additional Capabilities .....	K-4
Signature Boxes .....	K-4

**Appendix L: Non-Parameter Attributes**

Introduction ..... L-1

Attributes ..... L-1

    Model Number ..... L-1

    Serial Number ..... L-1

    Date of Manufacture ..... L-2

    Date of First Programming ..... L-2

    Configuration Filename ..... L-2

    Beeper/LED ..... L-3

    Parameter Defaults ..... L-4

    Beep on Next Bootup ..... L-4

    Reboot ..... L-4

    Host Trigger Session ..... L-4

    Firmware Version ..... L-5

    Scankit Version ..... L-5

**Index**

# ABOUT THIS GUIDE

---

## Introduction

The *DS8178 Digital Scanner Product Reference Guide* provides general instructions for setting up, operating, maintaining, and troubleshooting the DS8178 digital scanner.

---

## Configurations

### Digital Scanner

**Table A** *Scanner Configurations*

Configuration	Description
DS8178-SR0F007ZZWW	Area Imager, Standard Range, Cordless, FIPS, Twilight Black
DS8178-SR0F007ZZWK	Area Imager, Standard Range, Cordless, FIPS, Twilight Black, Korea and India
DS8178-SR0F006ZMWW	Area Imager, Standard Range, Cordless, FIPS, MFI, Nova White
DS8178-DL0F007ZZWW	Area Imager, Standard Range, DL Parsing, Cordless, FIPS, Twilight Black
DS8178-DL0F006ZMWW	Area Imager, Standard Range, DL Parsing, Cordless, FIPS, MFI, Nova White
DS8178-HCMF00BVMWW	Area Imager, Healthcare, Cordless, Magnetic Foot, FIPS, Vibration Motor, MFI, Healthcare White

## Cradles

**Table B** *Cradle Configurations*

Configuration	Description
CR8178-SC100F4WW	Standard Cradle, Bluetooth, FIPS, Midnight Black
CR8178-SC100FBWW	Standard Cradle, Bluetooth, FIPS, Healthcare White
CR8178-PC100F4WW	Presentation Cradle, Bluetooth, FIPS, Midnight Black
CR8178-PCM00FBWW	Presentation Cradle With Magnet, Bluetooth, FIPS, Healthcare White

## Related Product Line Configurations

The product configurations related to the DS8178 digital scanner are as follows.



**NOTES** Check Solution Builder for additional information regarding all available accessories, and the latest available configurations.

**Table C** *Accessories*

Part Number	Description
BTRY-DS81EAB0E-00	Replacement battery for the DS8178 digital scanner.
BTRY-DS81EAB0E-00K	Replacement battery for the DS8178 digital scanner, Korea, and India.
FAST-PC0081W-Q1	Set of four adhesive backed hook fastener strips used to adhere one CR8178-SC or CR8178-PC charging communication cradle to a surface.
FAST-PC0081W-25	25 sets of four adhesive backed hook fastener strips used to adhere 25 CR8178-SC or CR8178-PC charging communication cradles to surfaces.
STND-DC0081W-04	Document Capture Stand for use with the CR8178-PC.

**Note:** For compatible power supplies, contact your Zebra sales representative.

## Cables

For regional information about cables and cable compatibility, go to the Zebra Partner Portal at:

[https://partnerportal.zebra.com/PartnerPortal/product\\_services/downloads\\_z/barcode\\_scanners/Universal-Cable-Guide-Bar-Code-Scanners.xlsx](https://partnerportal.zebra.com/PartnerPortal/product_services/downloads_z/barcode_scanners/Universal-Cable-Guide-Bar-Code-Scanners.xlsx).

---

## Chapter Descriptions

Topics covered in this guide are as follows:

- [Chapter 1, Getting Started](#) provides a product overview, unpacking instructions, and cable connection information.
- [Chapter 2, Data Capture](#) provides beeper and LED definitions, techniques involved in scanning bar codes, general instructions and tips about scanning, and decode ranges.
- [Chapter 3, Maintenance and Technical Specifications](#) provides suggested scanner maintenance, troubleshooting, technical specifications, and signal descriptions (pinouts).
- [Chapter 4, Radio Communications](#) provides information about the modes of operation and features available for wireless communication. This chapter also includes programming bar codes to configure the digital scanner.
- [Chapter 5, User Preferences](#) describes each user preference feature and provides programming bar codes for selecting these features.
- [Chapter 6, Imaging Preferences](#) describes imaging preference features and provides programming bar codes for selecting these features.
- [Chapter 7, USB Interface](#) describes how to set up the digital scanner with a USB host.
- [Chapter 8, SSI Interface](#) describes the system requirements of the Simple Serial Interface (SSI), which provides a communications link between Zebra decoders and a serial host.
- [Chapter 9, RS-232 Interface](#) describes how to set up the digital scanner with an RS-232 host.
- [Chapter 10, IBM 468X / 469X Interface](#) describes how to set up the digital scanner with an IBM 468X/469X host.
- [Chapter 11, Keyboard Wedge Interface](#) describes how to set up a keyboard wedge interface with the digital scanner.
- [Chapter 12, Symbologies](#) describes all symbology features and provides programming bar codes for selecting these features for the digital scanner.
- [Chapter 13, Intelligent Document Capture](#) describes IDC, an advanced image processing firmware, including IDC functionality, parameter bar codes to control its features, and a quick start procedure.
- [Chapter 14, OCR Programming](#) describes how to set up the digital scanner for OCR programming.
- [Chapter 15, Driver's License Set Up \(DS8178-DL\)](#) provides information about parsing out information from standard US driver's licenses and certain other American Association of Motor Vehicle Administrators (AAMVA) compliant ID cards.
- [Chapter 16, 123Scan and Software Tools](#) provides information on the PC-based digital scanner configuration tool 123Scan.
- [Appendix A, Standard Parameter Defaults](#) provides a table of all host devices and miscellaneous scanner defaults.
- [Appendix B, Country Codes](#) provides bar codes for programming the country keyboard type for the USB keyboard (HID) device and the keyboard wedge host.
- [Appendix C, Country Code Pages](#) provides bar codes for selecting code pages for the country keyboard type.

- [Appendix D, CKJ Decode Control](#) describes control parameters for Unicode/CJK (Chinese, Japanese, Korean) bar code decode through USB HID Keyboard Emulation mode.
- [Appendix E, Programming Reference](#) provides a table of AIM code identifiers, ASCII character conversions, and keyboard maps.
- [Appendix F, Sample Bar Codes](#) includes sample bar codes of various code types.
- [Appendix G, Numeric Bar Codes](#) includes the numeric bar codes to scan for parameters requiring specific numeric values.
- [Appendix H, Alphanumeric Bar Codes](#) includes the alphanumeric bar codes to scan for parameters requiring specific alphanumeric values.
- [Appendix I, ASCII Character Sets](#) provides ASCII character value tables.
- [Appendix J, Communication Protocol Functionality](#) lists supported scanner functionality by communication protocol.
- [Appendix K, Signature Capture Code](#) describes CapCode, a special pattern that encloses a signature area on a document and allows the scanner to capture a signature.
- [Appendix L, Non-Parameter Attributes](#) defines non-parameter attributes.

---

## Notational Conventions

The following conventions are used in this document:

- *Italics* are used to highlight the following:
  - Chapters and sections in this and related documents
  - Dialog box, window and screen names
  - Drop-down list and list box names
  - Check box and radio button names
- **Bold** text is used to highlight the following:
  - Key names on a keypad
  - Button names on a screen.
- bullets (•) indicate:
  - Action items
  - Lists of alternatives
  - Lists of required steps that are not necessarily sequential
- Sequential lists (e.g., those that describe step-by-step procedures) appear as numbered lists.
- Throughout the programming bar code menus, asterisks (\*) are used to denote default parameter settings.



\* Indicates Default — \*Baud Rate 9600 — Feature/Option



---

## Related Documents

- *DS8178 Quick Start Guide*, p/n MN-002753-xx, provides general information for getting started with the DS8178 digital scanner/cradles, and includes basic set up and operation instructions.
- *Advanced Data Formatting Programmer Guide*, p/n 72E-69680-xx, provides information on ADF, a means of customizing data before transmission to a host.
- *Attribute Data Dictionary*, p/n 72E-149786-xx defines attribute numbers (device configuration parameters, monitored data, and born-on information) and describes management of various attribute domains for bar code scanners and OEM engines.

For the latest version of this guide and all guides, go to: <http://www.zebra.com/support>.

---

## Service Information

If you have a problem using the equipment, contact your facility's technical or systems support. If there is a problem with the equipment, they will contact the Zebra Support & Downloads website at: <http://www.zebra.com/support>.

When contacting support, please have the following information available:

- Serial number of the unit
- Model number or product name
- Software type and version number

Zebra responds to calls by e-mail, telephone or fax within the time limits set forth in service agreements.

If your problem cannot be solved by support, you may need to return your equipment for servicing and will be given specific directions. Zebra is not responsible for any damages incurred during shipment if the approved shipping container is not used. Shipping the units improperly can possibly void the warranty.

If you purchased your business product from a Zebra business partner, please contact that business partner for support.



# CHAPTER 1 GETTING STARTED

---

## Introduction

The DS8178 combines superior 1D and 2D omnidirectional bar code scanning performance and advanced ergonomics in a lightweight design. The digital scanner ensures comfort and ease of use for extended periods of time.

---

## Interfaces

The DS8178 digital scanner cradles (CR8178-SC and CR8178-PC) support the following interfaces.

- USB connection to a host. The digital scanner autodetects a USB host and defaults to the HID keyboard interface type. Select other USB interface types by scanning programming bar code menus. See [Appendix B, Country Codes](#) for the interface supported international keyboards (for Windows® environment).

✓ **NOTE** ONLY use compatible Zebra USB cables with a shielded modular connector.

- Standard RS-232 connection to a host. Scan bar code menus to set up communication of the digital scanner with the host.
- Connection to IBM 468X/469X hosts. Scan bar code menus to set up communication of the digital scanner with the IBM terminal.
- Keyboard Wedge connection to a host. The host interprets scanned data as keystrokes. Scan bar codes to set up communication of the digital scanner with the host. See [Appendix B, Country Codes](#) for the interface supported international keyboards (for Windows® environment).
- Configuration via 123Scan.

✓ **NOTE** For a list of supported scanner functionality by communication protocol, see [Appendix J, Communication Protocol Functionality](#).

---

## Unpacking

Remove the digital scanner from its packing and inspect it for damage. If the scanner was damaged in transit, contact support. See [page xxiii](#) for information. **KEEP THE PACKING.** It is the approved shipping container; use this to return the equipment for servicing.

## DS8178 Features



**IMPORTANT** Only use DS8178-SC or DS8178-PC cradles with DS8178 scanners. No other cradles are compatible with the DS8178.

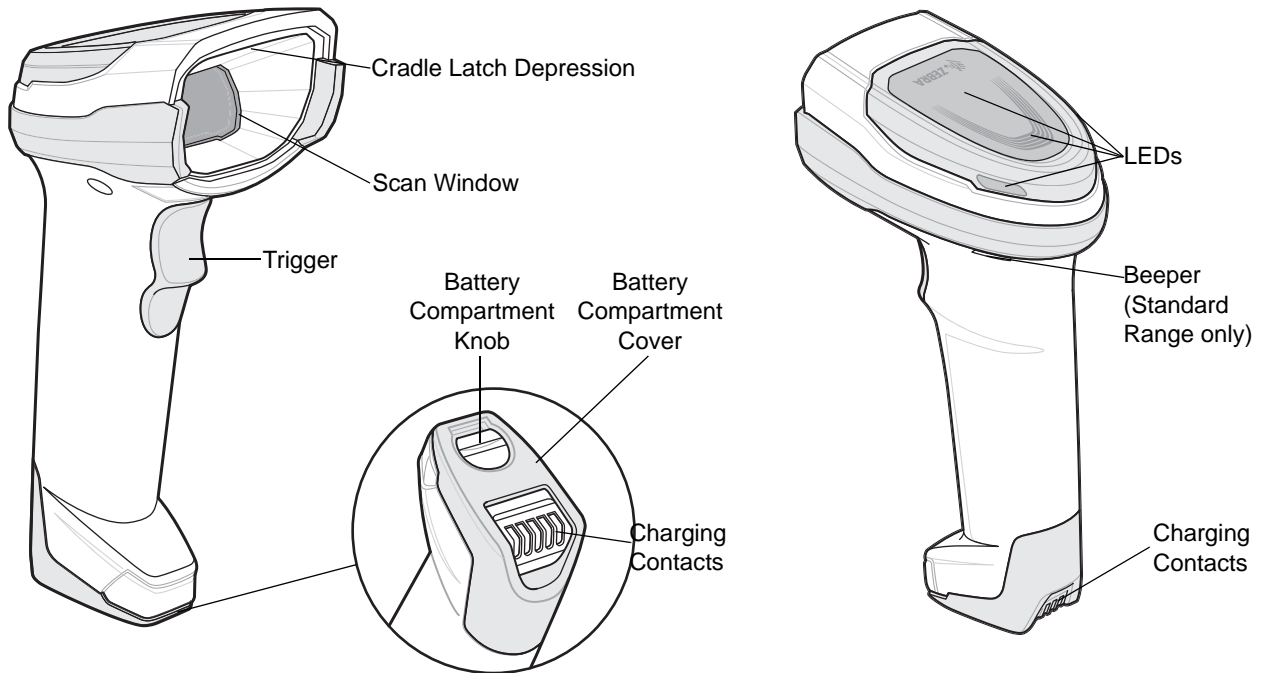

Figure 1-1 Digital Scanner Features

## Cradle Features

- ✓ **NOTE** For detailed information about connecting, using, and mounting the CR8178-SC and CR8178-PC cradles refer to the documentation included with each cradle (*CR8178-SC Standard Cradle Quick Reference Guide*, p/n MN-002784-xx and *CR8178-SC Presentation Cradle Quick Reference Guide*, p/n MN-002854-xx).

The cradles serve as a charger, radio communication interface, and host communication interface for the DS8178 cordless digital scanner. There are two versions of the cradle:

- The CR8178-SC cordless cradle sits on a desktop or mounts on a wall, and charges the DS8178 cordless digital scanner. This cradle also provides host communication by receiving scanner data via a Bluetooth radio, and sending that data to the host through an attached cable. The cable provides power to the cradle from the host or optional power supply if supported.
- The CR8178-PC cordless presentation cradle sits on a desktop and charges the DS8178 cordless digital scanner while allowing bar code scanning in presentation mode. This cradle also provides host communication by receiving scanner data via a Bluetooth radio, and sending that data to the host through an attached cable. The cable provides power to the cradle from the host or optional power supply if supported.

**DO NOT** use any scanner other than the DS8178 with CR8178-SC and CR8178-PC cradles. No other scanners are compatible with these cradles.

- ✓ **NOTE** For more information about communication between the digital scanner, cradle, and host, see [Chapter 4, Radio Communications](#).

### Standard Cradle

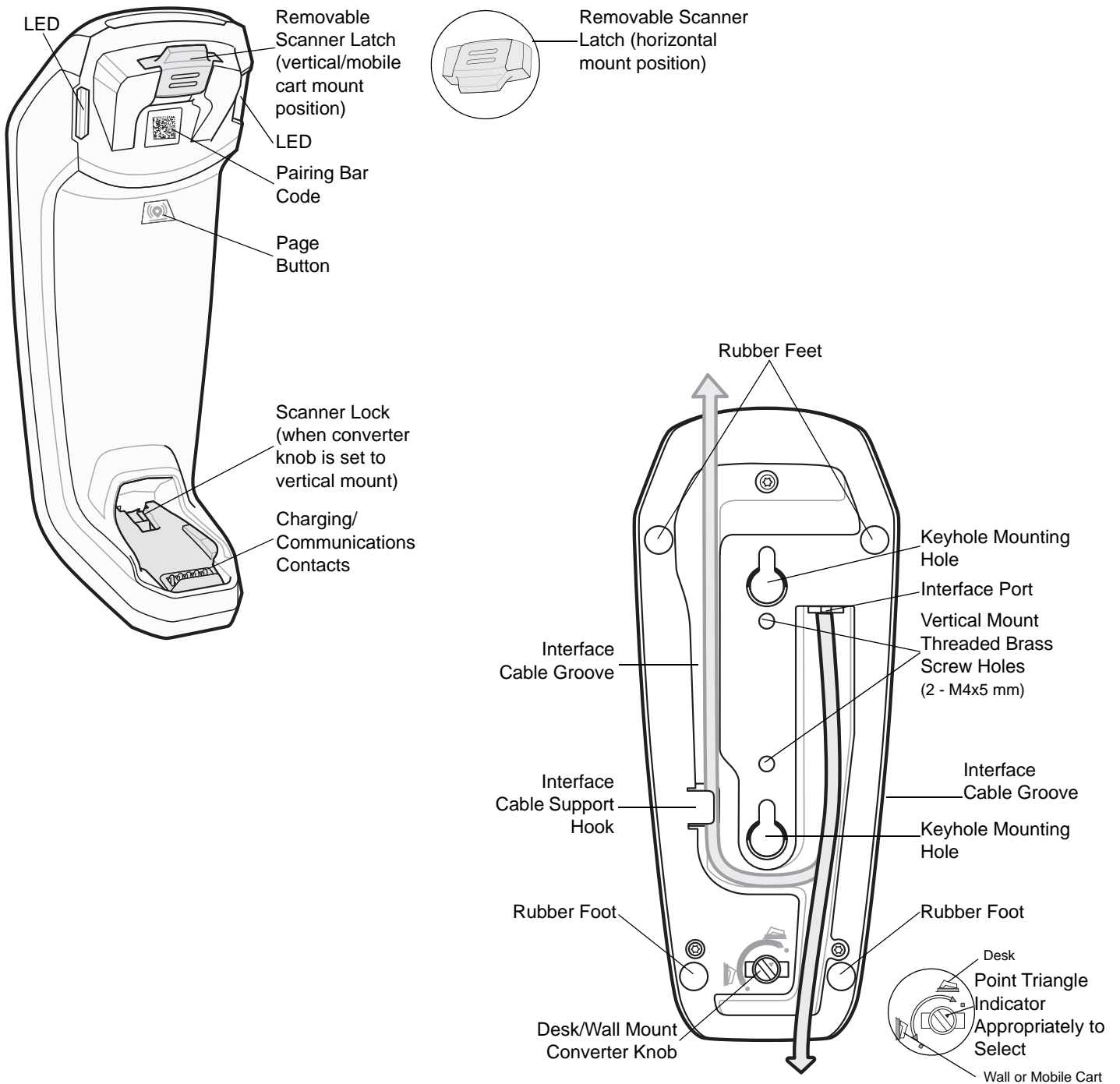

Figure 1-2 CR8178-SC (Standard Cradle) - Top and Bottom Views

## Presentation Cradle

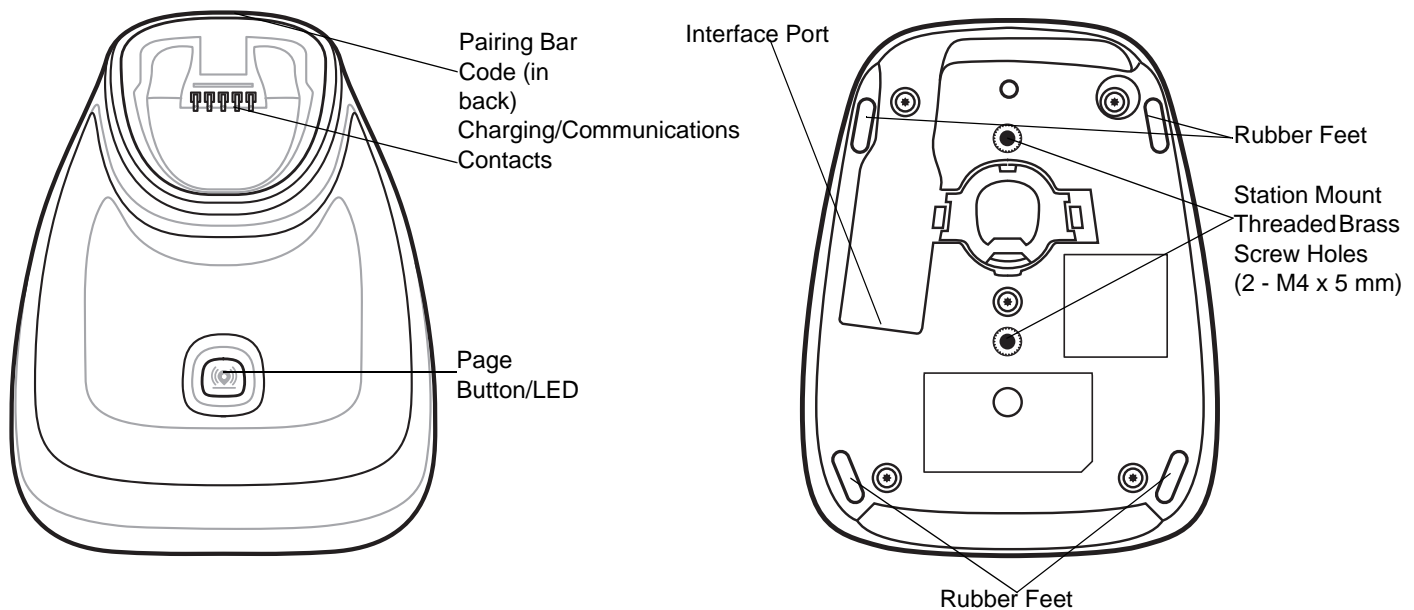

Figure 1-3 CR8178-PC (Presentation Cradle) -Top and Bottom Views

## Connecting the Cradle

1. Connect the appropriate cable to the power supply and an AC power source, if necessary. This ensures detection of the host and prevent inadvertently back powering the cradle from improper detection of the host.
2. Insert the interface cable into the host port.
3. Insert the interface cable into the cradle's host port.
4. For the CR8178-SC only, thread the interface cable under the interface cable support hook and run the cable along the interface cable groove (if applicable).
5. Pair the digital scanner to the cradle either by inserting it in the cradle (if Pair on Contacts is enabled) or by scanning the pairing bar code.
6. If necessary, scan the appropriate host bar code (for non-autodetected interfaces).

## Changing the Host Interface

To connect to a different host, or to the same host through a different cable:

1. Unplug the interface cable from the host.
2. Unplug the power supply from the cradle, if a power supply is used.
3. Connect the interface cable to the new host, or the new interface cable to the existing host.
4. Reconnect the power supply, if required.
5. If necessary, scan the appropriate host bar code (for non-autodetected interfaces).

## Using a DC Power Supply

The cradle can operate from host supplied power, if available. If host power is limited or not available, an external DC power supply can be used with certain host interface cables that support a power jack. An external power supply is recommended if fastest charging is required.



**CAUTION** Always disconnect the DC power supply BEFORE disconnecting the cable to the host end or the cradle may not recognize the new host.

## Mounting the Cradle

For detailed information on mounting the cradle, refer to the documentation included with the cradle.

✓ **NOTE** The drawings in [Figure 1-4](#) are not to scale.

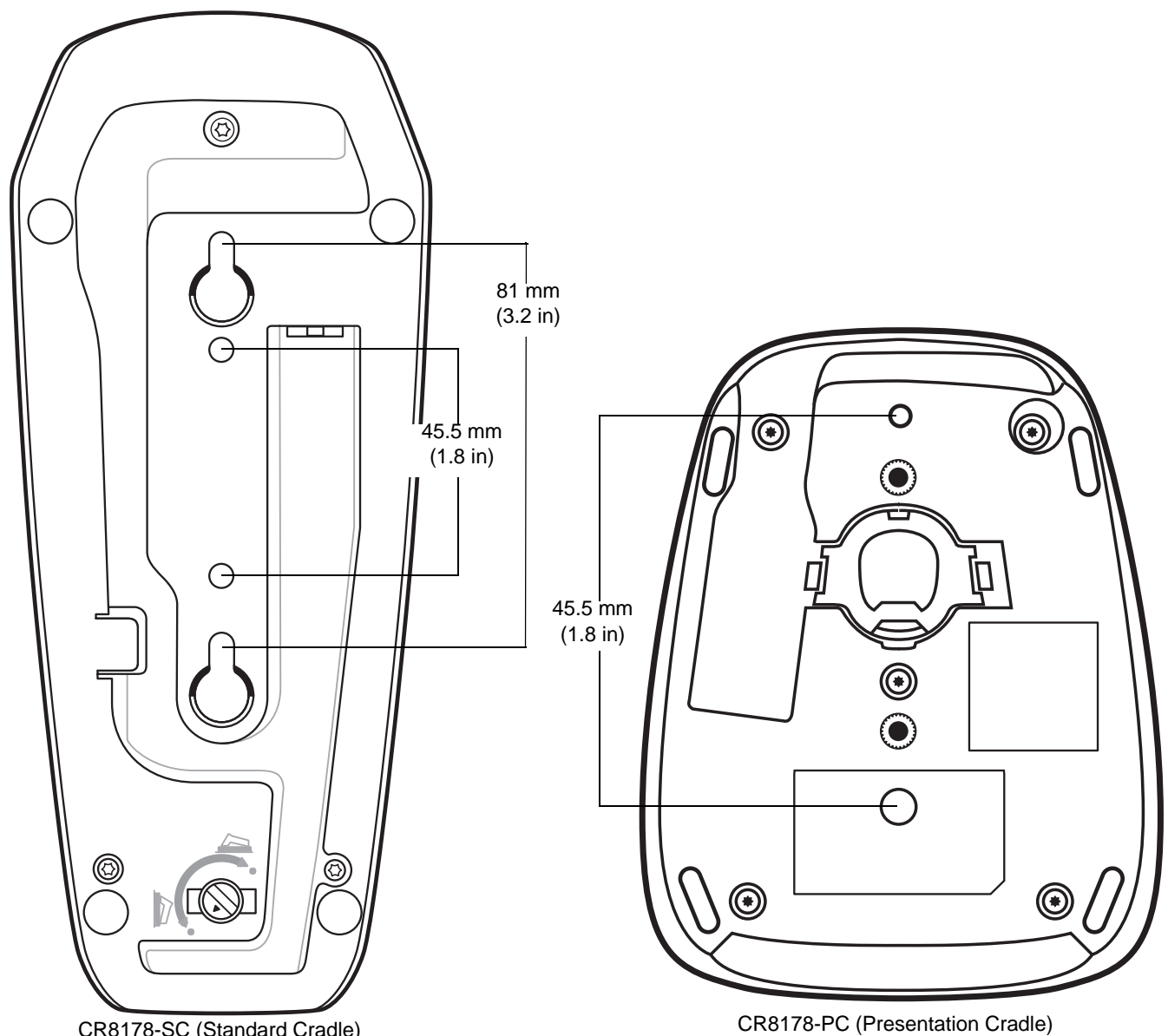

CR8178-SC (Standard Cradle)

CR8178-PC (Presentation Cradle)

**Figure 1-4** Cradle Mounting Dimensions

## Using the Document Capture Stand

The CR8178-PC Document Capture Stand (p/n Stnd-dc0081W-04) can be used with the digital scanner to capture images on 279.4 mm (11 in.) x 215.9 mm (8.5 in.) and A4 sized paper. The paper should be inserted vertically into the Document Capture Stand tab as shown in [Figure 1-5](#).

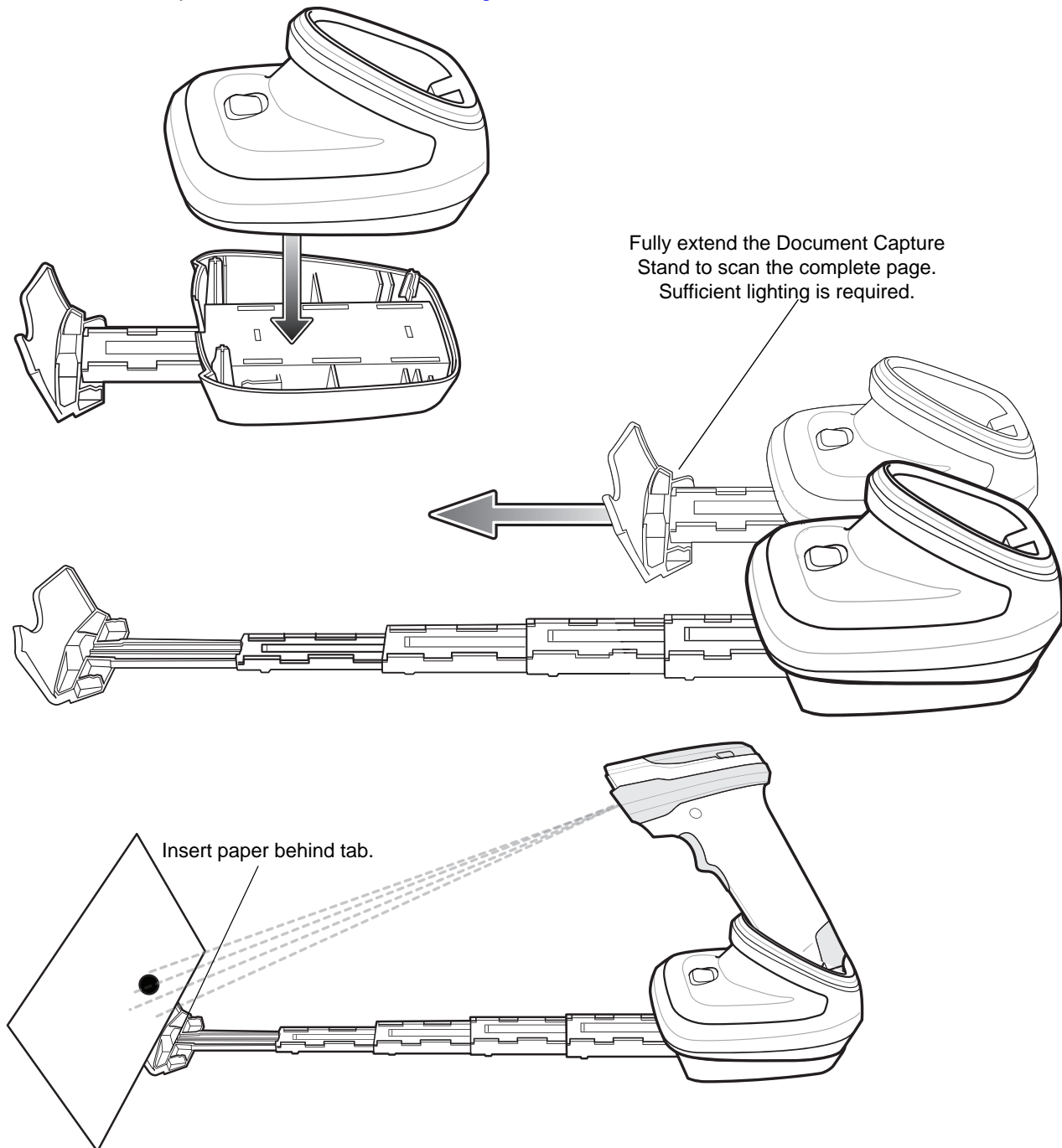

**Figure 1-5** Image Capture Using the Document Capture Stand



## Charging the DS8178 Battery

When using a new battery in the DS8178, the battery requires a charge to be enabled. Insert the battery (see [Charging the DS8178 Battery on page 1-7](#)) in the DS8178 and place the DS8178 in the CR8178-SC or CR8178-PC cradle (see [Inserting the Scanner in the Cradles on page 1-12](#)).

The battery begins pre-charging when the cradle LED lights amber. The scanner boots and the cradle LED begins flashing amber to indicate the start of normal charging.

See [Beeper and LED Indications on page 2-1](#) for detailed LED indicator information.



### NOTES

1. If the battery is significantly discharged it may take several minutes for the scanner to boot. During this time the cradle LED remains solid amber, and the scanner may not show activity. This is normal recovery behavior. (See [Recovering a Discharged Battery](#) below.)

Once the scanner is active, charge time depends on the host type and power source. See [Table 3-2 on page 3-8](#) for typical charge times.

2. The advanced charging system in the CR8178-XX cradles operate the scanner and charge the battery with as much power as allowed by the host or power supply. Charge times lengthen as scanning activity increases when a DS8178 operates in presentation mode on a CR8178-PC cradle. To optimize charge performance, ensure the scanner is oriented to minimize accidental scan activation.



### IMPORTANT

While attached to very power limited hosts, such as a standard USB port, the scanner may slowly discharge the battery during active scanning. In most cases, this is not a problem since the battery charges during breaks in activity. If activation time cannot be reduced, and discharging becomes a problem, it is recommended to attach to a BC1.2 compliant USB port if available, or use a Zebra USB cable that supports an external power supply.



### CAUTION

The battery does not charge when the temperature is above 40°C (104°F). When scanning in presentation mode at temperatures above 40°C (104°F), the battery drains until the temperature drops. When the battery charge is consumed the scanner stops scanning until the temperature drops and the battery has sufficient time to charge.

To avoid temperature related faults, charge the battery and operate the DS8178 in presentation mode on a CR8178-PC only within the recommended 0°C to 40°C (32°F to 104°F) range, and ideally within 5°C to 35°C (41°F to 95°F).

## Recovering a Discharged Battery

When a DS8178 battery becomes discharged to less than 3%, scanning and beeping functions are deactivated. Battery status and communication to the cradle is maintained until the battery reaches 0%, at which point the device shuts down. If left for long periods at 0% the battery can become deeply discharged to a point where the device does not function immediately when placed in a cradle to charge.

If this happens, it is normal for the scanner to appear off for up to several minutes while the battery is gently recovered. Once enough charge is replenished, the scanner lights the battery status LED (solid red for a healthy battery) while the battery continues to charge. At this point the scanner is available to remote management tools, however scanning and beeps are disabled. Depending on the power source available to the cradle, it may take up to 20 minutes for the battery to reach 3% at which point full functionality resumes.

## Shutting Off the Digital Scanner Battery

Scan the **Battery Off** bar code below to shut off the battery for long term storage or shipping. Pull the scanner trigger to turn on the battery.



**Battery Off**



**NOTE** Always scan the **Battery Off** bar code in hand-held mode.

## Inserting the Battery

To insert the battery into the scanner:

1. Remove the battery compartment cover.
  - a. Use a coin to turn the battery compartment knob counterclockwise until it reaches the hard stop.

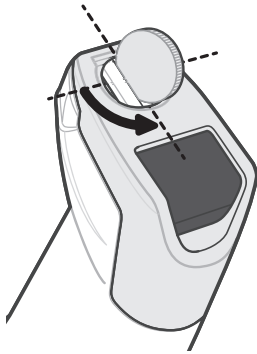

**Figure 1-6** *Unscrewing the Battery Compartment Cover*

- b. Lift the battery compartment cover off.

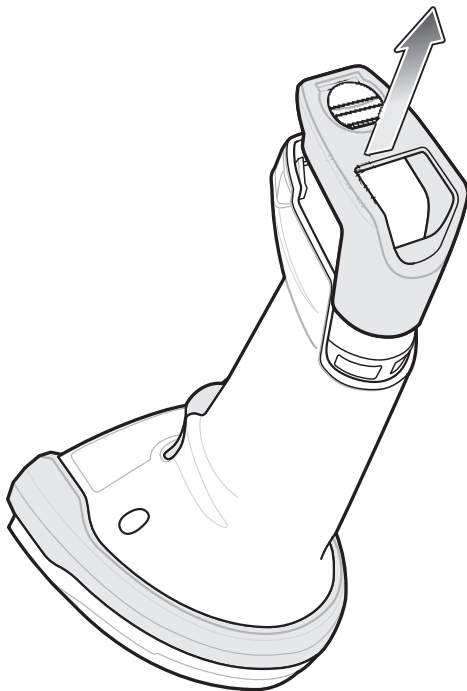

**Figure 1-7** *Removing the Battery Compartment Cover*

- c. Insert the battery into the battery compartment and push until it clicks into place.

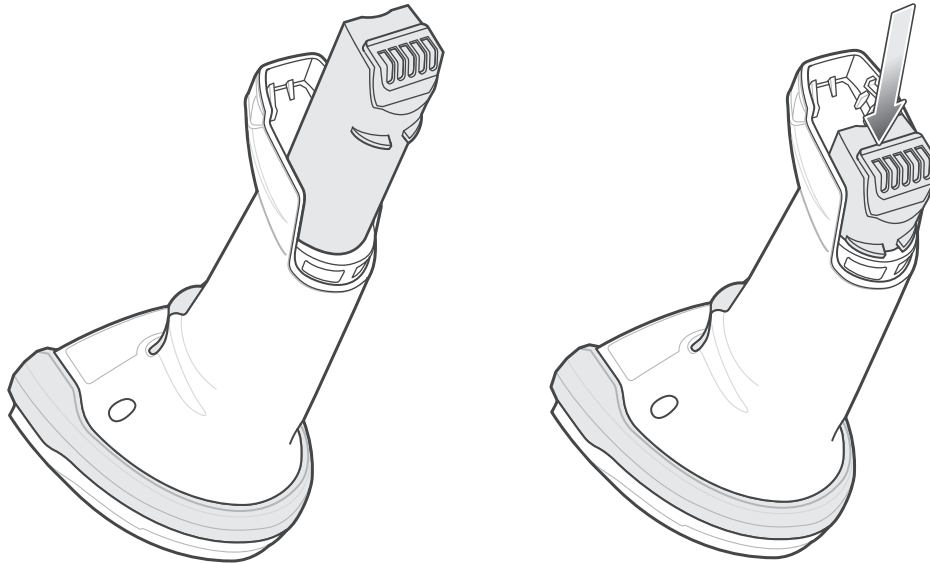

**Figure 1-8** *Inserting the Battery*

2. Replace the battery compartment cover.
  - a. Ensure the battery compartment knob is in the open position.
  - b. Slide the battery compartment cover into place.

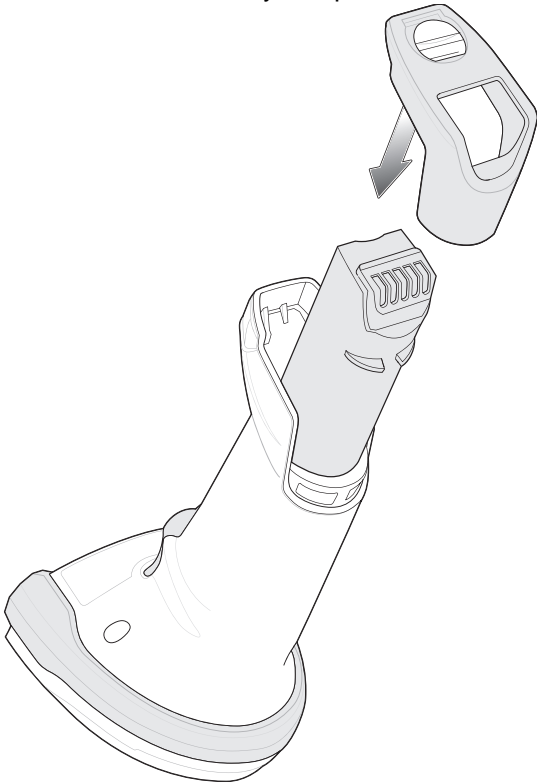

**Figure 1-9** *Replacing the Battery Compartment Cover*

- c. Use a coin to turn the battery compartment knob counterclockwise until it reaches the hard stop.

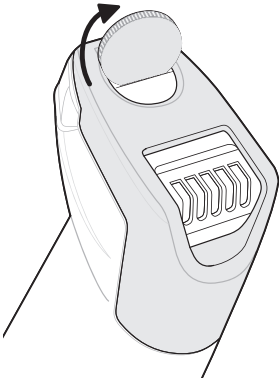
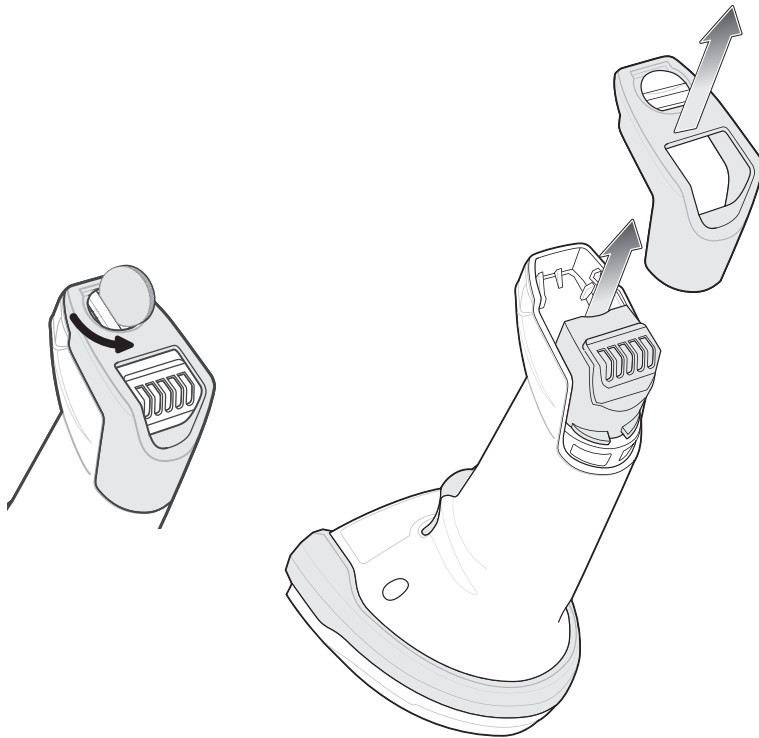

**Figure 1-10** Replacing the Battery Compartment Cover

## Removing the Battery



**IMPORTANT** When replacing the battery, wait at least 5 seconds after removing the old battery before inserting the new battery.



**Figure 1-11** Removing the Battery from the Scanner

To remove the battery from the scanner:

1. Remove the battery compartment cover.
  - a. Use a coin to turn the battery compartment knob counterclockwise until it reaches the hard stop
  - b. Lift the battery compartment cover off.
  - c. Lift the battery out of the battery compartment.
2. To replace the battery, see [Inserting the Battery on page 1-9](#).

## Inserting the Scanner in the Cradles

To insert the digital scanner in the CR8178-SC cradle:

1. Insert the scanner into the cradle top first ensuring that the cradle latch depression (see [Figure 1-1 on page 1-2](#)) connects with the scanner latch on the cradle.
2. Push the handle until it clicks into place, engaging the contacts in the cradle and digital scanner.

Scanner Latch

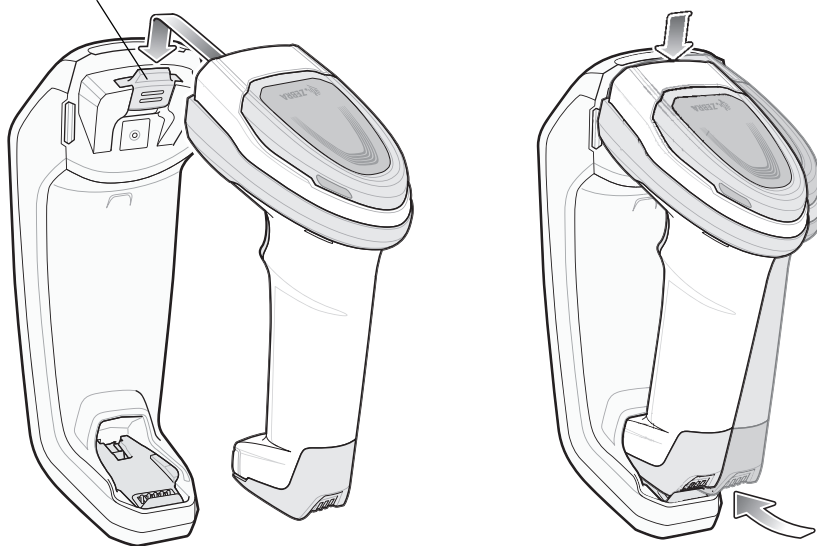

**Figure 1-12** Inserting the Scanner in the CR8178-SC Cradle

To insert the digital scanner in the CR8178-PC cradle:

1. Insert the scanner straight down into the cradle top.
2. The digital scanner naturally rotates forward to engage the digital scanner contacts with the cradle contacts

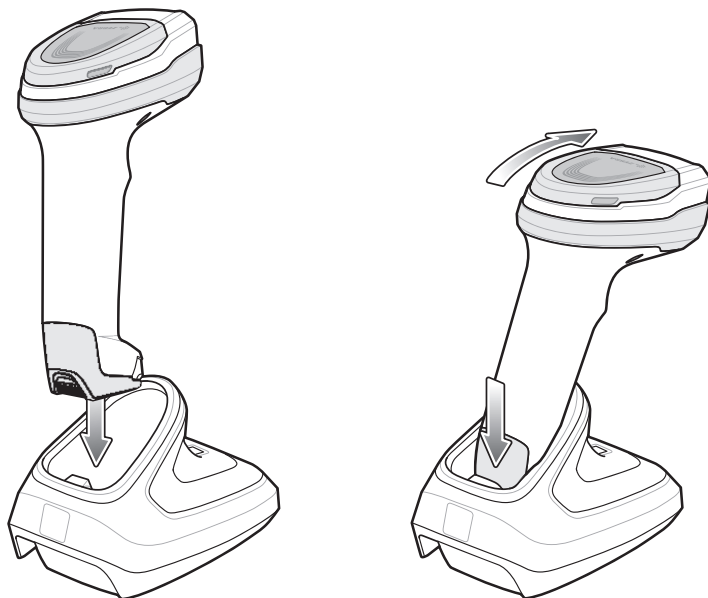

**Figure 1-13** Inserting the Scanner in the CR8178-PC Cradle

---

## Sending Data to the Host Computer

The cradle receives data from the digital scanner via a wireless radio connection and transmits it to the host computer via the host cable. The digital scanner and cradle must be paired for successful wireless communication.

### Pairing

Pairing registers a scanner to the cradle such that the scanner and cradle can exchange information. The CR8178-SC and CR8178-PC operate in two modes: Point-to-Point and Multipoint-to-Point. In Point-to-Point mode, pair the digital scanner to the cradle either by inserting it in the cradle (if pair on contacts is enabled), or by scanning the pairing bar code. In Multipoint-to-Point mode, you can pair up to seven scanners to one cradle. To use this feature, scan the multipoint bar code in [Multipoint-to-Point Communication on page 4-26](#) when the digital scanner is connected to the cradle.

To pair the digital scanner with the cradle, insert the scanner in the cradle or scan the pairing bar code. (Pairing on insertion into the cradle is enabled by default. See [Pairing Methods on page 4-29](#).)



**NOTE** The pairing bar code that connects the digital scanner to a cradle is unique to each cradle.

Do not scan data or parameters until pairing completes.

### Lost Connection to Host

If scanned data does not transmit to the cradle's host, ensure that all cables are firmly inserted and the power supply is connected to an appropriate AC outlet, if applicable. If scanned data still does not transmit to the host, reestablish a connection with the host:

1. Disconnect the power supply from the cradle.
2. Disconnect the host interface cable from the cradle.
3. Wait three seconds.
4. Reconnect the host interface cable to the cradle.
5. Reconnect the power supply to the cradle, if the host requires.
6. Reestablish pairing with the cradle by inserting the scanner in the cradle or scan the pairing bar code. (Pairing on insertion into the cradle is enabled by default. See [Pairing Methods on page 4-29](#).)

---

## Configuring the Scanner

Use the bar codes in this manual or the 123Scan configuration program to configure the digital scanner. See [Chapter 5, User Preferences](#) and each host chapter for information about programming the digital scanner using bar code menus. See [Chapter 16, 123Scan and Software Tools](#) to configure the digital scanner using this configuration program. 123Scan includes a help file.

---

## Radio Communications

The digital scanner can communicate with remote devices via Bluetooth, or by pairing with a cradle. For radio communication parameters, detailed information about operational modes, Bluetooth and pairing, see [Chapter 4, Radio Communications](#).

---

### Accessories

The digital scanner ships with the battery and the *DS8178 Quick Start Guide*. The following required accessories must be ordered separately:

- Cradle, required for charging the battery (see [Standard Cradle on page 1-3](#) and [Presentation Cradle on page 1-4](#)).
- Document Capture Stand for use with the CR8178-PC (p/n Stnd-dc0081W-04) (see [Using the Document Capture Stand on page 1-6](#)).
- Replacement battery for the DS8178 digital scanner.
- Replacement battery for the DS8178 digital scanner for use in Korea and India.
- Interface cable for the appropriate interface.
- Universal power supply, if the interface requires one.

See [Accessories on page xx](#) for the full list of power supplies and part numbers. Also see [Scanner Configurations on page xix](#) and [Cradle Configurations on page xx](#) for product configurations. For additional items, contact a local Zebra representative or business partner.



# CHAPTER 2 DATA CAPTURE

---

## Introduction

This chapter provides beeper and LED definitions, techniques involved in scanning bar codes, general instructions and tips about scanning, and decode ranges.

---

## Beeper and LED Indications

The digital scanner issues different beep sequences/patterns and an LED display to indicate status. [Table 2-1](#) defines beep sequences/patterns and LED displays which occur during both normal scanning and while programming the digital scanner.

In addition to the System/Decode LEDs, the DS8178 cordless digital scanner has a battery LED gauge (see [on page 1-2](#)).

The battery LED gauge is always active when inserted in the cradle. After the scanner is removed from the cradle, it is active for four seconds.

After the trigger is held for three seconds the battery LED gauge remain active for four seconds after trigger release.

## Digital Scanner Indications

**Table 2-1** *Digital Scanner Beeper and LED Indications*

Beeper Sequence	LED	Indication
<b>Standard Use</b>		
Low/medium/high beeps	Green	Power up.
<b>Scanning</b>		
None	Green solid	Presentation Mode on.
None	No LED; green LED is turned off	Presentation Mode off.

**Table 2-1** Digital Scanner Beeper and LED Indications (Continued)

Beeper Sequence	LED	Indication
Medium beep (or as configured)	Green flash	A bar code was successfully decoded. (See <a href="#">User Preferences Parameter Defaults on page 5-2</a> for programming beeper sounds.)
Low/low/low/extra low beeps	Red	Parity error.
Four long low beeps	Red	A transmission error was detected in a scanned symbol. The data is ignored. This occurs if a unit is not properly configured. Check option setting.
Five long low beeps	Red	Conversion or format error.
None	Red (fast blink) on trigger pull	Scanner is disabled by a host command to the scanner.
High	None	A <BEL> character is received over RS-232.
<b>Wireless Operation</b>		
Low, high, low, high	Red	Out of batch storage memory, unable to store new bar code.
<b>Radio Indications</b>		
Low	None	Scanner inserted into a cradle (may be disabled).
Low, high	Green	Bluetooth connection established.
High, low	Red	Bluetooth disconnection event.
Long low, long high	Red	Bluetooth page timeout; remote device is out of range/not powered.
Long low, long high, long low, long high	None	Bluetooth connection attempt was rejected by remote device.
None	Green (fast blink)	Bluetooth attempting reconnection.
Five high	None	Bluetooth attempting reconnection (default is disable).
Six high	Blue (fast/fast/slow)	Paging state indication.

Table 2-1 Digital Scanner Beeper and LED Indications (Continued)

Beeper Sequence	LED	Indication
<b>Battery Indications</b>		
Four short high beeps	Red (stays on)	Low battery indication (on trigger release).
	Green Amber Red	Battery charge level: 51-100% Battery charge level: 21-50% Battery charge level: 0-20%  Battery charge level indication (state of charge in % of present full charge capacity).
	Green/Red alternating Amber/Red alternating Red blinking	Battery end of life, battery charge level: 51-100% Battery end of life, battery charge level: 21-50% Battery end of life, battery charge level: 0-20%  When the battery indicator displays any one of these patterns it is time to replace your battery.
<b>Parameter Programming</b>		
Long low/long high beeps	Red	Input error, incorrect bar code or <b>Cancel</b> scanned, wrong entry, incorrect bar code programming sequence; remain in program mode.
High/low beeps	Green	Keyboard parameter selected. Enter value using bar code keypad.
High/low/high/low beeps	Green	Successful program exit with change in the parameter setting.
<b>ADF Programming</b>		
Low/high/low beeps	None	ADF transmit error.
High/low beeps	Green	Number expected. Enter another digit. Add leading zeros to the front if necessary.
Low/low beeps	Green	Alpha expected. Enter another alphabetic character or scan the <b>End of Message</b> bar code.
High/high beeps	Green blinking	ADF criteria or action is expected. Enter another criteria or action or scan the <b>Save Rule</b> bar code.
High/low/low beeps	Green	All criteria or actions cleared for current rule, continue entering rule.
High/low/high/low beeps	Green (turns off blinking)	Rule saved. Rule entry mode exited.
Long low/long high beeps	Red	Rule error. Entry error, wrong bar code scanned, or criteria/action list is too long for a rule. Re-enter criteria or action.
Low beep	Green	Deleted last saved rule. The current rule is left intact.

**Table 2-1** Digital Scanner Beeper and LED Indications (Continued)

Beeper Sequence	LED	Indication
Low/high/high beeps	Green	All rules deleted.
Long low/long high/long low/long high beeps	Red	Out of rule memory. Erase some existing rules, then try to save rule again.
Long low/long high/long low beeps	Green (turns off blinking)	Cancel rule entry. Rule entry mode exited because of an error or the user asked to exit rule entry.
<b>Host Specific</b>		
<b>USB only</b>		
Four high beeps	None	Digital scanner has not completed initialization. Wait several seconds and scan again.
<b>RS-232 only</b>		
High/high/high/low beeps	Red	RS-232 receive error.
High beep	None	A <BEL> character is received when Beep on <BEL> is enabled (Point-to-Point mode only).

## Cradle LED Indications

**Table 2-2** Cradle LED Indications

LED	Indication
<b>Standard Use</b>	
Green (stays on)	Power Up
<b>Radio Indications</b>	
Green (off, then on)	Bluetooth connection established
Blue	Page button
Blue (fast/fast/slow)	Page issued
<b>Battery Indications</b>	
Amber (stays on)	Pre-charging
Amber blinking	Charging
Green (stays on)	Fully charged
Amber fast blinking	Charging Error
<b>Battery End of Life Indications</b>	
Red blinking	Charging
Red (stays on)	Fully charged

**Table 2-2** Cradle LED Indications (Continued)

LED	Indication
Red fast blinking	Charging error
<b>Maintenance Indications</b>	
Red (stays on)	Enter boot loader
Red blinking	Firmware installation

[Table 2-3](#) lists the conditions in which the specified host controls the System Indicator LED.

**Table 2-3** Host Controlled Cradle LED Indications

LED	Indication
<b>123Scan</b>	
Slow Blinking Green	Scanner connected to 123Scan.
Fast Blinking Red	File being transferred to the scanner (parameters and firmware).
Slow Blinking Red	Firmware activated on the scanner, loaded into memory.
Solid Green	Programming completed successfully (parameters and firmware).
Solid Red	Error State.
<b>SMS</b>	
Blinking Red (Both scanner and cradle)	Loading the SMS package to scanner.

---

## Scanning

✓ **NOTE** The standard digital scanner emits a red illumination with a red aim dot (pictured in [Figure 2-1](#) and [Figure 2-2](#)). The Healthcare configuration emits a white illumination with a green aim dot.

### Hand-Held Scanning

1. Aim the digital scanner at a bar code and pull the trigger to decode.

2. Press the trigger until the digital scanner beeps, indicating the bar code is successfully decoded. For more information on beeper and LED definitions, see [Beeper and LED Indications on page 2-1](#).

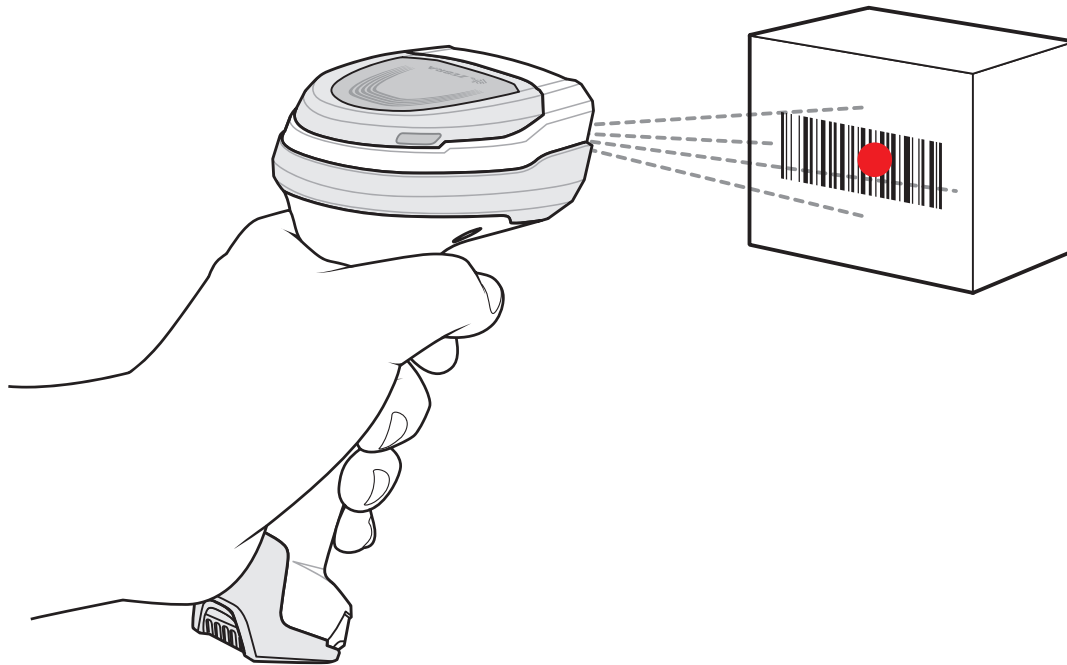

**Figure 2-1** Scanning in Hand-Held Mode

## Hands-Free Scanning

The scanner is in hands-free (presentation) mode when it sits in the CR8178-PC cradle. During idle conditions the scanner operates in object detection mode, where it automatically wakes up to decode a bar code presented in the field of view. In object detection mode it is normal for the illumination LEDs to be dimly lit.

To scan:

1. Ensure all connections are secure (see appropriate host chapter).
2. Present the bar code in the scanner field of view.

- Upon successful decode, the scanner beeps and the LED flashes green. (For more information about beeper and LED definitions, [Beeper and LED Indications on page 2-1](#)).

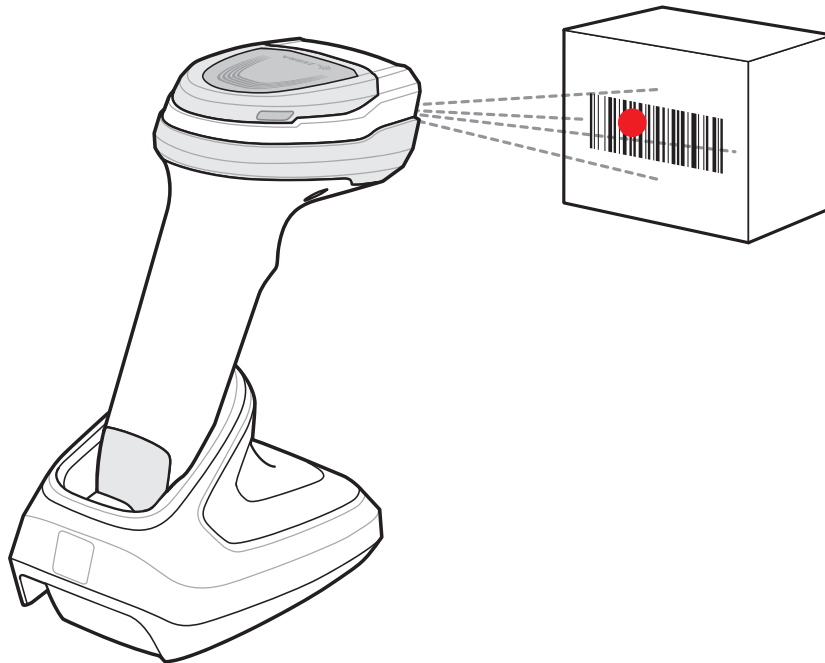

**Figure 2-2** Scanning in Hands-Free Mode

## Aiming with Digital Scanner

When scanning, the digital scanner projects a red LED dot which allows positioning the bar code within its field of view. See [Decode Ranges on page 2-9](#) for the proper distance to achieve between the digital scanner and a bar code.

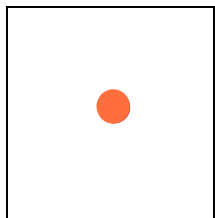

**Figure 2-3** Aiming Dot

If necessary, the digital scanner turns on its red illumination LEDs to illuminate the target bar code.

To scan a bar code, center the symbol and ensure the entire symbol is within the rectangular area formed by the illumination LEDs.

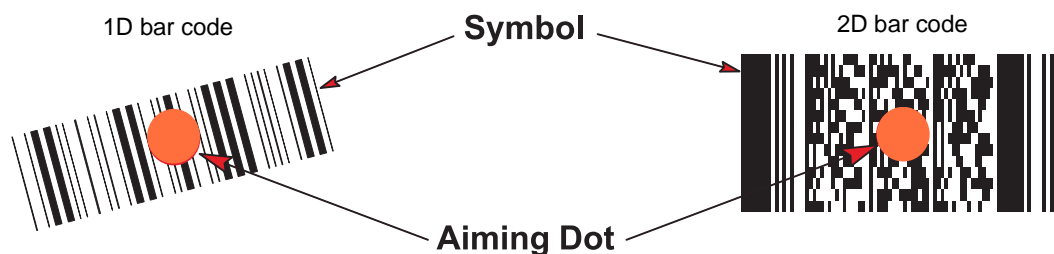

**Figure 2-4** Scanning Orientation with Aiming Dot

The digital scanner can also read a bar code presented within the aiming dot not centered. The top examples in [Figure](#) show acceptable aiming options, while the bottom examples can not be decoded.

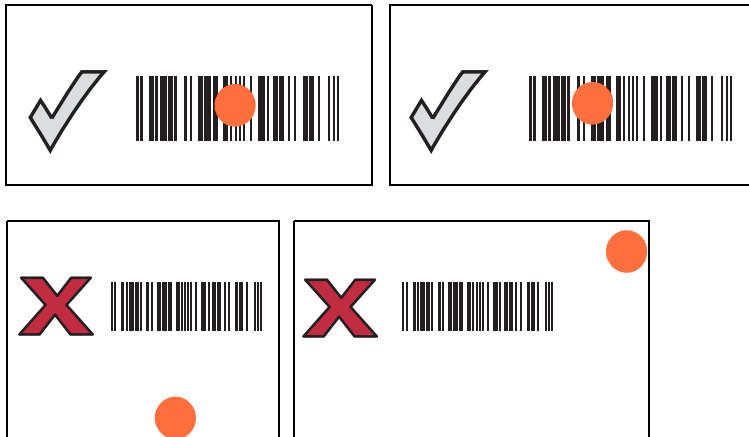

**Figure 2-5** *Acceptable and Incorrect Aiming*

The aiming dot is smaller when the digital scanner is closer to the symbol and larger when it is farther from the symbol. Scan symbols with smaller bars or elements (mil size) closer to the digital scanner, and those with larger bars or elements (mil size) farther from the digital scanner.

The digital scanner beeps to indicate that it successfully decoded the bar code. For more information on beeper and LED definitions, see [Table 2-1](#).



## Decode Ranges

**Table 2-4** DS8178 Decode Ranges

Bar Code Type	Symbol Density	DS8178-SR Typical Working Ranges		DS8178-HC Typical Working Ranges	
		Near	Far	Near	Far
Code 39	3.0 mil	2.2 in/5.6 cm	5.0 in/12.7 cm	1.4 in/3.6 cm	5.1 in/13.0 cm
	20.0 mil	0.0 in/0.0 cm	36.8 in/93.5 cm	0.0 in/0.0 cm	22.4 in/56.9 cm
Code 128	3.0 mil	2.6 in/6.6 cm	4.5 in/11.4 cm	1.8 in/4.6 cm	4.1 in/10.4 cm
	5.0 mil	1.6 in/4.1 cm	8.4 in/21.3 cm	1.2 in/3.0 cm	8.1 in/20.6 cm
	15 mil	0.0 in/0.0 cm	27.1 in/68.8 cm	1.0 in/ 2.5 cm	16.9 in/42.9 cm
100% UPC	13.0 mil	0.0 in/0.0 cm	24.0 in/61.0 cm	0.0 in/0.0 cm	15.9 in/40.4 cm
PDF 417	5 mil	2.3 in/5.8 cm	6.4 in/16.3 cm	1.5 in/3.8 cm	6.1 in/15.5 cm
	6.67 mil	1.8 in/4.6 cm	8.5 in/21.6 cm	1.1 in/2.8 cm	8.1 in/20.6 cm
Data Matrix	5.0 mil	n/a	n/a	1.9 in/4.8 cm	4.5 in/11.4 cm
	7.5 mil	2.1 in/5.3 cm	6.9 in/ 17.5 cm	1.3 in/ 3.3 cm	6.7 in/17.0 cm
	10.0 mil	1.1 in/2.8 cm	9.9 in/ 25.1 cm	0.6 in/1.5 cm	8.5 in/ 21.6 cm
QR Code	10.0 mil	1.0 in/2.5 cm	8.6 in/ 21.8 cm	0.6 in/1.5 cm	7.7 in/19.6 cm
	20.0 mil	0.1 in/0.3 cm	17.6 in/ 44.7 cm	0.0 in/0.0 cm	12.5 in/ 31.8 cm



# CHAPTER 3 MAINTENANCE AND TECHNICAL SPECIFICATIONS

---

## Introduction

This chapter provides suggested digital scanner maintenance, troubleshooting, technical specifications, and signal descriptions (pin-outs).

---

## Maintenance



**IMPORTANT** Use pre-moistened wipes and do not allow liquid cleaner to pool.

- <sup>1</sup> When using sodium hypochlorite (bleach) based products always follow the manufacturer's recommended instructions: use gloves during application and remove the residue afterwards with a damp cloth to avoid prolonged skin contact while handling the scanner.

Due to the powerful oxidizing nature of sodium hypochlorite the metal surfaces on the scanner are prone to oxidation (corrosion) when exposed to this chemical in the liquid form (including wipes) and should be avoided. In the event that these type of disinfectants come in contact with metal on the scanner prompt removal with a dampened cloth after the cleaning step is critical.

## Known Harmful Ingredients

The following chemicals are known to damage the plastics on Zebra scanners and should not come in contact with the device:

- Acetone
- Ammonia solutions
- Aqueous or alcoholic alkaline solutions
- Aromatic and chlorinated hydrocarbons
- Benzene
- Carboic acid
- Compounds of amines or ammonia
- Ethanolamine
- Ethers
- Ketones
- TB-lysoform
- Toluene
- Trichloroethylene.

### Approved Cleaners for Standard DS8178 Digital Scanners and CR8178 Cradles

- Isopropyl alcohol 70% (including wipes)
- Bleach/sodium hypochlorite <sup>1</sup> (see important note above)
- Hydrogen peroxide
- Mild dish soap
- Ammonium Chloride.

### Approved Disinfectant Cleaners for Healthcare Configurations of the DS8178 Digital Scanners and CR8178 Cradles

- Veridien Viraguard
- Sodium Hypochlorite 6%
- Ammonium Chloride 10%
- Spartan Super HDQL 10
- Surgipath Cloro-Wipe Towelette
- PDI Alcohol Prep Pads
- 10% Bleach Solution <sup>1</sup>
- Clorox® Non-Bleach Disinfecting Wipes <sup>1</sup> (see important note above)
- Oxivir® Tb Wipes
- 3% Hydrogen Peroxide Solution
- Sani-Cloth® Bleach Wipes <sup>1</sup> (see important note above)
- Sani-Cloth® Plus Germicidal Wipes
- 91% Isopropyl Alcohol Solution
- MetriCide® 28 Day Solution (2.5% Glutaraldehyde)
- CaviWipes® Disinfecting Towlettes
- Virex®II 256 Disinfectant Cleaner
- Cidex® OPA
- Sani-Cloth® HB Germicidal Wipes
- Sani-Cloth® PDI AF3 Wipes
- Super San-Cloth® Wipes
- Windex® Original
- Windex® Multi-Surface Anti Bacterial Spray
- Formula 409® Glass and Surface
- Hepacide Quat® II
- Dispatch® Wipes.

## Cleaning the Digital Scanner

Routinely cleaning the exit window is required. A dirty window may affect scanning accuracy. Do not allow any abrasive material to touch the window.

To clean the scanner:

1. Dampen a soft cloth with one of the approved cleaning agents listed above or use pre-moistened wipes.
2. Gently wipe all surfaces, including the front, back, sides, top and bottom. Never apply liquid directly to the scanner. Be careful not to let liquid pool around the scanner window, trigger, cable connector or any other area on the device.
3. Be sure to clean the trigger and in between the trigger and the housing (use a cotton-tipped applicator to reach tight or inaccessible areas).
4. Do not spray water or other cleaning liquids directly into the exit window.
5. Wipe the scanner exit window with a lens tissue or other material suitable for cleaning optical material such as eyeglasses.
6. Immediately dry the scanner window after cleaning with a soft non-abrasive cloth to prevent streaking.
7. Allow the unit to air dry before use.
8. Scanner connectors:
  - a. Dip the cotton portion of a cotton-tipped applicator in isopropyl alcohol.
  - b. Rub the cotton portion of the cotton-tipped applicator back-and-forth across the connector on the Zebra scanner at least 3 times. Do not leave any cotton residue on the connector.
  - c. Use the cotton-tipped applicator dipped in alcohol to remove any grease and dirt near the connector area.
  - d. Use a dry cotton tipped applicator and rub the cotton portion of the cotton-tipped applicator back-and-forth across the connectors at least 3 times. Do not leave any cotton residue on the connectors.

## Troubleshooting

**Table 3-1** *Troubleshooting*

Problem	Possible Causes	Possible Solutions
The aiming pattern does not appear when pressing the trigger.	No power to the digital scanner.	If the configuration requires a power supply, re-connect the power supply.
	Incorrect host interface cable is used.	Connect the correct host interface cable.
	Interface/power cables are loose.	Re-connect cables.
	Digital scanner is disabled.	For IBM 468x and USB IBM hand-held, IBM table-top, and OPOS modes, enable the digital scanner via the host interface. Otherwise, see the technical person in charge of scanning.
	If using RS-232 Nixdorf B mode, CTS is not asserted.	Assert CTS line.
	Aiming pattern is disabled.	Enable the aiming pattern. See <a href="#">Hand-Held Decode Aiming Pattern on page 5-22</a> .
Digital scanner emits aiming pattern, but does not decode the bar code.	Digital scanner is not programmed for the correct bar code type.	Program the digital scanner to read that type of bar code. See <a href="#">Chapter 12, Symbologies</a> .
	Bar code symbol is unreadable.	Scan test symbols of the same bar code type to determine if the bar code is defaced.
	The symbol is not completely inside aiming pattern.	Move the symbol completely within the aiming pattern.  Move the symbol completely within the field of view (AIM pattern does NOT define FOV)
	Distance between digital scanner and bar code is incorrect.	Move the scanner closer to or further from the bar code. See <a href="#">Decode Ranges on page 2-9</a> .

**Table 3-1** *Troubleshooting (Continued)*

<b>Problem</b>	<b>Possible Causes</b>	<b>Possible Solutions</b>
Digital scanner decodes bar code, but does not transmit the data to the host.	Digital scanner is not programmed for the correct host type.	Scan the appropriate host type programming bar code. See the chapter corresponding to the host type.
	Interface cable is loose.	Re-connect the cable.
	Cradle is not programmed for the correct host type.	Check digital scanner host parameters or edit options.
	Digital scanner is not paired to host connected interface.	Pair digital scanner to the cradle by scanning the <b>PAIR</b> bar code on the cradle.
	Cradle has lost connection to the host.	In this exact order: disconnect power supply; disconnect host cable; wait three seconds; reconnect host cable; reconnect power supply; reestablish pairing.
	If the digital scanner emits four long low beeps, a transmission error occurred. This occurs if a unit is not properly configured or connected to the wrong host type.	Set the scanner's communication parameters to match the host's setting.
	If the digital scanner emits 5 low beeps, a conversion or format error occurred.	Configure the digital scanner's conversion parameters properly.
Host displays scanned data incorrectly.	Digital scanner is not programmed to work with the host.	Scan the appropriate host type programming bar code.
		For RS-232, set the digital scanner's communication parameters to match the host's settings.
		For a Keyboard Wedge configuration, program the system for the correct keyboard type, and turn off the CAPS LOCK key.
		Program the proper editing options (e.g., UPC-E to UPC-A Conversion).
Digital scanner emits short low/short medium/short high beep sequence (power-up beep sequence) more than once.	The USB bus may put the digital scanner in a state where power to the scanner is cycled on and off more than once.	Normal during host reset.
Digital scanner emits 4 short high beeps during decode attempt.	Digital scanner has not completed USB initialization.	Wait several seconds and scan again.

**Table 3-1** Troubleshooting (Continued)

Problem	Possible Causes	Possible Solutions
Digital scanner emits Low/low/low/extra low beeps when not in use.	RS-232 receive error.	Normal during host reset. Otherwise, set the digital scanner's RS-232 parity to match the host setting.
Digital scanner emits low/high beeps during programming.	Input error, incorrect bar code or <b>Cancel</b> bar code was scanned.	Scan the correct numeric bar codes within range for the parameter programmed.
Digital scanner emits low/high/low/high beeps during programming.	Out of host parameter storage space.	Scan <a href="#">Default Parameters on page 5-5</a> .
	Out of memory for ADF rules.	Reduce the number of ADF rules or the number of steps in the ADF rules.
	During programming, indicates out of ADF parameter storage space.	Erase all rules and re-program with shorter rules.
Digital scanner emits low/high/low beeps.	ADF transmit error.	Refer to the Advanced Data Formatting Guide for information.
	Invalid ADF rule is detected.	Refer to the Advanced Data Formatting Guide for information.
Digital scanner emits a power-up beep after changing USB host type.	The USB bus re-established power to the digital scanner.	Normal when changing USB host type.
Digital scanner emits one high beep when not in use.	In RS-232 mode, a <BEL> character was received and Beep on <BEL> option is enabled.	Normal when <b>Beep on &lt;BEL&gt;</b> is enabled and the digital scanner is in RS-232 mode.
Digital scanner emits frequent beeps.	No power to the scanner.	Check the system power. If the configuration requires a power supply, re-connect the power supply.
	Incorrect host interface cable is used.	Verify that the correct host interface cable is used. If not, connect the correct host interface cable.
	Interface/power cables are loose.	Check for loose cable connections and re-connect cables.



**Table 3-1** *Troubleshooting (Continued)*

Problem	Possible Causes	Possible Solutions
Digital scanner emits five long low beeps after a bar code is decoded.	Conversion or format error was detected. The scanner conversion parameters are not properly configured.	Ensure the scanner conversion parameters are properly configured.
	Conversion or format error was detected. An ADF rule was set up with characters that can't be sent for the host selected.	Change the ADF rule, or change to a host that can support the ADF rule.
	Conversion or format error was detected. A bar code was scanned with characters that can't be sent for that host.	Change the bar code, or change to a host that can support the bar code.



**NOTE** If after performing these checks the digital scanner still experiences problems, contact the distributor or call support.

## Report Software Version Bar Code

When contacting support, a support representative may ask you to scan the bar code below to determine the version of software installed in the digital scanner.



**Report Software Version**

## Technical Specifications

✓ **NOTE** Operating current specifications are subject to change.

**Table 3-2** *Technical Specifications*

Item	Description																								
<b>Physical Characteristics</b>																									
Dimensions																									
<b>Scanner</b>	6.6 in H x 2.6 in W x 4.2 in D / 16.8 cm H x 6.7 cm W x 10.6 cm D																								
<b>Presentation Cradle</b>	2.9 in H x 3.7 in W x 4.8 in D / 7.3 cm H x 9.4 cm W x 12.3 cm D																								
<b>Desk/Wall Cradle</b>	2.8 in H x 3.3 in W x 8.3 in D / 7.2 cm H x 8.4 cm W x 21.1 cm D																								
Weight - DS8178-SR/DL																									
<b>Scanner</b>	8.2 oz / 232 g																								
<b>Presentation Cradle</b>	5.4 oz / 153 g																								
<b>Desk/Wall Cradle</b>	6.5 oz / 183 g																								
Weight - DS8178-HC																									
<b>Scanner</b>	8.3 oz / 237 g																								
<b>Presentation Cradle</b>	6.5 oz / 183 g																								
<b>Desk/Wall Cradle</b>	7.1 oz / 202 g																								
<b>Cradle Operating Currents</b>																									
CR8178-SC Operating Current (mA) T <sub>A</sub> =25C	<table border="1"> <thead> <tr> <th>Mode</th> <th>Typ</th> <th>Max</th> </tr> </thead> <tbody> <tr> <td>Idle @ VIN = 12V</td> <td>43</td> <td>50</td> </tr> <tr> <td>Idle @ VIN = 5V</td> <td>93</td> <td>100</td> </tr> <tr> <td>Charging, Standard USB</td> <td>470</td> <td>500</td> </tr> <tr> <td>Charging, BC1.2 CDP</td> <td>1350</td> <td>1500</td> </tr> <tr> <td>Charging, BC1.2 DCP</td> <td>1100</td> <td>1200</td> </tr> <tr> <td>Charging, 5V non-USB</td> <td>730</td> <td>750</td> </tr> <tr> <td>Charging, 12V non-USB</td> <td>743</td> <td>1000</td> </tr> </tbody> </table>	Mode	Typ	Max	Idle @ VIN = 12V	43	50	Idle @ VIN = 5V	93	100	Charging, Standard USB	470	500	Charging, BC1.2 CDP	1350	1500	Charging, BC1.2 DCP	1100	1200	Charging, 5V non-USB	730	750	Charging, 12V non-USB	743	1000
Mode	Typ	Max																							
Idle @ VIN = 12V	43	50																							
Idle @ VIN = 5V	93	100																							
Charging, Standard USB	470	500																							
Charging, BC1.2 CDP	1350	1500																							
Charging, BC1.2 DCP	1100	1200																							
Charging, 5V non-USB	730	750																							
Charging, 12V non-USB	743	1000																							
CR8178-PC Operating Current (mA) T <sub>A</sub> =25C	<table border="1"> <thead> <tr> <th>Mode</th> <th>Typ</th> <th>Max</th> </tr> </thead> <tbody> <tr> <td>Idle @ VIN = 12V</td> <td>37</td> <td>45</td> </tr> <tr> <td>Idle @ VIN = 5V</td> <td>77</td> <td>85</td> </tr> <tr> <td>Charging, Standard USB</td> <td>470</td> <td>500</td> </tr> <tr> <td>Charging, BC1.2 CDP</td> <td>1350</td> <td>1500</td> </tr> <tr> <td>Charging, BC1.2 DCP</td> <td>1100</td> <td>1200</td> </tr> <tr> <td>Charging, 5V non-USB</td> <td>730</td> <td>750</td> </tr> <tr> <td>Charging, 12V non-USB</td> <td>743</td> <td>1000</td> </tr> </tbody> </table>	Mode	Typ	Max	Idle @ VIN = 12V	37	45	Idle @ VIN = 5V	77	85	Charging, Standard USB	470	500	Charging, BC1.2 CDP	1350	1500	Charging, BC1.2 DCP	1100	1200	Charging, 5V non-USB	730	750	Charging, 12V non-USB	743	1000
Mode	Typ	Max																							
Idle @ VIN = 12V	37	45																							
Idle @ VIN = 5V	77	85																							
Charging, Standard USB	470	500																							
Charging, BC1.2 CDP	1350	1500																							
Charging, BC1.2 DCP	1100	1200																							
Charging, 5V non-USB	730	750																							
Charging, 12V non-USB	743	1000																							
Available Colors	Twilight Black, Nova White, Healthcare White (DS8178-HC)																								

**Table 3-2** *Technical Specifications (Continued)*

Item	Description
Supported Host Interfaces	USB, RS-232, Keyboard Wedge, RS-485 (IBM 46xx)
Keyboard Support	Supports 97 international keyboards
FIPS Security Certification	Certified Compliant with FIPS 140-2
<b>User Indicators</b>	
Scanner	Multi-function LED (Decode, error, paging status); Beeper (Decode, paging); Dedicated battery status LED; Direct Decode Indicator
Cradle	Multi-function LED (Power, error, charge status)
<b>Performance Characteristics</b>	
Light Source	<b>DS8178-SR/DL</b> <b>DS8178-HC</b> Aiming Pattern: Circular 617nm amber LED Aiming Pattern: Circular 528nm true green LED
Illumination	<b>DS8178-SR/DL</b> <b>DS8178-HC</b> Two 645nm red LEDs Two warm white LEDs
Imager Field of View	48.0° horizontal, 37.0° vertical
Image Sensor	1,280 x 960 pixels
Minimum Print Contrast	16% minimum reflective difference
Skew Tolerance	+/- 60°
Pitch Tolerance	+/- 60°
Roll Tolerance	360°
<b>Image Capture</b>	
Graphics Format Support	Images can be exported as Bitmap, JPEG, or TIFF
Resolution (A4 document)	109 PPI
<b>User Environment</b>	
DS8178-SR/DL Temperatures	Operating Temperature: 32° to 122°F / 0° to 50°C Presentation Mode Operation: 32° to 104°F / 0° to 40°C Charging Temperature: 32° to 104°F / 0° to 40°C
DS8178-HC Temperatures	Operating Temperature (Scanner): 32° to 122°F / 0° to 50°C Presentation Mode Operation: 32° to 104°F / 0° to 40°C Charging Temperature: 32° to 104°F / 0° to 40°C
Storage Temperature	-40° to 158°F / -40° to 70°C
Humidity	5% to 95% RH, non-condensing

### 3 - 10 DS8178 Digital Scanner Product Reference Guide

**Table 3-2** Technical Specifications (Continued)

Item	Description															
Drop Specification (Scanner)	Designed to withstand multiple drops at 6.0 ft./1.8 m to concrete															
Tumble Specification (Scanner)	Designed to withstand 2,000 tumbles in 1.5 ft./0.5 m tumbler Note: 1 tumble = 0.5 cycle															
Ambient Light Immunity	0 to 9000 Foot Candles/0 to 96,840 Lux															
Environmental Sealing	Scanner rated IP42															
<b>Electrostatic Discharge (ESD)</b> - Scanner, Presentation Cradle, Desk/Wall Cradle	+/-15kV Air, +/-8kV Indirect, +/-8kV Direct															
<b>Wireless Connectivity</b>																
Bluetooth Radio	Standard Bluetooth Version 4.0 with BLE: Class 1 330 ft. (100m) and Class 2 33 ft. (10m), Serial Port and HID Profiles															
Adjustable Bluetooth Power	Class 1: Output power adjustable down from 4 dBm in 8 Steps Class 2: Output power adjustable down from 2 dBm in 8 Steps															
<b>Battery (@ 25°C)</b>																
Battery Capacity / Battery Type	2500mAH Li-ion															
Battery Management Type	PowerPrecision+ Smart Battery															
Scans Per Battery Charge (1 scan/sec)	65,000															
Operating Time Per Charge <b>Note:</b> 10 scans in 10 seconds with a 50 second rest.	83 hours															
Typical Charge Time From Empty To Full	<table border="1"> <thead> <tr> <th></th> <th><b>CR8178-SC</b></th> <th><b>CR8178-PC</b></th> </tr> </thead> <tbody> <tr> <td><b>Standard USB</b></td> <td>7 hrs 45 min</td> <td>9 hrs 15 min</td> </tr> <tr> <td><b>BC1.2 USB</b></td> <td>3 hrs</td> <td>3 hrs 15 min</td> </tr> <tr> <td><b>External 5V Source</b></td> <td>4 hrs 30 min</td> <td>5 hrs</td> </tr> <tr> <td><b>External 12V Source</b></td> <td>2 hrs 15 min</td> <td>2 hrs 15 min</td> </tr> </tbody> </table>		<b>CR8178-SC</b>	<b>CR8178-PC</b>	<b>Standard USB</b>	7 hrs 45 min	9 hrs 15 min	<b>BC1.2 USB</b>	3 hrs	3 hrs 15 min	<b>External 5V Source</b>	4 hrs 30 min	5 hrs	<b>External 12V Source</b>	2 hrs 15 min	2 hrs 15 min
	<b>CR8178-SC</b>	<b>CR8178-PC</b>														
<b>Standard USB</b>	7 hrs 45 min	9 hrs 15 min														
<b>BC1.2 USB</b>	3 hrs	3 hrs 15 min														
<b>External 5V Source</b>	4 hrs 30 min	5 hrs														
<b>External 12V Source</b>	2 hrs 15 min	2 hrs 15 min														
<b>Accessories</b>																
Desk/Wall Cradle	CR8178-SC															
Presentation Cradle	CR8178-PC															
Document Capture Stand p/n STND-DC0081W-04	For use with the DS8178-SR/DL in the presentation cradle (CR8178-PC)															
Spare Battery	BTRY-DS81EAB0E-00 (Worldwide) BTRY-DS81EAB0E-00K (India & S. Korea)															

**Table 3-2** *Technical Specifications (Continued)*

Item	Description
<b>Symbol Decode Capability</b>	
1D	UPC/EAN, UPC/EAN with supplements, Bookland EAN, ISSN, UCC Coupon Extended, Code 39, Code 39 Full ASCII, Code 128, ISBT Code 128, Code 93, Codabar/NW7, Code 11, MSI Plessey, UPC/EAN, I 2 of 5, Korean 3 of 5, GS1 DataBar, Base 32 (Italian Pharma), ISBT Concat
2D	PDF417, MicroPDF417, Composite Codes, TLC-39, Aztec, DataMatrix, MaxiCode, QR Code, Micro QR, Chinese Sensible (Han Xin), China GM Code
Postal	Australian Post, US PLANET, Royal Mail 4 State, US POSTNET, KIX (Dutch), UK Postal, Japan Post, UPU 4 State FICS (Post US4), USPS 4 State (Post US3), Canadian Post (Postbar)
<b>Minimum Element Resolution</b>	
Code 39	3.0 mil
Code 128	3.0 mil
DataMatrix	5.0 mil
QR	5.0 mil
<b>Utilities and Management</b>	
123Scan	Programs scanner parameters, upgrades firmware, provides scanned bar code data and prints reports. See <a href="#">Chapter 16, 123Scan and Software Tools</a> .
Symbol Scanner SDK	Generates a fully-featured scanner application, including documentation, drivers, test utilities and sample source code. <a href="http://www.zebra.com/ScannerSDKforWindows">www.zebra.com/ScannerSDKforWindows</a>
Scanner Management Service (SMS)	Remotely manages your Zebra scanner and queries its asset information. <a href="http://www.zebra.com/sms">www.zebra.com/sms</a>
Decode Ranges (Typical)*	See <a href="#">Decode Ranges on page 2-9</a> .

## Cradle Signal Descriptions

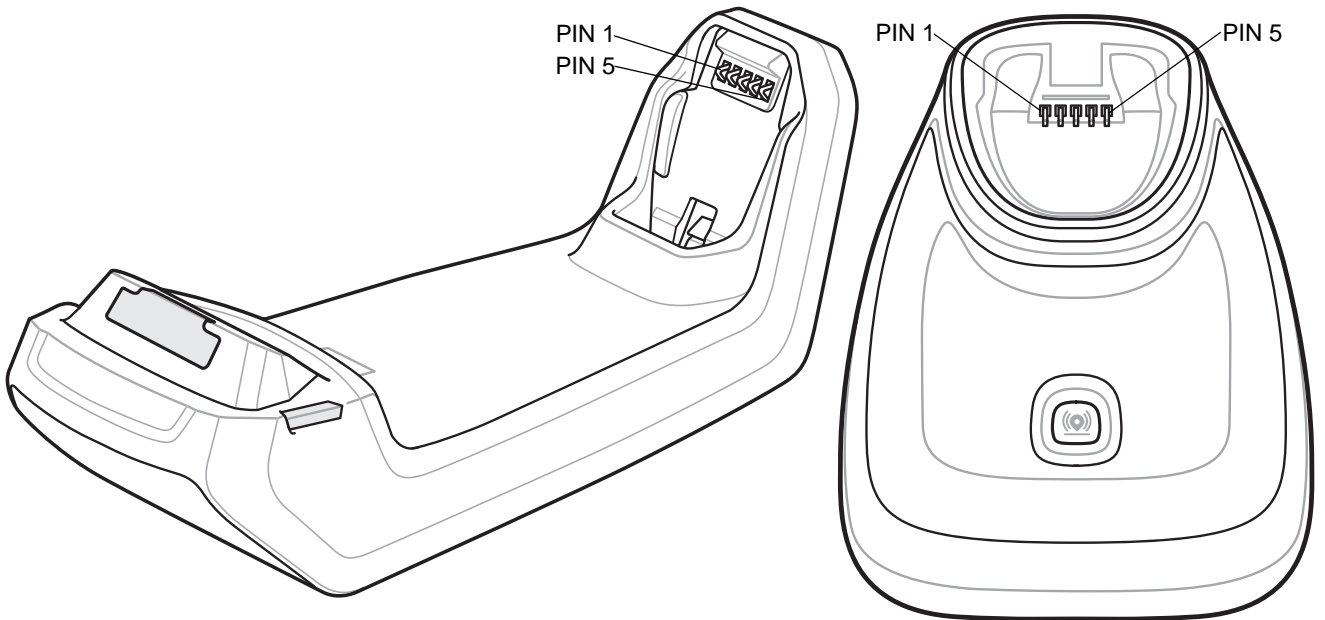

**Figure 3-1** Cradle Pin-outs

The signal descriptions in [Table 3-3](#) apply to the contacts on the digital scanner and are for reference only.

**Table 3-3** Signal Pin-outs

Pin	Function
1	PACK+
2	THERM
3	COM1
4	COM2
5	GND

**Table 3-4** 10 Pin Host Interface Connectors

Pin	USB	RS-232	Keyboard Wedge	RS-485*
1	CABLE_ID		CABLE_ID	CABLE_ID
2	5VDC	5VDC	5VDC	5VDC
3	GND	GND	GND	GND
4		TXD	KBD_CLK	IBM_TXD

**\*Additional RS-485 transceiver hardware located within the cable.**

**Table 3-4** 10 Pin Host Interface Connectors (Continued)

Pin	USB	RS-232	Keyboard Wedge	RS-485*
5	D+	RXD	TERM_DATA	IBM_RXD
6	Short to Pin 1	RTS	KBD_DATA	IBM_DIR
7	D-	CTS	TERM_CLK	
8			1Meg resistor to pin 1	2Meg resistor to pin 1
9				
10	12VDC (optional)	12VDC (optional)	12VDC (optional)	12VDC (optional)
SHELL	Shield	Shield	Shield	Shield

**\*Additional RS-485 transceiver hardware located within the cable.**





# CHAPTER 4 RADIO COMMUNICATIONS

---

## Introduction

This chapter provides information about the modes of operation and features available for wireless communication between the DS8178 cordless digital scanners, cradles and hosts. The chapter also includes the parameters necessary to configure the digital scanner.

The digital scanner ships with the settings shown in the [Radio Communication Default Table on page 4-2](#) (also see [Appendix A, Standard Parameter Defaults](#) for all defaults). If the default values suit requirements, programming is not necessary.

---

## Setting Parameters

To set feature values, scan a single bar code or a short bar code sequence. The settings are stored in non-volatile memory and are preserved even when the scanner powers down.

✓ **NOTE** Most computer monitors allow scanning bar codes directly on the screen. When scanning from the screen, be sure to set the document magnification to a level where you can see the bar code clearly, and bars and/or spaces do not merge.

If not using the default host, select the host type (see each host chapter for specific host information) after the power-up beeps sound. This is only necessary upon the first power-up when connected to a new host.

To return all features to default values, scan a bar code in [Default Parameters on page 5-5](#). Throughout the programming bar code menus, asterisks (\*) indicate default values.



\* Indicates default — \*Enable Parameter — Feature/option  
(1) — Option value

## Scanning Sequence Examples

In most cases, scanning one bar code sets the parameter value. For example, to enable Wi-Fi Friendly Mode, scan the **Enable Wi-Fi Friendly Mode** bar code listed under [Wi-Fi Friendly Mode on page 4-11](#). The scanner issues a fast warble beep and the LED turns green, signifying a successful parameter entry.

Other parameters, such as **Bluetooth Friendly Name**, require scanning several bar codes. See the parameter descriptions for this procedure.

## Errors While Scanning

Unless otherwise specified, to correct an error during a scanning sequence, just re-scan the correct parameter.

## Radio Communications Parameter Defaults

[Table 4-1](#) lists the defaults for radio communication parameters. Change these values in one of two ways:

- Scan the appropriate bar codes in this chapter. The new value replaces the standard default value in memory. To recall default parameter values, see [Default Parameters on page 5-5](#).
- Configure the scanner using the 123Scan configuration program. See [Chapter 16, 123Scan and Software Tools](#).

✓ **NOTE** See [Appendix A, Standard Parameter Defaults](#) for all user preference, host, symbology, and miscellaneous default parameters.

**Table 4-1** Radio Communication Default Table

Parameter	Parameter Number	SSI Number	Default	Page Number
Radio Communications Host Types	N/A	N/A	Cradle Host	<a href="#">4-4</a>
Bluetooth Friendly Name	607	F1h 5Fh	n/a	<a href="#">4-9</a>
Discoverable Mode	610	F1h 62h	General	<a href="#">4-10</a>
Wi-Fi Friendly Mode	1299	F8h 05h 77h	Disable	<a href="#">4-11</a>
Wi-Fi Friendly Channel Exclusion	N/A	N/A	Use All Channels	<a href="#">4-12</a>
Radio Output Power	1324	F8h 05h 2Ch	High	<a href="#">4-13</a>
Link Supervision Timeout	1698	F8h 06h A2h	5 sec	<a href="#">4-14</a>
Bluetooth Radio State	1354	F8h 05h 4Ah	On	<a href="#">4-15</a>
Bluetooth HID - Wait for Connection	1714	F8h 06h B2h	Disable	<a href="#">4-15</a>
HID Features for Apple iOS	1114	F8h 04h 5Ah	Disable	<a href="#">4-16</a>
HID Keyboard Keystroke Delay	N/A	N/A	No Delay (0 msec)	<a href="#">4-17</a>
HID CAPS Lock Override	N/A	N/A	Disable	<a href="#">4-17</a>
HID Ignore Unknown Characters	N/A	N/A	Enable	<a href="#">4-18</a>

**Table 4-1** Radio Communication Default Table (Continued)

Parameter	Parameter Number	SSI Number	Default	Page Number
Emulate Keypad	N/A	N/A	Enable	<a href="#">4-18</a>
Fast HID Keyboard	1361	F8h 05h 51h	Enable	<a href="#">4-19</a>
Quick Keypad Emulation	1362	F8h 05h 52h	Enable	<a href="#">4-19</a>
HID Keyboard FN1 Substitution	N/A	N/A	Disable	<a href="#">4-20</a>
HID Function Key Mapping	N/A	N/A	Disable	<a href="#">4-20</a>
Simulated Caps Lock	N/A	N/A	Disable	<a href="#">4-21</a>
Convert Case	N/A	N/A	No Case Conversion	<a href="#">4-21</a>
Reconnect Attempt Beep Feedback	559	F1h 2Fh	Disable	<a href="#">4-22</a>
Reconnect Attempt Interval	558	F1h 2Eh	30 sec	<a href="#">4-23</a>
Auto-Reconnect	604	F1h 5Ch	Auto-Reconnect Immediately	<a href="#">4-24</a>
Beep on Insertion	288	20h	Enable	<a href="#">4-25</a>
Beep on <BEL>	150	96	Enable	<a href="#">4-25</a>
Modes of Operation (Point-to-Point/Multipoint-to-Point)	538	F1 1A	Point-to-Point	<a href="#">4-26</a>
Parameter Broadcast (Cradle Host Only)	148	94h	Enable	<a href="#">4-27</a>
Pairing Modes	542	F1h 1Eh	Unlocked	<a href="#">4-28</a>
Pairing on Contacts	545	F1h 21h	Enable	<a href="#">4-29</a>
Toggle Pairing	1322	F8h 05h 2Ah	Disable	<a href="#">4-30</a>
Connection Maintenance Interval	N/A	N/A	15 Minutes	<a href="#">4-31</a>
Batch Mode	544	F1h 20h	Normal (Do Not Batch Data)	<a href="#">4-34</a>
Persistent Batch Storage	1399	F8h 05h 77h	Disable	<a href="#">4-35</a>
Page Button	746	F1h EAh	Enable	<a href="#">4-36</a>
Page Mode	1364	F8h 05h 54h	Page Simple	<a href="#">4-37</a>
Page Stage Timeout	1365	F8h 05h 55h	30 Seconds	<a href="#">4-37</a>
Bluetooth Classic and/or Low Energy (Cradle Host Only)	1355	F8h 05h 4Bh	Classic and Low Energy	<a href="#">4-38</a>
PIN Code (Set and Store)	552	F1h 28h	12345	<a href="#">4-39</a>

**Table 4-1** Radio Communication Default Table (Continued)

Parameter	Parameter Number	SSI Number	Default	Page Number
Variable Pin Code	608	F1h 60h	Static (Default PIN code is 12345)	<a href="#">4-39</a>
Bluetooth Security Levels	1393	F8h 05h 71h	Low	<a href="#">4-40</a>

## Wireless Beeper Definitions

When the digital scanner scans the pairing bar code it issues various beep sequences indicating successful or unsuccessful operations. See [Beeper and LED Indications on page 2-1](#) for all beep sequences and LED displays including those which occur during pairing operations.

## Radio Communication Host Types

To set up the digital scanner for communication with a cradle, or to use standard Bluetooth profiles, scan the appropriate host type bar code below.

### Bluetooth Classic vs. Low Energy Bluetooth

Low Energy (LE) Bluetooth has a smaller RF footprint which significantly improves Wi-Fi co-existence. However, LE Bluetooth is up to 7 times slower than Classic Bluetooth (0.27 Mbps versus 0.7-2.1 Mbps), so data intensive activities such as firmware update can take significantly longer.

### Cradle

Select this host type when connecting a scanner to a communication cradle (DS8178-SC or DS8178-PC).

✓ **NOTE** The scanner automatically tries to reconnect to a remote device when a disconnection occurs that is due to the radio losing communication. See [Auto-Reconnect Feature on page 4-22](#) for more information.

To establish a connection (for initial setup only):

1. Scan the **Cradle-Bluetooth Classic** or **Cradle-Low Energy** bar code.
2. Scan the pairing bar code on the cradle or place the scanner in the cradle.

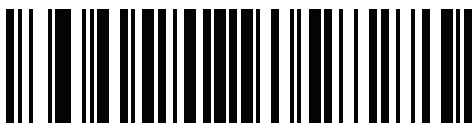

**Cradle Bluetooth Classic**

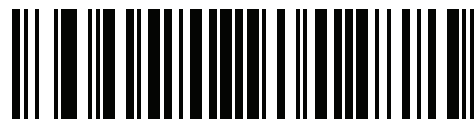

**Cradle Bluetooth Low Energy**

## Human Interface Device (HID) Keyboard Emulation

Select this host type when connecting to a PC/tablet/phone emulating a Bluetooth keyboard.

- **HID Bluetooth Classic** - Enables the host and scanner to communicate using the HID Keyboard Profile over Bluetooth Classic radio. The scanner(s) is discoverable (Slave Mode) and also supports Master Mode.

To establish a connection (initial setup only):

1. Scan the **HID Bluetooth Classic** bar code.
2. Connect to Master Mode or Slave Mode.
  - Master Mode - Scan a pairing bar code with the host device's MAC address.
  - Slave Mode - From the host, discover Bluetooth devices and select your scanner from the discovered device list.
- **HID Bluetooth Low Energy (Discoverable)** - Enables the host to establish a HID Keyboard Profile connection with the scanner over Bluetooth Low Energy radio. The scanner(s) is discoverable (Slave Mode).

To establish a connection (initial setup only):

1. Scan the **HID Bluetooth Low Energy (Discoverable)** bar code.
2. From the host discover Bluetooth devices and select your scanner from the discovered device list.

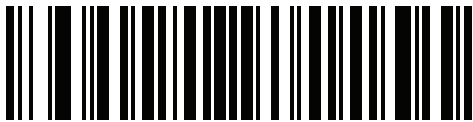

**HID Bluetooth Classic**

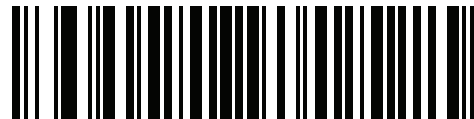

**HID Bluetooth Low Energy (Discoverable)**

## Simple Serial Interface (SSI)

Select this host type when connecting to a Zebra mobile device or PC/tablet/phone running a Zebra scanner SDK app.

- **SSI BT Classic (Non-discoverable)** - Enables communication with Zebra mobile computers. It enables the scanner(s) to establish a connection with the host over Bluetooth Classic radio. The scanner is NOT in discoverable (Master Mode).

To establish a connection (initial setup only):

1. Scan the **SSI BT Classic (Non-discoverable)** bar code.
2. Scan a pairing bar code with the host device's MAC address.

✓ **NOTE** Additional steps may be necessary depending on host's Bluetooth stack.

- **SSI BT Classic (Discoverable)** - Enables communication with Scanner SDK for Android generated apps. It enables the host to establish a connection with the scanner over Bluetooth Classic radio. The scanner is in discoverable (Slave Mode).

To establish a connection (initial setup only):

1. Scan the **SSI BT Classic (Discoverable)** bar code.
2. From the host, discover Bluetooth devices and select your scanner from your discovered device list.

- **SSI BT LE** - Enables communication with apps generated using the Zebra's Scanner SDKs for iOS and Android. It enables the host to establish a connection with the scanner over a Bluetooth Low Energy radio. The scanner is in discoverable (Slave Mode) and also supports Master Mode.
  - Free Demonstration App - Download Scanner Control App for iOS from the App Store.
  - Free Demonstration App - Download Scanner Control App for Android from the Google Play Store.
- **SSI BT with MFi (iOS Support)** - Enables communication with Scanner SDK for iOS generated apps. This enables an Apple device and scanner to communicate over Bluetooth Classic radio. The scanner is discoverable (Slave Mode) and also supports Master Mode.
  - Free Demonstration App - Download Scanner Control App for iOS from the App Store.

## Simple Serial Interface (continued)

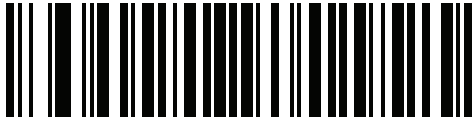

**SSI BT Classic (Non-Discoverable)**

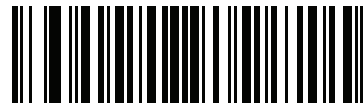

**SSI BT Classic (Discoverable)**

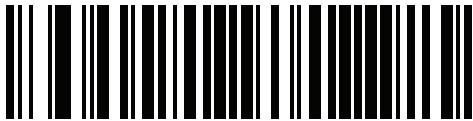

**SSI BT LE**



**SSI BT with MFi (iOS Support)**

## Serial Port Profile (SPP)

Select this host type when connecting to a PC/tablet/phone using a Bluetooth serial connection.

- **SPP BT Classic (Non-Discoverable)** - Enables the scanner to establish a Serial Port Profile (SPP) connection with the host over Bluetooth Classic radio. The scanner is NOT discoverable (Master Mode).  
To establish a connection (initial setup only):
  1. Scan the **SPP BT Classic (Non-discoverable)** bar code.
  2. Scan a pairing bar code with the MAC address of the host device.
- **SPP BT Classic (Discoverable)** - Enables the host to establish a Serial Port Profile (SPP) connection with the scanner over Bluetooth Classic radio. The scanner is discoverable (Slave Mode).  
To establish a connection (initial setup only):
  1. Scan the **SPP BT Classic (Discoverable)** bar code.
  2. From the host, discover Bluetooth devices and select your scanner from the discovered device list.

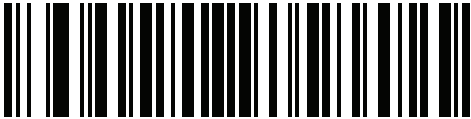

**SPP BT Classic (Non-Discoverable)**

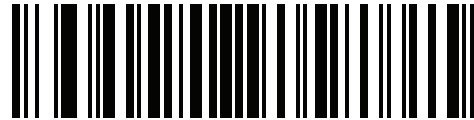

**SPP BT Classic (Discoverable)**



## Bluetooth Technology Profile Support

With Bluetooth Technology Profile Support, the cradle is not required for wireless communication. The digital scanner communicates directly to the host using Bluetooth technology. The digital scanner supports the standard Bluetooth Serial Port Profile (SPP) and HID Profiles which enable the digital scanner to communicate with other Bluetooth devices that support these profiles.

- SPP - the digital scanner connects to the PC/host via Bluetooth and performs like there is a serial connection.
- HID - the digital scanner connects to the PC/host via Bluetooth and performs like a keyboard.

## Master/Slave Set Up

The digital scanner can be set up as a Master or Slave. When the digital scanner is set up as a Slave, it is discoverable and connectible to other devices. When the digital scanner is set up as a Master, the Bluetooth address of the remote device to which a connection is requested is required. A pairing bar code with the remote device address must be created and scanned to attempt a connection to the remote device. See the [Pairing Bar Code Format on page 4-30](#) for information about creating a pairing bar code.

### Master

When the digital scanner is set up as a Master (SPP), it initiates the radio connection to a slave device. Initiating the connection is done by scanning a pairing bar code for the remote device (see [Pairing Bar Code Format on page 4-30](#)).

### Slave

When the digital scanner is set up as a Slave device (SPP), the digital scanner accepts an incoming connection request from a remote device.

✓ **NOTE** The number of digital scanners is dependent on the host capability.

---

## Bluetooth Friendly Name

### Parameter # 607 (SSI # F1h 5Fh)

You can set a meaningful name for the digital scanner that appears in the application during device discovery. The default name is the digital scanner name followed by its serial number, e.g., **DS8178 123456789ABCDEF**. Scanning **Set Defaults** reverts the digital scanner to this name; use custom defaults to maintain the user-programmed name through a **Set Defaults** operation.

To set a new Bluetooth Friendly Name, scan the following bar code, then scan up to 23 characters from [Appendix H, Alphanumeric Bar Codes](#). If the name contains less than 23 characters, Then scan **End of Message** in the [Advanced Data Formatting Guide](#).

✓ **NOTE** If your application allows you to set a device name, this takes precedence over the Bluetooth Friendly Name.



Bluetooth Friendly Name

## Discoverable Mode

### Parameter # 610 (SSI # F1h 62h)

Select a discoverable mode based on the device initiating discovery:

- Select **General Discoverable Mode** when initiating connection from a PC.
- Select **Limited Discoverable Mode** when initiating connection from a mobile device (e.g., Q), and the device does not appear in General Discoverable Mode. Note that it can take longer to discover the device in this mode.

The device remains in Limited Discoverable Mode for 30 seconds, and green LEDs flash while in this mode. It is then non-discoverable. To re-active Limited Discoverable Mode, press the trigger.

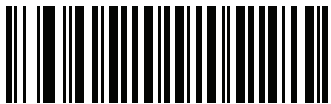

**\*General Discoverable Mode  
(0)**



**Limited Discoverable Mode  
(1)**

## Wi-Fi Friendly Mode

Scanners configured for Wi-Fi friendly mode behave as follows:

- The scanner remains in sniff mode, and exits sniff mode only during firmware update.
- If any Wi-Fi channel is excluded from the hopping sequence, AFH turns off.
- Scanner (and cradle) avoid the selected Wi-Fi channels after establishing connection.

### Notes

- If using this feature, configure all scanners in the area for Wi-Fi friendly mode.
- By default, no Wi-Fi channels are excluded.
- Since Bluetooth requires a minimum of 20 channels when Wi-Fi channels 1, 6, and 11 are excluded, a smaller number of channels are cut from the hopping sequence.
- Updating Wi-Fi friendly settings before Bluetooth connection is recommended.

Scan a bar code below to enable or disable **Wi-Fi Friendly Mode**, then see [Wi-Fi Friendly Channel Exclusion](#) to select any channels to exclude.



\*Disable Wi-Fi Friendly Mode

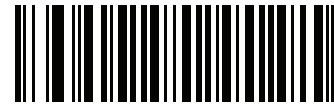

Enable Wi-Fi Friendly Mode

## Wi-Fi Friendly Channel Exclusion

### Wi-Fi Channel Exclusion

Select the channels to exclude:

- **Exclude Wi-Fi channel 1:** Bluetooth channels 0-21 are excluded from hopping sequence (2402-2423 MHz).
- **Exclude Wi-Fi channel 6:** Bluetooth channels 25-46 are excluded from hopping sequence (2427 - 2448 MHz).
- **Exclude Wi-Fi channel 11:** Bluetooth channels 50-71 are excluded from hopping sequence (2452 - 2473 MHz).
- **Exclude Wi-Fi channel 1, 6 and 11:** Bluetooth channels 2-19 (2404-2421 MHz), 26-45 (2428 - 2447 MHz) and 51-69 (2453 - 2471 MHz) are excluded from hopping sequence.
- **Exclude Wi-Fi channels 1 and 6:** Bluetooth channels 0-21 (2402-2423 MHz) and 25-46 (2427 - 2448 MHz) are excluded from hopping sequence.
- **Exclude Wi-Fi channels 1 and 11:** Bluetooth channels 0-21 (2402-2423 MHz) and 50-71 (2452 - 2473 MHz) are excluded from hopping sequence.
- **Exclude Wi-Fi channel 6 and 11:** Bluetooth channels 25-46 (2427 - 2448 MHz) and 50-71 (2452 - 2473 MHz) are excluded from hopping sequence.

### Wi-Fi Friendly Channel Exclusion (continued)



**\*Use All Channels (Standard AFH)**



**Exclude Wi-Fi Channel 1**

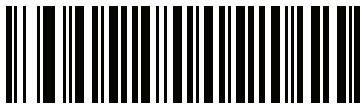

**Exclude Wi-Fi Channel 6**

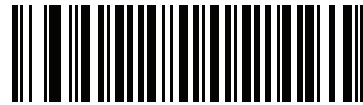

**Exclude Wi-Fi Channel 11**



**Exclude Wi-Fi Channels 1, 6, and 11**

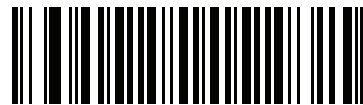

**Exclude Wi-Fi Channels 1 and 6**



**Exclude Wi-Fi Channels 1 and 11**



**Exclude Wi-Fi Channels 6 and 11**

---

## Radio Output Power

### Parameter # 1324 (SSI # F8h 05h 2Ch)

The DS8178 uses a Class 1 Bluetooth radio. Optionally, reduce the radio output power to restrict the transmission range and reduce the effect of the radio on neighboring wireless systems.

✓ **NOTE** Bluetooth stack resets on power change and the device loses connection.

Scan a bar code to select the desired power mode.

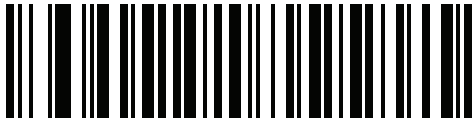

\* High Power Setting  
(0)

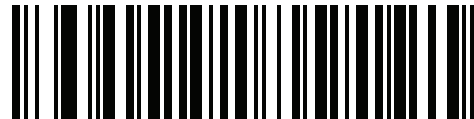

Medium Power Setting  
(1)

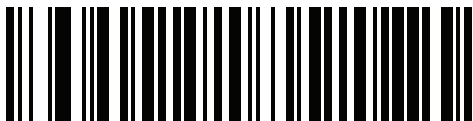

Low Power Setting  
(2)

## Link Supervision Timeout

### Parameter # 1698 (SSI # F8h 06h A2h)

Link supervision timeout controls how quickly the scanner senses that the Bluetooth radio lost connection to the remote device. A lower value helps prevent data loss at the edge of the operating range while a larger value helps prevent disconnects due to the remote device not responding in time. If you are experiencing occasional disconnects and the scanner is able to reconnect, increase the link supervision timeout value.

✓ **NOTE** The scanner only controls Link Supervision Timeout in Master Mode.

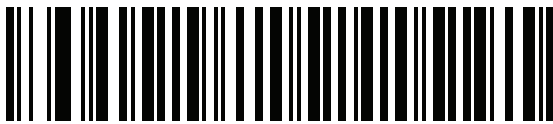

**.5 Seconds**

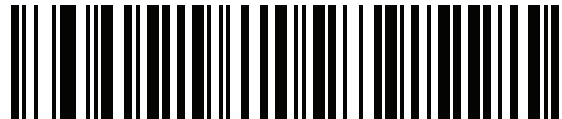

**2 Seconds**

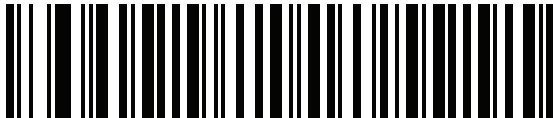

**\* 5 Seconds**

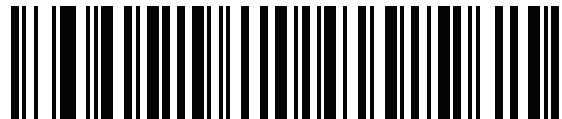

**10 Seconds**

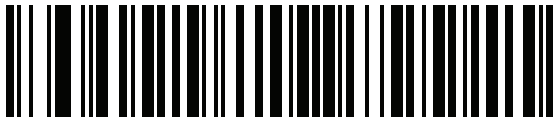

**20 Seconds**

---

## Bluetooth Radio State

### Parameter # 1354 (SSI # F8h 05h 4Ah)

✓ **NOTE** The only option to turn the radio on after it is turned off on the cradle, is through the host.

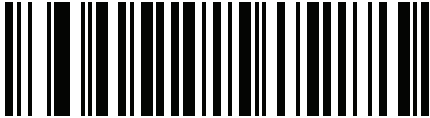

Bluetooth Radio Off

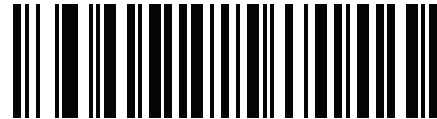

\*Bluetooth Radio On

---

## HID Host Parameters

The digital scanner supports virtual keyboard emulation for the Apple iOS, and keyboard emulation over the Bluetooth HID profile. In this mode the digital scanner can interact with Bluetooth enabled hosts supporting the HID profile as a Bluetooth keyboard. Scanned data is transmitted to the host as keystrokes.

### Bluetooth HID - Wait for Connection

#### Parameter # 1714

✓ **NOTE** This setting applies to first time connection only, when scanner connects to remote device by scanning a pairing bar code.

When disabled, the scanner issues a connection after scanning a pairing bar code. This is the recommended setting for Android devices.

When enabled, the scanner waits for a connection request from a remote device, after scanning a pairing bar code and initiating pairing. This is the recommended setting for Windows devices

## Bluetooth HID - Wait for Connection (continued)



\* Disable  
(0)

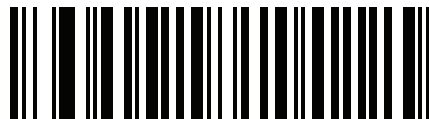

Enable  
(1)

## HID Features for Apple iOS

### Parameter # 1114 (SSI # F8h 04h 5Ah)

This option works with Apple iOS devices to enable the opening and closing of the iOS virtual keyboard by double-pressing the trigger.

✓ **NOTE** When this feature is enabled, the digital scanner may be incompatible with non-Apple iOS devices.



\*Disable  
(0)



Enable  
(1)



## HID Keyboard Keystroke Delay

This parameter sets the delay, in milliseconds, between emulated keystrokes. Scan a bar code below to increase the delay when the HID host requires a slower transmission of data.



**\*No Delay (0 msec)**



**Medium Delay (20 msec)**



**Long Delay (40 msec)**

## HID CAPS Lock Override

When enabled, the case of the data is preserved regardless of the state of the caps lock key. This setting is always enabled for the “Japanese, Windows (ASCII)” keyboard type and can not be disabled.



**\*Do Not Override Caps Lock Key  
(Disable)**



**Override Caps Lock Key  
(Enable)**

## HID Ignore Unknown Characters

This option applies only to the HID Keyboard Emulation device and IBM device. Unknown characters are characters the host does not recognize. When **Send Bar Codes With Unknown Characters** is selected, all bar code data is sent except for unknown characters, and no error beeps sound. When **Do Not Send Bar Codes With Unknown Characters** is selected, bar code data is sent up to the first unknown character, then the digital scanner issues an error beep.



**\*Send Bar Codes With Unknown Characters  
(Enable)**



**Do Not Send Bar Codes With Unknown Characters  
(Disable)**

## Emulate Keypad

When enabled, all characters are sent as ASCII sequences over the numeric keypad. For example, ASCII A is sent as "ALT make" 0 6 5 "ALT Break."



**Disable Keypad Emulation**



**\* Enable Keypad Emulation**

## Fast HID Keyboard

### Parameter # 1361 (SSI # F8h 05h 51h)

This option transmits Bluetooth HID keyboard data at a faster rate.

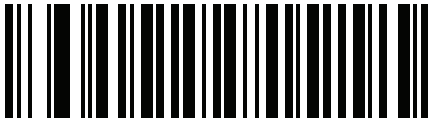

Fast HID Disable



\*Fast HID Enable

## Quick Keypad Emulation

### Parameter # 1362 (SSI # F8h 05h 52h)

- ✓ **NOTE** This option applies only to a HID Keyboard Emulation Device which has **Emulate Keypad** enabled (see [Emulate Keypad on page 4-18](#)).

This parameter enables a quicker method of keypad emulation where ASCII sequences are only sent for ASCII characters not found on the keyboard.

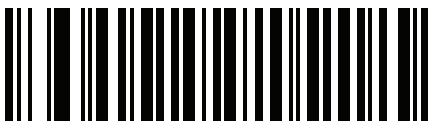

Quick Keypad Emulation Disable



\*Quick Keypad Emulation Enable

## HID Keyboard FN1 Substitution

When enabled, this parameter allows replacement of any FN1 character in an EAN128 bar code with a Key Category and value chosen by the user. See [FN1 Substitution Values on page 5-40](#) to set the Key Category and Key Value.



**\*Disable Keyboard FN1 Substitution**



**Enable Keyboard FN1 Substitution**

## HID Function Key Mapping

ASCII values under 32 are normally sent as control-key sequences. When this parameter is enabled, the keys in bold are sent in place of the standard key mapping (see [Table I-1 on page I-1](#)).

Table entries that do not have a bold entry remain the same whether or not this parameter is enabled.



**\*Disable Function Key Mapping**



**Enable Function Key Mapping**

## Simulated Caps Lock

When enabled, the digital scanner inverts upper and lower case characters on the digital scanner bar code as if the Caps Lock state is enabled on the keyboard. This inversion is done regardless of the current state of the keyboard Caps Lock state.



**\*Disable Simulated Caps Lock**



**Enable Simulated Caps Lock**

## Convert Case

When enabled, the digital scanner converts all bar code data to the selected case.



**\*No Case Conversion**



**Convert All to Upper Case**



**Convert All to LowerCase**

## Auto-Reconnect Feature

When in SPP Master, Cradle Host Mode, and Bluetooth Keyboard Emulation, the digital scanner automatically tries to reconnect to a remote device when a disconnection occurs that is due to the radio losing communication. This can happen if the digital scanner goes out of range with the remote device, or if the remote device powers down. The digital scanner tries to reconnect for the period of time specified by the Reconnect Attempt Interval setting. During that time the green LED continues to blink.

If the auto-reconnect process fails due to page time-outs, the digital scanner sounds a page timeout beep (long low/long high) and enters low power mode. The auto-reconnect process can be re-started by pulling the digital scanner trigger.

If the auto-reconnect process fails because the remote device rejects the connection attempt, the digital scanner sounds a connection reject beep sequence (see [Wireless Beeper Definitions on page 4-4](#)) and deletes the remote pairing address. If this happens, a pairing bar code must be scanned to attempt a new connection to the remote device.

- ✓ **NOTE** If a bar code is scanned while the auto-reconnect sequence is in process, a transmission error beep sequence sounds and the data is not transmitted to the host. After a connection is reestablished, normal scanning operation returns. For error beep sequence definitions, see [After the trigger is held for three seconds the battery LED gauge remain active for four seconds after trigger release. on page 2-1](#).

The digital scanner has memory available for storing a remote Bluetooth address for each Master Mode (SPP, Cradle). When switching between these modes, the digital scanner automatically tries to reconnect to the last device it was connected to in that mode.

- ✓ **NOTE** Switching between Bluetooth host types by scanning a host type bar code ( [page 4-4](#)) causes the radio to be reset. Scanning is disabled during this time. It takes several seconds for the digital scanner to re-initialize the radio at which time scanning is enabled.

## Reconnect Attempt Beep Feedback

### Parameter # 559 (SSI # F1h 2Fh)

When a digital scanner disconnects as it goes out of range, it immediately attempts to reconnect. While the digital scanner attempts to reconnect, the green LED continues to blink. If the auto-reconnect process fails, the digital scanner emits a page timeout beep (long low/long high) and stops blinking the LED. The process can be restarted by pulling the trigger.

The Beep on Reconnect Attempt feature is disabled by default. When enabled, the digital scanner emits 5 short high beeps every 5 seconds while the re-connection attempt is in progress. Scan a bar code below to enable or disable Beep on Reconnect Attempt.



\*Disable Beep on Reconnect Attempt  
(0)



Enable Beep on Reconnect Attempt  
(1)

## Reconnect Attempt Interval

### Parameter # 558 (SSI # F1h 2Eh)

When a digital scanner disconnects as it goes out of range, it immediately attempts to reconnect for the default time interval of 30 seconds. This time interval can be changed to one of the options below.

To set the Reconnect Attempt Interval, scan one of the bar codes below.



**\*Attempt to Reconnect for 30 Seconds  
(6)**



**Attempt to Reconnect for 1 Minute  
(12)**



**Attempt to Reconnect for 5 Minutes  
(60)**



**Attempt to Reconnect for 30 Minutes  
(360)**



**Attempt to Reconnect for 1 Hour  
(720)**



**Attempt to Reconnect Indefinitely  
(0)**

## Auto-Reconnect

### Parameter # 604 (SSI # F1h 5Ch)

In Bluetooth Keyboard Emulation (HID) mode, SPP Master, and Cradle Host Mode, select a re-connect option for when the digital scanner loses its connection with a remote device:

- **Auto-Reconnect on Bar Code Data:** The digital scanner auto-reconnects when you scan a bar code. With this option, a delay can occur when transmitting the first characters. The digital scanner sounds a decode beep upon bar code scan, followed by a connection, a page timeout, a rejection beep, or a transmission error beep. Select this option to optimize battery life on the digital scanner and mobile device. Note that auto-reconnect does not occur on rejection and cable unplug commands.
- **Auto-Reconnect Immediately:** When the digital scanner loses connection, it attempts to reconnect. If a page timeout occurs, the digital scanner attempts reconnect on a trigger pull. Select this option if the digital scanner battery life is not an issue and you do not want a delay to occur when the first bar code is transmitted. Note that auto-reconnect does not occur on rejection and cable unplug commands.
- **Disable Auto-Reconnect:** When the digital scanner loses connection, you must re-establish it manually.

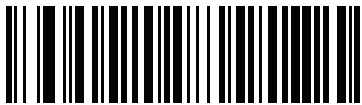

**Auto-Reconnect on Bar Code Data  
(1)**

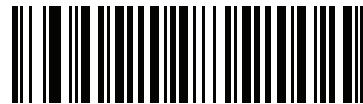

**\*Auto-Reconnect Immediately  
(2)**

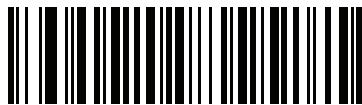

**Disable Auto-Reconnect  
(0)**

---

## Out of Range Indicator

An out of range indicator can be set by scanning [Enable Beep on Reconnect Attempt \(1\) on page 4-22](#) and extending the time using the [Reconnect Attempt Interval on page 4-23](#).

For example, with Beep on Reconnect Attempt disabled while the digital scanner loses radio connection when it is taken out of range, the digital scanner attempts to reconnect silently during the time interval set by scanning a Reconnect Attempt Interval.

When Beep on Reconnect Attempt is enabled, the digital scanner emits 5 high beeps every 5 seconds while the re-connection attempt is in progress. If the Reconnect Attempt Interval is adjusted to a longer period of time, such as 30 minutes, the digital scanner emits 5 high beeps every 5 seconds for 30 minutes providing an out of range indicator.



---

## Beep on Insertion

### Parameter # 288 (SSI # 20h)

When a digital scanner is inserted into a cradle and detects power, it emits a short low beep. This feature is enabled by default.

To enable or disable beeping on insertion, scan the appropriate bar code below.



**\*Enable Beep on Insertion  
(1)**



**Disable Beep on Insertion  
(0)**

---

## Beep on <BEL>

### Parameter # 150 (SSI # 96h)

When this parameter is enabled, the scanner issues a beep when a <BEL> character is detected on the serial line. <BEL> is issued to gain a user's attention to an illegal entry or other important events.



**NOTE** This parameter only applies to SPP (Serial Port Profile). The RS-232 interface on the cradle has this feature when Beep on <BEL> is enabled.

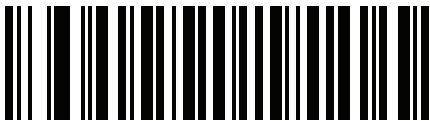

**\*Beep on <BEL> Enable**



**Beep on <BEL> Disable**

---

## Digital Scanner(s) To Cradle Support

### Modes of Operation

#### Parameter # 538 (SSI # F1h 1Ah)

The charging cradle with radio supports two radio communication modes of operation, allowing the digital scanner to communicate wirelessly:

- Point-to-Point
- Multipoint-to-Point.

#### Point-to-Point Communication

In Point-to-Point communication mode, the cradle allows one digital scanner to connect to it at a time. In this mode, the digital scanner is paired to the cradle either by insertion into the cradle (if pairing on contacts is enabled, [page 4-29](#)), or by scanning the **PAIR** bar code. Communication can be locked, unlocked (default), or in a lock override state (see [Pairing Modes on page 4-27](#)). In locked mode, locking intervals must be set by scanning a connection maintenance interval bar code beginning on [page 4-31](#).

To activate this mode of operation, scan **Point-to-Point**.

#### Multipoint-to-Point Communication

Multipoint-to-Point communication mode allows up to seven digital scanners to pair to one cradle.

To activate this mode, the first digital scanner connected to the cradle must scan the **Multipoint-to-Point** bar code. This mode allows a parameter broadcast ( [page 4-27](#) ) feature that forwards parameter bar code settings to all connected digital scanners. In this mode, programming one digital scanner applies the settings to all connected digital scanners.

To select Point-to-Point or Multipoint-to-Point mode, scan the appropriate bar code.



**Multipoint-to-Point Mode**  
(1)



**\*Point-to-Point Mode**  
(0)

## Parameter Broadcast (Cradle Host Only)

### Parameter # 148 (SSI # 94h)

- ✓ **NOTE** When Parameter Broadcast is disabled on one scanner in the piconet, **Parameter Broadcast** is disabled on all scanners in the piconet.

When in multipoint-to-point mode, enable Parameter Broadcast to broadcast all parameter bar codes scanned to all other digital scanners in the piconet. If disabled, parameter bar codes are processed by the individual digital scanner only, and the digital scanner ignores parameters broadcast from other digital scanners or from the cradle.



\*Enable Parameter Broadcast  
(1)



Disable Parameter Broadcast  
(0)

## Pairing

Pairing is the process by which a digital scanner initiates communication with a cradle. Scanning **Multipoint-to-Point** activates multi digital scanner-to-cradle operation and allows up to seven digital scanners to pair to one cradle.

To pair the digital scanner with the cradle, scan the pairing bar code. A high/low/high/low beep sequence indicates that the pairing bar code was decoded. When a connection between the cradle and digital scanner is established, a low/high beep sounds.

- ✓ **NOTE**
1. The pairing bar code that connects the digital scanner to a cradle is unique to each cradle.
  2. Do not scan data or parameters until pairing completes.
  3. Only when the digital scanner is paired to the cradle, it automatically tries to reconnect to a remote device when a disconnection occurs that is due to the radio losing communication. For more information see [Auto-Reconnect Feature on page 4-22](#).

## Pairing Modes

### Parameter # 542 (SSI # F1h 1Eh)

When operating with the cradle, two modes of pairing are supported:

- **Locked Pairing Mode** - When a cradle is paired (connected) to the digital scanner (or up to seven digital scanners in Multipoint-to-Point mode), any attempt to connect a different digital scanner, by either scanning the **PAIR** bar code on the cradle or by inserting it into the cradle with the pairing on contacts feature enabled ( [page 4-29](#)), is rejected. The currently connected digital scanner(s) maintain connection. In this mode, you must set a [Connection Maintenance Interval on page 4-31](#).

- **Unlocked Pairing Mode** - Unlocking works in Point-to-Point mode only. Pair (connect) a new digital scanner to a cradle at any time by either scanning the **PAIR** bar code on the cradle or by inserting it into the cradle with the pairing on contacts feature enabled. This unpairs the previous digital scanner from the cradle.

To set the cradle pairing mode, scan the appropriate bar code below.



**\*Unlocked Pairing Mode  
(0)**



**Locked Pairing Mode  
(1)**

### Lock Override



**NOTE** Lock Override is applicable in Point-to-Point mode only (does not apply to Multipoint-to-Point mode). In Multipoint-to-Point mode, if seven scanners are connected, the scanners must be disconnected for a new scanner to connect.

**Lock Override** overrides a locked digital scanner base pairing and connects a new digital scanner. To use **Lock Override**, scan the bar code below, followed by the pairing bar code on the cradle.



**Lock Override**

## Pairing Methods

### Parameter # 545 (SSI # F1h 21h)

There are two pairing methods. The default method allows the digital scanner and cradle to pair (connect) when the pairing bar code on the cradle is scanned. A second method pairs the digital scanner and cradle when the digital scanner is inserted in the cradle. To enable this feature, scan **Enable Pair On Contacts** below. With this feature enabled it is not necessary to scan the pairing bar code on the cradle. If the pairing is successful, a low/high connection beep sequence sounds a few seconds after the digital scanner is placed in the cradle. See [Wireless Beeper Definitions on page 4-4](#) for other beep sequences.

To enable or disable pairing on contacts, scan the appropriate bar code below.



**\*Enable Pair On Contacts  
(1)**



**Disable Pair on Contacts  
(0)**

## Unpairing

Unpair the digital scanner from the cradle or PC/host to make the cradle available for pairing with another digital scanner. Scan the bar code below to disconnect the digital scanner from its cradle/PC host.

An unpairing bar code is also included in the *DS8178 Quick Reference Guide*.



**Unpairing**

## Toggle Pairing

### Parameter # 1322 (SSI # F8h 05h 2Ah)

If the scanner is configured for Toggle Pairing, scanning the Toggle Pairing bar code a second time will unpair the scanner.



**\*Toggle Pairing Disable**

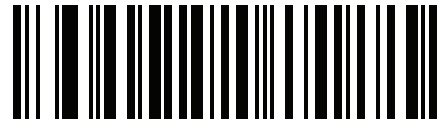

**Toggle Pairing Enable**

## Pairing Bar Code Format

When the digital scanner is configured as an SPP Master, you must create a pairing bar code for the remote Bluetooth device to which the digital scanner can connect. The Bluetooth address of the remote device must be known. Pairing bar codes are Code 128 bar codes and are formatted as follows:

<Fnc 3>Bxxxxxxxxxxx

where:

- **B** (or **LNKB**) is the prefix
- **xxxxxxxxxxx** represents the 12-character Bluetooth address.

## Pairing Bar Code Example

If the remote device to which the digital scanner can connect has a Bluetooth address of 11:22:33:44:55:66, then the pairing bar code is:



## Connection Maintenance Interval

- ✓ **NOTE** The Connection Maintenance Interval only applies in locked pairing mode (see [page 4-27](#)).

When a digital scanner disconnects from a cradle due to a Link Supervision Timeout, the digital scanner immediately attempts to reconnect to the cradle for 30 seconds. If the auto-reconnect process fails, it can be restarted by pulling the digital scanner trigger.

To guarantee that a disconnected digital scanner can reconnect when it comes back in range, the cradle reserves the connection for that digital scanner for a period of time defined by the Connection Maintenance Interval. If the cradle is supporting the maximum three digital scanners and one digital scanner disconnects, a fourth digital scanner cannot pair to the cradle during this interval. To connect another digital scanner: either wait until the connection maintenance interval expires then scan the **PAIR** bar code on the cradle with the new digital scanner; or, scan **Lock Override** ([page 4-28](#)) with the new digital scanner then scan the **PAIR** bar code on the cradle.

- ✓ **NOTE** The cradle stores the remote pairing address of each digital scanner in memory regardless of the digital scanner condition (e.g., discharged battery). When you want to change the digital scanners paired to the cradle, unpair each digital scanner currently connected to the cradle by scanning the [Unpairing](#) bar code prior and reconnect each appropriate digital scanner by scanning the PAIR bar code on the cradle.

## Considerations

The system administrator determines the Connection Maintenance Interval. A shorter interval allows new users to gain access to abandoned connections more quickly, but causes problems if users leave the work area for extended periods. A longer interval allows existing users to leave the work area for longer periods of time, but ties up the system for new users.

To avoid this conflict, users who are going off-shift can scan the unpair bar code on [page 4-29](#) to ignore the Connection Maintenance Interval and make the connection immediately available.

To set the Connection Maintenance Interval, scan one of the bar codes below.



**\*Set Interval to 15 Minutes  
(0)**



**Set Interval to 30 Minutes  
(1)**



**Set Interval to 60 Minutes  
(2)**

### Connection Maintenance Interval (continued)



**Set Interval to 2 Hours  
(3)**



**Set Interval to 4 Hours  
(4)**



**Set Interval to 8 Hours  
(5)**



**Set Interval to 24 Hours  
(6)**



**Set Interval to Forever  
(7)**



## Batch Mode

### Parameter # 544 (SSI # F1h 20h)



**IMPORTANT** Batch mode does not apply to SPP Slave Mode.

The digital scanner supports five versions of batch mode. When the digital scanner is configured for any of the batch modes, it attempts to store bar code data (not parameter bar codes) until transmission is initialized, or the maximum number of bar codes are stored. When a bar code is saved successfully, a good decode beep sounds and the LED flashes green. If the digital scanner is unable to store a new bar code, a low/high/low/high out of memory beep sounds. (See page 2-1 for all beeper and LED definitions.)

In all modes, calculate the amount of data (number of bar codes) the digital scanner can store as follows:

Number of storable bar codes = 30,720 bytes of memory / (number of characters in the bar code + 3).

- ✓ **NOTE** If the batch mode selection is changed while there is batched data, the new batch mode takes effect only after all the previously batched data is sent.

### Modes of Operation

- **Normal (default)** - Do not batch data. The digital scanner attempts to transmit every scanned bar code.
- **Out of Range Batch Mode** - The digital scanner starts storing bar code data when it loses its connection to a remote device (for example, when a user holding the digital scanner walks out of range). Data transmission is triggered by reestablishing the connection with the remote device (for example, when a user holding the digital scanner walks back into range).
- **Standard Batch Mode** - The digital scanner starts storing bar code data after **Enter Batch Mode** is scanned. Data transmission is triggered by scanning **Send Batch Data**.
- ✓ **NOTE** Transmission is halted if the connection to the remote device is lost.
- **Cradle Contact Batch Mode** - The digital scanner starts storing bar code data when **Enter Batch Mode** is scanned. Data transmission is triggered by insertion of the digital scanner into the cradle.
- ✓ **NOTE** If the digital scanner is removed from the cradle during batch data transfer, transmission halts until the digital scanner is re-inserted in the cradle.
- **Batch Only Mode** - The scanner radio is turned off and the scanner stores all bar code data. Data transmission is triggered by insertion of the scanner into the cradle.
- ✓ **NOTE** If the digital scanner is removed from the cradle during batch data transfer, transmission halts until the digital scanner is re-inserted in the cradle.

The radio may be turned off as batch data is transmitted over the cradle contacts.

This mode can only be exited by scanning **Normal** (default) mode.

- **Parameter Batch Mode** - When Parameter Batch Mode is enabled, the scanner stores parameter bar code data intended for the cradle. When the scanner is inserted into a cradle, the batched parameter data is sent over the cradle contacts, and the mode is disabled. This may be needed when the cradle and/or scanner is configured with its radio turned off.

In all modes, transmissions are halted if the digital scanner is moved out of range. The digital scanner resumes when it is back in range. If a bar code is scanned while batch data is transmitted it is appended to the end of the batched data; parameter bar codes are not stored.

## Batch Mode (continued)



**\*Normal  
(00h)**



**Out of Range Batch Mode  
(01h)**



**Standard Batch Mode  
(02h)**



**Cradle Contact Batch Mode  
(03h)**



**Enter Batch Mode**



**Send Batch Data**

## Batch Mode (continued)

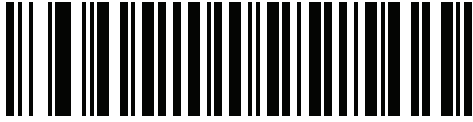

Batch Only Mode



Enter Parameter Batch Mode

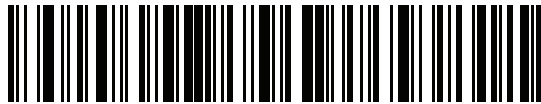

Exit Parameter Batch Mode

---

## Persistent Batch Storage

### Parameter #1399 (F8h 05h 77h)

When the scanner is configured for Persistent Batch Storage, batch data is stored in non-volatile memory and preserved even when the digital scanner is powered down. This parameter is Disabled by default.



**NOTE** Frequently storing batch data with this setting *Enabled* will shorten the life of the non-volatile memory.

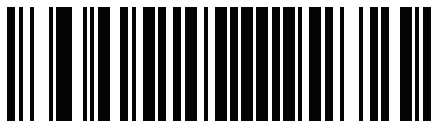

\* Persistent Batch Disable  
(0)

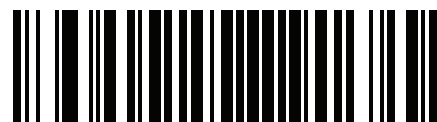

Persistent Batch Enable  
(1)

---

## Page Button

### Parameter # 746 (SSI # F1h EAh)

The cradle offers a page button. The page button is a sensor that when touched, causes paired scanners to emit a beeping sequence. The default is Enable **Page Button**.

1. Place your finger over the button sensor  .
2. Press down for approximately 1 second.
3. The cradle LED will turn blue when the scanner is out of the cradle. The paired scanner will beep, blink, and vibrate. If multiple scanners are paired to the cradle, all the scanners will beep, blink, and vibrate.
4. Repeat as necessary.

✓ **NOTE** Scanners out of radio range will not beep when paged. Refer to [Technical Specifications on page 3-8](#) for detailed radio range information.

Scan one of the following bar codes to enable or disable this feature.



**Disable Page Button  
(0)**



**\*Enable Page Button  
(1)**

## Page Options

To select a page option, select one of the bar codes below.

### Page Mode

#### Parameter # 1364 (SSI # F8h 05h 54h)

- **Page State** - In this mode, the cradle sends a page state request to each scanner. It remains in Page State indication until every scanner sends an acknowledgment.

The scanner enters Page State when the LED indicator is blinking blue and the vibrator and beeper is activated. When the trigger is pressed, or the scanner is inserted into the cradle, or the requested timeout (default is 30 sec) is reached, the scanner sends the acknowledgment to the cradle and returns to its normal state.

- **Page Simple** - In this mode, the cradle sends a page indication request to each scanner, and returns to idle state. Each scanner issues a single Page State indication.

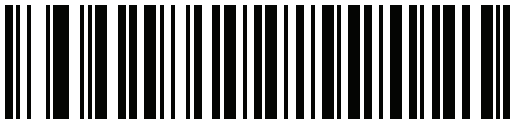

Page State

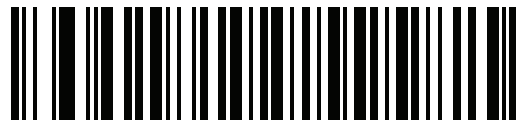

\*Page Simple

### Page State Timeout

#### Parameter # 1365 (SSI # F8h 05h 55h)

Page timeout is programmable in 1 second increments from 1 to 99 seconds. The default timeout is 30 seconds.

✓ **NOTE** Page State Timeout only applies to **Page State Mode**.

To set a page timeout:

1. Scan the **Page Timeout** bar code below.
2. Scan two numeric bar codes from [Numeric Bar Codes on page G-1](#) that correspond to the desired timeout duration. Enter a leading zero for single digit numbers (for example, for a 5 second page timeout, scan the 0 bar code and then the 5 bar code). To correct an error or change the selection, scan [Cancel on page H-1](#).

The Page State Timeout default is 30 seconds.



Page Timeout

---

## Bluetooth Classic and/or Low Energy (Cradle Host Only)

### Parameter # 1355 (SSI # F8h 05h 4Bh)

Set up cradle to accept both **Bluetooth Classic and Low Energy** connections or **Low Energy Only** connections.

- ✓ **NOTE** All Bluetooth Classic connections must be terminated before the setting can change to **Low Energy Only**.

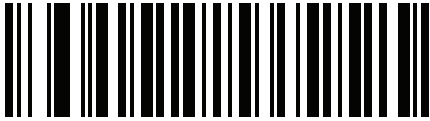

\* Bluetooth Classic and Low Energy

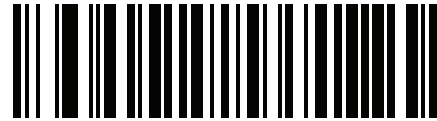

Low Energy Only

---

## Bluetooth Security

The digital scanner supports Bluetooth Authentication. Authentication can be requested by either the remote device or the digital scanner.

- ✓ **NOTE** A remote device can still request Authentication.

### PIN Code

#### Parameter # 552 (SSI # F1h 28h)

To set and store a PIN code (e.g., password) on the digital scanner to connect to the host:

1. Scan the **Set & Store PIN Code** bar code below.
2. Scan five alphanumeric programming bar codes using the alphanumeric bar codes beginning on [page H-1](#).
3. Scan **End of Message** in the *Advanced Data Formatting Guide*.

The default PIN code is **12345**.

If the digital scanner communicates with a host with enabled, synchronize the PIN codes on the digital scanner and host. To achieve this, connect the digital scanner to the host when setting the PIN codes. If the digital scanner is not connected to a host, the PIN code change only takes affect on the digital scanner. If is required between the digital scanner and host, and the PIN codes do not match, pairing fails.

- ✓ **NOTE** An extended 16 character PIN code is available for additional with Open Bluetooth (SPP and HID).



**Set and Store PIN Code**

## Variable PIN Code

### Parameter # 608 (SSI # F1h 60h)

When switching to Cradle Host mode, scan **Static PIN Code** below to avoid entering the PIN code manually. The PIN stored in memory is used. Scan the **Variable PIN Code** below to manually enter a PIN code with each connection.

The default PIN code is the user-programmed PIN set and stored above. Typically, however, HID connections require entering a Variable PIN Code. If, when attempting connection, the application presents a text box that includes a PIN, scan the **Variable PIN Code** bar code, then re-attempt connection. When you hear a beep indicating the digital scanner is waiting for an alphanumeric entry, enter the provided variable PIN using the [Alphanumeric Bar Codes on page H-1](#), then scan **End of Message** in the *Advanced Data Formatting Guide*. If the code is less than 16 characters. The digital scanner discards the variable PIN code after connection.



**\*Static PIN Code  
(0)**



**Variable PIN Code  
(1)**

## Bluetooth Security Levels

### Parameter # 1393 (SSI # F8h 05h 71h)

- **Low Bluetooth Security** - The low security setting is designed for ease of connection with most devices. This setting may be unacceptable to some devices. If connection fails, try re-connecting after increasing security setting on the scanner.

If connecting to Bluetooth 2.1 device and above, *Just Works* method for secure and simple pairing is used.



**NOTE** Data is encrypted using the **Low Bluetooth** security setting if connected to a Bluetooth 2.1 and above device.

- **Medium Bluetooth Security** - The medium security setting may require a passkey for the initial connection to pair scanner and device. If connecting to Bluetooth 2.1 device and above, *Passkey Entry* method for secure and simple pairing is used.
- **High Bluetooth Security** - The high security setting enables *Man in the Middle* protection for Bluetooth 2.1 and above. Not all devices are able to support this mode.
- **Legacy Bluetooth Security** (Bluetooth 2.0 and below) - The legacy security setting enables authentication and encryption for legacy pairing.

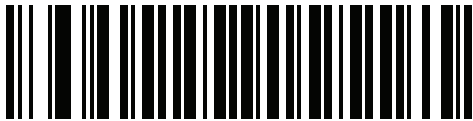

\*Low Bluetooth Security

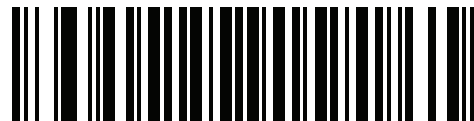

Medium Bluetooth Security

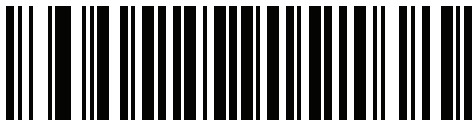

High Bluetooth Security

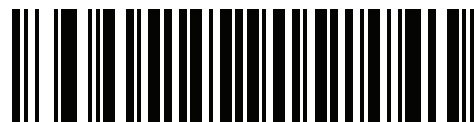

Legacy Bluetooth Security



---

## Bluetooth Radio, Linking, and Batch Operation

The DS8178 digital scanner has a Bluetooth Class 1 radio which achieves a range of at least 135m / 440ft (open air, line of sight). The actual range you achieve is influenced by the presence of other radios, shelving and wall materials as well as which cradle is tested. The environments vary widely and often influence radio ranges.

When the digital scanner goes out of communications range to the base, it can be configured for Batch Mode (see [Batch Mode on page 4-33](#)). The digital scanner has sufficient onboard memory to store 500 bar codes of typical size (UPC/EAN).

### Setting Up an iOS or Android Product To Work With The Digital Scanner

Perform the following steps on each device to establish a link.

#### ***HID Keyboard Emulation***

1. On the DS8178, scan [Human Interface Device \(HID\) Keyboard Emulation on page 4-5](#).
2. On an iOS/iPad/iPhone, select *Settings > General > Bluetooth* and turn Bluetooth *On*. Choose the DS8178 digital scanner from the list of discovered devices. A link should be established allowing scanning into any application with keyboard entry.
3. On an Android/ET1/Droid, select *Settings > Wireless & networks > Bluetooth* (to turn Bluetooth on, if not already on). Select *Bluetooth Settings* and choose the DS8178 digital scanner from the list of discovered devices. (The DS8178 digital scanner normally displays as DS8178 - xxxxxx, where xxxxxx is the serial number.)



#### ***IMPORTANT***

Android devices, specifically the ET1, may require you to scan a PIN to connect. If so, a PIN displays on the device. To enter the required PIN, scan the bar code, [Variable PIN Code \(1\) on page 4-39](#) then re-attempt connection. When a beep sounds, indicating the scanner is waiting for PIN entry, scan the PIN using the [Numeric Bar Codes on page G-1](#). Incorrect scanned entries can be deleted by scanning [Cancel on page H-1](#).

For more information, read the section [Variable PIN Code on page 4-39](#).



# CHAPTER 5 USER PREFERENCES

---

## Introduction

You can program the digital scanner to perform various functions, or activate different features. This chapter describes each user preference feature and provides programming bar codes for selecting these features.

The digital scanner ships with the settings shown in [Table 5-1 on page 5-2](#) (also see [Appendix A, Standard Parameter Defaults](#) for all defaults). If the default values suit requirements, programming is not necessary.

To set feature values, scan a single bar code or a short bar code sequence. The settings are stored in non-volatile memory and are preserved even when the digital scanner is powered down.

✓ **NOTE** Most computer monitors allow scanning the bar codes directly on the screen. When scanning from the screen, be sure to set the document magnification to a level where you can see the bar code clearly, and bars and/or spaces are not merging.

If not using a USB cable, select a host type (see each host chapter for specific host information) after the power-up beeps sound. This is only necessary upon the first power-up when connected to a new host.

To return all features to default values, see [Default Parameters on page 5-5](#). Throughout the programming bar code menus, asterisks indicate (\*) default values.



\* Indicates Default — \*High Volume — Feature/Option  
(0) — Option Value

## Scanning Sequence Examples

In most cases, scanning one bar code sets the parameter value. For example, to set the beeper tone to high, scan the **High Frequency** (beeper tone) bar code listed under [Beeper Tone on page 5-9](#). The digital scanner issues a fast warble beep and the LED turns green, signifying a successful parameter entry.

Other parameters, such as **Serial Response Time-Out** or **Data Transmission Formats**, require scanning several bar codes. See these parameter descriptions for this procedure.

## Errors While Scanning

Unless otherwise specified, to correct an error during a scanning sequence, just re-scan the correct parameter.

## User Preferences Parameter Defaults

[Table 5-1](#) lists defaults for user preferences parameters. To change the default values:

- Scan the appropriate bar codes in this guide. These new values replace the standard default values in memory. To recall the default parameter values, see [Default Parameters on page 5-5](#).
- Configure the digital scanner using the 123Scan configuration program (see [Chapter 16, 123Scan and Software Tools](#)).

✓ **NOTE** See [Appendix A, Standard Parameter Defaults](#) for all user preferences, hosts, symbologies, and miscellaneous default parameters.

**Table 5-1** User Preferences Parameter Defaults

Parameter	Parameter Number <sup>1</sup>	SSI Number <sup>2</sup>	Default	Page Number
Set Default Parameter			Restore Defaults	<a href="#">5-5</a>
Parameter Bar Code Scanning	236	ECh	Enable	<a href="#">5-6</a>
Beep After Good Decode	56	38h	Enable	<a href="#">5-6</a>
Direct Decode Indicator	859	F2h 5Bh	Disable	<a href="#">5-7</a>
Beeper Volume	140	8Ch	High	<a href="#">5-8</a>
Beeper Tone	145	91h	Medium	<a href="#">5-9</a>
Beeper Duration	628	F1h 74h	Medium	<a href="#">5-10</a>
Suppress Power Up Beeps	721	F1h D1h	Do Not Suppress	<a href="#">5-10</a>
Decode Pager Motor	613	F1h 65h	Enable	<a href="#">5-11</a>
Decode Pager Motor Duration	626	F1h 72h	150 msec	<a href="#">5-11</a>

<sup>1</sup> Parameter number decimal values are used for programming via RSM commands.  
<sup>2</sup> SSI number hex values are used for programming via SSI commands.

**Table 5-1** *User Preferences Parameter Defaults (Continued)*

Parameter	Parameter Number <sup>1</sup>	SSI Number <sup>2</sup>	Default	Page Number
Night Mode Trigger (DS8178-HC Only)	1215	F8h 04h BFh	Disable	<a href="#">5-13</a>
Night Mode Toggle (DS8178-HC Only)			N/A	<a href="#">5-13</a>
Lamp Mode Control	1711	F8h 06h AFh	Disable	<a href="#">5-14</a>
Lamp Mode Timeout	1712	F8h 06h B0h	5 Minutes	<a href="#">5-15</a>
Low Power Mode	128	80h	Enable	<a href="#">5-16</a>
Time Delay to Low Power Mode	146	92h	5 sec	<a href="#">5-17</a>
Timeout to Low Power Mode from Auto Aim	729	F1h D9h	15 sec	<a href="#">5-19</a>
Hand-Held Trigger Mode	138	8Ah	Level	<a href="#">5-20</a>
Hands-Free Mode	630	F1h 76h	Enable	<a href="#">5-21</a>
Hand-Held Decode Aiming Pattern	306	F0h 32h	Enable	<a href="#">5-22</a>
Hands-Free (Presentation) Decode Aiming Pattern	590	F1h 4Eh	Disable Hands-Free Decode Aiming Pattern	<a href="#">5-23</a>
Picklist Mode	402	F0h 92h	Disabled Always	<a href="#">5-24</a>
FIPS Mode	736	F1h E0h	Disable	<a href="#">5-25</a>
Continuous Bar Code Read	649	F1h 89h	Disable	<a href="#">5-25</a>
Unique Bar Code Reporting	723	F1h D3h	Enable	<a href="#">5-26</a>
Decode Session Timeout	136	88h	9.9 sec	<a href="#">5-26</a>
Hands-Free Decode Session Timeout	400	F0h 90h	15	<a href="#">5-27</a>
Timeout Between Decodes, Same Symbol	137	89h	0.5 sec	<a href="#">5-28</a>
Timeout Between Decodes, Different Symbols	144	90h	0.1 sec	<a href="#">5-28</a>
Triggered Timeout, Same Symbol	724	F1 D4	Disable	<a href="#">5-29</a>
Decode Mirror Images (Data Matrix Only)	537	F1h 19h	Auto	<a href="#">5-30</a>
Mobile Phone/Display Mode	716	F1h CCh	Normal	<a href="#">5-31</a>
PDF Prioritization	719	F1h CFh	Disable	<a href="#">5-32</a>
PDF Prioritization Timeout	720	F1h D0h	200 ms	<a href="#">5-32</a>
Presentation Mode Field of View	609	F1h 61h	Full	<a href="#">5-33</a>
Decoding Illumination	298	F0h 2Ah	Enable	<a href="#">5-34</a>
Motion Tolerance (Hand-Held Trigger Mode Only)	858	F2h 5Ah	Less Motion Tolerance	<a href="#">5-34</a>

<sup>1</sup> Parameter number decimal values are used for programming via RSM commands.  
<sup>2</sup> SSI number hex values are used for programming via SSI commands.

**Table 5-1** User Preferences Parameter Defaults (Continued)

Parameter	Parameter Number <sup>1</sup>	SSI Number <sup>2</sup>	Default	Page Number
Add an Enter Key	N/A	N/A	N/A	<a href="#">5-36</a>
Transmit Code ID Character	45	2Dh	None	<a href="#">5-36</a>
Battery Threshold		N/A		<a href="#">5-35</a>
Battery Status High Threshold	1367		50%	
Battery Status Medium Threshold	1368		20%	
Battery Status Low Warning Threshold	1369		10%	
Battery Health Low Warning Threshold	1370		60%	
Prefix Value	99, 105	63h, 69h	7013 <CR><LF>	<a href="#">5-38</a>
Suffix 1 Value	98, 104	62h, 68h	7013 <CR><LF>	<a href="#">5-38</a>
Suffix 2 Value	100, 106	64h, 6Ah		
Scan Data Transmission Format	235	EBh	Data as is	<a href="#">5-39</a>
FN1 Substitution Values	103, 109	67h, 6Dh	7013 <CR><LF>	<a href="#">5-40</a>
Transmit "No Read" Message	94	5Eh	Disable	<a href="#">5-41</a>
Unsolicited Heartbeat Interval	1118	F8h 04h 5Eh	Disable	<a href="#">5-42</a>

<sup>1</sup> Parameter number decimal values are used for programming via RSM commands.  
<sup>2</sup> SSI number hex values are used for programming via SSI commands.

---

## Parameters

### Default Parameters

The digital scanner can be reset to two types of defaults: factory defaults or custom defaults. Scan the appropriate bar code below to reset the digital scanner to its default settings and/or set the digital scanner current settings as the custom default.

- **Restore Defaults** - Resets all default parameters as follows:
  - If custom default values were configured (see **Write to Custom Defaults**), the custom default values are set for all parameters each time the **Restore Defaults** bar code below is scanned.
  - If no custom default values were configured, the factory default values are set for all parameters each time the **Restore Defaults** bar code below is scanned. (For factory default values, see [Appendix A, Standard Parameter Defaults.](#))
- **Set Factory Defaults** - Scan the **Set Factory Defaults** bar code below to eliminate all custom default values and set the digital scanner to factory default values (For factory default values, see [Appendix A, Standard Parameter Defaults.](#))
- **Write to Custom Defaults** - Custom default parameters can be configured to set unique default values for all parameters. After changing all parameters to the desired default values, scan the **Write to Custom Defaults** bar code below to configure custom defaults.



\*Restore Defaults



Set Factory Defaults



Write to Custom Defaults

## Parameter Bar Code Scanning

### Parameter # 236 (SSI # ECh)

To disable the decoding of parameter bar codes, including the **Set Defaults** parameter bar codes, scan the **Disable Parameter Scanning** bar code below. To enable decoding of parameter bar codes, scan **Enable Parameter Scanning**.



**\*Enable Parameter Bar Code Scanning  
(1)**



**Disable Parameter Bar Code Scanning  
(0)**

## Beep After Good Decode

### Parameter # 56 (SSI # 38h)

Scan a bar code below to select whether or not the digital scanner beeps after a good decode. If selecting **Do Not Beep After Good Decode**, the beeper still operates during parameter menu scanning and to indicate error conditions.



**\*Beep After Good Decode (Enable)  
(1)**



**Do Not Beep After Good Decode (Disable)  
(0)**



## Direct Decode Indicator

### Parameter # 859 (SSI # F2h 5Bh)

This feature is only supported in Auto Aim and Standard (Level) trigger modes. Scan a bar code below to select optional blinking of the illumination on a successful decode

- **Disable Direct Decode Indicator** - illumination does not blink on a successful decode.
- **1 Blink** - illumination blinks once upon a successful decode.
- **2 Blinks** - illumination blinks twice upon a successful decode.



**\*Disable Direct Decode Indicator  
(0)**



**1 Blink  
(1)**



**2 Blinks  
(2)**

## Beeper Volume

### Parameter # 140 (SSI # 8Ch)

To select a beeper volume, scan the **Low Volume**, **Medium Volume**, or **High Volume** bar code.



**Low Volume**  
(2)



**Medium Volume**  
(1)



**\*High Volume**  
(0)

## Beeper Tone

### Parameter # 145 (SSI # 91h)

To select a beeper tone, scan one of the following bar codes.



Off  
(3)

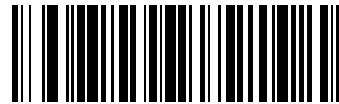

Low Tone  
(2)

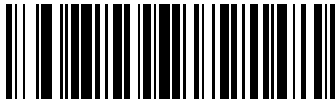

\* Medium Tone  
(1)

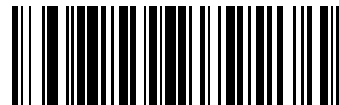

High Tone  
(0)



Medium to High Tone (2-tone)  
(4)

## Beeper Duration

### Parameter # 628 (SSI # F1h 74h)

To select the duration for the beeper, scan one of the following bar codes.

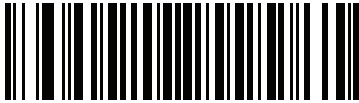

**Short**  
**(0)**

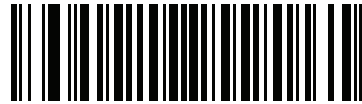

**\* Medium**  
**(1)**

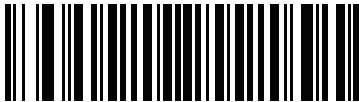

**Long**  
**(2)**

## Suppress Power Up Beeps

### Parameter # 721 (SSI # F1h D1h)

Scan a bar code below to select whether or not to suppress the digital scanner power-up beeps.



**\*Do Not Suppress Power Up Beeps**  
**(0)**



**Suppress Power Up Beeps**  
**(1)**

## Decode Pager Motor (DS8178-HC Only)

### Parameter # 613 (SSI # F1h 65h)

The scanner includes a pager motor which, when enabled, vibrates the scanner for a period of time when a successful decode occurs.

Scan a bar code below to enable or disable the pager motor. If enabled, scan the appropriate bar code to set the period of time in which to vibrate the scanner (see [Decode Pager Motor Duration \(DS8178-HC Only\)](#) below).



Pager Motor Disable  
(0)



\*Pager Motor Enable  
(1)

## Decode Pager Motor Duration (DS8178-HC Only)

### Parameter # 626 (SSI # F1h 72h)

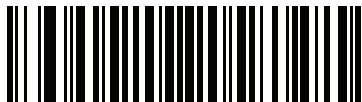

\*150 msec  
(15)



200 msec  
(20)

### Decode Pager Motor Duration (continued)



250 msec  
(25)



300 msec  
(30)

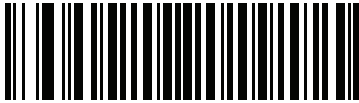

400 msec  
(40)



500 msec  
(50)

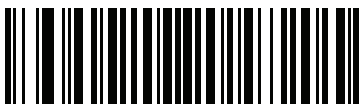

600 msec  
(60)



750 msec  
(75)

## Night Mode Trigger (DS8178-HC Only)

### Parameter # 1215 (SSI # F8h 04h BFh)

Enable this to use the trigger to toggle between entering and exiting Night Mode. To toggle, point the scanner away from a bar code, pull the trigger until the beam goes off, and then continue pulling the trigger for an additional 5 seconds. Note that pulling the trigger an additional 5 seconds after decoding a bar code has no affect.

When entering Night Mode, the pager motor vibrates. When exiting Night Mode, the scanner emits two short beeps.



**Enable Night Mode Trigger  
(1)**



**\*Disable Night Mode Trigger  
(0)**

### Night Mode Toggle

To toggle between entering and exiting Night Mode without using the trigger, scan this bar code. This functions regardless of the state of the **Night Mode Trigger** parameter.

When scanning this bar code, the Pager Motor vibrates when entering Night Mode, and the scanner emits 2 short beeps when exiting Night Mode.

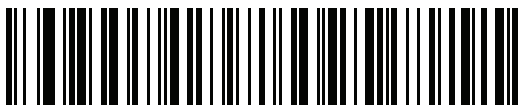

**Toggle Night Mode**

## Lamp Mode

Lamp Mode uses the scanner to illuminate the workspace around the scanner by providing continuous illumination on demand. Lamp Mode is intended to operate while the scanner is docked in the presentation cradle (CR8178-PC). Lamp Mode may be enabled or disabled (default). Once enabled, Lamp Mode is activated or deactivated by pressing the page button on the presentation cradle. Lamp Mode may be enabled with the option to allow bar code scanning, or not.

## Lamp Mode Control

### Parameter #1711 (SSI # F8h 06h AFh)

This parameter enables or disables the Lamp Mode feature.



**Enable Lamp Mode with Scanning  
(1)**



**Enable Lamp Mode without Scanning  
(2)**



**\*Disable Lamp Mode  
(0)**



## Lamp Mode Timeout

### Parameter #1712 (SSI # F8h 06h B0h)

This parameter controls how long the lamp remains on for when Lame Mode is enabled.



**1 Minute**  
**(1)**



**\*5 Minutes**  
**(5)**



**10 Minutes**  
**(10)**



**30 Minutes**  
**(30)**



**Always On**  
**(0)**

## Low Power Mode

### Parameter # 128 (SSI # 80h)

This parameter determines whether or not the digital scanner enters low power mode after a decode attempt. If disabled, power remains on after each decode attempt.



**Disable Low Power Mode  
(0)**



**\* Enable Low Power Mode  
(1)**

## Time Delay to Low Power Mode

### Parameter # 146 (SSI # 92h)

✓ **NOTE** This parameter only applies when Low Power Mode is enabled.

This parameter sets the time the digital scanner remains active before entering low power mode. The digital scanner wakes upon trigger pull or when the host attempts to communicate with the digital scanner.



100 msec  
(65)



500 msec  
(69)



1 Second  
(17)

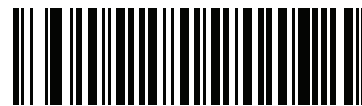

2 sec  
(18)

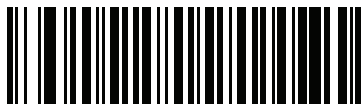

3 sec  
(19)



4 sec  
(20)

**Time Delay to Low Power Mode (continued)**



\* 5 sec  
(21)



10 sec  
(26)

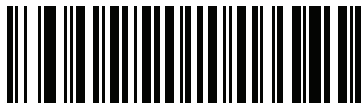

15 sec  
(27)

## Timeout to Low Power Mode from Auto Aim

### Parameter # 729 (SSI # F1 D9)

This parameter sets the time the scanner remains in auto aim before entering Low Power Mode.



**Disabled  
(0)**

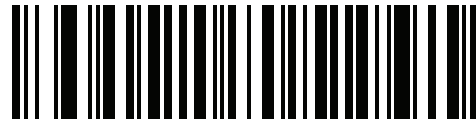

**5 sec  
(5)**



**\* 15 sec  
(11)**



**30 sec  
(13)**



**1 minute  
(17)**

## Hand-Held Trigger Mode

### Parameter # 138 (SSI # 8Ah)

Select one of the following trigger modes for the digital scanner.

- **Standard (Level)** - A trigger pull activates decode processing. Decode processing continues until the bar code decodes, you release the trigger, or the [Decode Session Timeout on page 5-26](#) occurs.
- **Presentation (Blink)** - The digital scanner activates decode processing when it detects a bar code in its field of view. After a period of non-use, the digital scanner enters a low power mode, in which the LEDs turn off until the digital scanner senses motion.
- **Auto Aim** - This trigger mode projects the aiming dot when you lift the digital scanner. A trigger pull activates decode processing. After 5 seconds of inactivity the aiming dot shuts off.

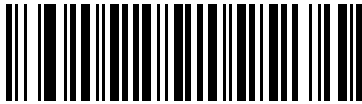

**\*Level (Standard)**  
**(0)**

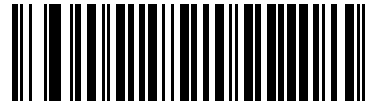

**Presentation (Blink)**  
**(7)**



**Auto Aim**  
**(9)**

## Hands-Free Mode

### Parameter # 630 (SSI # F1h 76h)

In hands-free mode, when you place the DS8178 in the presentation cradle, it automatically triggers when presented with a bar code. Lifting the digital scanner causes it to behave according to the setting of the [Hand-Held Trigger Mode on page 5-20](#).

If you select **Disable Hands-Free Mode**, the digital scanner behaves according to the setting of the [Hand-Held Trigger Mode on page 5-20](#) regardless of whether the DS8178 is in the presentation cradle.



**\*Enable Hands-Free Mode  
(1)**

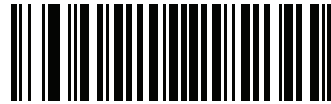

**Disable Hands-Free Mode  
(0)**

## Hand-Held Decode Aiming Pattern

### Parameter # 306 (SSI # F0h 32h)

Select **Enable Hand-Held Decode Aiming Pattern** to project the aiming dot during bar code capture, **Disable Hand-Held Decode Aiming Pattern** to turn the aiming dot off, or **Enable Hand-Held Decode Aiming Pattern on PDF** to project the aiming dot when the digital scanner detects a 2D bar code.



**NOTE** With [Picklist Mode on page 5-24](#) enabled, the decode aiming dot flashes even when the **Hand-Held Decode Aiming Pattern** is disabled.



**\*Enable Hand-Held Decode Aiming Pattern  
(2)**

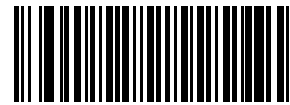

**Disable Hand-Held Decode Aiming Pattern  
(0)**

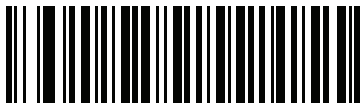

**Enable Hand-Held Decode Aiming Pattern on PDF  
(3)**



## Hands-Free Decode Aiming Pattern

### Parameter # 590 (SSI # F1h 4Eh)

Select **Enable Hands-Free Decode Aiming Pattern** to project the aiming dot during bar code capture, **Disable Hands-Free Decode Aiming Pattern** to turn the aiming dot off, or **Enable Hands-Free Decode Aiming Pattern on PDF** to project the aiming dot when the digital scanner detects a 2D bar code.



**NOTE** With [Picklist Mode on page 5-24](#) enabled, the decode aiming dot flashes even when the **Decode Aiming Pattern** is disabled.



Enable Hands-Free Decode Aiming Pattern  
(1)



\*Disable Hands-Free Decode Aiming Pattern  
(0)



Enable Hands-Free Decode Aiming Pattern on PDF  
(2)

## Picklist Mode

### Parameter # 402 (SSI # F0h 92h)

Scan one of the following bar codes to select a Picklist Mode, which allows you to pick and decode a bar code from multiple bar codes printed close together.

✓ **NOTE** Enabling Picklist Mode overrides the Disable Decode Aiming Pattern options. You can not disable the decode aiming pattern when Picklist Mode is enabled.

Enabling Picklist Mode can slow decode speed and hinder the ability to decode longer bar codes.

- Enable Picklist Mode Always - Picklist Mode is always enabled.
- Enable Picklist Mode in Hand-held Mode - Picklist Mode is enabled when the scanner is out of hands-free mode and disabled when the scanner is in presentation mode.
- Enable Picklist Mode in Hands-free Mode - Picklist Mode is enabled when the scanner is in hands-free mode only.
- Disable Picklist Mode Always - Picklist Mode is always disabled.

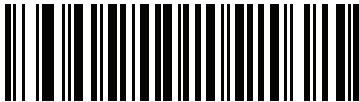

Enable Picklist Mode Always  
(2)



Enable Picklist Mode in Hand-held Mode  
(1)

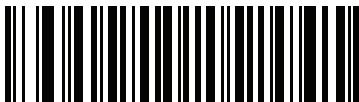

Enable Picklist Mode in Hands-free Mode  
(3)



\*Disable Picklist Mode Always  
(0)

## FIPS Mode

### Parameter # 736 (SSI # F1h E0h)

The Federal Information Processing Standard (FIPS) 140-2 is a U.S. government computer security standard used to accredit cryptographic modules. FIPS enabled scanners and cradles offer this secure mode of operation.

To enable the FIPS mode of operation (disabled by default), scan the **Enable FIPS** bar code. The scanner attempts to establish a secure session with the cradle to which it is connected. On success, the scanner lights an amber LED on every trigger pull to signal that all data will be transmitted over Bluetooth in a secure fashion. On failure, the scanner will sound transmission failure error message on every attempt to transmit data.

To disable the FIPS mode, scan the **Disable FIPS** bar code at any time.



**Enable FIPS**  
(1)

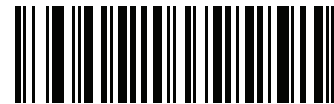

**\* Disable FIPS**  
(0)

## Continuous Bar Code Read

### Parameter # 649 (SSI # F1h 89h)

Enable this to report every bar code while the trigger is pulled.



**NOTE** Zebra strongly recommends enabling [Picklist Mode on page 5-24](#) with this feature. Disabling Picklist Mode can cause accidental decodes when more than one bar code is in the digital scanner's field of view.



**\*Disable Continuous Bar Code Read**  
(0)



**Enable Continuous Bar Code Read**  
(1)

## Unique Bar Code Reporting

### Parameter # 723 (SSI # F1h D3h)

Enable this to report only unique bar codes while the trigger is pulled. This option only applies when **Continuous Bar Code Read** is enabled.



**Disable Continuous Bar Code Read Uniqueness  
(0)**



**\*Enable Continuous Bar Code Read Uniqueness  
(1)**

## Decode Session Timeout

### Parameter # 136 (SSI # 88h)

This parameter sets the maximum time decode processing continues during a scan attempt. It is programmable in 0.1 second increments from 0.5 to 9.9 seconds. The default timeout is 9.9 seconds.

To set a Decode Session Timeout, scan the bar code below. Next, scan two numeric bar codes from [Appendix G, Numeric Bar Codes](#) that correspond to the desired on time. Enter a leading zero for single digit numbers. For example, to set a Decode Session Timeout of 0.5 seconds, scan the bar code below, then scan the **0** and **5** bar codes. To correct an error or change the selection, scan [Cancel on page H-1](#).



**Decode Session Timeout**

## Hands-free Decode Session Timeout

### Parameter # 400 (SSI # F0h 90h)

This parameter is the hands-free compliment to the **Decode Session Timeout**. It configures the minimum and maximum decode processing time during a hands-free scan attempt. It only applies to the hands-free trigger mode or when a scanner is placed in the Presentation cradle (CR8178-P).

The minimum decode processing time is defined as the time in which the scanner stops decoding when an object is removed or left stationary in the imaging field of view.

The maximum decode processing time is defined as the time in which the scanner stops decoding when an object is left in or is moving in the field of view.

Both the maximum and minimum times are configured using a single setting. The relationship of this setting is as follows:

Setting Value	Minimum Time	Maximum Time
$X < 25$	250 ms	2.5 Seconds
$X \geq 25$	$X * 10$ ms	$X * 100$ ms

For example, a setting value of 100 results in the scanner turning off approximately 1 second after an object is removed from the field of view or 10 seconds while an object is in the field of view moving.

The default value of the setting is 15 which results in a Minimum time of 250 ms and Maximum time of 1.5 seconds.

Adjust this setting based on your requirements. For example, when doing PDF prioritization, this parameter should be set to a value where the maximum time is above the PDF prioritization timeout.

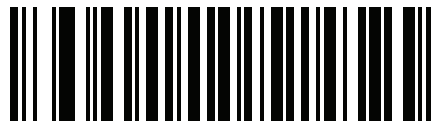

**Hands-free Decode Session Timeout**

## Timeout Between Decodes, Same Symbol

### Parameter # 137 (SSI # 89h)

Use this option in Continuous Bar Code Read mode to prevent the beeper from continuously beeping when a symbol is left in the digital scanner field of view. The bar code must be out of the field of view for the timeout period before the digital scanner reads the same consecutive symbol. It is programmable in 0.1 second increments from 0.0 to 9.9 seconds. The default interval is 0.5 seconds.

To select the timeout between decodes for the same symbol, scan the bar code below, then scan two numeric bar codes from [Appendix G, Numeric Bar Codes](#) that correspond to the desired interval, in 0.1 second increments.



Timeout Between Decodes, Same Symbol

## Timeout Between Decodes, Different Symbols

### Parameter # 144 (SSI # 90h)

Use this option in presentation mode or Continuous Bar Code Read to control the time the digital scanner is inactive between decoding different symbols. It is programmable in 0.1 second increments from 0.1 to 9.9 seconds. The default is 0.1 seconds.

To select the timeout between decodes for different symbols, scan the bar code below, then scan two numeric bar codes from [Appendix G, Numeric Bar Codes](#) that correspond to the desired interval, in 0.1 second increments.



**NOTE** Timeout Between Decodes, Different Symbols cannot be greater than or equal to the Decode Session Timeout.



Timeout Between Decodes, Different Symbols

## Triggered Timeout, Same Symbol

### Parameter # 724 (SSI # F1 D4)

Scan **Enable Triggered Timeout, Same Symbol** below to apply **Timeout Between Decodes, Same Symbol** (parameter #137 on page [5-28](#)) in hand-held trigger mode. Subsequent scans of **Enable Triggered Timeout, Same Symbol** are ignored until **Timeout Between Decodes, Same Symbol** expires.



**NOTES** 1. This feature does not apply to Timeout Between Decodes, Different Symbols.

2. **Timeout Between Decodes, Same Symbol** should not be greater than or equal to the **Time Delay to Low Power Mode** (parameter #146 on page [5-17](#)).



**Enable Triggered Timeout, Same Symbol**

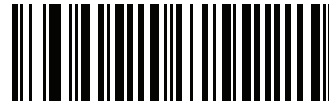

**\* Disable Triggered Timeout, Same Symbol**

## Decode Mirror Images (Data Matrix Only)

### Parameter # 537 (SSI # F1h 19h)

Select an option for decoding mirror image Data Matrix bar codes:

- Always - decode only Data Matrix bar codes that are mirror images
- Never - do not decode Data Matrix bar codes that are mirror images
- Auto - decode both mirrored and unmirrored Data Matrix bar codes.



**Never**  
**(0)**



**Always**  
**(1)**



**\*Auto**  
**(2)**



## Mobile Phone/Display Mode

### Parameter # 716 (SSI # F1h CCh)

This mode improves bar code reading performance off mobile phones and electronic displays. Select Enhanced in hand-held, hands-free, or both modes, or select Normal Mobile Phone/Display Mode.



**\*Normal Mobile Phone/Display Mode  
(0)**

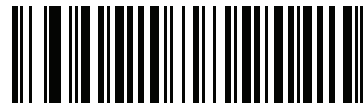

**Enhanced in Hand-Held Mode  
(1)**



**Enhanced in Hands-Free Mode  
(2)**

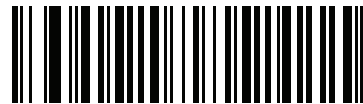

**Enhanced in Both Modes  
(3)**

## PDF Prioritization

### Parameter # 719 (SSI # F1h CFh)

Enable this feature to delay decoding a 1D bar code (Code 128) by the value specified in [PDF Prioritization Timeout](#). During that time the digital scanner attempts to decode a PDF417 symbol (e.g., on a US driver's license), and if successful, reports this only. If it does not decode (can not find) a PDF417 symbol, it reports the 1D symbol after the timeout. The 1D symbol must be in the device field of view for the digital scanner to report it. This parameter does not affect decoding other symbologies..



#### **NOTE**

The 1D Code 128 bar code lengths include the following:

- 7 to 10 characters
- 14 to 17 characters
- 27 to 28 characters

In addition, a Code 39 bar code with the following lengths are considered to potentially be part of a US driver's license:

- 8 characters
- 12 characters

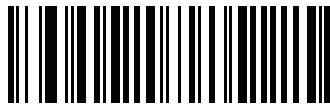

**\*Disable PDF Prioritization  
(0)**



**Enable PDF Prioritization  
(1)**

## PDF Prioritization Timeout

### Parameter # 720 (SSI # F1h D0h)

✓ **NOTE** Hands-free [Decode Session Timeout on page 5-26](#) should be set to a longer duration than Prioritization Timeout when configured.

When [PDF Prioritization](#) is enabled, this timeout specifies how long the digital scanner attempts to decode a PDF417 symbol before reporting the 1D bar code in the field of view.

Scan the following bar code, then scan four digits from [Appendix G, Numeric Bar Codes](#) that specify the timeout in milliseconds. For example, to enter 400 ms, scan the following bar code, then scan 0400. The range is 0 to 5000 ms, and the default is 200 ms.



PDF Prioritization Timeout

## Presentation Mode Field of View

### Parameter # 609 (SSI # F1h 61h)

In presentation mode, by default the digital scanner searches the larger area of the aiming pattern (**Full Field of View**).

To search for a bar code in a smaller region around the aiming dot center in order to speed search time, select **Small Field of View** or **Medium Field of View**.



Small Field of View  
(0)



Medium Field of View  
(1)



\*Full Field of View  
(2)

## Decoding Illumination

### Parameter # 298 (SSI # F0h 2Ah)

Selecting **Enable Decoding Illumination** causes the digital scanner to flash illumination to aid decoding. Select **Disable Decoding Illumination** to prevent the digital scanner from using decoding illumination.

Enabling illumination usually results in superior images. The effectiveness of the illumination decreases as the distance to the target increases.



**\*Enable Decoding Illumination  
(1)**



**Disable Decoding Illumination  
(0)**

## Motion Tolerance (Hand-Held Trigger Modes Only)

### Parameter # 858 (SSI # F2h 5Ah)

**Less Motion Tolerance** provides optimal decoding performance on 1D bar codes.

To increase motion tolerance and speed decoding when scanning a series of 1D bar codes in rapid progression, scan **More Motion Tolerance**.



**\*Less Motion Tolerance  
(0)**



**More Motion Tolerance  
(1)**

## Battery Threshold

Scan the appropriate bar code below to select the desired battery status threshold.

- **Battery Status High Threshold - Parameter #1367**

This parameter sets the threshold used to show the Battery Status is High. When the battery status is above the High Threshold, the battery indicator is green.

Scan this bar code followed by 2 digits from [Appendix G, Numeric Bar Codes](#) that correspond to the desired percentage from 00 to 99. The default is 50%.

- **Battery Status Medium Threshold - Parameter #1368**

This parameter sets the threshold used to show the Battery Status is Medium. When the battery status is above the Medium Threshold (and below the High Threshold), the Battery indicator is amber. When the battery status is below the Medium Threshold, the Battery indicator is red.

Scan this bar code followed by 2 digits from [Appendix G, Numeric Bar Codes](#) that correspond to the desired percentage from 00 to 99. The default is 20%.

- **Battery Status Low Warning Threshold - Parameter #1369**

This parameter sets the threshold to indicate Batter Status is Critically Low. When the battery status is below the Low Warning Threshold, on every trigger release the scanner issues 4 short beeps.

Scan this bar code followed by 2 digits from [Appendix G, Numeric Bar Codes](#) that correspond to the desired percentage from 00 to 99. The default is 10%.

- **Battery Health Low Warning Threshold - Parameter #1370**

This parameter sets the threshold to indicate Battery Health is Low. When the battery health is below the Low Health Threshold, all battery indication will alternate between Red and the appropriate Battery Status indication.

Scan this bar code followed by 2 digits from [Appendix G, Numeric Bar Codes](#) that correspond to the desired percentage from 00 to 99. The default is 60%.

✓ **NOTE** When Battery Health is Low, you should consider replacing the battery.



**Battery Status High Threshold**

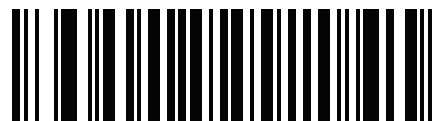

**Battery Status Medium Threshold**

## Battery Threshold (continued)

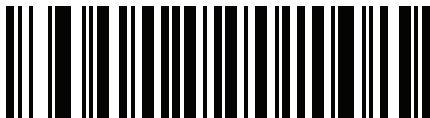

**Battery Status Low Warning Threshold**



**Battery Health Low Warning Threshold**

## Add an Enter Key

To add an Enter key (carriage return/line feed) after scanned data, scan the following bar code. To program other prefixes and/or suffixes, see [Prefix/Suffix Values on page 5-38](#).

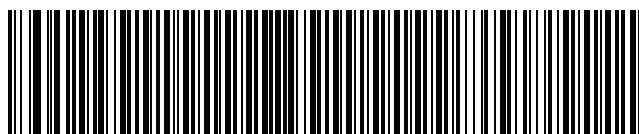

**Add Enter Key (Carriage Return/Line Feed)**

## Transmit Code ID Character

### Parameter # 45 (SSI # 2Dh)

A Code ID character identifies the code type of a scanned bar code. This is useful when decoding more than one code type. In addition to any single character prefix already selected, the Code ID character is inserted between the prefix and the decoded symbol.

Select no Code ID character, a Symbol Code ID character, or an AIM Code ID character. For Code ID characters, see [Symbol Code Identifiers on page E-1](#) and [Programming Reference on page E-1](#).

✓ **NOTE** If you enable Symbol Code ID Character or AIM Code ID Character, and enable [Transmit "No Read" Message on page 5-41](#), the digital scanner appends the code ID for Code 39 to the NR message.

### Transmit Code ID Character (continued)



Symbol Code ID Character  
(2)

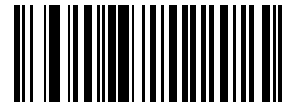

AIM Code ID Character  
(1)

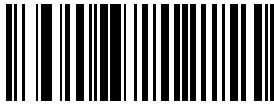

\*None  
(0)

## Prefix/Suffix Values

**Key Category Parameter # P = 99, S1 = 98, S2 = 100 (SSI # P = 63h, S1 = 62h, S2 = 64h)**

**Decimal Value Parameter # P = 105, S1 = 104, S2 = 106 (SSI # P = 69h, S1 = 68h, S2 = 6Ah)**

You can append a prefix and/or one or two suffixes to scan data for use in data editing. To set a value for a prefix or suffix, scan a four-digit number (i.e., four bar codes from [Appendix G, Numeric Bar Codes](#)) that corresponds to that value. See [Appendix I, ASCII Character Sets](#) for the four-digit codes.

When using host commands to set the prefix or suffix, set the key category parameter to 1, then set the 3-digit decimal value. See [Appendix I, ASCII Character Sets](#) for the four-digit codes.

The default prefix and suffix value is 7013 <CR><LF> (the Enter key). To correct an error or change a selection, scan [Cancel on page H-1](#).

✓ **NOTE** To use Prefix/Suffix values, first set the [Scan Data Transmission Format on page 5-39](#).

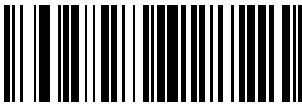

**Scan Prefix  
(7)**

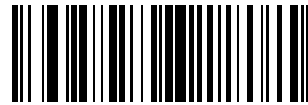

**Scan Suffix 1  
(6)**



**Scan Suffix 2  
(8)**



**Data Format Cancel**



## Scan Data Transmission Format

### Parameter # 235 (SSI # EBh)

To change the scan data format, scan one of the following eight bar codes corresponding to the desired format.

✓ **NOTE** If using this parameter do not use ADF rules to set the prefix/suffix.

To set values for the prefix and/or suffix, see [Prefix/Suffix Values on page 5-38](#).



\*Data As Is  
(0)



<DATA> <SUFFIX 1>  
(1)



<DATA> <SUFFIX 2>  
(2)



<DATA> <SUFFIX 1> <SUFFIX 2>  
(3)



<PREFIX> <DATA >  
(4)

## Scan Data Transmission Format (continued)



<PREFIX> <DATA> <SUFFIX 1>  
(5)



<PREFIX> <DATA> <SUFFIX 2>  
(6)



<PREFIX> <DATA> <SUFFIX 1> <SUFFIX 2>  
(7)

## FN1 Substitution Values

### Key Category Parameter # 103 (SSI # 67h)

### Decimal Value Parameter # 109 (SSI # 6Dh)

The wedge and USB HID keyboard hosts support a FN1 Substitution feature. Enabling this substitutes any FN1 character (0x1b) in an EAN128 bar code with a value. This value defaults to 7013 (Enter Key).

When using host commands to set the FN1 substitution value, set the key category parameter to 1, then set the 3-digit keystroke value. See the ASCII Character Set table for the current host interface for the desired value.

To select a FN1 substitution value via bar code menus:

1. Scan the bar code below.

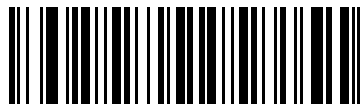

**Set FN1 Substitution Value**

2. Locate the keystroke desired for FN1 Substitution in the ASCII Character Set table for the current host interface. Enter the 4-digit ASCII Value by scanning each digit in [Appendix G, Numeric Bar Codes](#).

To correct an error or change the selection, scan **Cancel**.

To enable FN1 substitution for USB HID keyboard, scan the **Enable FN1 Substitution** bar code on page [5-40](#).

## Transmit “No Read” Message

### Parameter # 94 (SSI # 5Eh)

Scan a bar code below to select whether or not to transmit a No Read message. Enable this to transmit the characters NR when a successful decode does not occur before trigger release or the **Decode Session Timeout** expires. See [Decode Session Timeout on page 5-26](#). Disable this to send nothing to the host if a symbol does not decode.



**NOTE** If you enable **Transmit No Read**, and also enable Symbol Code ID Character or AIM Code ID Character for [Transmit Code ID Character on page 5-36](#), the digital scanner appends the code ID for Code 39 to the NR message.



Enable No Read  
(1)



\*Disable No Read  
(0)

## Unsolicited Heartbeat Interval

### Parameter # 1118 (SSI # F8h 04h 5Eh)

The imager supports sending *Unsolicited Heartbeat Messages* to assist in diagnostics. To enable this feature and set the desired unsolicited heartbeat interval, scan one of the time interval bar codes below, or scan **Set Another Interval** followed by four numeric bar codes from [Appendix G, Numeric Bar Codes](#) (scan sequential numbers that correspond to the desired number of seconds).

Scan **Disable Unsolicited Heartbeat Interval** to turn off the feature.

The heartbeat event is sent as decode data (with no decode beep) in the form of:

*MOTEVTHB:nnn*

where *nnn* is a three-digit sequence number starting at 001 and wrapping after 100.

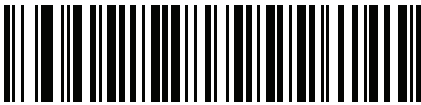

**10 seconds  
(10)**

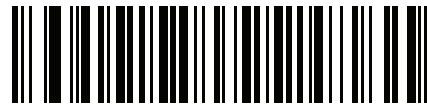

**1 minute  
(60)**



**Set Another Interval**

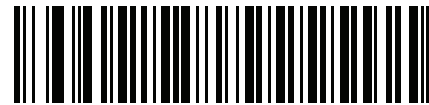

**\*Disable Unsolicited Heartbeat Interval  
(0)**

# CHAPTER 6 IMAGING PREFERENCES

## Introduction

You can program the digital scanner to perform various functions, or activate different features. This chapter describes imaging preference features and provides programming bar codes for selecting these features.

✓ **NOTE** Only the Symbol Native API (SNAPI) with Imaging interface supports image capture. See [USB Device Type on page 7-4](#) to enable this host.

The digital scanner ships with the settings in [Imaging Preferences Parameter Defaults on page 6-2](#) (also see [Appendix A, Standard Parameter Defaults](#) for all host device and miscellaneous defaults). If the default values suit requirements, programming is not necessary.

To set feature values, scan a single bar code or a short bar code sequence. The settings are stored in non-volatile memory and are preserved even when you power down the digital scanner.

✓ **NOTE** Most computer monitors allow scanning the bar codes directly on the screen. When scanning from the screen, be sure to set the document magnification to a level where you can see the bar code clearly, and bars and/or spaces are not merging.

To return all features to default values, scan the [Set Factory Defaults on page 5-5](#). Throughout the programming bar code menus, asterisks (\*) indicate default values.



## Scanning Sequence Examples

In most cases scanning one bar code sets the parameter value. For example, to disable image capture illumination, scan the **Disable Image Capture Illumination** bar code under *Image Capture Illumination on page 6-5*. The digital scanner issues a fast warble beep and the LED turns green, signifying a successful parameter entry.

Other parameters require scanning several bar codes. See these parameter descriptions for this procedure.

## Errors While Scanning

Unless otherwise specified, to correct an error during a scanning sequence, just re-scan the correct parameter.

## Imaging Preferences Parameter Defaults

*Table 6-1* lists the defaults for imaging preferences parameters. To change the default values, scan the appropriate bar codes in this guide. These new values replace the standard default values in memory. To recall the default parameter values, scan *\*Restore Defaults on page 5-5*.

✓ **NOTE** See *Appendix A, Standard Parameter Defaults* for all user preferences, hosts, symbologies, and miscellaneous default parameters.

**Table 6-1** *Imaging Preferences Parameter Defaults*

Parameter	Parameter Number	SSI Number	Default	Page Number
<b>Imaging Preferences</b>				
Operational Modes	N/A	N/A	N/A	<a href="#">6-4</a>
Image Capture Illumination	361	F0h 69h	Enable	<a href="#">6-5</a>
Image Capture Autoexposure	360	F0h 68h	Enable	<a href="#">6-5</a>
Fixed Exposure	567	F4h F1h 37h	100	<a href="#">6-6</a>
Fixed Gain	568	F1h 38h	50	<a href="#">6-6</a>
Gain / Exposure Priority for Snapshot Mode	562	F1h 32h	Autodetect	<a href="#">6-7</a>
Snapshot Mode Timeout	323	F0h 43h	0 (30 seconds)	<a href="#">6-8</a>
Snapshot Aiming Pattern	300	F0h 2Ch	Enable	<a href="#">6-9</a>
Silence Operational Mode Changes	1293	F8h 05h 0Dh	Disable (do not silence)	<a href="#">6-9</a>
Image Cropping	301	F0h 2Dh	Disable	<a href="#">6-10</a>

**Table 6-1** *Imaging Preferences Parameter Defaults (Continued)*

Parameter	Parameter Number	SSI Number	Default	Page Number
Crop to Pixel Addresses	315 316 317 318	F4h F0h 3Bh F4h F0h 3Ch F4h F0h 3Dh F4h F0h 3Eh	0 top 0 left 959 bottom 1279 right	<a href="#">6-11</a>
Image Size (Number of Pixels)	302	F0h 2Eh	Full	<a href="#">6-12</a>
Image Brightness (Target White)	390	F0h 86h	180	<a href="#">6-13</a>
JPEG Image Options	299	F0h 2Bh	Quality	<a href="#">6-13</a>
JPEG Target File Size	561	F1h 31h	160 kB	<a href="#">6-14</a>
JPEG Quality and Size Value	305	F0h 31h	65	<a href="#">6-14</a>
Image Enhancement	564	F1h 34h	Low (1)	<a href="#">6-15</a>
Image File Format Selector	304	F0h 30h	JPEG	<a href="#">6-16</a>
Image Rotation	665	F1h 99h	0	<a href="#">6-17</a>
Bits per Pixel (BPP)	303	F0h 2Fh	8 BPP	<a href="#">6-18</a>
Signature Capture	93	5Dh	Disable	<a href="#">6-19</a>
Signature Capture Image File Format Selector	313	F0h 39h	JPEG	<a href="#">6-20</a>
Signature Capture Bits per Pixel (BPP)	314	F0h 3Ah	8 BPP	<a href="#">6-21</a>
Signature Capture Width	366	F4h F0h 6Eh	400	<a href="#">6-22</a>
Signature Capture Height	367	F4h F0h 6Fh	100	<a href="#">6-22</a>
Signature Capture JPEG Quality	421	F0h A5h	65	<a href="#">6-22</a>

---

## Imaging Preferences

The parameters in this chapter control image capture characteristics. Image capture occurs in all modes of operation, including decode and snapshot.

### Operational Modes

The digital scanner has three modes of operation:

- Decode Mode
- Snapshot Mode.

#### Decode Mode

By default, when you pull the trigger the digital scanner attempts to locate and decode enabled bar codes within its field of view. The digital scanner remains in this mode until it decodes a bar code or you release the trigger.

#### Snapshot Mode

Use Snapshot Mode to capture a high-quality image and transmit it to the host. To temporarily enter this mode scan the **Snapshot Mode** bar code. While in this mode the digital scanner blinks the green LED at 1-second intervals to indicate it is not in standard operating (decode) mode.

In Snapshot Mode, the digital scanner turns on its aiming pattern to highlight the area to capture in the image. The next trigger pull instructs the digital scanner to capture a high quality image and transmit it to the host. A short time may pass (less than 2 seconds) between when the trigger is pulled and the image is captured as the digital scanner adjusts to the lighting conditions. Hold the digital scanner steady until the image is captured, denoted by a single beep.

If you do not press the trigger within the Snapshot Mode Timeout period, the digital scanner returns to Decode Mode. Use [Snapshot Mode Timeout on page 6-8](#) to adjust this timeout period. The default timeout period is 30 seconds.

To disable the aiming pattern during Snapshot Mode, see [Snapshot Aiming Pattern on page 6-9](#).



**Snapshot Mode**



## Image Capture Illumination

### Parameter # 361 (SSI # F0h 69h)

Selecting **Enable Image Capture Illumination** causes illumination to turn on during every image capture. Disable illumination to prevent the digital scanner from using illumination.

Enabling illumination usually results in superior images. The effectiveness of illumination decreases as the distance to the target increases.

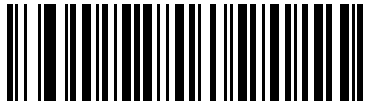

**\*Enable Image Capture Illumination  
(1)**

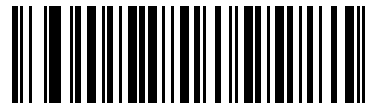

**Disable Image Capture Illumination  
(0)**

## Image Capture Autoexposure

### Parameter # 360 (SSI # F0h 68h)

Select **Enable Image Capture Autoexposure** to allow the digital scanner to control gain settings and exposure (integration) time to best capture an image for the selected operation mode.

Select **Disable Image Capture Autoexposure** to manually adjust the gain and exposure time (see the following pages). This option is only recommended for advanced users with difficult image capture situations.



**\*Enable Image Capture Autoexposure  
(1)**



**Disable Image Capture Autoexposure  
(0)**

## Fixed Exposure

### Parameter # 567 (SSI # F4h F1h 37h)

Type: Word

Range: 1 - 1000

This parameter configures the exposure used in manual mode for Snapshot mode.

Each integer value represents 100  $\mu$ s worth of exposure. The default value is 100 which results in an exposure setting of 10 ms.

To set the **Fixed Exposure** parameter, scan **Fixed Exposure** followed by four numeric bar codes representing the value. Leading zeros are required. For example, to set a Fixed Exposure value of 99, scan 0, 0, 9, 9. See [Appendix G, Numeric Bar Codes](#) for numeric bar codes.



Fixed Exposure  
(4 digits)

## Fixed Gain

### Parameter # 568 (SSI # F1h 38h)

Type: Byte

Range 1 - 100

This parameter configures the gain setting used in manual mode for Snapshot modes.

A value of 1 indicates that gain is not used for image capture. A value of 100 indicates that maximum gain is used for image capture. The default value of this parameter is 50.

To set the **Fixed Gain** parameter, scan **Fixed Gain** below followed by three numeric bar codes representing the value. Leading zeros are required. For example, to set a Fixed Gain value of 99, scan 0, 9, 9. See [Appendix G, Numeric Bar Codes](#) for numeric bar codes.



Fixed Gain

## Gain/Exposure Priority for Snapshot Mode

### Parameter # 562 (SSI # F1h 32h)

This parameter alters the digital scanner gain exposure priority when it acquires an image in Snapshot Mode in auto exposure mode.

- Scan **Low Exposure Priority** to set a mode in which the digital scanner favors higher gain over exposure to capture an image. This results in an image that is less susceptible to motion blur at the expense of noise artifacts. However, for most applications, the amount of noise is acceptable.
- Scan **Low Gain Priority** to set a mode in which the digital scanner favors longer exposure time rather than higher gain to capture an image. This ensures that the image is less noisy and produces fewer artifacts during post processing activities like image enhancement (sharpening). The mode is recommended for fixed mount / fixed object image capture since the image acquired is susceptible to motion blur.
- Scan **Autodetect** (default) to set a mode in which the digital scanner automatically selects Gain Priority or Low Exposure Priority mode for Snapshot Mode. If the digital scanner is in a magnetic reed switch enabled stand (or it is configured in Blink Mode), it uses Low Gain Priority mode. Otherwise, it uses the Low Exposure Priority mode.



**Low Gain Priority  
(0)**



**Low Exposure Priority  
(1)**



**\* Autodetect  
(2)**

## Snapshot Mode Timeout

### Parameter # 323 (SSI # F0h 43h)

This parameter sets the amount of time the digital scanner remains in Snapshot Mode. The digital scanner exits Snapshot Mode when you pull the trigger, or when the Snapshot Mode Timeout elapses. To set this timeout value, scan the **Set Snapshot Mode Timeout** bar code below followed by a bar code from [Appendix G, Numeric Bar Codes](#). The default value is 0 which represents 30 seconds; values increment by 30. For example, 1 = 60 seconds, 2 = 90 seconds, etc.

To quickly re-set the default timeout to 30 seconds, scan the **30 Seconds** bar code below.

If you select **No Timeout**, the digital scanner remains in Snapshot Mode until you pull the trigger.



**Set Snapshot Mode Timeout**

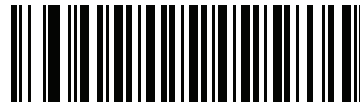

**\*30 Seconds**

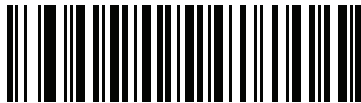

**No Timeout**

## Snapshot Aiming Pattern

### Parameter # 300 (SSI # F0h 2Ch)

Select **Enable Snapshot Aiming Pattern** to project the aiming pattern when in Snapshot Mode, or **Disable Snapshot Aiming Pattern** to turn the aiming pattern off.



\*Enable Snapshot Aiming Pattern  
(1)



Disable Snapshot Aiming Pattern  
(0)

## Silence Operational Mode Changes

### Parameter # 1293 (SSI # F8h 05h 0Dh)

Enable this feature to silence the beeper when switching between operational modes (e.g., from Decode Mode to Snapshot Mode).



Silence Operational Mode Changes (Enable)  
(1)



\*Do Not Silence Operational Mode Changes (Disable)  
(0)

## Image Cropping

### Parameter # 301 (SSI # F0h 2Dh)

This parameter crops a captured image. Select **Disable Image Cropping** to present the full 1280 x 960 pixels. Select **Enable Image Cropping** to crop the image to the pixel addresses set in [Crop to Pixel Addresses on page 6-11](#).



**Enable Image Cropping  
(1)**



**\*Disable Image Cropping  
(Use Full 1200 x 800 Pixels)  
(0)**

## Crop to Pixel Addresses

**Parameter # 315 (SSI # F4h F0h 3Bh) (Top)**

**Parameter # 316 (SSI # F4h F0h 3Ch) (Left)**

**Parameter # 317 (SSI # F4h F0h 3Dh) (Bottom)**

**Parameter # 318 (SSI # F4h F0h 3Eh) (Right)**

If you selected **Enable Image Cropping**, set the pixel addresses from (0,0) to (1259 x 959) to crop to.

Columns are numbered from 0 to 1279, rows from 0 to 959. Specify four values for Top, Left, Bottom, and Right, where Top and Bottom correspond to row pixel addresses, and Left and Right correspond to column pixel addresses. For example, for a 4 row x 8 column image in the extreme bottom-right section of the image set the following values:

Top = 796, Bottom = 959, Left = 1272, Right = 1279

To set the crop to pixel address, scan each pixel address bar code below followed by four numeric bar codes representing the value. Leading zeros are required. For example, to crop the top pixel address to 3, scan 0, 0, 0, 3. See [Appendix G, Numeric Bar Codes](#) for numeric bar codes. The defaults are:

Top = 0, Bottom = 959, Left = 0, Right = 1279

✓ **NOTE** The digital scanner has a cropping resolution of 4 pixels. Setting the cropping area to less than 4 pixels (after resolution adjustment, see [Image Size \(Number of Pixels\) on page 6-12](#)) transfers the entire image.



**Top Pixel Address**  
(0 - 799 Decimal)

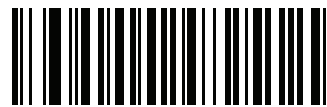

**Left Pixel Address**  
(0 - 1279 Decimal)



**Bottom Pixel Address**  
(0 - 959 Decimal)

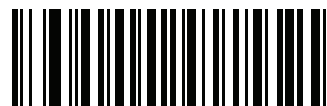

**Right Pixel Address**  
(0 - 1279 Decimal)

## Image Size (Number of Pixels)

### Parameter # 302 (SSI # F0h 2Eh)

This option alters image resolution before compression. Multiple pixels are combined to one pixel, resulting in a smaller image containing the original content with reduced resolution.

Select one of the following values:

**Table 6-2** *Image Sizes*

Resolution Value	Uncropped Image Size
Full	1280 x 960
1/2	640 x 400
1/4	320 x 200



**\*Full Resolution  
(0)**



**1/2 Resolution  
(1)**



**1/4 Resolution  
(3)**



## Image Brightness (Target White)

### Parameter # 390 (SSI # F0h 86h)

Type: Byte

Range: 1 - 240

This parameter sets the Target White value used in Snapshot mode when using auto exposure. White and black are defined as 240 decimal and 1, respectively. Setting the value to the factory default of 180 sets the white level of the image to ~180.

To set the Image Brightness parameter, scan **Image Brightness** below followed by three numeric bar codes representing the value. Leading zeros are required. For example, to set an Image Brightness value of 99, scan 0, 9, 9. See [Appendix G, Numeric Bar Codes](#) for numeric bar codes.



\*180



Image Brightness  
(3 digits)

## JPEG Image Options

### Parameter # 299 (SSI # F0h 2Bh)

Select an option to optimize JPEG images for either size or for quality. Scan the **JPEG Quality Selector** bar code to enter a quality value; the digital scanner then selects the corresponding image size. Scan the **JPEG Size Selector** bar code to enter a size value; the digital scanner then selects the best image quality.



\*JPEG Quality Selector  
(1)



JPEG Size Selector  
(0)

## JPEG Target File Size

### Parameter # 561 (SSI # F1h 31h)

Type: Word

Range: 5-350

This parameter defines the target JPEG file size in terms 1 Kilobytes (1024 bytes). The default value is 160 kB which represents 160 Kilobytes.



**CAUTION** JPEG compress may take 10 to 15 seconds based on the amount of information in the target image. Scanning **JPEG Quality Selector** (default setting) on [page 6-13](#) produces a compressed image that is consistent in quality and compression time.

To set the JPEG Target File Size parameter, scan **JPEG Target File Size** below followed by three numeric bar codes representing the value. Leading zeros are required. For example, to set an image file size value of 99, scan 0, 9, 9 in [Appendix G, Numeric Bar Codes](#).



JPEG Target File Size  
(3 digits)

## JPEG Quality and Size Value

### JPEG Quality = Parameter # 305 (SSI # F0h 31h)

If you selected **JPEG Quality Selector**, scan the **JPEG Quality Value** bar code followed by 3 bar codes from [Appendix G, Numeric Bar Codes](#) corresponding to a value from 5 to 100, where 100 represents the highest quality image.



JPEG Quality Value  
(Default: 065)  
(5 - 100 Decimal)

## Image Enhancement

### Parameter # 564 (SSI # F1h 34h)

This parameter configures the digital scanner's Image Enhance feature. This feature uses a combination of edge sharpening and contrast enhancement to produce an image that is visually pleasing.

The levels of image enhancement are:

- Off (0)
- Low (1) - Default
- Med (2)
- High (3).



**Off  
(0)**



**\*Low  
(1)**



**Medium  
(2)**



**High  
(3)**

## Image File Format Selector

### Parameter # 304 (SSI # F0h 30h)

Select an image format appropriate for the system (BMP, TIFF, or JPEG). The digital scanner stores captured images in the selected format.



**BMP File Format  
(3)**



**\*JPEG File Format  
(1)**



**TIFF File Format  
(04h)**

## Image Rotation

### Parameter # 665 (SSI # F1h 99h)

This parameter controls the rotation of the image by 0, 90, 180, or 270 degrees.



**\*Rotate 0°  
(0)**



**Rotate 90°  
(1)**



**Rotate 180°  
(2)**



**Rotate 270°  
(3)**

## Bits Per Pixel

### Parameter # 303 (SSI # F0h 2Fh)

Select the number of significant bits per pixel (BPP) to use when capturing an image. Select **1 BPP** for a black and white image, **4 BPP** to assign 1 of 16 levels of gray to each pixel, or **8 BPP** to assign 1 of 256 levels of gray to each pixel.



**NOTE** The digital scanner ignores these settings for JPEG file formats, which only support **8 BPP**.

The digital scanner ignores 1 BPP for TIFF file formats, which only support **4 BPP** and **8 BPP**. 1 BPP is coerced to 4 BPP for TIFF file formats.



**1 BPP**  
**(0)**



**4 BPP**  
**(1)**



**\*8 BPP**  
**(2)**

## Signature Capture

### Parameter # 93 (SSI # 5Dh)

A signature capture bar code is a special-purpose symbology which delineates a signature capture area in a document with a machine-readable format. The recognition pattern is variable so it can optionally provide an index to various signatures. The region inside the bar code pattern is considered the signature capture area. See [Appendix K, Signature Capture Code](#) for more information.

### Output File Format

Decoding a signature capture bar code de-skews the signature image and converts the image to a BMP, JPEG, or TIFF file format. The output data includes the file descriptor followed by the formatted signature image.

**Table 6-3** *Output Formats*

File Descriptor			Signature Image
Output Format (1 byte)	Signature Type (1 byte)	Signature Image Size (4 bytes) (BIG Endian)	
JPEG - 1 BMP - 3 TIFF - 4	1-8	0x00000400	0x00010203....

To enable or disable Signature Capture, scan the appropriate bar code below.



**Enable Signature Capture  
(1)**



**\*Disable Signature Capture  
(0)**

## Signature Capture File Format Selector

### Parameter # 313 (SSI # F0h 39h)

Select a signature file format appropriate for the system (BMP, TIFF, or JPEG). The digital scanner stores captured signatures in the selected format.



**BMP Signature Format**  
(3)



**\*JPEG Signature Format**  
(1)



**TIFF Signature Format**  
(4)



## Signature Capture Bits Per Pixel

### Parameter # 314 (SSI # F0h 3Ah)

Select the number of significant bits per pixel (BPP) to use when capturing a signature. Select **1 BPP** for a black and white image, **4 BPP** to assign 1 of 16 levels of gray to each pixel, or **8 BPP** to assign 1 of 256 levels of gray to each pixel.

✓ **NOTE** The digital scanner ignores these settings for JPEG file formats, which only support **8 BPP**.



**1 BPP**  
**(0)**



**4 BPP**  
**(1)**



**\*8 BPP**  
**(2)**

## Signature Capture Width

### Parameter # 366 (SSI # F4h F0h 6Eh)

The aspect ratio of the Signature Capture Width and Signature Capture Height parameters must match that of the signature capture area. For example, a 4 x 1 inch signature capture area would require a 4 to 1 aspect ratio of width to height.

To set the width of the signature capture box, scan the **Signature Capture Width** bar code, followed by 4 bar codes from [Appendix G, Numeric Bar Codes](#) corresponding to a value in the range of 016 to 1280 decimal.



**Signature Capture Width**  
(Default: 400)  
(016 - 1280 Decimal)

## Signature Capture Height

### Parameter # 367 (SSI # F4h F0h 6Fh)

To set the height of the signature capture box, scan the **Signature Capture Height** bar code, followed by 3 bar codes from [Appendix G, Numeric Bar Codes](#) corresponding to a value in the range of 016 to 800 decimal.



**Signature Capture Height (Default: 100)**  
(016 - 800 Decimal)

## Signature Capture JPEG Quality

### Parameter # 421 (SSI # F0h A5h)

Scan the **JPEG Quality Value** bar code followed by 3 bar codes from [Appendix G, Numeric Bar Codes](#) corresponding to a value from 005 to 100, where 100 represents the highest quality image.



**JPEG Quality Value (Default: 065)**  
(5 - 100 Decimal)

# CHAPTER 7 USB INTERFACE

---

## Introduction

This chapter provides instructions for programming the imaging imager to interface with a USB host. The imaging imager scanner connects directly to a USB host, or a powered USB hub. The USB host can power the imaging imager.

Throughout the programming bar code menus, default values are indicated with asterisks (\*).

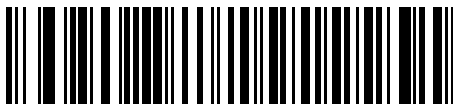

\*Indicates Default — \*North American Standard USB Keyboard — Feature/Option

---

## Connecting a USB Interface

The imaging imager scanner connects with USB capable hosts including:

- Desktop PCs and Notebooks
- Apple™ iMac, G4, iBooks (North America only)
- IBM SurePOS terminals
- Sun, IBM, and other network computers that support more than one keyboard.

The following operating systems support the imaging imager scanner through USB:

- Windows 98, 2000, ME, XP, Windows 7, Windows 8, Windows 10
- MacOS 8.5 and above
- IBM 4690 OS.

The imaging imager also interfaces with other USB hosts which support USB Human Interface Devices (HID).

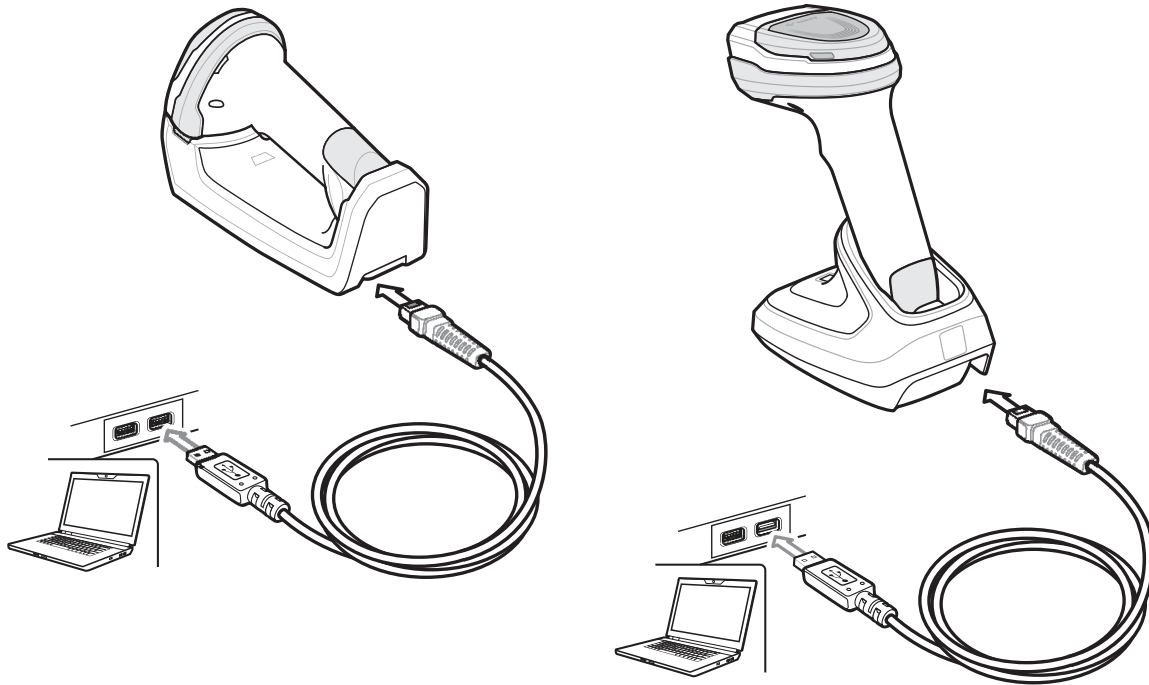

**Figure 7-1** *USB Connection*

To connect the cradle to a USB host:

1. Attach the modular connector of the USB interface cable to the cable interface port on the digital scanner. See [Connecting the Cradle on page 1-4](#).
2. Plug the series A connector in the USB host or hub, or plug the Plus Power connector in an available port of the IBM SurePOS terminal.
3. Ensure all connections are secure.
4. Pair the digital scanner to the cradle by scanning the bar code on the cradle.
5. Select the USB device type by scanning the appropriate bar code from [USB Device Type on page 7-4](#).
6. On first installation when using Windows, the software displays a prompt to select or install the *Human Interface Device* driver. To install the Human Interface Device driver provided by Windows, click **Next** through all the choices and click **Finished** on the last choice. The digital scanner powers up during this installation.
7. To modify any other parameter options, scan the appropriate bar codes in this chapter.
8. Connect an external power supply if desired.

✓ **NOTES** Interface cables vary depending on configuration. The connectors illustrated in [Figure 7-1](#) are examples only. The connectors may be different from those illustrated, but the steps to connect the cradle remain the same.

Disconnect the host cables before the power supply, or the digital scanner may not recognize the new host.

If problems occur, see [Troubleshooting on page 3-4](#).

## USB Parameter Defaults

[Table 7-1](#) lists the defaults for USB host parameters. If any option needs to be changed, scan the appropriate bar code(s) provided in the Parameter Descriptions section beginning on [page 7-4](#).

✓ **NOTES** See [Appendix A, Standard Parameter Defaults](#) for all user preferences, hosts, symbologies, and miscellaneous default parameters.

See [Appendix B, Country Codes](#) for USB Country Keyboard Types (Country Codes).

**Table 7-1** USB Host Default Table

Parameter	Default	Page Number
<b>USB Host Parameters</b>		
USB Device Type	HID Keyboard Emulation	<a href="#">7-4</a>
Symbol Native API (SNAPI) Status Handshaking	Enable	<a href="#">7-6</a>
USB Keystroke Delay	No Delay	<a href="#">7-6</a>
USB CAPS Lock Override	Disable	<a href="#">7-7</a>
USB Ignore Unknown Characters	Send	<a href="#">7-7</a>
USB Convert Unknown to Code 39	Disable	<a href="#">7-8</a>
Emulate Keypad	Enable	<a href="#">7-8</a>
Emulate Keypad with Leading Zero	Enable	<a href="#">7-8</a>
Quick Keypad Emulation	Enable	<a href="#">7-9</a>
USB FN1 Substitution	Disable	<a href="#">7-9</a>
Function Key Mapping	Disable	<a href="#">7-10</a>
Simulated Caps Lock	Disable	<a href="#">7-10</a>
Convert Case	No Case Conversion	<a href="#">7-11</a>
USB Static CDC	Enable	<a href="#">7-11</a>
Ignore Beep	Enable	<a href="#">7-12</a>
Ignore Bar Code Configuration	Enable	<a href="#">7-12</a>
USB Polling Interval	3 msec	<a href="#">7-14</a>
USB Fast HID	Enable	<a href="#">7-15</a>
IBM Specification Version	Version 2.2	<a href="#">7-15</a>

---

## USB Host Parameter

### USB Device Type

Select the desired USB device type.



#### NOTES

1. When changing USB device types, the scanner automatically restarts. The imaging imager issues a power-up beep sequence.
2. Before scanning *USB CDC Host (Note 1) on page 7-5*, install the appropriate USB CDC Driver on the host to ensure the scanner does not stall during power up (due to a failure to enumerate USB). Go to [www.zebra.com/support](http://www.zebra.com/support), Support & Downloads > Barcode Scanners > USB CDC Driver, select the appropriate Windows platform, and download the appropriate CDC Driver (64 bit or 32 bit).

To recover a stalled scanner:

Install the USB CDC Driver

or

Unplug the USB cable and add power. Connect the scanner via Bluetooth and scan HID Keyboard or another host.

3. Select **IBM Hand-Held USB** to disable data transmission when an IBM register issues a Scan Disable command. Aim, illumination, and decoding is still permitted. Select **OPOS (IBM Hand-held with Full Disable)** to completely shut off the scanner when an IBM register issues a Scan Disable command, including aim, illumination, decoding, and data transmission.

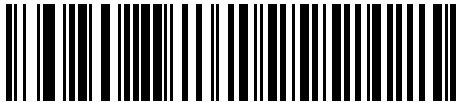

\*HID Keyboard Emulation



IBM Table Top USB

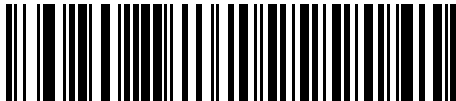

IBM Hand-Held USB



OPOS  
(IBM Hand-held with Full Disable)

## USB Device Type (continued)

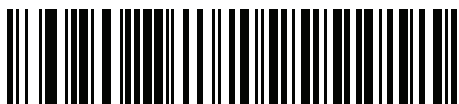

Simple COM Port Emulation



SSI over USB CDC

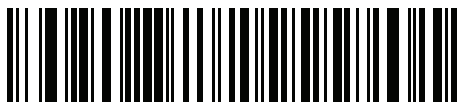

USB CDC Host  
(Note 1)



Symbol Native API (SNAPI) without Imaging Interface



Symbol Native API (SNAPI) with Imaging Interface

## Symbol Native API (SNAPI) Status Handshaking

After selecting a SNAPI interface as the USB device type, select whether to enable or disable status handshaking.



**\*Enable SNAPI Status Handshaking**



**Disable SNAPI Status Handshaking**

## USB Keystroke Delay

This parameter sets the delay, in milliseconds, between emulated keystrokes. Scan a bar code below to increase the delay when hosts require a slower transmission of data.

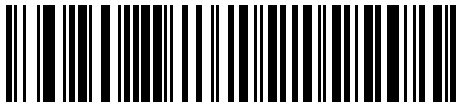

**\*No Delay**

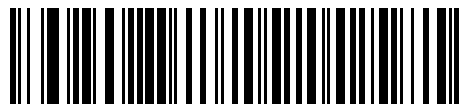

**Medium Delay (20 msec)**

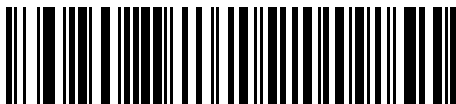

**Long Delay (40 msec)**



## USB CAPS Lock Override

This option applies only to the HID Keyboard Emulation device. When enabled, the case of the data is preserved regardless of the state of the caps lock key. This setting is always enabled for the “Japanese, Windows (ASCII)” keyboard type and can not be disabled.

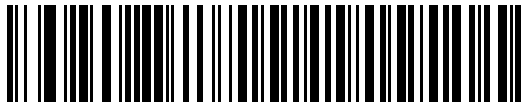

**Override Caps Lock Key  
(Enable)**

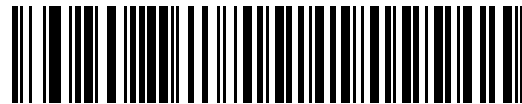

**\*Do Not Override Caps Lock Key  
(Disable)**

## USB Ignore Unknown Characters

This option applies only to the HID Keyboard Emulation device and IBM device. Unknown characters are characters the host does not recognize. When **Send Bar Codes With Unknown Characters** is selected, all bar code data is sent except for unknown characters, and no error beeps sound. When **Do Not Send Bar Codes With Unknown Characters** is selected, bar code data is sent up to the first unknown character, then the imaging imager scanner issues an error beep.

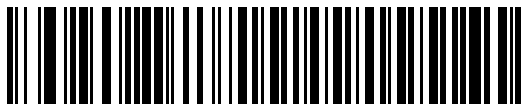

**\*Send Bar Codes with Unknown Characters**

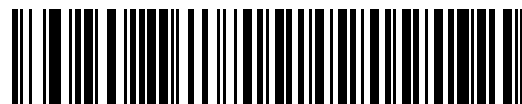

**Do Not Send Bar Codes with Unknown Characters**

## USB Convert Unknown to Code 39

This option applies only to the IBM Hand-held, IBM Tabletop, and OPOS devices. Scan a bar code below to enable or disable converting unknown bar code type data to Code 39.



**\*Disable Convert Unknown to Code 39**



**Enable Convert Unknown to Code 39**

## Emulate Keypad

When enabled, all characters are sent as ASCII sequences over the numeric keypad. For example ASCII A would be sent as "ALT make" 0 6 5 "ALT Break."



**Disable Keypad Emulation**

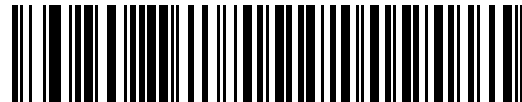

**\*Enable Keypad Emulation**

## Emulate Keypad with Leading Zero

Enable this to send character sequences sent over the numeric keypad as ISO characters which have a leading zero. For example ASCII A transmits as "ALT MAKE" 0 0 6 5 "ALT BREAK".



**Disable Keypad Emulation with Leading Zero**



**\*Enable Keypad Emulation with Leading Zero**

## Quick Keypad Emulation

This option applies only to the HID Keyboard Emulation Device and if Emulate Keypad is enabled. This parameter enables a quicker method of keypad emulation where ASCII sequences are only sent for ASCII characters not found on the keyboard. The default value is **Disable**.



**\*Enable**



**Disable**

## USB Keyboard FN 1 Substitution

This option applies only to the USB HID Keyboard Emulation device. When enabled, this allows replacement of any FN 1 characters in an EAN 128 bar code with a Key Category and value chosen by the user (see [FN1 Substitution Values on page 5-40](#) to set the Key Category and Key Value).

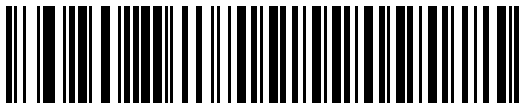

**Enable FN1 Substitution**



**\*Disable FN1 Substitution**

## Function Key Mapping

ASCII values under 32 are normally sent as a control-key sequences (see [Table I-1 on page I-1](#)). When this parameter is enabled, the keys in bold are sent in place of the standard key mapping. Table entries that do not have a bold entry remain the same whether or not this parameter is enabled.

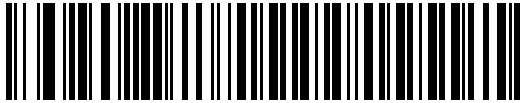

**\*Disable Function Key Mapping**

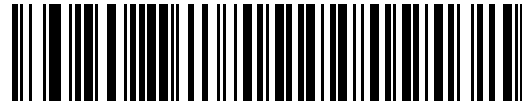

**Enable Function Key Mapping**

## Simulated Caps Lock

When enabled, the imaging imager scanner inverts upper and lower case characters on the imaging imager scanner bar code as if the Caps Lock state is enabled on the keyboard. This inversion is done regardless of the current state of the keyboard Caps Lock state.

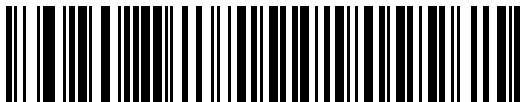

**\*Disable Simulated Caps Lock**



**Enable Simulated Caps Lock**

## Convert Case

When enabled, the imaging imager scanner converts all bar code data to the selected case.

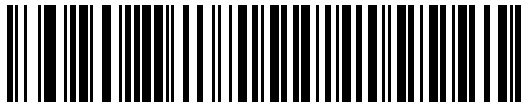

**\*No Case Conversion**



**Convert All to Upper Case**

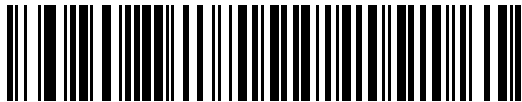

**Convert All to Lower Case**

## USB Static CDC

### Parameter # 670

When disabled, each device connected consumes another COM port (first device = COM1, second device = COM2, third device = COM3, etc.)

When enabled, each device connects to the same COM port.



**\*Enable USB Static CDC  
(1)**



**Disable USB Static CDC  
(0)**

---

## Optional USB Parameters

If you configure the imaging imager scanner and find the settings were not saved, or changed, when the system is restarted scan the bar codes that follow to override USB interface defaults.

Scan a bar code below after setting defaults and before configuring the imaging imager scanner.

### Ignore Beep

The host can send a beep request to the imaging imager scanner. When this parameter is enabled, the request is not sent to the attached imaging imager scanner. All directives are still acknowledged to the USB host as if it were processed.



**Disable**



**\*Enable**

### Ignore Bar Code Configuration

The host has the ability to enable/disable code types. When this parameter is enabled, the request is not sent to the attached imaging imager scanner. All directives are still acknowledged to the USB host as if it were processed.



**Disable**



**\*Enable**

## USB Polling Interval

Scan a bar code below to set the polling interval. The polling interval determines the rate at which data can be sent between the scanner and host computer. A lower number indicates a faster data rate.



**NOTE** When changing USB Device Types, the imaging imager automatically restarts and issues a disconnect-reconnect beep sequence.



**IMPORTANT** Ensure your host machine can handle the selected data rate.



1 msec

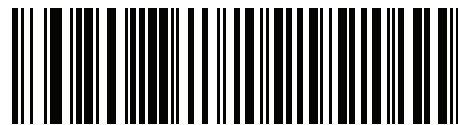

2 msec



\*3 msec



4 msec

### USB Polling Interval (continued)

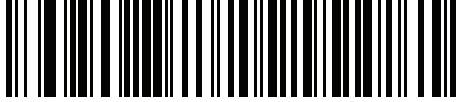

5 msec



6 msec

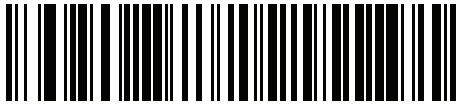

7 msec



8 msec

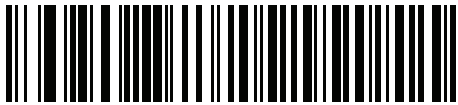

9 msec



10 msec



## USB Fast HID

This option transmits USB HID data at a faster rate.

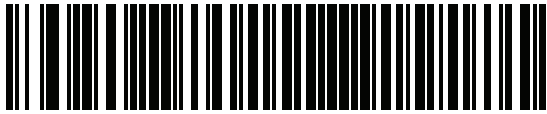

**\*Enable**

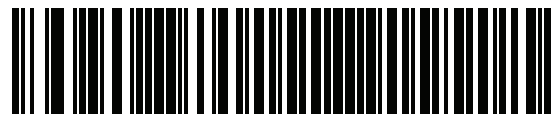

**Disable**

## IBM Specification Version

The IBM USB interface specification version selected defines how code types are reported over the IBM USB interface.

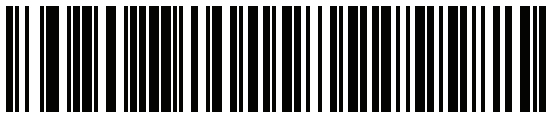

**Original Specification**



**\*Version 2.2**

---

## ASCII Character Sets for USB

See [Appendix I, ASCII Character Sets](#) for the following:

- ASCII Character Set ([Table I-1 on page I-1](#))
- ALT Key Character Set ([Table I-2 on page I-6](#))
- GUI Key Character Set ([Table I-3 on page I-7](#))
- F Key Character Set ([Table I-5 on page I-10](#)).

# CHAPTER 8 SSI INTERFACE

---

## Introduction

This chapter describes the system requirements of the Simple Serial Interface (SSI), which provides a communications link between Zebra decoders (e.g., scan engines, slot scanners, hand-held scanners, two-dimensional scanners, hands-free scanners, and RF base stations) and a serial host. It provides the means for the host to control the decoder or scanner.

---

## Communications

All communication between the digital scanner and host occurs over the hardware interface lines using the SSI protocol. Refer to the *Simple Serial Interface Programmer's Guide*, p/n 72-40451-xx, for more information on SSI.

The host and the digital scanner exchange messages in packets. A packet is a collection of bytes framed by the proper SSI protocol formatting bytes. The maximum number of bytes per packet that the SSI protocol allows for any transaction is 257 (255 bytes + 2 byte checksum).

Decode data can be sent as ASCII data (unpacketed), or as part of a larger message (packeted), depending on the digital scanner configuration.

SSI performs the following functions for the host device:

- Maintains a bi-directional interface with the digital scanner
- Allows the host to send commands that control the digital scanner
- Passes data from the digital scanner to a host device in SSI packet format or straight decode message.

The working environment of the SSI consists of a digital scanner, a serial cable which attaches to the host device, and in some instances, a power supply.

SSI transmits all decode data including special formatting (e.g., AIM ID). Parameter settings can control the format of the transmitted data.

The digital scanner can also send parameter information, product identification information, or event codes to the host.

All commands sent between the digital scanner and host must use the format described in the SSI Message Formats section. [SSI Transactions on page 8-3](#) describes the required sequence of messages in specific cases.

*Table 8-1* lists all the SSI opcodes the digital scanner supports. It identifies the SSI partner allowed to send a message of each type. The host transmits opcodes designated type H. The digital scanner transmits type D opcodes, and either partner can transmit Host/Decoder (H/D) types.

**Table 8-1** SSI Commands

Name	Type	Opcode	Description
AIM_OFF	H	0xC4	Deactivate aim pattern.
AIM_ON	H	0xC5	Activate aim pattern.
BEEP	H	0xE6	Sound the beeper.
CAPABILITIES_REPLY	D	0xD4	Reply to CAPABILITIES_REQUEST; contains a list of the capabilities and commands the decoder supports.
CAPABILITIES_REQUEST	H	0xD3	Request capabilities report from the decoder.
CMD_ACK	H/D	0xD0	Positive acknowledgment of received packet.
CMD_NAK	H/D	0xD1	Negative acknowledgment of received packet.
DECODE_DATA	D	0xF3	Decode data in SSI packet format.
EVENT	D	0xF6	Event indicated by associated event code.
LED_OFF	H	0xE8	De-activate LED output.
LED_ON	H	0xE7	Activate LED output.
PARAM_DEFAULTS	H	0xC8	Set parameter default values.
PARAM_REQUEST	H	0xC7	Request values of certain parameters.
PARAM_SEND	H/D	0xC6	Send parameter values.
REPLY_REVISION	D	0xA4	Reply to REQUEST_REVISION contains decoder's software/hardware configuration.
REQUEST_REVISION	H	0xA3	Request the decoder's configuration.
SCAN_DISABLE	H	0xEA	Prevent the operator from scanning bar codes.
SCAN_ENABLE	H	0xE9	Permit bar code scanning.
SLEEP	H	0xEB	Request to place the decoder into low power.
START_DECODE	H	0xE4	Tell decoder to attempt to decode a bar code.
STOP_DECODE	H	0xE5	Tell decoder to abort a decode attempt.
WAKEUP	H	N/A	Wakeup decoder after it has entered low power mode.

For details of the SSI protocol, refer to the *Simple Serial Interface Programmer's Guide* (72-40451-xx).

---

## SSI Transactions

### General Data Transactions

#### ACK/NAK Handshaking

If you enable ACK/NAK handshaking, all packeted messages must have a CMD\_ACK or CMD\_NAK response, unless the command description states otherwise. This parameter is enabled by default. Zebra recommends leaving this handshaking enabled to provide feedback to the host. Raw decode data and WAKEUP do not use ACK/NAK handshaking since they are not packeted data.

Following is an example of a problem which can occur if you disable ACK/NAK handshaking:

- The host sends a PARAM\_SEND message to the digital scanner to change the baud rate from 9600 to 19200.
- The digital scanner cannot interpret the message.
- The digital scanner does not implement the change the host requested.
- The host assumes that the parameter change occurred and acts accordingly.
- Communication is lost because the change did not occur on both sides.

If you enable ACK/NAK handshaking, the following occurs:

- The host sends a PARAM\_SEND message.
- The digital scanner cannot interpret the message.
- The digital scanner CMD\_NAKs the message.
- The host resends the message.
- The digital scanner receives the message successfully, responds with CMD\_ACK, and implements parameter changes.

## Transfer of Decode Data

The Decode Data Packet Format parameter controls how decode data is sent to the host. Set this parameter to send the data in a DECODE\_DATA packet. Clear this parameter to transmit the data as raw ASCII data.

✓ **NOTE** When transmitting decode data as raw ASCII data, ACK/NAK handshaking does not apply regardless of the state of the ACK/NAK handshaking parameter.

### ACK/NAK Enabled and Packeted Data

The digital scanner sends a DECODE\_DATA message after a successful decode. The digital scanner waits for a programmable time-out for a CMD\_ACK response. If it does not receive the response, the digital scanner tries to send two more times before issuing a host transmission error. If the digital scanner receives a CMD\_NAK from the host, it may attempt a retry depending on the cause field of the CMD\_NAK message.

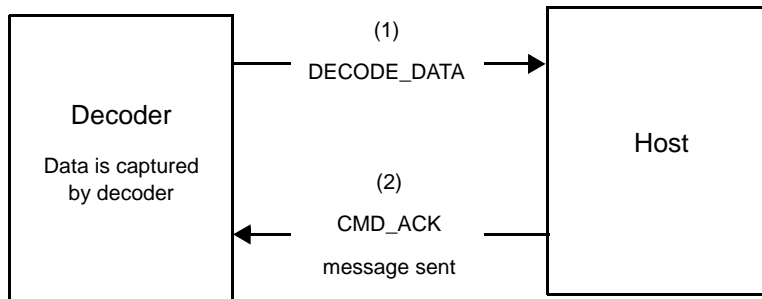

### ACK/NAK Enabled and Unpacketed ASCII Data

Even though the ACK/NAK handshaking is enabled, no handshaking occurs because the handshaking applies only to packeted data. In this example the **packeted\_decode** parameter is disabled.

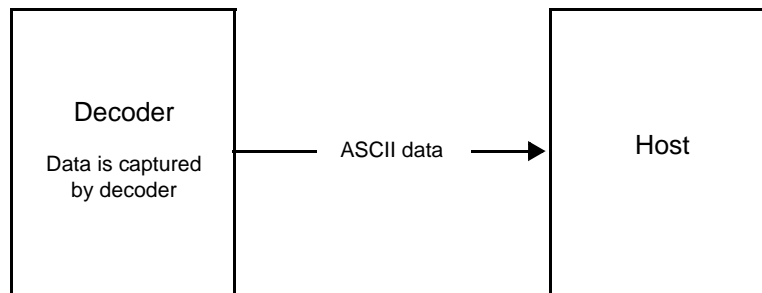

### ACK/NAK Disabled and Packeted DECODE\_DATA

In this example ACK/NAK does not occur even though **packeted\_decode** is enabled because the ACK/NAK handshaking parameter is disabled.

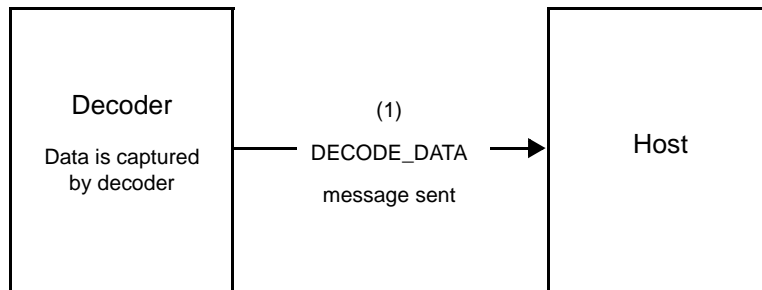

### ACK/NAK Disabled and Unpacketed ASCII Data

Data captured by the digital scanner is sent to the host.

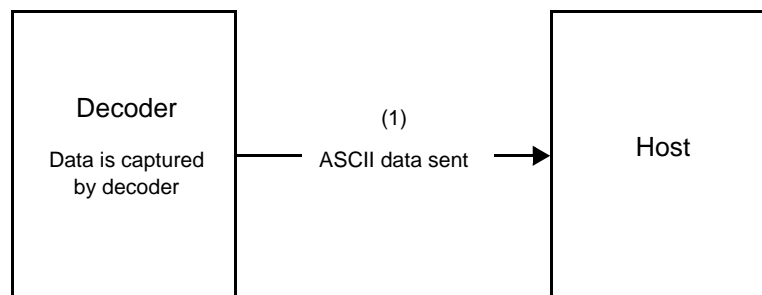

---

## Communication Summary

### RTS/CTS Lines

All communication must use RTS/CTS handshaking as described in the *Simple Serial Interface Programmer's Guide*, p/n 72-40451-xx. If hardware handshaking is disabled or bypassed, the WAKEUP command must be sent prior to all other communications, or the first byte of a communication message may be lost during the digital scanner wakeup sequence.

### ACK/NAK Option

Enable or disable ACK/NAK handshaking. This handshaking is enabled by default and Zebra recommends leaving it enabled. Disabling this handshaking can cause communication problems, as handshaking is the only acknowledgment that a message was received, and if it was received correctly. ACK/NAK is not used with unpacketed decode data regardless of whether or not it is enabled.

### Number of Data Bits

All communication with the digital scanner must use 8-bit data.

### Serial Response Time-out

The Serial Response Time-out parameter determines how long to wait for a handshaking response before trying again, or aborting any further attempts. Set the same value for both the host and digital scanner.



**NOTE** You can temporarily change the Serial Response Time-out when the host takes longer to process an ACK or longer data string. Zebra does not recommend frequent permanent changes due to limited write cycles of non-volatile memory.

### Retries

When sending data, the host should resend twice after the initial send if the digital scanner does not respond with an ACK or NAK (if ACK/NAK handshaking is enabled), or response data (e.g., PARAM\_SEND, REPLY\_REVISION). If the digital scanner replies with a NAK RESEND, the host resends the data. All resent messages must have the resend bit set in the Status byte.

The digital scanner resends data two times after the initial send if the host fails to reply with an ACK or NAK (if ACK/NAK handshaking is enabled).

### Baud Rate, Stop Bits, Parity, Response Time-out, ACK/NAK Handshake

If you use PARAM\_SEND to change these serial parameters, the ACK response to the PARAM\_SEND uses the previous values for these parameters. The new values then take effect for the next transaction.

### Errors

The digital scanner issues a communication error when:

- The CTS line is asserted when the digital scanner tries to transmit, and is still asserted on each of 2 successive retries
- Failure to receive an ACK or NAK after initial transmit and two resends.

---

## Things to Remember When Using SSI Communication

When not using hardware handshaking, space messages sufficiently apart. The host must not communicate with the digital scanner if the digital scanner is transmitting.

When using hardware handshaking, frame each message properly with the handshaking signals. Do not try to send two commands within the same handshaking frame.

There is a permanent/temporary bit in the PARAM\_SEND message. Removing power from the digital scanner discards temporary changes. Permanent changes are written to non-volatile memory. Frequent changes shorten the life of the non-volatile memory.



## Using Time Delay to Low Power Mode with SSI

[Time Delay to Low Power Mode on page 5-17](#) provides bar codes to select a general time delay. To program a more specific delay value, use an SSI command according to [Table 8-2](#).

**Table 8-2** Values for Selecting Time Delay to Low Power

Value	Timeout	Value	Timeout	Value	Timeout	Value	Timeout
0x00	15 min	0x10	1 sec	0x20	1 min	0x30	1 Hour
0x01	30 min	0x11	1 sec	0x21	1 min	0x31	1 Hour
0x02	60 min	0x12	2 sec	0x22	2 min	0x32	2 Hours
0x03	90 min	0x13	3 sec	0x23	3 min	0x33	3 Hours
N/A	N/A	0x14	4 sec	0x24	4 min	0x34	4 Hours
N/A	N/A	0x15	5 sec	0x25	5 min	0x35	5 Hours
N/A	N/A	0x16	6 sec	0x26	6 min	0x36	6 Hours
N/A	N/A	0x17	7 sec	0x27	7 min	0x37	7 Hours
N/A	N/A	0x18	8 sec	0x28	8 min	0x38	8 Hours
N/A	N/A	0x19	9 sec	0x29	9 min	0x39	9 Hours
N/A	N/A	0x1A	10 sec	0x2A	10 min	0x3A	10 Hours
N/A	N/A	0x1B	15 sec	0x2B	15 min	0x3B	15 Hours
N/A	N/A	0x1C	20 sec	0x2C	20 min	0x3C	20 Hours
N/A	N/A	0x1D	30 sec	0x2D	30 min	0x3D	30 Hours
N/A	N/A	0x1E	45 sec	0x2E	45 min	0x3E	45 Hours
N/A	N/A	0x1F	60 sec	0x2F	60 min	0x3F	60 Hours

## Encapsulation of RSM Commands/Responses over SSI

The SSI protocol allows the host to send a command that is variable in length up to 255 bytes. Although there is a provision in the protocol to multi-packet commands from the host, the scan engine does not support this. The host must fragment packets using the provisions in the RSM protocol.

### Command Structure

Byte	7	6	5	4	3	2	1	0
0	Length (not including the checksum)							
1	SSI_MGMT_COMMAND (0x80)							
2	Message Source (4 - Host)							
3	Reserved (0)			Reserved (0)		Reserved (0)	Cont'd packet	Retransmit
4	Payload data (see the following example)							
...								
Length -1								
Length	2's complement checksum (MSB)							
Length +1	2's complement checksum (LSB)							

The expected response in the positive case is SSI\_MGMT\_COMMAND which may be a multi-packet response. For devices that do not support the SSI\_MGMT\_COMMAND, the response is the standard SSI\_NAK.

### Response Structure

Byte	7	6	5	4	3	2	1	0
0	Length (not including the checksum)							
1	SSI_MGMT_COMMAND (0x80)							
2	Message Source (0 - Decoder)							
3	Reserved (0)			Reserved (0)		Reserved (0)	Cont'd packet	Retransmit
4	Payload data (see the following example)							
...								
Length -1								
Length	2's complement checksum (MSB)							
Length +1	2's complement checksum (LSB)							

## Example Transaction

The following example illustrates how to retrieve diagnostic information (Diagnostic Testing and Reporting (Attribute #10061) decimal) from the engine using encapsulation of RSM commands over SSI. Before sending any RSM command, the host must send the RSM Get Packet Size command to query the packet size supported by the device.

### Command from Host to Query Packet Size Supported by Device

```
0A 80 04 00 00 06 20 00 FF FF FD 4E
```

Where:

- 0A 80 04 00 is encapsulation of RSM commands over SSI command header
- 00 06 20 00 FF FF is RSM Get Packet Size command
- FD 4E is SSI command checksum

### Response from Device with Packet Size Information

```
0C 80 00 00 00 08 20 00 00 F0 00 F0 FD 6C
```

Where:

- 0C 80 00 00 is encapsulation of RSM command over SSI command header
- 00 08 20 00 00 F0 00 F0 is RSM Get Packet Size response
- FD 6C is SSI response checksum

### Command from Host to Retrieve Diagnostic Information

```
0C 80 04 00 00 08 02 00 27 4D 42 00 FE B0
```

Where:

- 0C 80 04 00 is encapsulation of RSM commands over SSI command header
- 00 08 02 00 27 4D 42 00 is attribute Get command requesting attribute 10061 decimal
- FE B0 is SSI command checksum

### Response from Device with Diagnostic Information

```
21 80 00 00 00 1D 02 00 27 4D 41 01 42 00 0E 00 00 00 00 01 03 02 03 03 03 04 03 05 03 06 03 FF FF FC 15
```

Where:

- 21 80 00 00 00 1D 02 00 27 4D 41 01 42 00 0E 00 00 is encapsulation of RSM responses over SSI command header
- 00 00 01 03 02 03 03 03 04 03 05 03 06 03 is attribute Get response which includes diagnostic report value
- FF FF is attribute Get response, packet termination
- FC 15 is SSI response checksum

## Simple Serial Interface Default Parameters

This section describes how to set up the digital scanner with an SSI host. When using SSI, program the digital scanner via bar code menu or SSI hosts commands.

Throughout the programming bar code menus, asterisks (\*) indicate default values.



- ✓ **NOTE** Most computer monitors allow scanning the bar codes directly on the screen. When scanning from the screen, be sure to set the document magnification to a level where you can see the bar code clearly, and bars and/or spaces are not merging.

[Table 8-3](#) lists the defaults for the SSI host. There are two ways to change the default values:

- Scan the appropriate bar codes in this guide. These new values replace the standard default values in memory. To recall the default parameter values, scan the [\\*Restore Defaults](#) bar code on [page 5-5](#).
- Download data through the device serial port using SSI. Hexadecimal parameter numbers appear in this chapter below the parameter title, and options appear in parenthesis beneath the accompanying bar codes. Refer to the *Simple Serial Interface (SSI) Programmer's Guide* for detailed instructions for changing parameters using this method.

- ✓ **NOTE** See [Appendix A, Standard Parameter Defaults](#) for all user preferences, hosts, symbologies, and miscellaneous default parameters.

**Table 8-3** SSI Default Table

Parameter	Parameter Number	SSI Number	Default	Page Number
Select SSI Host	N/A	N/A	N/A	<a href="#">8-11</a>
Baud Rate	156	9Ch	9600	<a href="#">8-12</a>
Parity	158	9Eh	None	<a href="#">8-13</a>
Check Parity	151	97h	Disable	<a href="#">8-14</a>
Stop Bits	157	9Dh	1	<a href="#">8-14</a>
Software Handshaking	159	9Fh	ACK/NAK	<a href="#">8-15</a>
Host RTS Line State	154	9Ah	Low	<a href="#">8-16</a>
Decode Data Packet Format	238	EEh	Send Raw Decode Data	<a href="#">8-16</a>
Host Serial Response Time-out	155	9Bh	2 sec	<a href="#">8-17</a>

**Table 8-3** SSI Default Table (Continued)

Parameter	Parameter Number	SSI Number	Default	Page Number
Host Character Time-out	239	EFh	200 msec	<a href="#">8-18</a>
Multipacket Option	334	F0h 4Eh	Option 1	<a href="#">8-19</a>
Interpacket Delay	335	F0h 4Fh	0 ms	<a href="#">8-20</a>
<b>Event Reporting</b>				
Decode Event	256	F0h 00h	Disable	<a href="#">8-21</a>
Boot Up Event	258	F0h 02h	Disable	<a href="#">8-22</a>
Parameter Event	259	F0h 03h	Disable	<a href="#">8-22</a>

✓ **NOTE** SSI interprets Prefix, Suffix1, and Suffix2 values listed in [Table I-1 on page I-1](#) differently than other interfaces. SSI does not recognize key categories, only the 3-digit decimal value. The default value of 7013 is interpreted as CR only.

---

## SSI Host Parameters

### Select SSI Host

To select SSI as the host interface, scan the following bar code.



**SSI Host**

## Baud Rate

### Parameter # 156 (SSI # 9Ch)

Baud rate is the number of bits of data transmitted per second. Set the digital scanner's baud rate to match the baud rate setting of the host device. Otherwise, data may not reach the host device or may reach it in distorted form.



**\*Baud Rate 9600  
(6)**



**Baud Rate 19,200  
(7)**



**Baud Rate 38,400  
(8)**



**Baud Rate 57,600  
(10)**



**Baud Rate 115,200  
(11)**



**Baud Rate 230,400  
(12)**

**Baud Rate (continued)**

**Baud Rate 460,800  
(13)**



**Baud Rate 921,600  
(14)**

**Parity****Parameter # 158 (SSI # 9Eh)**

A parity check bit is the most significant bit of each ASCII coded character. Select the parity type according to host device requirements.

- Select **Odd** parity and the parity bit has a value 0 or 1, based on data, to ensure that an odd number of 1 bits is contained in the coded character.
- Select **Even** parity and the parity bit has a value 0 or 1, based on data, to ensure that an even number of 1 bits is contained in the coded character.
- If no parity is required, select **None**.



**Odd  
(2)**



**Even  
(1)**



**\*None  
(0)**

## Check Parity

### Parameter # 151 (SSI # 97h)

Select whether or not to check the parity of received characters. Use the Parity parameter to select the type of parity.



**\*Do Not Check Parity  
(0)**



**Check Parity  
(1)**

## Stop Bits

### Parameter # 157 (SSI # 9Dh)

The stop bit(s) at the end of each transmitted character marks the end of transmission of one character and prepares the receiving (host) device for the next character in the serial data stream. Set the number of stop bits (one or two) to match host device requirements.



**\*1 Stop Bit  
(1)**



**2 Stop Bits  
(2)**



## Software Handshaking

### Parameter # 159 (SSI # 9Fh)

This parameter offers control of data transmission in addition to the control hardware handshaking offers. Hardware handshaking is always enabled; you cannot disable it.

- **Disable ACK/NAK Handshaking:** When this option is selected, the digital scanner neither generates nor expects ACK/NAK handshaking packets.
- **Enable ACK/NAK Handshaking:** When this option is selected, after transmitting data, the digital scanner expects either an ACK or NAK response from the host. The digital scanner also ACKs or NAKs messages from the host.

The digital scanner waits up to the programmable Host Serial Response Time-out to receive an ACK or NAK. If the digital scanner does not get a response in this time, it resends its data up to two times before discarding the data and declaring a transmit error.



**Disable ACK/NAK  
(0)**



**\*Enable ACK/NAK  
(1)**

## Host RTS Line State

### Parameter # 154 (SSI # 9Ah)

This parameter sets the expected idle state of the Serial Host RTS line.

The SSI Interface is used with host applications which also implement the SSI protocol. However, you can use the digital scanner in a "scan-and-transmit" mode to communicate with any standard serial communication software on a host PC (see [Decode Data Packet Format on page 8-16](#)). If transmission errors occur in this mode, the host PC may be asserting hardware handshaking lines which interfere with the SSI protocol. Scan the **Host: RTS High** bar code to address this problem.



**\*Host: RTS Low  
(0)**



**Host: RTS High  
(1)**

## Decode Data Packet Format

### Parameter # 238 (SSI # EEh)

This parameter selects whether to transmit decoded data in raw format (unpacked), or with the packet format defined by the serial protocol.

Selecting the raw format disables ACK/NAK handshaking for decode data.



**\*Send Raw Decode Data  
(0)**



**Send Packeted Decode Data  
(1)**

## Host Serial Response Time-out

### Parameter # 155 (SSI # 9Bh)

This parameter specifies how long the digital scanner waits for an ACK or NAK before resending. Also, if the digital scanner wants to send, and the host has already been granted permission to send, the digital scanner waits for the designated time-out before declaring an error.

To set the delay period (options are 2, 5, 7.5, or 9.9 seconds), scan one of the following bar codes.

✓ **NOTE** Other values are available via SSI command.



**\*Low - 2 Seconds  
(20)**



**Medium - 5 Seconds  
(50)**



**High - 7.5 Seconds  
(75)**



**Maximum - 9.9 Seconds  
(99)**

## Host Character Time-out

### Parameter # 239 (SSI # EFh)

This parameter determines the maximum time the digital scanner waits between characters transmitted by the host before discarding the received data and declaring an error.

To set the delay period (options are 200, 500, 750, or 990 ms), scan one of the following bar codes.

✓ **NOTE** Other values are available via SSI command.



**\*Low - 200 ms  
(20)**



**Medium - 500 ms  
(50)**



**High - 750 ms  
(75)**



**Maximum - 990 ms  
(99)**

## Multipacket Option

### Parameter # 334 (SSI # F0h 4Eh)

This parameter controls ACK/NAK handshaking for multi-packet transmissions.

- **Multi-Packet Option 1:** The host sends an ACK / NAK for each data packet during a multi-packet transmission.
- **Multi-Packet Option 2:** The digital scanner sends data packets continuously, with no ACK/NAK handshaking to pace the transmission. The host, if overrun, can use hardware handshaking to temporarily delay digital scanner transmissions. At the end of transmission, the digital scanner waits for a CMD\_ACK or CMD\_NAK.
- **Multi-Packet Option 3:** Option 3 is the same as option 2 with the addition of a programmable interpacket delay.



\*Multipacket Option 1  
(0)



Multipacket Option 2  
(1)



Multipacket Option 3  
(2)

## Interpacket Delay

### Parameter # 335 (SSI # F0h 4Fh)

This parameter specifies the interpacket delay if you selected **Multipacket Option 3**.

To set the delay period (options are 0, 25, 50, 75, or 99 ms), scan one of the following bar codes.

✓ **NOTE** Other values are available via SSI command.



\*Minimum - 0 ms  
(0)



Low - 25 ms  
(25)



Medium - 50 ms  
(50)



High - 75 ms  
(75)



Maximum - 99 ms  
(99)

## Event Reporting

The host can request the digital scanner to provide certain information (events) relative to the digital scanner behavior. Enable or disable the events listed in [Table 8-4](#) and on the following pages by scanning the appropriate bar codes.

**Table 8-4** *Event Codes*

Event Class	Event	Code Reported
Decode Event	Non parameter decode	0x01
Boot Up Event	System power-up	0x03
Parameter Event	Parameter entry error	0x07
	Parameter stored	0x08
	Defaults set (and parameter event is enabled by default)	0x0A
	Number expected	0x0F

### Decode Event

#### Parameter # 256 (SSI # F0h 00h)

When enabled, the digital scanner generates a message to the host upon a successful bar code decode. When disabled, no notification is sent.

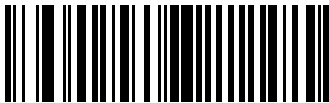

**Enable Decode Event  
(1)**



**\*Disable Decode Event  
(0)**

## Boot Up Event

### Parameter # 258 (SSI # F0h 02h)

When enabled, the digital scanner generates a message to the host whenever power is applied. When disabled, no notification is sent.

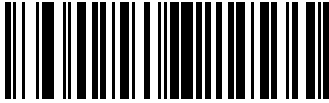

Enable Boot Up Event  
(1)

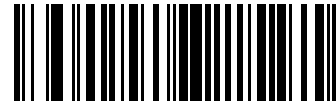

\*Disable Boot Up Event  
(0)

## Parameter Event

### Parameter # 259 (SSI # F0h 03h)

When enabled, the digital scanner generates a message to the host when one of the events specified in [Table 8-4 on page 8-21](#) occurs. When disabled, no notification is sent.

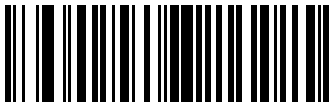

Enable Parameter Event  
(1)



\*Disable Parameter Event  
(0)



# CHAPTER 9 RS-232 INTERFACE

---

## Introduction

This chapter describes how to set up the digital scanner with an RS-232 host. Use the RS-232 interface to connect the digital scanner to point-of-sale devices, host computers, or other devices with an available RS-232 port (e.g., com port).

If your host does not appear in [Table 9-2](#), refer to the documentation for the host device to set communication parameters to match the host.

- ✓ **NOTE** The digital scanner uses TTL RS-232 signal levels, which interface with most system architectures. For system architectures requiring RS-232C signal levels, Zebra offers different cables providing TTL-to-RS-232C conversion. Contact support for more information.

Throughout the programming bar code menus, asterisks (\*) indicate default values.



\* Indicates default — \*Baud Rate 9600 — Feature/Option

- ✓ **NOTE** Most computer monitors allow scanning the bar codes directly on the screen. When scanning from the screen, be sure to set the document magnification to a level where you can see the bar code clearly, and bars and/or spaces are not merging.

## Connecting an RS-232 Interface

Connect the digital scanner directly to the host computer.

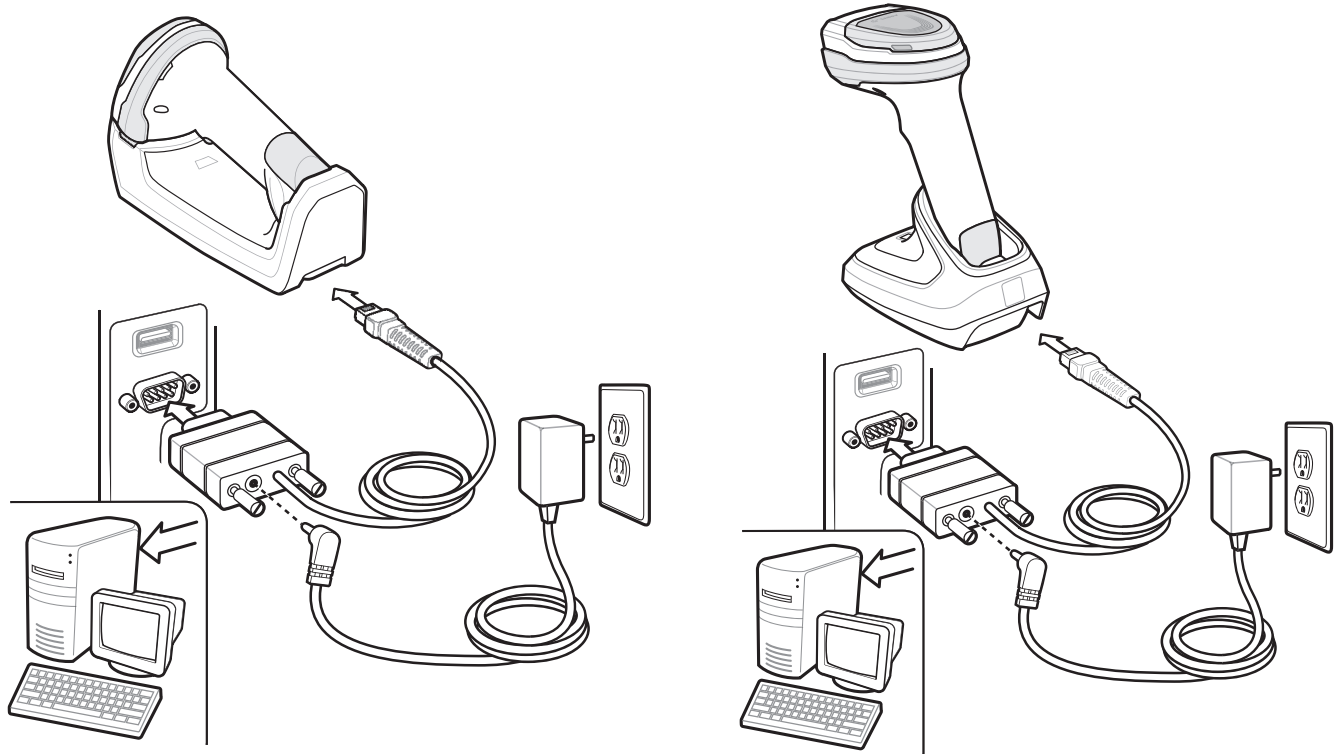

**Figure 9-1** *RS-232 Direct Connection*

- ✓ **NOTE** Interface cables vary depending on configuration. The connectors illustrated in [Figure 9-1](#) are examples only. The connectors may be different from those illustrated, but the steps to connect the cradle remain the same.
- ✓ **NOTE** Disconnect the host cables before the power supply, or the digital scanner may not recognize the new host.

To connect the cradle with a RS-232 interface:

1. Connect the other end of the RS-232 interface cable to the serial port on the host.
2. Attach the modular connector of the RS-232 interface cable to the cable interface port on the cradle. See [Connecting the Cradle on page 1-4](#).
3. If required, connect the power supply.
4. Ensure that all connections are secure.
5. Pair the digital scanner to the cradle by scanning the bar code on the cradle.
6. Select the RS-232 host type by scanning the appropriate bar code from [RS-232 Host Types on page 9-6](#).
7. To modify any other parameter options, scan the appropriate bar codes in this chapter.

## RS-232 Parameter Defaults

[Table 9-1](#) lists the defaults for RS-232 host parameters. To change any option, scan the appropriate bar code(s) provided in the RS-232 Host Parameters section beginning on page [9-4](#).

✓ **NOTE** See [Appendix A, Standard Parameter Defaults](#) for all user preferences, hosts, symbologies, and miscellaneous default parameters.

**Table 9-1** RS-232 Host Default Table

Parameter	Default	Page Number
<b>RS-232 Host Parameters</b>		
RS-232 Host Types	Standard	<a href="#">9-6</a>
Baud Rate	9600	<a href="#">9-8</a>
Parity Type	None	<a href="#">9-9</a>
Stop Bits	1 Stop Bit	<a href="#">9-10</a>
Data Bits	8-Bit	<a href="#">9-10</a>
Check Receive Errors	Enable	<a href="#">9-11</a>
Hardware Handshaking	None	<a href="#">9-11</a>
Software Handshaking	None	<a href="#">9-13</a>
Host Serial Response Time-out	2 sec	<a href="#">9-15</a>
RTS Line State	Low RTS	<a href="#">9-16</a>
Beep on <BEL>	Disable	<a href="#">9-16</a>
Intercharacter Delay	0 msec	<a href="#">9-17</a>
Nixdorf Beep/LED Options	Normal Operation	<a href="#">9-18</a>
Ignore Unknown Characters	Send Bar Code	<a href="#">9-18</a>
<b>Note: The DS8178 supports one stop bit only.</b>		

## RS-232 Host Parameters

Various RS-232 hosts use their own parameter default settings. Selecting standard, ICL, Fujitsu, Wincor-Nixdorf Mode A, Wincor-Nixdorf Mode B, OPOS/JPOS, Olivetti, Omron, or Common Use Terminal Equipment (CUTE-LP/LG bar code readers) sets the defaults listed in [Table 9-2](#).

**Table 9-2** Terminal Specific RS-232

Parameter	ICL	Fujitsu	Wincor-Nixdorf Mode A	Wincor-Nixdorf Mode B/OPOS/JPOS	Olivetti	Omron	CUTE
Transmit Code ID	Yes	Yes	Yes	Yes	Yes	Yes	Yes
Data Transmission Format	Data/Suffix	Data/Suffix	Data/Suffix	Data/Suffix	Prefix/Data/Suffix	Data/Suffix	Prefix/Data/Suffix
Suffix	CR (1013)	CR (1013)	CR (1013)	CR (1013)	ETX (1002)	CR (1013)	CR (1013) ETX (1003)
Baud Rate	9600	9600	9600	9600	9600	9600	9600
Parity	Even	None	Odd	Odd	Even	None	Even
Hardware Handshaking	RTS/CTS Option 3	None	RTS/CTS Option 3	RTS/CTS Option 3	None	None	None
Software Handshaking	None	None	None	None	ACK/NAK	None	None
Serial Response Time-out	9.9 sec.	2 sec.	None	None	9.9 sec.	9.9 sec.	9.9 sec.
Stop Bit Select	One	One	One	One	One	One	One
ASCII Format	8-Bit	8-Bit	8-Bit	8-Bit	7-Bit	8-Bit	7-Bit
Beep On <BEL>	Disable	Disable	Disable	Disable	Disable	Disable	Disable
RTS Line State	High	Low	Low	Low = No data to send	Low	High	High
Prefix	None	None	None	None	STX (1003)	None	STX (1002)

**In the Nixdorf Mode B, if CTS is low, scanning is disabled. When CTS is high, scanning is enabled.**

**If you scan Nixdorf Mode B without connecting the digital scanner to the proper host, it may appear unable to scan. If this happens, scan a different RS-232 host type within 5 seconds of cycling power to the digital scanner.**

**The CUTE host disables all parameter scanning, including Set Defaults. If you inadvertently select CUTE, scan *\*Enable Parameter Bar Code Scanning (1)* on page 5-6, then change the host selection.**

## RS-232 Host Parameters (continued)

Selecting ICL, Fujitsu, Wincor-Nixdorf Mode A, Wincor-Nixdorf Mode B, OPOS/JPOS, Olivetti, Omron, or Common Use Terminal Equipment (CUTE-LP/LG bar code readers) enables the transmission of code ID characters listed in [Table 9-3](#). These code ID characters are not programmable and are separate from the Transmit Code ID feature. Do not enable the Transmit Code ID feature for these terminals.

**Table 9-3** Terminal Specific Code ID Characters

Code Type	ICL	Fujitsu	Wincor-Nixdorf Mode A	Wincor-Nixdorf Mode B/OPOS/JPOS	Olivetti	Omron	CUTE
UPC-A	A	A	A	A	A	A	A
UPC-E	E	E	C	C	C	E	None
EAN-8/JAN-8	FF	FF	B	B	B	FF	None
EAN-13/JAN-13	F	F	A	A	A	F	A
Code 39	C <len>	None	M	M	M <len>	C <len>	3
Code 39 Full ASCII	None	None	M	M	None	None	3
Codabar	N <len>	None	N	N	N <len>	N <len>	None
Code 128	L <len>	None	K	K	K <len>	L <len>	5
I 2 of 5	I <len>	None	I	I	I <len>	I <len>	1
Code 93	None	None	L	L	L <len>	None	None
D 2 of 5	H <len>	None	H	H	H <len>	H <len>	2
GS1-128	L <len>	None	P	P	P <len>	L <len>	5
MSI	None	None	O	O	O <len>	None	None
Bookland EAN	F	F	A	A	A	F	None
Trioptic	None	None	None	None	None	None	None
Code 11	None	None	None	None	None	None	None
IATA	H<len>	None	H	H	H<len>	H<len>	2
Code 32	None	None	None	None	None	None	None
GS1 Databar Variants	None	None	E	E	None	None	None
PDF417	None	None	Q	Q	None	None	6
Data Matrix	None	None	R	R	None	None	4
QR Codes	None	None	U	U	None	None	7
Aztec/Aztec Rune	None	None	V	V	None	None	8

**Table 9-3** Terminal Specific Code ID Characters (Continued)

Code Type	ICL	Fujitsu	Wincor-Nixdorf Mode A	Wincor-Nixdorf Mode B/ OPOS/JPOS	Olivetti	Omron	CUTE
MAXICODE	None	None	T	T	None	None	None
microPDF	None	None	S	S	None	None	6

## RS-232 Host Types

To select an RS-232 host interface, scan one of the following bar codes.

✓ **NOTE** For a list of supported scanner functionality by communication protocol, see [Appendix J, Communication Protocol Functionality](#).

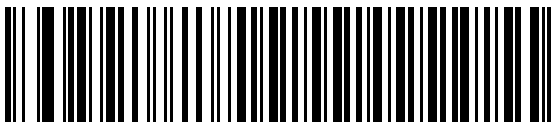

\* Standard RS-232<sup>1</sup>

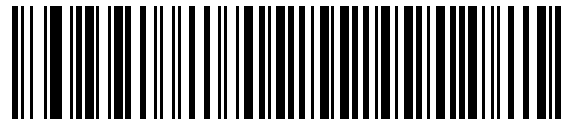

ICL RS-232

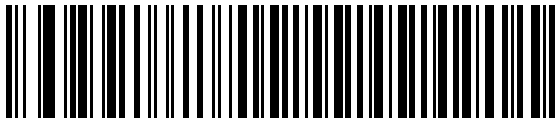

Wincor-Nixdorf RS-232 Mode A

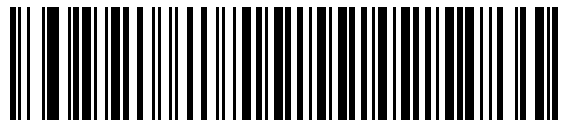

Wincor-Nixdorf RS-232 Mode B

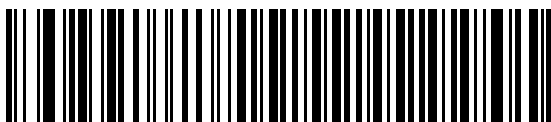

Olivetti ORS4500

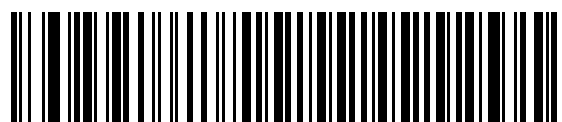

Omron

<sup>1</sup>Scanning Standard RS-232 activates the RS-232 driver, but does not change port settings (e.g., parity, data bits, handshaking). Selecting another RS-232 host type bar code changes these settings.

**RS-232 Host Types (continued)**

OPOS/JPOS

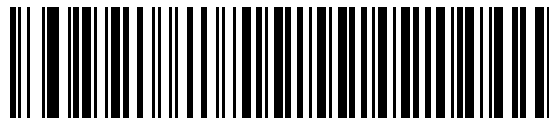

Fujitsu RS-232

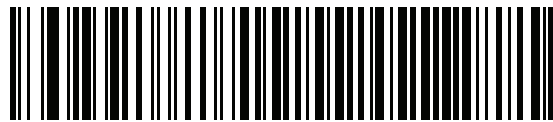
CUTE <sup>1</sup>

<sup>1</sup>The CUTE host disables all parameter scanning, including Set Defaults. If you inadvertently select CUTE, scan [\\*Enable Parameter Bar Code Scanning \(1\) on page 5-6](#), then change the host selection.

## Baud Rate

Baud rate is the number of bits of data transmitted per second. Set the digital scanner's baud rate to match the baud rate setting of the host device. Otherwise, data may not reach the host device or may reach it in distorted form.

✓ **NOTE** The digital scanner does not support baud rates below 9600.



\* Baud Rate 9600



Baud Rate 19,200



Baud Rate 38,400



Baud Rate 57,600



Baud Rate 115,200



## Parity

A parity check bit is the most significant bit of each ASCII coded character. Select the parity type according to host device requirements.

- Select **Odd** parity to set the parity bit value to 0 or 1, based on data, to ensure that the coded character contains an odd number of 1 bits.
- Select **Even** parity to set the parity bit value is set to 0 or 1, based on data, to ensure that the coded character contains an even number of 1 bits.
- Select **None** when no parity bit is required.

✓ **NOTE** Parity of **None** is not valid when Data Bits is set to **7-bit**.

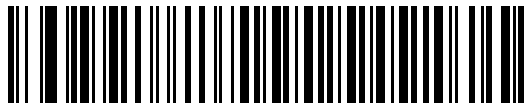

Odd



Even



\* None

## Stop Bit Select

The stop bit(s) at the end of each transmitted character marks the end of transmission of one character and prepares the receiving device for the next character in the serial data stream. Select the number of stop bits (one or two) based on the number the receiving terminal is programmed to accommodate. Set the number of stop bits to match host device requirements.

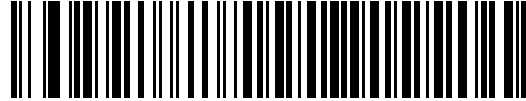

\*1 Stop Bit

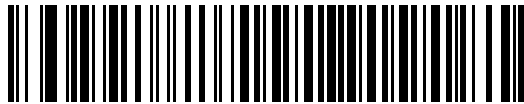

2 Stop Bits

## Data Bits

This parameter allows the digital scanner to interface with devices requiring a 7-bit or 8-bit ASCII protocol.



**NOTE** When **7-bit** is selected, Parity must be set to **Odd** or **Even**. If Parity is set to **None**, the scanner automatically operates in **8-bit** mode, even if **7-bit** is scanned.



7-Bit

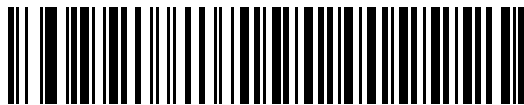

\* 8-Bit

## Check Receive Errors

Select whether or not to check the parity, framing, and overrun of received characters. The parity value of received characters is verified against the parity parameter selected above.

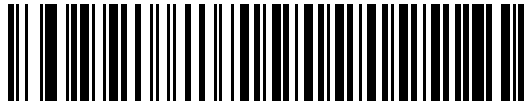

\* Check For Received Errors



Do Not Check For Received Errors

## Hardware Handshaking

The data interface consists of an RS-232 port designed to operate either with or without the hardware handshaking lines, *Request to Send* (RTS), and *Clear to Send* (CTS).

Disable Standard RTS/CTS handshaking to transmit scan data as it becomes available. Select Standard RTS/CTS handshaking to transmit scan data according to the following sequence:

- The digital scanner reads the CTS line for activity. If CTS is asserted, the scanner waits up to Host Serial Response Time-out for the host to de-assert the CTS line. If, after Host Serial Response Time-out (default), the CTS line is still asserted, the scanner sounds a transmit error, and discards any scanned data.
- When the CTS line is de-asserted, the digital scanner asserts the RTS line and waits up to Host Serial Response Time-out for the host to assert CTS. When the host asserts CTS, the scanner transmits data. If, after Host Serial Response Time-out (default), the CTS line is not asserted, the scanner sounds a transmit error, and discards the data.
- When data transmission completes, the digital scanner de-asserts RTS 10 msec after sending the last character.
- The host should respond by negating CTS. The digital scanner checks for a de-asserted CTS upon the next transmission of data.

During the transmission of data, the CTS line should be asserted. If CTS is deasserted for more than 50 ms between characters, the digital scanner aborts transmission, sounds a transmission error, and discards the data.

If this communication sequence fails, the digital scanner issues an error indication. In this case, the data is lost and must be rescanned.

If hardware handshaking and software handshaking are both enabled, hardware handshaking takes precedence.

✓ **NOTE** The DTR signal is jumpered to the active state.

## Hardware Handshaking (continued)

- **None:** Scan this bar code to disable hardware handshaking.
- **Standard RTS/CTS:** Scan this bar code to select Standard RTS/CTS Hardware Handshaking.
- **RTS/CTS Option 1:** If you select RTS/CTS Option 1, the digital scanner asserts RTS before transmitting and ignores the state of CTS. The scanner de-asserts RTS when the transmission completes.
- **RTS/CTS Option 2:** If you select Option 2, RTS is always high or low (user-programmed logic level). However, the digital scanner waits for CTS to be asserted before transmitting data. If CTS is not asserted within Host Serial Response Time-out (default), the scanner issues an error indication and discards the data.
- **RTS/CTS Option 3:** If you select Option 3, the digital scanner asserts RTS prior to any data transmission, regardless of the state of CTS. The scanner waits up to Host Serial Response Time-out (default) for CTS to be asserted. If CTS is not asserted during this time, the scanner issues an error indication and discards the data. The digital scanner de-asserts RTS when transmission is complete.

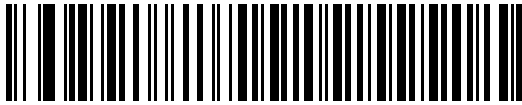

\* None

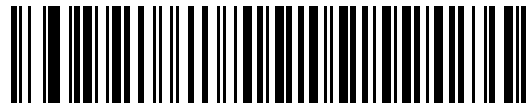

Standard RTS/CTS

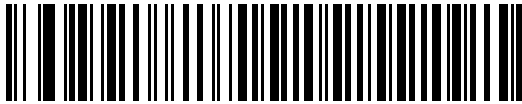

RTS/CTS Option 1



RTS/CTS Option 2



RTS/CTS Option 3

## Software Handshaking

This parameter offers control of the data transmission process in addition to, or instead of, that offered by hardware handshaking. There are five options.

If software handshaking and hardware handshaking are both enabled, hardware handshaking takes precedence.

- **None:** Select this to transmit data immediately. The digital scanner expects no response from the host.
- **ACK/NAK:** If you select this option, after transmitting data, the digital scanner expects either an ACK or NAK response from the host. When it receives a NAK, the scanner transmits the same data again and waits for either an ACK or NAK. After three unsuccessful attempts to send data after receiving NAKs, the digital scanner issues an error indication and discards the data.

The digital scanner waits up to the programmable Host Serial Response Time-out to receive an ACK or NAK. If the scanner does not get a response in this time, it issues an error indication and discards the data. There are no retries when a time-out occurs.

- **ENQ:** If you select this option, the digital scanner waits for an ENQ character from the host before transmitting data. If it does not receive an ENQ within the Host Serial Response Time-out, the digital scanner issues an error indication and discards the data. The host must transmit an ENQ character at least every Host Serial Response Time-out to prevent transmission errors.
- **ACK/NAK with ENQ:** This combines the two previous options. For re-transmissions of data, due to a NAK from the host, an additional ENQ is not required.
- **XON/XOFF:** An XOFF character turns the digital scanner transmission off until the scanner receives an XON character. There are two situations for XON/XOFF:
  - The digital scanner receives an XOFF before has data to send. When the scanner has data to send, it waits up to Host Serial Response Time-out for an XON character before transmission. If it does not receive the XON within this time, the digital scanner issues an error indication and discards the data.
  - The digital scanner receives an XOFF during a transmission. Data transmission then stops after sending the current byte. When the digital scanner receives an XON character, it sends the rest of the data message. The digital scanner waits indefinitely for the XON.

### Software Handshaking (continued)



\* None

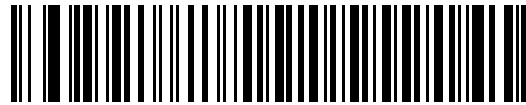

ACK/NAK

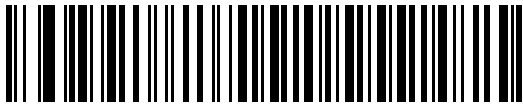

ENQ



ACK/NAK with ENQ

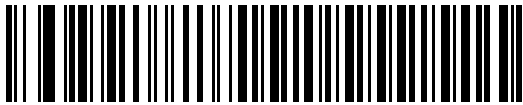

XON/XOFF

## Host Serial Response Time-out

This parameter specifies how long the digital scanner waits for an ACK, NAK, or CTS before determining that a transmission error occurred. This only applies when in one of the ACK/NAK software handshaking modes, or RTS/CTS hardware handshaking mode.



\* Minimum: 2 sec



Low: 2.5 sec

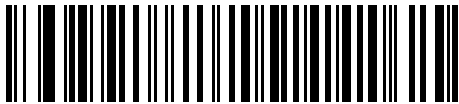

Medium: 5 sec



High: 7.5 sec

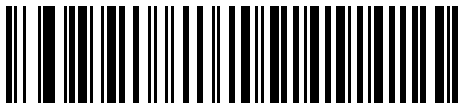

Maximum: 9.9 sec

## RTS Line State

This parameter sets the idle state of the Serial Host RTS line. Scan a bar code below to select **Low RTS** or **High RTS** line state.



\* Host: Low RTS

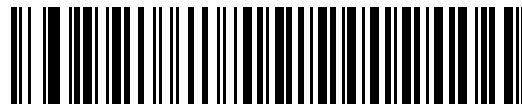

Host: High RTS

## Beep on <BEL>

If you enable this parameter, the digital scanner issues a beep when it detects a <BEL> character on the RS-232 serial line. <BEL> indicates an illegal entry or other important event.

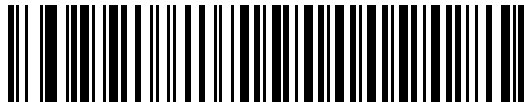

Beep On <BEL> Character  
(Enable)

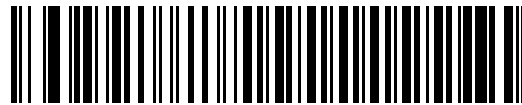

\* Do Not Beep On <BEL> Character  
(Disable)



## Intercharacter Delay

This parameter specifies the intercharacter delay inserted between character transmissions.



\* Minimum: 0 msec

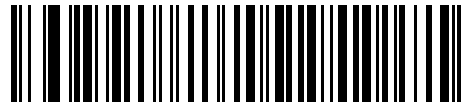

Low: 25 msec

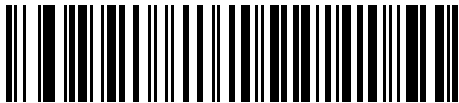

Medium: 50 msec



High: 75 msec

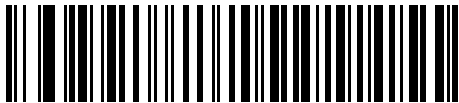

Maximum: 99 msec

## Nixdorf Beep/LED Options

If you selected Nixdorf Mode B, this indicates when the digital scanner beeps and turns on its LED after a decode.

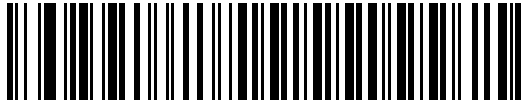

\* Normal Operation  
(Beep/LED immediately after decode)

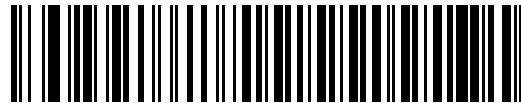

Beep/LED After Transmission

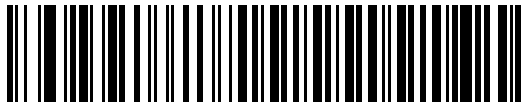

Beep/LED After CTS Pulse

## Ignore Unknown Characters

Unknown characters are characters the host does not recognize. Select **Send Bar Codes with Unknown Characters** to send all bar code data except for unknown characters. The digital scanner issues no error beeps.

Select **Do Not Send Bar Codes With Unknown Characters** to send bar code data up to the first unknown character. The digital scanner issues an error beep.

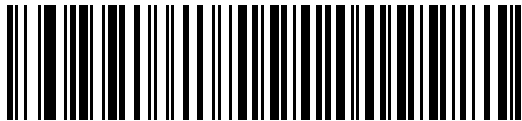

\* Send Bar Code  
(with unknown characters)



Do Not Send Bar Codes  
(with unknown characters)

---

## ASCII Character Set for RS-232

See [Appendix I, ASCII Character Sets](#) for Prefix/Suffix values. The values in [Table I-1](#) can be assigned as prefixes or suffixes for ASCII character data transmission.

# CHAPTER 10 IBM 468X / 469X INTERFACE

---

## Introduction

This chapter describes how to set up the digital scanner with an IBM 468X/469X host.

Throughout the programming bar code menus, asterisks (\*) indicate default values.

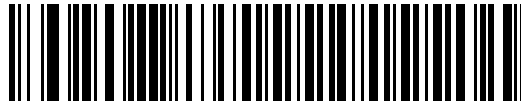

\* Indicates default — \* **Disable Convert Unknown to Code 39** — Feature/Option



**NOTE** Most computer monitors allow scanning the bar codes directly on the screen. When scanning from the screen, be sure to set the document magnification to a level where you can see the bar code clearly, and bars and/or spaces are not merging.

## Connecting to an IBM 468X/469X Host

Connect the digital scanner directly to the host interface.

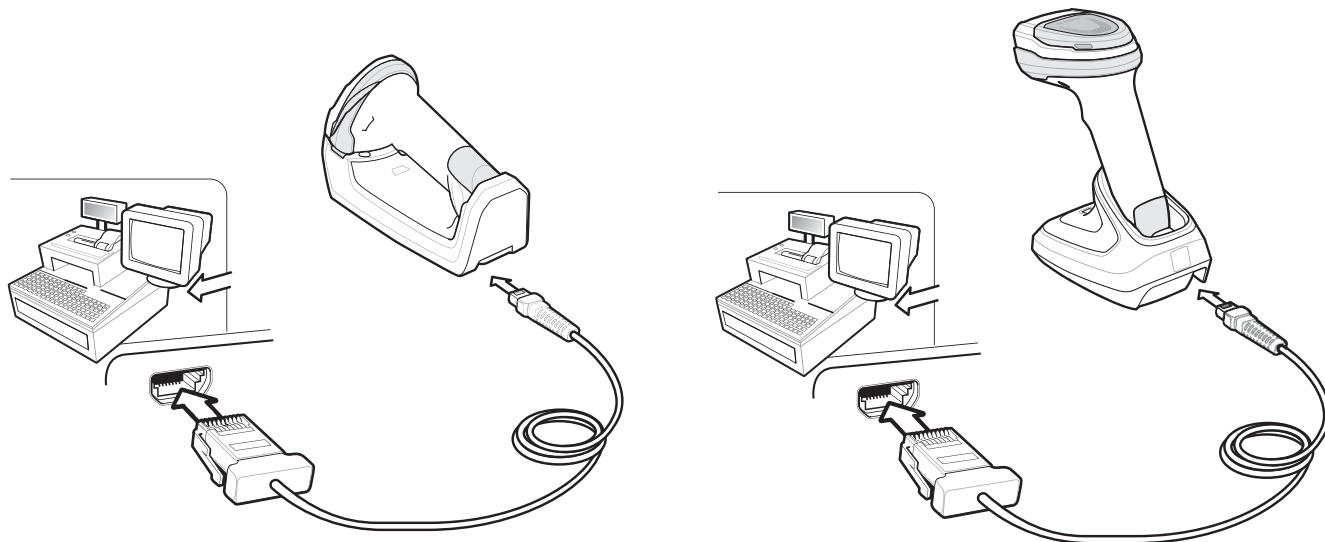

**Figure 10-1** IBM Direct Connection

✓ **NOTE** Interface cables vary depending on configuration. The connectors illustrated in [Figure 10-1](#) are examples only. The connectors may be different from those illustrated, but the steps to connect the cradle remain the same.

✓ **NOTE** Disconnect the host cables before the power supply, or the digital scanner may not recognize the new host.

1. Connect the other end of the IBM 46XX interface cable to the appropriate port on the host (typically Port 9).
2. Connect the modular connector of the IBM 46XX interface cable to the cable interface port on the cradle. See [Connecting the Cradle on page 1-4](#).
3. Connect an external power supply.
4. Ensure all connections are secure.
5. Pair the digital scanner to the cradle by scanning the bar code on the cradle.
6. Select the port address by scanning the appropriate bar code from [Port Address on page 10-4](#).
7. To modify other parameter options, scan the appropriate bar codes in this chapter.

✓ **NOTE** The only required configuration is the port address. Most other digital scanner parameters are typically controlled by the IBM system.

## IBM Parameter Defaults

[Table 10-1](#) lists the defaults for IBM host parameters. To change any option, scan the appropriate bar code(s) provided in the Parameter Descriptions section beginning on page [10-4](#).



**NOTE** See [Appendix A, Standard Parameter Defaults](#) for all user preferences, hosts, symbologies, and miscellaneous default parameters.

**Table 10-1** *IBM Host Default Table*

Parameter	Default	Page Number
<b>IBM 468X/469X Host Parameters</b>		
Port Address	None Selected	<a href="#">10-4</a>
Convert Unknown to Code 39	Disable	<a href="#">10-5</a>
RS-485 Beep Directive	Honor	<a href="#">10-5</a>
RS-485 Bar Code Configuration Directive	Ignore	<a href="#">10-6</a>
IBM-485 Specification Version	Original Specification	<a href="#">10-6</a>

---

## IBM 468X/469X Host Parameters

### Port Address

This parameter sets the IBM 468X/469X port used.

- ✓ **NOTE** Scanning one of these bar codes enables the RS-485 interface on the digital scanner.
  
- ✓ **NOTE** For a list of supported scanner functionality by communication protocol, see [Appendix J, Communication Protocol Functionality](#).

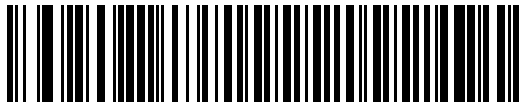

\* None Selected

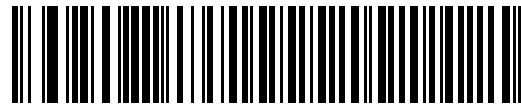

Hand-Held Scanner Emulation (Port 9B)

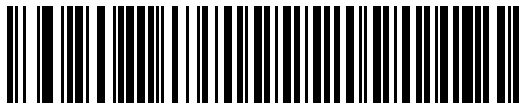

Non-IBM Scanner Emulation (Port 5B)



Table-Top Scanner Emulation (Port 17)

## Convert Unknown to Code 39

Scan a bar code below to enable or disable the conversion of unknown bar code type data to Code 39.



**Enable Convert Unknown to Code 39**

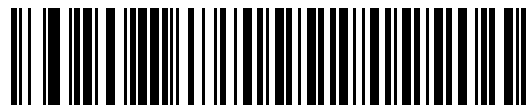

**\*Disable Convert Unknown to Code 39**

## RS-485 Beep Directive

The IBM RS-485 host can send a beeper configuration request to the scanner. Scan **Ignore Beep Directive** to prevent the scanner from processing the host request. All directives are still acknowledged to the host as if they were processed.

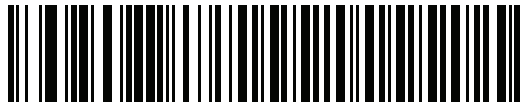

**\*Honor Beep Directive**



**Ignore Beep Directive**

## RS-485 Bar Code Configuration Directive

The IBM RS-485 host can enable and disable code types. Scan **Ignore Bar Code Configuration Directive** to prevent the scanner from processing the host request. All directives are still acknowledged to the IBM RS-485 host as if they were processed.

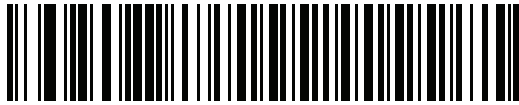

**Honor Bar Code Configuration Directive**



**\*Ignore Bar Code Configuration Directive**

## IBM-485 Specification Version

### Parameter # 1729 (SSI # F8h 06h C1h)

The IBM interface specification version selected defines how code types are reported over the IBM interface.

When you scan **Original Specification**, only Symbologies that were historically supported on each individual port are reported as known. When you scan Version 2.0, all Symbologies covered in the newer IBM specification are reported as known with their respective code types.



**\*Original Specification  
(0)**



**Version 2.0  
(1)**



# CHAPTER 11 KEYBOARD WEDGE INTERFACE

---

## Introduction

This chapter describes how to set up a keyboard wedge interface with the digital scanner. With this interface, the digital scanner is connected between the keyboard and host computer, and translates bar code data into keystrokes. The host computer accepts the keystrokes as if they originated from the keyboard. This mode adds bar code reading functionality to a system designed for manual keyboard input. Keyboard keystrokes are simply passed through.

Throughout the programming bar code menus, asterisks (\*) indicate default values.



\*Indicates default

\*Send Bar Codes with Unknown Characters

Feature/Option



**NOTE** Most computer monitors allow scanning the bar codes directly on the screen. When scanning from the screen, be sure to set the document magnification to a level where you can see the bar code clearly, and bars and/or spaces do not merge.

## Connecting a Keyboard Wedge Interface

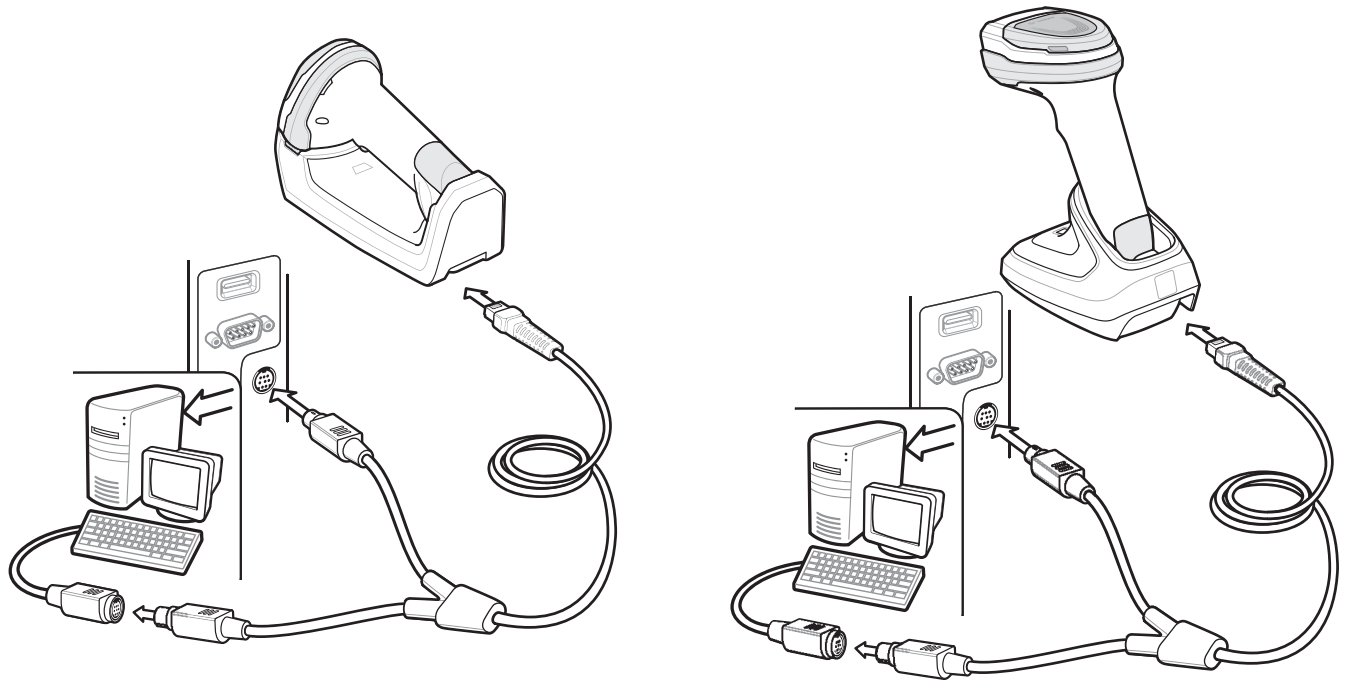

**Figure 11-1** Keyboard Wedge Connection with Y-cable

To connect the keyboard wedge interface Y-cable:

1. Turn off the host and unplug the keyboard connector.
2. Connect the round male DIN host connector of the Y-cable to the keyboard port on the host.
3. Connect the round female DIN keyboard connector of the Y-cable to the keyboard connector.
4. Attach the modular connector of the Y-cable to the cable interface port on the cradle. See [Connecting the Cradle on page 1-4](#).
5. If required, connect the power supply.
6. Ensure that all connections are secure.
7. Turn on the host system.
8. Pair the digital scanner to the cradle by scanning the bar code on the cradle.
9. Select the keyboard wedge host type by scanning the appropriate bar code from [Keyboard Wedge Host Parameters on page 11-4](#).
10. To modify any other parameter options, scan the appropriate bar codes in this chapter.
11. Connect an external power supply if desired.

✓ **NOTE** Interface cables vary depending on configuration. The connectors illustrated in [Figure 11-1](#) are examples only. The connectors may be different from those illustrated, but the steps to connect the cradle remain the same.

✓ **NOTE** Disconnect the host cables before the power supply, or the digital scanner may not recognize the new host.

## Keyboard Wedge Parameter Defaults

*Table 11-1* lists the defaults for Keyboard Wedge host parameters. To change any option, scan the appropriate bar code(s) in *Keyboard Wedge Host Parameters on page 11-4*.

- ✓ **NOTE** See *Appendix B, Country Codes* for Keyboard Wedge Country Keyboard Types (Country Codes).  
See *Appendix A, Standard Parameter Defaults* for all user preferences, hosts, symbologies, and miscellaneous default parameters.

**Table 11-1** *Keyboard Wedge Host Default Table*

Parameter	Default	Page Number
<b>Keyboard Wedge Host Parameters</b>		
Keyboard Wedge Host Type	IBM AT Notebook	<a href="#">11-4</a>
Ignore Unknown Characters	Transmit	<a href="#">11-4</a>
Keystroke Delay	No Delay	<a href="#">11-5</a>
Intra-Keystroke Delay	Disable	<a href="#">11-5</a>
Alternate Numeric Keypad Emulation	Enable	<a href="#">11-6</a>
Quick Keypad Emulation	Enable	<a href="#">11-6</a>
Simulated Caps Lock	Disable	<a href="#">11-7</a>
Caps Lock Override	Disable	<a href="#">11-7</a>
Convert Wedge Case	No Convert	<a href="#">11-8</a>
Function Key Mapping	Disable	<a href="#">11-8</a>
FN1 Substitution	Disable	<a href="#">11-9</a>
Send Make and Break	Send Make and Break Scan Codes	<a href="#">11-9</a>

---

## Keyboard Wedge Host Parameters

### Keyboard Wedge Host Types

Select the Keyboard Wedge host by scanning one of the bar codes below.



**NOTE** For a list of supported scanner functionality by communication protocol, see [Appendix J, Communication Protocol Functionality](#).

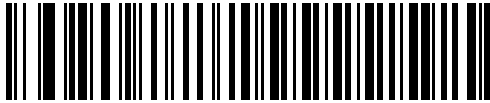

IBM PC/AT & IBM PC Compatibles

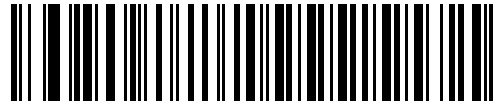

\*IBM AT Notebook

### Ignore Unknown Characters

Unknown characters are characters the host does not recognize. Select **Send Bar Codes With Unknown Characters** to send all bar code data except for unknown characters. The digital scanner issues no error beeps.

Select **Do Not Send Bar Codes With Unknown Characters** to send bar code data up to the first unknown character. The digital scanner issues an error beep.

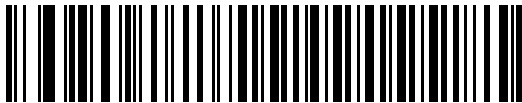

\* Send Bar Codes with Unknown Characters  
(Transmit)

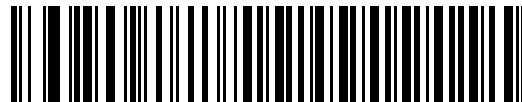

Do Not Send Bar Codes with Unknown Characters

### Keystroke Delay

This is the delay in milliseconds between emulated keystrokes. Scan a bar code below to increase the delay when hosts require a slower transmission of data.

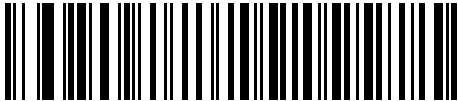

\* No Delay

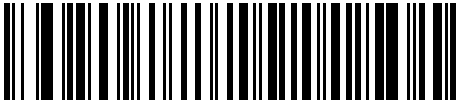

Medium Delay (20 msec)

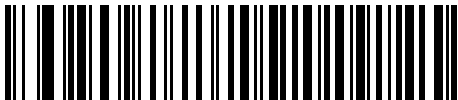

Long Delay (40 msec)

### Intra-Keystroke Delay

Enable this to insert an additional delay between each emulated key depression and release. This sets the Keystroke Delay parameter to a minimum of 5 msec as well.



Enable



\* Disable

## Alternate Numeric Keypad Emulation

This allows emulation of most other country keyboard types not listed in [Appendix B, Country Codes](#) in a Microsoft® operating system environment.

- ✓ **NOTE** If your keyboard type is not listed in the country code list (see [Country Codes on page B-1](#)), disable [Quick Keypad Emulation on page 11-6](#) and ensure [Alternate Numeric Keypad Emulation on page 11-6](#) is enabled.

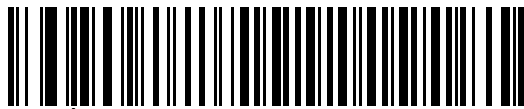

\*Enable Alternate Numeric Keypad

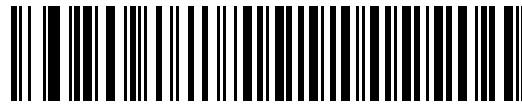

Disable Alternate Numeric Keypad

## Quick Keypad Emulation

This parameter enables faster keypad emulation where character value sequences are only sent for characters not found on the keyboard.

- ✓ **NOTE** This option applies only when [Alternate Numeric Keypad Emulation](#) is enabled.



\*Enable Quick Keypad Emulation



Disable Quick Keypad Emulation

## Simulated Caps Lock

Enable this to invert upper and lower case characters on the bar code as if the Caps Lock state is enabled on the keyboard. This inversion occurs regardless of the keyboard **Caps Lock** state. Note that this only applies to alpha characters.

✓ **NOTE** Simulated Caps Lock applies to ASCII characters only.



Enable Caps Lock On

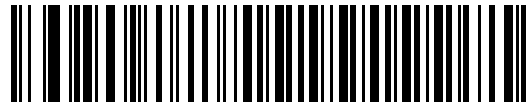

\* Disable Caps Lock On

## Caps Lock Override

Enable this on AT or AT Notebook hosts to preserve the case of the data regardless of the state of the **Caps Lock** key. Therefore, an 'A' in the bar code transmits as an 'A' regardless of the setting of the keyboard **Caps Lock** key.



Enable Caps Lock Override



\* Disable Caps Lock Override

✓ **NOTE** If both Simulated Caps Lock and Caps Lock Override are enabled, Caps Lock Override takes precedence.

## Convert Wedge Case

Enable this to convert all bar code data to the selected case.

✓ **NOTE** Convert Case applies to ASCII characters only.



Convert to Upper Case

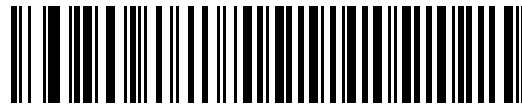

Convert to Lower Case



\* No Convert

## Function Key Mapping

ASCII values under 32 are normally sent as control key sequences (see [Table I-1 on page I-1](#)). Enable this parameter to send the keys in bold in place of the standard key mapping. Table entries that do not have a bold entry remain the same whether or not you enable this parameter.

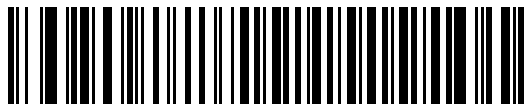

Enable

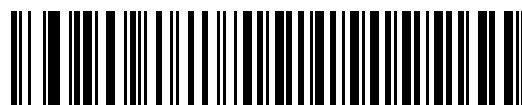

\* Disable



### FN1 Substitution

Enable this to replace FN1 characters in an EAN128 bar code with a user-selected keystroke (see [FN1 Substitution Values on page 5-40](#)).

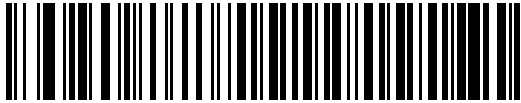

Enable

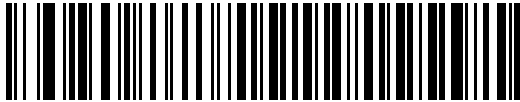

\* Disable

### Send Make and Break

Enable this to prevent sending the scan codes for releasing a key.

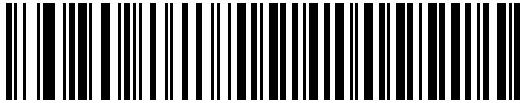

\* Send Make and Break Scan Codes

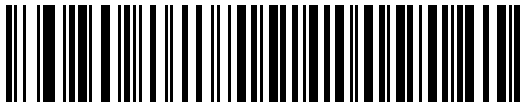

Send Make Scan Code Only



**NOTE** Windows-based systems must use **Send Make and Break Scan Codes**.

## Keyboard Maps

Refer to the following keyboard maps for prefix/suffix keystroke parameters. To program the prefix/suffix values, see the bar codes on [page 5-38](#).

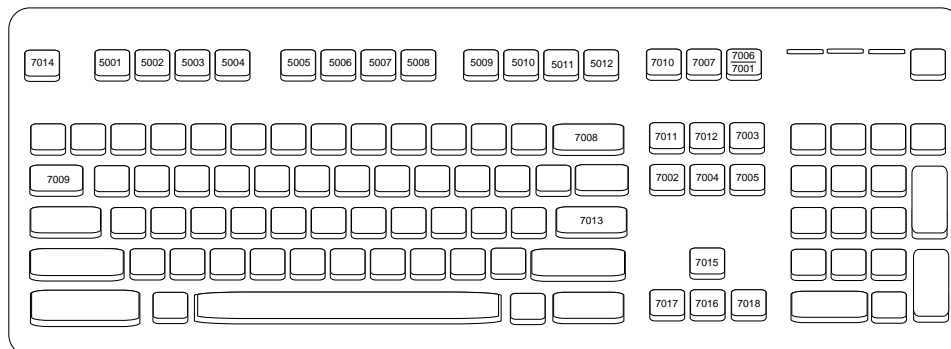

Figure 11-2 IBM PS2 Type Keyboard

## ASCII Character Set for Keyboard Wedge

✓ **NOTE** Code 39 Full ASCII interprets the bar code special character (\$ + % /) preceding a Code 39 character and assigns an ASCII character value to the pair. For example, if you enable Code 39 Full ASCII and scan **+B**, it transmits as **b**, **%J** as **?**, and **%V** as **@**. Scanning **ABC%i** outputs the keystroke equivalent of **ABC >**.

See [Appendix I, ASCII Character Sets](#) for the following:

- ASCII Character Set ([Table I-1 on page I-1](#))
- ALT Key Character Set ([Table I-2 on page I-6](#))
- GUI Key Character Set ([Table I-3 on page I-7](#))
- F Key Character Set ([Table I-5 on page I-10](#))
- Numeric Key Character Set ([Table I-6 on page I-11](#))
- Extended Key Character Set ([Table I-7 on page I-12](#)).

# CHAPTER 12 SYMBOLOGIES

---

## Introduction

This chapter describes symbology features and provides programming bar codes for selecting these features. Before programming, follow the instructions in [Chapter 1, Getting Started](#).

To set feature values, scan a single bar code or a short bar code sequence. The settings are stored in non-volatile memory and are preserved even when the digital scanner powers down.

✓ **NOTE** Most computer monitors allow scanning the bar codes directly on the screen. When scanning from the screen, be sure to set the document magnification to a level where you can see the bar code clearly, and bars and/or spaces do not merge.

Select a host type (see each host chapter for specific host information) after the power-up beeps sound. This is only necessary upon the first power-up when connected to a new host.

To return all features to default values, see [Default Parameters on page 5-5](#). Throughout the programming bar code menus, asterisks (\*) indicate default values.

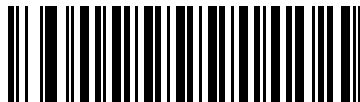

\* Indicates Default — \*Enable UPC-A — Feature/Option  
(1) — Option Value

---

## Scanning Sequence Examples

In most cases, scanning one bar code sets the parameter value. For example, to transmit bar code data without the UPC-A check digit, simply scan the **Do Not Transmit UPC-A Check Digit** bar code under [Transmit UPC-A Check Digit on page 12-16](#). The digital scanner issues a fast warble beep and the LED turns green, signifying a successful parameter entry.

Other parameters, such as **Set Length(s) for D 2 of 5** require scanning several bar codes. See the individual parameter, such as **Set Length(s) for D 2 of 5**, for this procedure.

## Errors While Scanning

Unless otherwise specified, to correct an error during a scanning sequence, just re-scan the correct parameter.

## Symbology Parameter Defaults

[Table 12-1](#) lists the defaults for all symbology parameters. To change the default values, scan the appropriate bar codes in this guide. These new values replace the standard default values in memory. To recall the default parameter values, see [Default Parameters on page 5-5](#).

✓ **NOTE** See [Appendix A, Standard Parameter Defaults](#) for all user preferences, hosts, and miscellaneous default parameters.

**Table 12-1** Symbology Parameter Defaults

Parameter	Parameter Number	SSI Number	Default	Page Number
<b>Enable/Disable All Code Types</b>				<a href="#">12-7</a>
<b>1D Symbologies</b>				
<b>UPC/EAN</b>				
UPC-A	1	01h	Enable	<a href="#">12-8</a>
UPC-E	2	02h	Enable	<a href="#">12-8</a>
UPC-E1	12	0Ch	Disable	<a href="#">12-9</a>
EAN-8/JAN 8	4	04h	Enable	<a href="#">12-9</a>
EAN-13/JAN 13	3	03h	Enable	<a href="#">12-10</a>
Bookland EAN	83	53h	Disable	<a href="#">12-10</a>
Decode UPC/EAN/JAN Supplementals (2 and 5 digits)	16	10h	Ignore	<a href="#">12-12</a>
User-Programmable Supplementals			000	<a href="#">12-14</a>
Supplemental 1:	579	F1h 43h		
Supplemental 2:	580	F1h 44h		
UPC/EAN/JAN Supplemental Redundancy	80	50h	10	<a href="#">12-14</a>
Decode UPC/EAN/JAN Supplemental AIM ID	672	F1h A0h	Combined	<a href="#">12-15</a>
UPC Reduced Quiet Zone	1289	F8h 05h 09h	Disable	<a href="#">12-16</a>
Transmit UPC-A Check Digit	40	28h	Enable	<a href="#">12-16</a>
Transmit UPC-E Check Digit	41	29h	Enable	<a href="#">12-16</a>
Transmit UPC-E1 Check Digit	42	2Ah	Enable	<a href="#">12-17</a>

**Table 12-1** Symbology Parameter Defaults (Continued)

Parameter	Parameter Number	SSI Number	Default	Page Number
UPC-A Preamble	34	22h	System Character	<a href="#">12-18</a>
UPC-E Preamble	35	23h	System Character	<a href="#">12-18</a>
UPC-E1 Preamble	36	24h	System Character	<a href="#">12-20</a>
Convert UPC-E to A	37	25h	Disable	<a href="#">12-21</a>
Convert UPC-E1 to A	38	26h	Disable	<a href="#">12-21</a>
EAN-8/JAN-8 Extend	39	27h	Disable	<a href="#">12-22</a>
Bookland ISBN Format	576	F1h 40h	ISBN-10	<a href="#">12-22</a>
UCC Coupon Extended Code	85	55h	Disable	<a href="#">12-23</a>
Coupon Report	730	F1h DAh	New Coupon Format	<a href="#">12-23</a>
ISSN EAN	617	F1h 69h	Disable	<a href="#">12-24</a>
<b>Code 128</b>				
Code 128	8	08h	Enable	<a href="#">12-24</a>
Set Length(s) for Code 128	209, 210	D1h, D2h	Any Length	<a href="#">12-25</a>
GS1-128 (formerly UCC/EAN-128)	14	0Eh	Enable	<a href="#">12-27</a>
ISBT 128	84	54h	Enable	<a href="#">12-27</a>
ISBT Concatenation	577	F1h 41h	Autodiscriminate	<a href="#">12-28</a>
Check ISBT Table	578	F1h 42h	Enable	<a href="#">12-29</a>
ISBT Concatenation Redundancy	223	DFh	10	<a href="#">12-29</a>
Code 128 Security Level	751	F1h EFh	Security Level 1	<a href="#">12-30</a>
Code 128 Reduced Quiet Zone	1208	F8h 04h B8h	Disable	<a href="#">12-31</a>
Ignore Code 128 <FNC4>	1254	F8h 04h E6h	Disable	<a href="#">12-31</a>
<b>Code 39</b>				
Code 39	0	00h	Enable	<a href="#">12-32</a>
Trioptic Code 39	13	0Dh	Disable	<a href="#">12-32</a>
Convert Code 39 to Code 32 (Italian Pharmacy Code)	86	56h	Disable	<a href="#">12-33</a>
Code 32 Prefix	231	E7h	Disable	<a href="#">12-33</a>
Set Length(s) for Code 39	18, 19	12h, 13h	1 to 55	<a href="#">12-34</a>
Code 39 Check Digit Verification	48	30h	Disable	<a href="#">12-35</a>
Transmit Code 39 Check Digit	43	2Bh	Disable	<a href="#">12-35</a>

**Table 12-1** Symbology Parameter Defaults (Continued)

Parameter	Parameter Number	SSI Number	Default	Page Number
Code 39 Full ASCII Conversion	17	11h	Disable	<a href="#">12-36</a>
Code 39 Security Level	750	F1h EEh	Security Level 1	<a href="#">12-37</a>
Code 39 Reduced Quiet Zone	1209	F8h 04h B9h	Disable	<a href="#">12-38</a>
<b>Code 93</b>				
Code 93	9	09h	Enable	<a href="#">12-38</a>
Set Length(s) for Code 93	26, 27	1Ah, 1Bh	1 to 55	<a href="#">12-39</a>
<b>Code 11</b>				
Code 11	10	0Ah	Disable	<a href="#">12-40</a>
Set Lengths for Code 11	28, 29	1Ch, 1Dh	4 to 55	<a href="#">12-40</a>
Code 11 Check Digit Verification	52	34h	Disable	<a href="#">12-42</a>
Transmit Code 11 Check Digit(s)	47	2Fh	Disable	<a href="#">12-42</a>
<b>Interleaved 2 of 5 (ITF)</b>				
Interleaved 2 of 5 (ITF)	6	06h	Enable	<a href="#">12-43</a>
Set Lengths for I 2 of 5	22, 23	16h, 17h	6 to 55	<a href="#">12-43</a>
I 2 of 5 Check Digit Verification	49	31h	Disable	<a href="#">12-45</a>
Transmit I 2 of 5 Check Digit	44	2Ch	Disable	<a href="#">12-45</a>
Convert I 2 of 5 to EAN 13	82	52h	Disable	<a href="#">12-46</a>
I 2 of 5 Security Level	1121	F8h 04h 61h	Security Level 1	<a href="#">12-46</a>
I 2 of 5 Reduced Quiet Zone	1210	F8h 04h BAh	Disable	<a href="#">12-47</a>
<b>Discrete 2 of 5 (DTF)</b>				
Discrete 2 of 5	5	05h	Disable	<a href="#">12-48</a>
Set Length(s) for D 2 of 5	20, 21	14h 15h	1 to 55	<a href="#">12-48</a>
<b>Codabar (NW - 7)</b>				
Codabar	7	07h	Enable	<a href="#">12-50</a>
Set Lengths for Codabar	24, 25	18h, 19h	4 to 55	<a href="#">12-50</a>
CLSI Editing	54	36h	Disable	<a href="#">12-52</a>
NOTIS Editing	55	37h	Disable	<a href="#">12-52</a>
Codabar Upper or Lower Case Start/ Stop Characters Detection	855	F2h 57h	Upper Case	<a href="#">12-53</a>

**Table 12-1** Symbology Parameter Defaults (Continued)

Parameter	Parameter Number	SSI Number	Default	Page Number
<b>MSI</b>				
MSI	11	0Bh	Disable	<a href="#">12-53</a>
Set Length(s) for MSI	30, 31	1Eh, 1Fh	4 to 55	<a href="#">12-54</a>
MSI Check Digits	50	32h	One	<a href="#">12-55</a>
Transmit MSI Check Digit	46	2Eh	Disable	<a href="#">12-55</a>
MSI Check Digit Algorithm	51	33h	Mod 10/Mod 10	<a href="#">12-56</a>
MSI Reduced Quiet Zone	1392	F8h 05h 70h	Disable	<a href="#">12-56</a>
<b>Chinese 2 of 5</b>				
Chinese 2 of 5	408	F0h 98h	Disable	<a href="#">12-57</a>
<b>Matrix 2 of 5</b>				
Matrix 2 of 5	618	F1h 6Ah	Disable	<a href="#">12-57</a>
Matrix 2 of 5 Lengths	619 620	F1h 6Bh F1h 6Ch	Any Length	<a href="#">12-58</a>
Matrix 2 of 5 Check Digit	622	F1h 6Eh	Disable	<a href="#">12-59</a>
Transmit Matrix 2 of 5 Check Digit	623	F1h 6Fh	Disable	<a href="#">12-59</a>
<b>Korean 3 of 5</b>				
Korean 3 of 5	581	F1h 45h	Disable	<a href="#">12-60</a>
<b>Inverse 1D</b>	586	F1h 4Ah	Regular	<a href="#">12-60</a>
<b>GS1 DataBar</b>				
GS1 DataBar-14	338	F0h 52h	Enable	<a href="#">12-62</a>
GS1 DataBar Limited	339	F0h 53h	Enable	<a href="#">12-62</a>
GS1 DataBar Expanded	340	F0h 54h	Enable	<a href="#">12-63</a>
Convert GS1 DataBar to UPC/EAN	397	F0h 8Dh	Disable	<a href="#">12-63</a>
GS1 DataBar Limited Margin Check	728	F1h D8h	Level 3	<a href="#">12-64</a>
GS1 DataBar Security Level	1706	F8h 06h AAh	Level 1	<a href="#">12-65</a>
<b>Composite</b>				
Composite CC-C	341	F0h 55h	Disable	<a href="#">12-66</a>
Composite CC-A/B	342	F0h 56h	Disable	<a href="#">12-66</a>
Composite TLC-39	371	F0h 73h	Disable	<a href="#">12-67</a>
Composite Inverse	1113	F8h 04h 59h	Regular	<a href="#">12-67</a>

**Table 12-1** Symbology Parameter Defaults (Continued)

Parameter	Parameter Number	SSI Number	Default	Page Number
UPC Composite Mode	344	F0h 58h	UPC Never Linked	<a href="#">12-68</a>
Composite Beep Mode	398	F0h 8Eh	Beep As Each Code Type is Decoded	<a href="#">12-68</a>
GS1-128 Emulation Mode for UCC/EAN Composite Codes	427	F0h ABh	Disable	<a href="#">12-69</a>
<b>2D Symbologies</b>				
PDF417	15	0Fh	Enable	<a href="#">12-69</a>
MicroPDF417	227	E3h	Disable	<a href="#">12-70</a>
Code 128 Emulation	123	7Bh	Disable	<a href="#">12-70</a>
Data Matrix	292	F0h 24h	Enable	<a href="#">12-71</a>
GS1 Data Matrix	1336	F8h 05h 38h	Disable	<a href="#">12-71</a>
Data Matrix Inverse	588	F1h 4Ch	Inverse Autodetect	<a href="#">12-72</a>
Maxicode	294	F0h 26h	Disable	<a href="#">12-72</a>
QR Code	293	F0h 25h	Enable	<a href="#">12-73</a>
GS1 QR	1343	F8h 05h 3Fh	Disable	<a href="#">12-73</a>
MicroQR	573	F1h 3Dh	Enable	<a href="#">12-74</a>
Aztec	574	F1h 3Eh	Enable	<a href="#">12-74</a>
Aztec Inverse	589	F1h 4Dh	Inverse Autodetect	<a href="#">12-75</a>
Han Xin	1167	F8h 04h 8Fh	Disable	<a href="#">12-75</a>
Han Xin Inverse	1168	F8h 04h 90h	Regular	<a href="#">12-76</a>
<b>Postal Codes</b>				
US Postnet	89	59h	Disable	<a href="#">12-76</a>
US Planet	90	5Ah	Disable	<a href="#">12-77</a>
Transmit US Postal Check Digit	95	5Fh	Enable	<a href="#">12-77</a>
UK Postal	91	5Bh	Disable	<a href="#">12-78</a>
Transmit UK Postal Check Digit	96	60h	Enable	<a href="#">12-78</a>
Japan Postal	290	F0h 22h	Disable	<a href="#">12-79</a>
Australia Post	291	F0h 23h	Disable	<a href="#">12-79</a>
Australia Post Format	718	F1h CEh	Autodiscriminate	<a href="#">12-80</a>
Netherlands KIX Code	326	F0h 46h	Disable	<a href="#">12-81</a>
USPS 4CB/One Code/Intelligent Mail	592	F1h 50h	Disable	<a href="#">12-81</a>



**Table 12-1** Symbology Parameter Defaults (Continued)

Parameter	Parameter Number	SSI Number	Default	Page Number
UPU FICS Postal	611	F1h 63h	Disable	<a href="#">12-82</a>
Mailmark	1337	F8h 05h 39h	Disable	<a href="#">12-82</a>
<b>Symbology-Specific Security Levels</b>				
Redundancy Level	78	4Eh	1	<a href="#">12-83</a>
Security Level	77	4Dh	1	<a href="#">12-85</a>
1D Quiet Zone Level	1288	F8h 05h 08h	1	<a href="#">12-86</a>
Intercharacter Gap Size	381	F0h 7Dh	Normal	<a href="#">12-87</a>
Report Version				<a href="#">12-87</a>
<b>Macro PDF</b>				
Flush Macro PDF Buffer	N/A	N/A	N/A	<a href="#">12-88</a>
Abort Macro PDF Entry	N/A	N/A	N/A	<a href="#">12-88</a>

## Enable/Disable All Code Types

To disable all symbologies, scan **Disable All Code Types** below. This is useful when enabling only a few code types.

Scan **Enable All Code Types** turn on (enable) all code types. This is useful when you want to read all codes, or when you want to disable only a few code types.

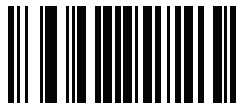
**Disable All Code Types****Enable All Code Types**

---

## UPC/EAN

### Enable/Disable UPC-A

#### Parameter # 1 (SSI # 01h)

To enable or disable UPC-A, scan the appropriate bar code below.



**\*Enable UPC-A  
(1)**

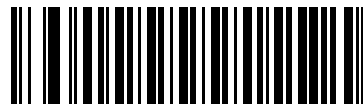

**Disable UPC-A  
(0)**

### Enable/Disable UPC-E

#### Parameter # 2 (SSI # 02h)

To enable or disable UPC-E, scan the appropriate bar code below.

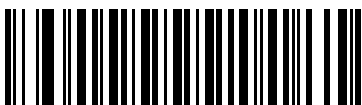

**\*Enable UPC-E  
(1)**



**Disable UPC-E  
(0)**

## Enable/Disable UPC-E1

### Parameter # 12 (SSI # 0Ch)

UPC-E1 is disabled by default.

To enable or disable UPC-E1, scan the appropriate bar code below.

✓ **NOTE** UPC-E1 is not a UCC (Uniform Code Council) approved symbology.

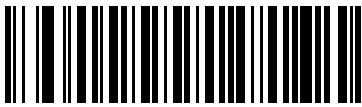

Enable UPC-E1  
(1)



\*Disable UPC-E1  
(0)

## Enable/Disable EAN-8/JAN-8

### Parameter # 4 (SSI # 04h)

To enable or disable EAN-8/JAN-8, scan the appropriate bar code below.

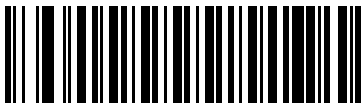

\*Enable EAN-8/JAN-8  
(1)



Disable EAN-8/JAN-8  
(0)

## Enable/Disable EAN-13/JAN-13

### Parameter # 3 (SSI # 03h)

To enable or disable EAN-13/JAN-13, scan the appropriate bar code below.

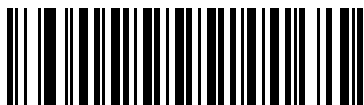

**\*Enable EAN-13/JAN-13  
(1)**

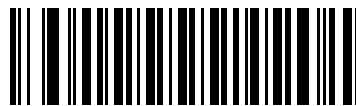

**Disable EAN-13/JAN-13  
(0)**

## Enable/Disable Bookland EAN

### Parameter # 83 (SSI # 53h)

To enable or disable Bookland EAN, scan the appropriate bar code below.

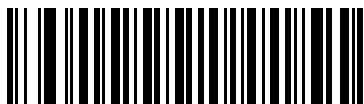

**Enable Bookland EAN  
(1)**

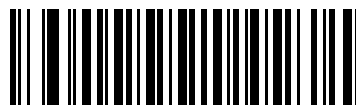

**\*Disable Bookland EAN  
(0)**



**NOTE** If you enable Bookland EAN, select a [Bookland ISBN Format on page 12-22](#). Also select either Decode UPC/EAN Supplementals, Autodiscriminate UPC/EAN Supplementals, or Enable 978/979 Supplemental Mode in [Decode UPC/EAN/JAN Supplementals on page 12-11](#).

## Decode UPC/EAN/JAN Supplementals

### Parameter # 16 (SSI # 10h)

Supplementals are bar codes appended according to specific format conventions (e.g., UPC A+2, UPC E+2, EAN 13+2). The following options are available:

- If you select **Ignore UPC/EAN with Supplementals**, and the digital scanner is presented with a UPC/EAN plus supplemental symbol, the digital scanner decodes UPC/EAN and ignores the supplemental characters.
- If you select **Decode UPC/EAN with Supplementals**, the digital scanner only decodes UPC/EAN symbols with supplemental characters, and ignores symbols without supplementals.
- If you select **Autodiscriminate UPC/EAN Supplementals**, the digital scanner decodes UPC/EAN symbols with supplemental characters immediately. If the symbol does not have a supplemental, the digital scanner must decode the bar code the number of times set via [UPC/EAN/JAN Supplemental Redundancy on page 12-14](#) before transmitting its data to confirm that there is no supplemental.
- If you select one of the following **Supplemental Mode** options, the digital scanner immediately transmits EAN-13 bar codes starting with that prefix that have supplemental characters. If the symbol does not have a supplemental, the digital scanner must decode the bar code the number of times set via [UPC/EAN/JAN Supplemental Redundancy on page 12-14](#) before transmitting its data to confirm that there is no supplemental. The digital scanner transmits UPC/EAN bar codes that do not have that prefix immediately.
  - **Enable 378/379 Supplemental Mode**
  - **Enable 978/979 Supplemental Mode**

✓ **NOTE** If you select 978/979 Supplemental Mode and are scanning Bookland EAN bar codes, see [Enable/Disable Bookland EAN on page 12-10](#) to enable Bookland EAN, and select a format using [Bookland ISBN Format on page 12-22](#).

- **Enable 977 Supplemental Mode**
- **Enable 414/419/434/439 Supplemental Mode**
- **Enable 491 Supplemental Mode**
- **Enable Smart Supplemental Mode** - applies to EAN-13 bar codes starting with any prefix listed previously.
- **Supplemental User-Programmable Type 1** - applies to EAN-13 bar codes starting with a 3-digit user-defined prefix. Set this 3-digit prefix using [User-Programmable Supplementals on page 12-14](#).
- **Supplemental User-Programmable Type 1 and 2** - applies to EAN-13 bar codes starting with either of two 3-digit user-defined prefixes. Set the 3-digit prefixes using [User-Programmable Supplementals on page 12-14](#).
- **Smart Supplemental Plus User-Programmable 1** - applies to EAN-13 bar codes starting with any prefix listed previously or the user-defined prefix set using [User-Programmable Supplementals on page 12-14](#).
- **Smart Supplemental Plus User-Programmable 1 and 2** - applies to EAN-13 bar codes starting with any prefix listed previously or one of the two user-defined prefixes set using [User-Programmable Supplementals on page 12-14](#).

✓ **NOTE** To minimize the risk of invalid data transmission, select either to decode or ignore supplemental characters.

## Decode UPC/EAN/JAN Supplementals (continued)

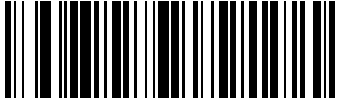

Decode UPC/EAN/JAN Only With Supplementals  
(1)



\*Ignore Supplementals  
(0)



Autodiscriminate UPC/EAN/JAN Supplementals  
(2)



Enable 378/379 Supplemental Mode  
(4)



Enable 978/979 Supplemental Mode  
(5)



Enable 977 Supplemental Mode  
(7)

### Decode UPC/EAN/JAN Supplementals (continued)



Enable 414/419/434/439 Supplemental Mode  
(6)



Enable 491 Supplemental Mode  
(8)



Enable Smart Supplemental Mode  
(3)



Supplemental User-Programmable Type 1  
(9)



Supplemental User-Programmable Type 1 and 2  
(10)



Smart Supplemental Plus User-Programmable 1  
(11)



Smart Supplemental Plus User-Programmable 1 and 2  
(12)

## User-Programmable Supplementals

### Supplemental 1: Parameter # 579 (SSI # F1h 43h)

### Supplemental 2: Parameter # 580 (SSI # F1h 44h)

If you selected a Supplemental User-Programmable option from [Decode UPC/EAN/JAN Supplementals on page 12-11](#), select **User-Programmable Supplemental 1** to set the 3-digit prefix. Then select the 3 digits using the numeric bar codes beginning on [page G-1](#). Select **User-Programmable Supplemental 2** to set a second 3-digit prefix. Then select the 3 digits using the numeric bar codes beginning on [page G-1](#). The default is 000 (zeros).



User-Programmable Supplemental 1



User-Programmable Supplemental 2

## UPC/EAN/JAN Supplemental Redundancy

### Parameter # 80 (SSI # 50h)

If you selected **Autodiscriminate UPC/EAN/JAN Supplementals**, this option adjusts the number of times to decode a symbol without supplementals before transmission. The range is from two to thirty times. Five or above is recommended when decoding a mix of UPC/EAN/JAN symbols with and without supplementals. The default is 10.

Scan the bar code below to set a decode redundancy value. Next, scan two numeric bar codes in [Appendix G, Numeric Bar Codes](#). Enter a leading zero for single digit numbers. To correct an error or change a selection, scan [Cancel on page H-1](#).

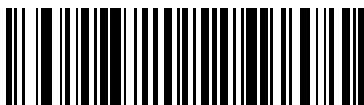

UPC/EAN/JAN Supplemental Redundancy



## UPC/EAN/JAN Supplemental AIM ID Format

### Parameter # 672 (SSI # F1h A0h)

Select an output format when reporting UPC/EAN/JAN bar codes with Supplementals with *Transmit Code ID Character on page 5-36* set to **AIM Code ID Character**:

- **Separate** - transmit UPC/EAN with supplementals with separate AIM IDs but one transmission, i.e.:  
]E<0 or 4><data>]E<1 or 2>[supplemental data]
- **Combined** – transmit UPC/EAN with supplementals with one AIM ID and one transmission, i.e.:  
]E3<data+supplemental data>
- **Separate Transmissions** - transmit UPC/EAN with supplementals with separate AIM IDs and separate transmissions, i.e.:  
]E<0 or 4><data>  
]E<1 or 2>[supplemental data]



**Separate**  
(0)



**\*Combined**  
(1)



**Separate Transmissions**  
(2)

## UPC Reduced Quiet Zone

### Parameter # 1289 (SSI # F8h 05h 09h)

Scan one of the following bar codes to enable or disable decoding UPC bar codes with reduced quiet zones. If you select **Enable**, select a [1D Quiet Zone Level on page 12-86](#).



**Enable UPC Reduced Quiet Zone  
(1)**

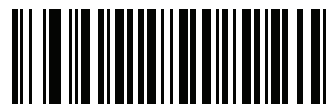

**\*Disable UPC Reduced Quiet Zone  
(0)**

## Transmit UPC-A Check Digit

### Parameter # 40 (SSI # 28h)

The check digit is the last character of the symbol used to verify the integrity of the data. Scan the appropriate bar code below to transmit the bar code data with or without the UPC-A check digit. It is always verified to guarantee the integrity of the data.



**\*Transmit UPC-A Check Digit  
(1)**

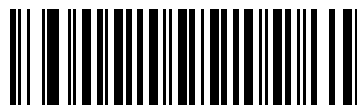

**Do Not Transmit UPC-A Check Digit  
(0)**

## Transmit UPC-E Check Digit

### Parameter # 41 (SSI # 29h)

The check digit is the last character of the symbol used to verify the integrity of the data. Scan the appropriate bar code below to transmit the bar code data with or without the UPC-E check digit. It is always verified to guarantee the integrity of the data.

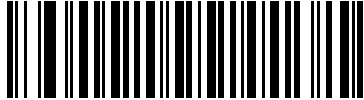

**\*Transmit UPC-E Check Digit  
(1)**

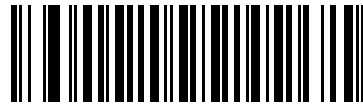

**Do Not Transmit UPC-E Check Digit  
(0)**

## Transmit UPC-E1 Check Digit

### Parameter # 42 (SSI # 2Ah)

The check digit is the last character of the symbol used to verify the integrity of the data. Scan the appropriate bar code below to transmit the bar code data with or without the UPC-E1 check digit. It is always verified to guarantee the integrity of the data.

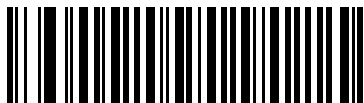

**\*Transmit UPC-E1 Check Digit  
(1)**

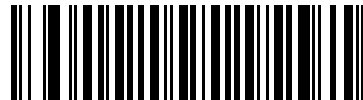

**Do Not Transmit UPC-E1 Check Digit  
(0)**

## UPC-A Preamble

### Parameter # 34 (SSI # 22h)

Preamble characters are part of the UPC symbol, and include Country Code and System Character. There are three options for transmitting a UPC-A preamble to the host device: transmit System Character only, transmit System Character and Country Code ("0" for USA), and transmit no preamble. Select the appropriate option to match the host system.

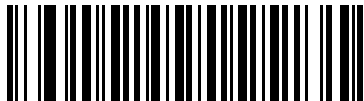

No Preamble (<DATA>)  
(0)



\*System Character (<SYSTEM CHARACTER>  
<DATA>)  
(1)

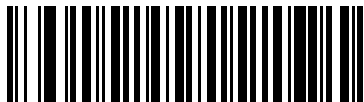

System Character & Country Code  
(< COUNTRY CODE> <SYSTEM CHARACTER>  
<DATA>)  
(2)

## UPC-E Preamble

### Parameter # 35 (SSI # 23h)

Preamble characters are part of the UPC symbol, and include Country Code and System Character. There are three options for transmitting a UPC-E preamble to the host device: transmit System Character only, transmit System Character and Country Code ("0" for USA), and transmit no preamble. Select the appropriate option to match the host system.

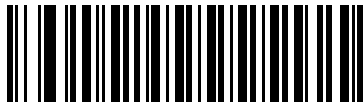

No Preamble (<DATA>)  
(0)



\*System Character (<SYSTEM CHARACTER>  
<DATA>)  
(1)

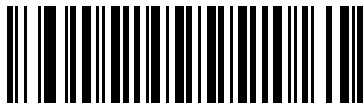

System Character & Country Code  
(< COUNTRY CODE> <SYSTEM CHARACTER>  
<DATA>)  
(2)

## UPC-E1 Preamble

### Parameter # 36 (SSI # 24h)

Preamble characters are part of the UPC symbol, and include Country Code and System Character. There are three options for transmitting a UPC-E1 preamble to the host device: transmit System Character only, transmit System Character and Country Code ("0" for USA), and transmit no preamble. Select the appropriate option to match the host system.

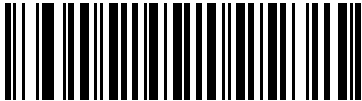

No Preamble (<DATA>)  
(0)

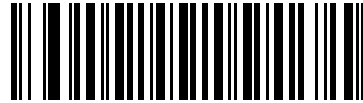

\*System Character (<SYSTEM CHARACTER> <DATA>)  
(1)

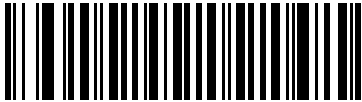

System Character & Country Code  
(< COUNTRY CODE> <SYSTEM CHARACTER> <DATA>)  
(2)

## Convert UPC-E to UPC-A

### Parameter # 37 (SSI # 25h)

Enable this to convert UPC-E (zero suppressed) decoded data to UPC-A format before transmission. After conversion, the data follows UPC-A format and is affected by UPC-A programming selections (e.g., Preamble, Check Digit).

Disable this to transmit UPC-E decoded data as UPC-E data, without conversion.

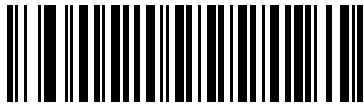

Convert UPC-E to UPC-A (Enable)  
(1)

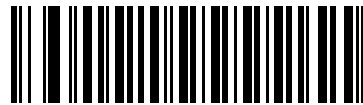

\*Do Not Convert UPC-E to UPC-A (Disable)  
(0)

## Convert UPC-E1 to UPC-A

### Parameter # 38 (SSI # 26h)

Enable this to convert UPC-E1 decoded data to UPC-A format before transmission. After conversion, the data follows UPC-A format and is affected by UPC-A programming selections (e.g., Preamble, Check Digit).

Disable this to transmit UPC-E1 decoded data as UPC-E1 data, without conversion.

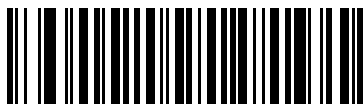

Convert UPC-E1 to UPC-A (Enable)  
(1)



\*Do Not Convert UPC-E1 to UPC-A (Disable)  
(0)

## EAN-8/JAN-8 Extend

### Parameter # 39 (SSI # 27h)

Enable this parameter to add five leading zeros to decoded EAN-8 symbols to make them compatible in format to EAN-13 symbols. Disable this to transmit EAN-8 symbols as is.



Enable EAN/JAN Zero Extend  
(1)

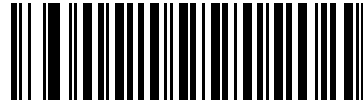

\*Disable EAN/JAN Zero Extend  
(0)

## Bookland ISBN Format

### Parameter # 576 (SSI # F1h 40h)

If you enabled Bookland EAN using [Enable/Disable Bookland EAN on page 12-10](#), select one of the following formats for Bookland data:

- **Bookland ISBN-10** - The digital scanner reports Bookland data starting with 978 in traditional 10-digit format with the special Bookland check digit for backward-compatibility. Data starting with 979 is not considered Bookland in this mode.
- **Bookland ISBN-13** - The digital scanner reports Bookland data (starting with either 978 or 979) as EAN-13 in 13-digit format to meet the 2007 ISBN-13 protocol.



\*Bookland ISBN-10  
(0)



Bookland ISBN-13  
(1)



**NOTE** For Bookland EAN to function properly, first enable Bookland EAN using [Enable/Disable Bookland EAN on page 12-10](#), then select either Decode UPC/EAN Supplementals, Autodiscriminate UPC/EAN Supplementals, or Enable 978/979 Supplemental Mode in [Decode UPC/EAN/JAN Supplementals on page 12-11](#).



## UCC Coupon Extended Code

### Parameter # 85 (SSI # 55h)

Enable this parameter to decode UPC-A bar codes starting with digit '5', EAN-13 bar codes starting with digit '99', and UPC-A/GS1-128 Coupon Codes. UPCA, EAN-13, and GS1-128 must be enabled to scan all types of Coupon Codes.

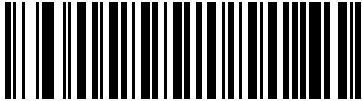

Enable UCC Coupon Extended Code  
(1)

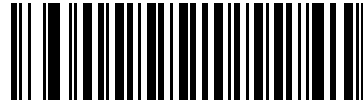

\*Disable UCC Coupon Extended Code  
(0)



**NOTE** See [UPC/EAN/JAN Supplemental Redundancy on page 12-14](#) to control autodiscrimination of the GS1-128 (right half) of a coupon code.

## Coupon Report

### Parameter # 730 (SSI # F1h DAh)

Select an option to determine which type of coupon format to support.

- Select **Old Coupon Format** to support UPC-A/GS1-128 and EAN-13/GS1-128.
- Select **New Coupon Format** as an interim format to support UPC-A/GS1-DataBar and EAN-13/GS1-DataBar.
- If you select **Autodiscriminate Format**, the digital scanner supports both **Old Coupon Format** and **New Coupon Format**.



Old Coupon Format  
(0)



\*New Coupon Format  
(1)



Autodiscriminate Coupon Format  
(2)

## ISSN EAN

### Parameter # 617 (SSI # F1h 69h)

To enable or disable ISSN EAN, scan the appropriate bar code below.



Enable ISSN EAN  
(1)



\*Disable ISSN EAN  
(0)

---

## Code 128

### Enable/Disable Code 128

#### Parameter # 8 (SSI # 08h)

To enable or disable Code 128, scan the appropriate bar code below.

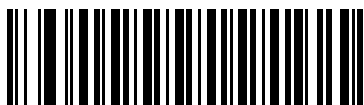

\*Enable Code 128  
(1)



Disable Code 128  
(0)

## Set Lengths for Code 128

### Parameter # L1 = 209 (SSI # D1h), L2 = 210 (SSI # D2h)

The length of a code refers to the number of characters (i.e., human readable characters), including check digit(s) the code contains. Set lengths for Code 128 to any length, one or two discrete lengths, or lengths within a specific range. The default Any Length.

✓ **NOTE** When setting lengths for different bar code types, enter a leading zero for single digit numbers.

- **One Discrete Length** - Select this option to decode only Code 128 symbols containing a selected length. Select the length using the numeric bar codes in [Appendix G, Numeric Bar Codes](#). For example, to decode only Code 128 symbols with 14 characters, scan **Code 128 - One Discrete Length**, then scan **1** followed by **4**. To correct an error or change the selection, scan [Cancel on page H-1](#).
- **Two Discrete Lengths** - Select this option to decode only Code 128 symbols containing either of two selected lengths. Select lengths using the numeric bar codes in [Appendix G, Numeric Bar Codes](#). For example, to decode only Code 128 symbols containing either 2 or 14 characters, select **Code 128 - Two Discrete Lengths**, then scan **0, 2, 1**, and then **4**. To correct an error or change the selection, scan [Cancel on page H-1](#).
- **Length Within Range** - Select this option to decode a Code 128 symbol with a specific length range. Select lengths using numeric bar codes in [Appendix G, Numeric Bar Codes](#). For example, to decode Code 128 symbols containing between 4 and 12 characters, first scan **Code 128 - Length Within Range**. Then scan **0, 4, 1**, and **2** (enter a leading zero for single digit numbers). To correct an error or change the selection, scan [Cancel on page H-1](#).
- **Any Length (default)**- Select this option to decode Code 128 symbols containing any number of characters within the digital scanner capability.

### Set Lengths for Code 128 (continued)

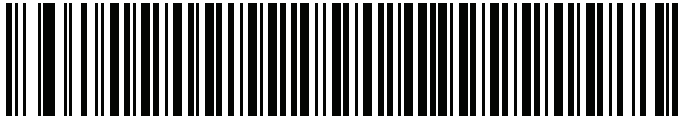

Code 128 - One Discrete Length

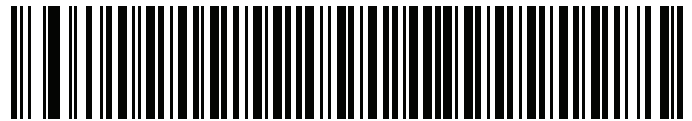

Code 128 - Two Discrete Lengths

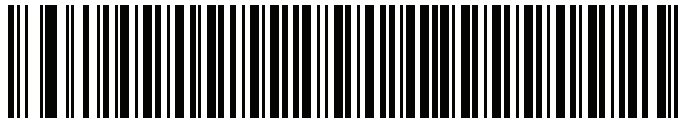

Code 128 - Length Within Range

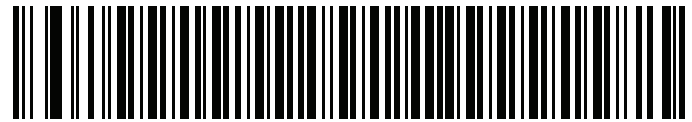

\* Code 128 - Any Length

## Enable/Disable GS1-128 (formerly UCC/EAN-128)

### Parameter # 14 (SSI # 0Eh)

To enable or disable GS1-128, scan the appropriate bar code below.

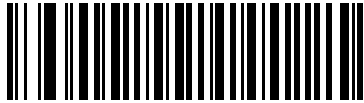

**\*Enable GS1-128**  
**(1)**

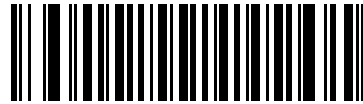

**Disable GS1-128**  
**(0)**

## Enable/Disable ISBT 128

### Parameter # 84 (SSI # 54h)

ISBT 128 is a variant of Code 128 used in the blood bank industry. Scan a bar code below to enable or disable ISBT 128. If necessary, the host must perform concatenation of the ISBT data.



**\*Enable ISBT 128**  
**(1)**



**Disable ISBT 128**  
**(0)**

## ISBT Concatenation

### Parameter # 577 (SSI # F1h 41h)

Select an option for concatenating pairs of ISBT code types:

- If you select **Disable ISBT Concatenation**, the digital scanner does not concatenate pairs of ISBT codes it encounters.
- If you select **Enable ISBT Concatenation**, there must be two ISBT codes in order for the digital scanner to decode and perform concatenation. The digital scanner does not decode single ISBT symbols.
- If you select **Autodiscriminate ISBT Concatenation**, the digital scanner decodes and concatenates pairs of ISBT codes immediately. If only a single ISBT symbol is present, the digital scanner must decode the symbol the number of times set via [ISBT Concatenation Redundancy on page 12-29](#) before transmitting its data to confirm that there is no additional ISBT symbol.



**Disable ISBT Concatenation  
(0)**



**Enable ISBT Concatenation  
(1)**



**\*Autodiscriminate ISBT Concatenation  
(2)**

## Check ISBT Table

### Parameter # 578 (SSI # F1h 42h)

The ISBT specification includes a table that lists several types of ISBT bar codes that are commonly used in pairs. If you set **ISBT Concatenation** to **Enable**, enable **Check ISBT Table** to concatenate only those pairs found in this table. Other types of ISBT codes are not concatenated.



\*Enable Check ISBT Table  
(1)



Disable Check ISBT Table  
(0)

## ISBT Concatenation Redundancy

### Parameter # 223 (SSI # DFh)

If you set **ISBT Concatenation** to **Autodiscriminate**, use this parameter to set the number of times the digital scanner must decode an ISBT symbol before determining that there is no additional symbol.

Scan the bar code below, then scan two numeric bar codes in [Appendix G, Numeric Bar Codes](#) to set a value between 2 and 20. Enter a leading zero for single digit numbers. To correct an error or change a selection, scan [Cancel on page H-1](#). The default is 10.



ISBT Concatenation Redundancy

## Code 128 Security Level

### Parameter # 751 (SSI # F1h EFh)

Code 128 bar codes are vulnerable to misdecodes, particularly when Code 128 Lengths is set to **Any Length**. The digital scanner offers four levels of decode security for Code 128 bar codes. There is an inverse relationship between security and digital scanner aggressiveness. Increasing the level of security can reduce scanning aggressiveness, so select only the level of security necessary.

- **Code 128 Security Level 0:** This setting allows the digital scanner to operate in its most aggressive state, while providing sufficient security in decoding most in-spec bar codes.
- **Code 128 Security Level 1:** A bar code must be successfully read twice, and satisfy certain safety requirements before being decoded. This default setting eliminates most misdecodes.
- **Code 128 Security Level 2:** Select this option with greater bar code security requirements if **Security Level 1** fails to eliminate misdecodes.
- **Code 128 Security Level 3:** If you selected **Security Level 2**, and misdecodes still occur, select this security level to apply the highest safety requirements. A bar code must be successfully read three times before being decoded.

✓ **NOTE** Selecting this option is an extreme measure against mis-decoding severely out-of-spec bar codes. Selecting this level of security significantly impairs the decoding ability of the digital scanner. If this level of security is required, try to improve the quality of the bar codes.

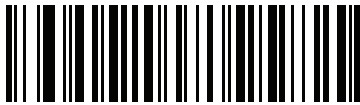

Code 128 Security Level 0  
(0)

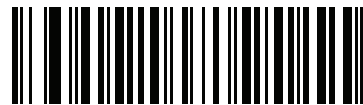

\*Code 128 Security Level 1  
(1)

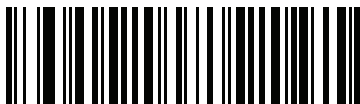

Code 128 Security Level 2  
(2)



Code 128 Security Level 3  
(3)



## Code 128 Reduced Quiet Zone

### Parameter # 1208 (SSI # F8h 04h B8h)

Scan one of the following bar codes to enable or disable decoding Code 128 bar codes with reduced quiet zones. If you select **Enable**, select a *1D Quiet Zone Level on page 12-86*.



Enable Code 128 Reduced Quiet Zone  
(1)



\*Disable Code 128 Reduced Quiet Zone  
(0)

## Ignore Code 128 <FNC4>

### Parameter # 1254 (SSI # F8h 04h E6h)

This feature applies to Code 128 bar codes with an embedded <FNC4> character. Enable this to strip the <FNC4> character from the decode data. The remaining characters are sent to the host unchanged. When disabled, the <FNC4> character is processed normally as per Code 128 standard.



Enable Ignore Code 128 <FNC4>  
(1)



\*Disable Ignore Code 128 <FNC4>  
(0)

---

## Code 39

### Enable/Disable Code 39

#### Parameter # 0 (SSI # 00h)

To enable or disable Code 39, scan the appropriate bar code below.

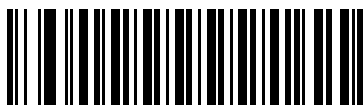

**\*Enable Code 39**  
(1)



**Disable Code 39**  
(0)

### Enable/Disable Trioptic Code 39

#### Parameter # 13 (SSI # 0Dh)

Trioptic Code 39 is a variant of Code 39 used in the marking of computer tape cartridges. Trioptic Code 39 symbols always contain six characters. To enable or disable Trioptic Code 39, scan the appropriate bar code below.

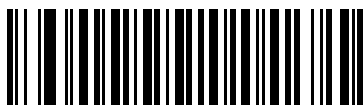

**Enable Trioptic Code 39**  
(1)



**\*Disable Trioptic Code 39**  
(0)



**NOTE** You cannot enable Trioptic Code 39 and Code 39 Full ASCII simultaneously.

## Convert Code 39 to Code 32

### Parameter # 86 (SSI # 56h)

Code 32 is a variant of Code 39 used by the Italian pharmaceutical industry. Scan the appropriate bar code below to enable or disable converting Code 39 to Code 32.

✓ **NOTE** Code 39 must be enabled for this parameter to function.



Enable Convert Code 39 to Code 32  
(1)

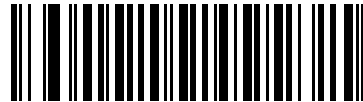

\*Disable Convert Code 39 to Code 32  
(0)

## Code 32 Prefix

### Parameter # 231 (SSI # E7h)

Scan the appropriate bar code below to enable or disable adding the prefix character "A" to all Code 32 bar codes.

✓ **NOTE** Convert Code 39 to Code 32 must be enabled for this parameter to function.



Enable Code 32 Prefix  
(1)



\*Disable Code 32 Prefix  
(0)

## Set Lengths for Code 39

### Parameter # L1 = 18 (SSI # 12h), L2 = 19 (SSI # 13h)

The length of a code refers to the number of characters (i.e., human readable characters), including check digit(s) the code contains. Set lengths for Code 39 to any length, one or two discrete lengths, or lengths within a specific range. If Code 39 Full ASCII is enabled, **Length Within a Range** or **Any Length** are the preferred options. The default is 1 to 55.

✓ **NOTE** When setting lengths for different bar code types, enter a leading zero for single digit numbers.

- **One Discrete Length** - Select this option to decode only Code 39 symbols containing a selected length. Select the length using the numeric bar codes in [Appendix G, Numeric Bar Codes](#). For example, to decode only Code 39 symbols with 14 characters, scan **Code 39 - One Discrete Length**, then scan **1** followed by **4**. To correct an error or change the selection, scan [Cancel on page H-1](#).
- **Two Discrete Lengths** - Select this option to decode only Code 39 symbols containing either of two selected lengths. Select lengths using the numeric bar codes in [Appendix G, Numeric Bar Codes](#). For example, to decode only Code 39 symbols containing either 2 or 14 characters, select **Code 39 - Two Discrete Lengths**, then scan **0, 2, 1**, and then **4**. To correct an error or change the selection, scan [Cancel on page H-1](#).
- **Length Within Range** - Select this option to decode a Code 39 symbol with a specific length range. Select lengths using numeric bar codes in [Appendix G, Numeric Bar Codes](#). For example, to decode Code 39 symbols containing between 4 and 12 characters, first scan **Code 39 - Length Within Range**. Then scan **0, 4, 1**, and **2** (enter a leading zero for single digit numbers). To correct an error or change the selection, scan [Cancel on page H-1](#).
- **Any Length** - Select this option to decode Code 39 symbols containing any number of characters within the digital scanner capability.



Code 39 - One Discrete Length



Code 39 - Two Discrete Lengths



\*Code 39 - Length Within Range



Code 39 - Any Length

## Code 39 Check Digit Verification

### Parameter # 48 (SSI # 30h)

Enable this feature to check the integrity of all Code 39 symbols to verify that the data complies with specified check digit algorithm. Only Code 39 symbols which include a modulo 43 check digit are decoded. Enable this feature if the Code 39 symbols contain a Modulo 43 check digit.

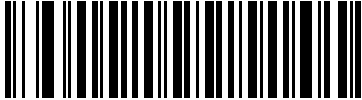

**Enable Code 39 Check Digit**  
(1)

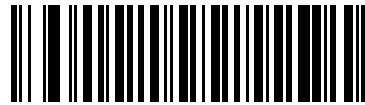

**\*Disable Code 39 Check Digit**  
(0)

## Transmit Code 39 Check Digit

### Parameter # 43 (SSI # 2Bh)

Scan a bar code below to transmit Code 39 data with or without the check digit.



**Transmit Code 39 Check Digit (Enable)**  
(1)



**\*Do Not Transmit Code 39 Check Digit (Disable)**  
(0)



**NOTE** Code 39 Check Digit Verification must be enabled for this parameter to function.

## Code 39 Full ASCII Conversion

### Parameter # 17 (SSI # 11h)

Code 39 Full ASCII is a variant of Code 39 which pairs characters to encode the full ASCII character set. To enable or disable Code 39 Full ASCII, scan the appropriate bar code below.



**Enable Code 39 Full ASCII  
(1)**

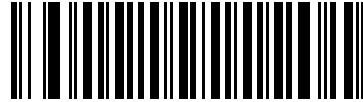

**\*Disable Code 39 Full ASCII  
(0)**



**NOTE** You cannot enable Trioptic Code 39 and Code 39 Full ASCII simultaneously.

Code 39 Full ASCII to Full ASCII Correlation is host-dependent, and is therefore described in the ASCII Character Set Table for the appropriate interface. See the [ASCII Character Sets for USB on page 7-16](#).

## Code 39 Security Level

### Parameter # 750 (SSI # F1h EEh)

The digital scanner offers four levels of decode security for Code 39 bar codes. There is an inverse relationship between security and digital scanner aggressiveness. Increasing the level of security can reduce scanning aggressiveness, so select only the level of security necessary.

- **Code 39 Security Level 0:** This setting allows the digital scanner to operate in its most aggressive state, while providing sufficient security in decoding most in-spec bar codes.
- **Code 39 Security Level 1:** This default setting eliminates most misdecodes.
- **Code 39 Security Level 2:** Select this option with greater bar code security requirements if **Security Level 1** fails to eliminate misdecodes.
- **Code 39 Level 3:** If you selected **Security Level 2**, and misdecodes still occur, select this security level to apply the highest safety requirements.

✓ **NOTE** Selecting this option is an extreme measure against mis-decoding severely out-of-spec bar codes. Selecting this level of security significantly impairs the decoding ability of the digital scanner. If this level of security is required, try to improve the quality of the bar codes.

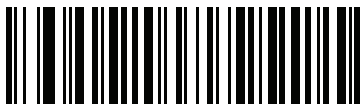

Code 39 Security Level 0  
(0)



\*Code 39 Security Level 1  
(1)

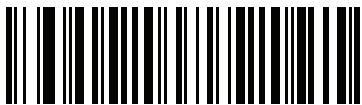

Code 39 Security Level 2  
(2)



Code 39 Security Level 3  
(3)

## Code 39 Reduced Quiet Zone

### Parameter # 1209 (SSI # F8h 04h B9h)

Scan one of the following bar codes to enable or disable decoding Code 39 bar codes with reduced quiet zones. If you select **Enable**, select a [1D Quiet Zone Level on page 12-86](#).



Enable Code 39 Reduced Quiet Zone  
(1)



\*Disable Code 39 Reduced Quiet Zone  
(0)

---

## Code 93

### Enable/Disable Code 93

### Parameter # 9 (SSI # 09h)

To enable or disable Code 93, scan the appropriate bar code below.

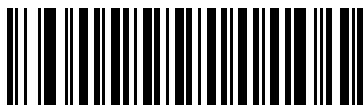

\*Enable Code 93  
(1)



Disable Code 93  
(0)



## Set Lengths for Code 93

### Parameter # L1 = 26 (SSI # 1Ah), L2 = 27 (SSI # 1Bh)

The length of a code refers to the number of characters (i.e., human readable characters), including check digit(s) the code contains. Set lengths for Code 93 to any length, one or two discrete lengths, or lengths within a specific range. The default is 1 to 55.

- **One Discrete Length** - Select this option to decode only Code 93 symbols containing a selected length. Select the length using the numeric bar codes in [Appendix G, Numeric Bar Codes](#). For example, to decode only Code 93 symbols with 14 characters, scan **Code 93 - One Discrete Length**, then scan **1** followed by **4**. To correct an error or to change the selection, scan [Cancel on page H-1](#).
- **Two Discrete Lengths** - Select this option to decode only Code 93 symbols containing either of two selected lengths. Select lengths using the numeric bar codes in [Appendix G, Numeric Bar Codes](#). For example, to decode only Code 93 symbols containing either 2 or 14 characters, select **Code 93 - Two Discrete Lengths**, then scan **0, 2, 1**, and then **4**. To correct an error or to change the selection, scan [Cancel on page H-1](#).
- **Length Within Range** - Select this option to decode a Code 93 symbol with a specific length range. Select lengths using the numeric bar codes in [Appendix G, Numeric Bar Codes](#). For example, to decode Code 93 symbols containing between 4 and 12 characters, first scan **Code 93 - Length Within Range**. Then scan **0, 4, 1**, and **2** (enter a leading zero for single digit numbers). To correct an error or change the selection, scan [Cancel on page H-1](#).
- **Any Length** - Scan this option to decode Code 93 symbols containing any number of characters within the digital scanner capability.



Code 93 - One Discrete Length



Code 93 - Two Discrete Lengths



\*Code 93 - Length Within Range



Code 93 - Any Length

## Code 11

### Code 11

#### Parameter # 10 (SSI # 0Ah)

To enable or disable Code 11, scan the appropriate bar code below.

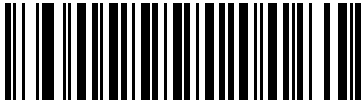

Enable Code 11  
(1)

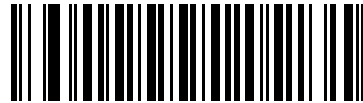

\*Disable Code 11  
(0)

### Set Lengths for Code 11

#### Parameter # L1 = 28 (SSI # 1Ch), L2 = 29 (SSI # 1Dh)

The length of a code refers to the number of characters (i.e., human readable characters), including check digit(s) the code contains. Set lengths for Code 11 to any length, one or two discrete lengths, or lengths within a specific range. The default is 4 to 55.

- **One Discrete Length** - Select this option to decode only Code 11 symbols containing a selected length. Select the length using the numeric bar codes in [Appendix G, Numeric Bar Codes](#). For example, to decode only Code 11 symbols with 14 characters, scan **Code 11 - One Discrete Length**, then scan **1** followed by **4**. To correct an error or to change the selection, scan [Cancel on page H-1](#).
- **Two Discrete Lengths** - Select this option to decode only Code 11 symbols containing either of two selected lengths. Select lengths using the numeric bar codes in [Appendix G, Numeric Bar Codes](#). For example, to decode only Code 11 symbols containing either 2 or 14 characters, select **Code 11 - Two Discrete Lengths**, then scan **0, 2, 1**, and then **4**. To correct an error or to change the selection, scan [Cancel on page H-1](#).
- **Length Within Range** - Select this option to decode a Code 11 symbol with a specific length range. Select lengths using numeric bar codes in [Appendix G, Numeric Bar Codes](#). For example, to decode Code 11 symbols containing between 4 and 12 characters, first scan **Code 11 - Length Within Range**. Then scan **0, 4, 1**, and **2** (enter a leading zero for single digit numbers). To correct an error or change the selection, scan [Cancel on page H-1](#).
- **Any Length** - Scan this option to decode Code 11 symbols containing any number of characters within the digital scanner capability.

**Set Lengths for Code 11 (continued)**



**Code 11 - One Discrete Length**



**Code 11 - Two Discrete Lengths**



**\*Code 11 - Length Within Range**



**Code 11 - Any Length**

## Code 11 Check Digit Verification

### Parameter # 52 (SSI # 34h)

This feature allows the digital scanner to check the integrity of all Code 11 symbols to verify that the data complies with the specified check digit algorithm. This selects the check digit mechanism for the decoded Code 11 bar code. The options are to check for one check digit, check for two check digits, or disable the feature.

To enable this feature, scan the bar code below corresponding to the number of check digits encoded in the Code 11 symbols.

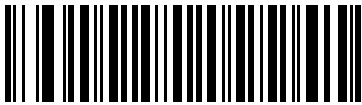

**\*Disable  
(0)**

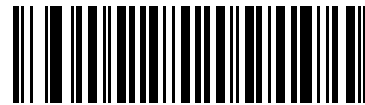

**One Check Digit  
(1)**

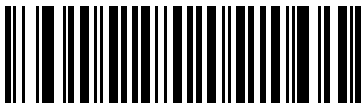

**Two Check Digits  
(2)**

## Transmit Code 11 Check Digits

### Parameter # 47 (SSI # 2Fh)

This feature selects whether or not to transmit the Code 11 check digit(s).



**Transmit Code 11 Check Digit(s) (Enable)  
(1)**

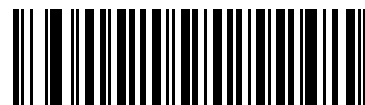

**\*Do Not Transmit Code 11 Check Digit(s) (Disable)  
(0)**



**NOTE** Code 11 Check Digit Verification must be enabled for this parameter to function.

## Interleaved 2 of 5 (ITF)

### Enable/Disable Interleaved 2 of 5

#### Parameter # 6 (SSI # 06h)

To enable or disable Interleaved 2 of 5, scan the appropriate bar code below, and select an Interleaved 2 of 5 length from the following pages.

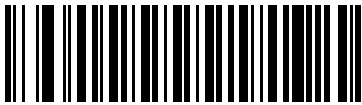

\*Enable Interleaved 2 of 5  
(1)

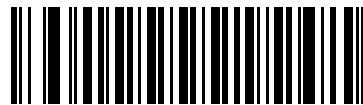

Disable Interleaved 2 of 5  
(0)

### Set Lengths for Interleaved 2 of 5

#### Parameter # L1 = 22 (SSI # 16h), L2 = 23 (SSI # 17h)

The length of a code refers to the number of characters (i.e., human readable characters), including check digit(s) the code contains. Set lengths for I 2 of 5 to any length, one or two discrete lengths, or lengths within a specific range. The range for Interleaved 2 of 5 lengths is 0 - 55. The default is 6 to 55.

- **One Discrete Length** - Select this option to decode only I 2 of 5 symbols containing a selected length. Select the length using the numeric bar codes in [Appendix G, Numeric Bar Codes](#). For example, to decode only I 2 of 5 symbols with 14 characters, scan **I 2 of 5 - One Discrete Length**, then scan **1** followed by **4**. To correct an error or to change the selection, scan [Cancel on page H-1](#).
- **Two Discrete Lengths** - Select this option to decode only I 2 of 5 symbols containing either of two selected lengths. Select lengths using the numeric bar codes in [Appendix G, Numeric Bar Codes](#). For example, to decode only I 2 of 5 symbols containing either 2 or 14 characters, select **I 2 of 5 - Two Discrete Lengths**, then scan **0, 2, 1**, and then **4**. To correct an error or to change the selection, scan [Cancel on page H-1](#).
- **Length Within Range** - Select this option to decode an I 2 of 5 symbol with a specific length range. Select lengths using numeric bar codes in [Appendix G, Numeric Bar Codes](#). For example, to decode I 2 of 5 symbols containing between 4 and 12 characters, first scan **I 2 of 5 - Length Within Range**. Then scan **0, 4, 1**, and **2** (enter a leading zero for single digit numbers). To correct an error or change the selection, scan [Cancel on page H-1](#).
- **Any Length** - Scan this option to decode I 2 of 5 symbols containing any number of characters within the digital scanner capability.

✓ **NOTE** Due to the construction of the I 2 of 5 symbology, it is possible for a scan line covering only a portion of the code to transmit as a complete scan, yielding less data than is encoded in the bar code. To prevent this, select specific lengths (I 2 of 5 - One Discrete Length, Two Discrete Lengths) for I 2 of 5 applications.

### Set Lengths for Interleaved 2 of 5 (continued)



**I 2 of 5 - One Discrete Length**



**I 2 of 5 - Two Discrete Lengths**



**\*I 2 of 5 - Length Within Range**



**I 2 of 5 - Any Length**

## I 2 of 5 Check Digit Verification

### Parameter # 49 (SSI # 31h)

Enable this feature to check the integrity of all I 2 of 5 symbols to verify the data complies with either the specified Uniform Symbology Specification (USS), or the Optical Product Code Council (OPCC) check digit algorithm.



**\*Disable  
(0)**



**USS Check Digit  
(1)**



**OPCC Check Digit  
(2)**

## Transmit I 2 of 5 Check Digit

### Parameter # 44 (SSI # 2Ch)

Scan the appropriate bar code below to transmit I 2 of 5 data with or without the check digit.

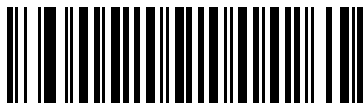

**Transmit I 2 of 5 Check Digit (Enable)  
(1)**



**\*Do Not Transmit I 2 of 5 Check Digit (Disable)  
(0)**

## Convert I 2 of 5 to EAN-13

### Parameter # 82 (SSI # 52h)

Enable this parameter to convert 14-character I 2 of 5 codes to EAN-13, and transmit to the host as EAN-13. To accomplish this, the I 2 of 5 code must be enabled, and the code must have a leading zero and a valid EAN-13 check digit.

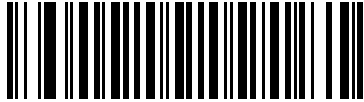

Convert I 2 of 5 to EAN-13 (Enable)  
(1)

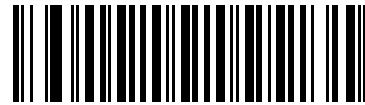

\*Do Not Convert I 2 of 5 to EAN-13 (Disable)  
(0)

## I 2 of 5 Security Level

### Parameter # 1121 (SSI # F8h 04h 61h)

Interleaved 2 of 5 bar codes are vulnerable to misdecodes, particularly when I 2 of 5 Lengths is set to **Any Length**. The digital scanner offers four levels of decode security for Interleaved 2 of 5 bar codes. There is an inverse relationship between security and digital scanner aggressiveness. Increasing the level of security can reduce scanning aggressiveness, so select only the level of security necessary.

- **I 2 of 5 Security Level 0:** This setting allows the digital scanner to operate in its most aggressive state, while providing sufficient security in decoding most in-spec bar codes.
- **I 2 of 5 Security Level 1:** A bar code must be successfully read twice, and satisfy certain safety requirements before being decoded. This default setting eliminates most misdecodes.
- **I 2 of 5 Security Level 2:** Select this option with greater bar code security requirements if **Security Level 1** fails to eliminate misdecodes.
- **I 2 of 5 Security Level 3:** If you selected **Security Level 2**, and misdecodes still occur, select this security level. The highest safety requirements are applied. A bar code must be successfully read three times before being decoded.



**NOTE** Selecting this option is an extreme measure against mis-decoding severely out-of-spec bar codes. Selecting this level of security significantly impairs the decoding ability of the digital scanner. If this level of security is required, try to improve the quality of the bar codes.



**I 2 of 5 Security Level (continued)**

**I 2 of 5 Security Level 0  
(00h)**

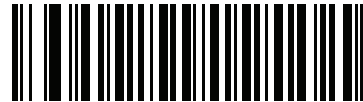

**\*I 2 of 5 Security Level 1  
(01h)**



**I 2 of 5 Security Level 2  
(02h)**

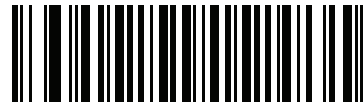

**I 2 of 5 Security Level 3  
(03h)**

**I 2 of 5 Reduced Quiet Zone****Parameter # 1210 (SSI # F8h 04h BAh)**

Scan one of the following bar codes to enable or disable decoding I 2 of 5 bar codes with reduced quiet zones. If you select **Enable**, select a [1D Quiet Zone Level on page 12-86](#).



**Enable I 2 of 5 Reduced Quiet Zone  
(1)**



**\*Disable I 2 of 5 Reduced Quiet Zone  
(0)**

## Discrete 2 of 5 (DTF)

### Enable/Disable Discrete 2 of 5

#### Parameter # 5 (SSI # 05h)

To enable or disable Discrete 2 of 5, scan the appropriate bar code below.

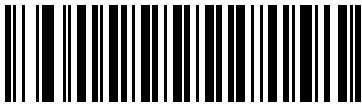

Enable Discrete 2 of 5  
(1)



\*Disable Discrete 2 of 5  
(0)

### Set Lengths for Discrete 2 of 5

#### Parameter # L1 = 20 (SSI # 14h), L2 = 21 (SSI # 15h)

The length of a code refers to the number of characters (i.e., human readable characters), including check digit(s) the code contains. Set lengths for D 2 of 5 to any length, one or two discrete lengths, or lengths within a specific range. The range for Discrete 2 of 5 lengths is 1 - 55.

- **One Discrete Length** - Select this option to decode only D 2 of 5 symbols containing a selected length. Select the length using the numeric bar codes in [Appendix G, Numeric Bar Codes](#). For example, to decode only D 2 of 5 symbols with 14 characters, scan **D 2 of 5 - One Discrete Length**, then scan **1** followed by **4**. To correct an error or to change the selection, scan [Cancel on page H-1](#).
- **Two Discrete Lengths** - Select this option to decode only D 2 of 5 symbols containing either of two selected lengths. Select lengths using the numeric bar codes in [Appendix G, Numeric Bar Codes](#). For example, to decode only D 2 of 5 symbols containing either 2 or 14 characters, select **D 2 of 5 - Two Discrete Lengths**, then scan **0**, **2**, **1**, and then **4**. To correct an error or to change the selection, scan [Cancel on page H-1](#).
- **Length Within Range** - Select this option to decode a D 2 of 5 symbol with a specific length range. Select lengths using numeric bar codes in [Appendix G, Numeric Bar Codes](#). For example, to decode D 2 of 5 symbols containing between 4 and 12 characters, first scan **D 2 of 5 - Length Within Range**. Then scan **0**, **4**, **1**, and **2** (enter a leading zero for single digit numbers). To correct an error or change the selection, scan [Cancel on page H-1](#).
- **Any Length** - Scan this option to decode D 2 of 5 symbols containing any number of characters within the digital scanner capability.

✓ **NOTE** Due to the construction of the D 2 of 5 symbology, it is possible for a scan line covering only a portion of the code to transmit as a complete scan, yielding less data than is encoded in the bar code. To prevent this, select specific lengths (**D 2 of 5 - One Discrete Length, Two Discrete Lengths**) for D 2 of 5 applications.

### Set Lengths for Discrete 2 of 5 (continued)



D 2 of 5 - One Discrete Length



D 2 of 5 - Two Discrete Lengths



\*D 2 of 5 - Length Within Range



D 2 of 5 - Any Length

## Codabar (NW - 7)

### Enable/Disable Codabar

#### Parameter # 7 (SSI # 07h)

To enable or disable Codabar, scan the appropriate bar code below.

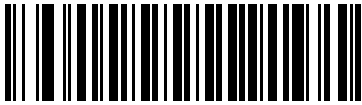

\*Enable Codabar  
(1)



Disable Codabar  
(0)

### Set Lengths for Codabar

#### Parameter # L1 = 24 (SSI # 18h), L2 = 25 (SSI # 19h)

The length of a code refers to the number of characters (i.e., human readable characters), including check digit(s) the code contains. Set lengths for Codabar to any length, one or two discrete lengths, or lengths within a specific range. The default is 4 to 55.

- **One Discrete Length** - Select this option to decode only Codabar symbols containing a selected length. Select the length using the numeric bar codes in [Appendix G, Numeric Bar Codes](#). For example, to decode only Codabar symbols with 14 characters, scan **Codabar - One Discrete Length**, then scan **1** followed by **4**. To correct an error or to change the selection, scan [Cancel on page H-1](#).
- **Two Discrete Lengths** - Select this option to decode only Codabar symbols containing either of two selected lengths. Select lengths using the numeric bar codes in [Appendix G, Numeric Bar Codes](#). For example, to decode only Codabar symbols containing either 2 or 14 characters, select **Codabar - Two Discrete Lengths**, then scan **0, 2, 1**, and then **4**. To correct an error or to change the selection, scan [Cancel on page H-1](#).
- **Length Within Range** - Select this option to decode a Codabar symbol with a specific length range. Select lengths using numeric bar codes in [Appendix G, Numeric Bar Codes](#). For example, to decode Codabar symbols containing between 4 and 12 characters, first scan **Codabar - Length Within Range**. Then scan **0, 4, 1**, and **2** (enter a leading zero for single digit numbers). To correct an error or change the selection, scan [Cancel on page H-1](#).
- **Any Length** - Scan this option to decode Codabar symbols containing any number of characters within the digital scanner capability.

### Set Lengths for Codabar (continued)



Codabar - One Discrete Length



Codabar - Two Discrete Lengths



\*Codabar - Length Within Range



Codabar - Any Length

## CLSI Editing

### Parameter # 54 (SSI # 36h)

Enable this parameter to strip the start and stop characters and insert a space after the first, fifth, and tenth characters of a 14-character Codabar symbol. Enable this feature if the host system requires this data format.



**NOTE** Symbol length does not include start and stop characters.

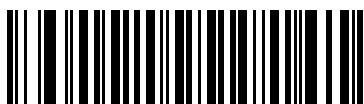

Enable CLSI Editing  
(1)



\*Disable CLSI Editing  
(0)

## NOTIS Editing

### Parameter # 55 (SSI # 37h)

Enable this parameter to strip the start and stop characters from a decoded Codabar symbol. Enable this feature if the host system requires this data format.

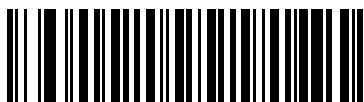

Enable NOTIS Editing  
(1)



\*Disable NOTIS Editing  
(0)

## Codabar Upper or Lower Case Start/Stop Characters Detection

### Parameter # 855 (SSI # F2h 57h)

Select whether to detect upper case or lower case Codabar start/stop characters.



Lower Case  
(1)



\*Upper Case  
(0)

---

## MSI

### Enable/Disable MSI

#### Parameter # 11 (SSI # 0Bh)

To enable or disable MSI, scan the appropriate bar code below.

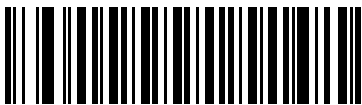

Enable MSI  
(1)

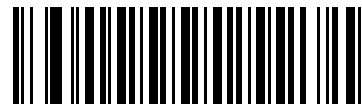

\*Disable MSI  
(0)

## Set Lengths for MSI

### Parameter # L1 = 30 (SSI # 1Eh), L2 = 31 (SSI # 1Fh)

The length of a code refers to the number of characters (i.e., human readable characters), including check digit(s) the code contains. Set lengths for MSI to any length, one or two discrete lengths, or lengths within a specific range. The default is 4 to 55.

- **One Discrete Length** - Select this option to decode only MSI symbols containing a selected length. Select the length using the numeric bar codes in [Appendix G, Numeric Bar Codes](#). For example, to decode only MSI symbols with 14 characters, scan **MSI - One Discrete Length**, then scan **1** followed by **4**. To correct an error or to change the selection, scan [Cancel on page H-1](#).
- **Two Discrete Lengths** - Select this option to decode only MSI symbols containing either of two selected lengths. Select lengths using the numeric bar codes in [Appendix G, Numeric Bar Codes](#). For example, to decode only MSI symbols containing either 2 or 14 characters, select **MSI - Two Discrete Lengths**, then scan **0, 2, 1**, and then **4**. To correct an error or to change the selection, scan [Cancel on page H-1](#).
- **Length Within Range** - Select this option to decode a MSI symbol with a specific length range. Select lengths using numeric bar codes in [Appendix G, Numeric Bar Codes](#). For example, to decode MSI symbols containing between 4 and 12 characters, first scan **MSI - Length Within Range**. Then scan **0, 4, 1**, and **2** (enter a leading zero for single digit numbers). To correct an error or change the selection, scan [Cancel on page H-1](#).
- **Any Length** - Scan this option to decode MSI symbols containing any number of characters within the digital scanner capability.

✓ **NOTE** Due to the construction of the MSI symbology, it is possible for a scan line covering only a portion of the code to transmit as a complete scan, yielding less data than is encoded in the bar code. To prevent this, select specific lengths (**MSI - One Discrete Length, Two Discrete Lengths**) for MSI applications.

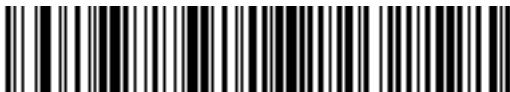

MSI - One Discrete Length



MSI - Two Discrete Lengths

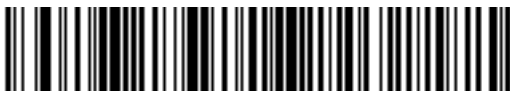

\*MSI - Length Within Range



MSI - Any Length



## MSI Check Digits

### Parameter # 50 (SSI # 32h)

With MSI symbols, one check digit is mandatory and always verified by the reader. The second check digit is optional. If the MSI codes include two check digits, scan the **Two MSI Check Digits** bar code to enable verification of the second check digit.

See [MSI Check Digit Algorithm on page 12-56](#) for the selection of second digit algorithms.

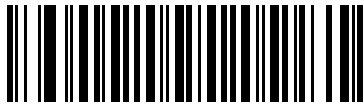

**\*One MSI Check Digit  
(0)**

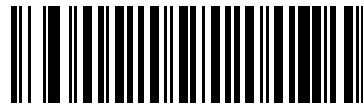

**Two MSI Check Digits  
(1)**

## Transmit MSI Check Digit(s)

### Parameter # 46 (SSI # 2Eh)

Scan a bar code below to transmit MSI data with or without the check digit.

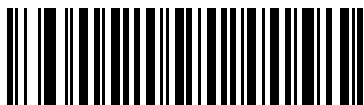

**Transmit MSI Check Digit(s) (Enable)  
(1)**

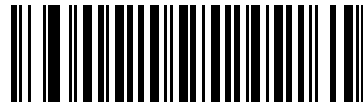

**\*Do Not Transmit MSI Check Digit(s) (Disable)  
(0)**

## MSI Check Digit Algorithm

### Parameter # 51 (SSI # 33h)

Two algorithms are possible for the verification of the second MSI check digit. Select the bar code below corresponding to the algorithm used to encode the check digit.

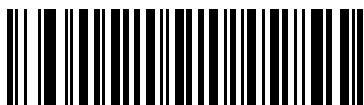

MOD 10/MOD 11  
(0)



\*MOD 10/MOD 10  
(1)

## MSI Reduced Quiet Zone

### Parameter # 1392 (SSI # F8h 05h 70h)

Scan one of the following bar codes to enable or disable decoding MSI bar codes with reduced quiet zones. If enabled select a [1D Quiet Zone Level on page 12-86](#).



\*Disable MSI Reduced Quiet Zone  
(0)



Enable MSI Reduced Quiet Zone  
(1)

---

## Chinese 2 of 5

Enable/Disable Chinese 2 of 5

**Parameter # 408 (SSI # F0h 98h)**

To enable or disable Chinese 2 of 5, scan the appropriate bar code below.



Enable Chinese 2 of 5  
(1)

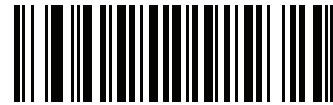

\*Disable Chinese 2 of 5  
(0)

---

## Matrix 2 of 5

Enable/Disable Matrix 2 of 5

**Parameter # 618 (SSI # F1h 6Ah)**

To enable or disable Matrix 2 of 5, scan the appropriate bar code below.



Enable Matrix 2 of 5  
(1)



\*Disable Matrix 2 of 5  
(0)

## Set Lengths for Matrix 2 of 5

### Parameter # L1 = 619 (SSI # F1h 6Bh), L2 = 620 (SSI # F1h 6Ch)

The length of a code refers to the number of characters (i.e., human readable characters), including check digit(s) the code contains. Set lengths for Matrix 2 of 5 to any length, one or two discrete lengths, or lengths within a specific range. The default is **Any Length**.

- **One Discrete Length** - Select this option to decode only Matrix 2 of 5 symbols containing a selected length. Select the length using the numeric bar codes in [Appendix G, Numeric Bar Codes](#). For example, to decode only Matrix 2 of 5 symbols with 14 characters, scan **Matrix 2 of 5 - One Discrete Length**, then scan **1** followed by **4**. To correct an error or to change the selection, scan [Cancel on page H-1](#).
- **Two Discrete Lengths** - Select this option to decode only Matrix 2 of 5 symbols containing either of two selected lengths. Select lengths using the numeric bar codes in [Appendix G, Numeric Bar Codes](#). For example, to decode only Matrix 2 of 5 symbols containing either 2 or 14 characters, select **Matrix 2 of 5 - Two Discrete Lengths**, then scan **0, 2, 1**, and then **4**. To correct an error or to change the selection, scan [Cancel on page H-1](#).
- **Length Within Range** - Select this option to decode a Matrix 2 of 5 symbol with a specific length range. Select lengths using the numeric bar codes in [Appendix G, Numeric Bar Codes](#). For example, to decode Matrix 2 of 5 symbols containing between 4 and 12 characters, first scan **Matrix 2 of 5 - Length Within Range**. Then scan **0, 4, 1**, and **2** (enter a leading zero for single digit numbers). To correct an error or change the selection, scan [Cancel on page H-1](#).
- **Any Length** - Scan this option to decode Matrix 2 of 5 symbols containing any number of characters within the digital scanner capability.



Matrix 2 of 5 - One Discrete Length



Matrix 2 of 5 - Two Discrete Lengths



Matrix 2 of 5 - Length Within Range



\*Matrix 2 of 5 - Any Length

## Matrix 2 of 5 Check Digit

### Parameter # 622 (SSI # F1h 6Eh)

The check digit is the last character of the symbol used to verify the integrity of the data. Scan the appropriate bar code below to transmit the bar code data with or without the Matrix 2 of 5 check digit.



Enable Matrix 2 of 5 Check Digit  
(1)



\*Disable Matrix 2 of 5 Check Digit  
(0)

## Transmit Matrix 2 of 5 Check Digit

### Parameter # 623 (SSI # F1h 6Fh)

Scan a bar code below to transmit Matrix 2 of 5 data with or without the check digit.



Transmit Matrix 2 of 5 Check Digit  
(1)



\*Do Not Transmit Matrix 2 of 5 Check Digit  
(0)

---

## Korean 3 of 5

### Enable/Disable Korean 3 of 5

#### Parameter # 581 (SSI # F1h 45h)

To enable or disable Korean 3 of 5, scan the appropriate bar code below.

✓ **NOTE** The length for Korean 3 of 5 is fixed at 6.

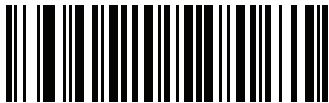

**Enable Korean 3 of 5**  
**(1)**



**\*Disable Korean 3 of 5**  
**(0)**

---

## Inverse 1D

### Parameter # 586 (SSI # F1h 4Ah)

This parameter sets the 1D inverse decoder setting. Options are:

- **Regular Only** - the digital scanner decodes regular 1D bar codes only.
- **Inverse Only** - the digital scanner decodes inverse 1D bar codes only.
- **Inverse Autodetect** - the digital scanner decodes both regular and inverse 1D bar codes.

✓ **NOTE** The Inverse 1D setting may impact Composite or Inverse Composite decoding. See [Composite Inverse on page 12-67](#).



\*Regular  
(0)



Inverse Only  
(1)



Inverse Autodetect  
(2)

---

## GS1 DataBar

The variants of GS1 DataBar are DataBar-14, DataBar Expanded, and DataBar Limited. The limited and expanded versions have stacked variants. Scan the appropriate bar codes to enable or disable each variant of GS1 DataBar.

### GS1 DataBar-14

#### Parameter # 338 (SSI # F0h 52h)

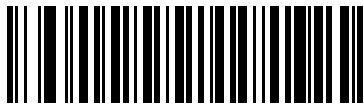

**\*Enable GS1 DataBar-14  
(1)**



**Disable GS1 DataBar-14  
(0)**

### GS1 DataBar Limited

#### Parameter # 339 (SSI # F0h 53h)

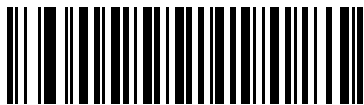

**\*Enable GS1 DataBar Limited  
(1)**



**Disable GS1 DataBar Limited  
(0)**



## GS1 DataBar Expanded

### Parameter # 340 (SSI # F0h 54h)

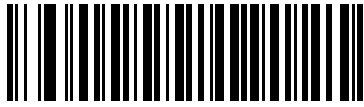

**\*Enable GS1 DataBar Expanded  
(1)**

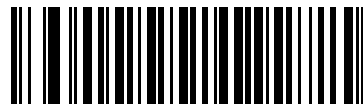

**Disable GS1 DataBar Expanded  
(0)**

## Convert GS1 DataBar to UPC/EAN

### Parameter # 397 (SSI # F0h, 8Dh)

This parameter only applies to GS1 DataBar-14 and GS1 DataBar Limited symbols not decoded as part of a Composite symbol. Enable this to strip the leading '010' from DataBar-14 and DataBar Limited symbols encoding a single zero as the first digit, and report the bar code as EAN-13.

For bar codes beginning with two or more zeros but not six zeros, this parameter strips the leading '0100' and reports the bar code as UPC-A. The UPC-A Preamble parameter that transmits the system character and country code applies to converted bar codes. Note that neither the system character nor the check digit can be stripped.

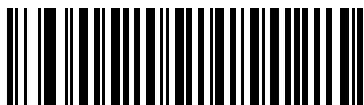

**Enable Convert GS1 DataBar to UPC/EAN  
(1)**

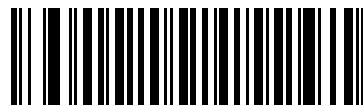

**\*Disable Convert GS1 DataBar to UPC/EAN  
(0)**

## GS1 DataBar Limited Margin Check

### Parameter # 728 (SSI # F1h D8h)

The decoder offers four levels of margin check for GS1 DataBar Limited bar codes. There is an inverse relationship between level of margin check and decoder aggressiveness. Increasing the level of margin check may result in reduced aggressiveness in scanning, so only choose the level of margin check necessary.

- Level 1: No clear margin required. This complies with the original GS1 standard, yet might result in erroneous decoding of the DataBar Limited bar code when scanning some UPC symbols that start with the digits 9 and 7.
- Level 2: Automatic risk detection. This level of security may result in erroneous decoding of DataBar Limited bar codes when scanning some UPC symbols. If a misdecode is detected, the decoder operates in Level 3 or Level 1.
- Level 3: Margin check level reflects newly proposed GS1 standard that requires a 5x trailing clear margin.
- Level 4: Margin check level extends beyond the standard required by GS1. This level of security requires a 5x leading and trailing clear margin.



**GS1 DataBar Limited Margin Check Level 1**  
(1)



**GS1 DataBar Limited Margin Check Level 2**  
(2)



**\*GS1 DataBar Limited Margin Check Level 3**  
(3)



**GS1 DataBar Limited Margin Check Level 4**  
(4)

## GS1 DataBar Security Level

### Parameter # 1706 (SSI # F8h 06h AAh)

The decoder offers four levels of decode security for GS1 Databar (GS1 Databar 14, GS1 Databar Limited, GS1 Databar Expanded) bar codes.

- Security Level 0: This setting allows the digital scanner to operate in its most aggressive state, while providing sufficient security in decoding most in-spec bar codes.
- Security Level 1: This setting eliminates most misdecodes while maintaining reasonable aggressiveness (default).
- Security Level 2: This setting allows greater bar code security requirements if Security Level 1 fails to eliminate misdecodes.
- Security Level 3: This setting applies the highest safety requirements. Select if Security Level 2 was applied and misdecodes still occur.



**Security Level 0  
(0)**



**\* Security Level 1  
(1)**



**Security Level 2  
(2)**

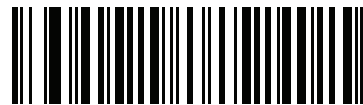

**Security Level 3  
(3)**

---

## Composite

### Composite CC-C

#### Parameter # 341 (SSI # F0h 55h)

Scan a bar code below to enable or disable Composite bar codes of type CC-C.

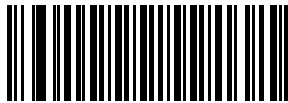

Enable CC-C  
(1)



\*Disable CC-C  
(0)

### Composite CC-A/B

#### Parameter # 342 (SSI # F0h 56h)

Scan a bar code below to enable or disable Composite bar codes of type CC-A/B.



Enable CC-A/B  
(1)



\*Disable CC-A/B  
(0)

## Composite TLC-39

### Parameter # 371 (SSI # F0h 73h)

Scan a bar code below to enable or disable Composite bar codes of type TLC-39.



Enable TLC39  
(1)

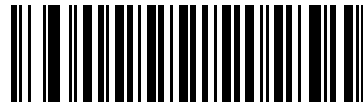

\*Disable TLC39  
(0)

## Composite Inverse

### Parameter # 1113 (SSI # F8h 04h 59h)

This parameter sets Composite for either regular decode or inverse decode.

- **Regular Only:** The digital scanner decodes regular Composite bar codes only. (default).
- **Inverse Only:** The digital scanner decodes inverse Composite bar codes only. This mode only supports Inverse Composite that has Databar combined with CCAB. No other 1D/2D combinations. For this parameter to work as expected, [Composite CC-A/B on page 12-66](#) and corresponding 1D Inverse or 1D Inverse Autodetect ( [page 12-61](#)) and Databar must be enabled.



To decode regular Composite, Inverse Composite must be set to Regular Only and Inverse 1D must be set to **Regular Only** or **Autodetect**.

To decode inverse Composite, Inverse Composite must be set to Inverse Only and Inverse 1D must be set to **Inverse Only** or **Autodetect**.

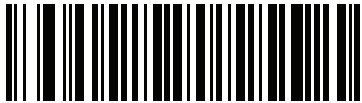

\* Regular Only  
(0)



Inverse Only  
(1)

## UPC Composite Mode

### Parameter # 344 (SSI # F0h 58h)

Select an option for linking UPC symbols with a 2D symbol during transmission as if they were one symbol:

- Select **UPC Never Linked** to transmit UPC bar codes regardless of whether a 2D symbol is detected.
- Select **UPC Always Linked** to transmit UPC bar codes and the 2D portion. If 2D is not present, the UPC bar code does not transmit.
- If you select **Autodiscriminate UPC Composites**, the digital scanner determines if there is a 2D portion, then transmits the UPC, as well as the 2D portion if present.



\*UPC Never Linked  
(0)

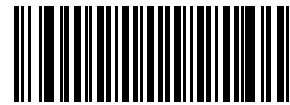

UPC Always Linked  
(1)



Autodiscriminate UPC Composites  
(2)

## Composite Beep Mode

### Parameter # 398 (SSI # F0h, 8Eh)

To select the number of decode beeps when a composite bar code is decoded, scan the appropriate bar code.

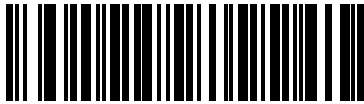

Single Beep after both are decoded  
(0)



\*Beep as each code type is decoded  
(1)

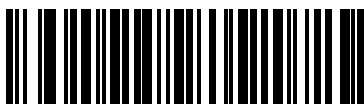

Double Beep after both are decoded  
(2)

## GS1-128 Emulation Mode for UCC/EAN Composite Codes

### Parameter # 427 (SSI # F0h, ABh)

Select whether to enable or disable this mode.



Enable GS1-128 Emulation Mode for  
UCC/EAN Composite Codes  
(1)



\*Disable GS1-128 Emulation Mode for  
UCC/EAN Composite Codes  
(0)

---

## 2D Symbologies

### Enable/Disable PDF417

### Parameter # 15 (SSI # 0Fh)

To enable or disable PDF417, scan the appropriate bar code below.



\*Enable PDF417  
(1)



Disable PDF417  
(0)

## Enable/Disable MicroPDF417

### Parameter # 227 (SSI # E3h)

To enable or disable MicroPDF417, scan the appropriate bar code below.



Enable MicroPDF417  
(1)



\*Disable MicroPDF417  
(0)

## Code 128 Emulation

### Parameter # 123 (SSI # 7Bh)

Enable this parameter to transmit data from certain MicroPDF417 symbols as Code 128. [AIM Code ID Character on page 5-37](#) must be enabled for this parameter to work.

Enable Code 128 Emulation to transmit these MicroPDF417 symbols with one of the following prefixes:

- ]C1 if the first codeword is 903-905
- ]C2 if the first codeword is 908 or 909
- ]C0 if the first codeword is 910 or 911

Disable Code 128 Emulation to transmit these MicroPDF417 symbols with one of the following prefixes:

- ]L3 if the first codeword is 903-905
- ]L4 if the first codeword is 908 or 909
- ]L5 if the first codeword is 910 or 911

Scan a bar code below to enable or disable Code 128 Emulation.



**NOTE** Linked MicroPDF codewords 906, 907, 912, 914, and 915 are not supported. Use GS1 Composites instead.



Enable Code 128 Emulation  
(1)



\*Disable Code 128 Emulation  
(0)



## Data Matrix

### Parameter # 292 (SSI # F0h, 24h)

To enable or disable Data Matrix, scan the appropriate bar code below.



**\*Enable Data Matrix  
(1)**



**Disable Data Matrix  
(0)**

## GS1 Data Matrix

### Parameter # 1336 (SSI # F8h 05h 38h)

To enable or disable GS1 Data Matrix, scan the appropriate bar code below.

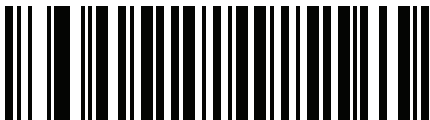

**\*Disable GS1 Data Matrix  
(0)**

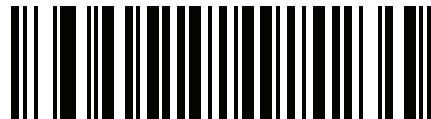

**Enable GS1 Data Matrix  
(1)**

## Data Matrix Inverse

### Parameter # 588 (SSI # F1h 4Ch)

This parameter sets the Data Matrix inverse decoder setting. Options are:

- **Regular Only** - the digital scanner decodes regular Data Matrix bar codes only.
- **Inverse Only** - the digital scanner decodes inverse Data Matrix bar codes only.
- **Inverse Autodetect** - the digital scanner decodes both regular and inverse Data Matrix bar codes.



Regular  
(0)



Inverse Only  
(1)



\*Inverse Autodetect  
(2)

## Maxicode

### Parameter # 294 (SSI # F0h, 26h)

To enable or disable Maxicode, scan the appropriate bar code below.



Enable Maxicode  
(1)



\*Disable Maxicode  
(0)

## QR Code

### Parameter # 293 (SSI # F0h, 25h)

✓ **NOTE** Inverse QR bar codes decode if **QR Code** is enabled.

To enable or disable QR Code, scan the appropriate bar code below.



**\*Enable QR Code**  
(1)



**Disable QR Code**  
(0)

## GS1 QR

### Parameter # 1343 (SSI # F8h 05h 3Fh)

To enable or disable GS1 QR, scan the appropriate bar code below.



**\*Disable GS1 QR**  
(0)



**Enable GS1 QR**  
(1)

## MicroQR

### Parameter # 573 (SSI # F1h 3Dh)

To enable or disable MicroQR, scan the appropriate bar code below.



**\*Enable MicroQR  
(1)**



**Disable MicroQR  
(0)**

## Aztec

### Parameter # 574 (SSI # F1h 3Eh)

To enable or disable Aztec, scan the appropriate bar code below.



**\*Enable Aztec  
(1)**



**Disable Aztec  
(0)**

## Aztec Inverse

### Parameter # 589 (SSI # F1h 4Dh)

This parameter sets the Aztec inverse decoder setting. Options are:

- **Regular Only** - the digital scanner decodes regular Aztec bar codes only.
- **Inverse Only** - the digital scanner decodes inverse Aztec bar codes only.
- **Inverse Autodetect** - the digital scanner decodes both regular and inverse Aztec bar codes.



Regular  
(0)



Inverse Only  
(1)



\*Inverse Autodetect  
(2)

## Han Xin

### Parameter # 1167 (SSI # F8h 04h 8Fh)

To enable or disable Han Xin, scan the appropriate bar code below.



Enable Han Xin  
(1)



\*Disable Han Xin  
(0)

## Han Xin Inverse

### Parameter # 1168 (SSI # F8h 04h 90h)

Select a Han Xin inverse decoder setting:

- **Regular Only** - the decoder decodes Han Xin bar codes with normal reflectance only.
- **Inverse Only** - the decoder decodes Han Xin bar codes with inverse reflectance only.
- **Inverse Autodetect** - the decoder decodes both regular and inverse Han Xin bar codes.



\*Regular  
(0)



Inverse Only  
(1)



Inverse Autodetect  
(2)

---

## Postal Codes

### US Postnet

#### Parameter # 89 (SSI # 59h)

To enable or disable US Postnet, scan the appropriate bar code below.



Enable US Postnet  
(1)



\*Disable US Postnet  
(0)

## US Planet

### Parameter # 90 (SSI # 5Ah)

To enable or disable US Planet, scan the appropriate bar code below.



Enable US Planet  
(1)



\*Disable US Planet  
(0)

## Transmit US Postal Check Digit

### Parameter # 95 (SSI # 5Fh)

Select whether to transmit US Postal data, which includes both US Postnet and US Planet, with or without the check digit.

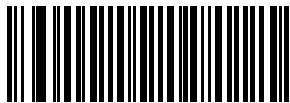

\*Transmit US Postal Check Digit  
(1)



Do Not Transmit US Postal Check Digit  
(0)

## UK Postal

### Parameter # 91 (SSI # 5Bh)

To enable or disable UK Postal, scan the appropriate bar code below.



**Enable UK Postal  
(1)**



**\*Disable UK Postal  
(0)**

## Transmit UK Postal Check Digit

### Parameter # 96 (SSI # 60h)

Select whether to transmit UK Postal data with or without the check digit.



**\*Transmit UK Postal  
Check Digit  
(1)**



**Do Not Transmit UK Postal Check Digit  
(0)**



## Japan Postal

### Parameter # 290 (SSI # F0h, 22h)

To enable or disable Japan Postal, scan the appropriate bar code below.



Enable Japan Postal  
(1)



\*Disable Japan Postal  
(0)

## Australia Post

### Parameter # 291 (SSI # F0h, 23h)

To enable or disable Australia Post, scan the appropriate bar code below.



Enable Australia Post  
(1)



\*Disable Australia Post  
(0)

## Australia Post Format

### Parameter # 718 (SSI # F1h, CEh)

To select one of the following formats for Australia Post, scan the appropriate bar code below:

- **Autodiscriminate** (or Smart mode) - Attempt to decode the Customer Information Field using the N and C Encoding Tables.

✓ **NOTE** This option increases the risk of misdecodes because the encoded data format does not specify the Encoding Table used for encoding.

- **Raw Format** - Output raw bar patterns as a series of numbers 0 through 3.
- **Alphanumeric Encoding** - Decode the Customer Information Field using the C Encoding Table.
- **Numeric Encoding** - Decode the Customer Information Field using the N Encoding Table.

For more information on Australia Post Encoding Tables, refer to the *Australia Post Customer Barcoding Technical Specifications* available at <http://www.auspost.com.au>.



\* Autodiscriminate  
(0)



Raw Format  
(1)



Alphanumeric Encoding  
(2)



Numeric Encoding  
(3)

## Netherlands KIX Code

### Parameter # 326 (SSI # F0h, 46h)

To enable or disable Netherlands KIX Code, scan the appropriate bar code below.



**Enable Netherlands KIX Code**  
(1)



**\*Disable Netherlands KIX Code**  
(0)

## USPS 4CB/One Code/Intelligent Mail

### Parameter # 592 (SSI # F1h 50h)

To enable or disable USPS 4CB/One Code/Intelligent Mail, scan the appropriate bar code below.



**Enable USPS 4CB/One Code/Intelligent Mail**  
(1)



**\*Disable USPS 4CB/One Code/Intelligent Mail**  
(0)

## UPU FICS Postal

### Parameter # 611 (SSI # F1h 63h)

To enable or disable UPU FICS Postal, scan the appropriate bar code below.



Enable UPU FICS Postal  
(1)



\*Disable UPU FICS Postal  
(0)

## Mailmark

### Parameter # 1337 (SSI # F8h 05h 39h)

To enable or disable Mailmark, scan the appropriate bar code below.

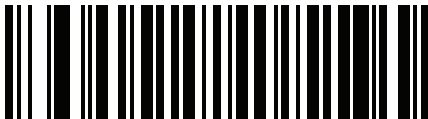

\*Disable Mailmark  
(0)



Enable Mailmark  
(1)

## Symbology-Specific Security Levels

### Redundancy Level

#### Parameter # 78 (SSI # 4Eh)

The digital scanner offers four levels of decode redundancy. Select higher redundancy levels for decreasing levels of bar code quality. As redundancy levels increase, the digital scanner aggressiveness decreases.

Select the redundancy level appropriate for the bar code quality.

#### Redundancy Level 1

The following code types must be successfully read twice before being decoded:

**Table 12-2** *Redundancy Level 1 Codes*

Code Type	Code Length
Codabar	8 characters or less
MSI	4 characters or less
D 2 of 5	8 characters or less
I 2 of 5	8 characters or less

#### Redundancy Level 2

The following code types must be successfully read twice before being decoded:

**Table 12-3** *Redundancy Level 2 Codes*

Code Type	Code Length
All	All

#### Redundancy Level 3

Code types other than the following must be successfully read twice before being decoded. The following codes must be read three times:

**Table 12-4** *Redundancy Level 3 Codes*

Code Type	Code Length
MSI	4 characters or less
D 2 of 5	8 characters or less
I 2 of 5	8 characters or less
Codabar	8 characters or less

### Redundancy Level 4

The following code types must be successfully read three times before being decoded:

**Table 12-5** *Redundancy Level 4 Codes*

Code Type	Code Length
All	All

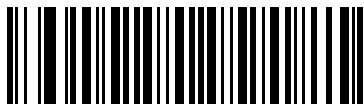

\*Redundancy Level 1  
(1)

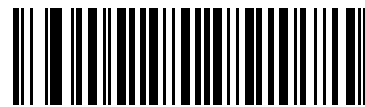

Redundancy Level 2  
(2)



Redundancy Level 3  
(3)

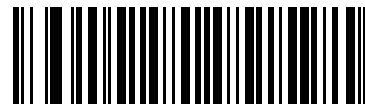

Redundancy Level 4  
(4)

## Security Level

### Parameter # 77 (SSI # 4Dh)

The digital scanner offers four levels of decode security for delta bar codes, which include the Code 128 family, UPC/EAN, and Code 93. Select increasing levels of security for decreasing levels of bar code quality. There is an inverse relationship between security and digital scanner aggressiveness, so choose only that level of security necessary for any given application.

- **Security Level 0:** This setting allows the digital scanner to operate in its most aggressive state, while providing sufficient security in decoding most “in-spec” bar codes.
- **Security Level 1:** This default setting eliminates most misdecodes.
- **Security Level 2:** Select this option if Security level 1 fails to eliminate misdecodes.
- **Security Level 3:** If you selected Security Level 2 and misdecodes still occur, select this security level. Be advised, selecting this option is an extreme measure against mis-decoding severely out of spec bar codes. Selecting this level of security significantly impairs the decoding ability of the digital scanner. If you need this level of security, try to improve the quality of the bar codes.

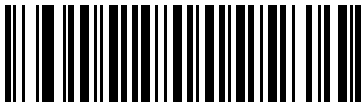

Security Level 0  
(0)



\*Security Level 1  
(1)

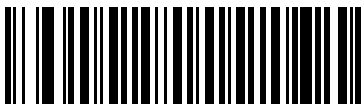

Security Level 2  
(2)



Security Level 3  
(3)

## 1D Quiet Zone Level

### Parameter # 1288 (SSI # F8h 05h 08h)

This feature sets the level of aggressiveness in decoding bar codes with a reduced quiet zone (the area in front of and at the end of a bar code), and applies to symbologies enabled by a Reduced Quiet Zone parameter. Because higher levels increase the decoding time and risk of misdecodes, Symbol Technologies strongly recommends enabling only the symbologies which require higher quiet zone levels, and leaving Reduced Quiet Zone disabled for all other symbologies. Options are:

- 0 - The digital scanner performs normally in terms of quiet zone.
- 1 - The digital scanner performs more aggressively in terms of quiet zone.
- 2 - The digital scanner only requires one side EB (end of bar code) for decoding.
- 3 - The digital scanner decodes anything in terms of quiet zone or end of bar code.

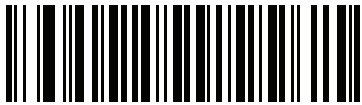

1D Quiet Zone Level 0  
(0)

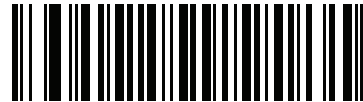

\*1D Quiet Zone Level 1  
(1)

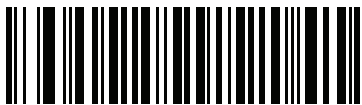

1D Quiet Zone Level 2  
(2)



1D Quiet Zone Level 3  
(3)



## Intercharacter Gap Size

### Parameter # 381 (SSI # F0h, 7Dh)

The Code 39 and Codabar symbologies have an intercharacter gap that is typically quite small. Due to various bar code-printing technologies, this gap can grow larger than the maximum size allowed, preventing the digital scanner from decoding the symbol. If this problem occurs, scan the **Large Intercharacter Gaps** parameter to tolerate these out-of-specification bar codes.



\*Normal Intercharacter Gaps  
(06h)



Large Intercharacter Gaps  
(0Ah)

---

## Report Version

Scan the bar code below to report the version of software installed in the digital scanner.



Report Software Version

---

## Macro PDF Features

Macro PDF is a special feature for concatenating multiple PDF symbols into one file. The digital scanner can decode symbols that are encoded with this feature, and can store more than 64 Kb of decoded data stored in up to 50 MacroPDF symbols.



**CAUTION** When printing, keep each Macro PDF sequence separate, as each sequence has unique identifiers. Do not mix bar codes from several Macro PDF sequences, even if they encode the same data. When scanning Macro PDF sequences, scan the entire Macro PDF sequence without interruption. If, when scanning a mixed sequence, the digital scanner emits two long low beeps (Low/Low) this indicates an inconsistent file ID or inconsistent symbology error.

### Flush Macro Buffer

This flushes the buffer of all decoded Macro PDF data stored to that point, transmits it to the host device, and aborts from Macro PDF mode.



**Flush Macro PDF Buffer**

### Abort Macro PDF Entry

This clears all currently-stored Macro PDF data in the buffer without transmission and aborts from Macro PDF mode.



**Abort Macro PDF Entry**

# CHAPTER 13 INTELLIGENT DOCUMENT CAPTURE

---

## Introduction

Intelligent Document Capture (IDC) is Zebra advanced image processing firmware for select imager based decoders. This chapter describes the IDC functionality, provides parameter bar codes to control its features, and includes a quick start procedure to get you started with IDC.

---

## The IDC Process

Intelligent Document Capture:

1. Verifies a bar code is appropriate to use as an IDC anchor or link. See [Bar Code Acceptance Test](#).
2. Determines the rectangular region to capture as an image. See [Capture Region Determination on page 13-2](#).
3. Processes the captured image. See [Image Post Processing on page 13-3](#).
4. Transmits the data. See [Data Transmission on page 13-3](#).

## Bar Code Acceptance Test

Upon decoding a bar code, the decoder checks to ensure that the bar code fits the description of a bar code that anchors or links to an IDC form. To be accepted as an IDC bar code:

- The symbology must be enabled in the IDC symbology parameter and enabled for decode in the decoder. The IDC firmware allows enabling between zero and eight symbologies simultaneously: Code 128, Code 39, Interleaved 2 of 5, Discrete 2 of 5, Codabar, PDF417, Data Matrix, and EAN-128.
- The decoded data must satisfy the values set in the *IDC Minimum Text Length* and *IDC Maximum Text Length* parameters. To disable either of these checks, set the value to zero.

If the bar code does not satisfy both requirements, it is sent as a normal (non-IDC) decode.

An IDC bar code is required when *IDC Operating Mode on page 13-5* is set to **Anchored** or **Linked**.

**Free-Form** operating mode does not require a bar code, but transmits decoded data if one is found and satisfies the requirements. If no bar code is decoded, the document capture process starts but can be subject to the following condition: specify a non-zero value for the *IDC Delay Time on page 13-15*. The decoder must wait for at least this amount of time after trigger pull before capturing a document, unless a bar code is decoded before the time expires.

If *Picklist Mode on page 5-24* is enabled, the bar code must be directly under the aiming pattern, within the decoder decode range, and the region to capture completely within the engine's field-of-view.

## Capture Region Determination

After accepting an IDC bar code, the firmware establishes the region to capture as an image. The method used depends on the setting of the *IDC Operating Mode* as follows.

The IDC firmware emits a single low beep after successfully capturing a region. The engine is then no longer capturing images and can be moved without disturbing the IDC output. Be sure to hold the trigger button until the decode beep, otherwise the IDC process may be aborted.

### IDC Operating Mode = Anchored

A coordinate system is built based on the bar code in its rectified (de-skewed) form. The origin is the center of the bar code, and the x-axis is set toward the right, from the bar code's point of view. The unit module width of the bar code is the unit for x. Similarly, the y-axis is set toward the up direction. The unit for the y-axis is specified via the parameter *IDC Aspect on page 13-9*. This is the aspect ratio of a thin bar or space - the bar code's height is divided by this value to get the unit in the y-axis. The aspect ratio is calculated automatically if *IDC Aspect* is set to zero. The bar code can be of different sizes for the same form, as long as the center of the bar code is the same when the bar code's length changes.

From this coordinate system, the IDC area is determined using four parameters: offsets in x and y (*IDC X Coordinate*, *IDC Y Coordinate*) to the region's top-left corner, and width and height (*IDC Width*, *IDC Height*).

If the capture area is relatively large as compared to the bar code area, the calculation to obtain the capture area is prone to significant errors. A recommended solution is to enclose the form with a single black-lined rectangular border (a box), which is not in contact with any other line on the outside of the form (although it can be connected to lines on the inside of the form). When the *IDC Find Box Outline* is set, the firmware searches for the box, and does not decode if any edges are broken (such as by a protruding thumb).

The *IDC Zoom Limit* parameter controls the quality of the captured form. The IDC firmware rejects capturing a form unless the width is at least the *IDC Zoom Limit* percentage of the *IDC Width* parameter. For example, if *IDC Zoom Limit* is set to 100 and *IDC Width* is set to 150, the form must be at least 300 pixels wide before it is captured (each unit module is scaled to two pixels).

The *IDC Maximum Rotation* parameter controls the maximum rotation any edge of the form can have in relation to the scanner's horizontal or vertical axis.

## IDC Operating Mode = Free-Form or Linked

The document capture region is a rectangular piece of paper, or a portion of it enclosed by a rectangular border. In either case, all four sides of the capture region must be completely within the engine's field-of-view, and there must be sufficient contrast at the border of the capture region. For example, if a piece of white paper contains the document to capture, it must be put in front of a dark background.

By default, the engine captures the largest rectangular region within the field-of-view. To specify a particular border type, use the *IDC Border Type* parameter.

The region must contain at least 10% of the field-of-view in two dimensions.

If an IDC bar code is decoded, its location is used to start the search for the capture region. Otherwise, the capture region is searched from the center of the field-of-view. IDC also uses the orientation of a decoded IDC bar code to orient the output image.

## Image Post Processing

After determining the document capture region, the firmware de-skews and re-samples the region as described below. Enabling *IDC Captured Image Brighten* calls normalization, where the brightness of the image is made uniform, and contrast is enhanced as a large percent of background pixels is made completely white (a smaller percent of pixels is made completely black if the firmware determines there is no danger of enhancing the contrast of a very bland area). Enabling *IDC Captured Image Sharpen* enhances the sharpness of the image.

The image is re-sampled about one output pixel per input pixel for **Free-Form** or **Linked** modes and two pixels-per-module in **Anchored** mode.

The image is compressed and transmitted in one of the standard image formats selected by the *IDC File Format Selector*, *IDC Bits Per Pixel*, and *IDC JPEG Quality* parameters.

Note that it may take several seconds for post processing to complete, depending on the size of the captured region, the options enabled, and the decoder model.

## Data Transmission

After processing the captured image, it is assembled with the decoded bar code data (if applicable) into an ISO/IEC 15434 style packet and transmitted to the host. The decoder issues the standard decode beep and the trigger can be released. Be sure the *USB Device Type on page 7-4* is set to **Symbol Native API (SNAPI) with Imaging Interface**.

---

## PC Application and Programming Support

For a sample application running on the Microsoft Windows operating system, contact your Zebra representative. This application displays bar code data and/or captured images from Intelligent Document Capture enabled decoders and allows setting and reading IDC parameters. Complete source code and documentation are also provided for developing custom applications. The application includes documentation for the ISO/IEC 15434 format as used by the IDC firmware and C# code to process it.

## Parameters

This section describes the parameters controlling the IDC firmware and provides programming bar codes for setting them.

To set parameters requiring a range of values, scan the parameter bar code followed by two, three, or four bar codes from [Appendix G, Numeric Bar Codes](#) corresponding to the desired value. Scan two numeric bar codes for parameters with a maximum value of less than 100, for example, [IDC Minimum Text Length](#). [IDC Delay Time](#) requires scanning three digits since the maximum value is 200. Leading zeros are required.

Alternatively, use the sample application to set parameters using the parameter name. The application provides prompts and error checking to assist in setting the parameters correctly and easily. You must use an application to set a parameter to a negative value, as the [IDC X Coordinate](#) can require.

**Table 13-1** *Intelligent Document Capture (IDC) Parameter Defaults*

Parameter	Parameter Name	Parameter Number	SSI Number	Default	Page Number
<b>Intelligent Document Capture (IDC)</b>					
IDC Operating Mode	DocCap_MODE	594	F1h 52h	Off	<a href="#">13-5</a>
IDC Symbology	DocCap_SYMBOLOGY	655	F1h 8Fh	001	<a href="#">13-6</a>
IDC X Coordinate	DocCap_X	596	F4h F1h 54h	-151	<a href="#">13-7</a>
IDC Y Coordinate	DocCap_Y	597	F4h F1h 55h	-050	<a href="#">13-7</a>
IDC Width	DocCap_WIDTH	598	F1h 56h	0300	<a href="#">13-8</a>
IDC Height	DocCap_HEIGHT	599	F1h 57h	0050	<a href="#">13-8</a>
IDC Aspect	DocCap_ASPECT	595	F1h 53h	000	<a href="#">13-9</a>
IDC File Format Selector	DocCap_FMT	601	F1h 59h	JPEG	<a href="#">13-9</a>
IDC Bits Per Pixel	DocCap_BPP	602	F1h 5Ah	8 BPP	<a href="#">13-10</a>
IDC JPEG Quality	DocCap_JPEG_Qual	603	F1h 5Bh	065	<a href="#">13-10</a>
IDC Find Box Outline	Sig_FINDBOX	727	F1h D7h	Disable	<a href="#">13-11</a>
IDC Minimum Text Length	DocCap_MIN_TEXT	656	F1h 90h	00	<a href="#">13-11</a>
IDC Maximum Text Length	DocCap_MAX_TEXT	657	F1h 91h	00	<a href="#">13-12</a>
IDC Captured Image Brighten	Sig_BRIGHTEN	654	F1h 8Eh	Enable	<a href="#">13-12</a>
IDC Captured Image Sharpen	Sig_SHARPEN	658	F1h 92h	Enable	<a href="#">13-13</a>
IDC Border Type	DocCap_BORDER	829	F2h 3Dh	None	<a href="#">13-14</a>
IDC Delay Time	DocCap_DELAY	830	F2h 3Eh	000	<a href="#">13-15</a>
IDC Zoom Limit	Sig_MIN_PERCENT	651	F1h 8Bh	000	<a href="#">13-15</a>
IDC Maximum Rotation	Sig_MAX_ROT	652	F1h 8Ch	00	<a href="#">13-16</a>

## IDC Operating Mode

**Parameter Name: DocCap\_MODE**

**Parameter # 594 (SSI # F1h 52h)**

Select the operating mode of the Intelligent Document Capture firmware:

- **Off** - Disables the IDC feature.
- **Anchored** - Requires a bar code decode. The image capture region is based off this bar code.
- **Free-Form** - A printed border or page edge defines the image capture region. A bar code is optional.
- **Linked** - A printed border or page edge defines the image capture region. A bar code is required.

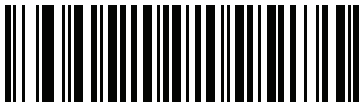

\*Off  
(0)

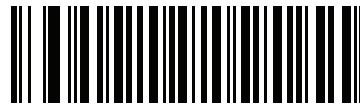

Anchored  
(1)

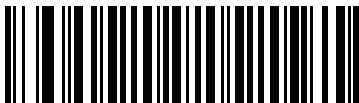

Free-Form  
(2)



Linked  
(3)

## IDC Symbology

### Parameter Name: DocCap\_SYMBOLOGY

#### Parameter # 655 (SSI # F1h 8Fh)

Select the bar code type(s) to use when Document Capture mode is not set to **Off**. To enable more than one symbology at a time, simply add the values together. For example, to enable PDF417, Data Matrix, and Code 39 write a value of 98 (32 + 64 + 2).

Scan the bar code below, followed by three bar codes from [Appendix G, Numeric Bar Codes](#) in the range of 000 to 255 decimal. The default is 001.

**Table 13-2** *IDC Symbologies*

Symbology	Value (Decimal)
Code 128	1
Code 39	2
I 2 of 5	4
D 2 of 5	8
Codabar	16
PD 417	32
Data Matrix	64
EAN 128	128



**IDC Symbology**



## IDC X Coordinate

**Parameter Name: DocCap\_X**

**Parameter # 596 (SSI # F4h F1h 54h)**

Specify the horizontal offset to the top left corner of the region to capture relative to the center of the bar code. Negative values move toward the left. This parameter only applies when *IDC Operating Mode* is set to **Anchored**.

Scan the bar code below, followed by four bar codes from *Appendix G, Numeric Bar Codes* in the range of +/- 1279. The default is -151. Note that you must use an application to set a negative value.

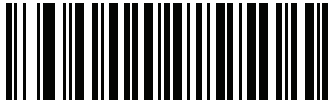

IDC X Coordinate

## IDC Y Coordinate

**Parameter Name: DocCap\_Y**

**Parameter # 597 (SSI # F4h F1h 55h)**

Specify the vertical offset to the top left corner of the region to capture relative to the center of the bar code. Negative values move toward the top. This parameter only applies when *IDC Operating Mode* is set to **Anchored**.

Scan the bar code below, followed by four bar codes from *Appendix G, Numeric Bar Codes* in the range of +/- 1023. The default is -050. Note that you must use an application to set a negative value.



IDC Y Coordinate

## IDC Width

**Parameter Name: DocCap\_WIDTH**

**Parameter # 598 (SSI # F1h 56h)**

Specify the width of the region to capture. This parameter only applies when *IDC Operating Mode* is set to **Anchored**.

Scan the bar code below, followed by four bar codes from *Appendix G, Numeric Bar Codes* in the range of 0000 to 1279. The default is 0300.

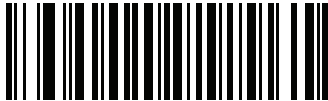

IDC Width

## IDC Height

**Parameter Name: DocCap\_HEIGHT**

**Parameter # 599 (SSI # F1h 57h)**

Specify the height of the region to capture. This parameter only applies when *IDC Operating Mode* is set to **Anchored**.

Scan the bar code below, followed by four bar codes from *Appendix G, Numeric Bar Codes* in the range of 0000 to 1279. The default is 0050.



IDC Height

### IDC Aspect

**Parameter Name: DocCap\_ASPECT**

**Parameter # 595 (SSI # F1h 53h)**

Specify the bar code's aspect ratio of a thin bar or space. The bar code's height is divided by this value to get the unit in the y-axis. The aspect value is calculated automatically if this parameter is set to zero.

This parameter only applies when *IDC Operating Mode* is set to **Anchored**.

Scan the bar code below, followed by three bar codes from *Appendix G, Numeric Bar Codes* in the range of 000 to 255. The default is 000.



IDC Aspect

### IDC File Format Selector

**Parameter Name: DocCap\_FMT**

**Parameter # 601 (SSI # F1h 59h)**

Select a document capture file format appropriate for your system (BMP, TIFF, or JPEG). The decoder stores captured areas in the selected format.



\*JPEG  
(1)



BMP  
(3)

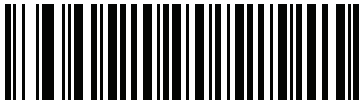

TIFF  
(4)

## IDC Bits Per Pixel

**Parameter Name: DocCap\_BPP**

**Parameter # 602 (SSI # F1h 5Ah)**

Select the number of significant bits per pixel (BPP) to use when capturing an image. Select 1 BPP for a black and white image, 4 BPP to assign 1 of 16 gray levels to each pixel, or 8 BPP to assign 1 of 256 levels of gray to each pixel.

✓ **NOTE** The decoder ignores these settings for JPEG file formats, which only support 8 BPP.



1 BPP  
(0)



4 BPP  
(1)



\*8 BPP  
(2)

## IDC JPEG Quality

**Parameter Name: DocCap\_JPEG\_Qual**

**Parameter # 603 (SSI # F1h 5Bh)**

Set the amount of JPEG compression to perform on the captured image. Higher numbers produce a better quality image but larger files.

Scan the bar code below, followed by three bar codes from [Appendix G, Numeric Bar Codes](#) in the range of 005 to 100 decimal. The default is 065.



IDC JPEG Quality

## IDC Find Box Outline

**Parameter Name: Sig\_FINDBOX**

**Parameter # 727 (SSI # F1h D7h)**

Select **Enable Find Box Outline** to instruct the firmware to search for a rectangular border during document capture. This parameter only applies when *IDC Operating Mode* is set to **Anchored**.



\*Disable Find Box Outline  
(0)

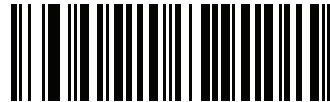

Enable Find Box Outline  
(1)

## IDC Minimum Text Length

**Parameter Name: DocCap\_MIN\_TEXT**

**Parameter # 656 (SSI # F1h 90h)**

Specify the minimum number of characters encoded in a bar code for the IDC firmware to use it as an anchored or linked bar code. Set this to zero (the default) to disable all checking and use all bar codes.

Scan the bar code below, followed by two bar codes from [Appendix G, Numeric Bar Codes](#) in the range of 00 to 55 decimal. The default is 00.



IDC Minimum Text Length

## IDC Maximum Text Length

**Parameter Name: DocCap\_MAX\_TEXT**

**Parameter # 657 (SSI # F1h 91h)**

Specify the maximum number of characters encoded in a bar code for the IDC firmware to use it as an anchored or linked bar code. Set this to zero (the default) to disable all checking and use all bar codes.

Scan the bar code below, followed by two bar codes from [Appendix G, Numeric Bar Codes](#) in the range of 00 to 55 decimal. The default is 00.



IDC Maximum Text Length

## IDC Captured Image Brighten

**Parameter Name: Sig\_BRIGHTEN**

**Parameter # 654 (SSI # F1h 8Eh)**

Enable **Captured Image Brighten** to make image brightness uniform and enhance contrast such that a large percent of the background pixels is made completely white (a smaller percentage of pixels is made completely black if the program determines there is no danger of enhancing the contrast of a very bland area).

✓ **NOTE** This parameter is also used for Signature Capture.



Disable Captured Image Brighten  
(0)



\*Enable Captured Image Brighten  
(1)

## IDC Captured Image Sharpen

**Parameter Name: Sig\_SHARPEN**

**Parameter # 658 (SSI # F1h 92h)**

Enable this to enhance the sharpness of the image.



**NOTE** This parameter is also used for Signature Capture.



**Disable Captured Image Sharpen  
(0)**



**\*Enable Captured Image Sharpen  
(1)**

## IDC Border Type

Parameter Name: DocCap\_BORDER

Parameter # 829 (SSI # F2h 3Dh)

Select the style of border used to determine the outline of the capture region in **Free-Form** and **Linked** modes:

- Select **None** to capture the largest rectangular region within the field-of-view.
- Select **Black** to indicate that the border must be black (such as a printed rectangular border).
- Select **White** to indicate that the border must be white (e.g., paper edge on a dark background).
- Select **Advanced Edge Detection (AED)** to capture a region defined by edges of any color and potentially broken.

This parameter is only used in **Free-Form** and **Linked** modes.



\*None  
(0)



Black  
(1)



White  
(2)



Advanced Edge Detection (AED)  
(3)



## IDC Delay Time

**Parameter Name: DocCap\_DELAY**

**Parameter # 830 (SSI # F2h 3Eh)**

Set the delay for capturing a document after a trigger pull. Decoding a bar code aborts this delay. This parameter only applies in **Free-Form** mode.

Scan the bar code below, followed by three bar codes from [Appendix G, Numeric Bar Codes](#) in the range of 000 to 200 decimal in units of 10 msec. The default is 000.

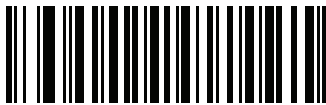

IDC Delay Time

## IDC Zoom Limit

**Parameter Name: Sig\_MIN\_PERCENT**

**Parameter # 651 (SSI # F1h 8Bh)**

Set the minimal "zoom" percentage value of a form for it to be considered for capture. This controls the quality of the captured form. The IDC firmware rejects capturing a form unless the width is at least the *IDC Zoom Limit* percentage of the *IDC Width* parameter. For example, if you set this parameter to 100 and *IDC Width* to 150, the form must be at least 300 pixels wide before it is captured (each unit module is scaled to two pixels).

Set this to zero (the default) to disable all checking. This parameter only applies in **Anchored** mode.

Scan the bar code below, followed by three bar codes from [Appendix G, Numeric Bar Codes](#) in the range of 000 to 100 percent. The default is 000.



IDC Zoom Limit

## IDC Maximum Rotation

**Parameter Name: Sig\_MAX\_ROT**

**Parameter # 652 (SSI # F1h 8Ch)**

Set the maximum rotation any edge of the form can have in relation to the decoder's horizontal or vertical axis for it to be considered for capture. Set this to zero (the default) to disable all checking. This parameter only applies in **Anchored** mode.

Scan the bar code below, followed by two bar codes from [Appendix G, Numeric Bar Codes](#) in the range of 00 to 45 decimal. The default is 00.

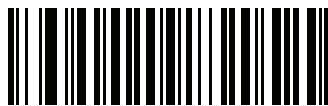

**IDC Maximum Rotation**

---

## Quick Start

This section familiarizes you with some of the Intelligent Document Capture features. [IDC Demonstrations on page 13-17](#) includes instructions to demonstrate the Anchored, Free-Form, and Linked modes using a sample form to help provide an understanding of how to use IDC. These examples do not illustrate all capabilities of the advanced IDC firmware. Build upon these using different parameter settings and forms.

## Sample IDC Setup

To set up IDC with the decoder:

1. Connect a decoder equipped with the Intelligent Document Capture feature to the host computer's USB port.
2. To set the decoder to the default settings and proper USB host type, scan **Set Defaults** followed by the **Symbol Native API (SNAPI) with Imaging Interface** bar code. Allow time for the decoder to reset and the USB connection to remunerate after each scan before continuing.



**Set Defaults**



**Symbol Native API (SNAPI) with Imaging Interface**

## Quick Start (continued)

3. Start the sample application and select the decoder in the **SNAPI Scanners** drop-down menu.
4. Set the parameters as specified in [IDC Demonstrations on page 13-17](#) using the sample application or by scanning parameter bar codes in this guide. The bar code in the sample form is Code 128, which is enabled by default for decoding and as a Document Capture symbology. You can change these settings for your IDC application.
5. Perform the list of suggestions in each demo. When scanning, aim the engine at the bar code in the center of the rectangle. Pull the engine back so the rectangle is fully contained in the aiming pattern. When you pull the trigger, the decoder emits a low tone to indicate that the IDC firmware identified and captured an image, then a decode beep to indicate that the data is processed and transmitted. There may be several seconds between the two beeps, depending on the size of the captured image and options selected (de-skew, brighten, etc). You can move the decoder after the first beep, but continue to hold the trigger or the decoder may end the session before sending the data.

## IDC Demonstrations

### Anchored Mode Demo

Set parameters to these values:

**Table 13-3** *Anchored Mode Sample Parameter Values*

Parameter	Value
IDC Operating Mode	Anchored
IDC Height	100
IDC Width	90
IDC X Coordinate	-175
IDC Y Coordinate	-50

- Pull the trigger. The decoder decodes the bar code and captures an image of the text scroll.
- Rotate the form clockwise so the word **Capture** is along the bottom edge, and pull the trigger. The decoder decodes the bar code and captures the same image, including orientation. (This example also works with the form rotated counterclockwise or upside down).
- Modify the values for height, width, x, and y. Pull the trigger. The captured area changes in size and location.
- Cover the bar code with a small piece of paper (or your finger) and pull the trigger. The decoder does not decode the bar code or capture an image.

#### What this demonstrates:

The Intelligent Document Capture Anchored mode captures an image of fixed size and location relative to a bar code on the page. Parameters control the height, width, and location. The IDC firmware requires that a bar code is present in order to capture an image, decodes it, and uses it to adjust the image to the upright orientation.

## Free-Form Mode Demo

Set IDC Operating Mode to **Free-Form**.

- Pull the trigger. The decoder decodes the bar code and captures an image of the entire rectangle, including the contents.
- Modify the values for height, width, x, and y. Pull the trigger. Note that the captured image is not affected.
- Rotate the form clockwise so the word **Capture** is along the bottom edge, and pull the trigger. The decoder decodes the bar code and captures the same image, including orientation. (This example also works with the form rotated counterclockwise or upside down).
- Cover the bar code with a small piece of paper and pull the trigger. The decoder does not decode the bar code and does not re-orient the captured image to the normal position, i.e., with the logo in upper-left corner.

### What this demonstrates:

The Intelligent Document Capture Free-Form mode captures an image whose size and position are determined by a rectangular border on the page. It adjusts the image to the upright orientation if a bar code is found and decoded in the image.

## Linked Mode Demo

Set IDC Operating Mode to **Linked**.

The examples from Free-Form mode also work in Linked mode except that the last one (with the bar code covered) does not decode the bar code or capture an image.

### What this demonstrates:

The Intelligent Document Capture Linked mode captures an image whose size and position are determined by a rectangular border on the page. The IDC firmware requires that a bar code is present in order to capture an image, decodes it, and uses it to adjust the image to the upright orientation

## Other Suggestions

Hold the decoder at an angle (up/down or side to side) to the page instead of perpendicular to it. The IDC firmware de-skews and adjusts the brightness (enabled by default) to produce a quality image when the decoder is held at less than ideal conditions.

Quick Start Form

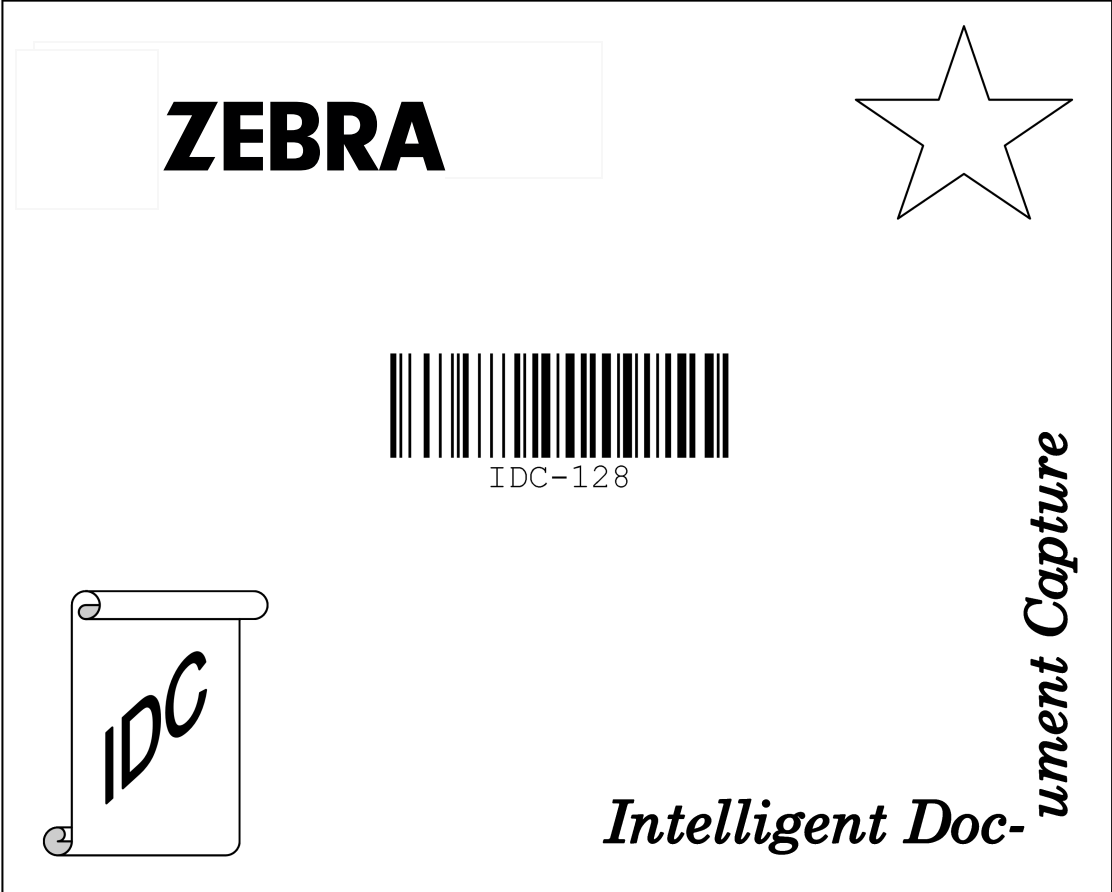

Figure 13-1 Quick Start Form



# CHAPTER 14 OCR PROGRAMMING

---

## Introduction

This chapter describes how to set up the scanner for OCR programming. The scanner can read 6 to 60 point OCR typeface. It supports font types OCR-A, OCR-B, MICR-E13B, and US Currency Serial Number.

OCR is not as secure as a bar code. To decrease OCR misdecodes and speed OCR reading, set an accurate OCR template and character subset, and use a check digit.

All OCR fonts are disabled by default. Enabling OCR can slow bar code decoding. You can enable OCR-A and OCR-B at the same time, but not other combined font types.

---

## Setting Parameters

To set feature values, scan a single bar code or a short bar code sequence. The settings are stored in non-volatile memory and are preserved even when the imager powers down.

✓ **NOTE** Most computer monitors allow scanning bar codes directly on the screen. When scanning from the screen, be sure to set the document magnification to a level where you can see the bar code clearly, and bars and/or spaces do not merge.

To return all features to default values, scan the [Set Factory Defaults on page 9-7](#). Throughout the programming bar code menus, asterisks (\*) indicate default values.



\* Indicates default    \*Enable Parameter (1)    Feature/option  
Option value

## Scanning Sequence Examples

In most cases scanning one bar code sets the parameter value. For example, to enable OCR-B, scan the **Enable OCR-B** bar code under [OCR-B on page 14-6](#). The scanner issues a fast warble beep and the LED turns green, signifying a successful parameter entry.

Other parameters require scanning several bar codes. See the parameter descriptions for this procedure.

## Errors While Scanning

Unless otherwise specified, to correct an error during a scanning sequence, just re-scan the correct parameter.



## OCR Parameter Defaults

[Table 14-1](#) lists the defaults for OCR parameters. Change these values in one of two ways:

- Scan the appropriate bar codes in this chapter. The new value replaces the standard default value in memory. To recall default parameter values, see [Default Parameters on page 9-7](#).
- Configure the scanner using the 123Scan<sup>2</sup> configuration program. See [Chapter 17, 123Scan and Software Tools](#).

✓ **NOTE** See [Appendix A, Standard Parameter Defaults](#) for all user preference, host, symbology, and miscellaneous default parameters.

**Table 14-1** OCR Programming Default Table

Parameter	Parameter Number	SSI Number	Default	Page Number
<b>OCR Programming Parameters</b>				
OCR-A	680	F1h A8h	Disable	<a href="#">14-4</a>
OCR-A Variant	684	F1h ACh	Full ASCII	<a href="#">14-4</a>
OCR-B	681	F1h A9h	Disable	<a href="#">14-6</a>
OCR-B Variant	685	F1h ADh	Full ASCII	<a href="#">14-7</a>
MICR E13B	682	F1h AAh	Disable	<a href="#">14-10</a>
US Currency	683	F1h ABh	Disable	<a href="#">14-11</a>
OCR Orientation	687	F1h AFh	0°	<a href="#">14-11</a>
OCR Lines	691	F1h B3h	1	<a href="#">14-13</a>
OCR Minimum Characters	689	F1h B1h	3	<a href="#">14-13</a>
OCR Maximum Characters	690	F1h B2h	100	<a href="#">14-14</a>
OCR Subset	686	F1h AEh	Selected font variant	<a href="#">14-14</a>
OCR Quiet Zone	695	F1h B7h	50	<a href="#">14-15</a>
OCR Bright Illumination	701	F1h BDh	Disable	<a href="#">14-15</a>
OCR Template	547	F1h 23h	54R	<a href="#">14-16</a>
OCR Check Digit Modulus	688	F1h B0h	1	<a href="#">14-25</a>
OCR Check Digit Multiplier	700	F1h BCh	121212121212	<a href="#">14-26</a>
OCR Check Digit Validation	694	F1h B6h	None	<a href="#">14-27</a>
Inverse OCR	856	F2h 58h	Regular	<a href="#">14-32</a>

## OCR Programming Parameters

### OCR-A

Parameter # 680

SSI # F1h A8h

Scan one of the following bar codes to enable or disable OCR-A.

- ✓ **NOTE** OCR is not as secure as a bar code. To decrease OCR misdecodes and speed OCR reading, set an accurate OCR template and character subset, and use a check digit. See [OCR Subset on page 14-14](#) and [OCR Template on page 14-16](#).
- ✓ **NOTE** All OCR fonts are disabled by default. Enabling OCR can slow bar code decoding. Enabling more than one OCR font could also slow OCR decoding and impact OCR decoding accuracy.



Enable OCR-A  
(1)



\*Disable OCR-A  
(0)

### OCR-A Variant

Parameter # 684

SSI # F1 ACh

The font variant sets a processing algorithm and default character subset for the given font. To choose a variant, scan one of the following bar codes. Select the most appropriate font variant to optimize performance and accuracy.

OCR-A supports the following variants:

- OCR-A Full ASCII  
!#\$()\*+,-./0123456789<>ABCDEFGHIJKLMN OPQRSTUVWXYZ^`
- OCR-A Reserved 1  
\$\*+,-./0123456789ABCDEFGHIJKLMN OPQRSTUVWXYZ
- OCR-A Reserved 2  
\$\*+,-./0123456789<>ABCDEFGHIJKLMN OPQRSTUVWXYZ
- OCR-A Banking  
-0123456789<> ¥ ¢ ¤

## OCR-A Variant (continued)

Special banking characters output as the following representative characters:

ƒ outputs as f

¢ outputs as c

℥ outputs as h

✓ **NOTE** Enable OCR-A before setting this parameter. If disabling OCR-A, set the variant to its default (OCR-A Full ASCII).



\*OCR-A Full ASCII  
(0)



OCR-A Reserved 1  
(1)

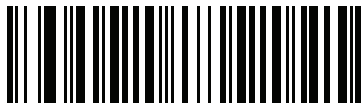

OCR-A Reserved 2  
(2)



OCR-A Banking  
(3)

## OCR-B

Parameter # 681

SSI # F1h A9h

Scan one of the following bar codes to enable or disable OCR-B.

- ✓ **NOTE** OCR is not as secure as a bar code. To decrease OCR misdecodes and speed OCR reading, set an accurate OCR template and character subset, and use a check digit. See [OCR Subset on page 14-14](#) and [OCR Template on page 14-16](#).
- ✓ **NOTE** All OCR fonts are disabled by default. Enabling OCR can slow bar code decoding. Enabling more than one OCR font could also slow OCR decoding and impact OCR decoding accuracy.



Enable OCR-B  
(1)

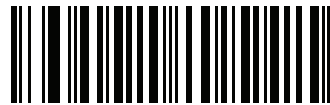

\*Disable OCR-B  
(0)

## OCR-B Variant

### Parameter # 685

#### SSI # F1h ADh

OCR-B has the following variants. Select the most appropriate font variant to optimize performance and accuracy.

- OCR-B Full ASCII  
!#\$%()\*+,-./0123456789<>ABCDEFGHIJKLMNOPQRSTUVWXYZ^|~
- OCR-B Banking  
#+-0123456789<>JNP|
- OCR-B Limited  
+,-./0123456789<>ACENPSTVX
- OCR-B ISBN 10-Digit Book Numbers  
-0123456789>BCEINPSXz
- OCR-B ISBN 10 or 13-Digit Book Numbers  
-0123456789>BCEINPSXz
- OCR-B Travel Document Version 1 (TD1) 3-Line ID Cards  
-0123456789<ABCDEFGHIJKLMNOPQRSTUVWXYZ
- OCR-B Travel Document Version 2 (TD2) 2-Line ID Cards  
-0123456789<ABCDEFGHIJKLMNOPQRSTUVWXYZ
- OCR-B Travel Document 2 or 3-Line ID Cards Auto-Detect  
!#\$%()\*+,-./0123456789<>ABCDEFGHIJKLMNOPQRSTUVWXYZ^|~
- OCR-B Passport  
-0123456789<ABCDEFGHIJKLMNOPQRSTUVWXYZ~
- OCR-B Visa Type A  
-0123456789<ABCDEFGHIJKLMNOPQRSTUVWXYZ
- OCR-B Visa Type B  
-0123456789<ABCDEFGHIJKLMNOPQRSTUVWXYZ~
- OCR-B ICAO Travel Documents  
This allows reading either TD1, TD2, Passport, Visa Type A, or Visa Type B without switching between these options. It automatically recognizes the travel document read.

To choose a variant, scan one of the following bar codes. Selecting the following OCR-B variants automatically sets the appropriate [OCR Lines on page 14-13](#). These five variants invoke extensive special algorithms and checking for that particular document type:

Variant	OCR Lines Setting
Passport	2
TD1 ID Cards	3
TD2 ID Cards	2
Visa Type A	2
Visa Type B	2

Selecting one of the ISBN Book Numbers automatically applies the appropriate ISBN checksum, so you do not need to set this.

## OCR-B Variant (continued)

For the best performance in passport reading, fix the target passport and the scanner in place (6.5 - 7.5”).

✓ **NOTE** Enable OCR-B before setting this parameter. If disabling OCR-B, set the variant to its default (OCR-B Full ASCII).



\*OCR-B Full ASCII  
(0)

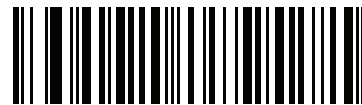

OCR-B Banking  
(1)



OCR-B Limited  
(2)



OCR-B ISBN 10-Digit Book Numbers  
(6)



OCR-B ISBN 10 or 13-Digit Book Numbers  
(7)



OCR-B Travel Document Version 1 (TD1)  
3 Line ID Cards  
(3)

## OCR-B Variant (continued)



**OCR-B Travel Document Version 2 (TD2)  
2-Line ID Cards  
(8)**



**Travel Document 2 or 3-Line ID Cards Auto-Detect  
(20)**



**OCR-B Passport  
(4)**



**OCR-B Visa Type A  
(9)**



**OCR-B Visa Type B  
(10)**



**OCR-B ICAO Travel Documents  
(11)**

## MICR E13B

Parameter # 682

SSI # F1h AAh

Scan one of the following bar codes to enable or disable MICR E13B.

MICR E 13B uses the following characters:

0 1 2 3 4 5 6 7 8 9 t a o d

TOAD characters (Transit, On Us, Amount, and Dash) output as the following representative characters:

t outputs as t

a outputs as a

o outputs as o

d outputs as d

✓ **NOTE** OCR is not as secure as a bar code. To decrease OCR misdecodes and speed OCR reading, set an accurate OCR template and character subset, and use a check digit. See [OCR Subset on page 14-14](#) and [OCR Template on page 14-16](#).

✓ **NOTE** All OCR fonts are disabled by default. Enabling OCR can slow bar code decoding. Enabling more than one OCR font could also slow OCR decoding and impact OCR decoding accuracy.



Enable MICR E13B  
(1)



\*Disable MICR E13B  
(0)



## US Currency Serial Number

Parameter # 683

SSI # F1h ABh

Scan one of the following bar codes to enable or disable US Currency Serial Number.

- ✓ **NOTE** OCR is not as secure as a bar code. To decrease OCR misdecodes and speed OCR reading, set an accurate OCR template and character subset, and use a check digit. See [OCR Subset on page 14-14](#) and [OCR Template on page 14-16](#).
- ✓ **NOTE** All OCR fonts are disabled by default. Enabling OCR can slow bar code decoding. Enabling more than one OCR font could also slow OCR decoding and impact OCR decoding accuracy.



Enable US Currency  
(1)



\*Disable US Currency  
(0)

## OCR Orientation

Parameter # 687

SSI # F1h AFh

Select one of five options to specify the orientation of the OCR to read:

- 0° to the imaging engine (default)
- 270° clockwise (or 90° counterclockwise) to the imaging engine
- 180° (upside down) to the imaging engine
- 90° clockwise to the imaging engine
- Omnidirectional

Setting an incorrect orientation can cause misdecodes.

## OCR Orientation (continued)



\*OCR Orientation 0°  
(0)



OCR Orientation 270° Clockwise  
(1)



OCR Orientation 180° Clockwise  
(2)



OCR Orientation 90° Clockwise  
(3)



OCR Orientation Omnidirectional  
(4)

## OCR Lines

Parameter # 691

SSI # F1h B3h

To select the number of OCR lines to decode, scan one of the following bar codes. Selecting Visas, TD1, or TD2 ID cards automatically sets the appropriate **OCR Lines**. Also see [OCR-B Variant on page 14-7](#).

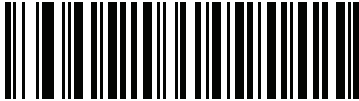

\*OCR 1 Line  
(1)



OCR 2 Lines  
(2)



OCR 3 Lines  
(3)

## OCR Minimum Characters

Parameter # 689

SSI # F1h B1h

To select the minimum number of OCR characters (not including spaces) per line to decode, scan the following bar code, then scan a three-digit number between 003 and 100 using the bar codes in [Appendix B, Numeric Bar Codes](#) representing the number of OCR characters to decode. Strings of OCR characters less than the minimum are ignored. The default is 003.



OCR Minimum Characters

## OCR Maximum Characters

**Parameter # 690**

**SSI # F1h B2h**

To select the maximum number of OCR characters (including spaces) per line to decode, scan the following bar code, then scan a three-digit number between 003 and 100 using the bar codes in [Appendix B, Numeric Bar Codes](#) representing the number of OCR characters to decode. Strings of OCR characters greater than the maximum are ignored. The default is 100.



**OCR Maximum Characters**

## OCR Subset

**Parameter # 686**

**SSI # F1h AEh**

Create an OCR subset to define a custom group of characters in place of a preset font variant. For example, if scanning only numbers and the letters A, B, and C, create a subset of just these characters to speed decoding. This applies a designated OCR Subset across all enabled OCR fonts.

To set or modify the OCR font subset:

1. Enable the appropriate OCR font(s).
2. Scan the **OCR Subset** bar code.
3. Scan numbers and letters to form the OCR Subset from [Appendix C, Alphanumeric Bar Codes](#).
4. Scan [End of Message on page C-8](#).



**OCR Subset**

To cancel an OCR subset, for OCR-A or OCR-B, scan OCR-A variant **Full ASCII**, or OCR-B variant **Full ASCII**.

For MICR E13B or US Currency Serial Number, create a subset which includes all allowed characters in that character set, or scan an option from the [Default Parameters on page 9-7](#) and re-program the scanner.

## OCR Quiet Zone

**Parameter # 695**

**SSI # F1h B7h**

This option sets the OCR quiet zone. The scanner stops scanning a field when it detects a sufficiently wide blank space. The width of this space is defined by the End of Field option. Used with parsers that tolerate slanted characters, the End of Field count is approximately a count of 8 for a character width. For example, if set to 15, then two character widths are an end of line indicator for the parser. Larger end of field numbers require bigger quiet zones at each end of text line.

To set a quiet zone, scan the following bar code, then scan a two-digit number using the numeric keypad in [Appendix C, Alphanumeric Bar Codes](#). The range of the quiet zone is 20 - 99 and the default is 50, indicating a six character width quiet zone.

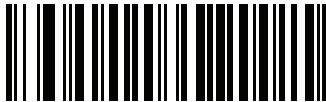

**OCR Quiet Zone**

## OCR Bright Illumination

**Parameter # 701**

**SSI # F1h BDh**

When enabled, image contrast is improved for OCR scanning. Zebra recommends enabling this when the OCR string is longer than 20 characters, and for applications with busy backgrounds such as check or VISA reading.



**Enable OCR Bright Illumination  
(1)**



**\*Disable OCR Bright Illumination  
(0)**

## OCR Template

**Parameter # 547**

**SSI # F1h 23h**

This option creates a template for precisely matching scanned OCR characters to a desired input format. Carefully constructing an OCR template eliminates scanning errors.

To set or modify the OCR decode template, scan the *OCR Template* bar code, and then scan bar codes on the following pages that correspond to numbers and letters to form the template expression. Then scan **End of Message**. The default is **54R** which accepts OCR strings containing any character.



OCR Template



End of Message

### Required Digit (9)

Only a numeric character is accepted in this position.

Template	Valid data	Valid data	Invalid data
99999	12987	30517	123AB



9

### Required Alpha (A)

Only an alpha character is accepted in this position.

Template	Valid data	Valid data	Invalid data
AAAAA	ABCDE	UVWXY	12FGH



A

**Require and Suppress (0)**

Any character in this position, including space or reject, is suppressed from the output.

Template	Incoming data	Output
990AA	12QAB	12AB

**Optional Alphanumeric (1)**

An alphanumeric character is accepted in this position if present. Optional characters are not allowed as the first character(s) in a field of like characters.

Template	Valid data	Valid data	Invalid data
99991	1234A	12345	1234<



1

**Optional Alpha (2)**

An alpha character is accepted in this position if present. Optional characters are not allowed as the first character(s) in a field of like characters.

Template	Valid data	Valid data	Invalid data
AAAA2	ABCDE	WXYZ	ABCD6



2

**Alpha or Digit (3)**

An alphanumeric character is required in this position to validate the incoming data.

Template	Valid data	Valid data	Invalid data
33333	12ABC	WXY34	12AB<



3

### Any Including Space & Reject (4)

Any character is accepted in this position, including space and reject. An underscore (\_) represents rejects in the output. This is a good selection for troubleshooting.

Template	Valid data	Valid data
99499	12\$34	34_98



4

### Any except Space & Reject (5)

Any character is accepted in this position, except a space or reject.

Template	Valid data	Valid data	Invalid data
55999	A.123	*Z456	A BCD



5

### Optional Digit (7)

A numeric character is accepted if present. Optional characters are not allowed as the first character(s) in a field of like characters.

Template	Valid data	Valid data	Invalid data
99977	12345	789	789AB



7



**Digit or Fill (8)**

Any numeric or fill character is accepted in this position.

Template	Valid data	Valid data	Valid data
88899	12345	>>789	<<789



8

**Alpha or Fill (F)**

Any alpha or fill character is accepted in this position.

Template	Valid data	Valid data	Valid data
AAAF	ABCXY	LMN>>	ABC<5



F

**Optional Space ( )**

A space is accepted if present. Optional characters are not allowed as the first character(s) in a field of like characters.

Template	Valid data	Valid data	Invalid data
99 99	12 34	1234	67891



Space

### Optional Small Special (.)

A special character is accepted if present. Optional characters are not allowed as the first character(s) in a field of like characters. Small special characters are - , and .

Template	Valid data	Valid data	Invalid data
AA.99	MN.35	XY98	XYZ12



.

### Other Template Operators

These template operators assist in capturing, delimiting, and formatting scanned OCR data.

#### Literal String (" and +)

Use either of these delimiting characters surrounding characters from the alphanumeric keyboard in [Appendix C, Alphanumeric Bar Codes](#) to define a literal string within a template that must be present in scanned OCR data. There are two characters used to delimit required literal strings; if one of the delimiter characters is present in the desired literal string, use the other delimiter.

Template	Valid data	Invalid data
"35+BC"	35+BC	AB+22



"



+

#### New Line (E)

To create a template of multiple lines, add E between the template of each single line.

Template	Valid data	Valid data	Invalid data
999EAAAA	321	987	XYZW
	BCAD	ZXYW	12



E

**String Extract (C)**

This operator combined with others defines a string of characters to extract from the scanned data. The string extract is structured as follows:

CbPe

Where:

- C is the string extract operator
- b is the string begin delimiter
- P is the category (one or more numeric or alpha characters) describing the string representation
- e is the string end delimiter

Values for b and e can be any scannable character. They are included in the output stream.

Template	Incoming data	Output
C>A>	XQ3>ABCDE>	>ABCDE>
	->ATHRUZ>123	>ATHRUZ>
	1ABCZXYZ	No Output



C

**Ignore to End of Field (D)**

This operator causes all characters after a template to be ignored. Use this as the last character in a template expression. Examples for the template 999D:

Template	Incoming data	Output
999D	123-PED	123
	357298	357
	193	193



D

**Skip Until (P1)**

This operator skips over characters until a specific character type or a literal string is detected. It can be used in two ways:

P1ct

Where:

- P1 is the Skip Until operator
- c is the type of character that triggers the start of output
- t is one or more template characters

P1"s"t

Where:

- P1 is the Skip Until operator
- "s" is one or more literal string characters (see [Literal String \(" and +\) on page 14-20](#)) that trigger the start of output
- t is one or more template characters

The trigger character or literal string is included in output from a Skip Until operator, and the first character in the template should accommodate this trigger.

Template	Incoming data	Output
P1"PN"AA9999	123PN9876	PN9876
	PN1234	PN1234
	X-PN3592	PN3592



P



1

### **Skip Until Not (P0)**

This operator skips over characters until a specific character type or a literal string is not matched in the output stream. It can be used in two ways:

P0ct

Where:

- P0 is the Skip Until Not operator
- c is the type of character that triggers the start of output
- t is one or more template characters

P0"s"t

Where:

- P0 is the Skip Until Not operator

- "s" is one or more literal string characters (see [Literal String \(" and +\) on page 14-20](#)) that trigger the start of output
- t is one or more template characters

The trigger character or literal string is not included in output from a Skip Until Not operator.

Template	Incoming data	Output
P0A9999	BP3456	3456
	PN1234	1234
	5341	No output

Template	Incoming data	Output
P0"PN"9999	PN3456	3456
	5341	No output
	PNPN7654	7654



P



0

### Repeat Previous (R)

This operator allows a template character to repeat one or more times, allowing the capture of variable-length scanned data. The following examples capture two required alpha characters followed by one or more required digits:

Template	Incoming data	Output
AA9R	AB3	AB3
	PN12345	PN12345
	32RM52700	No output



R

***Scroll Until Match (S)***

This operator steps through scanned data one character at a time until the data matches the template.

Template	Incoming data	Output
S99999	AB3	No Output
	PN12345	12345
	32RM52700	52700



**S**

## Multiple Templates

This feature sets up multiple templates for OCR decoding. To do this, follow the procedure described in [OCR Template on page 14-16](#) (scan the [OCR Template](#) bar code, and then bar codes corresponding to numbers and letters to form the template expression, and then **End of Message**) for each template in the multiple template string, using a capital letter **X** as a separator between templates.

For example, set the [OCR Template](#) as **99999XAAAAA** to decode OCR strings of either **12345** or **ABCDE**.

## Template Examples

Following are sample templates with descriptions of valid data for each definition.

Field Definition	Description
"M"99977	<b>M</b> followed by three digits and two optional digits.
"X"997777"X"	<b>X</b> followed by two digits, four optional digits, and an <b>X</b> .
9959775599	Two digits followed by any character, a digit, two optional digits, any two characters, and two digits.
A55 "-" "999" - "99	A letter followed by two characters, a dash, three digits, a dash, and two digits.
33A" . "99	Two alphanumeric characters followed by a letter, a period, and two digits.
999992991	Five digits followed by an optional alpha, two digits, and an optional alphanumeric.
"PN98"	Literal field - <b>PN98</b>

## OCR Check Digit Modulus

### Parameter # 688

#### SSI # F1h B0h

The check digit is the last digit (in the right-most position) in an OCR string and improves the accuracy of the collected data. This option sets OCR module check digit calculation. The calculation is performed on incoming data to determine this check digit, based on the numeric weight of the alpha and numeric characters. See [OCR Check Digit Multiplier on page 14-26](#). If the incoming data does not match the check digit, the data is considered corrupt.

The selected check digit option does not take effect until you set [OCR Check Digit Validation on page 14-27](#).

To choose the Check Digit Modulus, such as 10 for Modulus 10, scan the following bar code, and then scan a three-digit number from 001 to 099 representing the check digit using the numeric keypad in [Appendix C, Alphanumeric Bar Codes](#). The default is 1.



OCR Check Digit

## OCR Check Digit Multiplier

### Parameter # 700

#### SSI # F1h BCh

This option sets OCR check digit multipliers for character positions. For check digit validation, each character in scanned data has an assigned weight to use in calculating the check digit. The scanner OCR ships with the following weight equivalents:

0 = 0	A = 10	K = 20	U = 30
1 = 1	B = 11	L = 21	V = 31
2 = 2	C = 12	M = 22	W = 32
3 = 3	D = 13	N = 23	X = 33
4 = 4	E = 14	O = 24	Y = 34
5 = 5	F = 15	P = 25	Z = 35
6 = 6	G = 16	Q = 26	Space = 0
7 = 7	H = 17	R = 27	
8 = 8	I = 18	S = 28	
9 = 9	J = 19	T = 29	

All other characters are equivalent to one (1).

You can define the multiplier string if it is different from the default.

121212121212 (default)

123456789A (for ISBN, Product Add Right to Left. See [OCR Check Digit Validation on page 14-27](#))

For example:

ISBN	0	2	0	1	1	8	3	9	9	4
Multiplier	10	9	8	7	6	5	4	3	2	1
Product	0	18	0	7	6	40	12	27	18	4
Product add	0+	18+	0+	7+	6+	40+	12+	27+	18+	4= 132

ISBN uses Modulus 11 for the check digit. In this case, 132 is divisible by 11, so it passes the check digit.

To set the check digit multiplier, scan the following bar code, and then scan numbers and letters to form the multiplier string from [Appendix C, Alphanumeric Bar Codes](#). Then scan [End of Message on page C-8](#).

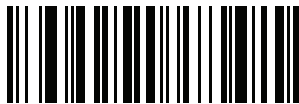

OCR Check Digit Multiplier



## OCR Check Digit Validation

Parameter # 694

SSI # F1h B6h

Use the following options to protect against scanning errors by applying a check digit validation scheme.

### None

No check digit validation, indicating no check digit is applied. This is the default.



**\*No Check Digit  
(0)**

### Product Add Left to Right

Each character in the scanned data is assigned a numeric value (see [OCR Check Digit Multiplier on page 14-26](#)). Each digit representing a character in the scanned data is multiplied by its corresponding digit in the multiplier, and the sum of these products is computed. The check digit passes if this sum modulo Check Digit Modulus is zero.

Example:

Scanned data numeric value is 132456 (check digit is 6)

Check digit multiplier string is 123456

Digit	1	3	2	4	5	6	
Multiplier	1	2	3	4	5	6	
Product	1	6	6	16	25	36	
Product add	1+	6+	6+	16+	25+	36=	90

The Check Digit Modulus is 10. It passes because 90 is divisible by 10 (the remainder is zero).



**Product Add Left to Right  
(3)**

### Product Add Right to Left

Each character in the scanned data is assigned a numeric value (see [OCR Check Digit Multiplier on page 14-26](#)). The check digit multiplier is reversed in order. Each value representing a character in the scanned data is multiplied by its corresponding digit in the reversed multiplier, resulting in a product for each character in the scanned data. The sum of these products is computed. The check digit passes if this sum modulo Check Digit Modulus is zero.

Example:

Scanned data numeric value is 132459 (check digit is 9)

Check digit multiplier string is 123456

Digit	1	3	2	4	5	9	
Multiplier	6	5	4	3	2	1	
Product	6	15	8	12	10	9	
Product add	6+	15+	8+	12+	10+	9=	60

The Check Digit Modulus is 10. It passes because 60 is divisible by 10 (the remainder is 0).



**Product Add Right to Left  
(1)**

### Digit Add Left to Right

Each character in the scanned data is assigned a numeric value (see [OCR Check Digit Multiplier on page 14-26](#)). Each value representing a character in the scanned data is multiplied by its corresponding digit in the multiplier, resulting in a product for each character in the scanned data. The sum of each individual digit in all of the products is then calculated. The check digit passes if this sum modulo Check Digit Modulus is zero.

Example:

Scanned data numeric value is 132456 (check digit is 6)

Check digit multiplier string is 123456

Digit	1	3	2	4	5	6	
Multiplier	1	2	3	4	5	6	
Product	1	6	6	16	25	36	
Digit add	1+	6+	6+	1+6+	2+5+	3+6=	36

The Check Digit Modulus is 12. It passes because 36 is divisible by 12 (the remainder is 0).



**Digit Add Left to Right  
(4)**

### Digit Add Right to Left

Each character in the scanned data is assigned a numeric value (see [OCR Check Digit Multiplier on page 14-26](#)). The check digit multiplier is reversed in order. Each value representing a character in the scanned data is multiplied by its corresponding digit in the reversed multiplier, resulting in a product for each character in the scanned data. The sum of each individual digit in all of the products is then calculated. The check digit passes if this sum modulo Check Digit Modulus is zero.

Example:

Scanned data numeric value is 132456 (check digit is 6)

Check digit multiplier string is 123456

Digit	1	3	2	4	5	6	
Multiplier	6	5	4	3	2	1	
Product	6	15	8	12	10	6	
Digit add	6+	1+5+	8+	1+2+	1+0+	6=	30

The Check Digit Modulus is 10. It passes because 30 is divisible by 10 (the remainder is 0).



Digit Add Right to Left  
(2)

### Product Add Right to Left Simple Remainder

Each character in the scanned data is assigned a numeric value (see [OCR Check Digit Multiplier on page 14-26](#)). The check digit multiplier is reversed in order. Each value representing a character in the scanned data is multiplied by its corresponding digit in the reversed multiplier, resulting in a product for each character in the scanned data. The sum of these products **except for the check digit's product** is computed. The check digit passes if this sum modulo Check Digit Modulus is equal to the check digit's product.

Example:

Scanned data numeric value is 122456 (check digit is 6)

Check digit multiplier string is 123456

Digit	1	2	2	4	5	6	
Multiplier	6	5	4	3	2	1	
Product	6	10	8	12	10	6	
Product add	6+	10+	8+	12+	10=	46	6

The Check Digit Modulus is 10. It passes because 46 divided by 10 leaves a remainder of 6.



**Product Add Right to Left Simple Remainder  
(5)**

**Digit Add Right To Left Simple Remainder**

Each character in the scanned data is assigned a numeric value (see [OCR Check Digit Multiplier on page 14-26](#)). The check digit multiplier is reversed in order. Each value representing a character in the scanned data is multiplied by its corresponding digit in the reversed multiplier, resulting in a product for each character in the scanned data. The sum of each individual digit in all of the products **except for the check digit's product** is then calculated. The check digit passes if this sum modulo Check Digit Modulus is equal to the check digit's product.

Example:

Scanned data numeric value is 122459 (check digit is 6)

Check digit multiplier string is 123456

Digit	1	2	2	4	5	9
Multiplier	6	5	4	3	2	1
Product	6	10	8	12	10	9
Digit add	6+	1+0+	8+	1+2+	1+0=	19 9

The Check Digit Modulus is 10. It passes because 19 divided by 10 leaves a remainder of 9.



**Digit Add Right to Left Simple Remainder  
(6)**

## Health Industry - HIBCC43

This is the health industry module 43 check digit standard. The check digit is the modulus 43 sum of all the character values in a given message, and is printed as the last character in a given message.

Example:

Supplier Labeling Data Structure: + A 1 2 3 B J C 5 D 6 E 7 1

Sum of values:  $41+10+1+2+3+11+19+12+5+13+6+14+7+1 = 145$

Divide 145 by 43. The quotient is 3 with a remainder of 16. The check digit is the character corresponding to the value of the remainder (see [Table 14-2](#)), which in this example is 16, or **G**. The complete Supplier Labeling Data Structure, including the check digit, therefore is:

A 1 2 3 B J C 5 D 6 E 7 1 G

**Table 14-2** *Table of Numeric Value Assignments for Computing HIBC LIC Data Format Check Digit*

0 = 0	9 = 9	I = 18	R = 27	- = 36
1 = 1	A = 10	J = 19	S = 28	. = 37
2 = 2	B = 11	K = 20	T = 29	Space = 38
3 = 3	C = 12	L = 21	U = 30	\$ = 39
4 = 4	D = 13	M = 22	V = 31	/ = 40
5 = 5	E = 14	N = 23	W = 32	+ = 41
6 = 6	F = 15	O = 24	X = 33	% = 42
7 = 7	G = 16	P = 25	Y = 34	
8 = 8	H = 17	Q = 26	Z = 35	



Health Industry - HIBCC43  
(9)

## Inverse OCR

Parameter # 856

SSI # F2h 58h

Inverse OCR is white or light words on a black or dark background. Select an option for decoding inverse OCR:

- **Regular Only** - Decode regular OCR (black on white) strings only.
- **Inverse Only** - Decode inverse OCR (white on black) strings only.
- **Autodiscriminate** - Decode both regular and inverse OCR strings.

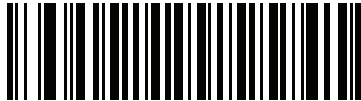

**\*Regular Only**  
(0)



**Inverse Only**  
(1)



**Autodiscriminate**  
(2)

# CHAPTER 15 DRIVER'S LICENSE SET UP (DS8178-DL)

## Introduction

The DS8178-DL digital scanner is capable of parsing out information from standard US driver's licenses and certain other American Association of Motor Vehicle Administrators (AAMVA) compliant ID cards. This is achieved using internally embedded algorithms, where scanning bar codes activates algorithms internally embedded in the digital scanner to produce formatted data. Use the formatted data for age verification, credit card application information, and more.

This chapter describes how to program the DS8178-DL digital scanner to read and use the data contained in the 2D bar codes on US driver's licenses and AAMVA compliant ID cards.

**Table 15-1** *DL Parsing Parameter Table*

Parameter	Default	Page Number
<b>DL Parsing Parameters</b>		
Driver's License Parsing	No Driver's License Parsing	<a href="#">15-2</a>
Parsing Driver's License Data Fields	N/A	<a href="#">15-3</a>
Driver's License Parse Field Bar Codes	N/A	<a href="#">15-4</a>
AAMVA Parse Field Bar Codes	N/A	<a href="#">15-7</a>
Set Default Parameter	N/A	<a href="#">15-17</a>
Output Gender as M or F	N/A	<a href="#">15-17</a>
Date Format	CCYYMMDD	<a href="#">15-18</a>
No Separator	N/A	<a href="#">15-19</a>
Send Keystroke	N/A	<a href="#">15-20</a>
Control Characters		<a href="#">15-20</a>
Keyboard Characters		<a href="#">15-26</a>
Parsing Rule Example	N/A	<a href="#">15-41</a>
Embedded Driver's License Parsing ADF Example	N/A	<a href="#">15-45</a>

---

## Driver's License Parsing

To enable driver's license parsing on the digital scanner, scan the **Embedded Driver's License Parsing** bar code. This does not require Zebra software (.DLL).

Scan the bar codes on the following pages in the order indicating the sequence of data fields that the digital scanner outputs. See [Parsing Driver's License Data Fields \(Embedded Driver's License Parsing\) on page 15-3](#) for more information.



**\*No Driver's License Parsing**

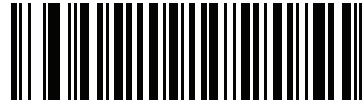

**Embedded Driver's License Parsing**



---

## Parsing Driver's License Data Fields (Embedded Driver's License Parsing)

To begin programming a parsing rule:

1. Scan [Begin New Driver's License Parse Rule on page 15-4](#).
2. Scan any of the field bar codes on the following pages, or [Send Keystroke \(Control Characters and Keyboard Characters\) on page 15-20](#) to complete the parsing rule.
3. After entering the entire rule, scan [Save Driver's License Parse Rule on page 15-4](#) to save the rule.

✓ **NOTE** Only ONE driver's license parsing rule may be stored in memory at any time. Saving a new rule replaces the prior rule.

To abort the programming sequence at any time during programming, scan [Quit Entering Driver's License Rule on page 15-4](#). Any previously saved rule is retained.

To erase a programmed saved rule, scan [Erase Driver's License Parse Rules on page 15-4](#).

### Embedded Driver's License Parsing Criteria - Code Type

After specifying the fields and their order for the parsed driver's license, you can also apply standard ADF rules to the parsed data using the **Parsed Driver's License** criterion bar code in the *Advanced Data Formatting Programmer Guide*.

✓ **NOTE** Only create standard ADF rules on parsed driver's license data when configured for Embedded Driver's License Parsing.

See [Embedded Driver's License Parsing ADF Example on page 15-45](#) for a sample ADF rule using this code type criterion.

## Driver's License Parse Field Bar Codes



**Begin New Driver's License Parse Rule**



**Save Driver's License Parse Rule**



**Quit Entering Driver's License Rule**



**Erase Driver's License Parse Rules**

**Driver's License Parse Field Bar Codes (continued)**

The parse fields currently supported begin below. Not all IDs present data in the same format. For example, some IDs may have separate fields for first name, last name, and middle initial, and others may have a single field with the entire name. In addition, some IDs may expire on the subject's birth date and the actual expiration date field may only indicate the year. In order to present data in a consistent format, the following nine bar codes return data that may be calculated from the actual data contained within the ID bar code.

**First Name****Middle Name/Initial****Last Name****Name Suffix****Name Prefix****Expiration Date****Birth Date**

**Driver's License Parse Field Bar Codes (continued)**



**Issue Date**



**ID Number (Formatted)**

### AAMVA Parse Field Bar Codes

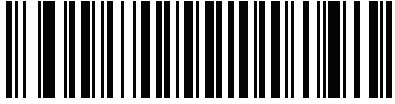

AAMVA Issuer ID

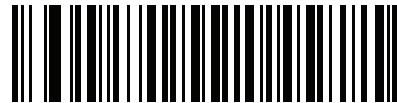

Full Name

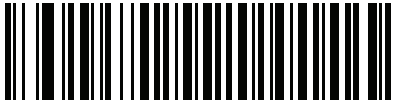

Last Name

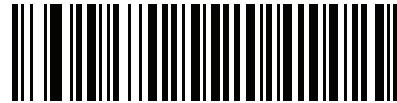

First Name



Middle Name / Initial

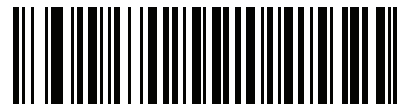

Name Suffix

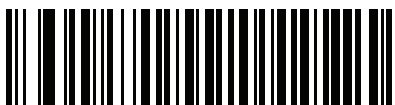

Name Prefix

**AAMVA Parse Field Bar Codes (continued)**



**Mailing Address Line 1**



**Mailing Address Line 2**



**Mailing Address City**

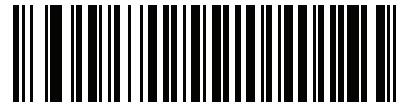

**Mailing Address State**



**Mailing Address Postal Code**



**Home Address Line 1**



**Home Address Line 2**

**AAMVA Parse Field Bar Codes (continued)**



**Home Address City**

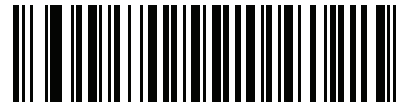

**Home Address State**



**Home Address Postal Code**

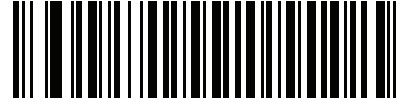

**License ID Number**



**License Class**

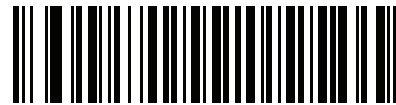

**License Restrictions**



**License Endorsements**

**AAMVA Parse Field Bar Codes (continued)**



**Height (Feet and/or Inches)**

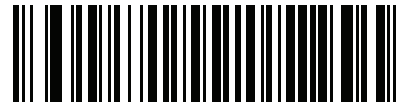

**Height (Centimeters)**

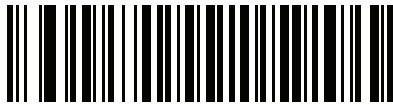

**Weight (Pounds)**

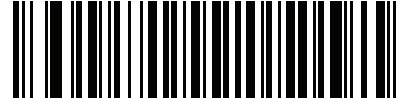

**Weight (Kilograms)**



**Eye Color**

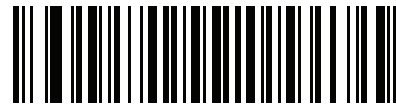

**Hair Color**



**License Expiration Date**



**AAMVA Parse Field Bar Codes (continued)**



**Birth Date**

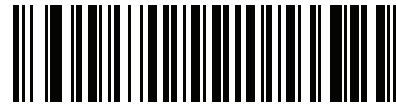

**Gender**

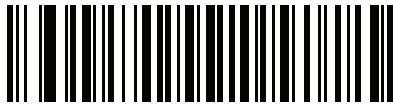

**License Issue Date**



**License Issue State**



**Social Security Number**

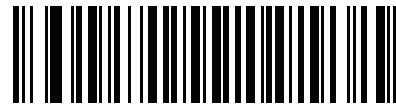

**Permit Class**



**Permit Expiration Date**

**AAMVA Parse Field Bar Codes (continued)**

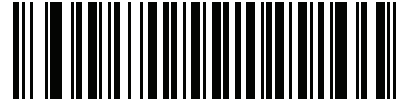

**Permit ID Number**



**Permit Issue Date**

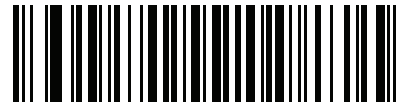

**Permit Restrictions**



**Permit Endorsements**

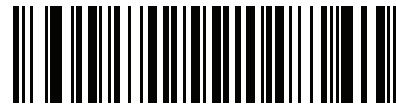

**AKA Social Security Name**



**AKA Full Name**



**AKA Last Name**



**AKA First Name**

**AAMVA Parse Field Bar Codes (continued)**



**AKA Middle Name / Initial**

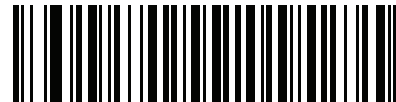

**AKA Name Suffix**



**AKA Name Prefix**

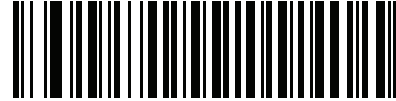

**AKA Birth Date**



**Issue Timestamp**

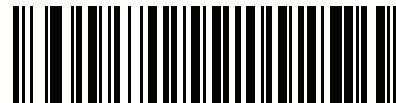

**Number of Duplicates**



**Medical Codes**

**AAMVA Parse Field Bar Codes (continued)**



**Organ Donor**

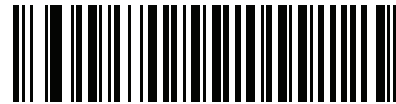

**Nonresident**

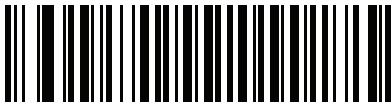

**Customer ID**

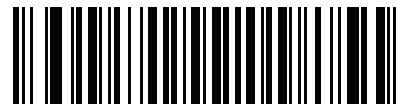

**Weight Range**



**Document Discriminator**



**Country**

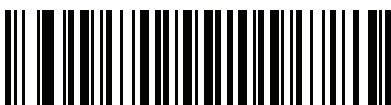

**Federal Commission Codes**

**AAMVA Parse Field Bar Codes (continued)**



**Place of Birth**



**Audit Information**



**Inventory Control**



**Race / Ethnicity**



**Std Vehicle Class**



**Std Endorsements**



**Std Restrictions**

### AAMVA Parse Field Bar Codes (continued)



Class Description

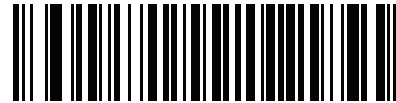

Endorsement Description



Restrictions Description

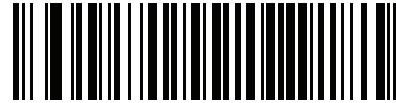

Height in Inches



Height in Centimeters

### Parser Version ID Bar Codes

Include this field to emit embedded parser software version identification

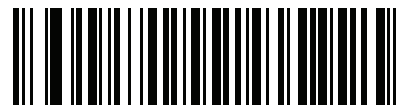

Parser Version ID

---

## User Preferences

### Set Default Parameter

Scan this bar code to return all parameters to the default values listed in [Table A-1 on page A-1](#).



\*Set All Defaults

### Output Gender as M or F

Scan this bar code to report the gender as **M** or **F** instead of a numeric value.

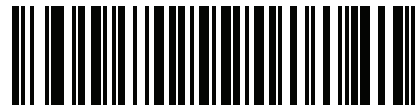

Output gender as M or F

## Date Format

Use these bar codes to select the date format that is displayed. Date fields include the following:

- **CCYY** = 4-digit year (**CC**=2-digit century [00-99], **YY**=2-digit year in the century [00-99])
- **MM** = 2-digit month [01-12]
- **DD** = 2-digit day of the month [00-31]

The default is Date Format **CCYYMMDD**.

✓ **NOTE** To specify a date separator, i.e., a character separating each field of the date, scan the **Send <character>** bar code that corresponds to the alphanumeric character to use as the date separator immediately following the date format bar code. To select no date separator, scan the **No Separator** DL parsing rule immediately following the date format bar code.

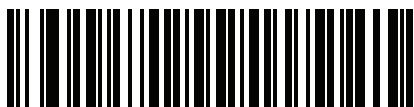

\*CCYYMMDD



CCYYDDMM



MMDDCCYY



MMCCYYDD

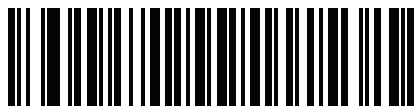

DDMMCCYY

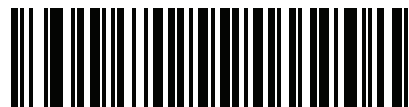

DDCCYYMM



### Date Format (continued)

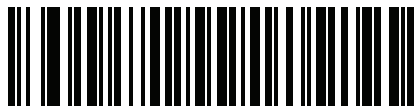

YYMMDD

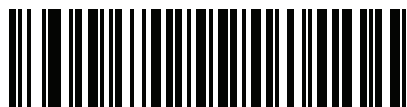

YYDDMM



MMDDYY

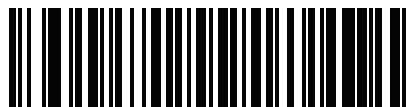

MMY/DD

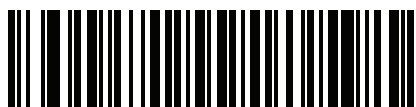

DDMMYY

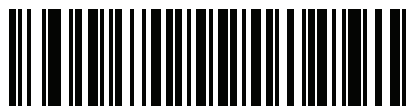

DDYYMM

### No Separator

Scan this bar code immediately following a date format bar code to use no separator character between the date fields.

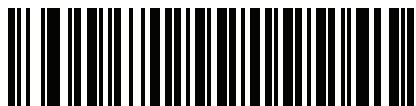

No Separator

## Send Keystroke (Control Characters and Keyboard Characters)

### Control Characters

Scan a **Send** bar code for the keystroke to send.



Send Control A



Send Control B



Send Control C



Send Control D



Send Control E



Send Control F



Send Control G



**Send Control H**

**Control Characters (continued)**



**Send Control I**



**Send Control J**



**Send Control K**



**Send Control L**



**Send Control M**



**Send Control N**



**Send Control O**



**Send Control P**

**Control Characters (continued)**



**Send Control R**



**Send Control Q**



**Send Control S**



**Send Control T**



**Send Control U**



**Send Control V**



**Send Control W**

**Control Characters (continued)**



**Send Control X**



**Send Control Y**



**Send Control Z**



**Send Control [**



**Send Control \**



**Send Control ]**

### Control Characters (continued)



Send Control 6



Send Control -

### Keyboard Characters

Scan a **Send** bar code for the keyboard characters to send.



Send Space



Send !





**Keyboard Characters (continued)**



**Send \$**



**Send %**



**Send &**



**Send '**



**Send (/)**



**Send )**



**Send \***

**Keyboard Characters (continued)**



**Send +**



**Send ,**



**Send -**



**Send .**



**Send /**



**Send 0**



**Send 1**

**Keyboard Characters (continued)**



**Send 2**



**Send 3**



**Send 4**



**Send 5**



**Send 6**



**Send 7**



**Send 8**

**Keyboard Characters (continued)**



**Send 9**



**Send :**



**Send ;**



**Send <**



**Send =**



**Send >**



**Send ?**

**Keyboard Characters (continued)**



**Send @**



**Send A**



**Send B**



**Send C**



**Send D**



**Send E**



**Send F**

**Keyboard Characters (continued)**



**Send G**



**Send H**



**Send I**



**Send J**



**Send K**



**Send L**



**Send M**

Keyboard Characters (continued)



Send N



Send O



Send P



Send Q



Send R



Send S



Send T

**Keyboard Characters (continued)**



**Send U**



**Send V**



**Send W**



**Send X**



**Send Y**



**Send Z**



**Send [**



Keyboard Characters (continued)



Send \



Send ]



Send ^



Send \_



Send `



Send a



Send b

**Keyboard Characters (continued)**



**Send c**



**Send d**



**Send e**



**Send f**



**Send g**



**Send h**



**Send i**

Keyboard Characters (continued)



Send j



Send k



Send l



Send m



Send n



Send o



Send p

**Keyboard Characters (continued)**



**Send q**



**Send r**



**Send s**



**Send t**



**Send u**



**Send v**



**Send w**

Keyboard Characters (continued)



Send x



Send y



Send z



Send {



Send |



Send }



Send ~

**Keyboard Characters (continued)**



**Send Tab Key**



**Send Enter Key**

---

## Parsing Rule Example

Scan the following bar codes in sequence to program the digital scanner to extract and transmit first, middle, and last names; mailing address line 1; mailing address line 2; mailing address city; mailing address state; mailing address postal code; and, date of birth. Then, scan a driver's license bar code.

✓ **NOTE** This example applies to RS-232. To use this example with a USB interface, enable [Function Key Mapping](#) on page 7-10 to send the Enter key properly.

1



Embedded Driver's License Parsing

2



Begin New Driver's License Parse Rule

3



First Name

4



Send Space

5



Middle Name / Initial

6



Send Space

## Parsing Rule Example (continued)

7



Last Name

8



Send Enter Key

9



Mailing Address Line 1

10



Send Space

11



Mailing Address Line 2

12



Send Enter Key



## Parsing Rule Example (continued)

13



Mailing Address City

14



Send Space

15



Mailing Address State

16



Send Space

17



Mailing Address Postal Code

## Parsing Rule Example (continued)

**18**



Send Enter Key

**19**

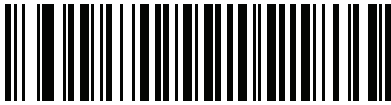

Birth Date

**20**



Send Enter Key

**21**



Save Driver's Licence Parse Rule

## Embedded Driver's License Parsing ADF Example

This example creates a parsing rule for parsed data configured to result in the format:

**Last Name, First Name**

**1**

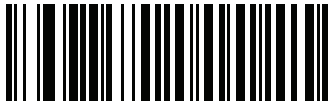

**Begin New Driver's License Parse Rule**

**2**

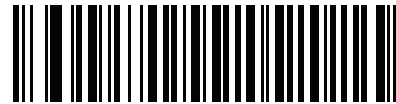

**Last Name**

**3**



**Send ,**

**4**



**Send Space**

**5**



**First Name**

**6**

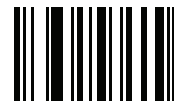

**Save Driver's Licence Parse Rule**

Then, in order to limit the full name to 15 characters, create the following ADF rule:

**1**



**Begin New Rule**

**2**



**Criterion: Parsed Driver's License**

**3**



**Action: Send Next 15 Characters**

**4**



**Save Rule**

For a license belonging to Michael Williams, the parsed data is Williams, Michael and Williams, Micha after applying the previous ADF rule.

# CHAPTER 16 123SCAN AND SOFTWARE TOOLS

---

## Introduction

This chapter briefly describes the Zebra software tools available for customizing scanner operation.

---

## 123Scan

123Scan is a software tool that simplifies scanner setup and more.

Intuitive enough for first time users, the 123Scan wizard guides users through a streamlined setup process. Settings are saved in a configuration file that can be printed as a single programming bar code for scanning, emailed to a smart phone for scanning from its screen, or downloaded to the scanner using a USB cable.

Through 123Scan a user can:

- Configure a scanner using a wizard
  - Program the following scanner settings:
    - Beeper tone / volume settings
    - Enable / disable symbologies
    - Communication settings
    - Preferred Symbol
  - Modify data before transmission to a host using:
    - Advanced Data Formatting (ADF) - Scan one bar code per trigger pull
    - Multicode Data Formatting (MDF) - Scan many bar codes in one trigger pull
- Load parameter settings to a scanner via:
  - Bar code scanning:
    - Scan a paper bar code
    - Scan a bar code from a PC screen
    - Scan a bar code from a smart phone screen
  - Download over a USB cable:
    - Load settings to one scanner
    - Stage up to 10 scanners simultaneously

- Validate scanner setup:
  - View scanned data within the utility's Data View screen
  - Capture an image and save to a PC within the utility's Data View screen
  - Review settings using the Parameter Report
  - Clone settings from an already deployed scanner
- Upgrade scanner firmware:
  - Load settings to one scanner
  - Stage up to 10 scanners simultaneously with a power USB hub
- View statistics such as:
  - Asset tracking information
  - Time and usage information
  - Bar codes scanned by symbology
  - Battery diagnostics
  - Communication diagnostics
- Generate the following reports:
  - Barcode Report - Programming bar code, included parameter settings, and supported scanner models
  - Parameter Report - Lists parameters programmed within a configuration file
  - Activity Report - Lists activities performed on a scanner(s)
  - Inventory Report - Lists scanner asset tracking information
  - Validation Report - Printout of scanned data
  - Statistics Report - Lists all statistics retrieved from the scanner

For more information go to: <http://www.zebra.com/123Scan>.

### Communication with 123Scan

Use a USB cable to connect the scanner to a Windows host computer running 123Scan.

### 123Scan Requirements

- Host computer running Windows
- Scanner
- USB cable

## 123Scan Information

For more information on 123Scan, go to: <http://www.zebra.com/123Scan>.

For a 1 minute tour of 123Scan, go to: <http://www.zebra.com/ScannerHowToVideos>.

To download any of the following free tools, go to: <http://www.zebra.com/scannersoftware>.

- 123Scan configuration utility (described in this chapter)
- How-to-videos

## Scanner SDK, Other Software Tools, and Videos

Tackle all your scanner programming needs with our diversified set of software tools. Whether you need to simply stage a device, or develop a fully featured application with image and data capture as well as asset management, these tools help you every step of the way.

To download any of the following free tools, go to: <http://www.zebra.com/scannersoftware>.

- 123Scan configuration utility
- SDKs
  - Scanner SDK for Windows
  - Scanner SDK for Android
  - Scanner SDK for iOS
  - Scanner SDK for Linux
- Drivers
  - OPOS driver
  - JPOS driver
  - TWAIN driver
  - USB CDC driver
  - Virtual COM port driver
- Scanner Management Service (SMS) for Remote Management
  - Windows
  - Linux
  - IBM 4690
- Mobile Apps
  - Scanner Control App
    - Android
    - iOS
    - Windows
    - Zebra AppGallery
  - Scan-To-Connect Utility
    - Android
    - iOS

- Windows
- Zebra AppGallery
- How-To-Videos
- User documentation.

✓ **NOTE** For a list of SDK supported scanner functionality by communication protocol, see [Appendix J, Communication Protocol Functionality](#).

---

## Scanner Control App

The Scanner Control App allows you to control a Bluetooth scanner from a phone or tablet without a cradle. Use this app to showcase a Zebra Bluetooth scanner's capabilities and ease of control right from your phone.

The Scanner Control App supports Scan-To-Connect technology for one-step Bluetooth pairing, and allows you to control the following scanner functions:

- Program the beeper and LEDs
- Enable and disable symbologies
- Remotely trigger a scan

The app displays scanned bar code data, and can query scanner asset information and battery health statistics.

The Scanner Control app is available on the Android Play, iOS App, and Zebra AppGallery stores. Source code is available within the Zebra Scanner SDK for Android and iOS.

---

## Advanced Data Formatting (ADF)

Advanced Data Formatting (ADF) is a means of customizing data from before transmission to the host device. Use ADF to edit scan data to suit your host's requirements. With ADF you scan one bar code per trigger pull. ADF is programmed using 123Scan.

For an ADF tutorial and a 123Scan programming example, go to the 123Scan section of our How To Videos: <http://www.zebra.com/ScannerHowToVideos>.

For additional information, refer to the *Advanced Data Formatting Programmer Guide*.



---

## Multicode Data Formatting (MDF)

Multicode Data Formatting (MDF) enables a 2D imaging scanner to scan all bar codes on a label with a single trigger pull, and then modify and transmit the data to meet host application requirements. MDF supports programming up to nine unique labels into one scanner. MDF also supports scanning multiple bar codes on opposite sides of a box by holding the trigger.

Programming options include:

- Output all or specific bar codes
- Control the bar code output sequence
- Apply unique multicode data formatting (MDF) to each output bar code
- Discard scanned data if all required bar codes are not present

For more information, refer to the *MDF and Preferred Symbol User Guide*.

## Programming Options

Using 123Scan, programming an MDF Group is similar to setting an ADF rule. MDF programming is saved in the 123Scan configuration file.

MDF can be deployed to a fleet of 2D imaging scanners using the Scanner Management Service (SMS) through a traditional SMS package.

## MDF Terms and Definitions

- **Multicode** - Industry term for the ability to scan multiple bar codes with one trigger pull.
- **Multicode Data Formatting (MDF)** - Zebra's name for Multicode.
- **MDF Session** - The act of decoding a label from trigger pull to either data transmission or decode session termination.
- **MDF Group** - The complete set of commands for processing a single label which contains multiple bar codes. 123Scan can program from one to nine MDF Groups.
- **MDF Rule** - The programming steps for processing a single bar code. Similar to an ADF Rule, the MDF Rule contains both criteria and actions. One MDF Rule identifies a single bar code and how to format its data; more bar codes require more MDF Rules.
- **Pattern Match** - The criteria used to determine if a set of scanned bar codes qualify for Multicode Data Formatting. If the pattern match criteria are not met, Multicode Data Formatting is not applied.

---

## Preferred Symbol

Preferred Symbol is a bar code prioritization technique that enables favored decoding of user designated high priority bar code(s). The Preferred Symbol is the only bar code that is decoded and output within the preset Preferred Symbol Timeout. During this time, the scanner attempts to decode the prioritized bar code and reports only this bar code.

For more information, refer to the *MDF and Preferred Symbol User Guide*.

## Programming Options

To program Preferred Symbol via 123Scan, select **123Scan > Configuration Wizard > Symbologies** screen, and then select **Preferred Symbol** from the drop-down menu. Preferred Symbol programming is saved in the 123Scan configuration file.

Preferred Symbol can be deployed to a fleet of 2D imaging scanners using the Scanner Management Service (SMS) through a traditional SMS package.

# APPENDIX A STANDARD PARAMETER DEFAULTS

**Table A-1** *Parameter Defaults*

Parameter	Parameter Number	SSI Number	Default	Page Number
<b>Radio Communications</b>				
Radio Communications Host Types	N/A	N/A	Cradle Host	<a href="#">4-4</a>
Bluetooth Friendly Name	607	F1h 5Fh	n/a	<a href="#">4-9</a>
Discoverable Mode	610	F1h 62h	General	<a href="#">4-10</a>
Wi-Fi Friendly Mode	1299	F8h 05h 77h	Disable	<a href="#">4-11</a>
Wi-Fi Friendly Channel Exclusion	N/A	N/A	Use All Channels	<a href="#">4-11</a>
Radio Output Power	1324	F8h 05h 2Ch	High	<a href="#">4-13</a>
Link Supervision Timeout	1698	F8h 06h A2h	5 sec	<a href="#">4-14</a>
Bluetooth Radio State	1354	F8h 05h 4Ah	On	<a href="#">4-15</a>
Bluetooth HID - Wait for Connection	1714	F8h 06h B2h	Disable	<a href="#">4-15</a>
HID Features for Apple iOS	1114	F8h 04h 5Ah	Disable	<a href="#">4-16</a>
HID Keyboard Keystroke Delay	N/A	N/A	No Delay (0 msec)	<a href="#">4-17</a>
HID CAPS Lock Override	N/A	N/A	Disable	<a href="#">4-17</a>
HID Ignore Unknown Characters	N/A	N/A	Enable	<a href="#">4-18</a>
Emulate Keypad	N/A	N/A	Enable	<a href="#">4-18</a>
Fast HID Keyboard	1361	F8h 05h 51h	Enable	<a href="#">4-19</a>
Quick Keypad Emulation	1362	F8h 05h 52h	Enable	<a href="#">4-19</a>
HID Keyboard FN1 Substitution	N/A	N/A	Disable	<a href="#">4-20</a>
HID Function Key Mapping	N/A	N/A	Disable	<a href="#">4-20</a>

**Table A-1** *Parameter Defaults (Continued)*

Parameter	Parameter Number	SSI Number	Default	Page Number
Simulated Caps Lock	N/A	N/A	Disable	<a href="#">4-21</a>
Convert Case	N/A	N/A	No Case Conversion	<a href="#">4-21</a>
Reconnect Attempt Beep Feedback	559	F1h 2Fh	Disable	<a href="#">4-22</a>
Reconnect Attempt Interval	558	F1h 2Eh	30 sec	<a href="#">4-23</a>
Auto-Reconnect	604	F1h 5Ch	Auto-Reconnect Immediately	<a href="#">4-24</a>
Beep on Insertion	288	20h	Enable	<a href="#">4-25</a>
Beep on <BEL>	150	96	Enable	<a href="#">4-25</a>
Modes of Operation (Point-to-Point/Multipoint-to-Point)	538	F1 1A	Point-to-Point	<a href="#">4-26</a>
Parameter Broadcast (Cradle Host Only)	148	94h	Enable	<a href="#">4-27</a>
Pairing Modes	542	F1h 1Eh	Unlocked	<a href="#">4-27</a>
Pairing on Contacts	545	F1h 21h	Enable	<a href="#">4-29</a>
Toggle Pairing	1322	F8h 05h 2Ah	Disable	<a href="#">4-30</a>
Connection Maintenance Interval	N/A	N/A	15 Minutes	<a href="#">4-31</a>
Batch Mode	544	F1h 20h	Normal (Do Not Batch Data)	<a href="#">4-33</a>
Persistent Batch Storage	1399	F8h 05h 77h	Disable	<a href="#">4-35</a>
Page Button	746	F1h EAh	Enable	<a href="#">4-36</a>
Page Mode	1364	F8h 05h 54h	Page Simple	<a href="#">4-37</a>
Page Stage Timeout	1365	F8h 05h 55h	30 Seconds	<a href="#">4-37</a>
Bluetooth Classic and/or Low Energy (Cradle Host Only)	1355	F8h 05h 4Bh	Classic and Low Energy	<a href="#">4-38</a>
PIN Code (Set and Store)	552	F1h 28h	12345	<a href="#">4-38</a>
Variable Pin Code	608	F1h 60h	Static (Default PIN code is 12345)	<a href="#">4-39</a>
Bluetooth Security Levels	1393	F8h 05h 71h	Low	<a href="#">4-40</a>
<b>User Preferences</b>				
Set Default Parameter	N/A	N/A	Restore Defaults	<a href="#">5-5</a>
Parameter Bar Code Scanning	236	ECh	Enable	<a href="#">5-6</a>
Beep After Good Decode	56	38h	Enable	<a href="#">5-6</a>

**Table A-1** *Parameter Defaults (Continued)*

Parameter	Parameter Number	SSI Number	Default	Page Number
Direct Decode Indicator	859	F2h 5Bh	Disable	<a href="#">5-7</a>
Beeper Volume	140	8Ch	High	<a href="#">5-8</a>
Beeper Tone	145	91h	Medium	<a href="#">5-9</a>
Beeper Duration	628	F1h 74h	Medium	<a href="#">5-10</a>
Suppress Power Up Beeps	721	F1h D1h	Do Not Suppress	<a href="#">5-10</a>
Decode Pager Motor	613	F1h 65h	Enable	<a href="#">5-11</a>
Decode Pager Motor Duration	626	F1h 72h	150 msec	<a href="#">5-11</a>
Night Mode Trigger (DS8178-HC Only)	1215	F8h 04h BFh	Disable	<a href="#">5-13</a>
Night Mode Toggle (DS8178-HC Only)	N/A	N/A	N/A	<a href="#">5-13</a>
Lamp Mode Control	1711	F8h 06h AFh	Disable	<a href="#">5-14</a>
Lamp Mode Timeout	1712	F8h 06h B0h	5 Minutes	<a href="#">5-15</a>
Low Power Mode	128	80h	Enable	<a href="#">5-16</a>
Time Delay to Low Power Mode	146	92h	5 sec	<a href="#">5-17</a>
Timeout to Low Power Mode from Auto Aim	729	F1h D9h	15 sec	<a href="#">5-19</a>
Hand-Held Trigger Mode	138	8Ah	Level	<a href="#">5-20</a>
Hands-Free Mode	630	F1h 76h	Enable	<a href="#">5-21</a>
Hand-Held Decode Aiming Pattern	306	F0h 32h	Enable	<a href="#">5-22</a>
Hands-Free (Presentation) Decode Aiming Pattern	590	F1h 4Eh	Disable Hands-Free Decode Aiming Pattern	<a href="#">5-23</a>
Picklist Mode	402	F0h 92h	Disabled Always	<a href="#">5-24</a>
FIPS Mode	736	F1h E0h	Disable	<a href="#">5-25</a>
Continuous Bar Code Read	649	F1h 89h	Disable	<a href="#">5-25</a>
Unique Bar Code Reporting	723	F1h D3h	Enable	<a href="#">5-26</a>
Decode Session Timeout	136	88h	9.9 sec	<a href="#">5-26</a>
Hands-Free Decode Session Timeout	400	F0h 90h	15	<a href="#">5-27</a>
Timeout Between Decodes, Same Symbol	137	89h	0.5 sec	<a href="#">5-28</a>

**Table A-1** *Parameter Defaults (Continued)*

Parameter	Parameter Number	SSI Number	Default	Page Number
Timeout Between Decodes, Different Symbols	144	90h	0.1 sec	<a href="#">5-28</a>
Triggered Timeout, Same Symbol	724	F1 D4	Disable	<a href="#">5-29</a>
Decode Mirror Images (Data Matrix Only)	537	F1h 19h	Auto	<a href="#">5-30</a>
Mobile Phone/Display Mode	716	F1h CCh	Normal	<a href="#">5-31</a>
PDF Prioritization	719	F1h CFh	Disable	<a href="#">5-32</a>
PDF Prioritization Timeout	720	F1h D0h	200 ms	<a href="#">5-33</a>
Presentation Mode Field of View	609	F1h 61h	Full	<a href="#">5-33</a>
Decoding Illumination	298	F0h 2Ah	Enable	<a href="#">5-34</a>
Motion Tolerance (Hand-Held Trigger Mode Only)	858	F2h 5Ah	Less Motion Tolerance	<a href="#">5-34</a>
Add an Enter Key	N/A	N/A	N/A	<a href="#">5-36</a>
Transmit Code ID Character	45	2Dh	None	<a href="#">5-36</a>
Battery Threshold		N/A		<a href="#">5-35</a>
Battery Status High Threshold	1367		50%	
Battery Status Medium Threshold	1368		20%	
Battery Status Low Warning Threshold	1369		10%	
Battery Health Low Warning Threshold	1370		60%	
Prefix Value	99, 105	63h, 69h	7013 <CR><LF>	<a href="#">5-38</a>
Suffix 1 Value	98, 104	62h, 68h	7013 <CR><LF>	<a href="#">5-38</a>
Suffix 2 Value	100, 106	64h, 6Ah		
Scan Data Transmission Format	235	EBh	Data as is	<a href="#">5-39</a>
FN1 Substitution Values	103, 109	67h, 6Dh	7013 <CR><LF>	<a href="#">5-40</a>
Transmit "No Read" Message	94	5Eh	Disable	<a href="#">5-41</a>
Unsolicited Heartbeat Interval	1118	F8h 04h 5Eh	Disable	<a href="#">5-42</a>
<b>Imaging Preferences</b>				
Operational Modes	N/A	N/A	N/A	<a href="#">6-4</a>
Image Capture Illumination	361	F0h 69h	Enable	<a href="#">6-5</a>
Image Capture Autoexposure	360	F0h 68h	Enable	<a href="#">6-5</a>
Fixed Exposure	567	F4h F1h 37h	100	<a href="#">6-6</a>

**Table A-1** *Parameter Defaults (Continued)*

Parameter	Parameter Number	SSI Number	Default	Page Number
Fixed Gain	568	F1h 38h	50	6-6
Gain / Exposure Priority for Snapshot Mode	562	F1h 32h	Autodetect	6-7
Snapshot Mode Timeout	323	F0h 43h	0 (30 seconds)	6-8
Snapshot Aiming Pattern	300	F0h 2Ch	Enable	6-9
Silence Operational Mode Changes	1293	F8h 05h 0Dh	Disable (do not silence)	6-9
Image Cropping	301	F0h 2Dh	Disable	6-10
Crop to Pixel Addresses	315 316 317 318	F4h F0h 3Bh F4h F0h 3Ch F4h F0h 3Dh F4h F0h 3Eh	0 top 0 left 959 bottom 1279 right	6-11
Image Size (Number of Pixels)	302	F0h 2Eh	Full	6-12
Image Brightness (Target White)	390	F0h 86h	180	6-13
JPEG Image Options	299	F0h 2Bh	Quality	6-13
JPEG Target File Size	561	F1h 31h	160 kB	6-14
JPEG Quality and Size Value	305	F0h 31h	65	6-14
Image Enhancement	564	F1h 34h	Low (1)	6-15
Image File Format Selector	304	F0h 30h	JPEG	6-16
Image Rotation	665	F1h 99h	0	6-17
Bits per Pixel (BPP)	303	F0h 2Fh	8 BPP	6-18
Signature Capture	93	5Dh	Disable	6-19
Signature Capture Image File Format Selector	313	F0h 39h	JPEG	6-20
Signature Capture Bits per Pixel (BPP)	314	F0h 3Ah	8 BPP	6-21
Signature Capture Width	366	F4h F0h 6Eh	400	6-22
Signature Capture Height	367	F4h F0h 6Fh	100	6-22
Signature Capture JPEG Quality	421	F0h A5h	65	6-22
<b>USB Host Parameters</b>				
USB Device Type	N/A	N/A	HID Keyboard Emulation	7-4
Symbol Native API (SNAPI) Status Handshaking	N/A	N/A	Enable	7-6

**Table A-1** *Parameter Defaults (Continued)*

Parameter	Parameter Number	SSI Number	Default	Page Number
USB Keystroke Delay	N/A	N/A	No Delay	<a href="#">7-6</a>
USB CAPS Lock Override	N/A	N/A	Disable	<a href="#">7-7</a>
USB Ignore Unknown Characters	N/A	N/A	Send	<a href="#">7-7</a>
USB Convert Unknown to Code 39	N/A	N/A	Disable	<a href="#">7-8</a>
Emulate Keypad	N/A	N/A	Enable	<a href="#">7-8</a>
Emulate Keypad with Leading Zero	N/A	N/A	Enable	<a href="#">7-8</a>
Quick Keypad Emulation	N/A	N/A	Enable	<a href="#">7-9</a>
USB FN1 Substitution	N/A	N/A	Disable	<a href="#">7-9</a>
Function Key Mapping	N/A	N/A	Disable	<a href="#">7-10</a>
Simulated Caps Lock	N/A	N/A	Disable	<a href="#">7-10</a>
Convert Case	N/A	N/A	No Case Conversion	<a href="#">7-11</a>
USB Static CDC	N/A	N/A	Enable	<a href="#">7-11</a>
Ignore Beep	N/A	N/A	Enable	<a href="#">7-12</a>
Ignore Bar Code Configuration	N/A	N/A	Enable	<a href="#">7-12</a>
USB Polling Interval	N/A	N/A	3 msec	<a href="#">7-13</a>
USB Fast HID	N/A	N/A	Enable	<a href="#">7-15</a>
IBM Specification Version	N/A	N/A	Version 2.2	<a href="#">7-15</a>
<b>RS-232 Host Parameters</b>				
RS-232 Host Types	N/A	N/A	Standard	<a href="#">9-6</a>
Baud Rate	N/A	N/A	9600	<a href="#">9-8</a>
Parity Type	N/A	N/A	None	<a href="#">9-9</a>
Stop Bits	N/A	N/A	1 Stop Bit	<a href="#">9-10</a>
Data Bits	N/A	N/A	8-Bit	<a href="#">9-10</a>
Check Receive Errors	N/A	N/A	Enable	<a href="#">9-11</a>
Hardware Handshaking	N/A	N/A	None	<a href="#">9-11</a>
Software Handshaking	N/A	N/A	None	<a href="#">9-13</a>
Host Serial Response Time-out	N/A	N/A	2 sec	<a href="#">9-15</a>
RTS Line State	N/A	N/A	Low RTS	<a href="#">9-16</a>
Beep on <BEL>	N/A	N/A	Disable	<a href="#">9-16</a>



**Table A-1** *Parameter Defaults (Continued)*

Parameter	Parameter Number	SSI Number	Default	Page Number
Intercharacter Delay	N/A	N/A	0 msec	9-17
Nixdorf Beep/LED Options	N/A	N/A	Normal Operation	9-18
Ignore Unknown Characters	N/A	N/A	Send Bar Code	9-18
<b>IBM 468X/469X Host Parameters</b>				
Port Address	N/A	N/A	None Selected	10-4
Convert Unknown to Code 39	N/A	N/A	Disable	10-5
RS-485 Beep Directive	N/A	N/A	Honor	10-5
RS-485 Bar Code Configuration Directive	N/A	N/A	Ignore	10-6
IBM-485 Specification Version	N/A	N/A	Original Specification	10-6
<b>Keyboard Wedge Host Parameters</b>				
Keyboard Wedge Host Type	N/A	N/A	IBM AT Notebook	11-4
Ignore Unknown Characters	N/A	N/A	Transmit	11-4
Keystroke Delay	N/A	N/A	No Delay	11-5
Intra-Keystroke Delay	N/A	N/A	Disable	11-5
Alternate Numeric Keypad Emulation	N/A	N/A	Enable	11-6
Quick Keypad Emulation	N/A	N/A	Enable	11-6
Simulated Caps Lock	N/A	N/A	Disable	11-7
Caps Lock Override	N/A	N/A	Disable	11-7
Convert Wedge Case	N/A	N/A	No Convert	11-8
Function Key Mapping	N/A	N/A	Disable	11-8
FN1 Substitution	N/A	N/A	Disable	11-9
Send Make and Break	N/A	N/A	Send Make and Break Scan Codes	11-9
<b>Enable/Disable All Code Types</b>				12-7
<b>1D Symbolologies</b>				
<b>UPC/EAN</b>				
UPC-A	1	01h	Enable	12-8
UPC-E	2	02h	Enable	12-8
UPC-E1	12	0Ch	Disable	12-9

**Table A-1** *Parameter Defaults (Continued)*

Parameter	Parameter Number	SSI Number	Default	Page Number
EAN-8/JAN 8	4	04h	Enable	<a href="#">12-9</a>
EAN-13/JAN 13	3	03h	Enable	<a href="#">12-10</a>
Bookland EAN	83	53h	Disable	<a href="#">12-10</a>
Decode UPC/EAN/JAN Supplementals (2 and 5 digits)	16	10h	Ignore	<a href="#">12-11</a>
User-Programmable Supplementals Supplemental 1: Supplemental 2:	579 580	F1h 43h F1h 44h	000	<a href="#">12-14</a>
UPC/EAN/JAN Supplemental Redundancy	80	50h	10	<a href="#">12-14</a>
Decode UPC/EAN/JAN Supplemental AIM ID	672	F1h A0h	Combined	<a href="#">12-15</a>
UPC Reduced Quiet Zone	1289	F8h 05h 09h	Disable	<a href="#">12-16</a>
Transmit UPC-A Check Digit	40	28h	Enable	<a href="#">12-16</a>
Transmit UPC-E Check Digit	41	29h	Enable	<a href="#">12-17</a>
Transmit UPC-E1 Check Digit	42	2Ah	Enable	<a href="#">12-17</a>
UPC-A Preamble	34	22h	System Character	<a href="#">12-18</a>
UPC-E Preamble	35	23h	System Character	<a href="#">12-19</a>
UPC-E1 Preamble	36	24h	System Character	<a href="#">12-20</a>
Convert UPC-E to A	37	25h	Disable	<a href="#">12-21</a>
Convert UPC-E1 to A	38	26h	Disable	<a href="#">12-21</a>
EAN-8/JAN-8 Extend	39	27h	Disable	<a href="#">12-22</a>
Bookland ISBN Format	576	F1h 40h	ISBN-10	<a href="#">12-22</a>
UCC Coupon Extended Code	85	55h	Disable	<a href="#">12-23</a>
Coupon Report	730	F1h DAh	New Coupon Format	<a href="#">12-23</a>
ISSN EAN	617	F1h 69h	Disable	<a href="#">12-24</a>
<b>Code 128</b>				
Code 128	8	08h	Enable	<a href="#">12-24</a>
Set Length(s) for Code 128	209, 210	D1h, D2h	Any Length	<a href="#">12-25</a>
GS1-128 (formerly UCC/EAN-128)	14	0Eh	Enable	<a href="#">12-27</a>

**Table A-1** *Parameter Defaults (Continued)*

Parameter	Parameter Number	SSI Number	Default	Page Number
ISBT 128	84	54h	Enable	<a href="#">12-27</a>
ISBT Concatenation	577	F1h 41h	Autodiscriminate	<a href="#">12-28</a>
Check ISBT Table	578	F1h 42h	Enable	<a href="#">12-29</a>
ISBT Concatenation Redundancy	223	DFh	10	<a href="#">12-29</a>
Code 128 Security Level	751	F1h EFh	Security Level 1	<a href="#">12-30</a>
Code 128 Reduced Quiet Zone	1208	F8h 04h B8h	Disable	<a href="#">12-31</a>
Ignore Code 128 <FNC4>	1254	F8h 04h E6h	Disable	<a href="#">12-31</a>
<b>Code 39</b>				
Code 39	0	00h	Enable	<a href="#">12-32</a>
Trioptic Code 39	13	0Dh	Disable	<a href="#">12-32</a>
Convert Code 39 to Code 32 (Italian Pharmacy Code)	86	56h	Disable	<a href="#">12-33</a>
Code 32 Prefix	231	E7h	Disable	<a href="#">12-33</a>
Set Length(s) for Code 39	18, 19	12h, 13h	1 to 55	<a href="#">12-34</a>
Code 39 Check Digit Verification	48	30h	Disable	<a href="#">12-35</a>
Transmit Code 39 Check Digit	43	2Bh	Disable	<a href="#">12-35</a>
Code 39 Full ASCII Conversion	17	11h	Disable	<a href="#">12-36</a>
Code 39 Security Level	750	F1h EEh	Security Level 1	<a href="#">12-37</a>
Code 39 Reduced Quiet Zone	1209	F8h 04h B9h	Disable	<a href="#">12-38</a>
<b>Code 93</b>				
Code 93	9	09h	Enable	<a href="#">12-38</a>
Set Length(s) for Code 93	26, 27	1Ah, 1Bh	1 to 55	<a href="#">12-39</a>
<b>Code 11</b>				
Code 11	10	0Ah	Disable	<a href="#">12-40</a>
Set Lengths for Code 11	28, 29	1Ch, 1Dh	4 to 55	<a href="#">12-40</a>
Code 11 Check Digit Verification	52	34h	Disable	<a href="#">12-42</a>
Transmit Code 11 Check Digit(s)	47	2Fh	Disable	<a href="#">12-42</a>
<b>Interleaved 2 of 5 (ITF)</b>				
Interleaved 2 of 5 (ITF)	6	06h	Enable	<a href="#">12-43</a>

**Table A-1** Parameter Defaults (Continued)

Parameter	Parameter Number	SSI Number	Default	Page Number
Set Lengths for I 2 of 5	22, 23	16h, 17h	6 to 55	<a href="#">12-43</a>
I 2 of 5 Check Digit Verification	49	31h	Disable	<a href="#">12-45</a>
Transmit I 2 of 5 Check Digit	44	2Ch	Disable	<a href="#">12-45</a>
Convert I 2 of 5 to EAN 13	82	52h	Disable	<a href="#">12-46</a>
I 2 of 5 Security Level	1121	F8h 04h 61h	Security Level 1	<a href="#">12-46</a>
I 2 of 5 Reduced Quiet Zone	1210	F8h 04h BAh	Disable	<a href="#">12-47</a>
<b>Discrete 2 of 5 (DTF)</b>				
Discrete 2 of 5	5	05h	Disable	<a href="#">12-48</a>
Set Length(s) for D 2 of 5	20, 21	14h 15h	1 to 55	<a href="#">12-48</a>
<b>Codabar (NW - 7)</b>				
Codabar	7	07h	Enable	<a href="#">12-50</a>
Set Lengths for Codabar	24, 25	18h, 19h	4 to 55	<a href="#">12-50</a>
CLSI Editing	54	36h	Disable	<a href="#">12-52</a>
NOTIS Editing	55	37h	Disable	<a href="#">12-52</a>
Codabar Upper or Lower Case Start/Stop Characters Detection	855	F2h 57h	Upper Case	<a href="#">12-53</a>
<b>MSI</b>				
MSI	11	0Bh	Disable	<a href="#">12-53</a>
Set Length(s) for MSI	30, 31	1Eh, 1Fh	4 to 55	<a href="#">12-54</a>
MSI Check Digits	50	32h	One	<a href="#">12-55</a>
Transmit MSI Check Digit	46	2Eh	Disable	<a href="#">12-55</a>
MSI Check Digit Algorithm	51	33h	Mod 10/Mod 10	<a href="#">12-56</a>
MSI Reduced Quiet Zone	1392	F8h 05h 70h	Disable	<a href="#">12-56</a>
<b>Chinese 2 of 5</b>				
Chinese 2 of 5	408	F0h 98h	Disable	<a href="#">12-57</a>
<b>Matrix 2 of 5</b>				
Matrix 2 of 5	618	F1h 6Ah	Disable	<a href="#">12-57</a>
Matrix 2 of 5 Lengths	619 620	F1h 6Bh F1h 6Ch	Any Length	<a href="#">12-58</a>
Matrix 2 of 5 Check Digit	622	F1h 6Eh	Disable	<a href="#">12-59</a>

**Table A-1** *Parameter Defaults (Continued)*

Parameter	Parameter Number	SSI Number	Default	Page Number
Transmit Matrix 2 of 5 Check Digit	623	F1h 6Fh	Disable	<a href="#">12-59</a>
<b>Korean 3 of 5</b>				
Korean 3 of 5	581	F1h 45h	Disable	<a href="#">12-60</a>
<b>Inverse 1D</b>	586	F1h 4Ah	Regular	<a href="#">12-61</a>
<b>GS1 DataBar</b>				
GS1 DataBar-14	338	F0h 52h	Enable	<a href="#">12-62</a>
GS1 DataBar Limited	339	F0h 53h	Enable	<a href="#">12-62</a>
GS1 DataBar Expanded	340	F0h 54h	Enable	<a href="#">12-63</a>
Convert GS1 DataBar to UPC/EAN	397	F0h 8Dh	Disable	<a href="#">12-63</a>
GS1 DataBar Limited Margin Check	728	F1h D8h	Level 3	<a href="#">12-64</a>
GS1 DataBar Security Level	1706	F8h 06h AAh	Level 1	<a href="#">12-65</a>
<b>Composite</b>				
Composite CC-C	341	F0h 55h	Disable	<a href="#">12-66</a>
Composite CC-A/B	342	F0h 56h	Disable	<a href="#">12-66</a>
Composite TLC-39	371	F0h 73h	Disable	<a href="#">12-67</a>
Composite Inverse	1113	F8h 04h 59h	Regular	<a href="#">12-67</a>
UPC Composite Mode	344	F0h 58h	UPC Never Linked	<a href="#">12-68</a>
Composite Beep Mode	398	F0h 8Eh	Beep As Each Code Type is Decoded	<a href="#">12-68</a>
GS1-128 Emulation Mode for UCC/EAN Composite Codes	427	F0h ABh	Disable	<a href="#">12-69</a>
<b>2D Symbologies</b>				
PDF417	15	0Fh	Enable	<a href="#">12-69</a>
MicroPDF417	227	E3h	Disable	<a href="#">12-70</a>
Code 128 Emulation	123	7Bh	Disable	<a href="#">12-70</a>
Data Matrix	292	F0h 24h	Enable	<a href="#">12-71</a>
GS1 Data Matrix	1336	F8h 05h 38h	Disable	<a href="#">12-71</a>
Data Matrix Inverse	588	F1h 4Ch	Inverse Autodetect	<a href="#">12-72</a>
Maxicode	294	F0h 26h	Disable	<a href="#">12-72</a>
QR Code	293	F0h 25h	Enable	<a href="#">12-73</a>

**Table A-1** *Parameter Defaults (Continued)*

Parameter	Parameter Number	SSI Number	Default	Page Number
GS1 QR	1343	F8h 05h 3Fh	Disable	<a href="#">12-73</a>
MicroQR	573	F1h 3Dh	Enable	<a href="#">12-74</a>
Aztec	574	F1h 3Eh	Enable	<a href="#">12-74</a>
Aztec Inverse	589	F1h 4Dh	Inverse Autodetect	<a href="#">12-75</a>
Han Xin	1167	F8h 04h 8Fh	Disable	<a href="#">12-75</a>
Han Xin Inverse	1168	F8h 04h 90h	Regular	<a href="#">12-76</a>
<b>Postal Codes</b>				
US Postnet	89	59h	Disable	<a href="#">12-76</a>
US Planet	90	5Ah	Disable	<a href="#">12-77</a>
Transmit US Postal Check Digit	95	5Fh	Enable	<a href="#">12-77</a>
UK Postal	91	5Bh	Disable	<a href="#">12-78</a>
Transmit UK Postal Check Digit	96	60h	Enable	<a href="#">12-78</a>
Japan Postal	290	F0h 22h	Disable	<a href="#">12-79</a>
Australia Post	291	F0h 23h	Disable	<a href="#">12-79</a>
Australia Post Format	718	F1h CEh	Autodiscriminate	<a href="#">12-80</a>
Netherlands KIX Code	326	F0h 46h	Disable	<a href="#">12-81</a>
USPS 4CB/One Code/Intelligent Mail	592	F1h 50h	Disable	<a href="#">12-81</a>
UPU FICS Postal	611	F1h 63h	Disable	<a href="#">12-82</a>
Mailmark	1337	F8h 05h 08h	Disable	<a href="#">12-82</a>
<b>Symbology-Specific Security Levels</b>				
Redundancy Level	78	4Eh	1	<a href="#">12-83</a>
Security Level	77	4Dh	1	<a href="#">12-85</a>
1D Quiet Zone Level	1288	F8h 05h 08h	1	<a href="#">12-86</a>
Intercharacter Gap Size	381	F0h 7Dh	Normal	<a href="#">12-87</a>
Report Version				<a href="#">12-87</a>
<b>Macro PDF</b>				
Flush Macro PDF Buffer	N/A	N/A	N/A	<a href="#">12-88</a>
Abort Macro PDF Entry	N/A	N/A	N/A	<a href="#">12-88</a>

**Table A-1** *Parameter Defaults (Continued)*

Parameter	Parameter Number	SSI Number	Default	Page Number
<b>Intelligent Document Capture (IDC)</b>				
IDC Operating Mode	594	F1h 52h	Off	<a href="#">13-5</a>
IDC Symbology	655	F1h 8Fh	001	<a href="#">13-6</a>
IDC X Coordinate	596	F4h F1h 54h	-151	<a href="#">13-7</a>
IDC Y Coordinate	597	F4h F1h 55h	-050	<a href="#">13-7</a>
IDC Width	598	F1h 56h	0300	<a href="#">13-8</a>
IDC Height	599	F1h 57h	0050	<a href="#">13-8</a>
IDC Aspect	595	F1h 53h	000	<a href="#">13-9</a>
IDC File Format Selector	601	F1h 59h	JPEG	<a href="#">13-9</a>
IDC Bits Per Pixel	602	F1h 5Ah	8 BPP	<a href="#">13-10</a>
IDC JPEG Quality	603	F1h 5Bh	065	<a href="#">13-10</a>
IDC Find Box Outline	727	F1h D7h	Disable	<a href="#">13-11</a>
IDC Minimum Text Length	656	F1h 90h	00	<a href="#">13-11</a>
IDC Maximum Text Length	657	F1h 91h	00	<a href="#">13-12</a>
IDC Captured Image Brighten	654	F1h 8Eh	Enable	<a href="#">13-12</a>
IDC Captured Image Sharpen	658	F1h 92h	Enable	<a href="#">13-13</a>
IDC Border Type	829	F2h 3Dh	None	<a href="#">13-14</a>
IDC Delay Time	830	F2h 3Eh	000	<a href="#">13-15</a>
IDC Zoom Limit	651	F1h 8Bh	000	<a href="#">13-15</a>
IDC Maximum Rotation	652	F1h 8Ch	00	<a href="#">13-16</a>
<b>OCR Programming Parameters</b>				
OCR-A	680	F1h A8h	Disable	<a href="#">14-4</a>
OCR-A Variant	684	F1h ACh	Full ASCII	<a href="#">14-4</a>
OCR-B	681	F1h A9h	Disable	<a href="#">14-6</a>
OCR-B Variant	685	F1h ADh	Full ASCII	<a href="#">14-7</a>
MICR E13B	682	F1h AAh	Disable	<a href="#">14-10</a>
US Currency	683	F1h ABh	Disable	<a href="#">14-11</a>
OCR Orientation	687	F1h AFh	0°	<a href="#">14-11</a>
OCR Lines	691	F1h B3h	1	<a href="#">14-13</a>

**Table A-1** *Parameter Defaults (Continued)*

Parameter	Parameter Number	SSI Number	Default	Page Number
OCR Minimum Characters	689	F1h B1h	3	<a href="#">14-13</a>
OCR Maximum Characters	690	F1h B2h	100	<a href="#">14-14</a>
OCR Subset	686	F1h AEh	Selected font variant	<a href="#">14-14</a>
OCR Quiet Zone	695	F1h B7h	50	<a href="#">14-15</a>
OCR Template	547	F1h 23h	54R	<a href="#">14-16</a>
OCR Check Digit Modulus	688	F1h B0h	1	<a href="#">14-25</a>
OCR Check Digit Multiplier	700	F1h BCh	121212121212	<a href="#">14-26</a>
OCR Check Digit Validation	694	F1h B6h	None	<a href="#">14-27</a>
Inverse OCR	856	F2h 58h	Regular	<a href="#">14-32</a>



# APPENDIX B COUNTRY CODES

---

## Introduction

This chapter provides instructions for programming the keyboard to interface with a USB, BT HID, or keyboard wedge host. The host powers the scanner. For host setup information, see [Chapter 7, USB Interface](#) and [Chapter 11, Keyboard Wedge Interface](#).

✓ **NOTE** Mobile device keyboards are English only.

To select a code page for the country keyboard type, see [Appendix C, Country Code Pages](#).

Throughout the programming bar code menus, default values are indicated with asterisks (\*).

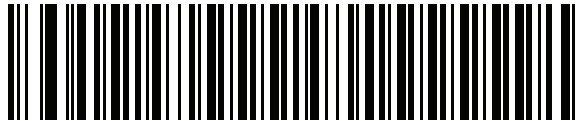

\*Indicates Default — **\*US English (North American)** — Feature/Option

## USB, BT HID, and Keyboard Wedge Country Keyboard Types (Country Codes)

Scan the bar code corresponding to the keyboard type. For a USB host, this setting applies only to the USB Keyboard (HID) device. If the keyboard type is not listed, see [Emulate Keypad on page 7-8](#) for the USB HID host. For a keyboard wedge host, see [Alternate Numeric Keypad Emulation on page 11-6](#).



**NOTE** When changing USB country keyboard types the digital scanner automatically resets and issues the standard startup beep sequences.



**NOTE** For best results when using international keyboards, enable [Quick Keypad Emulation on page 7-9](#).



**IMPORTANT** 1. Some country keyboard bar code types are specific to certain Windows Operating Systems (i.e., XP, and Win 7 or higher). Bar codes requiring a specific Windows OS are noted so in their bar code captions.

2. Use the **French International** bar code for Belgian French keyboards.

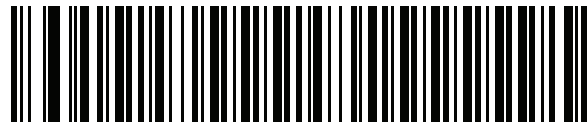

\*US English (North American)



US English (Mac)

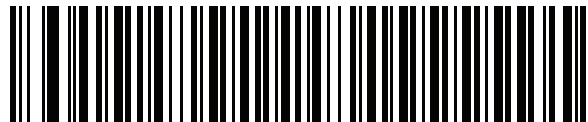

Albanian



Arabic (101)



Arabic (102)

### Country Codes (Continued)



Arabic (102) AZERTY



Azeri (Latin)



Azeri (Cyrillic)



Belarusian

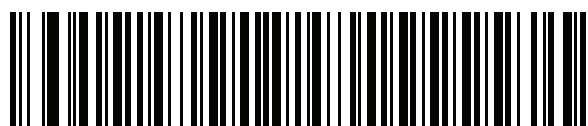

Bosnian (Latin)

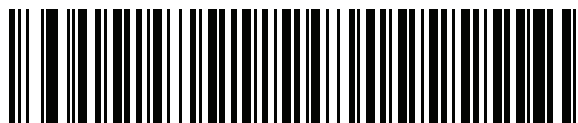

Bosnian (Cyrillic)



Bulgarian (Latin)

## Country Codes (Continued)

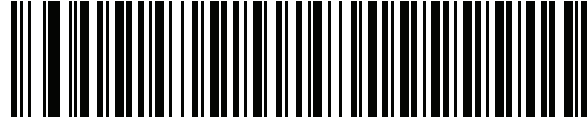

**Bulgarian Cyrillic (Typewriter)  
(Bulgarian -Windows XP  
Typewriter - Win 7 or higher)**

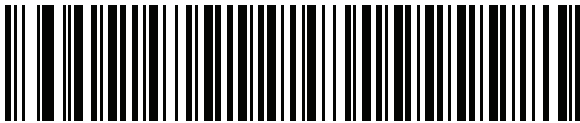

**Canadian French Win7**

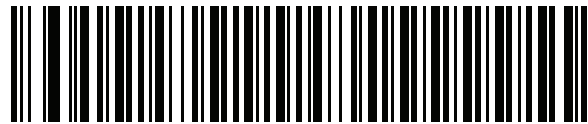

**Canadian French (Legacy)**



**Canadian Multilingual Standard**



**Chinese (ASCII)**

## Country Codes (Continued)

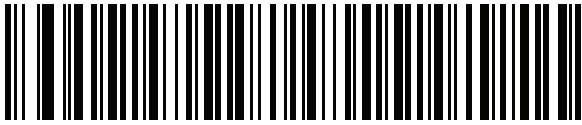

Chinese (Simplified)\*

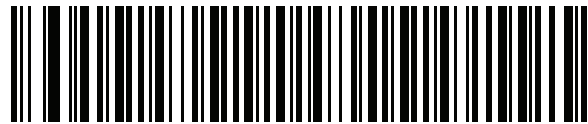

Chinese (Traditional)\*

\*For CJK keyboard types, see [Appendix D, CKJ Decode Control](#).

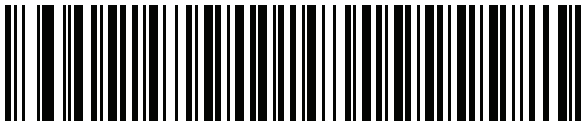

Croatian

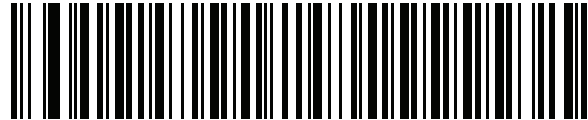

Czech



Czech (Programmer)



Czech (QWERTY)



Danish

### Country Codes (Continued)



**Dutch (Netherlands)**

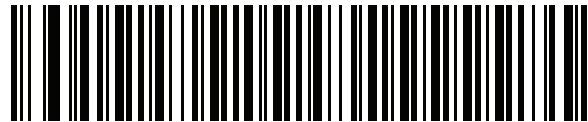

**Estonian**

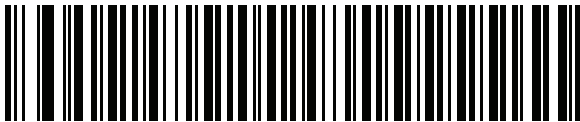

**Faeroese**



**Finnish**



**French (France)**



**French International  
(Belgian French)**



**French (Canada) 95/98**

## Country Codes (Continued)

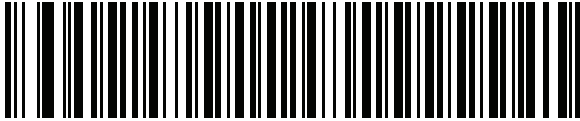

**French (Canada) 2000/XP\***

\*Note that there is also a country code bar code for [Canadian Multilingual Standard on page B-4](#). Be sure to select the appropriate bar code for your host system.

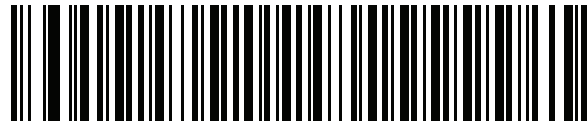

**Galician**



**German**

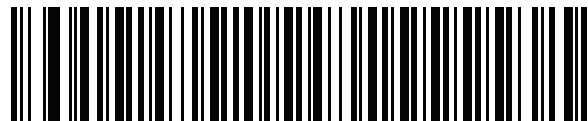

**Greek Latin**



**Greek (220) Latin**



**Greek (319) Latin**



**Greek**

### Country Codes (Continued)

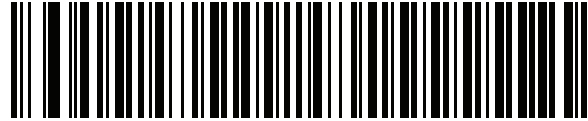

Greek (220)

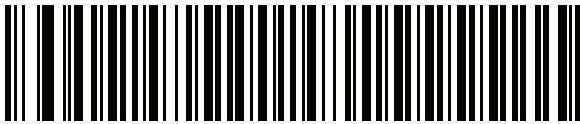

Greek (319)

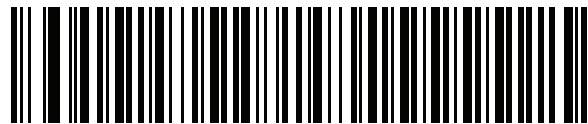

Greek Polytonic



Hebrew Israel

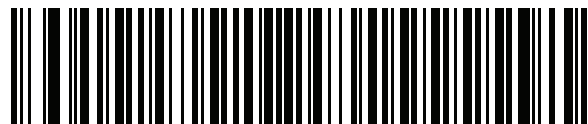

Hungarian

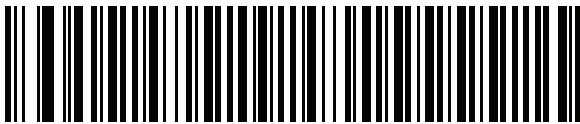

Hungarian\_101KEY



Icelandic

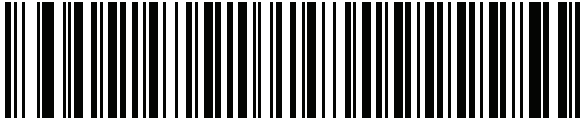
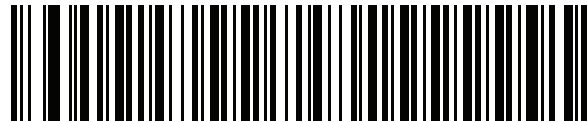
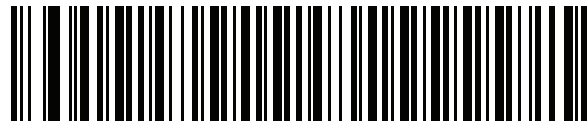

**Country Codes (Continued)****Irish****Italian****Italian (142)****Japanese (ASCII)****Japanese (SHIFT-JIS)\***

\*For CJK keyboard types, see [Appendix D, CKJ Decode Control](#).

**Kazakh****Korean (ASCII)**

## Country Codes (Continued)

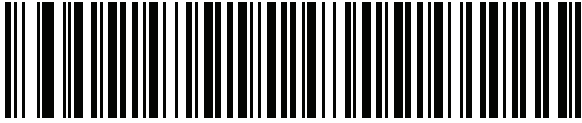

**Korean (Hangul)\***

\*For CJK keyboard types, see [Appendix D, CKJ Decode Control](#).

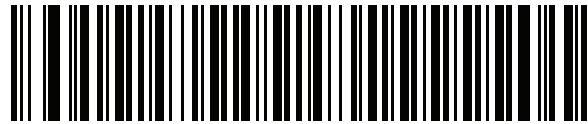

**Kyrgyz**

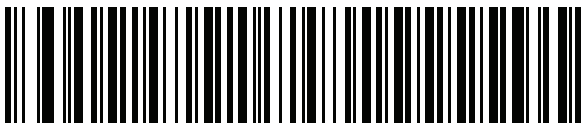

**Latin American**

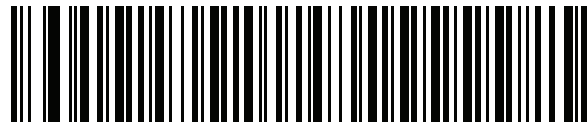

**Latvian**



**Latvian (QWERTY)**



**Lithuanian**



**Lithuanian (IBM)**

### Country Codes (Continued)

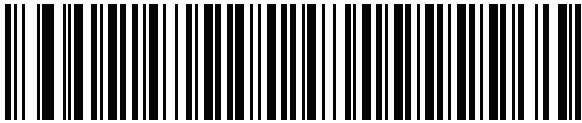

Macedonian (FYROM)



Maltese\_47KEY



Mongolian



Norwegian



Polish (214)



Polish (Programmer)

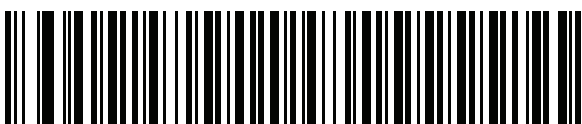

Portuguese (Brazil)  
(Windows XP)

## Country Codes (Continued)

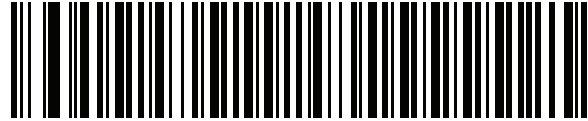

**Portuguese (Brazilian ABNT)**

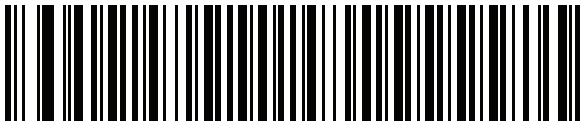

**Portuguese (Brazilian ABNT2)**



**Portuguese (Portugal)**



**Romanian  
(Windows XP)**



**Romanian (Legacy)  
(Win 7 or higher)**



**Romanian (Standard)  
(Win 7 or higher)**

## Country Codes (Continued)

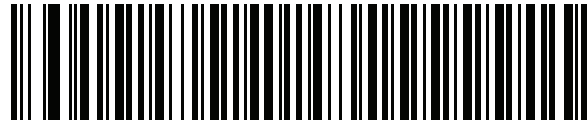

**Romanian (Programmer)  
(Win 7 or higher)**

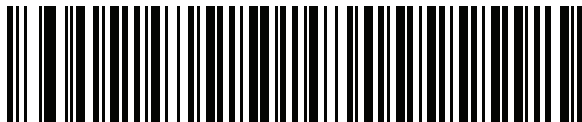

**Russian**



**Russian (Typewriter)**



**Serbian (Latin)**



**Serbian (Cyrillic)**



**Slovak**

**Country Codes (Continued)**

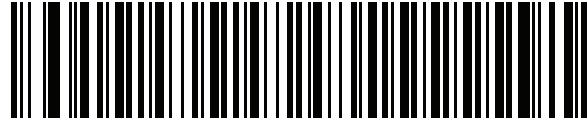

**Slovak (QWERTY)**

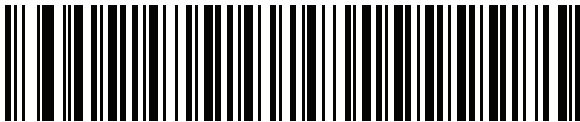

**Slovenian**



**Spanish**



**Spanish (Variation)**



**Swedish**



**Swiss French**



**Swiss German**

### Country Codes (Continued)

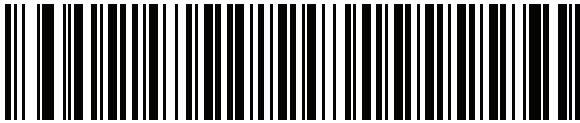

Tatar

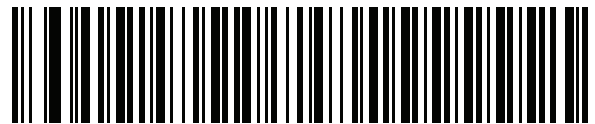

Thai (Kedmanee)

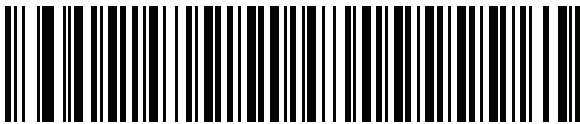

Turkish F



Turkish Q



UK English



Ukrainian



US Dvorak

### Country Codes (Continued)

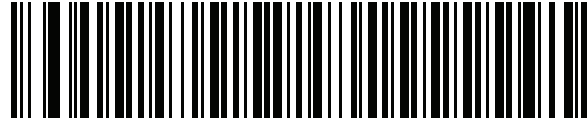

US Dvorak Left

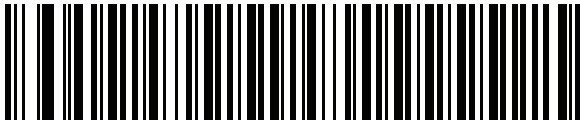

US Dvorak Right

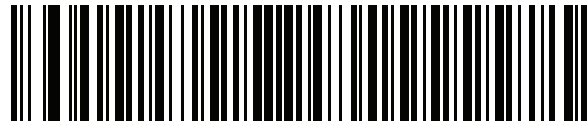

US International



Uzbek



Vietnamese



# APPENDIX C COUNTRY CODE PAGES

---

## Introduction

This chapter provides bar codes for selecting code pages for the country keyboard type selected in [Appendix B, Country Codes](#). If the default code page in [Table C-1](#) is appropriate for your selected country keyboard type, you do not need to scan a country code page bar code.

✓ **NOTE** ADF rules can also specify a code page based on the symbology and other ADF criteria. Refer to the *Advanced Data Formatting Programmer Guide*.

---

## Country Code Page Defaults

[Table C-1](#) lists the code page default for each country keyboard.

**Table C-1** *Country Code Page Defaults*

Country Keyboard	Code Page Default
US English (North American)	Windows 1252
US English (Mac)	Mac CP10000
Albanian	Windows 1250
Arabic 101	Windows 1256
Arabic 102	Windows 1256
Arabic 102 AZERTY	Windows 1256
Azeri Latin	Windows 1254
Azeri Cyrillic	Windows 1251
Belarusian	Windows 1251
Bosnian Latin	Windows 1250

**Table C-1** *Country Code Page Defaults*

<b>Country Keyboard</b>	<b>Code Page Default</b>
Bosnian Cyrillic	Windows 1251
Bulgarian Latin	Windows 1250
Bulgarian Cyrillic	Windows 1251
Canadian French Win7	Windows 1252
Canadian French (Legacy)	Windows 1252
Canadian Multilingual	Windows 1252
Croatian	Windows 1250
Chinese ASCII	Windows 1252
Chinese (Simplified)	Windows 936, GBK
Chinese (Traditional)	Windows 950, Big5
Czech	Windows 1250
Czech Programmers	Windows 1250
Czech QWERTY	Windows 1250
Danish	Windows 1252
Dutch Netherland	Windows 1252
Estonian	Windows 1257
Faeroese	Windows 1252
Finnish	Windows 1252
French (France)	Windows 1252
French (Canada) 95/98	Windows 1252
French (Canada) 2000/XP	Windows 1252
French International (Belgian French)	Windows 1252
Galician	Windows 1252
German	Windows 1252
Greek Latin	Windows 1252
Greek220 Latin	Windows 1253
Greek319 Latin	Windows 1252
Greek	Windows 1253
Greek220	Windows 1253
Greek319	Windows 1253

**Table C-1** Country Code Page Defaults

Country Keyboard	Code Page Default
Greek Polytonic	Windows 1253
Hebrew Israel	Windows 1255
Hungarian	Windows 1250
Hungarian_101KEY	Windows 1250
Icelandic	Windows 1252
Irish	Windows 1252
Italian	Windows 1252
Italian_142	Windows 1252
Japanese ASCII	Windows 1252
Japanese (Shift-JIS)	Windows 932, Shift-JIS
Kazakh	Windows 1251
Korean ASCII	Windows 1252
Korean (Hangul)	Windows 949, Hangul
Kyrgyz Cyrillic	Windows 1251
Latin America	Windows 1252
Latvian	Windows 1257
Latvian QWERTY	Windows 1257
Lithuanian	Windows 1257
Lithuanian_IBM	Windows 1257
Macedonian -FYROM	Windows 1251
Maltese_47KEY	Windows 1252
Mongolian-Cyrillic	Windows 1251
Norwegian	Windows 1252
Polish_214	Windows 1250
Polish Programmer	Windows 1250
Portuguese Brazil	Windows 1252
Portuguese Brazilian ABNT	Windows 1252
Portuguese Brazilian ABNT2	Windows 1252
Portuguese Portugal	Windows 1252
Romanian	Windows 1250

## C - 4 DS8178 Digital Scanner Product Reference Guide

**Table C-1** *Country Code Page Defaults*

<b>Country Keyboard</b>	<b>Code Page Default</b>
Romanian Legacy	Windows 1250
Romanian Standard	Windows 1250
Romanian Programmer	Windows 1250
Russian	Windows 1251
Russian Typewriter	Windows 1251
Serbian Latin	Windows 1250
Serbian Cyrillic	Windows 1251
Slovak	Windows 1250
Slovak QWERTY	Windows 1250
Slovenian	Windows 1250
Spanish	Windows 1252
Spanish Variation	Windows 1252
Swedish	Windows 1252
Swiss French	Windows 1252
Swiss German	Windows 1252
Tatar	Windows 1251
Thai-Kedmanee	Windows 874
Turkish F	Windows 1254
Turkish Q	Windows 1254
Ukrainian	Windows 1251
United Kingdom	Windows 1252
United States	Windows 1252
US Dvorak	Windows 1252
US Dvorak Left Hand	Windows 1252
US Dvorak Right Hand	Windows 1252
US International	Windows 1252
Uzbek Cyrillic	Windows 1251
Vietnamese	Windows 1258

---

## Country Code Page Bar Codes

Scan the bar code corresponding to the country keyboard code page.

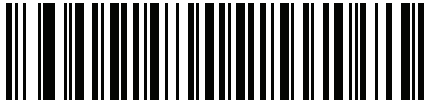

**Windows 1250**  
Latin 2, Central European

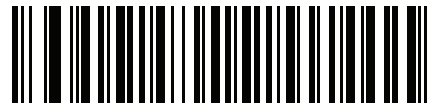

**Windows 1251**  
Cyrillic, Slavic

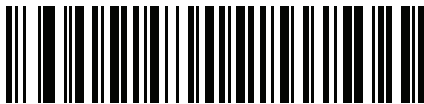

**Windows 1252**  
Latin 1, Western European

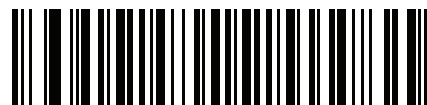

**Windows 1253**  
Greek



**Windows 1254**  
Latin 5, Turkish

## Country Code Pages (Continued)



**Windows 1255  
Hebrew**

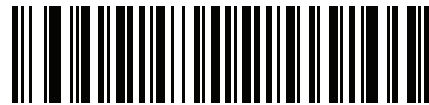

**Windows 1256  
Arabic**

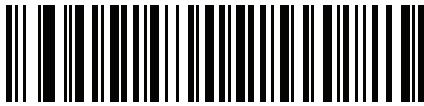

**Windows 1257  
Baltic**

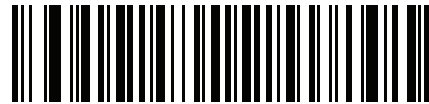

**Windows 1258  
Vietnamese**



**Windows 874  
Thai**

## Country Code Pages (Continued)

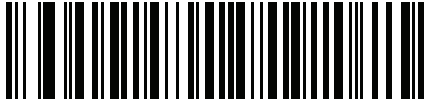

**Windows 20866  
Cyrillic KOI8-R**

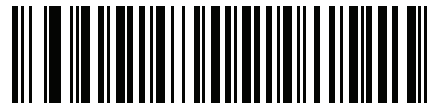

**Windows 932  
Japanese Shift-JIS**

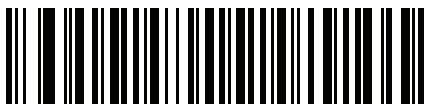

**Windows 936  
Simplified Chinese GBK**

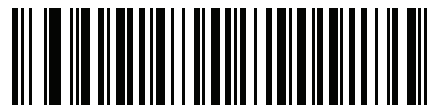

**Windows 54936  
Simplified Chinese GB18030**

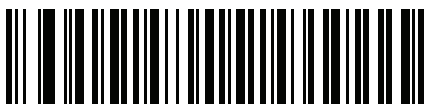

**Windows 949  
Korean Hangul**

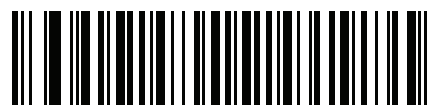

**Windows 950  
Traditional Chinese Big5**

### Country Code Pages (Continued)



**MS-DOS 437**  
Latin US

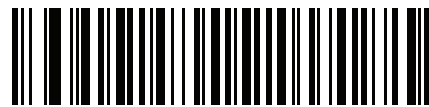

**MS-DOS 737**  
Greek



**MS-DOS 775**  
Baltic

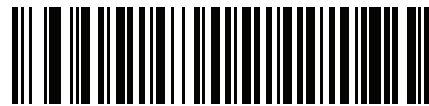

**MS-DOS 850**  
Latin 1

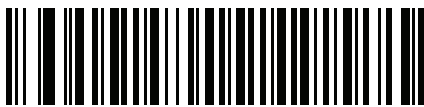

**MS-DOS 852**  
Latin 2



Country Code Pages (Continued)



**MS-DOS 855**  
Cyrillic

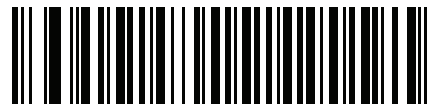

**MS-DOS 857**  
Turkish

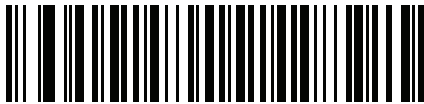

**MS-DOS 860**  
Portuguese

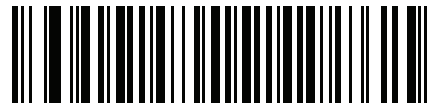

**MS-DOS 861**  
Icelandic

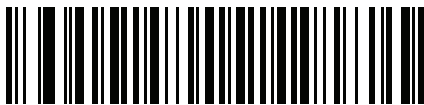

**MS-DOS 862**  
Hebrew

**Country Code Pages (Continued)**



**MS-DOS 863  
French Canada**



**MS-DOS 865  
Nordic**



**MS-DOS 866  
Cyrillic**

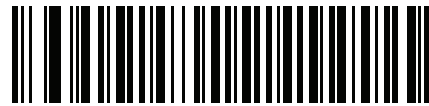

**MS-DOS 869  
Greek 2**

**Country Code Pages (Continued)**

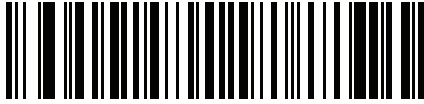

**ISO 8859-1**  
**Latin 1, Western European**

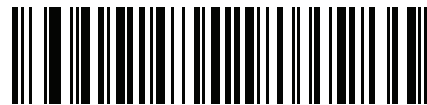

**ISO 8859-2**  
**Latin 2, Central European**



**ISO 8859-3**  
**Latin 3, South European**

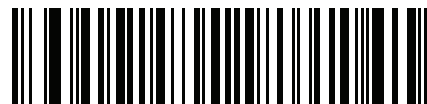

**ISO 8859-4**  
**Latin 4, North European**



**ISO 8859-5**  
**Cyrillic**

## Country Code Pages (Continued)

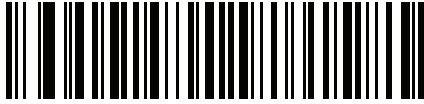

**ISO 8859-6**  
Arabic

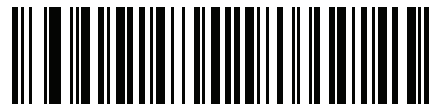

**ISO 8859-7**  
Greek



**ISO 8859-8**  
Hebrew

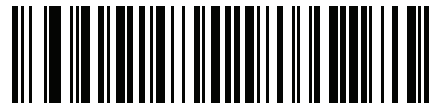

**ISO 8859-9**  
Latin 5, Turkish



**ISO 8859-10**  
Latin 6, Nordic

**Country Code Pages (Continued)**

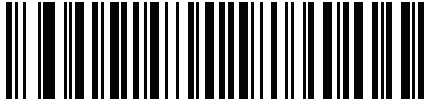

**ISO 8859-11**  
Thai

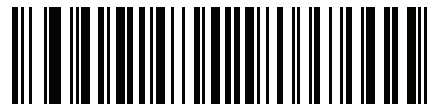

**ISO 8859-13**  
Latin 7, Baltic



**ISO 8859-14**  
Latin 8, Celtic

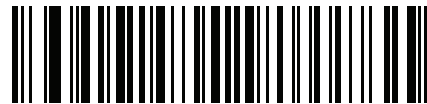

**ISO 8859-15**  
Latin 9



**ISO 8859-16**  
Latin 10, South-Eastern European

**Country Code Pages (Continued)**



**UTF-8**



**UTF-16LE**  
**UTF-16 Little Endian**

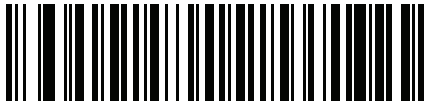

**UTF-16BE**  
**UTF-16 Big Endian**

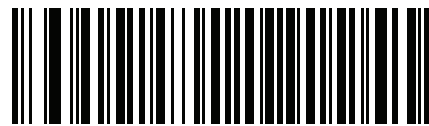

**Mac CP10000**  
**Roman**

# APPENDIX D CKJ DECODE CONTROL

---

## Introduction

This appendix describes control parameters for CJK (Chinese, Japanese, Korean) bar code decode through USB HID Keyboard Emulation mode.

✓ **NOTE** Because ADF does not support CJK character processing, there is no format manipulation for CJK output.

---

## CJK Control Parameters

### Unicode Output Control

#### Parameter # 973

For a Unicode encoded CJK bar code, select one of the following options for unicode output:

- **Universal Output to Unicode and MBCS Application** - This default method applies to Unicode and MBCS expected applications, such as MS Word and Notepad on a Windows host.

✓ **NOTE** To support Unicode universal output, set up the registry table for the Windows host. See [Unicode/CJK Decode Setup with Windows Host on page D-7](#).

- **Output to Unicode Application Only** - This method applies only to Unicode expected applications, such as MS Word and WordPad, but not Notepad.



**\*Universal Output  
(0)**



**Unicode Application Only  
(1)**



## CJK Output Method to Windows Host

### Parameter # 972

For a national standard encoded CJK bar code, select one of the following options for CJK output to a Windows host:

- **Universal CJK Output** - This is the default universal CJK output method for US English IME or Chinese/Japanese/Korean ASCII IME on a Windows host. This method converts CJK characters to Unicode and emulates the characters when transmitting to the host. Use the [Unicode Output Control](#) parameter to control Unicode output.
- ✓ **NOTE** To support universal CJK output, set up the registry table for the Windows host. See [Unicode/CJK Decode Setup with Windows Host on page D-7](#).
- **Other options for CJK output** - With the following methods, the scanner sends the CJK character hexadecimal internal code (Nei Ma) value to host, or converts the CJK character to Unicode and sends the hexadecimal Unicode value to host. When using these methods, the Windows host must select the corresponding IME to accept the CJK character. See [Unicode/CJK Decode Setup with Windows Host on page D-7](#).
    - **Japanese Unicode Output**
    - **Simplified Chinese GBK Code Output**
    - **Simplified Chinese Unicode Output**
    - **Korean Unicode Code Output**
    - **Traditional Chinese Big5 Code Output** (Windows XP)
    - **Traditional Chinese Big5 Code Output** (Windows 7)
    - **Traditional Chinese Unicode Code Output** (Windows XP)
    - **Traditional Chinese Unicode Code Output** (Windows 7)

- ✓ **NOTE** The Unicode emulate output method depends on the host system (Windows XP or Windows 7).



\*Universal CJK Output  
(0)



Japanese Unicode Output  
(34)

(for Japanese Unicode Output, select Simplified Chinese Unicode IME on the Windows host)

## CJK Output Method to Windows Host (continued)



**Chinese (Simplified) GBK Output  
(1)**

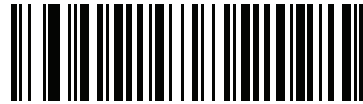

**Chinese (Simplified) Unicode Output  
(2)**



**Korean Unicode Output  
(50)**

(for Korean Unicode Output, select Simplified Chinese Unicode IME on the Windows host)

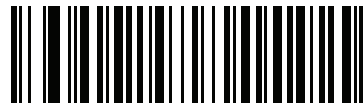

**Chinese (Traditional) Big5 Output (Windows XP)  
(17)**



**Chinese (Traditional) Big5 Output (Windows 7)  
(19)**

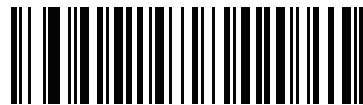

**Chinese (Traditional) Unicode Output (Windows XP)  
(18)**

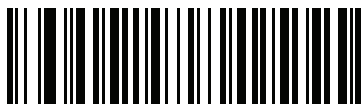

**Chinese (Traditional) Unicode Output (Windows 7)  
(20)**

## Non-CJK UTF Bar Code Output

### Parameter # 960

Some country keyboard type layouts contain characters that do not exist in the default code page (see [Country Keyboard Type Missing Characters on page D-5](#)). Although the default code page can not encode these characters in a bar code, they can be encoded in the UTF-8 bar code. Scan this parameter bar code to output the Unicode values by emulation mode.

- ✓ **NOTE** Use this special country keyboard type to decode the non-CJK UTF-8 bar code. After decoding, re-configure the scanner to use the original country keyboard type.

Use US English IME on Windows. See [Unicode Output Control on page D-2](#).

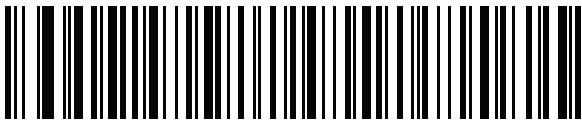

Non-CJK UTF-8 Emulation Output

### Country Keyboard Type Missing Characters

Country keyboard type: **Tatar, Uzbek, Mongolian, Kyrgyz, Kazakh and Azeri**

Default code page: CP1251

Missing characters:

ƒ	F
х	X
к	К
h	Һ
ө	Ө
ә	Ә
Ү	У
ң	Ң
ж	Ж
Ғ	
Һ	Ң
Ү	У
к	К
ч	Ч
к	К

Country keyboard type: **Romanian (Standard)**

Default code page: CP1250

## D - 6 DS8178 Digital Scanner Product Reference Guide

Missing characters:

ş	Ş
ţ	Ț

Country keyboard type: **Portuguese-Brazilian (ABNT), Portuguese-Brazilian (ABNT2)**

Default code page: CP1252

Missing character: **Ç**

Country keyboard type: **Azeri-Latin**

Default code page: CP1254

Missing characters: ə, Ə

---

## Unicode/CJK Decode Setup with Windows Host

This section describes how to set up CJK decode with a Windows host.

### Setting Up the Windows Registry Table for Unicode Universal Output

To support the Unicode universal output method, set up the Windows host registry table as follows:

1. Select **Start > Run > regedt32** to start the registry editor.
2. Under **HKEY\_Current\_User\Control Panel\Input Method**, set **EnableHexNumpad** to **1** as follows:  
[HKEY\_CURRENT\_USER\Control Panel\Input Method]  
"EnableHexNumpad"="1"  
If this key does not exist, add it as type **REG\_SZ** (string value).
3. Reboot the computer to implement the registry change.

### Adding CJK IME on Windows

To add the desired CJK input language:

1. Click **Start > Control Panel**.
2. If the Control Panel opens in category view, select **Switch to Classic View** in the top left corner.
3. Select **Regional and Language Options**.
4. Click the **Language** tab.
5. Under **Supplemental Language Support**, select the **Install Files for East Asian Languages** check box if not already selected, and click **Apply**. This may require a Windows installation CD to install the required files. This step ensures that the East Asian Languages (CJK) are available.
6. Under **Text Services and Input Language**, click **Details**.
7. Under **Installed Services**, click **Add**.
8. In the **Add Input Language** dialog box, choose the CJK input language and keyboard layout or Input Method Editor (IME) to add.
9. Click **OK** twice. The language indicator appears in the system tray (at bottom right corner of the desktop by default). To switch between input languages (keyboard languages) select the language indicator in the system tray.
10. Select the language indicator in the system tray to select the desired country keyboard type.
11. Verify that the characters displayed on each country's keyboard appear.

## Selecting the Simplified Chinese Input Method on the Host

To select the Simplified Chinese input method:

- Select Unicode/GBK input on Windows XP: **Chinese (Simplified) - NeiMa**, then click the input bar to select **Unicode** or **GBK NeiMa** input.

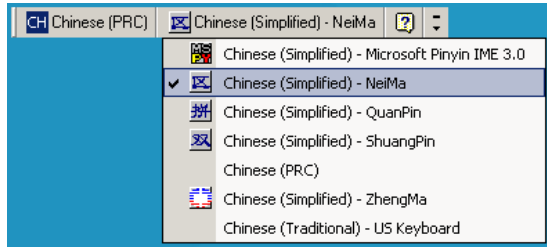

Or



- Select Unicode/GBK input on Windows7: **Chinese (Simplified) - Microsoft Pinyin New Experience Input Style**, then select **Tool Menu > Secondary Inputs > Unicode Input** or **GB Code Input**.

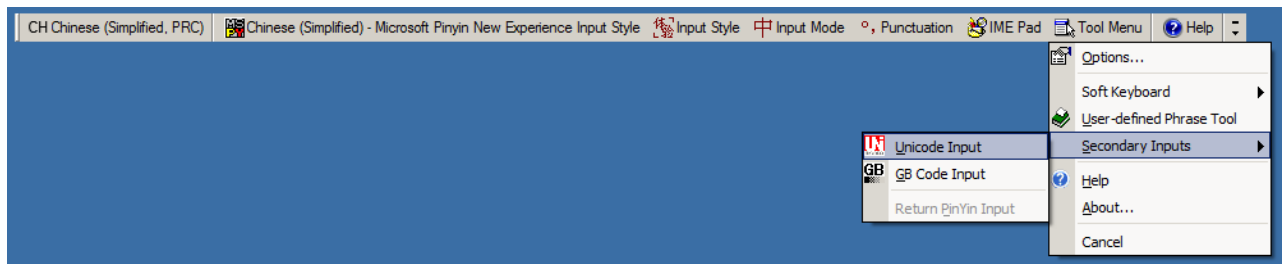

## Selecting the Traditional Chinese Input Method on the Host

To select the Traditional Chinese input method:

- Select Unicode input on Windows XP: **Chinese (Traditional) - Unicode**

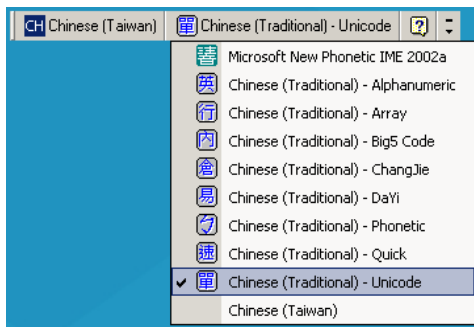

- Select Big5 input on Windows XP: **Chinese (Traditional) - Big5 Code**

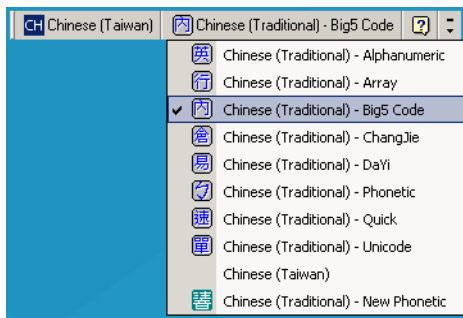

- Select Unicode/Big5 input on Windows 7: **Chinese (Traditional) - New Quick**. This option support both Unicode and Big5 input.







# APPENDIX E PROGRAMMING REFERENCE

---

## Symbol Code Identifiers

**Table E-1** *Symbol Code Characters*

Code Character	Code Type
A	UPC-A, UPC-E, UPC-E1, EAN-8, EAN-13
B	Code 39, Code 32
C	Codabar
D	Code 128, ISBT 128, ISBT 128 Concatenated
E	Code 93
F	Interleaved 2 of 5
G	Discrete 2 of 5, or Discrete 2 of 5 IATA
H	Code 11
J	MSI
K	GS1-128
L	Bookland EAN
M	Trioptic Code 39
N	Coupon Code
R	GS1 DataBar Family
S	Matrix 2 of 5
T	UCC Composite, TLC 39
U	Chinese 2 of 5

**Table E-1** *Symbol Code Characters (Continued)*

<b>Code Character</b>	<b>Code Type</b>
V	Korean 3 of 5
X	ISSN EAN, PDF417, Macro PDF417, Micro PDF417
z	Aztec, Aztec Rune
P00	Data Matrix
P01	QR Code, MicroQR
P02	Maxicode
P03	US Postnet
P04	US Planet
P05	Japan Postal
P06	UK Postal
P08	Netherlands KIX Code
P09	Australia Post
P0A	USPS 4CB/One Code/Intelligent Mail
P0B	UPU FICS Postal
P0C	Mailmark
P0G	GS1 DM
P0H	Han Xin
P0Q	GS1 QR
P0X	Signature Capture

## AIM Code Identifiers

Each AIM Code Identifier contains the three-character string **Jcm** where:

- J = Flag Character (ASCII 93)
- c = Code Character (see [Table E-2](#))
- m = Modifier Character (see [Table E-3](#))

**Table E-2** *Aim Code Characters*

Code Character	Code Type
A	Code 39, Code 39 Full ASCII, Code 32
C	Code 128, ISBT 128, ISBT 128 Concatenated, GS1-128, Coupon (Code 128 portion)
d	Data Matrix
d2	GS1 Data Matrix
E	UPC/EAN, Coupon (UPC portion)
e	GS1 DataBar Family
F	Codabar
G	Code 93
H	Code 11
h	Han Xin
I	Interleaved 2 of 5
L	PDF417, Macro PDF417, Micro PDF417
L2	TLC 39
M	MSI
Q	QR Code, MicroQR
Q3	GS1 QR
S	Discrete 2 of 5, IATA 2 of 5
U	Maxicode
z	Aztec, Aztec Rune
X	Bookland EAN, ISSN EAN, Trioptic Code 39, Chinese 2 of 5, Matrix 2 of 5, Korean 3 of 5, US Postnet, US Planet, UK Postal, Japan Postal, Australia Post, Netherlands KIX Code, USPS 4CB/One Code/ Intelligent Mail, UPU FICS Postal, Signature Capture
X0	Mailmark

## E - 4 DS8178 Digital Scanner Product Reference Guide

The modifier character is the sum of the applicable option values based on [Table E-3](#).

**Table E-3** *Modifier Characters*

Code Type	Option Value	Option
<b>Code 39</b>	0	No check character or Full ASCII processing.
	1	Reader has checked one check character.
	3	Reader has checked and stripped check character.
	4	Reader has performed Full ASCII character conversion.
	5	Reader has performed Full ASCII character conversion and checked one check character.
	7	Reader has performed Full ASCII character conversion and checked and stripped check character.
	Example: A Full ASCII bar code with check character W, <b>A+I+MI+DW</b> , is transmitted as <b>J</b> A7AIMID where 7 = (3+4).	
<b>Trioptic Code 39</b>	0	No option specified at this time. Always transmit 0.
	Example: A Trioptic bar code 412356 is transmitted as <b>J</b> X0412356	
<b>Code 128</b>	0	Standard data packet, no Function code 1 in first symbol position.
	1	Function code 1 in first symbol character position.
	2	Function code 1 in second symbol character position.
	Example: A Code (EAN) 128 bar code with Function 1 character <sup>FNC1</sup> in the first position, AIMID is transmitted as <b>J</b> C1AIMID	
<b>I 2 of 5</b>	0	No check digit processing.
	1	Reader has validated check digit.
	3	Reader has validated and stripped check digit.
	Example: An I 2 of 5 bar code without check digit, 4123, is transmitted as <b>J</b> I04123	
<b>Codabar</b>	0	No check digit processing.
	1	Reader has checked check digit.
	3	Reader has stripped check digit before transmission.
	Example: A Codabar bar code without check digit, 4123, is transmitted as <b>J</b> F04123	
<b>Code 93</b>	0	No options specified at this time. Always transmit 0.
	Example: A Code 93 bar code 012345678905 is transmitted as <b>J</b> G0012345678905	
<b>MSI</b>	0	Check digits are sent.
	1	No check digit is sent.
	Example: An MSI bar code 4123, with a single check digit checked, is transmitted as <b>J</b> M14123	

Table E-3 *Modifier Characters (Continued)*

Code Type	Option Value	Option
<b>D 2 of 5</b>	0	No options specified at this time. Always transmit 0.
	Example: A D 2 of 5 bar code 4123, is transmitted as <b>JS04123</b>	
<b>UPC/EAN</b>	0	Standard data packet in full EAN format, i.e. 13 digits for UPC-A, UPC-E, and EAN-13 (not including supplemental data).
	1	Two digit supplemental data only.
	2	Five digit supplemental data only.
	3	Combined data packet comprising 13 digits from EAN-13, UPC-A or UPC-E symbol and 2 or 5 digits from supplemental symbol.
	4	EAN-8 data packet.
Example: A UPC-A bar code 012345678905 is transmitted as <b>JE00012345678905</b>		
<b>Bookland EAN</b>	0	No options specified at this time. Always transmit 0.
	Example: A Bookland EAN bar code 123456789X is transmitted as <b>JX0123456789X</b>	
<b>ISSN EAN</b>	0	No options specified at this time. Always transmit 0.
	Example: An ISSN EAN bar code 123456789X is transmitted as <b>JX0123456789X</b>	
<b>Code 11</b>	0	Single check digit
	1	Two check digits
	3	Check characters validated but not transmitted.
<b>GS1 DataBar Family</b>		No option specified at this time. Always transmit 0. GS1 DataBar-14 and GS1 DataBar Limited transmit with an Application Identifier "01". Note: In GS1-128 emulation mode, GS1 DataBar is transmitted using Code 128 rules (i.e., J1C1).
	Example: A GS1 DataBar-14 bar code 0110012345678902 is transmitted as <b>Je00110012345678902</b> .	

Table E-3 *Modifier Characters (Continued)*

Code Type	Option Value	Option
<b>EAN.UCC Composites (GS1 DataBar, GS1-128, 2D portion of UPC composite)</b>		Native mode transmission. Note: UPC portion of composite is transmitted using UPC rules.
	0	Standard data packet.
	1	Data packet containing the data following an encoded symbol separator character.
	2	Data packet containing the data following an escape mechanism character. The data packet does not support the ECI protocol.
	3	Data packet containing the data following an escape mechanism character. The data packet supports the ECI protocol.
		GS1-128 emulation Note: UPC portion of composite is transmitted using UPC rules.
	1	Data packet is a GS1-128 symbol (i.e., data is preceded with ]JC1).
<b>PDF417, Micro PDF417</b>	0	Reader set to conform to protocol defined in 1994 PDF417 symbology specifications. <b>Note:</b> When this option is transmitted, the receiver cannot reliably determine whether ECIs have been invoked or whether data byte 92 <sub>DEC</sub> has been doubled in transmission.
	1	Reader set to follow the ECI protocol (Extended Channel Interpretation). All data characters 92 <sub>DEC</sub> are doubled.
	2	Reader set for Basic Channel operation (no escape character transmission protocol). Data characters 92 <sub>DEC</sub> are not doubled. <b>Note:</b> When decoders are set to this mode, unbuffered Macro symbols and symbols requiring the decoder to convey ECI escape sequences cannot be transmitted.
	3	The bar code contains a GS1-128 symbol, and the first codeword is 903-907, 912, 914, 915.
	4	The bar code contains a GS1-128 symbol, and the first codeword is in the range 908-909.
	5	The bar code contains a GS1-128 symbol, and the first codeword is in the range 910-911.

Table E-3 *Modifier Characters (Continued)*

Code Type	Option Value	Option
<b>Data Matrix</b>	0	ECC 000-140, not supported.
	1	ECC 200.
	2	ECC 200, FNC1 in first or fifth position.
	3	ECC 200, FNC1 in second or sixth position.
	4	ECC 200, ECI protocol implemented.
	5	ECC 200, FNC1 in first or fifth position, ECI protocol implemented.
	6	ECC 200, FNC1 in second or sixth position, ECI protocol implemented.
<b>MaxiCode</b>	0	Symbol in Mode 4 or 5.
	1	Symbol in Mode 2 or 3.
	2	Symbol in Mode 4 or 5, ECI protocol implemented.
	3	Symbol in Mode 2 or 3, ECI protocol implemented in secondary message.
<b>QR Code</b>	0	Model 1 symbol.
	1	Model 2 / MicroQR symbol, ECI protocol not implemented.
	2	Model 2 symbol, ECI protocol implemented.
	3	Model 2 symbol, ECI protocol not implemented, FNC1 implied in first position.
	4	Model 2 symbol, ECI protocol implemented, FNC1 implied in first position.
	5	Model 2 symbol, ECI protocol not implemented, FNC1 implied in second position.
	6	Model 2 symbol, ECI protocol implemented, FNC1 implied in second position.
<b>Aztec</b>	0	Aztec symbol.
	C	Aztec Rune symbol.
<b>Han Xin</b>	0	Generic data, no special features are set. The transmitted data does not follow the AIM ECI protocol.
	1	ECI protocol enabled. There is at least one ECI mode encoded. Transmitted data must follow the AIM ECI protocol.





# APPENDIX F SAMPLE BAR CODES

---

## Code 39



---

## Code 93

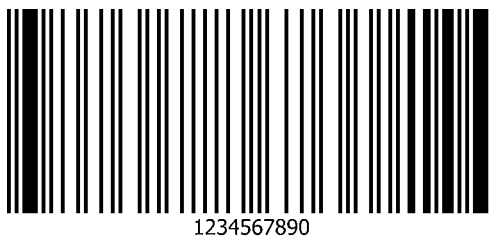

---

## UPC/EAN

UPC-A, 100%

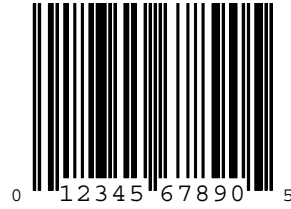

UPC-E

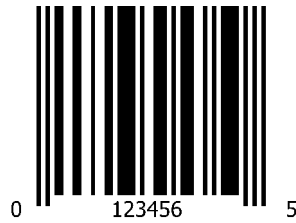

EAN-8



---

**UPC/EAN (continued)**

**EAN-13, 100%**



---

**Code 128**



---

**Interleaved 2 of 5**



---

## GS1 DataBar

### GS1 DataBar-14

✓ **NOTE** DataBar-14 must be enabled to read the bar code below (see [GS1 DataBar-14 on page 12-62](#)).



7612341562341

### GS1 DataBar Omnidirectional

✓ **NOTE** DataBar Omnidirectional must be enabled to read the bar code below (see [GS1 DataBar on page 12-62](#)).



0176123415623411

### GS1 DataBar Expanded

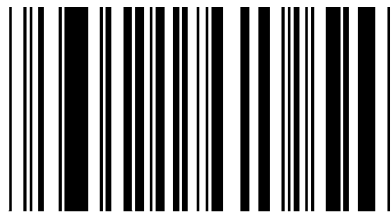

(01)12345678901231

---

## GS1 DataBar (continued)

GS1 DataBar Limited

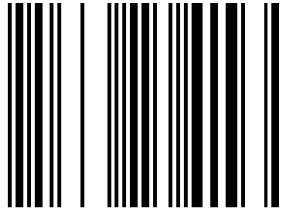

(01)00012345678905

---

## PDF417

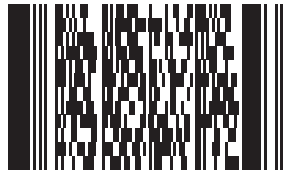

---

## Data Matrix



123456789abcdefghijklmnopqrstuvwxyz

---

## Maxicode

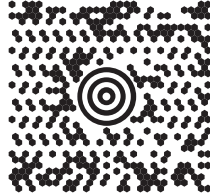

---

## QR Code



0123456789ABCDEFGHIJKLMNOPQRSTUVWXYZ0123456789ABCDEFGHIJKLMNOPQRSTUVWXYZ0123456789

---

## US Postnet



---

**UK Postal**



---

**Interleaved 2 of 5**



---

**PDF417**



12345678910abcdefghijklmnopqrstuvwxy

---

**Aztec**



0123456789ABCDEFGHIJKLMNOPQRSTUVWXYZ0123456789ABCDEFGHIJKLMNOPQRSTUVWXYZ0123456789012345  
6789ABCDEFGHIJKLMNOPQRSTUVWXYZ0123456789ABCDEFGHIJKLMNOPQRSTUVWXYZ0123456789



# APPENDIX G NUMERIC BAR CODES

---

## Numeric Bar Codes

For parameters requiring specific numeric values, scan the appropriately numbered bar code(s).



## Numeric Bar Codes (continued)



5



6



7



8



9

# APPENDIX H ALPHANUMERIC BAR CODES

---

## Cancel

To correct an error or change a selection, scan the bar code below.



Cancel

---

## Alphanumeric Bar Codes

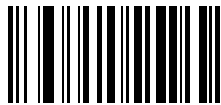

Space



#



\$

## Alphanumeric Bar Codes (continued)



\*



%



+



-

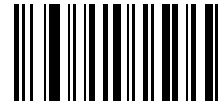

.



/

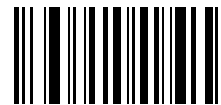

!

## Alphanumeric Bar Codes (continued)



“



&

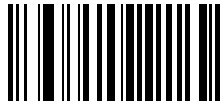

’



(

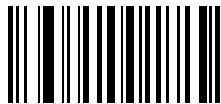

)

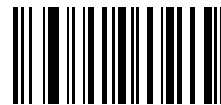

:

## Alphanumeric Bar Codes (continued)

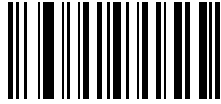

;

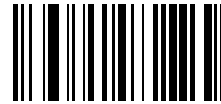

<



=

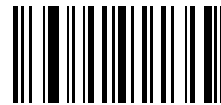

>



?

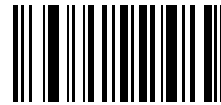

@

## Alphanumeric Bar Codes (continued)



[

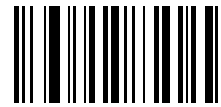

\

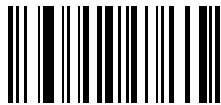

]



^

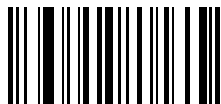

\_

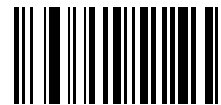

~

## Alphanumeric Bar Codes (continued)



**NOTE** The bar codes that follow should not be confused with those on the numeric keypad.

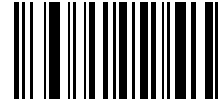

0



1



2



3

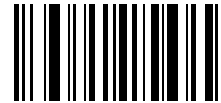

4

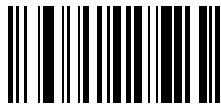

5



## Alphanumeric Bar Codes (continued)

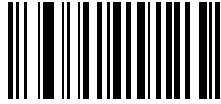

6

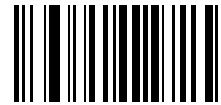

7



8

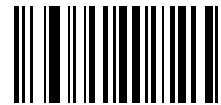

9



End of Message



Cancel

## Alphanumeric Bar Codes (continued)

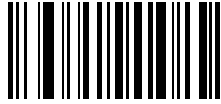

A



B



C

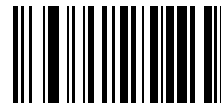

D

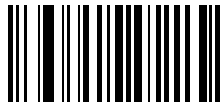

E

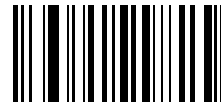

F

## Alphanumeric Bar Codes (continued)



G

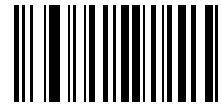

H



I

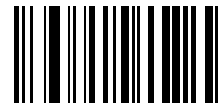

J

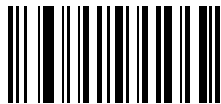

K



L

## Alphanumeric Bar Codes (continued)



M



N

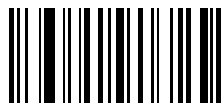

O



P



Q



R

## Alphanumeric Bar Codes (continued)



S

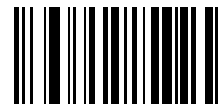

T

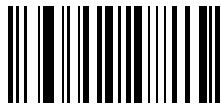

U



V



W



X

## Alphanumeric Bar Codes (continued)



Y



Z

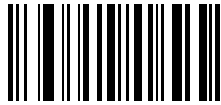

a



b

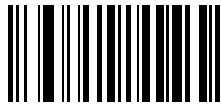

c

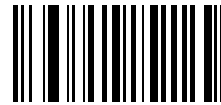

d

## Alphanumeric Bar Codes (continued)



e



f

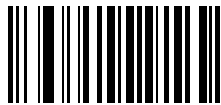

g



h



i

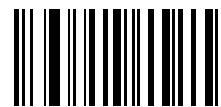

j

## Alphanumeric Bar Codes (continued)



k



l



m

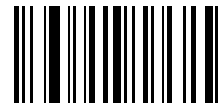

n



o



p



## Alphanumeric Bar Codes (continued)



q



r

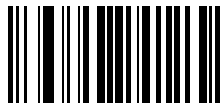

s

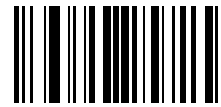

t



u

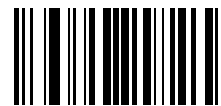

v

## Alphanumeric Bar Codes (continued)

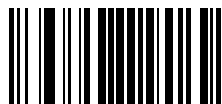

w



x



y



z



{



|

---

## Alphanumeric Bar Codes (continued)

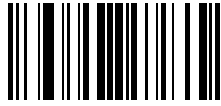

}

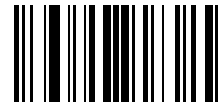

~



# APPENDIX I ASCII CHARACTER SETS

✓ **NOTE** For the Keyboard Wedge Interface, Code 39 Full ASCII interprets the bar code special character (\$ + % /) preceding a Code 39 character and assigns an ASCII character value to the pair. For example, if you enable Code 39 Full ASCII and scan **+B**, it transmits as **b, %J** as **?**, and **%V** as **@**. Scanning **ABC%I** outputs the keystroke equivalent of **ABC >**.

**Table I-1** ASCII Character Set

ASCII Value (Prefix/Suffix Value for RS-232)	Full ASCII Code 39 Encode Char	Keystroke	ASCII Character (Applies to RS-232 Only)
1000	%U	CTRL 2	NUL
1001	\$A	CTRL A	SOH
1002	\$B	CTRL B	STX
1003	\$C	CTRL C	ETX
1004	\$D	CTRL D	EOT
1005	\$E	CTRL E	ENQ
1006	\$F	CTRL F	ACK
1007	\$G	CTRL G	BELL
1008	\$H	CTRL H/ <b>BACKSPACE</b> <sup>1</sup>	BCKSPC
1009	\$I	CTRL I/ <b>HORIZONTAL TAB</b> <sup>1</sup>	HORIZ TAB
1010	\$J	CTRL J	LF/NW LN
1011	\$K	CTRL K	VT
1012	\$L	CTRL L	FF

The keystroke in bold transmits only if you enabled Function Key Mapping. Otherwise, the unbold keystroke transmits.

Table I-1 ASCII Character Set (Continued)

ASCII Value (Prefix/Suffix Value for RS-232)	Full ASCII Code 39 Encode Char	Keystroke	ASCII Character (Applies to RS-232 Only)
1013	\$M	CTRL M/ENTER <sup>1</sup>	CR/ENTER
1014	\$N	CTRL N	SO
1015	\$O	CTRL O	SI
1016	\$P	CTRL P	DLE
1017	\$Q	CTRL Q	DC1/XON
1018	\$R	CTRL R	DC2
1019	\$S	CTRL S	DC3/XOFF
1020	\$T	CTRL T	DC4
1021	\$U	CTRL U	NAK
1022	\$V	CTRL V	SYN
1023	\$W	CTRL W	ETB
1024	\$X	CTRL X	CAN
1025	\$Y	CTRL Y	EM
1026	\$Z	CTRL Z	SUB
1027	%A	CTRL [	ESC
1028	%B	CTRL \	FS
1029	%C	CTRL ]	GS
1030	%D	CTRL 6	RS
1031	%E	CTRL -	US
1032	Space	Space	Space
1033	/A	!	!
1034	/B	"	"
1035	/C	#	#
1036	/D	\$	\$
1037	/E	%	%
1038	/F	&	&
1039	/G	'	'

The keystroke in bold transmits only if you enabled Function Key Mapping. Otherwise, the unbold keystroke transmits.

Table I-1 ASCII Character Set (Continued)

ASCII Value (Prefix/Suffix Value for RS-232)	Full ASCII Code 39 Encode Char	Keystroke	ASCII Character (Applies to RS-232 Only)
1040	/H	(	(
1041	/I	)	)
1042	/J	*	*
1043	/K	+	+
1044	/L	,	,
1045	-	-	-
1046	.	.	.
1047	/o	/	/
1048	0	0	0
1049	1	1	1
1050	2	2	2
1051	3	3	3
1052	4	4	4
1053	5	5	5
1054	6	6	6
1055	7	7	7
1056	8	8	8
1057	9	9	9
1058	/Z	:	:
1059	%F	;	;
1060	%G	<	<
1061	%H	=	=
1062	%I	>	>
1063	%J	?	?
1064	%V	@	@
1065	A	A	A
1066	B	B	B

The keystroke in bold transmits only if you enabled Function Key Mapping. Otherwise, the unbold keystroke transmits.

Table I-1 ASCII Character Set (Continued)

ASCII Value (Prefix/Suffix Value for RS-232)	Full ASCII Code 39 Encode Char	Keystroke	ASCII Character (Applies to RS-232 Only)
1067	C	C	C
1068	D	D	D
1069	E	E	E
1070	F	F	F
1071	G	G	G
1072	H	H	H
1073	I	I	I
1074	J	J	J
1075	K	K	K
1076	L	L	L
1077	M	M	M
1078	N	N	N
1079	O	O	O
1080	P	P	P
1081	Q	Q	Q
1082	R	R	R
1083	S	S	S
1084	T	T	T
1085	U	U	U
1086	V	V	V
1087	W	W	W
1088	X	X	X
1089	Y	Y	Y
1090	Z	Z	Z
1091	%K	[	[
1092	%L	\	\
1093	%M	]	]

The keystroke in bold transmits only if you enabled Function Key Mapping. Otherwise, the unbold keystroke transmits.



Table I-1 ASCII Character Set (Continued)

ASCII Value (Prefix/Suffix Value for RS-232)	Full ASCII Code 39 Encode Char	Keystroke	ASCII Character (Applies to RS-232 Only)
1094	%N	^	^
1095	%O	_	_
1096	%W	`	`
1097	+A	a	a
1098	+B	b	b
1099	+C	c	c
1100	+D	d	d
1101	+E	e	e
1102	+F	f	f
1103	+G	g	g
1104	+H	h	h
1105	+I	i	i
1106	+J	j	j
1107	+K	k	k
1108	+L	l	l
1109	+M	m	m
1110	+N	n	n
1111	+O	o	o
1112	+P	p	p
1113	+Q	q	q
1114	+R	r	r
1115	+S	s	s
1116	+T	t	t
1117	+U	u	u
1118	+V	v	v
1119	+W	w	w
1120	+X	x	x

The keystroke in bold transmits only if you enabled Function Key Mapping. Otherwise, the unbold keystroke transmits.

**Table I-1** ASCII Character Set (Continued)

ASCII Value (Prefix/Suffix Value for RS-232)	Full ASCII Code 39 Encode Char	Keystroke	ASCII Character (Applies to RS-232 Only)
1121	+Y	<b>y</b>	y
1122	+Z	<b>z</b>	z
1123	%P	<b>{</b>	{
1124	%Q	<b> </b>	
1125	%R	<b>}</b>	}
1126	%S	<b>~</b>	~
1127			Undefined
7013			ENTER

The keystroke in bold transmits only if you enabled Function Key Mapping. Otherwise, the unbold keystroke transmits.

**Table I-2** ALT Key Character Set

ALT Keys	Keystroke
2064	ALT 2
2065	ALT A
2066	ALT B
2067	ALT C
2068	ALT D
2069	ALT E
2070	ALT F
2071	ALT G
2072	ALT H
2073	ALT I
2074	ALT J
2075	ALT K
2076	ALT L
2077	ALT M
2078	ALT N

**Table I-2** ALT Key Character Set (Continued)

ALT Keys	Keystroke
2079	ALT O
2080	ALT P
2081	ALT Q
2082	ALT R
2083	ALT S
2084	ALT T
2085	ALT U
2086	ALT V
2087	ALT W
2088	ALT X
2089	ALT Y
2090	ALT Z

**Table I-3** GUI Key Character Set

GUI Key	Keystroke
3000	Right Control Key
3048	GUI 0
3049	GUI 1
3050	GUI 2
3051	GUI 3
3052	GUI 4
3053	GUI 5
3054	GUI 6
3055	GUI 7
3056	GUI 8
3057	GUI 9
3065	GUI A

**Note: GUI Shift Keys - The Apple™ iMac keyboard has an apple key on either side of the space bar. Windows-based systems have a GUI key to the left of the left ALT key, and to the right of the right ALT key.**

**Table I-3** GUI Key Character Set (Continued)

GUI Key	Keystroke
3066	GUI B
3067	GUI C
3068	GUI D
3069	GUI E
3070	GUI F
3071	GUI G
3072	GUI H
3073	GUI I
3074	GUI J
3075	GUI K
3076	GUI L
3077	GUI M
3078	GUI N
3079	GUI O
3080	GUI P
3081	GUI Q
3082	GUI R
3083	GUI S
3084	GUI T
3085	GUI U
3086	GUI V
3087	GUI W
3088	GUI X
3089	GUI Y
3090	GUI Z

**Note:** GUI Shift Keys - The Apple™ iMac keyboard has an apple key on either side of the space bar. Windows-based systems have a GUI key to the left of the left ALT key, and to the right of the right ALT key.

**Table I-4** *PF Key Character Set*

<b>PF Keys</b>	<b>Keystroke</b>
4001	PF 1
4002	PF 2
4003	PF 3
4004	PF 4
4005	PF 5
4006	PF 6
4007	PF 7
4008	PF 8
4009	PF 9
4010	PF 10
4011	PF 11
4012	PF 12
4013	PF 13
4014	PF 14
4015	PF 15
4016	PF 16

**Table I-5** *F key Character Set*

<b>F Keys</b>	<b>Keystroke</b>
5001	F 1
5002	F 2
5003	F 3
5004	F 4
5005	F 5
5006	F 6
5007	F 7
5008	F 8
5009	F 9
5010	F 10
5011	F 11
5012	F 12
5013	F 13
5014	F 14
5015	F 15
5016	F 16
5017	F 17
5018	F 18
5019	F 19
5020	F 20
5021	F 21
5022	F 22
5023	F 23
5024	F 24

**Table I-6** *Numeric Key Character Set*

<b>Numeric Keypad</b>	<b>Keystroke</b>
6042	*
6043	+
6044	Undefined
6045	-
6046	.
6047	/
6048	0
6049	1
6050	2
6051	3
6052	4
6053	5
6054	6
6055	7
6056	8
6057	9
6058	Enter
6059	Num Lock

**Table I-7** *Extended Key Character Set*

<b>Extended Keypad</b>	<b>Keystroke</b>
7001	Break
7002	Delete
7003	Pg Up
7004	End
7005	Pg Dn
7006	Pause
7007	Scroll Lock
7008	Backspace
7009	Tab
7010	Print Screen
7011	Insert
7012	Home
7013	Enter
7014	Escape
7015	Up Arrow
7016	Dn Arrow
7017	Left Arrow
7018	Right Arrow



# APPENDIX J COMMUNICATION PROTOCOL FUNCTIONALITY

## Functionality Supported via Communication (Cable) Interface

[Table J-1](#) lists supported scanner functionality by communication protocol.

**Table J-1** Communication Interface Functionality

Communication Interfaces	Functionality		
	Data Transmission	Remote Management	Image and Video Transmission
<b>USB</b>			
HID Keyboard Emulation	Supported	Not Available	Not Available
Simple COM Port Emulation	Supported	Not Available	Not Available
CDC COM Port Emulation	Supported	Not Available	Not Available
SSI over CDC COM Port Emulation	Supported	Supported	Supported
IBM Table-Top USB	Supported	Supported	Not Available
IBM Hand-Held USB	Supported	Supported	Not Available
USB OPOS Hand-Held	Supported	Supported	Not Available
Symbol Native API (SNAPI) without Imaging Interface	Supported	Supported	Not Available
Symbol Native API (SNAPI) with Imaging Interface	Supported	Supported	Supported
<b>RS-232</b>			
Standard RS-232	Supported	Not Available	Not Available
ICL RS-232	Supported	Not Available	Not Available
Fujitsu RS-232	Supported	Not Available	Not Available
Wincor-Nixdorf RS-232 Mode A	Supported	Not Available	Not Available

**Table J-1** *Communication Interface Functionality (Continued)*

Communication Interfaces	Functionality		
	Data Transmission	Remote Management	Image and Video Transmission
Wincor-Nixdorf RS-232 Mode B	Supported	Not Available	Not Available
Olivetti ORS4500	Supported	Not Available	Not Available
Omron	Supported	Not Available	Not Available
CUTE	Supported	Not Available	Not Available
OPOS/JPOS	Supported	Not Available	Not Available
SSI	Supported	Supported	Supported
<b>IBM 4690</b>			
Hand-Held Scanner Emulation (Port 9B)	Supported	Not Available	Not Available
Table-Top Scanner Emulation (Port 17)	Supported	Supported	Not Available
Non-IBM Scanner Emulation (Port 5B)	Supported	Supported	Not Available
<b>Keyboard Wedge</b>			
IBM PC/AT & IBM PC Compatibles	Supported	Not Available	Not Available
IBM AT Notebook	Supported	Not Available	Not Available

## Functionality Supported via Radio Communication

**Table J-2** *Communication Interface Functionality*

Communication Interfaces	Scanner Functionality
Simple Serial Interface (SSI)	SSI BT Classic (Non-discoverable) SSI BT Classic (Discoverable) SSI BT Low Energy SSI BT with MFi (iOS Support)
HID (Keyboard Emulation)	HID BT Classic HID BT LE (Discoverable)
Serial Port Profile (SPP)	SPP BT Classic (Non-discoverable) SPP BT Classic (Discoverable)

# APPENDIX K SIGNATURE CAPTURE CODE

---

## Introduction

CapCode, a signature capture code, is a special pattern that encloses a signature area on a document and allows a scanner to capture a signature.

There are several accepted patterns that allow automatic identification of different signatures on the same form. For example, on the federal tax return 1040 form there are three signature areas, one each for two joint filers, and one for a professional preparer. By using different patterns, a program can correctly identify all three, so they can be captured in any sequence and still be identified correctly.

---

## Code Structure

### Signature Capture Area

A CapCode is printed as two identical patterns on either side of a signature capture box, as shown in [Figure K-1](#). Each pattern extends the full height of the signature capture box.

The box is optional, so you can omit it, replace it with a single baseline, or print a baseline with an "X" on top of it towards the left, as is customarily done in the US to indicate a request for signature. However, if an "X" or other markings are added in the signature box area, these are captured with the signature.



Figure K-1 *CapCode*

## CapCode Pattern Structure

A CapCode pattern structure consists of a start pattern followed by a separator space, a signature capture box, a second separator space, and then a stop pattern. Assuming that  $X$  is the dimension of the thinnest element, the start and stop patterns each contains  $9X$  total width in 4 bars and 3 spaces. A  $7X$  quiet zone is required to the left and to the right of the CapCode pattern.

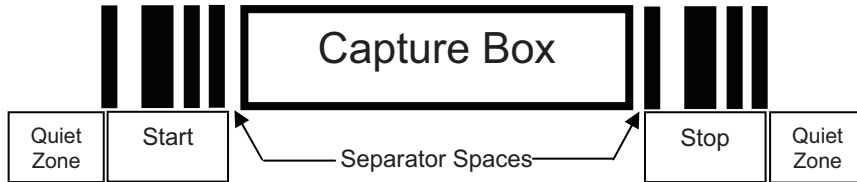

**Figure K-2** CapCode Structure

The separator spaces on either side of the signature capture box can be between  $1X$  and  $3X$  wide.

## Start / Stop Patterns

Table K-1 lists the accepted start / stop patterns. The bar and space widths are expressed as multiples of  $X$ . You must use the same pattern on either side of a signature capture box. The type value is reported with the captured signature to indicate the purpose of the signature captured.

**Table K-1** Start / Stop Pattern Definitions

Bar/Space Patterns							Type
B	S	B	S	B	S	B	
1	1	2	2	1	1	1	2
1	2	2	1	1	1	1	5
2	1	1	2	1	1	1	7
2	2	1	1	1	1	1	8
3	1	1	1	1	1	1	9

[Table K-2](#) lists selectable parameters used to generate the image of the captured signature.

**Table K-2** *User Defined CapCode Parameters*

Parameter	Defined
Width	Number of pixels
Height	Number of pixels
Format	JPEG, BMP, TIFF
JPEG quality	1 (most compression) to 100 (best quality)
Bits Per Pixel (not applicable to JPEG format)	1 (2 levels)
	4 (16 levels)
	8 (256 levels)

BMP format does not use compression, JPEG and TIFF formats do.

---

## Dimensions

The size of the signature capture box is determined by the height and separation of the start and stop patterns. The line width of the signature capture box is insignificant.

The thinnest element width, referred to here as X, is nominally 10 mils (1 mil = 0.0254 mm). Select this as an exact multiple of the pixel pitch of the printer used. For example, when using a 203 DPI (dots-per-inch) printer and printing 2 dots per module, the resulting X dimension is 9.85 mils.

---

## Data Format

The decoder output is formatted according to [Table K-3](#). Zebra decoders allow different user options to output or inhibit bar code type. Selecting "Symbol ID" as the bar code type for output identifies the CapCode with letter "i".

**Table K-3** *Data Format*

File Format (1 byte)	Type (1 byte)	Image Size (4 bytes, BIG Endian)	Image Data
JPEG - 1 BMP - 3 TIFF - 4	See <a href="#">Table K-1</a> , last column		(Same bytes as in a data file)

---

## Additional Capabilities

Regardless of how the signature is captured, the output signature image is de-skewed and right-side up.

A scanner that captures signatures automatically determines whether it is scanning a signature or a bar code. You can disable the signature capturing capability in a decoder.

---

## Signature Boxes

*Figure K-3* illustrates the five acceptable signature boxes:

Type 2:



Type 5:



Type 7:



Type 8:



Type 9:

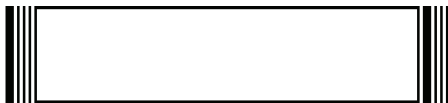

**Figure K-3** *Acceptable Signature Boxes*

# APPENDIX L NON-PARAMETER ATTRIBUTES

---

## Introduction

This appendix defines non-parameter attributes.

---

## Attributes

### Model Number

Attribute #533

Model number of the scanner. This electronic output matches the printout on the physical device label, for example DS8178-SR0F007ZZWW.

<b>Type</b>	S
<b>Size (Bytes)</b>	18
<b>User Mode Access</b>	R
<b>Values</b>	Variable

### Serial Number

Attribute #534

Unique serial number assigned in the manufacturing facility. This electronic output matches the printout on the physical device label, for example **M1J26F45V**.

<b>Type</b>	S
<b>Size (Bytes)</b>	16
<b>User Mode Access</b>	R
<b>Values</b>	Variable

## Date of Manufacture

Attribute #535

Date of device manufacture assigned in the manufacturing facility. This electronic output matches the printout on the physical device label, for example **30APR14** (which reads the 30th of April 2014).

<b>Type</b>	S
<b>Size (Bytes)</b>	7
<b>User Mode Access</b>	R
<b>Values</b>	Variable

## Date of First Programming

Attribute #614

Date of first electronic programming represents the first time settings were electronically loaded to the scanner either by 123Scan or via SMS, for example **18MAY14** (which reads the 18th of May 2014).

<b>Type</b>	S
<b>Size (Bytes)</b>	7
<b>User Mode Access</b>	R
<b>Values</b>	Variable

## Configuration Filename

Attribute #616

The name assigned to the configuration settings loaded electronically to the device either by 123Scan or via SMS.



**NOTE** Scanning the **Set Defaults** bar code automatically changes the configuration filename to *factory defaults*.

To indicate the configuration settings loaded to the device were changed, the configuration filename changes to *Modified* upon scanning any parameter bar code.

<b>Type</b>	S
<b>Size (Bytes)</b>	17
<b>User Mode Access</b>	RW
<b>Values</b>	Variable



**Beeper/LED**

Attribute #6000

Activates the beeper and/or LED.

**Type** X  
**Size (Bytes)** N/A  
**User Mode Access** W

**Values:**

<b>Beep / LED Action</b>	<b>Value</b>
1 high short beep	0
2 high short beeps	1
3 high short beeps	2
4 high short beeps	3
5 high short beeps	4
1 low short beep	5
2 low short beeps	6
3 low short beeps	7
4 low short beeps	8
5 low short beeps	9
1 high long beep	10
2 high long beeps	11
3 high long beeps	12
4 high long beeps	13
5 high long beeps	14
1 low long beep	15
2 low long beeps	16
3 low long beeps	17
4 low long beeps	18
5 low long beeps	19
Fast warble beep	20
Slow warble beep	21
High-low beep	22
Low-high beep	23
High-low-high beep	24
Low-high-low beep	25
High-high-low-low beep	26
Green LED off	42
Green LED on	43
Red LED on	47
Red LED off	48

## Parameter Defaults

### Attribute #6001

This attribute restores all parameters to their factory defaults.

<b>Type</b>	X
<b>Size (Bytes)</b>	N/A
<b>User Mode Access</b>	W
<b>Values</b>	0 = Restore Defaults 1 = Restore Factory Defaults 2 = Write Custom Defaults

## Beep on Next Bootup

### Attribute #6003

This attribute configures (enables or disables) beep on next boot up of scanner.

<b>Type</b>	X
<b>Size (Bytes)</b>	N/A
<b>User Mode Access</b>	W
<b>Values</b>	0 = Disable beep on next bootup 1 = Enable beep on next bootup

## Reboot

### Attribute #6004

This attribute initiates a device reboot.

<b>Type</b>	X
<b>Size (Bytes)</b>	N/A
<b>User Mode Access</b>	W
<b>Values</b>	N/A

## Host Trigger Session

### Attribute #6005

This attribute triggers a decode session similar to manually depressing the scanner trigger button.

<b>Type</b>	X
<b>Size (Bytes)</b>	N/A
<b>User Mode Access</b>	W
<b>Values</b>	1 = Start Host Trigger Session 0 = Stop Host Trigger Session

## Firmware Version

Attribute #20004

The scanner's operating system version. For example, **NBRFMAAC** or **PAAAABS00-007-R03D0**.

<b>Type</b>	S
<b>Size (Bytes)</b>	Variable
<b>User Mode Access</b>	R
<b>Values</b>	Variable

## Scankit Version

Attribute #20008

Identifies the 1D decode algorithms resident on the device, for example **SKIT4.33T02**.

<b>Type</b>	S
<b>Size (Bytes)</b>	Variable
<b>User Mode Access</b>	R
<b>Values</b>	Variable



# INDEX

## Numerics

123Scan .....	16-1
2D bar codes	
aztec .....	12-74
aztec inverse .....	12-75
code 128 emulation .....	12-70
data matrix .....	12-71
data matrix inverse .....	12-72
han xin .....	12-75
han xin inverse .....	12-76
maxicode .....	12-72
microPDF417 .....	12-70
microQR .....	12-74
PDF417 .....	12-69
QR code .....	12-73

## A

AAMVA	
field parsing bar codes .....	15-7
accessories .....	1-14
interface cable .....	1-14
power supply .....	1-14
ADF	
invalid rule .....	3-6
transmit error .....	3-6
ADF programming indicators .....	2-3
advanced data formatting .....	3-6
aiming	
orientation .....	2-7
aiming options	
hand-held decode aiming pattern .....	5-23
snapshot aiming pattern .....	6-9
snapshot mode timeout .....	6-8
aiming pattern .....	2-7, 6-9
enabling .....	5-23

orientation .....	2-8
ASCII values	
keyboard wedge .....	11-10
RS-232 .....	9-18
attributes	
non-parameter .....	L-1
attributes, non-parameter	
beep on next bootup .....	L-4
configuration filename .....	L-2
date of first programming .....	L-2
date of manufacture .....	L-2
firmware version .....	L-5
host trigger session .....	L-4
model number .....	L-1
parameter defaults .....	L-4
reboot .....	L-4
scankit version .....	L-5
serial number .....	L-1
autoexposure .....	6-5
auto-reconnect .....	4-22, 4-27, 4-31

## B

bar code defaults	
all .....	A-1
IBM 468X/469X .....	10-3
imaging preferences .....	6-2
keyboard wedge .....	11-3
radio communications .....	4-2
RS-232 .....	9-3
USB .....	7-3
user preferences .....	5-2
bar codes	
AAMVA field parsing .....	15-7
Australia post .....	12-79
Australia post format .....	12-80
autoexposure .....	6-5

auto-reconnect in Bluetooth keyboard emulation (HID slave) mode	4-24	country code pages	C-5
auto-reconnect interval	4-22	country codes	B-2
aztec	12-74	crop to address	6-11
aztec inverse	12-75	data matrix	12-71
batch mode	4-33, 4-34	data matrix inverse	12-72
battery shut off	1-8	decode mirror images	5-30
battery threshold	5-35	decode pager motor	5-11
beep after good decode	5-6	decode pager motor duration	5-11
beep on insertion	4-25	decode session timeout	5-26, 5-27
beeper duration	5-10	disable all code types	12-7
beeper tone	5-9	discrete 2 of 5	12-48
beeper volume	5-8	discrete 2 of 5 lengths	12-48
bits per pixel	6-18, 6-21	driver's license date format	15-18
Bluetooth friendly name	4-9	no separator	15-19
Bluetooth technology support	4-15	driver's license gender format	15-17
bookland EAN	12-10	driver's license parsing	15-2
bookland ISBN	12-22	send control characters	15-20
cancel	G-2, H-1	send keyboard characters	15-26
Chinese 2 of 5	12-57	set defaults	15-17
codabar	12-50	set up	15-4, 15-5, 15-6
codabar CLSI editing	12-52	EAN zero extend	12-22
codabar lengths	12-50	EAN-13/JAN-13	12-10
codabar NOTIS editing	12-52	EAN-8/JAN-8	12-9
codabar start and stop characters	12-53	enable all code types	12-7
code 11	12-40	enter	5-36
code 11 check digit verification	12-42	event reporting	
code 11 lengths	12-40	boot up event	8-22
code 128	12-24	decode event	8-21
code 128 emulation	12-70	parameter event	8-22
code 128 lengths	12-25	fixed exposure	6-6
code 128 reduced quiet zone	12-31	fixed gain	6-6
code 128 security level	12-30	flush macro buffer/abort macro	
code 32 prefix	12-33	PDF entry	12-88
code 39	12-32	FN1 substitution values	5-40
code 39 check digit verification	12-35	gain and exposure priority for	
code 39 full ASCII	12-36	snapshot mode	6-7
code 39 lengths	12-34	GS1 databar bar codes	12-62
code 39 reduced quiet zone	12-38	GS1 databar expanded	12-63
code 39 security level	12-37	GS1 databar limited	12-62
code 39 transmit check digit	12-35	GS1 databar limited margin check	12-64
code 93	12-38	GS1 databar security level	12-65
code 93 lengths	12-39	GS1 databar-14	12-62
composite beep mode	12-68	GS1-128	12-27
composite CC-A/B	12-66	GS1-128 emulation mode	12-69
composite CC-C	12-66	han xin	12-75
composite inverse	12-67	han xin inverse	12-76
composite TLC-39	12-67	hand-held decode aiming pattern	5-23
continuous bar code read	5-25	hands-free mode	5-21
convert code 39 to code 32	12-33	I 2 of 5 check digit verification	12-45
convert GS1 databar to UPC/EAN	12-63	I 2 of 5 convert to EAN-13	12-46
convert UPC-E to UPC-A	12-21	I 2 of 5 reduced quiet zone	12-47
convert UPC-E1 to UPC-A	12-21	I 2 of 5 security level	12-46, 12-47
country code page defaults	C-1	I 2 of 5 transmit check digit	12-45
		IBM	

- bar code configuration directive . . . . . 10-6
- IBM specification version . . . . . 10-6
- IBM 468X/469X
  - convert unknown to code 39 . . . . . 10-5
  - default parameters . . . . . 10-3
  - port address . . . . . 10-4
  - RS-485 beep directive . . . . . 10-5
- IDC
  - aspect . . . . . 13-9
  - bits per pixel . . . . . 13-10
  - border type . . . . . 13-14
  - captured image brighten . . . . . 13-12
  - captured image sharpen . . . . . 13-13
  - delay time . . . . . 13-15
  - file format selector . . . . . 13-9
  - find box outline . . . . . 13-11
  - height . . . . . 13-8
  - JPEG quality . . . . . 13-10
  - maximum rotation . . . . . 13-16
  - maximum text length . . . . . 13-12
  - minimum text length . . . . . 13-11
  - operating mode . . . . . 13-5
  - symbology . . . . . 13-6
  - width . . . . . 13-8
  - X coordinate . . . . . 13-7
  - Y coordinate . . . . . 13-7
  - zoom limit . . . . . 13-15
- ignore code 128 fnc4 . . . . . 12-31
- illumination . . . . . 5-34
- image brightness (target white) . . . . . 6-13
- image cropping . . . . . 6-10
- image enhancement . . . . . 6-15
- image file format . . . . . 6-16, 6-20
- image resolution . . . . . 6-12
- image rotation . . . . . 6-17
- intercharacter gap size . . . . . 12-87
- interleaved 2 of 5 . . . . . 12-43
  - convert to EAN-13 . . . . . 12-46, 12-47
- interleaved 2 of 5 lengths . . . . . 12-43
- inverse 1D . . . . . 12-61
- ISBT 128 . . . . . 12-27
- ISBT concatenation . . . . . 12-28, 12-29
- ISBT concatenation redundancy . . . . . 12-29
- ISSN EAN . . . . . 12-24
- Japan postal . . . . . 12-79
- JPEG image options . . . . . 6-13
- JPEG quality and size . . . . . 6-14
- JPEG target file size . . . . . 6-14
- keyboard wedge
  - alternate numeric keypad emulation . . . . . 11-6
  - caps lock override . . . . . 11-7
  - default table . . . . . 11-3
  - host types . . . . . 11-4
  - ignore unknown characters . . . . . 11-4
  - intra-keystroke delay . . . . . 11-5
  - keystroke delay . . . . . 11-5
  - quick keypad emulation . . . . . 11-6
  - simulated caps lock . . . . . 11-7
- Korean 3 of 5 . . . . . 12-60
- lamp mode
  - lamp mode control . . . . . 5-14
  - lamp mode timeout . . . . . 5-15
- lock override . . . . . 4-28
- low power mode . . . . . 5-16
- matrix 2 of 5 . . . . . 12-57
- matrix 2 of 5 check digit . . . . . 12-59
- matrix 2 of 5 lengths . . . . . 12-58
- maxicode . . . . . 12-72
- microPDF417 . . . . . 12-70
- microQR . . . . . 12-74
- mobile phone/display mode . . . . . 5-31
- motion tolerance . . . . . 5-34
- MSI . . . . . 12-53
- MSI check digit algorithm . . . . . 12-56
- MSI check digits . . . . . 12-55
- MSI lengths . . . . . 12-54
- MSI reduced quiet zone . . . . . 12-56
- MSI transmit check digit . . . . . 12-55
- Netherlands KIX code . . . . . 12-81
- night mode trigger . . . . . 5-13
- numeric bar codes . . . . . G-2, H-1
- OCR
  - bright illumination . . . . . 14-15
  - check digit . . . . . 14-25
  - check digit multiplier . . . . . 14-26
  - check digit validation . . . . . 14-27
  - default table . . . . . 14-3
  - inverse OCR . . . . . 14-32
  - lines . . . . . 14-13
  - maximum characters . . . . . 14-14
  - MICR E13B . . . . . 14-10
  - minimum character . . . . . 14-13
  - OCR-A . . . . . 14-4
  - OCR-A variant . . . . . 14-4
  - OCR-B . . . . . 14-6
  - OCR-B variant . . . . . 14-7
  - orientation . . . . . 14-11
  - parameters . . . . . 14-4
  - quiet zone . . . . . 14-15
  - subset . . . . . 14-14
  - template . . . . . 14-16
  - US currency serial number . . . . . 14-11
- pager motor . . . . . 5-11
- parameter broadcast . . . . . 4-27
- parameter scanning . . . . . 5-6
- parser version ID . . . . . 15-16
- PDF prioritization . . . . . 5-32
- PDF prioritization timeout . . . . . 5-33

PDF417	12-69	check receive errors	9-11
picklist mode	5-24	data bits	9-10
postal	12-76	hardware handshaking	9-11, 9-12
prefix/suffix values	5-38	host serial response time-out	9-15
presentation mode field of view	5-33	host types	9-6
QR code	12-73	intercharacter delay	9-17
quiet zone level	12-86	parity	9-9
radio		RTS line state	9-16
auto-reconnect	4-22	software handshaking	9-13, 9-14
batch mode	4-33	stop bit select	9-16
beep on	4-25	stop bits	9-10
beep on insertion	4-25	samples	F-1
bluetooth friendly name	4-9	scan data options	5-39
bluetooth HID wait for		scanner to cradle support	4-26
connection	4-15, 4-16	security level	12-85
bluetooth radio state	4-15	set defaults	5-5
bluetooth security	4-38	signature capture	6-19
classic bluetooth and low energy	4-38	signature capture height	6-22
connection maintenance interval	4-31	signature capture JPEG quality	6-22
convert case	4-21	signature capture width	6-22
cradle bluetooth	4-4	silence operational mode changes	6-9
discoverable mode	4-10	snapshot aiming pattern	6-9
emulate keypad	4-18	snapshot mode timeout	6-8
fast HID keyboard	4-19	SSI	
HID bluetooth	4-5	baud rate	8-12
HID caps lock override	4-17	check parity	8-14
HID features for Apple iOS	4-16	data packet format	8-16
HID function key mapping	4-20	host character timeout	8-18
HID ignore unknown characters	4-18	host RTS line state	8-16
HID keyboard FN1 sub	4-20	host serial response time-out	8-17
HID keyboard keystroke delay	4-17	interpacket delay	8-20
link supervision timeout	4-14	multipacket option	8-19
lock override	4-28	parity	8-13
output power	4-13	selecting	8-11
page	4-36	software handshaking	8-15
page mode	4-37	stop bit select	8-14
page state timeout	4-37	suppress power up beeps	5-10
pairing methods	4-29	symbolologies	
persistent batch storage	4-35	default table	12-2
quick keypad emulation	4-19	time delay to low power mode	5-17
SSI	4-6	timeout between decodes,	
SSP	4-8	different symbols	5-28
toggle pairing	4-30	timeout between decodes,	
unpairing	4-29	same symbol	5-28
wi-fi friendly channel exclusion	4-11	transmit code 11 check digits	12-42
wi-fi friendly mode	4-11	transmit code ID character	5-36
radio output power	4-27	transmit matrix 2 of 5 check digit	12-59
reconnect attempt beep	4-22	transmit no read message	5-41
reconnect attempt interval	4-23	transmit UK postal check digit	12-78
redundancy level	12-83	transmit US postal check digit	12-77
report version	12-87	trigger mode	5-20
RS-232		trigger modes	5-19
baud rate	9-8	triggered timeout, same symbol	5-29
beep on bel	9-16	trioptic code 39	12-32



- UCC coupon extended code . . . . . 12-23
  - UK postal . . . . . 12-78
  - unicode output control . . . . . D-2
  - unique bar code reporting . . . . . 5-26
  - unpair . . . . . 4-29
  - unsolicited heartbeat interval . . . . . 5-42
  - UPC composite mode . . . . . 12-68
  - UPC reduced quiet zone . . . . . 12-16
  - UPC/EAN
    - coupon code . . . . . 12-23
  - UPC/EAN supplemental AIM ID format . . . . . 12-15
  - UPC/EAN supplemental redundancy . . . . . 12-14
  - UPC/EAN supplementals . . . . . 12-11
  - UPC-A . . . . . 12-8
  - UPC-A check digit . . . . . 12-16
  - UPC-A preamble . . . . . 12-18
  - UPC-E . . . . . 12-8
  - UPC-E check digit . . . . . 12-17
  - UPC-E preamble . . . . . 12-19
  - UPC-E1 . . . . . 12-9
  - UPC-E1 check digit . . . . . 12-17
  - UPC-E1 preamble . . . . . 12-20
  - UPU FICS postal . . . . . 12-82
  - US planet . . . . . 12-77
  - US postnet . . . . . 12-76
  - USB
    - caps lock override . . . . . 7-7
    - convert case . . . . . 7-11
    - country keyboard types (country codes) . . . . . B-2
    - device type . . . . . 7-4
    - emulate keypad . . . . . 7-8
    - emulate keypad with leading zero . . . . . 7-8
    - fast HID . . . . . 7-15
    - function key mapping . . . . . 7-10
    - IBM specification version . . . . . 7-15
    - keyboard FN 1 sub . . . . . 7-9
    - keystroke delay . . . . . 7-6
    - optional parameters . . . . . 7-12
    - polling interval . . . . . 7-13, 7-14
    - quick emulation . . . . . 7-9
    - simulated caps lock . . . . . 7-10
    - SNAPI handshaking . . . . . 7-6
    - static CDC . . . . . 7-11
    - unknown characters . . . . . 7-7
  - USPS 4CB/One Code/Intelligent Mail . . . . . 12-81
  - variable PIN code . . . . . 4-39
  - wi-fi friendly channel exclusion . . . . . 4-11
  - wi-fi friendly mode . . . . . 4-11
  - batch mode stored data . . . . . 4-33
  - battery
    - charging . . . . . 1-7
    - indicators . . . . . 2-3
    - recovering discharged . . . . . 1-7
    - shutting off bar code . . . . . 1-8
  - beeper definitions
    - pairing . . . . . 4-4
    - wireless . . . . . 4-4
  - beeper indicators
    - ADF programming . . . . . 2-3
    - battery . . . . . 2-3
    - host specific . . . . . 2-4
    - parameter programming . . . . . 2-3
    - radio . . . . . 2-2
    - scanning . . . . . 2-1
    - standard . . . . . 2-1
    - wireless . . . . . 2-2
  - Bluetooth
    - encryption . . . . . 4-40
    - HID . . . . . 4-9, 4-15, 4-24
    - pairing . . . . . 4-30
    - pin code . . . . . 4-38
    - profiles . . . . . 4-4
    - secure simple pairing IO capability . . . . . 4-40
    - serial port profile . . . . . 4-9
    - set friendly name . . . . . 4-9
    - SPP . . . . . 4-22, 4-30
  - bluetooth . . . . . 1-2, 1-13
  - bullets . . . . . xxii
- ## C
- cable configurations . . . . . xx
  - cables . . . . . xx
    - installing . . . . . 1-4
    - interface . . . . . 1-14
    - signal descriptions . . . . . 3-12
  - character sets
    - keyboard wedge . . . . . 11-10
    - RS-232 . . . . . 9-18
  - charging . . . . . 1-7
  - Chinese 2 of 5 bar codes . . . . . 12-57
  - CJK . . . . . D-1
  - cleaning the devices
    - approved disinfectant cleaners for
      - healthcare devices . . . . . 3-2
    - approved for standard devices . . . . . 3-2
    - how to . . . . . 3-3
    - known harmful ingredients . . . . . 3-1
  - codabar bar codes . . . . . 12-50
    - CLSI editing . . . . . 12-52
    - lengths . . . . . 12-50
    - NOTIS editing . . . . . 12-52
    - start and stop characters . . . . . 12-53
  - code 11 bar codes . . . . . 12-40
    - check digit verification . . . . . 12-42
    - lengths . . . . . 12-40
    - transmit check digit . . . . . 12-42
  - code 128 bar codes . . . . . 12-24

GS1-128 ..... 12-27  
 ignore fnc4 ..... 12-31  
 ISBT 128 ..... 12-27  
 ISBT concatenation ..... 12-28, 12-29  
 ISBT concatenation redundancy ..... 12-29  
 lengths ..... 12-25  
 reduced quiet zone ..... 12-31  
 security level ..... 12-30  
 code 128 emulation bar codes ..... 12-70  
 code 39 bar codes ..... 12-32  
   check digit verification ..... 12-35  
   code 32 prefix ..... 12-33  
   code 39 ..... 12-32  
   code 39 security Level ..... 12-37  
   convert code 39 to code 32 ..... 12-33  
   full ASCII ..... 12-36  
   lengths ..... 12-34  
   reduced quiet zone ..... 12-38  
   transmit check digit ..... 12-35  
   trioptic ..... 12-32  
 code 93 bar codes ..... 12-38  
   lengths ..... 12-39  
 code ID character ..... 5-36  
 code identifiers  
   AIM code IDs ..... E-3  
   modifier characters ..... E-4  
   Symbol ..... E-1  
 communication protocol  
   cable interface ..... J-1  
   radio ..... J-2  
 composite bar codes  
   beep mode ..... 12-68  
   composite CC-A/B ..... 12-66  
   composite CC-C ..... 12-66  
   composite inverse ..... 12-67  
   composite TLC-39 ..... 12-67  
   GS1-128 emulation mode ..... 12-69  
   UPC composite mode ..... 12-68  
 configurations  
   cables ..... xx  
   cradles ..... xx  
   product line ..... xx  
   scanners ..... xix  
 configuring scanner ..... 1-13  
 connecting  
   IBM 468X/469X interface ..... 10-2  
   keyboard wedge interface ..... 11-2  
   lost connection ..... 1-13  
   RS-232 interface ..... 9-2  
 conventions  
   notational ..... xxii  
 country code page defaults ..... C-1  
 country code pages ..... C-5  
 country codes ..... B-2

cradle  
   connecting ..... 1-4  
   inserting scanner ..... 1-12  
   mounting ..... 1-5  
   presentation  
     features ..... 1-4  
   standard  
     features ..... 1-3  
     supply power ..... 1-5  
 cradle configurations ..... xx  
 cradle indicators ..... 2-4  
 cradle indicators (host controlled) ..... 2-5  
 cropping ..... 6-10, 6-11

## D

data matrix bar codes ..... 12-71  
 decode ranges  
   ds8178-hc ..... 2-9  
   ds8178-sr ..... 2-9  
 default parameters  
   all ..... A-1  
   IBM 468X/469X ..... 10-3  
   IDC ..... 13-4  
   imaging preferences ..... 6-2  
   keyboard wedge ..... 11-3  
   OCR ..... 14-3  
   radio communications ..... 4-2  
   restoring ..... 5-5  
   RS-232 ..... 9-3  
   SSI ..... 8-10  
   symbolologies ..... 12-2  
   USB ..... 7-3  
   user preferences ..... 5-2  
 digital scanner  
   features ..... 1-2  
 discharged battery recovery ..... 1-7  
 discrete 2 of 5 bar codes ..... 12-48  
   lengths ..... 12-48  
 driver's license  
   ADF parsing sample ..... 15-45  
   date format ..... 15-18  
     no separator ..... 15-19  
   field parsing bar codes ..... 15-4, 15-5, 15-6  
   gender format ..... 15-17  
   parsing bar codes ..... 15-2  
   parsing rule example ..... 15-41

## E

encryption ..... 4-40  
 error indications  
   ADF ..... 3-6  
   format ..... 3-7

input	3-6
miscellaneous scanner options	4-2
unknown characters	7-7
exposure options	
autoexposure	6-5
fixed exposure	6-6
fixed gain	6-6
gain and exposure priority for snapshot mode	6-7
illumination	5-34
presentation mode field of view	5-33

## F

features	1-2
fixed exposure	6-6
fixed gain	6-6

## G

gain and exposure priority for snapshot mode	6-7
GS1 databar	12-62
GS1 databar bar codes	
convert GS1 databar to UPC/EAN	12-63
GS1 databar expanded	12-63
GS1 databar limited	12-62
GS1 databar limited margin check	12-64
GS1 databar security level	12-65
GS1 databar-14	12-62

## H

HID Profile	4-9
host specific indicators	2-4
host types	
keyboard wedge	11-4
RS-232	9-6
USB	7-4

## I

IBM 468X/469X	
connection	10-2
default parameters	10-3
parameters	10-4
IDC	13-1
bar code acceptance test	13-2
capture region	13-2
data transmission	13-3
demonstrations	13-17
image post processing	13-3
operating mode	13-5
quick start	13-16, 13-17
quick start form	13-19

sample setup	13-16
support	13-3
illumination	5-34
image brightness (target white)	6-13
image cropping	6-10, 6-11
image enhancement	6-15
image options	
bits per pixel	6-18
cropping	6-10, 6-11
file formats	6-16, 6-20
image brightness (target white)	6-13
image enhancement	6-15
image resolution	6-12
image rotation	6-17
JPEG image options	6-13
JPEG size/quality	6-14
JPEG target file size	6-14
image resolution	6-12
imaging preferences	
defaults	6-2
interleaved 2 of 5 bar codes	12-43
check digit verification	12-45
convert to EAN-13	12-46
lengths	12-43
reduced quiet zone	12-47
security level	12-46, 12-47
transmit check digit	12-45

## J

JPEG image options	6-13
size/quality	6-14
JPEG target file size	6-14

## K

keyboard types (country codes)	
Albanian	B-2
Arabic (101)	B-2
Arabic (102)	B-2
Arabic (102) Azerty	B-3
Azeri (Cyrillic)	B-3
Azeri (Latin)	B-3
Belarusian	B-3
Bosnian (Cyrillic)	B-3
Bosnian (Latin)	B-3
Bulgarian (Latin)	B-3
Bulgarian Cyrillic (Typewriter)	B-4
Canadian French (Legacy)	B-4
Canadian French Win7	B-4
Canadian Multilingual Standard	B-4
Chinese (ASCII)	B-4
Croatian	B-5
Czech	B-5

Czech (Programmer)	B-5
Czech (QWERTY)	B-5
Danish	B-5
Dutch (Netherlands)	B-6
Estonian	B-6
Faeroese	B-6
Finnish	B-6
French (Canada) 2000/XP	B-7
French (Canada) 95/98	B-6
French (France)	B-6
French International	B-6
Galician	B-7
German	B-7
Greek	B-7
Greek (220) Latin	B-7
Greek (319) Latin	B-7
Greek 220	B-8
Greek 319	B-8
Greek Latin	B-7
Greek Polytonic	B-8
Hebrew Israel	B-8
Hungarian	B-8
Hungarian_101KEY	B-8
Irish	B-9
Islandic	B-8
Italian	B-9
Italian (142)	B-9
Japanese (ASCII)	B-9
Kazakh	B-9
Korean (ASCII)	B-9, B-10
Kyrgyz	B-10
Latin American	B-10
Latvian	B-10
Latvian (QWERTY)	B-10
Lithuanian	B-10
Lithuanian (IBM)	B-10
Macedonian (FYROM)	B-11
Maltese_47KEY	B-11
Mongolian	B-11
Norwegian	B-11
Polish (214)	B-11
Polish (Programmer)	B-11
Portuguese (Brazil)	B-11
Portuguese (Brazilian ABNT)	B-12
Portuguese (Brazilian ABNT2)	B-12
Portuguese (Portugal)	B-12
Romanian	B-12
Romanian (Legacy)	B-12
Romanian (Programmer)	B-13
Romanian (Standard)	B-12
Russian	B-13
Russian (Typewriter)	B-13
Serbian (Cyrillic)	B-13
Serbian (Latin)	B-13

Slovak	B-13
Slovak (QWERTY)	B-14
Slovenian	B-14
Spanish	B-14
Spanish (Variation)	B-14
Swedish	B-14
Swiss French	B-14
Swiss German	B-14
Tatar	B-15
Thai (Kedmanee)	B-15
Turkish F	B-15
Turkish Q	B-15
UK English	B-15
Ukrainian	B-15
US Dvorak	B-15
US Dvorak Left	B-16
US Dvorak Right	B-16
US English	B-2
US International	B-16
Uzbek	B-16
Vietnamese	B-16
keyboard wedge	
connection	11-2
default parameters	11-3
parameters	11-4
Korean 3 of 5 bar codes	12-60

## L

LED indicators	
ADF programming	2-3
battery	2-3
cradle	2-4
cradle, host controlled	2-5
host specific	2-4
parameter programming	2-3
radio	2-2
scanning	2-1
standard	2-1
wireless	2-2
lock override	4-28
locked pairing mode	4-31
locked pairing mode bar codes	
radio pairing modes	4-27
low power mode	4-22

## M

macro PDF	12-88
flush buffer/abort PDF entry	12-88
maintenance	
approved cleaners for standard devices	3-2
approved disinfectant cleaners for	
healthcare devices	3-2

- how to clean the devices . . . . . 3-3
- known harmful ingredients . . . . . 3-1
- master . . . . . 4-9
- master serial port profile . . . . . 4-22, 4-27
- matrix 2 of 5 bar codes . . . . . 12-57
  - check digit . . . . . 12-59
  - lengths . . . . . 12-58
  - transmit check digit . . . . . 12-59
- maxicode bar codes . . . . . 12-72
- microPDF417 bar codes . . . . . 12-70
- mounting
  - cradle . . . . . 1-5
- MSI bar codes . . . . . 12-53
  - check digit algorithm . . . . . 12-56
  - check digits . . . . . 12-55
  - lengths . . . . . 12-54
  - reduced quiet zone . . . . . 12-56
  - transmit check digit . . . . . 12-55
- multipoint-to-point communication . . . . . 4-26

## N

- non-parameter attributes . . . . . L-1
  - beep on next bootup . . . . . L-4
  - configuration filename . . . . . L-2
  - date of first programming . . . . . L-2
  - date of manufacture . . . . . L-2
  - firmware version . . . . . L-5
  - host trigger session . . . . . L-4
  - model number . . . . . L-1
  - parameter defaults . . . . . L-4
  - reboot . . . . . L-4
  - scankit version . . . . . L-5
  - serial number . . . . . L-1
- notational conventions . . . . . xxii

## O

- OCR
  - bar codes . . . . . 14-4
  - default parameters . . . . . 14-3
- out of range indicator . . . . . 4-24

## P

- pairing . . . . . 1-13
  - address . . . . . 4-22
  - bar code . . . . . 4-4
  - bar code format . . . . . 4-30
  - connection maintenance interval . . . . . 4-31
  - lock override . . . . . 4-28
  - master/slave setup . . . . . 4-9
  - methods . . . . . 4-29
  - modes . . . . . 4-3, 4-27, A-2

- multipoint-to-point bar codes
  - radio
    - multipoint-to-point . . . . . 4-26
  - on contacts . . . . . 4-3, A-2
  - pin codes . . . . . 4-38
  - point-to-point . . . . . 4-26
  - radio communication . . . . . 1-13
  - unpair . . . . . 4-29
- pairing beeper definitions . . . . . 4-4
- parameter defaults
  - all . . . . . A-1
  - imaging preferences . . . . . 6-2
  - radio communications . . . . . 4-2
  - RS-232 . . . . . 9-3
  - USB . . . . . 7-3
  - user preferences . . . . . 5-2
- parameter programming indicators . . . . . 2-3
- parameters
  - batch mode . . . . . 4-33, 4-34
  - beep on insertion . . . . . 4-25
  - Bluetooth technology support . . . . . 4-15
  - night mode trigger . . . . . 5-13
  - persistent batch storage . . . . . 4-35
  - radio communication . . . . . 4-4
    - auto-reconnect interval . . . . . 4-22
    - batch mode . . . . . 4-33, 4-34
    - connection maintenance interval . . . . . 4-31
    - host types . . . . . 4-4
    - pairing . . . . . 4-27
    - parameter broadcast . . . . . 4-27
    - persistent batch storage . . . . . 4-35
  - reconnect attempt beep . . . . . 4-22
  - reconnect attempt interval . . . . . 4-23
  - scanner to cradle support . . . . . 4-26
  - unpair . . . . . 4-29
  - USB . . . . . 7-4
- parser version ID . . . . . 15-16
- parts
  - scanner . . . . . 1-3, 1-4, 1-5
- PDF417 bar codes . . . . . 12-69
  - PDF prioritization . . . . . 5-32
- PIN code
  - static . . . . . 4-39
  - variable . . . . . 4-39
- pinouts
  - cradle signal descriptions . . . . . 3-12
- point-to-point communication . . . . . 4-26
- postal codes . . . . . 12-76
  - Australia post . . . . . 12-79
  - Australia post format . . . . . 12-80
  - Japan postal . . . . . 12-79
  - Netherlands KIX code . . . . . 12-81
  - transmit UK postal check digit . . . . . 12-78
  - transmit US postal check digit . . . . . 12-77

UK postal	12-78
UPU FICS postal	12-82
US planet	12-77
US postnet	12-76
USPS 4CB/One Code/Intelligent Mail	12-81
power	1-5
power supply	1-14
presentation mode field of view	5-33
product line configurations	xx

## Q

QR code bar codes	12-73
quick start guide	1-14

## R

radio communication	
bluetooth	1-2
bluetooth technology profile support	1-13
pairing	1-13
parameters	4-4
point-to-point	4-26
reconnect attempt	4-23
reconnect attempt beep	4-22
radio communications	
defaults	4-2
multipoint-to-point	4-26
radio indicators	2-2
range indicator	4-24
reconnect attempt	4-23
reconnect attempt beep	4-22
RS-232	
connection	9-2
defaults	9-3
parameters	9-4, 9-6
RSM	
commands and responses over SSI	8-8

## S

sample bar codes	F-1
scanner configurations	xix
scanner parts	1-3, 1-4, 1-5
scanner to cradle support	4-26
scanner(s) to cradle support	4-26
scanning	
aiming	2-7
errors	5-2, 6-2, 7-7, 12-2
hand-held mode	2-5
presentation mode	2-5
radio communications	
sequence example	4-2
sequence example	5-2, 6-2, 12-1

setting parameters	4-1
scanning indicators	2-1
secure simple pairing IO capability	4-40
security	
intercharacter gap size	12-87
quiet zone level	12-86
redundancy level	12-83
security level	12-85
Serial Port Profile	
master	4-22, 4-27
support	4-9
service information	xxiii
setting defaults	5-5
setup	
connecting a USB interface	7-1
connecting an RS-232 interface	9-2
connecting keyboard wedge interface	11-2
connecting to an IBM 468X/469X host	10-2
inserting scanner in cradle	1-12
lost host connection	1-13
mounting cradle	1-5
supplying power	1-5
unpacking	1-1
shutting off battery	1-8
signal descriptions	3-12
signature capture	6-19
bits per pixel	6-21
file format selector	6-20
height	6-22
JPEG quality	6-22
width	6-22
simple serial interface	
baud rate	8-12
commands	8-2
communications	8-1, 8-5
default parameters	8-10
handshaking	8-3, 8-5
RSM commands and responses	8-8
RTS CTS	8-5
selecting	8-11
transactions	8-3
slave	4-9
snapshot mode timeout	6-8
specifications	3-8
SPP	
master	4-22, 4-27
support	4-9
SSI	
baud rate	8-12
commands	8-2
communications	8-1, 8-5
default parameters	8-10
handshaking	8-3, 8-5
RSM commands and responses	8-8

RTS CTS .....	8-5
selecting .....	8-11
transactions .....	8-3
stored data	
batch mode .....	4-33
support .....	xxiii
for IDC .....	13-3
symbology default parameters .....	12-2

## T

technical specifications .....	3-8
trigger mode .....	5-20
troubleshooting .....	3-4

## U

unicode	
output control .....	D-2
unlocked pairing mode .....	4-28
unpacking .....	1-1
unpairing	
bar code .....	4-29
UPC/EAN bar codes	
bookland EAN .....	12-10
bookland ISBN .....	12-22
check digit .....	12-16, 12-17
convert UPC-E to UPC-A .....	12-21
convert UPC-E1 to UPC-A .....	12-21
EAN zero extend .....	12-22
EAN-13/JAN-13 .....	12-10
EAN-8/JAN-8 .....	12-9
ISSN EAN .....	12-24
reduced quiet zone .....	12-16
supplemental AIM ID format .....	12-15
supplemental redundancy .....	12-14
supplementals .....	12-11
UCC coupon extended code .....	12-23
UPC-A .....	12-8
UPC-A preamble .....	12-18
UPC-E .....	12-8
UPC-E preamble .....	12-19
UPC-E1 .....	12-9
UPC-E1 preamble .....	12-20
USB connection .....	7-1
USB defaults .....	7-3
USB parameters .....	7-4
user preferences	
defaults .....	5-2
user preferences bar codes	
batch mode .....	4-33, 4-34
beep on insertion .....	4-25
night mode trigger .....	5-13
persistent batch storage .....	4-35

## W

wi-fi friendly mode	
channel exclusion .....	4-11
notes .....	4-11
wireless indicators .....	2-2

## Z

Zebra Technologies Corporation support .....	xxiii
--	-------





# Tell Us What You Think...

We'd like to know what you think about this manual. Please take a moment to fill out this questionnaire and fax this form to: (631) 627-7184, or mail to:

Zebra Technologies Corporation  
One Zebra Plaza  
Holtsville, New York 11742  
Att: Technical Publications Manager MS B10



**IMPORTANT** If you need product support, please call the appropriate customer support number provided. Unfortunately, we cannot provide customer support at the fax number above.

Manual Title: \_\_\_\_\_  
(please include revision level)

How familiar were you with this product before using this manual?

- Very familiar     Slightly familiar     Not at all familiar

Did this manual meet your needs? If not, please explain.

---

---

---

---

What topics need to be added to the index, if applicable?

---

---

---

---

What topics do you feel need to be better discussed? Please be specific.

---

---

---

---

What can we do to further improve our manuals?

---

---

---

---







Zebra Technologies Corporation, Inc.  
3 Overlook Point  
Lincolnshire, IL 60069, U.S.A.  
<http://www.zebra.com>

Zebra and the stylized Zebra head are trademarks of ZIH Corp., registered in many jurisdictions worldwide. All other trademarks are the property of their respective owners.

© 2017 Symbol Technologies LLC, a subsidiary of Zebra Technologies Corporation. All rights reserved.