



SLC™ 8000 Advanced Console Manager User Guide

Part Number 900-704-R
Revision F June 2017

Intellectual Property

© 2017 Lantronix, Inc. All rights reserved. No part of the contents of this publication may be transmitted or reproduced in any form or by any means without the written permission of Lantronix.

Lantronix and *Lantronix Spider* are registered trademarks of Lantronix, Inc. in the United States and other countries. *SLC*, and *vSLM* are trademarks of Lantronix, Inc.

Patented: patents.lantronix.com; additional patents pending.

Windows and *Internet Explorer* are registered trademarks of Microsoft Corporation. *Firefox* is a registered trademark of the Mozilla Foundation. *Chrome* and *iGoogle* are trademarks of Google Inc. All other trademarks and trade names are the property of their respective holders.

Warranty

For details on the Lantronix warranty policy, please go to our web site at <http://www.lantronix.com/support/warranty>.

Contacts

Lantronix Corporate Headquarters

7535 Irvine Center Drive
Suite100
Irvine, CA 92618, USA

Toll Free: 800-526-8766
Phone: 949-453-3990
Fax: 949-453-3995

Technical Support

Online: www.lantronix.com/support

Sales Offices

For a current list of our domestic and international sales offices, go to the Lantronix web site at www.lantronix.com/about/contact.

Open Source Software

Some applications are Open Source software licensed under the Berkeley Software Distribution (BSD) license or the GNU General Public License (GPL) as published by the Free Software Foundation (FSF). Lantronix grants you no right to receive source code to the Open Source software; however, in some cases, rights and access to source code for certain Open Source software may be available directly from Lantronix' licensors. Upon request, Lantronix will identify the Open Source components and the licenses that apply to them. Your use of each Open Source component or software is subject to the terms of the applicable license. The BSD license is available at <http://opensource.org/licenses>. The GNU General Public License is available at <http://www.gnu.org/licenses/>. Your use of each Open Source component or software is subject to the terms of the applicable license.

OPEN SOURCE SOFTWARE IS DISTRIBUTED WITHOUT ANY WARRANTY, INCLUDING ANY IMPLIED WARRANTY OF MERCHANTABILITY OR FITNESS FOR A PARTICULAR PURPOSE. SEE THE APPLICATION LICENSE AGREEMENT FOR ADDITIONAL INFORMATION.

Disclaimer & Revisions

All information contained herein is provided "AS IS." Lantronix undertakes no obligation to update the information in this publication. Lantronix does not make, and specifically disclaims, all warranties of any kind (express, implied or otherwise) regarding title, non-infringement, fitness, quality, accuracy, completeness, usefulness, suitability or performance of the information provided herein. Lantronix shall have no liability whatsoever to any user for any damages, losses and causes of action (whether in contract or in tort or otherwise) in connection with the user's access or usage of any of the information or content contained herein. The information and specifications contained in this document are subject to change without notice.

Operation of this equipment in a residential area is likely to cause interference, in which case the user, at his or her own expense, will be required to take whatever measures may be required to correct the interference.

Note: *This equipment has been tested and found to comply with the limits for Class A digital device pursuant to Part 15 of the FCC Rules. These limits are designed to provide reasonable protection against harmful interference when the equipment is operated in a commercial environment. This equipment generates, uses, and can radiate radio frequency energy and, if not installed and used in accordance with this User Guide, may cause interference to radio communications. Operation of this equipment in a residential area is likely to cause interference, in which case the user will be required to correct the interference at his own expense.*

User Information

Class A Equipment (Broadcasting and communication equipments for office work)

Seller and user shall be noticed that this equipment is suitable for electromagnetic equipments for office work (Class A) and it can be used outside home.

Changes or modifications made to this device that are not explicitly approved by Lantronix will void the user's authority to operate this device.

声明

此为 A 级产品，在生活环境中，该产品可能会造成无线电干扰。在这种情况下，可能需要用户对其干扰采取切实可行的措施。

사용자안내문

기종별	사용자안내문
A 급 기기 (업무용방송통신기자재)	이 기기는 업무용 (A 급) 전자파적합기기로서 판매자 또는 사용자는 이 점을 주의하시기 바라며, 가정외의 지역에서 사용하는 것을 목적으로 합니다.

Revision History

Date	Rev.	Comments
March 2014	A	Preliminary release.
October 2014	B	Initial document for firmware release 7.1.0.0.
June 2015	C	Updated for firmware release 7.2.0.0. Changes include new operating atmosphere information and warning language in Chinese and Korean. Software changes include additions in Telnet, SSH and TCP timeout directions, number of sessions message, idle timeout message, VBUS enabling, assert DTR, run web server, added mounted column information for NFS Mounts, masked CHAP secret and DOD CHAP secret fields, USB devices in diagnostics and addition of SSH bit option. SSL settings were removed so the SSLv2 protocol option is no longer available.
June 2016	D	Updated for firmware release 7.3.0.0.
January 2017	E	Updated power cord information.
June 2017	F	Updated for firmware release 7.4.0.0 and for new dual SFP transceiver port or dual Ethernet port capability options. Updated the following: <ul style="list-style-type: none">◆ IPv6 Neighbor Table, Ethernet Bonding Status links, and IPv6 Forward Flag under Network Settings.◆ IKE v2, x.509 Certificate, Certificate Authority/Certificate File for Remote Peer, Certificate Authority/Certificate File/Key File for Local Peer, SA Lifetime, Remote and Dead Peer settings under Network VPN.◆ Enable v1/v2c, Trap Version, Alarm Delay to SNMP, and Trap User Name, Password and Passphrase under SNMP Services.◆ Added ability change and reset BootCount, BootDelay and BootLimit.

Table of Contents

Intellectual Property	2
Warranty	2
Contacts	2
Open Source Software	2
Disclaimer & Revisions	3
Revision History	4
List of Figures	14
List of Tables	18
1: About this Guide	19
Purpose and Audience	19
Summary of Chapters	19
Additional Documentation	20
2: Introduction	21
Features	21
Console Management	21
Power	22
Hardware	22
System Features	24
Protocols Supported	25
Access Control	25
Device Port Buffer	25
Configuration Options	25
Device Port and Console Port Interfaces	26
Network Connections	29
Front Panel USB Ports	30
Memory Card Port	30
Internal Modem	31
3: Installation	32
What's in the Box	32
Product Label	34
Technical Specifications	34
Physical Installation	36
Connecting to a Device Port	36
Modular Expansion for I/O Module Bays	38
Connecting to Network Ports	39
Connecting Terminals	39

AC Input _____	40
Modem Installation _____	41
Battery Replacement _____	44
4: Quick Setup	48
Recommendations _____	48
IP Address _____	48
Method #1 Using the Front Panel Display _____	49
Front Panel LCD Display and Keypads _____	49
Navigating _____	49
Entering the Settings _____	51
Restoring Factory Defaults _____	52
Method #2 Quick Setup on the Web Page _____	52
Network Settings _____	54
Date & Time Settings _____	54
Administrator Settings _____	54
Method #3 Quick Setup on the Command Line Interface _____	55
Next Step _____	58
5: Web and Command Line Interfaces	59
Web Manager _____	59
Logging in _____	61
Logging Out _____	61
Web Page Help _____	61
Command Line Interface _____	62
Logging In _____	62
Logging Out _____	62
Command Syntax _____	62
Command Line Help _____	63
Tips _____	63
6: Basic Parameters	66
Requirements _____	66
Network Port Settings _____	67
Ethernet Interfaces (Eth1 and Eth2) _____	69
Gateway _____	71
Hostname & Name Servers _____	71
DNS Servers _____	71
DHCP-Acquired DNS Servers _____	71
TCP Keepalive Parameters _____	72
Ethernet Counters _____	72
Network Commands _____	72

IP Filter	74
Viewing IP Filters	74
Mapping Rulesets	75
Enabling IP Filters	75
Configuring IP Filters	76
Rule Parameters	77
Updating an IP Filter	77
Deleting an IP Filter	78
IP Filter Commands	78
Routing	79
Dynamic Routing	79
Static Routing	79
Equivalent Routing Commands	80
VPN	80
Configuring an IPsec VPN Tunnel through the CLI	85
Security	86

7: Services 89

System Logging and Other Services	89
SSH/Telnet/Logging	90
System Logging	90
Audit Log	91
SMTP	91
SSH	92
Telnet	92
Web SSH/Web Telnet Settings	92
Phone Home	93
SNMP	94
v1/v2c Communities	96
Version 3	96
V3 User Read-Only	96
V3 User Read-Write	96
V3 User Trap	96
SNMP, SSH, Telnet, and Logging Commands	97
NFS and SMB/CIFS	98
SMB/CIFS Share	100
NFS and SMB/CIFS Commands	100
Secure Lantronix Network	101
Browser Issues	105
Secure Lantronix Network Commands	107
Date and Time	107
Date and Time Commands	109
Web Server	110

Admin Web Commands _____	112
Services - Web Sessions _____	113
Services - SSL Certificate _____	113
iGoogle Gadgets _____	116

8: Device Ports 118

Connection Methods _____	118
Permissions _____	118
I/O Modules _____	119
Device Status _____	120
Device Ports _____	121
Telnet/SSH/TCP in Port Numbers _____	122
Global Commands _____	122
Device Ports - Settings _____	123
Device Port Settings _____	126
IP Settings _____	127
Data Settings _____	128
Hardware Signal Triggers _____	129
Modem Settings (Device Ports) _____	130
Modem Settings: Text Mode _____	131
Modem Settings: PPP Mode _____	131
Port Status and Counters _____	133
Device Ports - Power Management _____	133
Device Ports - RPMs - Add Device _____	135
Device Port - Sensorsoft Device _____	137
Device Port Commands _____	138
Device Commands _____	140
Interacting with a Device Port _____	141
Device Ports - Logging and Events _____	142
Local Logging _____	142
NFS File Logging _____	142
USB and SD Card Logging _____	143
Token/Data Detection _____	143
Syslog Logging _____	143
Token & Data Detection _____	144
Local Logging _____	146
Log Viewing Attributes _____	146
NFS File Logging _____	146
USB / SD Card Logging _____	146
Syslog Logging _____	146
Logging Commands _____	147
Console Port _____	148
Console Port Commands _____	149

Internal Modem Settings _____	150
Setting Up Internal Modem Storage _____	150
Internal Modem Commands _____	154
Host Lists _____	155
Host Parameters _____	156
Host Parameters _____	157
Host List Commands _____	158
Scripts _____	159
Scripts _____	161
User Rights _____	162
Set Script CLI Commands _____	163
Show Script CLI Commands _____	164
Batch Script Syntax _____	165
Interface Script Syntax _____	165
Primary Commands _____	166
Secondary Commands _____	168
Control Flow Commands _____	169
Sample Scripts _____	170
Batch Script—SLC CLI _____	172
Sites _____	174
Modem Dialing States _____	178
Dial In _____	178
Dial-back _____	179
Dial-on-demand _____	180
Dial-in & Dial-on-demand _____	180
Dial-back & Dial-on-demand _____	181
CBCP Server and CBCP Client _____	181
CBCP Server _____	182
CBCP Client _____	182
Key Sequences _____	183

9: USB/SD Card Port 184

Set Up of USB/SD Card Storage _____	184
Data Settings _____	188
Modem Settings _____	188
Text Mode _____	189
PPP Mode _____	190
IP Settings _____	191
Manage Files _____	191
USB Commands _____	192
SD Card Commands _____	192

10: Remote Power Managers	193
Devices - RPMs _____	193
RPMs - Add Device _____	196
RPMs - Manage Device _____	199
RPMs - Outlets _____	202
RPM Shutdown Procedure _____	203
Optimizing and Troubleshooting RPM Behavior _____	205
RPM Commands _____	206
11: Connections	209
Typical Setup Scenarios for the SLC Unit _____	209
Terminal Server _____	209
Remote Access Server _____	210
Reverse Terminal Server _____	210
Multiport Device Server _____	211
Console Server _____	211
Connection Configuration _____	212
Connection Commands _____	214
12: User Authentication	217
Authentication Commands _____	219
User Rights _____	220
Local and Remote User Settings _____	221
Adding, Editing or Deleting a User _____	222
Shortcut _____	226
Local Users Commands _____	226
Local User Rights Commands _____	227
Remote User Commands _____	228
Parameters _____	228
NIS _____	229
NIS Commands _____	232
LDAP _____	233
LDAP Commands _____	238
RADIUS _____	239
RADIUS Commands _____	242
User Attributes & Permissions from LDAP Schema or RADIUS VSA _____	243
Kerberos _____	245
Kerberos Commands _____	248
TACACS+ _____	249
TACACS+ Commands _____	252
Groups _____	253
Group Commands _____	256

SSH Keys _____	257
Imported Keys _____	257
Exported Keys _____	257
Imported Keys (SSH In) _____	259
Host & Login for Import _____	259
Exported Keys (SSH Out) _____	259
Host and Login for Export _____	260
SSH Commands _____	262
Custom Menus _____	264
Custom User Menu Commands _____	267

13: Maintenance 271

Firmware & Configurations _____	271
Zero Touch Provisioning Configuration Restore _____	271
HTTPS Push Configuration Restore _____	272
Internal Temperature _____	274
Site Information _____	274
SLC Firmware _____	274
Boot Banks _____	275
Load Firmware Via Options _____	275
Configuration Management _____	276
Manage Files _____	277
Administrative Commands _____	278
System Logs _____	281
System Log Command _____	282
Audit Log _____	283
Email Log _____	284
Diagnostics _____	286
Diagnostic Commands _____	288
Status/Reports _____	291
View Report _____	291
Status Commands _____	293
Emailing Logs and Reports _____	293
Events _____	296
Events Commands _____	298
LCD/Keypad _____	299
LCD/Keypad Commands _____	300
Banners _____	301
Banner Commands _____	302

14: Application Examples 303

Telnet/SSH to a Remote Device _____	303
Dial-in (Text Mode) to a Remote Device _____	305
Local Serial Connection to Network Device via Telnet _____	306

15: Command Reference 308

Introduction to Commands _____	308
Command Syntax _____	308
Command Line Help _____	309
Tips _____	309
Administrative Commands _____	310
Audit Log Commands _____	323
Authentication Commands _____	324
Kerberos Commands _____	325
LDAP Commands _____	326
Local Users Commands _____	327
NIS Commands _____	331
RADIUS Commands _____	332
TACACS+ Commands _____	333
User Permissions Commands _____	334
Remote User Commands _____	336
CLI Commands _____	337
Description _____	338
Connection Commands _____	339
Custom User Menu Commands _____	343
Date and Time Commands _____	345
Device Commands _____	346
Device Port Commands _____	347
Diagnostic Commands _____	351
Events Commands _____	355
Group Commands _____	356
Host List Commands _____	357
Internal Modem Commands _____	358
IP Filter Commands _____	359
Logging Commands _____	360
Network Commands _____	363
NFS and SMB/CIFS Commands _____	366
Routing Commands _____	368
RPM Commands _____	368
SD Card Commands _____	371
Security Commands _____	371
Services Commands _____	372

SLC Network Commands	373
SSH Key Commands	374
Status Commands	377
System Log Commands	378
USB Access Commands	379
USB Device Commands	379
USB Storage Commands	380
USB Modem Commands	382
VPN Commands	383
Appendix A: Security Considerations	387
Security Practice	387
Factors Affecting Security	387
Appendix B: Safety Information	388
Safety Precautions	388
Fuse Caution Statement	388
Cover	388
Power Plug	388
Input Supply	389
Grounding	389
Rack	389
Port Connections	389
Appendix C: Adapters and Pinouts	390
Appendix D: Protocol Glossary	393
Appendix E: Compliance Information	395
RoHS, REACH and WEEE Compliance Statement	396

List of Figures

Figure 2-1 SLC 8048 Unit (Front Side) - Part Number SLC 804812N-01-S	23
Figure 2-2 SLC 8048 Unit Samples (Back Side) - Part Number SLC80482201S	24
Figure 2-3 Three 16-Port USB I/O Modules Installed in Bays 1, 2, & 3 with Dual Ethernet Port	27
Figure 2-4 One 16-Port USB I/O Module Installed in Bay 1 with Dual Ethernet Port	27
Figure 2-5 One 16 RJ-45 Serial Port I/O Module Installed in Bay1 & Two 15 USB I/O Module Installed Bays 2 & 3 with Dual SFP Port	27
Figure 2-6 SFP Port LEDs	28
Figure 2-8 Console Port (Front Side)	28
Figure 2-10 Dual Ethernet Network Connection	29
Figure 2-11 Inserting SFP Transceiver Module into the SFP Por	29
Figure 2-12 Dual USB Ports	30
Figure 2-13 Memory Card Port	30
Figure 2-14 Internal Modem Location	31
Figure 3-3 Product Label	34
Figure 3-7 Sample Device Port Connections (Back Side)	38
Figure 3-9 AC Power Input	40
Figure 4-2 Front Panel LCD Display and Five Button Keypad (Enter, Up, Down, Left, Right)	49
Figure 4-5 Quick Setup	53
Figure 4-6 Quick Setup Completed in Web Manager	55
Figure 4-7 Home	55
Figure 4-8 Beginning of Quick Setup Script	56
Figure 4-9 Quick Setup Completed in CLI	57
Figure 5-1 Web Page Layout	59
Figure 5-2 Sample Dashboards	60
Figure 6-1 Network > Network Settings	68
Figure 6-2 Network Settings > SFP NIC Information & Diagnostics	69
Figure 6-3 Network > IP Filter	74
Figure 6-4 Network > IP Filter Ruleset (Adding/Editing Rulesets)	76
Figure 6-5 Network > Routing	79
Figure 6-6 Network > VPN	81
Figure 6-7 Network > Security	87
Figure 7-1 Services > SSH/Telnet/Logging	90
Figure 7-2 Services > SNMP	94
Figure 7-3 Services > NFS & SMB/CIFS	99
Figure 7-4 Services > Secure Lantronix Network	102

Figure 7-5 IP Address Login Page _____	103
Figure 7-6 SSH and Telnet Opening File Popups _____	103
Figure 7-7 SSH or Telnet CLI Session _____	104
Figure 7-8 Disabled Port Number Popup Window _____	105
Figure 7-9 Services > Secure Lantronix Network > Search Options _____	106
Figure 7-10 Services > Date & Time _____	108
Figure 7-11 Services > Web Server _____	110
Figure 7-12 Web Sessions _____	113
Figure 7-13 SSL Certificate _____	114
Figure 7-14 iGoogle Gadget Example _____	117
Figure 8-2 Devices > Device Status _____	120
Figure 8-3 Devices > Device Ports _____	121
Figure 8-4 Device Ports > Settings _____	125
Figure 8-6 Device Ports - Power Management _____	134
Figure 8-7 Device Ports > RPMs - Add Device _____	136
Figure 8-8 Devices > Device Ports > Sensorsoft _____	137
Figure 8-9 Sensorsoft Status _____	138
Figure 8-10 Devices > Device Ports - Logging & Events _____	144
Figure 8-11 Devices > Console Port _____	148
Figure 8-12 Devices > Internal Modem _____	151
Figure 8-13 Devices > Host Lists _____	155
Figure 8-14 View Host Lists _____	157
Figure 8-15 Devices > Scripts _____	160
Figure 8-16 Adding or Editing New Scripts _____	161
Figure 8-21 Devices > Sites _____	175
Figure 9-1 Devices > USB / SD Card _____	185
Figure 9-2 Devices > SD Card > Configure _____	185
Figure 9-3 Devices > USB > Configure _____	186
Figure 9-4 Devices > USB > Modem _____	187
Figure 9-5 Firmware and Configurations - Manage Files _____	191
Figure 10-1 Devices > RPMs _____	193
Figure 10-2 RPM Shutdown Order _____	194
Figure 10-3 RPM Notifications _____	195
Figure 10-4 RPM Raw Data Log _____	195
Figure 10-5 RPM Logs _____	196
Figure 10-6 RPM Environmental Log _____	196
Figure 10-7 Device Ports > RPMs - Add Device _____	197
Figure 10-8 RPMs - Managed Device _____	200

Figure 10-9 RPMs - Outlets _____	203
Figure 11-1 Terminal Server _____	210
Figure 11-2 Remote Access Server _____	210
Figure 11-3 Reverse Terminal Server _____	210
Figure 11-4 Multiport Device Server _____	211
Figure 11-5 Console Server _____	211
Figure 11-6 Devices > Connections _____	212
Figure 11-7 Current Connections _____	214
Figure 12-1 User Authentication > Authentication Methods _____	218
Figure 12-3 User Authentication > Local/Remote Users _____	221
Figure 12-4 User Authentication > Local/Remote User > Add/Edit User _____	223
Figure 12-5 User Authentication > NIS _____	229
Figure 12-6 User Authentication > LDAP _____	234
Figure 12-7 User Authentication > RADIUS _____	240
Figure 12-8 User Authentication > Kerberos _____	245
Figure 12-9 User Authentication > TACACS+ _____	249
Figure 12-10 User Authentication > Groups _____	254
Figure 12-11 User Authentication > SSH Keys _____	258
Figure 12-12 Current Host Keys _____	261
Figure 12-13 User Authentication > Custom Menus _____	265
Figure 13-1 Maintenance > Firmware & Configurations _____	273
Figure 13-2 Network > Firmware/Config > Manage _____	277
Figure 13-3 Maintenance > System Logs _____	281
Figure 13-4 System Logs _____	282
Figure 13-5 Maintenance > Audit Log _____	284
Figure 13-6 Maintenance > Email Log _____	285
Figure 13-7 Maintenance > Diagnostics _____	286
Figure 13-8 Maintenance > Diagnostics _____	288
Figure 13-9 Maintenance > Status/Reports _____	291
Figure 13-10 Generated Status/Reports _____	292
Figure 13-11 Emailed Log or Report _____	294
Figure 13-12 About SLC _____	295
Figure 13-13 Maintenance > Events _____	296
Figure 13-14 Maintenance > LCD/Keypad _____	299
Figure 13-15 Maintenance > Banners _____	301
Figure 14-1 SLC - Console Manager Configuration _____	303
Figure 14-2 Remote User Connected to a SUN Server via the SLC unit _____	303
Figure 14-3 Dial-in (Text Mode) to a Remote Device _____	305

Figure 14-4 Local Serial Connection to Network Device via Telnet	306
Figure C-1 RJ45. Receptacle to DB25M DCE Adapter for the SLC unit (PN 200.2066A)	390
Figure C-2 RJ45 Receptacle to DB25F DCE Adapter for the SLC unit (PN 200.2067A)	391
Figure C-3 RJ45 Receptacle to DB9M DCE Adapter for the SLC unit (PN 200.2069A)	391
Figure C-4 RJ45 Receptacle to DB9F DCE Adapter for the SLC unit (PN 200.2070A)	392
Figure C-5 RJ45 Receptacle to DB25M DTE Adapter (PN 200.2073)	392

List of Tables

Table 2-7 Device (DCE Reversed & DTE) Port Pinout	28
Table 2-9 Console (DTE) Port Pinout	28
Table 3-1 What's in the Box	32
Table 3-2 Optional Accessories	33
Table 3-4 SLC Technical Specifications	34
Table 3-5 Console Port and Device Port - Reverse Pinout Disabled	37
Table 3-6 Device Port - Reverse Pinout Enabled (Default)	37
Table 3-8 Available I/O Module Configurations	39
Table 4-1 Methods of Assigning an IP Address	48
Table 4-3 LCD Arrow Keypad Actions	50
Table 4-4 Front Panel Setup Options with Associated Parameters	50
Table 5-3 SCS Commands	64
Table 5-4 CLI Keyboard Shortcuts	65
Table 8-1 Supported I/O Module Configurations	119
Table 8-5 Port Status and Counters	133
Table 8-17 Definitions	165
Table 8-18 Primary Commands	166
Table 8-19 Secondary Commands	168
Table 8-20 Control Flow Commands	169
Table 12-2 User Types and Rights	220
Table 15-1 Actions and Category Options	308

1: About this Guide

Purpose and Audience

This guide provides the information needed to install, configure, and use the Lantronix SLC™ 8000 Advanced Console Manager. The SLC unit is for IT professionals who must remotely and securely configure and administer servers, routers, switches, telephone equipment, or other devices equipped with a serial port for facilities that are typically remote branch offices or “distributed” IT locations.

Summary of Chapters

The remaining chapters in this guide include:

Chapter	Description
Chapter 2: Introduction	Describes the SLC 8000 models, their main features, and the protocols they support.
Chapter 3: Installation	Provides technical specifications; describes connection form factors and power supplies; provides instructions for installing the SLC 8000 advanced console manager in a rack.
Chapter 4: Quick Setup	Provides instructions for getting your SLC unit up and running and for configuring required settings.
Chapter 5: Web and Command Line Interfaces	Describes the web and command line interfaces available for configuring the SLC 8000 advanced console manager. The configuration chapters (6-12) provide detailed instructions for using the web interface and include equivalent command line interface commands.
Chapter 6: Basic Parameters	Provides instructions for configuring network ports, firewall and routing settings, and VPN.
Chapter 7: Services	Provides instructions for enabling and disabling system logging, SSH and Telnet logins, SNMP, SMTP, and the date and time.
Chapter 8: Device Ports	Provides instructions for configuring global device port settings, individual device port settings, and console port settings.
Chapter 9: USB/SD Card Port	Provides instructions for using the USB port.
Chapter 10: Remote Power Managers	Provides instructions for using RPMs.
Chapter 11: Connections	Provides instructions for configuring connections and viewing, updating, or disconnecting a connection.
Chapter 12: User Authentication	Provides instructions for enabling or disabling methods that authenticate users who attempt to log in via the web, SSH, Telnet, or the console port. Provides instructions for creating custom menus.
Chapter 13: Maintenance	Provides instructions for upgrading firmware, viewing system logs and diagnostics, generating reports, and defining events. Includes information about web pages and commands used to shut down and reboot the SLC 8000 advanced console manager.
Chapter 14: Application Examples	Shows how to set up and use the SLC unit in three different configurations.

Chapter (continued)	Description
Chapter 15: Command Reference	Lists and describes all of the commands available on the SLC command line interface
Appendix A: Security Considerations	Provides tips for enhancing SLC security.
Appendix B: Safety Information	Lists safety precautions for using the SLC 8000 advanced console manager.
Appendix C: Adapters and Pinouts	Includes adapter pinout diagrams.
Appendix D: Protocol Glossary	Lists the protocols supported by the SLC unit with brief descriptions.
Appendix E: Compliance Information	Provides information about the SLC 8000 advanced console manager's compliance with industry standards.

Additional Documentation

Visit the Lantronix Web site at www.lantronix.com/support/documentation for the latest documentation and the following additional documentation.

Document	Description
<i>SLC 8000 Advanced Console Manager Quick Start Guide</i>	Provides accessories and part number information, hardware installation instructions, directions to connect the SLC unit, and network IP configuration information.
<i>SLC 8000 Advanced Console Manager Product Brief</i>	Provides product overview information and specifications.

2: Introduction

The SLC 8000 advanced console manager enables IT system administrators to manage remote servers and IT infrastructure equipment securely over the Internet.

IT equipment can be configured, administered, and managed in a variety of ways, but most devices have one of two methods in common: via USB port and/or via an RS-232 serial port, sometimes called a console, auxiliary, or management port. These ports are often accessed directly by connecting a terminal or laptop to them, meaning that the administrator must be in the same physical location as the equipment. The SLC 8000 advanced console manager gives the administrator a way to access them remotely from anywhere there is a network or modem connection. The SLC 8000 unit can accommodate up to three I/O modules (16-port USB I/O module and/or 16-port RJ45 I/O module.)

Many types of equipment can be accessed and administered using console managers including:

- ◆ **Servers:** Unix, Linux, Windows, and others.
- ◆ **Networking equipment:** Routers, switches, storage networking.
- ◆ **Telecom:** PBX, voice switches.
- ◆ **Other systems with serial interfaces:** Heating/cooling systems, security/building access systems, UPS, medial devices.

The key benefits of using console managers:

- ◆ **Saves money:** Enables remote management and troubleshooting without sending a technician onsite. Reduces travel costs and downtime costs.
- ◆ **Saves time:** Provides instant access and reduces response time, improving efficiency.
- ◆ **Simplifies access:** Enables you to access equipment securely and remotely after hours and on weekends and holidays—without having to schedule visits or arrange for off-hour access.
- ◆ **Protects assets:** Security features provide encryption, authentication, authorization, and firewall features to protect your IT infrastructure while providing flexible remote access.

The SLC advanced console manager provides features such as convenient text menu systems, break-safe operation, port buffering (logging), remote authentication, and Secure Shell (SSH) access. Dial-up modem support ensures access when the network is not available.

Features

Console Management

- ◆ Up to 48 serial RJ45 RS-232 and/or USB type A ports for console connectivity
Note: USB ports are generally intended to connect directly to USB console ports. It is also possible to connect a USB to serial adapter to them to connect to serial console ports, if needed.
- ◆ Enables system administrators to remotely manage devices with serial and/or USB console ports, e.g., Linux, Unix, and recent versions of Windows servers, routers, telecom, and switches with RS-232C (now EIA-232) or USB compatible serial consoles in a 1U-tall rack space. All models have two Ethernet ports, called Eth1 and Eth2 in this document.
- ◆ Provides data logging, monitoring, and secure access control via the Internet

Power

- ◆ Universal AC power input (100-240V, 50/60 Hz) or 20-72 VDC power input hardware option
- ◆ Convection cooled, silent operation, low power consumption

Hardware

- ◆ **SLC Chassis:** The SLC 8000 advanced console manager has a 1U-tall (1.75 inch), self-contained rack-mountable chassis.
- ◆ **Three I/O Module Bays** are available on the back of the SLC unit, and able to accommodate a combined total of 48 device ports depending on the number of I/O modules installed. See [Figure 2-2](#). Configuration possibilities are listed below. See [Appendix C: Adapters and Pinouts on page 390](#) for more information on serial adapters and pin-outs, and also [Table 3-8 on page 39](#) which describes different I/O module configurations.
 - **Up to three 16-port RJ45 I/O modules** can be installed to provide a maximum of forty-eight serial RS-232C (EIA-232) device ports. The serial RJ45 ports match the RJ45 pin-outs of the console ports of many popular devices found in a network environment, and where different can be converted using Lantronix adapters.
 - **Up to three 16-port USB I/O modules** can be installed to provide a maximum of forty-eight USB I/O device ports.
 - **A combination of 16-port USB I/O modules and 16-port RJ45 I/O modules** can be installed to provide up to forty-eight serial RJ45 ports and/or USB type A ports, according to the type and number of I/O modules installed on the back of the SLC unit.

Note: *The SLC8008 ships with an 8-port serial module that must be installed in the first bay. This module is not available separately. See [Table 3-8 on page 39](#) which describes different I/O module configurations.*
- ◆ **Network Interface** on the back left side of the SLC unit can accommodate either a factory-installed:
 - Dual 10/100/1000 Base-T Ethernet port I/F card. Ethernet ports are referred to as Eth1 and Eth2 in the user interface and this user guide.
 - Dual SFP port I/F card to support 1 Gigabit-capable single or multi-mode fiber or copper SFP transceiver modules. Single and multi-mode SFP transceiver modules are referred to as F1 in the user interface and this user guide.

Notes:

- ◆ *1000 BASE-T SFP transceiver copper modules need to use RX_LOS signal within SFP interface pins for the indicator on Link Status LED. Not all vendor 1000 Base-T SFP modules provide this feature. Qualified copper SFP transceiver modules with this feature include the following: the Finisar 1000 Base-T Copper SFP Transceiver FCLF8250P2BTL and the Fiberstore Cisco SFP-GE-T Compatible 1000 Base-T SFP RJ-45 100m Transceiver.*
- ◆ *SFP transceiver modules are provided by users according to fiber mode and brand preferences. Network ports and the SFP port have LEDs to indicate link and activity status. If a single mode and a multi-mode are both installed the SLC 8000 unit, the device can be configured to utilize one mode at a time.*

- ◆ **Front Console Panel Ports** (see [Figure 2-1](#))
 - One serial console port (RJ45) for VT100 terminal or PC with emulation with LED for activity indicators
 - Two USB type A ports for use with flash drives or external USB modems
 - Optional internal modem
 - One Secure Digital (SD) memory card slot (SD card provided by the user)
 - One RJ11 modem port on the front panel
- Note:** Use of the RJ11 modem port requires installation of an optional modem card (Lantronix part number 56KINTMODEM-01) - see [Modem Installation on page 41](#).
- LCD display and keypad
- ◆ 256 KB-per-port buffer memory for serial device ports
 - ◆ Software reversible device port pinouts
 - ◆ Either universal AC power input (100-240V, 50/60 Hz) or DC power input (20-72 VDC)

Note: For more detailed information, see [Chapter 4: Quick Setup on page 48](#).

Figure 2-1 SLC 8048 Unit (Front Side) - Part Number SLC 804812N-01-S

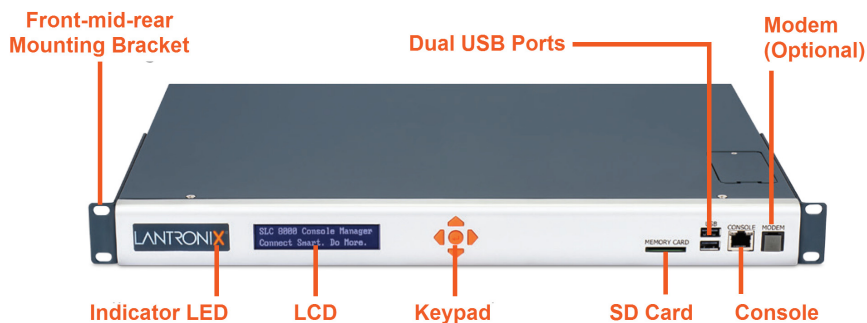
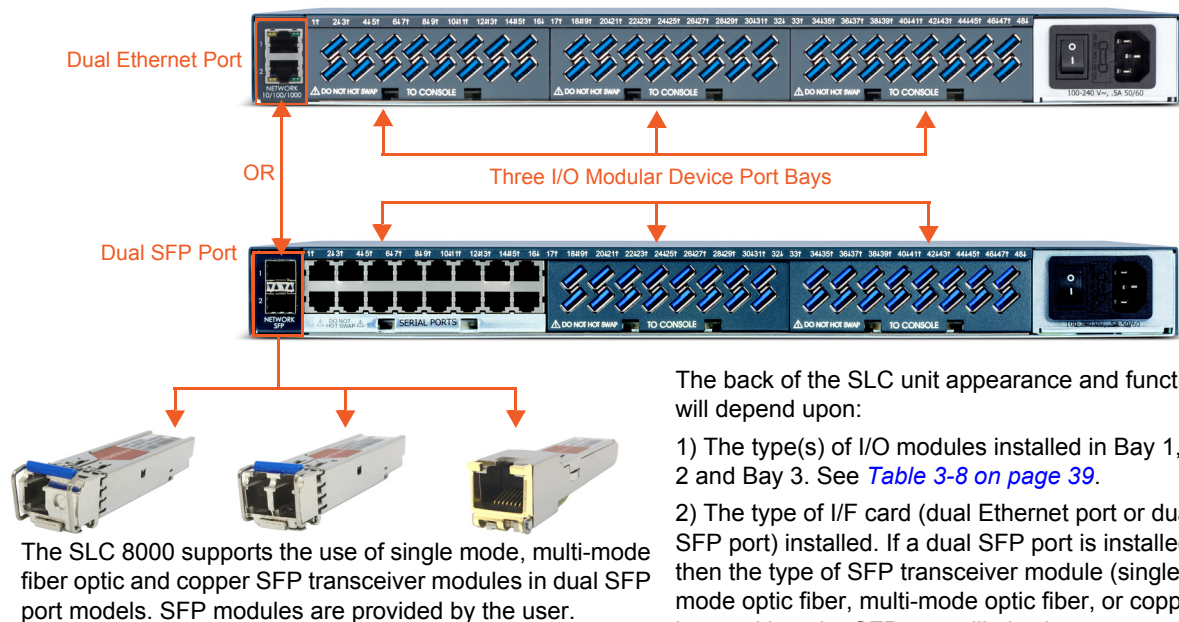

Figure 2-2 SLC 8048 Unit Samples (Back Side) - Part Number SLC80482201S



System Features

The SLC 8000 firmware has the following basic capabilities:

- ◆ Software reversible device port pinouts (serial RJ45 ports only)
- ◆ Connects up to 48 RS-232 serial consoles or up to 48 USB consoles
- ◆ Support use of simple straight-through cables for use with Cisco, Sun and other devices that use the “Cisco” RJ-45 serial pinouts
- ◆ 10/100/1000 Base-T Ethernet network compatibility or SFP port to support single or multi-mode 1 Gigabit SFP transceiver modules
- ◆ Buffer logging to file
- ◆ Email and SNMP notification
- ◆ ID/Password security, configurable access rights
- ◆ Secure shell (SSH) security; supports numerous other security protocols
- ◆ Network File System (NFS) and Common Internet File System (CIFS) support
- ◆ RAW TCP, Telnet or SSH to a serial port by IP address per port or by IP address and TCP port number
- ◆ Configurable user rights for local and remotely authenticated users
- ◆ Supports an external modem
- ◆ No unintentional break ever sent to attached servers (Solaris Ready)
- ◆ Simultaneous access on the same port - “listen” and “direct” connect mode
- ◆ Remote power manager (RPM) control of UPS and PDU devices

- ◆ Local access through a dedicated front panel serial console port
- ◆ Web administration (using most browsers)

Protocols Supported

The SLC 8000 advanced console manager supports the TCP/IP network protocol as well as:

- ◆ SSH, Telnet, PPP, NFS, and CIFS for connections in and out of the SLC console manager
- ◆ SMTP for mail transfer
- ◆ DNS for text-to-IP address name resolution
- ◆ SNMP for remote monitoring and management
- ◆ SCP, FTP and SFTP for file transfers and firmware upgrades
- ◆ TFTP for firmware upgrades
- ◆ DHCP and BOOTP for IP address assignment
- ◆ HTTPS (SSL) for secure browser-based configuration
- ◆ NTP for time synchronization
- ◆ LDAP, NIS, RADIUS, CHAP, PAP, Kerberos, TACACS+, and SecurID (via RADIUS) for user authentication
- ◆ Callback Control Protocol (CBCP)
- ◆ IPsec for VPN access

For brief descriptions of these protocols, see [Appendix D: Protocol Glossary on page 393](#).

Access Control

The system administrator controls access to attached servers or devices by assigning access rights to up to 128 user profiles. Each user has an assigned ID, password, and access rights. Other user profile access options may include externally configured authentication methods such as Radius and LDAP.

Device Port Buffer

The SLC 8000 unit supports real-time data logging for each device port. The port can save the data log to a file, send an email notification of an issue, or take no action.

You can define the path for logged data on a port-by-port basis, configure file size and number of files per port for each logging event, and configure the device log to send an email alert message automatically to the appropriate parties indicating a particular error.

Configuration Options

You may use the backlit front-panel LCD display for initial setup and configuration and to view current network, console, and date/time settings, and get internal temperature status.

Both a web interface viewed through a standard browser and a command line interface (CLI) are available for configuring the SLC settings and monitoring performance.

Device Port and Console Port Interfaces

RS-232 RJ45 Interface

Device ports are located on the back of the SLC 8000 unit (please see [Figure 2-2](#)). The console port is located on the front of the SLC 8000 unit (please see [Figure 2-8](#)). All devices attached to the device ports and the console port must support the RS-232C (EIA-232) standard. For serial RJ45 device ports and the console port, RJ45 cabling (e.g., category 5 or 6 patch cabling) is used.

Serial RJ45 device ports for the SLC 8000 advanced console manager are reversed by default so that straight-through RJ45 patch cables may be used to connect to Cisco and Sun RJ45 serial console ports. If you are replacing an SLC with an SLC 8000 you can either switch the ports to the non-reversed pinout used by SLC units and use your original cables and adapters, or remove any rolled cables or adapters and replace them with straight-through RJ45 cables, e.g. Ethernet patch cables.

Note: RJ45 to DB9/DB25 adapters are available from Lantronix. For serial pinout information, see the [Appendix C: Adapters and Pinouts on page 390](#).

Device ports and the console port support the following baud-rate options: 300, 600, 1200, 2400, 4800, 9600, 19200, 38400, 57600, 115200 and 230400 baud.

USB Interface

The SLC unit can contain up to up to three I/O modules comprised of 16-port USB I/O module(s) and/or 16-port RJ45 I/O module(s) installed in the three module bays available from the back of the SLC 8000 unit. USB device ports can be used with a USB type A connector to serial adapter, if needed.

[Figure 2-3](#) shows an SLC unit containing two 16-port RJ45 I/O modules installed in Bay 1 and Bay 2 for a total of 32 serial RJ45 device ports and one 16-port USB I/O module installed in Bay 3, for a total of 48 device ports. [Figure 2-4](#) shows an SLC unit containing three 16-port RJ45 I/O modules installed in Bay 1, Bay 2 and Bay 3 for a total of 48 serial RJ45 device ports.

Note: When installing I/O modules into an SLC 8000 ([Figure 2-2](#)), Bay 1, Bay 2, and Bay 3 must be populated in order. The 8-port RJ45 serial module is supported on Bay 1 only.

I/F Card Slot: Dual Small Form-Factor Pluggable (SFP) or Dual Ethernet Port

On the left back side of the SLC 8000 unit, a dual SFP port or dual Ethernet port I/F card can be installed. See [Figure 2-5](#). If the dual SFP port is installed, copper or optic fiber 1 Gigabit SFP transceiver modules may be used. The SLC 8000 supports use of single and multi-mode SFPs.

Figure 2-3 Three 16-Port USB I/O Modules Installed in Bays 1, 2, & 3 with Dual Ethernet Port

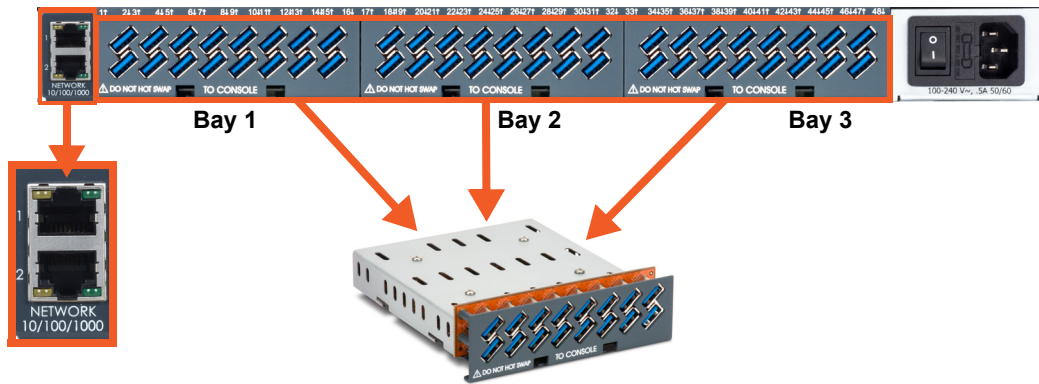

Figure 2-4 One 16-Port USB I/O Module Installed in Bay 1 with Dual Ethernet Port

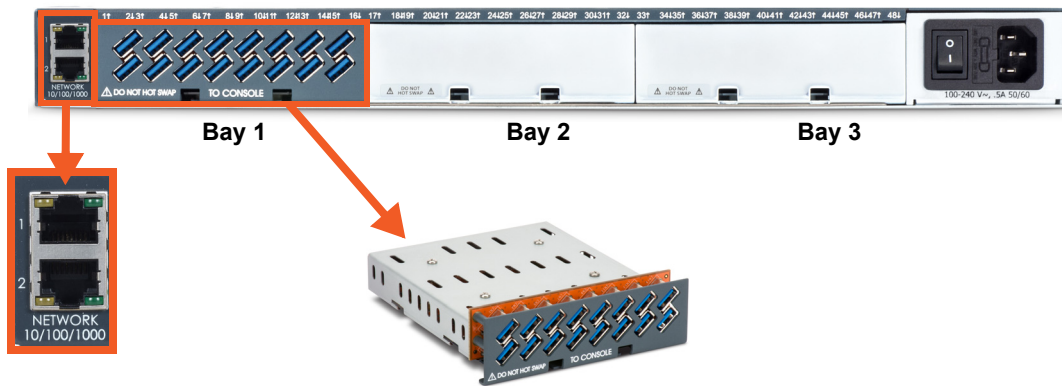

Figure 2-5 One 16 RJ-45 Serial Port I/O Module Installed in Bay1 & Two 15 USB I/O Module Installed Bays 2 & 3 with Dual SFP Port

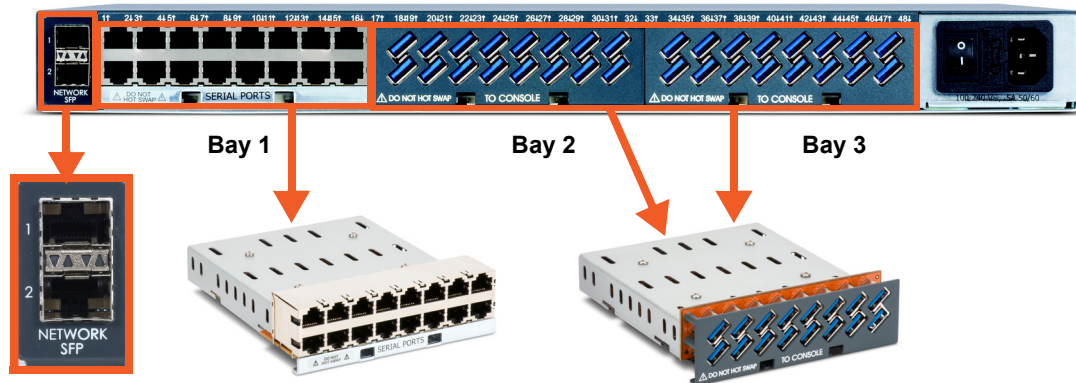

Figure 2-6 SFP Port LEDs

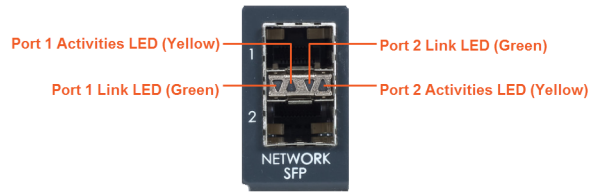

Table 2-7 Device (DCE Reversed & DTE) Port Pinout

DCE Pin	DTE Pin	Description
8	1	RTS (output)
7	2	DTR (output)
6	3	TXD (output)
5	4	Ground
4	5	Ground
3	6	RXD (input)
2	7	DSR (input)
1	8	CTS (input)

Figure 2-8 Console Port (Front Side)

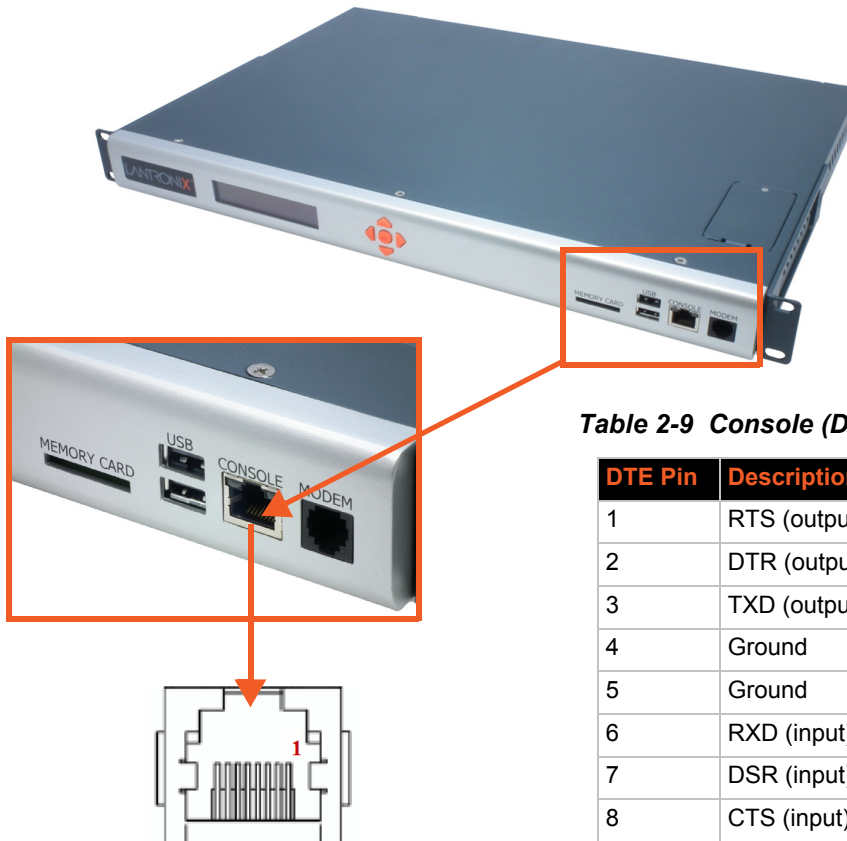

Table 2-9 Console (DTE) Port Pinout

DTE Pin	Description
1	RTS (output)
2	DTR (output)
3	TXD (output)
4	Ground
5	Ground
6	RXD (input)
7	DSR (input)
8	CTS (input)

Network Connections

The SLC 8000 network interfaces are 10/100/1000 Base-T Ethernet for use with a conventional Ethernet network as shown in [Figure 2-10](#). Use standard RJ45-terminated cables, like Category 5 or 6 patch cable. CAT5E or better cables are recommended for 1000 Base Ethernet. Network parameters must be configured before the SLC console manager can be accessed over the network.

Note: One possible use for the two Ethernet ports is to have one port on a private, secure network and the other on a public, unsecured network. The SLC 8000 can also be equipped with a factory-installed NIC (Ethernet RJ45 or SFP ports). The NIC with SFP ports can support single/multi-mode fiber or copper SFP transceiver modules at 1 Gigabit speed.

Figure 2-10 Dual Ethernet Network Connection

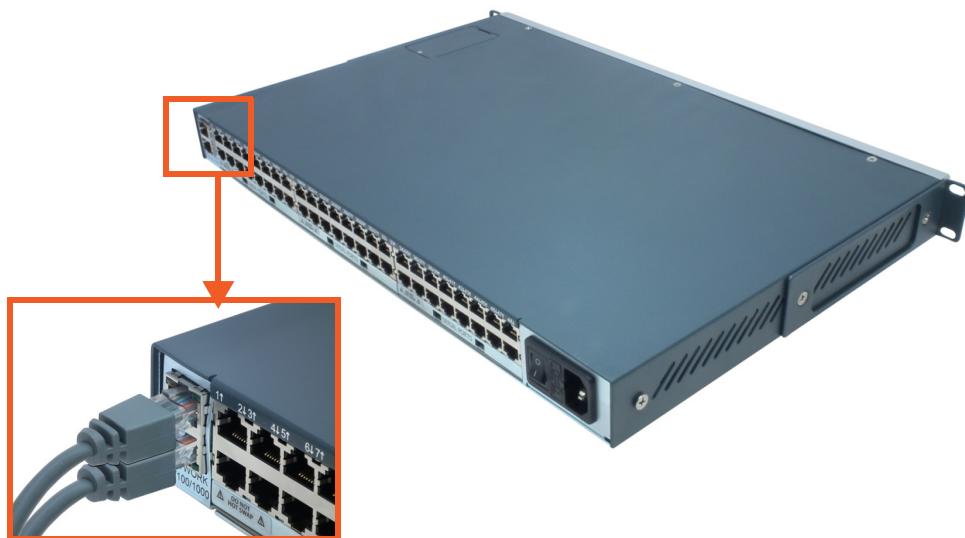
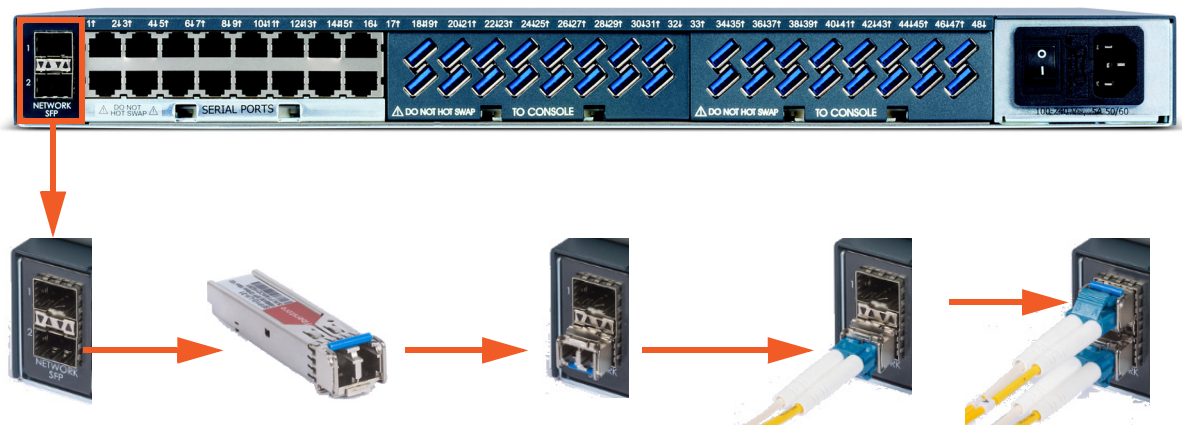

Figure 2-11 Inserting SFP Transceiver Module into the SFP Port



Front Panel USB Ports

The SLC 8000 unit has two 2.0 USB ports (HS, FS, LS) on the front panel, as seen in [Figure 2-12](#).

Figure 2-12 Dual USB Ports



Memory Card Port

The SLC unit has a memory card port on the front panel of the unit which accepts SD cards.

Figure 2-13 Memory Card Port



Internal Modem

An internal modem can be installed in the SLC 8000 advanced console manager. See [Modem Installation on page 41](#) for instructions.

Figure 2-14 Internal Modem Location



3: Installation

This chapter provides a high-level procedure for installing the SLC advanced console manager followed by more detailed information about the SLC connections and power supplies.

Caution: To avoid physical and electrical hazards, please read [Appendix A: Security Considerations on page 387](#) before installing the SLC 8000 advanced console manager.

What's in the Box

[Table 3-1](#) lists all included components that come in the box and their corresponding part numbers.

Table 3-1 What's in the Box

Part Number	Component Description
SLC 8000 Advanced Console Manager Models	
SLC80162211S	SLC 8000 Advanced Console Manager with RJ45 16-Port, Dual SFP, Dual AC PSU
SLC80162411S	SLC 8000 Advanced Console Manager with RJ45 16-Port, Dual SFP, Dual DC PSU
SLC80322211S	SLC 8000 Advanced Console Manager with RJ45 32-Port, Dual SFP, Dual AC PSU
SLC80482211S	SLC 8000 Advanced Console Manager with RJ45 48-Port, Dual SFP, Dual AC PSU
SLC81162211S	SLC 8000 Advanced Console Manager with USB 16-Port, Dual SFP, Dual AC PSU
SLC81162411S	SLC 8000 Advanced Console Manager with USB 16-Port, Dual SFP, Dual DC PSU
SLC80081201S*	SLC 8000 Advanced Console Manager with RJ45 8-Port, Dual Ethernet, Single AC PSU
SLC80082201S*	SLC 8000 Advanced Console Manager with RJ45 8-Port, Dual Ethernet, Dual AC PSU
SLC81161201S*	SLC 8000 Advanced Console Manager with USB 6-Port, Dual Ethernet, Single AC PSU
SLC80161201S*	SLC 8000 Advanced Console Manager with RJ45 16-Port, Dual Ethernet, Single AC PSU
SLC80162201S	SLC 8000 Advanced Console Manager with RJ45 16-Port, Dual Ethernet, Dual AC PSU
SLC80162401S	SLC 8000 Advanced Console Manager with RJ45 16-Port, Dual Ethernet, Dual DC PSU
SLC80321201S*	SLC 8000 Advanced Console Manager with RJ45 32-Port, Dual Ethernet, Single AC PSU
SLC80322201S*	SLC 8000 Advanced Console Manager with RJ45 32-Port, Dual Ethernet, Dual AC PSU
SLC80322401S	SLC 8000 Advanced Console Manager with RJ45 32-Port, Dual Ethernet, Dual DC PSU
SLC80481201S*	SLC 8000 Advanced Console Manager with RJ45 48-Port, Dual Ethernet, Single AC PSU
SLC80482201S*	SLC 8000 Advanced Console Manager Serial RJ45 48-Port, Dual Ethernet, Dual AC PSU
SLC80482401S	SLC 8000 Advanced Console Manager Serial RJ45 48-Port, Dual Ethernet, Dual DC PSU
Cables	
200.2070A	RJ45 to DB9F Adapter Note: Available only with SLC 8000 units with RJ-45 modules.
200.0062	RJ45 to RJ45, Cat5, 6.6 ft (2 m) Note: Available only with SLC 8000 units with GbE variants.

Part Number	Component Description
500-153	RJ45 Loopback Plug <i>Note: Available only with SLC 8000 units with RJ-45 modules.</i>
North American Power Cords	
500-041-ACC	For AC Supply Models, USA & Canada: 110V AC Power Cord, 8 ft (2.43 m), RoHS. <i>Note: Power cords for other international regions are available and sold separately. See Table 3-2.</i>
083-152-ACC	For DC Supply Models, USA & Canada: the DC Installation Kit is included.

Notes:

- ◆ Accessories that can be ordered separately are listed below in [Table 3-2](#). Regional power cords are available as accessories.
- ◆ SLC 8000 single and dual AC supply variants ship with 110V North American AC power cord(s).
- ◆ * TAA Compliant models available, replace the “S” with “G” in the SKUs above, (e.g. SLC80321201G for 16-Port RS-232 (RJ45) Single AC Supply).

Table 3-2 Optional Accessories

Part Number	Component Description
International Power Cords:	
930-077-R	Power Cord, Israel, 250VAC 10A, 8FT, RoHS
930-075-R	Power Cord, UK, 250VAC 10A, 8FT, RoHS
930-074-R	Power Cord, European, 250VAC 10A, 8FT, RoHS
User Swappable Modules	
FRRJ451601	16 Device Port RS-232 (RJ45) I/O Device Port Module
FRUSB1601	16 Device Port USB I/O Device Port Module
FR1ACPS01	100 to 240V AC Single Power Supply Module
FR2ACPS01	100 to 240V AC Dual Power Supply Module
FR2DCPS01	-20 to -72V DC Dual Power Supply Module
Secondary Connectivity Accessories for SLC 8000	
56KINTMODEM-0156K v.92	Internal Modem for Dial-UP Out-of-Band Connection
PXC2102H2-01-S	3.5G Cellular Out-of-Band Connectivity Intelligent Gateway <i>Note: Wireless data plan sold separately.</i>

Verify and inspect the contents of the SLC package using the enclosed packing slip or the table above. If any item is missing or damaged, contact your place of purchase immediately.

Product Label

The product label on the underside of the SLC 8000 advanced console manager contains the following information about each SLC unit:

- ◆ Part Number
- ◆ Product Revision
- ◆ Country of Manufacturing Origin
- ◆ Serial Number
- ◆ Manufacturing Date Code
- ◆ Bar Code



Figure 3-3 Product Label



Technical Specifications

Table 3-4 SLC Technical Specifications

Component	Description
Serial Interface (Device)	<ul style="list-style-type: none"> ◆ Up to 48 RJ45-type 8-conductor connectors as up to three 16-port RJ45 I/O modules can be installed. These connectors have individually configurable standard and reversible pinouts, 8 or 16 ports per I/O module. ◆ Speed software selectable (300 to 230400 baud) <p>Note: Serial RJ45 device ports for the SLC 8000 advanced console manager are reversed by default. Do not use rolled cables and adapters when replacing an SLC console manager with the SLC 8000 model.</p>
USB 2.0 Interface (Device)	<ul style="list-style-type: none"> ◆ Up to 48 USB type A (Host) as up to three 16-port USB I/O modules can be installed ◆ HS, FS, and LS ◆ Capable of providing VBUS 5V up to 100 mA per port, but not to exceed 600 mA total per 16-port USB I/O module. ◆ May be used with a USB-to-serial adapter to connect a serial device, if needed. Please contact Lantronix for the list of tested adapters. <p>Caution: USB ports are designed for data traffic only. They are not designed for charging or powering devices. Over-current conditions on VBUS 5V may disrupt operations.</p>

Component (continued)	Description
Serial Interface (Console)	<ul style="list-style-type: none"> ◆ (1) RJ45-type 8-pin connector (DTE) ◆ Speed software selectable (300 to 230400 baud) ◆ LEDs: <ul style="list-style-type: none"> ➢ Green light ON indicates data transmission activities ➢ Yellow light ON indicates data receiving activities
Network Interface	<ul style="list-style-type: none"> ◆ (2) 10/100/1000 Base-T RJ45 Ethernet with LED indicators: <ul style="list-style-type: none"> ➢ Green light ON indicates a link at 1000 Base-T. ➢ Green light OFF indicates a link at other speeds or no link. ➢ Yellow light ON indicates a link is established. ➢ Yellow light blinking indicates activity. <p>OR</p> <ul style="list-style-type: none"> ◆ (2) SFP ports to support standard fiber or copper SFP transceiver modules (single or multi-mode) at speed 1 Gigabit. LED indicators: <ul style="list-style-type: none"> ➢ Green light ON indicates a link is established. ➢ Green light OFF indicates no link. ➢ Yellow light ON indicates no link activity. ➢ Yellow light blinking indicates activity.
Power Supply AC (single or dual)	<ul style="list-style-type: none"> ◆ Universal AC power input: 100-240 VAC ◆ 50 or 60 Hz IEC 60320/C19IEC-type regional cord set included
Power Supply DC (dual)	20V to 72V input
Power Consumption	<ul style="list-style-type: none"> ◆ Less than 25W with 48 RS232 serial ports ◆ Less than 45W with 48 USB ports
Dimensions	1U, 1.75 in x 17.25 in x 12 in
Weight	<ul style="list-style-type: none"> ◆ 12.1 lbs with 48 serial ports ◆ 11.8 lbs with 48 USB ports
Temperature	<ul style="list-style-type: none"> ◆ Operating: 0 to 50°C (32 to 122°F), 30 to 90% RH, non-condensing ◆ Storage: -20 to 80°C (-4 to 176°F), 10 to 90% RH, non-condensing
Relative Humidity	<ul style="list-style-type: none"> ◆ Operating: 10% to 90% non-condensing; 40% to 60% recommended ◆ Storage: 10% to 90% non-condensing
Front USB Ports	◆ (2) ports, type A, host USB 2.0 (HS, FS, LS)
Memory Card	Single memory card slot supporting: <ul style="list-style-type: none"> ◆ SD ◆ SDHC
Optional Internal Modem	<ul style="list-style-type: none"> ◆ 300 bps to 56K bps data rate ◆ Upstream 48K bps, downstream 56K bps ◆ V.44 data compression (V92MB-U, V92HU) ◆ V.42 bis and MNP-5 data compression ◆ V.29 FastPOS support ◆ Caller ID type I and II for select countries ◆ Agency approvals: Transferable FCC68, CS03 and CTR21 certifications, IEC60601-1 (Medical Electronics) compliant, CE Marking, IEC60950 approved
Operating Atmosphere	 For use at altitudes no more than 2000 meters above sea level only. 仅适用于海拔 2000m 以下地区安全使用
Caution: EQUIPMENT IS FOR INDOOR USE ONLY!	 For use in non-tropical conditions only. 仅适用于非热带气候条件下安全使用

Physical Installation

Install the SLC 8000 advanced console manager in an EIA-standard 19-inch rack (1U tall) or as a desktop unit. The SLC module uses convection cooling to dissipate excess heat.

To install the SLC 8000 advanced console manager in a rack:

1. Place the SLC unit in a 19-inch rack.

Warning: *Do not to block the air vents on the sides of the SLC module. If you mount the SLC advanced console manager in an enclosed rack, we recommended that the rack have a ventilation fan to provide adequate airflow through the SLC unit.*

2. Connect the serial device(s) to the SLC unit ports. See the section, [Connecting to a Device Port \(on page 36\)](#).
3. Choose one of the following options:
 - To configure the SLC 8000 advanced console manager using the network, or to monitor serial devices on the network, connect at least one SLC network port to a network. See [Connecting to Network Ports \(on page 39\)](#).
 - To configure the SLC unit using a dumb terminal or a computer with terminal emulation, connect the terminal or PC to the front panel SLC console port. See [Connecting Terminals \(on page 39\)](#).
4. Connect the power cord, and apply power. See [AC Input \(on page 40\)](#).
5. Wait approximately one minute for the boot process to complete.

When the boot process ends, the SLC host name and the clock appear on the LCD display. Now you are ready to configure the network settings as described in [Chapter 4: Quick Setup](#).

Connecting to a Device Port

You can connect almost any device that has a serial console port to a device port on the SLC 8000 unit for remote administration. The console port must support the RS-232C interface.

Note: *Many servers must either have the serial port enabled as a console or the keyboard and mouse detached. Consult the server hardware and/or software documentation for more information.*

To connect to a serial RJ45 device port:

1. Connect one end of the Cat 5 cable to the device port.
2. Connect the other end of the Cat 5 cable to an RJ45 serial console port or to other port types using a Lantronix serial console adapter.

Notes:

- ◆ See [Device Port Commands](#) to enable or disable reverse pinouts through the CLI.
 - ◆ [Table 3-5](#) and [Table 3-6](#) provide additional information on reverse pinouts.
 - ◆ See [Appendix C: Adapters and Pinouts](#) for information about Lantronix adapters.
3. Connect the adapter to the serial console port on the serial device as shown in [Figure 3-7](#).

Table 3-5 Console Port and Device Port - Reverse Pinout Disabled

Pin Number	Description
1	RTS (output)
2	DTR (output)
3	TXD (output)
4	Ground
5	Ground
6	RXD (input)
7	DSR (input)
8	CTS (input)

Table 3-6 Device Port - Reverse Pinout Enabled (Default)

Pin Number	Description
1	CTS (input)
2	DSR (input)
3	RXD (input)
4	Ground
5	Ground
6	TXD (output)
7	DTR (output)
8	RTS (output)

To connect to a USB device port:

1. Connect the USB type A connector of a USB cable to a device port.
2. Connect the other end of the USB cable to a USB console port.

Figure 3-7 shows a sample I/O module installation with two 16-port RJ45 I/O modules and one 16-port USB I/O module, and how the device ports correspond to the buttons on the [Dashboard](#).

Figure 3-7 Sample Device Port Connections (Back Side)

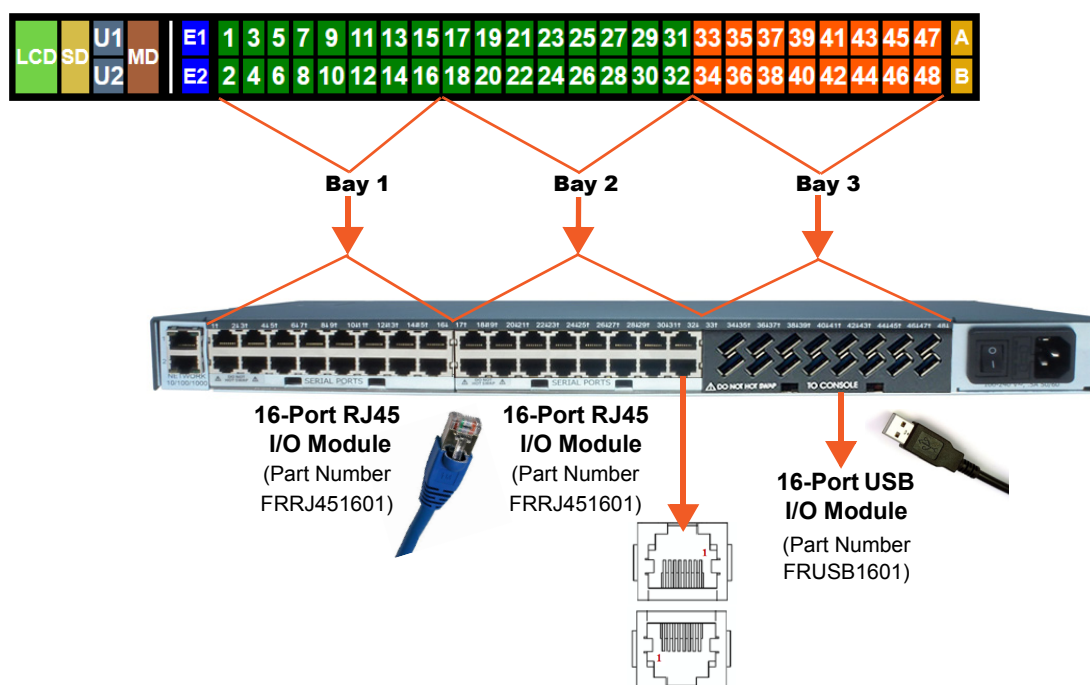

Modular Expansion for I/O Module Bays

The SLC 8000 advanced console manager, which provides 3 separate bays, supports the flexibility to change the I/O module configuration by offering a 16-port module for expansion. When populating the bays, Bay 1, Bay 2 and Bay 3 must be populated in consecutive order. Bay 1 is the slot next to the Ethernet ports and Bay 3 is the slot beside the power supply module. See [Figure 3-7](#) and [Table 3-8](#). When device ports are unused or unsupported, they do not appear in the [Dashboard](#). See [Sample Dashboards](#).

Note: See the [SLC 8000 I/O Module Installation Guide](#) for information on installing I/O modules.

Table 3-8 Available I/O Module Configurations

Examples of Available I/O Configurations		
Model	Ports	Final Configuration
Standard	8	
Standard	16	
Customized	24	
Standard	32	
Customized		
Customized	40	
Standard	48	
Customized		
Customized		
Customized	24	
Customized	32	
Customized	48	
Customized	48	
Customized	48	

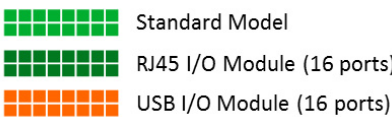



Note: The 8-port RJ45 serial module is supported on Bay 1 only. The available I/O module configurations in Table 3-8 are supported with either dual Gigabit Ethernet or dual SFP ports.

Connecting to Network Ports

The SLC network ports, 10/100/1000 Base-T Ethernet, allow remote access to the attached devices and the system administrative functions. Use a standard RJ45-terminated Category 5 cable to connect to the network port. A CAT5e or better cable is recommended for use with a 1000 Base-T Ethernet connection.

Note: One possible use for the two Ethernet ports is to have one port on a private, secure network, and the other on an unsecured network.

Connecting Terminals

The console port is for local access to the SLC 8000 advanced console manager and the attached devices. You may attach a dumb terminal or a computer with terminal emulation to the console port. The SLC console port uses RS-232C protocol and supports VT100 emulation. The default serial settings are 9600 baud, 8 bit data, No parity, 1 stop bit with no flow control.

To connect the console port to a terminal or computer with terminal emulation, Lantronix offers optional adapters that provide a connection between an RJ45 jack and a DB9 or DB25 connector. The console port is configured as DTE (non-reversed RJ45). See [Appendix C: Adapters and Pinouts on page 390](#) for more information.

To connect a terminal:

1. Attach the Lantronix adapter to your terminal (typically a PN 200.2066A adapter - see [Figure C-1](#)) or your PC's serial port (use PN 200.2070A adapter - see [Figure C-4](#)).
2. Connect the Cat 5 cable to the adapter, and connect the other end to the SLC console port.
3. Turn on the terminal or start your computer's communication program (e.g., PuTTY or TeraTerm Pro).
4. Once the SLC 8000 advanced console manager is running, press **Enter** to establish connection. You should see the model name and a login prompt on your terminal. On a factory default SLC you may log in with the user name **sysadmin** and the password **PASS**.

AC Input

The power supply module for the SLC controller accepts AC input voltage of 100-240 VAC, 50/60 HZ. Rear-mounted IEC-type AC power connectors are provided for universal AC power input. (See [What's in the Box on page 32](#).)

Warning: *Disconnect all power supply modules before servicing to avoid electric shock.*

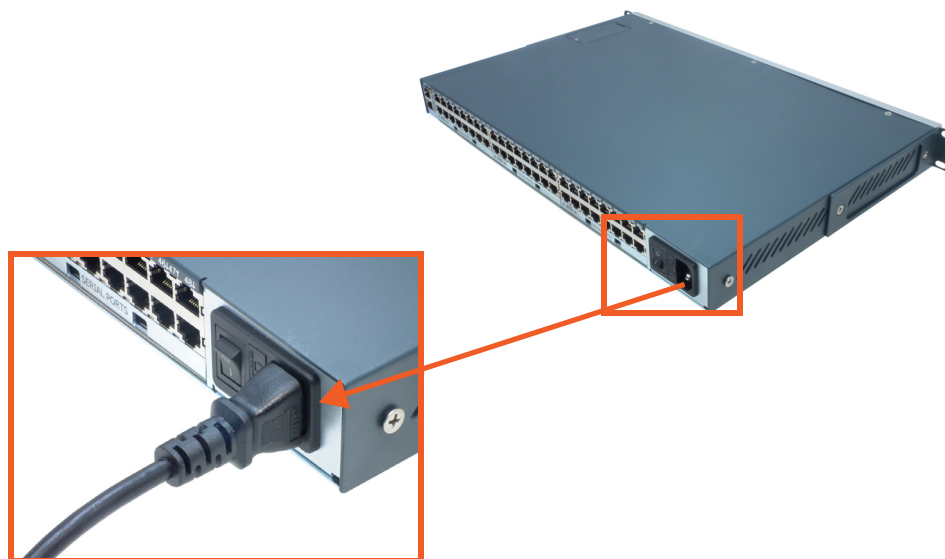
Figure 3-9 AC Power Input

Modem Installation



Caution: TO REDUCE THE RISK OF FIRE, USE ONLY NO. 26 AWG OR LARGER (e.g., 24 AWG) UL LISTED OR CSA CERTIFIED TELECOMMUNICATION LINE CORD.

Attention: POUR RÉDUIRE LES RISQUES D'INCENDIE, UTILISER UNIQUEMENT DES CONDUCTEURS DE TÉLÉCOMMUNICATIONS 26 AWG AU DE SECTION SUPÉRIEURE.

Warning: RISK OF ELECTRICAL SHOCKS; DISCONNECT ALL POWER AND PHONE LINES BEFORE SERVICING!



Caution: DEVICES INSIDE THE EQUIPMENT AND THE MODEM ARE ELECTROSTATIC -SENSITIVE; DO NOT HANDLE EXCEPT AT A STATIC FREE WORKPLACE.

MODEM PART NUMBER

Lantronix 56KINTMODEM-01

MODEM SERVICING INSTRUCTIONS

You will need a medium size Phillips screw driver.

1. Turn off power to the SLC 8000 advanced console manager.
2. Locate the battery modem door on the top of the SLC unit.

3. Carefully unscrew and lift the door off with the screw driver.

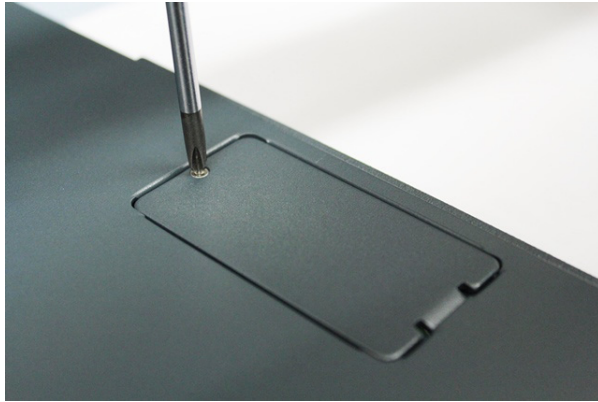

4. Take note of the orientation of the modem in the photograph so that you can install a new modem correctly with the same orientation.



5. If there is a modem replacement, carefully lift the old modem out of its socket.



6. Install the new modem with correct orientation.

7. Make sure to have correct pin alignment.



8. Press the modem down to make sure it sits down all the way in the socket.



9. Double-check the new modem placement to make sure it is done properly.
10. Place the battery/modem door back.
11. Carefully tighten the door screw.

Battery Replacement



Caution: *RISK OF EXPLOSION IF BATTERY IS REPLACED BY AN INCORRECT TYPE. DISPOSE OF USED BATTERIES ACCORDING TO THE INSTRUCTIONS.*

Attention: *IL Y A DANGER D'EXPLOSION S'IL Y A REMPLACEMENT INCORRECT DE LA BATTERIE. REMPLACER UNIQUEMENT AVEC UNE BATTERIE DU MÊME TYPE OU D'UN TYPE EQUIVALENT RECOMMANDÉ PAR LE CONSTRUCTEUR. METTRE AU REBUT LES BATTERIES USAGÉES CONFORMÉMENT AUX INSTRUCTIONS DU FABRICANT.*



Caution: *DEVICES INSIDE THE EQUIPMENT ARE ELECTROSTATIC -SENSITIVE; DO NOT HANDLE EXCEPT AT A STATIC FREE WORKPLACE.*

Battery Part Numbers

Panasonic BR2032 or equivalent (button cell lithium, non-rechargeable.)

Caution: *DO NOT USE BATTERY TYPE CR2032 SINCE IT HAS A LOWER OPERATING TEMPERATURE RANGE.*

DISPOSAL OF USED BATTERIES (from battery data sheet)

- ◆ If not in a large quantity, button cell batteries contain so little Lithium that they do not qualify as reactive hazardous waste. These batteries are safe for disposal in the normal municipal waste stream.
- ◆ If in a large quantity, disposal of button cell batteries should be performed by permitted, professional firms knowledgeable in Federal, State and local hazardous waste transportation and disposal requirements.

Caution: *RISK OF FIRE, EXPLOSION AND BURNS. DO NOT RECHARGE, CRUSH, HEAT ABOVE 212°F (100°C) OR INCINERATE.*

Battery Replacement Instructions

Warning: *RISK OF ELECTRICAL SHOCKS; DISCONNECT ALL POWER AND PHONE LINE BEFORE SERVICING!*

You will need a medium size Phillips screw driver.

1. Turn off power to the SLC 8000 advanced console manager.
2. Locate the battery/modem door on the top of the SLC unit.
3. Carefully unscrew and lift the door off with the screw driver.

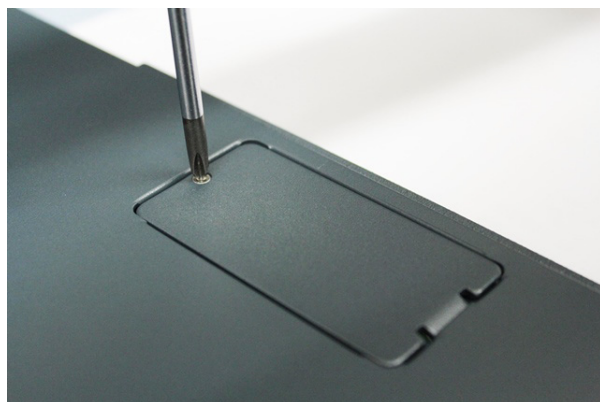

4. If there is a modem installed, note the orientation of the modem so that later you can install it back correctly.



5. If there is a modem installed, carefully lift the modem out of its socket.



6. Use fingers to lift the battery out of the socket.



Caution: **DO NOT USE A METAL OBJECT TO PRY OUT THE BATTERY. IT MAY SHORT THE BATTERY AND DAMAGE THE BATTERY HOUSING.**

7. Install the new battery with the (+) side up making sure the battery sits completely and securely in the housing.



8. Re-install the modem with correct orientation.
 - a. Make sure also to have correct pin alignment.

- b. Press the modem down to make sure it sits down all the way in the socket.



9. Double-check the battery and modem placements to make sure they are done properly.
10. Place the battery/modem door back.
11. Carefully tighten the door screw.
12. If necessary, reprogram the SLC system date-time after installing a new battery.

4: Quick Setup

This chapter helps get the IP network port up and running quickly, so you can administer the SLC advanced console manager using your network.

Recommendations

To set up the network connections quickly, we suggest you do one of the following:

- ◆ Use the front panel LCD display and keypad buttons to configure the IP address, subnet mask, gateway address and DNS address(es), if applicable.
- ◆ Complete the quick setup (see [Figure 4-5](#)) on the web interface.
- ◆ SSH to the command line interface and follow the Quick Setup script on the command line interface.
- ◆ Connect to the console port and follow the Quick Setup script on the command line interface.

Note: *The first time you power up the SLC unit, Eth1 tries to obtain its IP address via DHCP. If you have connected Eth1 to the network, and Eth1 is able to acquire an IP address, you can view this IP address on the LCD or by running the Lantronix DeviceInstaller™ application. If Eth1 cannot acquire an IP address, you cannot use Telnet, SSH, or the web interface to run Quick Setup.*

IP Address

Your SLC 8000 advanced console manager must have a unique IP address on your network. The system administrator generally provides the IP address and corresponding subnet mask and gateway. The IP address must be within a valid range and unique to your network. If a valid gateway address has not been assigned the IP address must be on the same subnet as workstations connecting to the SLC 8000 over the network.

The following table lists the options for assigning an IP address to your SLC unit.

Table 4-1 Methods of Assigning an IP Address

Method	Description
DHCP	A DHCP server automatically assigns the IP address and network settings. The SLC 8000 advanced console manager is DHCP-enabled by default. With the Eth1 network port connected to the network, and the SLC unit powered up, Eth1 acquires an IP address, viewable on the LCD. At this point, you can use SSH to connect to the SLC console manager or use the web interface.
BOOTP	Non-dynamic predecessor to DHCP.
Front panel LCD display and keypads	You manually assign the IP address and other basic network, console, and date/time settings. If desired, you can restore the factory defaults.
Serial port login to command line interface	You assign an IP address and configure the SLC unit using a terminal or a PC running a terminal emulation program to the SLC serial console port connection.

Method #1 Using the Front Panel Display

Before you begin, ensure that you have:

- ◆ Unique IP address that is valid on your network (unless automatically assigned)
- ◆ Subnet mask (unless automatically assigned)
- ◆ Gateway (unless automatically assigned)
- ◆ DNS settings (unless automatically assigned)
- ◆ Date, time, and time zone
- ◆ Console port settings: baud rate, data bits, stop bits, parity, and flow control

Make sure the SLC advanced console manager is plugged into power and turned on.

Front Panel LCD Display and Keypads

With the SLC unit powered up, you can use the front panel display and buttons to set up the basic parameters.

Figure 4-2 Front Panel LCD Display and Five Button Keypad (Enter, Up, Down, Left, Right)

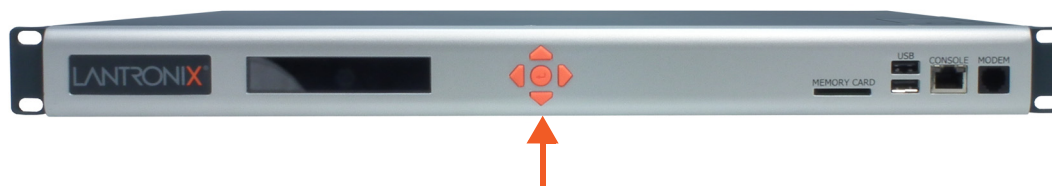

The front panel display initially shows the hostname (abbreviated to 14 letters) and the date and time.

When you click the right-arrow button, the SLC network settings displays. Using the five buttons on the keypad, you can change the network, console port, and date/time settings and view the firmware release version. If desired, you can restore the factory defaults.

Note: *Have your information handy as the display times out without accepting any unsaved changes if you take more than 30 seconds between entries.*

Any changes made to the network, console port, and date/time settings take effect immediately.

Navigating



The front panel keypad has one **Enter** button (in the center) and four arrow buttons (up, left, right, and down). Press the arrow buttons to navigate from one option to another, or to increment or decrement a numerical entry of the selected option. Use the **Enter** button to select an option to change or to save your settings.



The following table lists the SLC navigation actions, buttons, and options.

Table 4-3 LCD Arrow Keypad Actions

Button	Action
Right arrow	To move to the next option (e.g., from Network Settings to Console Settings)
Left arrow	To return to the previous option
Enter (center button)	To enter edit mode
Up and down arrows	Within edit mode, to increase or decrease a numerical entry
Right or left arrows	Within edit mode, to move the cursor right or left
Enter	To exit edit mode
Up and down arrows	To scroll up or down the list of parameters within an option (e.g., from IP Address to Mask)

Table 4-4 Front Panel Setup Options with Associated Parameters

 Left/Right Arrow 

	Current Time	Eth1 Network Settings	Console Port Settings	Date / Time Settings	Release	Internal Temp	User Strings	Location	Device Ports
 Up/ Down Arrow 	User ID & Current Time	Eth1 IP Address	Baud Rate, Data Bits, Stop Bits, Parity, Flow Control	Time Zone	Firmware version and date code (display only)	Reading in Celsius & Fahrenheit	Displays configured user string(s), if any.	Indicates the Rack (RK), Row (RW) & Cluster (CW) locations.	Detects the connection state of each port: 0 =No DSR input signal detected on device port 1 =DSR input signal detected on device port
		Eth1 Subnet Mask	Data Bits	Date/Time	Restore Factory Defaults				
		Gateway	Stop Bits						
		DNS1	Parity						
		DNS2	Flow Control						
		DNS3							

Note: The individual screens listed from left to right in [Table 4-4](#) can be enabled or disabled for display on the SLC LCD screen. The order of appearance of the screens, if enabled, along with the elected “Home Page” may vary on the LCD monitor according to configuration. The internal temperature, user strings, location and device ports LCD menus are disabled by default. See [LCD/Keypad \(on page 299\)](#) for instructions on enabling and disabling screens.

Entering the Settings

To enter setup information:

1. From the normal display (host name, date and time), press the right arrow button to display Network Settings. The IP address for Eth1 displays.

Note: *If you have connected Eth1 to the network, and Eth1 is able to acquire an IP address through DHCP, this IP address displays, followed by the letter [D]. Otherwise, the IP address displays as all zeros (000.000.000.000).*

2. Press the **Enter** button on the keypad to enter edit mode. A cursor displays below one character of the existing IP address setting.
3. To enter values:
 - Use the left or right arrow to move the cursor to the left or to the right position.
 - Use the up or down arrow to increment or decrement the numerical value.
4. When you have the IP address as you want it, press **Enter** to exit edit mode, and then press the down arrow button. The Subnet Mask parameter displays.

Note: *You must edit the IP address and the Subnet Mask together for a valid IP address combination.*

5. To save your entries for one or more parameters in the group, press the right arrow button. The Save Settings? Yes/No prompt displays.

Note: *If the prompt does not display, make sure you are no longer in edit mode.*

6. Use the left/right arrow buttons to select **Yes**, and press the **Enter** button.
7. Press the right arrow button to move to the next option, **Console Settings**.
8. Repeat steps 2-7 for each setting.
9. Press the right arrow button to move to the next option, **Date/Time Settings**, and click **Enter** to edit the time zone.
 - To enter a US time zone, use the up/down arrow buttons to scroll through the US time zones, and then press **Enter** to select the correct one.
 - To enter a time zone outside the US, press the left arrow button to move up to the top level of time zones. Press the up/down arrow button to scroll through the top level.
 A time zone with a trailing slash (such as Africa/) has sub-time zones. Use the right arrow button to select the Africa time zones, and then the up/down arrows to scroll through them.
 Press **Enter** to select the correct time zone. To move back to the top-level time zone at any time, press the left arrow.
10. To save your entries, press the right arrow button. The **Save Settings? Yes/No** prompt displays.

Note: *If the prompt does not display, make sure you are no longer in edit mode.*

11. Use the left/right arrow buttons to select **Yes**, and press the **Enter** button.
12. To review the saved settings, press the up or down arrows to step through the current settings.

When you are done, the front panel returns to the clock display. The network port resets to the new settings, and you can connect to your IP network for further administration. You should be able to SSH to the SLC 8000 advanced console manager through your network connection, or access the Web interface through a Web browser.

Restoring Factory Defaults

To use the LCD display to restore factory default settings:

1. Press the right arrow button to move to the last option, **Release**.
2. Use the down arrow to move to the **Restore Factory Defaults** option. A prompt for the 6-digit Restore Factory Defaults password displays.
3. Press **Enter** to enter edit mode.
4. Using the left and right arrows to move between digits and the up and down arrows to change digits, enter the password (the default password is 999999).

Notes: *The Restore Factory Defaults password is only for the LCD. You can change it at the command line interface using the `admin keypad password` command. The front panel Factory Default password and `sysadmin` password should be recorded and stored in a secure place accessible by at least two authorized system administrators. Recovering an SLC if both of these passwords are unknown is cumbersome and time consuming.*

5. Press **Enter** to exit edit mode. If the password is valid, a Save Settings? Yes/No prompt displays.
6. Select **Yes** and press **Enter**. When the process is complete, the SLC unit reboots.

Method #2 Quick Setup on the Web Page

After the unit has an IP address, you can use the [Quick Setup](#) page to configure the remaining network settings. This page displays the first time you log into the SLC 8000 advanced console manager only. Otherwise, the SLC [Home](#) page displays.

To complete the Quick Setup page:

1. Open a web browser (Firefox, Chrome or Internet Explorer web browsers with the latest browser updates).
2. In the URL field, type `https://` followed by the IP address of your SLC console manager.

Note: *The web server listens for requests on the unencrypted (HTTP) port (port 80) and redirects all requests to the encrypted (HTTPS) port (port 443).*

3. Log in using `sysadmin` as the user name and `PASS` as the password. The first time you log in to the SLC unit, the [Quick Setup](#) page automatically displays.

Note: *To open the Quick Setup page at another time, click the [Quick Setup](#) tab.*

Figure 4-5 Quick Setup

LANTRONIX® SLC 8048

Logout Host: slc4331 User: sysadmin

Select port for Configuration WebSSH (DP only) Connected Device (DP only)

Network Services User Authentication Devices Maintenance Quick Setup

Quick Setup

Quick Setup [Help?](#)

Welcome to the Lantronix SLC 8000 Advanced Console Manager

Below are basic settings that it is recommended you configure before using the Lantronix SLC 8000 Advanced Console Manager. If these settings are OK, click the checkbox below and select the Apply button.

Accept default Quick Setup settings

Network Settings

The SLC has two Ethernet ports, Eth1 and Eth2. By default, both Eth1 and Eth2 are configured for DHCP.

Eth1 Settings: Obtain from DHCP Obtain from BOOTP Specify:

IP Address:

Subnet Mask:

Default Gateway:

Hostname:

Note: The hostname will be used as the prompt in the Command Line Interface.

Domain:

Date & Time Settings

Change Date/Time:

Date:

Time: :

Time Zone:

Administrator Settings

The **sysadmin** user has complete privileges for SLC administration. The default password is 'PASS'.

Sysadmin Password:

Retype Password:

- To accept the defaults, select the **Accept default Quick Setup settings** checkbox on the top portion of the page and click the **Apply** button at the bottom of the page. Otherwise, continue with step 5.

Note: Once you click the **Apply** button on the [Quick Setup](#) page, you can continue using the web interface to configure the SLC further.

- Enter the following settings:

Network Settings

Note: Configurations with the same IP subnet on multiple interfaces (Ethernet or PPP) are not currently supported.

Network Setting	Description
Eth 1 Settings	<ul style="list-style-type: none"> ◆ Obtain from DHCP: Acquires IP address, subnet mask, hostname and gateway from the DHCP server. (The DHCP server may not provide the hostname gateway, depending on its setup.) This is the default setting. If you select this option, skip to Gateway. ◆ Obtain from BOOTP: Lets a network node request configuration information from a BOOTP "server" node. If you select this option, skip to Gateway. ◆ Specify: Lets you manually assign a static IP address, generally provided by the system administrator.
IP Address (if specifying)	<ul style="list-style-type: none"> ◆ Enter an IP address that is unique and valid on your network. There is no default. ◆ Enter all IP addresses in dot-quad notation. Do not use leading zeros in the fields for dot-quad numbers less than 100. For example, if your IP address is 172.19.201.28, do not enter 028 for the last segment octet. <p>Note: Currently, the SLC 8000 advanced console manager does not support configurations with the same IP subnet on multiple interfaces (Ethernet or PPP).</p>
Subnet Mask	If specifying an IP address, enter the subnet mask for the network on which the SLC unit resides. There is no default.
Default Gateway	The IP address of the router for this network. There is no default.
Hostname	The default host name is slcXXXX, where XXXX is the last 4 characters of the hardware address of Ethernet Port 1. There is a 64-character limit (contiguous characters, no spaces).
	Note: The host name becomes the prompt in the command line interface.
Domain	If desired, specify a domain name (for example, support.lantronix.com). The domain name is used for host name resolution within the SLC 8000 advanced console manager. For example, if abcd is specified for the SMTP server, and mydomain.com is specified for the domain, if abcd cannot be resolved, the SLC unit attempts to resolve abcd.mydomain.com for the SMTP server.

Date & Time Settings

Date & Time Setting	Description
Change Date/Time	Select the checkbox to manually enter the date and time at the SLC unit's location.
Date	From the drop-down lists, select the current month, day, and year.
Time	From the drop-down lists, select the current hour and minute.
Time Zone	From the drop-down list, select the appropriate time zone.

Administrator Settings

Administrator Setting	Description
Sysadmin Password	To change the password (e.g., from the default) enter a Sysadmin Password of up to 64 characters.
Retype Password	Re-enter the Sysadmin Password above in this field as a confirmation.

6. Click the **Apply** button to save your entries.

Figure 4-6 Quick Setup Completed in Web Manager

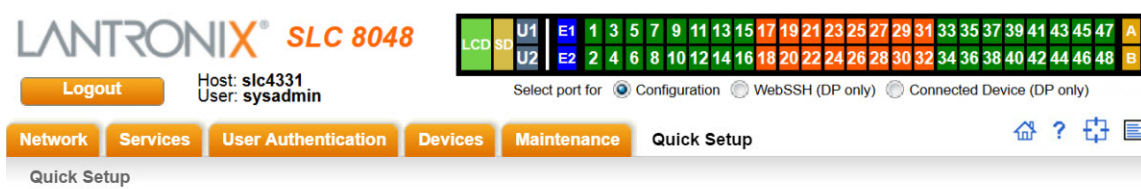

If Quick Setup has already been run the standard Home page will display.

Figure 4-7 Home

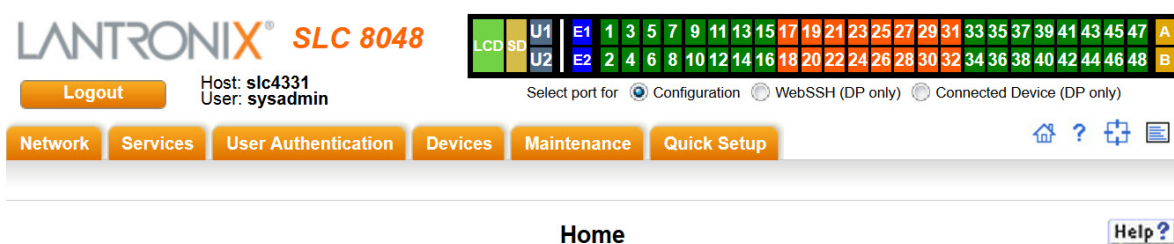

Welcome to the Lantronix SLC 8000 Advanced Console Manager

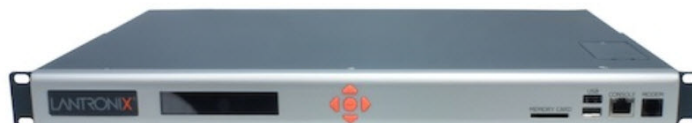

Method #3 Quick Setup on the Command Line Interface

If the SLC 8000 advanced console manager does not have an IP address, you can connect a dumb terminal or a PC running a terminal emulation program (VT100) to access the command line interface. (See [Connecting Terminals on page 39](#).) If the unit has an IP address, you can use SSH or Telnet to connect to the SLC unit.

By default, Telnet is disabled and SSH is enabled. To enable Telnet, use the [Services > SSH/Telnet/Logging \(on page 90\)](#).

To complete the command line interface Quick Setup script:

1. Do one of the following:
 - With a serial terminal connection, power up, and when the command line displays, press **Enter**.

- With a network connection, use an SSH client or Telnet program (if Telnet has been enabled) to connect to `xx.xx.xx.xx` (the IP address in dot quad notation), and press **Enter**. You should be at the login prompt.
2. Enter `sysadmin` as the user name and press **Enter**.
 3. Enter `PASS` as the password and press **Enter**. The first time you log in, the Quick Setup script runs automatically. Normally, the command prompt displays.

Figure 4-8 Beginning of Quick Setup Script

```
Welcome to the Lantronix SLC8000 Advanced Console Manager
Model Number: SLC8032
```

Quick Setup will now step you through configuring a few basic settings.

The current settings are shown in brackets ('[]').
You can accept the current setting for each question by pressing
<return>.

4. Enter the following information at the prompts:

Note: To accept a default or to skip an entry that is not required, press **Enter**.

CLI Quick Setup Settings	Description
Config Eth1	Select one of the following: <ul style="list-style-type: none"> ◆ (1) obtain IP Address from DHCP: The unit will acquire the IP address, subnet mask, hostname, and gateway from the DHCP server. (The DHCP server may or may not provide the gateway and hostname, depending on its setup.) This is the default setting. ◆ (2) obtain IP Address from BOOTP: Permits a network node to request configuration information from a BOOTP "server" node. ◆ (3) static IP Address: Allows you to assign a static IP address manually. The IP address is generally provided by the system administrator.
IP Address (if specifying)	An IP address that is unique and valid on your network and in the same subnet as your PC. There is no default. If you selected DHCP or BOOTP , this prompt does not display. Enter all IP addresses in dot-quad notation. Do not use leading zeros in the fields for dot-quad numbers less than 100. For example, if your IP address is 172.19.201.28, do not enter 028 for the last octet. Note: Configurations with the same IP subnet on multiple interfaces (Ethernet or PPP) are not currently supported.
Subnet Mask	The subnet mask specifies the network segment on which the SLC 8000 advanced console manager resides. There is no default. If you selected DHCP or BOOTP, this prompt does not display.
Default Gateway	IP address of the router for this network. There is no default.
Hostname	The default host name is <code>slcXXXX</code> , where <code>XXXX</code> is the last 4 characters of the hardware address of Ethernet Port 1. There is a 64-character limit (contiguous characters, no spaces). Note: The host name becomes the prompt in the command line interface.

CLI Quick Setup Settings	Description
Domain	If desired, specify a domain name (for example, support.lantronix.com). The domain name is used for host name resolution within the SLC unit. For example, if abcd is specified for the SMTP server, and mydomain.com is specified for the domain, if abcd cannot be resolved, the SLC 8000 advanced console manager attempts to resolve abcd.mydomain.com for the SMTP server.
Time Zone	If the time zone displayed is incorrect, enter the correct time zone and press Enter . If the entry is not a valid time zone, the system guides you through selecting a time zone. A list of valid regions and countries displays. At the prompts, enter the correct region and country.
Date/Time	If the date and time displayed are correct, type n and continue. If the date and time are incorrect, type y and enter the correct date and time in the formats shown at the prompts.
Sysadmin password	Enter a new sysadmin password.

After you complete the Quick Setup script, the changes take effect immediately.

Figure 4-9 Quick Setup Completed in CLI

```
Welcome to the Lantronix SLC8000 Advanced Console Manager
Model Number: SLC8032
```

```
Quick Setup will now step you through configuring a few basic settings.
```

```
The current settings are shown in brackets ('[]').
You can accept the current setting for each question by pressing
<return>.
```

```
____ Ethernet Port and Default Gateway _____
```

```
The SLC8032 has two ethernet ports, Eth1 and Eth2.
```

```
By default, both ports are configured for DHCP.
```

```
Configure Eth1: (1) obtain IP Address from DHCP
                (2) obtain IP Address from BOOTP
                (3) static IP Address
```

```
Enter 1-3: [1]
```

```
The SLC8032 can be configured to use a default gateway.
```

```
Enter gateway IP Address: [none]
```

```
____ Hostname _____
```

```
The current hostname is 'slc0348', and the current domain is
'<undefined>'.
```

```
The hostname will be shown in the CLI prompt.
```

```
Specify a hostname: [slc0348]
```

```
Specify a domain: [<undefined>]
```

```
____ Time Zone _____
```

```
The current time zone is 'GMT'.
```

```
Enter time zone: [GMT]
```

```
____Date/Time____  
The current time is Wed May 18 20:51:04 2016  
Change the current time? [n]
```

```
____Sysadmin Password____  
The default sysadmin (administrator user) password is 'PASS'.  
Enter new password: [PASS]
```

Quick Setup is now complete.

For a list of commands, type 'help'.

Next Step

After completing quick setup on the SLC 8000 advanced console manager, you may want to configure other settings. You can use the web page or the command line interface for configuration.

- ◆ For information about the web and the command line interfaces, go to [Chapter 5: Web and Command Line Interfaces](#).
- ◆ To continue configuring the SLC unit, go to [Chapter 6: Basic Parameters](#).

5: Web and Command Line Interfaces

The SLC advanced console manager offers three interfaces for configuring the SLC unit: a command line interface (CLI), a web interface, and an LCD with keypad buttons on the front panel. This chapter discusses the web and command line interfaces.

Note: See [Chapter 4: Quick Setup on page 48](#) for instructions on using the LCD front panel to configure basic network settings, Web Manager, and CLI to perform quick setup.

Web Manager

A Web Manager allows the system administrator and other authorized users to configure and manage the SLC 8000 advanced console manager using most web browsers (Firefox, Chrome or Internet Explorer web applications with the latest browser updates). The SLC unit provides a secure, encrypted web interface over SSL (secure sockets layer).

Note: The web server listens for requests on the unencrypted (HTTP) port (port 80) and redirects all requests to the encrypted (HTTPS) port (port 443). Web Telnet and Web SSH features (utilized in SLC console managers with firmware 7.2.0.0 or earlier) require Java 1.1 (or later) support in the browser.

The following figure shows a typical web page:

Figure 5-1 Web Page Layout

The screenshot displays the LANTRONIX SLC 8048 Web Manager interface. At the top, there is a navigation bar with tabs for Network, Services, User Authentication, Devices, Maintenance, and Quick Setup. The main content area is titled "Network Settings" and contains several sections for configuring network parameters. A table at the bottom shows network statistics for Rx and Tx. Annotations point to various UI elements: Logout Button, Tabs, Options, Entry Fields and Options, Dashboard, Icons, and Help Button.

Logout Button

Tabs

Options

Entry Fields and Options

Dashboard

Icons

Help Button

Network Settings

Ethernet Interfaces

Eth1 Settings: Disabled, Obtain from DHCP, Obtain from BOOTP, Specify. IP Address: 172.19.39.251, Subnet Mask: 255.255.0.0, IPv6 Address (Static):, IPv6 Address (Global): 2001::db80:ac13:d91e::, IPv6 Address (Link Local): fe80::280:a3ff:fe96:8d, Mode: Full-Duplex,1000Mbit, MTU: 1500, HW Address: 00:80:a3:96:8d:02, Multicast: 239.255.255.251, 224.0.0.1

Eth2 Settings: Disabled, Obtain from DHCP, Obtain from BOOTP, Specify. IP Address: 192.19.39.251, Subnet Mask: 255.255.0.0, IPv6 Address (Static):, IPv6 Address (Global): 2001::db80:ac13:d91e::, IPv6 Address (Link Local): fe80::280:a3ff:fe96:8d, Mode: Full-Duplex,1000Mbit, MTU: 1500, HW Address: 00:80:a3:96:8d:03, Multicast: 224.0.0.1

Hostname & Name Servers

Hostname: slc48SFP251-7400

Note: The hostname will be used as the prompt in the Command Line Interface.

Domain: lantronix.com

DNS Servers

#1: 172.18.0.10
#2: 172.19.39.251
#3: 172.19.0.11

DHCP-Acquired DNS Servers

#1: None
#2: None
#3: None

Prefer IPv4 DNS Records

Enable IP Forwarding:
Enable IPv6 Forwarding:

TCP Keepalive Parameters

Start Probes: 185 secs
Number of Probes: 6
Interval: 20 secs

	Rx			Tx		
	Bytes	Packets	Errors	Bytes	Packets	Errors
Eth1	88987876	919560	0	69844235	606105	0
Eth2	26845329	347358	0	30023	357	0

Gateway

The alternate gateway is used if an IP address usually accessible through the default gateway fails to return one or more pings.

Default: 172.19.0.1 Alternate:

DHCP-Acquired: none IP Address to Ping:

Ethernet Port for Ping: Eth1 Eth2

Precedence: DHCP-Acquired Default Delay between Pings: 2 seconds

Number of Failed Pings: 5

IPv6 Default: fe80::20c:29ff:fe5f:d

The web page has the following components:

- ◆ **Tabs:** Groups of settings to configure.
- ◆ **Options:** Below each tab are options for specific types of settings.

Note: Only those options for which the currently logged-in user has rights display.

Figure 5-2 Sample Dashboards

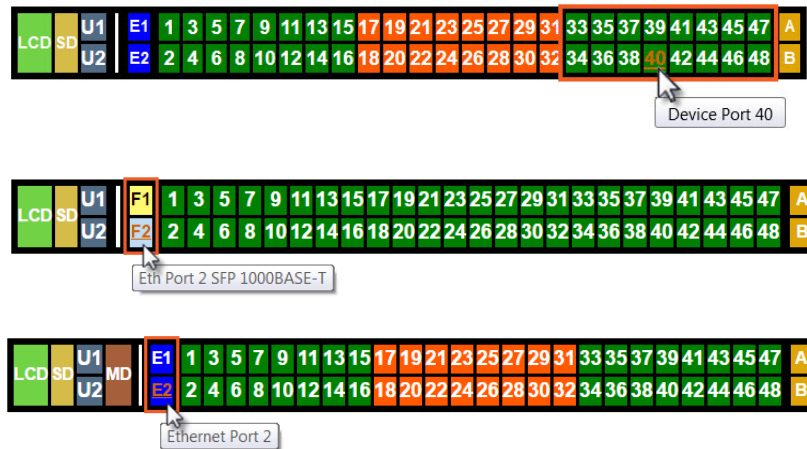

◆ Dashboard

The appearance of the user interface dashboard will differ according to the type of NIC card and bay modules installed in the back of the SLC 8000. See [Figure 2-2 SLC 8048 Unit Samples \(Back Side\) - Part Number SLC80482201S \(on page 24\)](#), [Figure 3-7 Sample Device Port Connections \(Back Side\) \(on page 38\)](#), and [Figure 5-2 Sample Dashboards \(on page 60\)](#).

- The light green **LCD** button allows you to configure the front panel LCD.
- The beige **SD** button allows you to configure the SD card, if a card is inserted. See [Chapter 9: USB/SD Card Port on page 184](#).
- The gray **U1** button allows you to configure the upper USB device (flash drive or modem) plugged into the front panel USB connector. The gray **U2** button allows you to configure the lower USB device plugged into the front panel USB connector. See [Chapter 9: USB/SD Card Port on page 184](#).
- The brown **MD** button allows you to configure the internal modem, if an internal modem is installed.
- The blue **E1** and **E2** buttons display the [Network > Network Settings](#) page for the Ethernet port.
- The **F1** and **F2** buttons display the [Network > Network Settings](#) page for the SFP transceiver port.
- The number buttons allow you to select a port and display its settings. Only ports to which the currently logged-in user has rights are enabled.

Below the bar are options for use with the port buttons. Selecting a port and the **Configuration** option takes you to the [Device Ports > Settings](#) page. Selecting a port and the **WebSSH** option displays the WebSSH window for the device port –if Web SSH is enabled, and if SSH is enabled for the device port. Selecting the port and the **Connected Device** button allows access to supported devices such as remote power managers (RPMs) and/or SensorSoft temperature and humidity probes connected to the device port.

- The yellow orange **A** and **B** buttons display the status of the power supplies.
- ◆ **Entry Fields and Options:** Allow you to enter data and select options for the settings.

Note: For specific instructions on completing the fields on the web pages, see Chapters 5 through 12.

- ◆ **Apply Button:** Apply on each web page makes the changes immediately and saves them so they will be there when the SLC 8000 advanced console manager is rebooted.
- ◆ **Icons:** The icon bar above the Main Menu has icons that display the following:

 Home page.

 Information about the SLC unit and Lantronix contact information.

 Configuration site map.

 Status of the SLC 8000 advanced console manager.

- ◆ **Help Button:** Provides online Help for the specific web page.

Logging in

Only the system administrator or users with web access rights can log into the Web Manager. More than one user at a time can log in, but the same user cannot login more than once.

To log in to the SLC Web Manager:

1. Open a web browser.
2. In the URL field, type `https://` followed by the IP address of your SLC 8000 advanced console manager.
3. To configure the SLC unit, use `sysadmin` as the user name and `PASS` as the password. (These are the default values.)

Note: The system administrator may have changed the password using one of the Quick Setup methods in the previous chapter.

The Lantronix SLC [Quick Setup](#) page displays automatically the first time you log in. Subsequently, the Lantronix SLC Home page displays. (If you want to display the [Quick Setup](#) page again, click **Quick Setup** on the main menu.)

Logging Out

To log off the SLC web interface:

1. Click the **Logout** button located on the upper left part of any Web Manager page. You are brought back to the login screen when logout is complete.

Web Page Help

To view detailed information about an SLC web page:

1. Click the **Help** button to the right of any Web Manager page. Online Help contents will appear in a new browser window.

Command Line Interface

A command line interface (CLI) is available for entering all the commands you can use with the SLC 8000 advanced console manager. In this user guide, after each section of instructions for using the web interface, you will find the equivalent CLI commands. You can access the command line interface using Telnet, SSH, or a serial terminal connection.

Note: *By default, Telnet is disabled and SSH is enabled. To enable Telnet, use the [Services > SSH/Telnet/Logging](#) web page, a serial terminal connection, or an SSH connection. (See [Chapter 7: Services](#).)*

The sysadmin user and users with who have full administrative rights have access to the complete command set, while all other users have access to a reduced command set based on their permissions.

Logging In

To log in to the SLC command line interface:

- Do one of the following:
 - With a serial terminal connection, power up, and when the command line displays, press **Enter**.
 - If the SLC 8000 advanced console manager already has an IP address (assigned previously or assigned by DHCP), Telnet (if Telnet has been enabled) or SSH to `xx.xx.xx.xx` (the IP address in dot quad notation) and press **Enter**. The login prompt displays.
- To log in as the system administrator for setup and configuration, enter `sysadmin` as the user name and press **Enter**.
- Enter `PASS` as the password and press **Enter**. The first time you log in, the Quick Setup script runs automatically. Normally, the command prompt displays. (If you want to display the Quick Setup script again, use the `admin quicksetup` command.)

Note: *The system administrator may have changed the password using one of the Quick Setup methods in the previous chapter.*

To log in any other user:

- Enter your SLC user name and press **Enter**.
- Enter your SLC password and press **Enter**.

Logging Out

To log out of the SLC command line interface, type `logout` and press **Enter**.

Command Syntax

Commands have the following format:

```
<action> <category> <parameter(s)>
```

where

<action> is `set`, `show`, `connect`, `admin`, `diag`, or `logout`.

<category> is a group of related parameters whose settings you want to configure or view. Examples are ntp, deviceport, and network.

<parameter (s) > is one or more name-value pairs in one of the following formats:

<parameter name> <aa bb>	User must specify one of the values (aa or bb) separated by a vertical line (). The values are in all lowercase and must be entered exactly as shown. Bold indicates a default value.
<parameter name> <Value>	User must specify an appropriate value, for example, an IP address. The parameter values are in mixed case. Square brackets [] indicate optional parameters.

Command Line Help

- ◆ For general Help and to display the commands to which you have rights, type: `help`
- ◆ For general command line Help, type: `help command line`
- ◆ For release notes for the current firmware release, type: `help release`
- ◆ For more information about a specific command, type `help` followed by the command. For example: `help set network` or `help admin firmware`

Tips

- ◆ Type enough characters to identify the action, category, or parameter name uniquely. For parameter values, type the entire value. For example, you can shorten:

```
set network port 1 state static ipaddr 122.3.10.1 mask 255.255.0.0
```

 to

```
se net po 1 st static ip 122.3.10.1 ma 255.255.0.0
```
- ◆ Use the Tab key to automatically complete action, category, or parameter names. Type a partial name and press **Tab** either to complete the name if only one is possible, or to display the possible names if more than one is possible. Following a space after the preceding name, Tab displays all possible names.
- ◆ Should you make a mistake while typing, backspace by pressing the Backspace key and/or the Delete key, depending on how you accessed the interface. Both keys work if you use VT100 emulation in your terminal access program when connecting to the console port. Use the left and right arrow keys to move within a command.
- ◆ Use the up and down arrows to scroll through previously entered commands. If desired, select one and edit it. You can scroll through up to 100 previous commands entered in the session.
- ◆ To clear an IP address, type 0.0.0.0, or to clear a non-IP address value, type `CLEAR`.
- ◆ When the number of lines displayed by a command exceeds the size of the window (the default is 25), the command output is halted until the user is ready to continue. To display the next line, press **Enter**, and to display the page, press the space bar. You can override the number of lines (or disable the feature altogether) with the `set cli` command. General CLI Commands

The following commands relate to the CLI itself.

To configure the current command line session:

```
set cli scscommands <enable|disable>
```

Allows you to use SCS-compatible commands as shortcuts for executing commands:

Note: Settings are retained between CLI sessions for local users and users listed in the remote users list.

Table 5-3 SCS Commands

SCS Commands	Commands
info	'show sysstatus'
version	'admin version'
reboot	'admin reboot'
poweroff	'admin shutdown'
listdev	'show deviceport names'
direct	'connect direct deviceport'
listen	'connect listen deviceport'
clear	'set locallog clear'
telnet	'connect direct telnet'
ssh	'connect direct ssh'

To set the number of lines displayed by a command:

```
set cli terminallines <disable|Number of lines>
```

Sets the number of lines in the terminal emulation (screen) for paging through text one screenful at a time, if the SLC 8000 unit cannot detect the size of the terminal automatically.

To show current CLI settings:

```
show cli
```

To view the last 100 commands entered in the session:

```
show history
```

To clear the command history:

```
set history clear
```

To view the rights of the currently logged-in user:

```
show user
```

Note: For information about user rights, see [Chapter 12: User Authentication](#).

Table 5-4 CLI Keyboard Shortcuts

Keyboard Shortcut	Description
Control + [a]	Move to the start of the line.
Control + [e]	Move to the end of the line.
Control + [b]	Move back to the start of the current word.
Control + [f]	Move forward to the end of the next word.
Control + [u]	Erase from cursor to the beginning of the line.
Control + [k]	Erase from cursor to the end of the line.

6: Basic Parameters

This chapter explains how to set the following basic configuration settings for the SLC advanced console manager using the SLC web interface or the CLI:

- ◆ Network parameters that determine how the SLC 8000 advanced console manager interacts with the attached network
- ◆ Firewall and routing
- ◆ Date and time

Note: *If you entered some of these settings using a Quick Setup procedure, you may update them here.*

Requirements

If you assign a different IP address from the current one, it must be within a valid range and unique to your network. If a valid gateway address has not been assigned the IP address must be on the same subnet as workstations connecting to the SLC 8000 over the network.

To configure the unit, you need the following information:

Eth1 IP address: _____ - _____ - _____ - _____
Subnet mask: _____ - _____ - _____ - _____

Eth2 IP address (optional): _____ - _____ - _____ - _____
Subnet mask (optional): _____ - _____ - _____ - _____

Gateway: _____ - _____ - _____ - _____

DNS: _____ - _____ - _____ - _____

Network Port Settings

Network parameters determine how the SLC unit interacts with the attached network. Use this page to set the following basic configuration settings for the network ports (Eth1 and Eth2).

The SLC supports the following types of network interfaces:

- ◆ RJ-45 ports, as part of the standard SLC RJ45 NIC board. In the web UI port banner bar, these are represented as **E1** and **E2**. These ports can be configured for speeds of 10Mbit, 100 Mbit or 1000 Mbit, at half-duplex or full-duplex. The RJ45 Ethernet NIC LEDs display the following states:
 - **Green Light On:** indicates a link at 1000 BASE-T
 - **Green Light Off:** indicates a link at other speeds, or no link
 - **Yellow Light On:** indicates a link is established
 - **Yellow Light Blinking:** indicates link activity
- ◆ A variety of SFP modules, installed in the SLC SFP NIC board. In the web UI port banner bar, these are represented as **F1** and **F2**, in a variety of colors. Single mode 1000 BASE-LX optical SFPs are shown in yellow as **F1**. Multi mode 1000 BASE-SX optical SFPs are shown as **F1**. RJ45 1000 BASE-T SFPs are shown in blue as **F1**. A port with no SFP module is shown in white as **F1**. A port with an unknown SFP module is shown as **F1**. The SFP Ethernet NIC LEDs are located between the two SFP module slots; the LEDs for Ethernet 1 are on the left, and the LEDs for Ethernet 2 are on the right. They display the following states:
 - **Green Light On:** indicates a link is established
 - **Green Light Off:** indicates no link
 - **Yellow Light On:** indicates no link activity
 - **Yellow Light Blinking:** indicates link activity

These ports are fixed at 1000 Mbit full-duplex. Note that in some vendor's RJ45 1000 BASE-T transceivers, the RX LOS is internally ground, so the link status feature may fail.

To enter settings for one or both network ports:

1. Click the **Network** tab and select the **Network Settings** option. The following page displays:

Figure 6-1 Network > Network Settings

LANTRONIX[®] SLC 8048

Logout Host: slc48SFP251-7400R8 User: sysadmin

Select port for Configuration WebSSH (DP only) Connected Device (DP only)

Network Services User Authentication Devices Maintenance Quick Setup

Network Settings IP Filter Routing VPN Security

Network Settings Help?

Ethernet Interfaces

Eth1 Settings: Disabled Obtain from DHCP Obtain from BOOTP Specify:

IP Address: Subnet Mask:

IPv6 Address: (Static)

IPv6 Address: (Global)

IPv6 Address: (Link Local)

Mode: MTU:

HW Address: **00:80:a3:96:8d:02** Multicast: **239.255.255.251**
224.0.0.1

Enable IPv6: (Requires reboot) Ethernet Bonding:

[SFP NIC Info & Diagnostics](#) [Ethernet Bonding Status](#)

	Rx				Tx		
	Bytes	Packets	Errors	Multicast	Bytes	Packets	Errors
Eth1	88987876	919560	0	0	69844235	606105	0
Eth2	26845329	347358	0	0	30023	357	0

Hostname & Name Servers

Hostname: **Note:** The hostname will be used as the prompt in the Command Line Interface.

Domain:

DNS Servers

#1: #2: #3:

DHCP-Acquired DNS Servers

#1: **None** #2: **None** #3: **None**

Prefer IPv4 DNS Records:

Enable IP Forwarding: Enable IPv6 Forwarding:

TCP Keepalive Parameters

Start Probes: secs
Number of Probes:
Interval: secs

Gateway

The alternate gateway is used if an IP address usually accessible through the default gateway fails to return one or more pings.

Default: Alternate:

DHCP-Acquired: **none** IP Address to Ping:

Ethernet Port for Ping: Eth1 Eth2

Precedence: DHCP-Acquired Default Delay between Pings: seconds

IPv6 Default: Number of Failed Pings:

Note: The SFP NIC Info & Diagnostics link in the **Network > Network Settings** page only appears in SLC units equipped with an SFP NIC board.

Figure 6-2 Network Settings > SFP NIC Information & Diagnostics

LANTRONIX[®] SLC 8048

Host: slc48SFP251-7400R11
User: sysadmin

Select port for Configuration WebSSH (DP only) Connected Device (DP only)

Network Settings IP Filter Routing VPN Security

Network - SFP NIC Information & Diagnostics Help?

Eth1 SFP Module: 1000BASE-LX Single Mode (Vendor: Fiberstore PN: SFP1G-EX-55 Rev: A0)
Eth2 SFP Module: 1000BASE-LX Single Mode (Vendor: FiberStore PN: SFP1G-ZX-55 Rev: A)

SFP Diagnostic Information								
Port	Temp	Voltage	Current	Output Power	Input Power	LOS	TX	Fault
Eth1	36.53 degC/97.76 degF	3.2058V	23.800mA	0.5475mW	0.5622mW	No	No	
Eth2	48.42 degC/119.15 degF	3.1902V	20.000mA	1.0741mW	0.0000mW	Yes	No	

[Back to Network Settings](#)

2. Enter the following information:

Ethernet Interfaces (Eth1 and Eth2)

Note: Configurations with the same IP subnet on multiple interfaces (Ethernet or PPP) are not currently supported.

Eth 1 Settings or Eth 2 Settings	<ul style="list-style-type: none"> ◆ Disabled: If selected, disables the network port. ◆ Obtain from DHCP: Acquires IP address, subnet mask, hostname and gateway from the DHCP server. (The DHCP server may not provide the hostname gateway, depending on its setup.) This is the default setting. If you select this option, skip to Gateway. ◆ Obtain from BOOTP: Lets a network node request configuration information from a BOOTP "server" node. If you select this option, skip to Gateway. ◆ Specify: Lets you manually assign a static IP address, generally provided by the system administrator.
IP Address (if specifying)	<ul style="list-style-type: none"> ◆ Enter an IP address that will be unique and valid on your network. There is no default. ◆ Enter all IP addresses in dot-quad notation. Do not use leading zeros in the fields for dot-quad numbers less than 100. For example, if your IP address is 172.19.201.28, do not enter 028 for the last segment octet. <p>Note: Currently, the SLC unit does not support configurations with the same IP subnet on multiple interfaces (Ethernet or PPP).</p>
Subnet Mask	If specifying an IP address, enter the network segment on which the SLC unit resides. There is no default.
IPv6 Address (Static)	Address of the port in IPv6 format. <p>Note: The SLC 8000 advanced console manager supports IPv6 connections for the following services: the web, SSH, Telnet, remote syslog, SNMP, NTP, LDAP, Kerberos, RADIUS, TACACS+, connections to device ports, and diagnostic ping.</p> <p>IPv6 addresses are written as 8 sets of 4-digit hexadecimal numbers separated by colons. There are several rules for modifying the address. For example:</p> <p>1234 : 0BCD : 1D67 : 0000 : 0000 : 8375 : BADD : 0057 may be shortened to 1234 : BCD : 1D67 : : 8375 : BADD : 57 .</p>

IPv6 Address (Global)"	<p>IPv6 address with global scope that is generated by address autoconfiguration. The address is generated from a combination of router advertisements and MAC address to create a unique IPv6 address. This field is read only.</p> <p>Note: This field will not appear in the absence of an IPv6 global address.</p>
IPv6 Address (Link Local)	An IPv6 address that is intended only for communications within the segment of a local network. This field is read only.
Mode	Select the direction, duplex mode (full duplex or half-duplex), and speed (10, 100, or 1000 Mbit) of data transmission. The default is Auto, which allows the Ethernet port to auto-negotiate the speed and duplex with the hardware endpoint to which it is connected.
MTU	Specifies the maximum transmission unit (MTU) or maximum packet size of packets at the IP layer (OSI layer 3) for the Ethernet port. When fragmenting a datagram, this is the largest number of bytes that can be used in a packet.
HW Address	Displays the hardware address of the Ethernet port.
Multicast	Displays the multicast address of the Ethernet port.
Enable IPv6	Select this box to enable the IPv6 protocol. If changed, the SLC unit will need to reboot. Enabled by default.
Ethernet Bonding	Ethernet 1 and Ethernet 2 can be bonded to support redundancy (Active Backup), aggregation (802.3ad), and load balancing. Disabled by default. Note that if Ethernet Bonding is enabled, assigning individual IP Addresses to Device Ports is not supported.
SFP NIC Info & Diagnostics (Link)	<p>Clicking the link brings you to the Network Settings > SFP NIC Information & Diagnostics page showing information and diagnostics about the SFP connection port, temperature, voltage, current, output power, input power, LOS, and TX fault. Click Back to Network Settings to return to the Network > Network Settings page.</p> <p>Note: The SFP NIC Info & Diagnostics link in the Network > Network Settings page only appears in SLC units equipped with an SFP NIC board.</p>
Ethernet Bonding Status (Link)	<p>Click the link to access Ethernet bonding status information. Ethernet 1 and Ethernet 2 can be bonded to support redundancy (Active Backup), aggregation (802.3ad), and load balancing. Disabled by default. Note that if Ethernet Bonding is enabled, assigning individual IP Addresses to Device Ports is not supported.</p> <p>Click Back to Network Settings link to return to the Network Settings page.</p>
Prefer IPv4 DNS Records	If enabled, IPv4 DNS records will be preferred when DNS hostname lookups are performed. Otherwise IPv6 records will be preferred (when IPv6 is enabled). Enabled by default.
Enable IP Forwarding	<p>If enabled, IP forwarding enables IPv4 network traffic received on one interface (Eth1, Eth2, or an external/USB modem attached to the SLC unit with an active PPP connection) to be transferred out another interface (any of the above). The default behavior (if IP forwarding is disabled) is for network traffic to be received but not routed to another destination.</p> <p>Enabling IP forwarding is required if you enable Network Address Translation (NAT) for any device port modem or USB/ISDN modem. IP forwarding allows a user accessing the SLC 8000 advanced console manager over a modem to access the network connected to Eth1 or Eth2.</p>
Enable IPv6 Forwarding	If enabled, IPv6 forwarding enables IPv6 network traffic received on one interface (Eth1, Eth2, or an external/USB modem attached to the SLC unit with an active PPP connection) to be transferred out another interface (any of the above). The default behavior (if IP forwarding is disabled) is for network traffic to be received but not routed to another destination.

Note: Configurations with the same IP subnet on multiple interfaces (Ethernet or PPP) are not currently supported.

Gateway

Default	<p>IP address of the IPv4 router for this network.</p> <p>If this has not been set manually, any gateway acquired by DHCP for Eth1 or Eth2 displays.</p> <p>All network traffic that matches the Eth1 IP address and subnet mask is sent out Eth1. All network traffic that matches the Eth2 IP address and subnet mask is sent out Eth 2.</p> <p>If you set a default gateway, any network traffic that does not match Eth1 or Eth2 is sent to the default gateway for routing.</p>
DHCP-Acquired	Gateway acquired by DHCP for Eth1 or Eth2. View only.
Precedence	Indicates whether the gateway acquired by DHCP or the default gateway takes precedence. The default is DHCP Gateway. If the DHCP Gateway is selected and both Eth1 and Eth2 are configured for DHCP, the SLC unit gives precedence to the Eth1 gateway.
IPv6 Default	Indicates the IPv6 default gateway.
Alternate	An alternate IP address of the router for this network, to be used if an IP address usually accessible through the default gateway fails to return one or more pings.
IP Address to Ping	IP address to ping to determine whether to use the alternate gateway.
Ethernet Port to Ping	Ethernet port to use for the ping.
Delay between Pings	Number of seconds between pings
Number of Failed Pings	Number of pings that fail before the SLC 8000 advanced console manager uses the alternate gateway.

Hostname & Name Servers

Hostname	The default host name is <code>slcXXXX</code> , where <code>XXXX</code> is the last 4 characters of the hardware address of Ethernet Port 1. There is a 64-character limit (contiguous characters, no spaces). The host name becomes the prompt in the command line interface.
Domain	If desired, specify a domain name (for example, <code>support.lantronix.com</code>). The domain name is used for host name resolution within the SLC unit. For example, if <code>abcd</code> is specified for the SMTP server, and <code>mydomain.com</code> is specified for the domain, if <code>abcd</code> cannot be resolved, the SLC 8000 advanced console manager attempts to resolve <code>abcd.mydomain.com</code> for the SMTP server.

DNS Servers

#1 - #3	<p>Configure up to three name servers with an IPv4 or IPv6 address. #1 is required if you choose to configure DNS (Domain Name Server) servers.</p> <p>The first three DNS servers acquired via DHCP through Eth1 and/or Eth2 display automatically.</p>
----------------	--

DHCP-Acquired DNS Servers

#1 - #3	Displays the IP address of the name servers if automatically assigned by DHCP.
----------------	--

TCP Keepalive Parameters

Start Probes	Number of seconds the SLC unit waits after the last transmission before sending the first probe to determine whether a TCP session is still alive. The default is 600 seconds (10 minutes).
Number of Probes	Number of probes the SLC 8000 advanced console manager sends before closing a session. The default is 5.
Interval	The number of seconds the SLC unit waits between probes. The default is 60 seconds.

- To save your entries, click the **Apply** button. **Apply** makes the changes immediately and saves them so they will be there when the SLC 8000 advanced console manager is rebooted.

Ethernet Counters

The [Network > Network Settings](#) page displays statistics for each of the SLC Ethernet ports since boot-up. The system automatically updates them.

Note: For Ethernet statistics for a smaller time period, use the `diag perfstat` command.

Network Commands

The following CLI commands correspond to the web page entries described above.

To configure Ethernet port 1 or 2:

```
set network port <1|2> <Parameters>
```

Parameters

```
state <dhcp|bootp|static|disable> [ipaddr <IP Address> mask <Mask>]
ipv6addr <IPv6 Address/Prefix>
mode <auto|10mbit-half|100mbit-half|10mbit-full|100mbit-full|
    1000mbit-full>
mtu <Maximum Transmission Unit>
```

To configure IPv6 networking:

```
set network ipv6 <enable|disable>
```

To configure IPv4/IPv6 DNS lookup precedence:

```
set network dnsipv4prec <enable|disable>
```

To configure up to three DNS servers:

```
set network dns <1|2|3> ipaddr <IP Address>
```

To set the default and alternate network gateways:

```
set network gateway <parameters>
```

Parameters

```
default <IP Address>
```



```
ipv6default <IPv6 Address>  
precedence <dhcp|default>  
alternate <IP Address>  
pingip <IP Address>  
ethport <1 or 2>  
pingdelay <1-250 seconds>  
failedpings <1-25>
```

The alternate gateway is used if an IP address usually accessible through the default gateway fails to return one or more pings.

To set the SLC host name and domain name:

```
set network host <Hostname> [domain <Domain Name>]
```

To set TCP Keepalive and IP Forwarding network parameters:

```
set network <parameters>
```

Parameters

```
startprobes <1-99999 Seconds>  
probes <Number of Probes>  
interval <1-99999 Seconds>  
ipforwarding <enable|disable>  
ipv6forwarding <enable|disable>
```

To view all network settings:

```
show network all
```

To view Ethernet port settings and counters:

```
show network port <1|2>
```

To view DNS settings:

```
show network dns
```

To view gateway settings:

```
show network gateway
```

To view the host name of the SLC 8000 advanced console manager:

```
show network host
```

To view bonding settings and status of the SLC 8000 advanced console manager:

```
show network bonding
```

To view IPv6 settings of the SLC 8000 advanced console manager:

```
show network ipv6
```

To view SFP diagnostics of the SLC 8000 advanced console manager:

```
show network sfp
```

IP Filter

IP filters (also called a rule set) act as a firewall to allow or deny individual or a range of IP addresses, ports, and protocols. When a network connection is configured to use an IP filter, all network traffic through that connection is compared, in order, to the rules of that filter. Network traffic may be allowed to pass, it may be dropped (without notice), or it may be rejected (sends back an error packet) depending upon the rules of that filter rule set.

The administrator uses the [Network > IP Filter](#) page to view, add, edit, delete, and map IP filters.

Warning: *IP filters configuration is a feature for advanced users. Adding and enabling IP filter sets incorrectly can disable access to your SLC unit.*

Viewing IP Filters

You can view a list of filters and a table showing how each filter is mapped to an interface.

To view a list of IP filters:

1. Click the **Network** tab and select the **IP Filter** option. The following page displays:

Figure 6-3 Network > IP Filter

LANTRONIX[®] SLC 8048

Logout Host: slc4331 User: sysadmin

Select port for Configuration WebSSH (DP only) Connected Device (DP only)

Network Services User Authentication Devices Maintenance Quick Setup

Network Settings IP Filter Routing VPN Security

IP Filter Help ?

Enable IP Filter: [IP Filter Status >](#)

Packets Dropped: 0 Packets Rejected: 0

Test Timer: No Yes, minutes (1-120): Use the Test Timer to verify the IP Filter Rulesets; IP Filter will automatically be disabled when the Test Timer expires.

Time Remaining: 0 minutes

Add Ruleset Edit Ruleset Map Ruleset to Interface: Ethernet 1 Delete Mapping

Delete Ruleset

IP Filter Rulesets	
Name	

IP Filter Mappings	
Interface	Ruleset

Apply

Mapping Rulesets

The administrator can assign an IP Filter Rule Set to a network interface (Ethernet interface), a modem connected to a device port, or a USB modem or an internal modem (if installed).

To map a ruleset to a network interface:

1. Click the **Network** tab and select the **IP Filter** option. The [Network > IP Filter](#) page displays.
2. Select the IP filter rule set to be mapped.
3. From the **Interface** drop-down list, select the desired network interface and click the **Map Ruleset** button. The Interface and rule set display in the IP Filter Mappings table.

To delete a mapping:

1. Click the **Network** tab and select the **IP Filter** option. The [Network > IP Filter](#) page displays.
2. Select the mapping from the list and click the **Delete Mappings** button. The mapping no longer displays.
3. Click the **Apply** button.

Enabling IP Filters

On the [Network > IP Filter](#) page, you can enable all filters or disable all filters.

Note: *There is no way to enable or disable individual filters.*

To enable IP filters:

1. Enter the following:

Enable IP Filter	Select the Enable IP Filter checkbox to enable all filters, or clear the checkbox to disable all filters. Disabled by default.
Packets Dropped	Displays the number of data packets that the filter ignored (did not respond to). View only.
Packets Rejected	Displays the number of data packets that the filter sent a “rejected” response to. View only.
Test Timer	Timer for testing IP Filter rulesets. Select No to disable the timer. Select Yes, minutes (1-120) to enable the timer and enter the number of minutes the timer should run. The timer automatically disables the IP Filters when the time expires.
Time Remaining	Indicates how many minutes are left on the timer before it expires and IP Filters disabled. View only.

Configuring IP Filters

The administrator can add, edit, delete, and map IP filters.

Note: A configured filter has no effect until it is mapped to a network interface.
See [Mapping Rulesets on page 75](#).

To add an IP filter:

1. On the [Network > IP Filter](#) page, click the **Add Ruleset** button. The following page displays:

Figure 6-4 Network > IP Filter Ruleset (Adding/Editing Rulesets)

The screenshot shows the LANTRONIX SLC 8048 web interface. At the top, there is a navigation menu with options like Network, Services, User Authentication, Devices, Maintenance, and Quick Setup. Below the menu, the page title is "Network - IP Filter Ruleset". The main configuration area includes:

- Ruleset Name:** A text input field.
- Number of Rules:** 1
- Rule Parameters:**
 - IP Address(es):** A text input field.
 - Subnet Mask:** A text input field.
 - Protocol:** A dropdown menu set to "All".
 - Port Range:** A text input field.
 - Action:** Radio buttons for "Drop" (selected), "Reject", and "Accept".
 - Clear:** A button.
- Rules (in order of precedence):** A list box containing "0.0.0.0/0;All;;Drop".
- Generate rule to allow service:** A section with a grid of radio buttons for various services: BOOTP/DHCP, Telnet, HTTP, FTP, DNS, SNMP, NIS, SFTP, RIP, SMTP, LDAP, TFTP, NTP, NFS, RADIUS, VPN, Syslog, SMB/CIFS, Kerberos, LDP, SSH, HTTPS, TACACS+, and SLC Logging.
- Add Rule:** A button.
- Back to IP Filter:** A link.
- Apply:** A button.





Rulesets can be added or updated on this page.

2. Enter the following:

Ruleset Name	Name that identifies a filter; may be composed of letters, numbers, and hyphens only. (The name cannot start with a hyphen.) Example: FILTER-2
---------------------	---

Rule Parameters

IP Address(es)	Specify a single IP address to act as a filter. Example: 172 . 19 . 220 . 64 – this specific IP address only
Subnet Mask	Specify a subnet mask to act determine how much of the address should apply to the filter. Example: 255 . 255 . 255 . 255 to specify the whole address should apply.
Protocol	From the drop-down list, select the type of protocol through which the filter will operate. The default setting is All .
Port Range	Enter a range of destination TCP or UDP port numbers to be tested. An entry is required for TCP, TCP New, TCP Established, and UDP, and is not allowed for other protocols. Separate multiple ports with commas. Separate ranges of ports by colons. Examples: <ul style="list-style-type: none"> ◆ 22 – filter on port 22 only ◆ 23,64,80 – filter on ports 23, 64 and 80 ◆ 23:64,80,143:150 – filter on ports 23 through 64, port 80 and ports 143 through 150
Action	Select whether to Drop , Reject , or Allow communications for the specified IP address, subnet mask, protocol, and port range. Drop ignores the packet with no notification. Reject ignores the packet and sends back an error message. Allow permits the packet through the filter.
Clear	Click the Clear button to clear any Rule Parameter information set above.
Generate rule to allow service	You may wish to “punch holes” in your filter set for a particular protocol or service. For instance, if you have configured your NIS server and wish to create an opening in your filter set, select the NIS option and click the Add Rule button. This entry adds a new rule to your filter set using the NIS -configured IP address. Other services and protocols added automatically generate the necessary rule to allow their use.

3. Click the right arrow  button to add the new rule to the bottom of the Rules list box on the right. A maximum of 64 rules can be created for each ruleset.
4. To remove a rule from the filter set, highlight that line and click the left  arrow. The rule populates the rule definition fields, allowing you to make minor changes before reinserting the rule. To clear the definition fields, click the **Clear** button.
5. To change the order of priority of the rules in the list box, select the rule to move and use the up  or down  arrow buttons on the right side of the filter list box.
6. To save, click the **Apply** button. The new filter displays in the menu tree.

Note: To add another new filter rule set, click the **Back to IP Filter** link to return to the [Network > IP Filter](#) page.

Updating an IP Filter

To update an IP filter rule set:

1. From the [Network > IP Filter](#) page, the administrator selects the IP filter ruleset to be edited and clicks the **Edit Ruleset** button to return to the [Network > IP Filter Ruleset \(Adding/Editing Rulesets\)](#) page (see [Figure 6-4](#)).
2. Edit the information as desired and click the **Apply** button.

Deleting an IP Filter

To delete an IP filter rule set:

1. On the [Network > IP Filter](#) page, the administrator selects the IP filter ruleset to be deleted and clicks the **Delete Ruleset** button.

IP Filter Commands

The following CLI commands correspond to the web page entries described above.

To enable or disable IP filtering for incoming network traffic:

```
set ipfilter state <enable|disable> [testtimer <disable|1-120 minutes>]
```

To set IP filter mapping:

```
set ipfilter mapping <parameters>
```

Parameters

```
ethernet <1|2|bond0> state <disable>
ethernet <1|2|bond0> state <enable> ruleset <Ruleset Name>
deviceport <1..48> state <disable>
deviceport <1..48> state <enable> ruleset <Ruleset Name>
internal modem state <disable>
internal modem state <enable> ruleset <Ruleset Name>
usbport <U1|U2> state <disable>
usbport <U1|U2> state <enable> ruleset <Ruleset Name>
```

To set IP filter rules:

```
set ipfilter rules <parameters>
```

Parameters

```
add <Ruleset Name>
delete <Ruleset Name>
edit <Ruleset Name> <Edit Parameters>
```

Edit Parameters

```
append
insert <Rule Number>
replace <Rule Number>
delete <Rule Number>
```

Routing

The SLC 8000 advanced console manager allows you to define static routes and, for networks using Routing Information Protocol (RIP)-capable routes, to enable the RIP protocol to configure the routes dynamically.

To configure routing settings:

1. Click the **Network** tab and select the **Routing** option. The following page displays:

Figure 6-5 Network > Routing

The screenshot shows the LANTRONIX SLC 8048 web interface. At the top, there's a navigation bar with tabs: Network, Services, User Authentication, Devices, Maintenance, and Quick Setup. The 'Network' tab is selected, and sub-tabs include Network Settings, IP Filter, Routing, VPN, and Security. The 'Routing' sub-tab is active.

Configuration options include:

- Enable RIP: (disabled)
- RIP Version: 1, 2, 1 and 2
- Enable Static Routing: (disabled)

Input fields for static routing:

- IP Address:
- Subnet Mask:
- Gateway:

Buttons: Add/Edit Route, Delete Route, Apply.

Static Routes table:

No	IP Address	Subnet Mask	Gateway
<input type="radio"/>			

2. Enter the following:

Dynamic Routing

Enable RIP	Select to enable Dynamic Routing Information Protocol (RIP) to assign routes automatically. Disabled by default.
RIP Version	Select the RIP version. The default is 2 .

Static Routing

Enable Static Routing	<p>Select to assign the routes manually. The system administrator usually provides the routes. Disabled by default.</p> <ul style="list-style-type: none"> ◆ To add a static route, enter the IP Address, Subnet Mask, and Gateway for the route and click the Add/Edit Route button. The route displays in the Static Routes table. You can add up to 64 static routes. ◆ To edit a static route, select the radio button to the right of the route, change the IP Address, Subnet Mask, and Gateway fields as desired, and click the Add/Edit Route button. ◆ To delete a static route, select the radio button to the right of the route and click the Delete Route button.
------------------------------	--

3. Click the **Apply** button.

Note: To display the routing table, status or specific report, see the section, [Status/Reports on page 291](#).

Equivalent Routing Commands

The following CLI commands correspond to the web page entries described above.

To configure static or dynamic routing:

```
set routing [parameters]
```

Parameters

```
rip <enable|disable>
route <1-64> ipaddr <IP Address> mask <Netmask> gateway <IP Address>
static <enable|disable>
version <1|2|both>
```

Note: To delete a static route, set the IP address, mask, and gateway parameters to 0.0.0.0.

To set the routing table to display IP addresses (disable) or the corresponding host names (enable):

```
show routing [resolveip <enable|disable>] [email <Email Address>]
```

Note: You can optionally email the displayed information.

VPN

This page can be used to create a Virtual Private Network (VPN) tunnel to the SLC 8000 advanced console manager for secure communication between the SLC unit and a remote host or gateway. The SLC 8000 advanced console manager supports IPsec tunnels using Encapsulated Security Payload (ESP). The SLC unit supports host-to-host, net-to-net, host-to-net, and roaming user tunnels.

Note: To allow VPN tunnel access if the SLC firewall is enabled, traffic to UDP ports 500 and 4500 from the remote host should be allowed, as well as protocol ESP from the remote host.

To complete the VPN page:

1. Click the **Network** tab and select the **VPN** option. The following page displays:

Figure 6-6 Network > VPN

LANTRONIX[®] SLC 8048

Logout Host: slc4331 User: sysadmin

Select port for Configuration WebSSH (DP only) Connected Device (DP only)

Network Services User Authentication Devices Maintenance Quick Setup

Network Settings IP Filter Routing VPN Security

VPN Help?

Enable VPN Tunnel: Current Tunnel Status: **Down**

Name:

Ethernet Port: 1 2

Remote Host:

Remote Id:

Remote Hop/Router:

Remote Subnet(s): [View Detailed Status >](#)

Local Id: [View VPN Logs >](#)

Local Hop/Router: [View SLC RSA Public Key >](#)

Local Subnet(s): [View X.509 Certificates >](#)

IKE Negotiation: Main Mode Aggressive Mode

IKE v2:

IKE Encryption: Authentication: DH Group:

ESP Encryption: Authentication: DH Group:

Authentication: RSA Public Key Pre-Shared Key X.509 Certificate

RSA Public Key for Remote Host:

Pre-Shared Key: Retype Pre-Shared Key:

Certificate Authority for Remote Peer: [Upload File >](#)

Certificate File for Remote Peer: [Upload File >](#)

Certificate Authority for Local Peer: [Upload File >](#)

Certificate File for Local Peer: [Upload File >](#)

Key File for Local Peer: [Upload File >](#)

Perfect Forward Secrecy:

SA Lifetime:

Mode Configuration Client:

XAUTH Client:

XAUTH Login:

XAUTH Password: Retype Password:

Remote Peer Type: IETF (non-Cisco) Cisco

Force Encapsulation:

Dead Peer Detection: No Yes, Delay: seconds

Dead Peer Detection Timeout:

Dead Peer Detection Action:

2. Enter the following:

Enable VPN Tunnel	Select to create a tunnel.
Name	The name assigned to the tunnel. Required to create a tunnel.
Ethernet Port	Select Ethernet port 1 or 2.
Remote Host	The IP address of the remote host's public network interface. The special value of any can be entered if the remote host is a roaming user who may not have the same IP address each time a tunnel is created. In this case, it is recommended that the Remote Id also be configured.
Remote Id	How the remote host should be identified for authentication. The Id is used to select the proper credentials for communicating with the remote host.
Remote Hop/Router	If the remote host is behind a gateway, this specifies the IP address of the gateway's public network interface.
Remote Subnet(s)	One or more subnets behind the remote host, expressed in CIDR notation (IP address/mask bits). If multiple subnets are specified, the subnets should be separated by a comma.
Local Id	How the SLC 8000 advanced console manager should be identified for authentication. The Id is used by the remote host to select the proper credentials for communicating with the SLC advanced console manager.
Local Hop/Router	If the SLC unit is behind a gateway, this specifies the IP address of the gateway's public network interface.
Local Subnet(s)	One or more subnets behind the SLC 8000 advanced console manager, expressed in CIDR notation (IP address/mask bits). If multiple subnets are specified, the subnets should be separated by a comma.
IKE Negotiation	The Internet Key Exchange (IKE) protocol is used to exchange security options between two hosts who want to communicate via IPsec. The first phase of the protocol authenticates the two hosts to each other and establishes the Internet Security Association Key Management Protocol Security Association (ISAKMP SA). The second phase of the protocol establishes the cryptographic parameters for protecting the data passed through the tunnel, which is the IPsec Security Association (IPsec SA). The IPsec SA can periodically be renegotiated to ensure security. The IKE protocol can use one of two modes: Main Mode , which provides identity protection and takes longer, or Aggressive Mode , which provides no identity protection but is quicker. With Aggressive Mode, there is no negotiation of which cryptographic parameters will be used; each side must give the correct cryptographic parameters in the initial package of the exchange, otherwise the exchange will fail. If Aggressive Mode is used, the IKE Encryption , IKE Authentication , and IKE DH Group must be specified.

IKE v2	<p>IKE version 2 settings to be used. Currently the accepted values are Permit, (the default) signifying no IKEv2 should be transmitted, but will be accepted if the other ends initiates to us with IKEv2; Never signifying no IKEv2 negotiation should be transmitted or accepted; Propose signifying that the SLC will permit IKEv2, and also use it as the default to initiate; Insist, signifying that the SLC only accept and receive IKEv2 and IKEv1 negotiations will be rejected.</p> <p>If the IKEv2 setting is set to Permit or Propose, the SLC will try and detect a "bid down" attack from IKEv2 to IKEv1. Since there is no standard for transmitting the IKEv2 capability with IKEv1, the SLC uses a special Vendor ID "CAN-IKEv2". If a fall back from IKEv2 to IKEv1 was detected, and the IKEv1 negotiation contains Vendor ID "CAN-IKEv2", the SLC will immediately attempt an IKEv2 rekey and refuse to use the IKEv1 connection. With an IKEv2 setting of Insist, no IKEv1 negotiation is allowed, and no bid down attack is possible.</p>
IKE Encryption	The type of encryption, 3DES , AES , SHA2_256 or SHA2_512 used for IKE negotiation. Any can be selected if the two sides can negotiate which type of encryption to use.
Authentication (IKE)	The type of authentication, SHA1 or MD5 , used for IKE negotiation. Any can be selected if the two sides can negotiate which type of authentication to use.
DH Group (IKE)	The Diffie-Hellman Group, 2 , 5 , 14 or 15 used for IKE negotiation. Any can be selected if the two sides can negotiate which Diffie-Hellman Group to use.
ESP Encryption	The type of encryption, 3DES or AES , used for encrypting the data sent through the tunnel. Any can be selected if the two sides can negotiate which type of encryption to use.
Authentication (ESP)	The type of authentication, SHA1 , MD5 , or SHA2_512 used for authenticating data sent through the tunnel. Any can be selected if the two sides can negotiate which type of authentication to use.
DH Group (ESP)	The Diffie-Hellman Group, 2 , 5 , 14 or 15 , used for the key exchange for data sent through the tunnel. Any can be selected if the two sides can negotiate which Diffie-Hellman Group to use.
Authentication	<p>The type of authentication used by the host on each side of the VPN tunnel to verify the identity of the other host.</p> <ul style="list-style-type: none"> ◆ For RSA Public Key, each host generates a RSA public-private key pair, and shares its public key with the remote host. The RSA Public Key for the SLC 8000 advanced console manager (which has 2192 bits) can be viewed at either the web or CLI. ◆ For Pre-Shared Key, each host enters the same passphrase to be used for authentication. ◆ For X.509 Certificate, each host is configured with a Certificate Authority certificate along with a X.509 certificate with a corresponding private key, and shares the X.509 certificate with the remote host.
RSA Public Key for Remote Host	If RSA Public Key is selected for authentication, enter the public key for the remote host.
Pre-Shared Key	If Pre-Shared Key is selected for authentication, enter the key.
Retype Pre-Shared Key	If Pre-Shared Key is selected for authentication, re-enter the key.

Certificate Authority for Remote Peer	<p>A certificate can be uploaded to the SLC unit for peer authentication. The certificate for the remote peer is used to authenticate the SLC to the remote peer, and at a minimum contains the public certificate file of the remote peer. The certificate may also contain a Certificate Authority file; if the Certificate Authority file is omitted, the SLC may display "issuer cacert not found" and "X.509 certificate rejected" messages, but still authenticate. The Certificate Authority file and public certificate File must be in PEM format, e.g.:</p> <pre>-----BEGIN CERTIFICATE----- (certificat e in base64 encoding) -----END CERTIFICATE-----</pre>
Certificate File for Remote Peer	
Certificate Authority for Local Peer	<p>A certificate can be uploaded to the SLC unit for peer authentication. The certificate for the local peer is used to authenticate any remote peer to the SLC, and contains a Certificate Authority file, a public certificate file, and a private key file. The public certificate file can be shared with any remote peer for authentication. The Certificate Authority and public certificate file must be in PEM format, e.g.:</p> <pre>-----BEGIN CERTIFICATE----- (certificat e in base64 encoding) -----END CERTIFICATE-----</pre> <p>The key file must be in RSA private key file (PKCS#1) format, eg:</p> <pre>-----BEGIN RSA PRIVATE KEY----- (private key in base64 encoding) -----END RSA PRIVATE KEY-----</pre>
Certificate File for Local Peer	
Key File for Local Peer	
Perfect Forward Secrecy	<p>When a new IPSec SA is negotiated after the IPSec SA lifetime expires, a new Diffie-Hellman key exchange can be performed to generate a new session key to be used to encrypt the data being sent through the tunnel. If this is enabled, it provides greater security, since the old session keys are destroyed.</p>
SA Lifetime	<p>How long a particular instance of a connection should last, from successful negotiation to expiry, in seconds. Normally, the connection is renegotiated (via the keying channel) before it expires.</p>
Mode Configuration Client	<p>If this is enabled, the SLC unit can receive network configuration from the remote host. This allows the remote host to assign an IP address/netmask to the SLC advanced console manager side of the VPN tunnel.</p>
XAUTH Client	<p>If this is enabled, the SLC 8000 advanced console manager will send authentication credentials to the remote host if they are requested. XAUTH, or Extended Authentication, can be used as an additional security measure on top of the Pre-Shared Key or RSA Public Key.</p>
XAUTH Login (Client)	<p>If XAUTH Client is enabled, this is the login used for authentication.</p>
XAUTH Password	<p>If XAUTH Client is enabled, this is the password used for authentication.</p>
Retype Password	<p>If XAUTH Client is enabled, this is the password used for authentication.</p>
Remote Peer Type	<p>Defines the type of the remote peer, either IETF (non-Cisco) or Cisco. When set to Cisco, support for Cisco IPsec gateway redirection and Cisco obtained DNS and domainname are enabled.</p>
Force Encapsulation	<p>In some cases, for example when ESP packets are filtered or when a broken IPsec peer does not properly recognise NAT, it can be useful to force RFC-3948 encapsulation.</p>

Dead Peer Detection	Sets the delay (in seconds) between Dead Peer Detection (RFC 3706) keepalives (R_U_THERE, R_U_THERE_ACK) that are sent for the tunnel (default 30 seconds). Dead Peer Detection can also be disabled.
Dead Peer Detection Timeout	Sets the length of time (in seconds) the SLC will idle without hearing either an R_U_THERE poll from the peer, or an R_U_THERE_ACK reply. The default is 120 seconds. After this period has elapsed with no response and no traffic, the SLC will declare the peer dead, remove the Security Association (SA), and perform the action defined by Dead Peer Detection Action.
Dead Peer Detection Action	When a Dead Peer Detection enabled peer is declared dead, the action that should be taken. Hold (the default) means the tunnel will be put into a hold status. Clear means the Security Association (SA) will be cleared. Restart means the SA will immediately be renegotiated.

- To save, click **Apply** button.
- To see a details of the VPN tunnel connection, including the cryptographic algorithms used, select the **View Detailed Status** link.
- To see the last 100 lines of the logs associated with the VPN tunnel, select the **View VPN Logs** link.
- To see the RSA public key for the SLC 8000 advanced console manager (required for configuring the remote host if RSA Public Keys are being used), select the **View SLC RSA Public Key** link.
- To see the X.509 Certificates for the SLC 8000 advanced console manager, select the **View X.509 Certificates** link.

Configuring an IPsec VPN Tunnel through the CLI

- Set vpn <parameters>:

```
tunnel <enable|disable>
ethport <1|2>
auth <rsa|psk|x509>
remotehost <RemoteHost IP Address or name>
remoteid <Authentication name>
remotehop <IP Address>
remotesubnet <one or more subnets in CIDR notation>
localid <Authentication Name>
localhop <IP Address>
localsubnet <one or more subnets in CIDR notation>
ikenegotiation <main|aggressive>
ikeenc <any|3des|aes>
ikeauth <any|sha1|md5|sha2_256|sha2_512>
ikedhgroup <any|dh2|dh5|dh14|dh15>
espenc <any|3des|aes>
espauth <any|sha1|md5|sha2_256|sha2_512>
espdhgroup <any|dh2|dh5|dh14|dh15>
pfs <enable|disable>
lifetime <SA Lifetime in Seconds>
modeconfig <enable|disable>
xauthclient <enable|disable>
xauthlogin <User Login>
```

```

remotepeertype <ietf|cisco>
forceencaps <enable|disable>
deadpeerdelay <disable|1-300 seconds>
deadpeertimeout <5-1200 seconds>
deadpeeraction <restart|hold|clear>

```

2. Enter RSA public key or Pre-Shared Key of remote host: `set vpn key`
3. Configure X.509 certificate for remote peer or local peer.

```

set vpn certificate local via <sftp|scp> rootfile
    <Cert Authority File>
certfile <Certificate File> keyfile <Private Key File>
host <IP Address or Name> login <User Login> [path <Path to Files>]
set vpn certificate remote via <sftp|scp> [rootfile
    <Cert Authority File>]
certfile <Certificate File> host <IP Address or Name>
login <User Login> [path <Path to Files>]

```

4. Delete X.509 certificate for local and/or remote peer.

```
set vpn certificate delete
```
5. Enter XAUTH password: `set vpn xauthpassword`
6. Display all VPN settings and current status: `show vpn [email <Email Address>]`
7. Display detailed VPN status: `show vpn status [email <Email Address>]`
8. Display VPN logs: `show vpn viewlog [numlines <Number of Lines>] [email <Email Address>]`
9. Display RSA public key of the SLC: `show vpn rsakey`

Security

The SLC 8000 advanced console manager supports a security mode that complies with the FIPS 140-2 standard. FIPS (Federal Information Processing Standard) 140-2 is a security standard developed by the United States federal government that defines rules, regulations and standards for the use of encryption and cryptographic services. The National Institute of Standards and Technology (NIST) maintains the documents related to FIPS at:

<http://csrc.nist.gov/publications/PubsFIPS.html>

FIPS 140-2 defines four security levels, Level 1 through Level 4. The SLC unit uses a FIPS module certified at Level 1.

Note: *The SSH client keyboard-interactive authentication type is not supported while the SLC unit is in FIPS mode. The SLC 8000 can support a limit of 25 concurrent CLI sessions simultaneously when in FIPs mode.*

To enable FIPS mode, the **Network -> Security -> FIPS Mode** flag needs to be enabled and the SLC unit rebooted. Each time the SLC unit is booted in FIPS mode, it will perform a power up self test to verify the integrity of the SLC unit's cryptographic module. If there are any issues with the integrity of the cryptographic module, FIPS mode will be disabled and the SLC unit will be rebooted into non-FIPS mode.

When the SLC unit is running in FIPS mode, the following protocols are supported: TLS 1.0, TLS 1.1, TLS 1.2, and SSH v2.

For SSL, the SLC unit will support the following cipher suites:

- ◆ AES128-SHA
- ◆ AES128-SHA256
- ◆ AES128-GCM-SHA256
- ◆ AES256-SHA
- ◆ AES256-SHA256
- ◆ AES256-GCM-SHA384

SSL/secure certificates imported for use with the web server or LDAP authentication must use either the SHA1 or SHA2 hash with a RSA public key of 1024, 2048 or 3072 bits.

For SSH, the SLC unit will support the following cipher suites:

- * AEAD-AES-128-GCM-SSH
- * AEAD-AES-256-GCM-SSH
- * AES128-CTR
- * AES256-CTR
- * AES192-CTR

SSH Keys imported for use with SSH authentication must use a RSA public key of 1024, 2048 or 3072 bits. SSH Keys exported by the SLC must use a RSA public key of 2048 or 3072 bits.

When the SLC unit is running in FIPS mode, the following protocols/functions will not be supported: NIS, Kerberos, RADIUS, TACACS+, Telnet/WebTelnet, WebSSH, IPsec/VPN, SSH v1, FTP, PPP, CIFS/Samba, TCP, UDP, unencrypted LDAP, and SNMP. If any of these protocols/functions are enabled prior to enabling FIPS mode, they will be automatically disabled.

LDAP authentication must be configured with the following:

- ◆ StartTLS encryption (SSL encryption over port 636 is not supported)
- ◆ A SSL/secure certificate
- ◆ Either Bind with Login or a Bind Name and Password

Note: In FIPS mode, passphrases are not supported for SSH keys and SSL certificates.

Figure 6-7 Network > Security

The screenshot shows the LANTRONIX SLC 8048 web interface. At the top, there is a navigation bar with tabs for Network, Services, User Authentication, Devices, Maintenance, and Quick Setup. The 'Security' tab is selected. Below the navigation bar, there is a section for 'Enable FIPS Mode' with a checkbox and a note: 'Note: Changing FIPS Mode requires a reboot.' An 'Apply' button is located below the note. The interface also displays the host name 'slc4331' and user 'sysadmin'. A keyboard layout is visible at the top right of the interface.

To enable FIPS:

Note: The SSH client keyboard-interactive authentication type is not supported while the SLC unit is in FIPS mode.

1. Check the **Enable FIPS Mode** check box on the **Networks > Security** page.
2. Click **Apply**. The SLC unit will need to be rebooted to initiate FIPS mode. Once the SLC module is running in FIPS mode, the Security page, will display all processes that are running in FIPS mode.

To disable FIPS:

1. Uncheck the **Enable FIPS Mode** check box on the **Networks > Security** page.
2. Click **Apply**. The SLC unit will need to be rebooted for this change to take effect. When rebooted after disabling FIPS mode, information about processes running in FIPS mode will no longer display on the Security page.

7: Services

System Logging and Other Services

Use the **Services** tab to:

- ◆ Configure the amount of data sent to the logs.
- ◆ Enable or disable SSH and Telnet logins.
- ◆ Enable a Simple Network Management Protocol (SNMP) agent.

Note: *The SLC advanced console manager supports both MIB-II (as defined by RFC 1213) and a private enterprise MIB. The private enterprise MIB provides read-only access to all statistics and configurable items provided by the SLC unit. It provides read-write access to a select set of functions for controlling the SLC 8000 advanced console manager and device ports. See the MIB definition file for details.*

- ◆ Identify a Simple Mail Transfer Protocol (SMTP) server.
- ◆ Enable or disable SSH and Telnet logins.
- ◆ Configure an audit log.
- ◆ View the status of and manage the SLC 8000 advanced console managers on the Secure Lantronix network.
- ◆ Set the date and time.
- ◆ Configure NFS and CIFS shares.
- ◆ Configure the web server.

SSH/Telnet/Logging

To configure SSH, Telnet, and Logging settings:

1. Click the **Services** tab and select the **SSH/Telnet/Logging** option. The following page displays.

Figure 7-1 Services > SSH/Telnet/Logging

LANTRONIX® SLC 8048

Logout Host: slc4331 User: sysadmin

Select port for Configuration WebSSH (DP only) Connected Device (DP only)

Network Services User Authentication Devices Maintenance Quick Setup

SSH/Telnet/Logging SNMP NFS/CIFS Secure Lantronix Network Date & Time Web Server

SSH/Telnet/Logging

System Logging

Network Level: Warning
 Services: Warning
 Authentication: Warning
 Device Ports: Warning
 Diagnostics: Warning
 General: Warning

Remote Server #1:
 #2:

RPM Log Size: 20 Kbytes
 Other Log Size: 200 Kbytes

Audit Log

Enable Log:
 Size: 50 Kbytes
 Include CLI Commands:
 Include in System Log:

SMTP

Server:
 Sender: donotreply@\$host.\$domain
 Note: '\$host' and '\$domain' will be substituted with hostname and domain.

SSH

Enable Logins: Web SSH:
 Timeout: No Yes: 0 minutes
 Timeout Data Direction: Both Directions
 SSH Port: 22
 SSH V1 Logins:
 DSA Keys:

Telnet

Enable Logins: Web Telnet:
 Timeout: No Yes: 0 minutes
 Timeout Data Direction: Both Directions
 Outgoing Telnet:

Web SSH/Web Telnet Settings

Terminal Buffer Size: 250

Phone Home

Enable:
 IP Address:
 Last Attempt: N/A
 Results: N/A

Apply

2. Enter the following settings:

System Logging

In the System Logging section, select one of the following alert levels from the drop-down list for each message category:

- ◆ **Off:** Disables this type of logging.
- ◆ **Error:** Saves messages that are output because of an error.
- ◆ **Warning:** Saves message output from a condition that may be cause for concern, in addition to error messages. This is the default for all message types.

- ◆ **Info:** Saves informative message, in addition to warning and error messages.
- ◆ **Debug:** Saves extraneous detail that may be helpful in tracking down a problem, in addition to information, warning, and error messages.

Network Level	Messages concerning the network activity, for example about Ethernet and routing.
Services	Messages concerning services such as SNMP and SMTP.
Authentication	Messages concerning user authentication.
Device Ports	Messages concerning device ports and connections.
Diagnostics	Messages concerning system status and problems.
General	Any message not in the categories above.
Remote Servers (#1 and #2)	<p>The IPv4 or IPv6 address of the remote server(s) where system logs are stored. The system log is always saved to local SLC storage. It is retained through SLC unit reboots for files up to 200K. Saving the system log to a server that supports remote logging services (see RFC 3164) allows the administrator to save the complete system log history.</p> <p><i>Note: If the SLC is unable resolve the Remote Server hostnames or contact the Remote Servers to send syslog messages, the syslog messages that cannot be sent to a Remote Server may appear on the SLC console port.</i></p>
RPM Log Size	The maximum size in Kbytes that RPM logs can grow to before they are pruned. When the file is pruned, it will be pruned to 50% of the RPM Log Size.
Other Log Size	The maximum size in Kbytes that all logs other than the RPM logs can grow to before they are pruned. When the file is pruned, it will be pruned to 50% of the Other Log Size.

Audit Log

Enable Log	Select to save a history of all configuration changes in a circular log. Disabled by default. The audit log is saved through SLC 8000 advanced console manager reboots.
Size	The log has a default maximum size of 50 Kbytes (approximately 500 entries). You can set the maximum size of the log from 1 to 500 Kbytes.
Include CLI Commands	Select to cause the audit log to include the CLI commands that have been executed. Disabled by default.
Include In System Log	If enabled, the contents of the audit log are added to the system log (under the General/Info category/level). Disabled by default.

SMTP

Server	IP address of your network's Simple Mail Transfer Protocol (SMTP) relay server. If an SMTP server is not specified, the SLC module will attempt to look up the MX record for the domain in the destination email addresses of outgoing emails.
Sender	The email address of the sender of outgoing emails. The strings "\$host" and "\$domain" can be part of the email address - they will be substituted with the actual hostname and domain. The default is donotreply@\$host.\$domain.

SSH

Enable Logins	<p>Enables or disables SSH logins to the SLC unit to allow users to access the CLI using SSH. Enabled by default.</p> <p>This setting does not control SSH access to individual device ports. (See Device Ports - Settings (on page 123) for information on enabling SSH access to individual ports.)</p> <p>Most system administrators enable SSH logins, which is the preferred method of accessing the system.</p>
Web SSH	Enables or disables the ability to access the SLC command line interface or device ports (connect direct) through the Web SSH window. Disabled by default.
Timeout	If you enable SSH logins, you can cause an idle connection to disconnect after a specified number of minutes. Select Yes and enter a value of from 1 to 30 minutes.
Timeout Data Direction	<p>If idle connection timeouts are enabled, this setting indicates the direction of data used to determine if the connection has timed out. Select the type of data direction:</p> <ul style="list-style-type: none"> ◆ Both Directions ◆ Incoming Network ◆ Outgoing Network
SSH Port	Allows you to change the SSH login port to a different value in the range of 1 - 65535. The default is 22. Use of ports other than 22 that are less than 1025 is not recommended.
SSH V1 Logins	Enables or disables SSH version 1 connections to the SLC 8000 advanced console manager. Enabled by default.
DSA Keys	Enables or disables support for DSA keys for incoming and outgoing connections for the SLC unit. Any imported or exported DSA keys will be retained but will not be visible on the web or the CLI. Enabled by default.

Telnet

Enable Logins	<p>Enables or disables Telnet logins to the SLC unit to allow users to access the CLI using Telnet. Disabled by default.</p> <p>This setting does not control Telnet access to individual device ports. (See Device Ports > Settings (on page 125) for information on enabling Telnet access to individual ports.) You may want to keep this option disabled for security reasons.</p>
Web Telnet	Enables or disables the ability to access the SLC command line interface or device ports (connect direct) through the Web Telnet window. Disabled by default.
Timeout	If you enable Telnet logins, you can cause an idle connection to disconnect after a specified number of minutes. Select Yes and enter a value of from 1 to 30 minutes.
Timeout Data Direction	<p>If idle connection timeouts are enabled, this setting indicates the direction of data used to determine if the connection has timed out. Select the type of data direction:</p> <ul style="list-style-type: none"> ◆ Both Directions ◆ Incoming Network ◆ Outgoing Network
Outgoing Telnet	Enables or disables the ability to create Telnet out connections.

Web SSH/Web Telnet Settings

Terminal Buffer Size	<p>Number of lines in the Web SSH or Web Telnet terminal window that are available for scrolling back through output.</p> <p>Note: For tips on browser issues with Web SSH or Web Telnet, see Troubleshooting Browser Issues.</p>
-----------------------------	--

Phone Home

Enable	If enabled, allows SLC 8000 advanced console manager to directly contact a vSLM™ management appliance and request addition to the database
IP Address	IP address of the SLM device.
Last Attempt (view only)	Displays the date and time of last connection attempt.
Results (view only)	Indicates whether the attempt was successful.

3. To save, click the **Apply** button.

SNMP

Simple Network Management Protocol (SNMP) is a set of protocols for managing complex networks. The SLC unit supports both MIB-II (as defined by RFC 1213) and a private enterprise MIB. The private enterprise MIB provides read-only access to all statistics and configurable items provided by the SLC unit. It provides read-write access to a select set of functions for controlling the SLC unit and device ports. See the MIB definition file for details. The SLC MIB definition file and the top level MIB file for all Lantronix products is accessible from the SNMP web page.

1. Click the **Services** tab and select the **SNMP** option. The following page displays:

Figure 7-2 Services > SNMP

LANTRONIX[®] SLC 8048

Logout Host: slc4331 User: sysadmin

Select port for Configuration WebSSH (DP only) Connected Device (DP only)

Network Services User Authentication Devices Maintenance Quick Setup

SSH/Telnet/Logging SNMP NFS/CIFS Secure Lantronix Network Date & Time Web Server

SNMP Help ?

Enable Agent: [Top Level MIB](#) [SLC MIB](#)

Enable v1/v2c:

Enable Traps:

Trap Version: 2c ▾

NMS #: 172.20.197.131

NMS #: 172.20.197.131

Alarm Delay: 60 seconds

Engine ID: 800000F4030080A3964331

Location: location

Contact: contact

v1/v2c Communities

Read-Only: public

Read-Write: private

Trap: public

Version 3

Security: No Auth/No Encrypt
 Auth/No Encrypt
 Auth/Encrypt

Auth with: MD5 SHA

Encrypt with: DES AES

Traps Enabled for Sending	
coldStart (1.3.6.1.6.3.1.1.5.1)	<input checked="" type="checkbox"/>
linkDown (1.3.6.1.6.3.1.1.5.3)	<input checked="" type="checkbox"/>
linkUp (1.3.6.1.6.3.1.1.5.4)	<input checked="" type="checkbox"/>
authenticationFailure (1.3.6.1.6.3.1.1.5.5)	<input checked="" type="checkbox"/>
slcEventPowerSupply (1.3.6.1.4.1.244.1.1.0.1)	<input checked="" type="checkbox"/>
slcEventSysadminPassword (1.3.6.1.4.1.244.1.1.0.2)	<input checked="" type="checkbox"/>
slcEventSLCShutdown (1.3.6.1.4.1.244.1.1.0.3)	<input checked="" type="checkbox"/>
slcEventDevicePortData (1.3.6.1.4.1.244.1.1.0.4)	<input checked="" type="checkbox"/>
slcEventDevicePortSLMData (1.3.6.1.4.1.244.1.1.0.5)	<input checked="" type="checkbox"/>
slcEventDevicePortSLMConfig (1.3.6.1.4.1.244.1.1.0.6)	<input checked="" type="checkbox"/>
slcEventDevicePortDeviceLowTemp (1.3.6.1.4.1.244.1.1.0.7)	<input checked="" type="checkbox"/>
slcEventDevicePortDeviceHighTemp (1.3.6.1.4.1.244.1.1.0.8)	<input checked="" type="checkbox"/>
slcEventDevicePortDeviceLowHumidity (1.3.6.1.4.1.244.1.1.0.9)	<input checked="" type="checkbox"/>
slcEventDevicePortDeviceHighHumidity (1.3.6.1.4.1.244.1.1.0.10)	<input checked="" type="checkbox"/>
slcEventDevicePortDeviceError (1.3.6.1.4.1.244.1.1.0.11)	<input checked="" type="checkbox"/>
slcEventUSBAction (1.3.6.1.4.1.244.1.1.0.14)	<input checked="" type="checkbox"/>
slcEventInternalTemp (1.3.6.1.4.1.244.1.1.0.13)	<input checked="" type="checkbox"/>
slcEventDevicePortError (1.3.6.1.4.1.244.1.1.0.15)	<input checked="" type="checkbox"/>
slcEventSDCardAction (1.3.6.1.4.1.244.1.1.0.16)	<input checked="" type="checkbox"/>
slcEventNoDialToneAlarm (1.3.6.1.4.1.244.1.1.0.17)	<input checked="" type="checkbox"/>
slcEventDevicePortDeviceContactChanged (1.3.6.1.4.1.244.1.1.0.20)	<input type="checkbox"/>
slcEventSFPAction (1.3.6.1.4.1.244.1.1.0.21)	<input type="checkbox"/>

SNMP Traps Sent/Fail: 768/12, Recv/Trans packets: 1951338/1261434 | IP: 0/0

v3 Users

Read-Only	Read-Write	Trap
User Name: snmpuser	snmprwuser	snmptrapuser
Password:
Retype Password:
Passphrase:		
Retype Passphrase:		

Apply

2. Enter the following:

Enable Agent	Enables or disables the Simple Network Management Protocol (SNMP) agent, which allows read-only access to the system. Disabled by default.
Top Level MIB	Click the link to access the top level MIB file for all Lantronix products.
SLC MIB	Click the link to access the SLC MIB definition file for SLC 8000 advanced console managers and advanced console managers.
Enable v1/v2c	If checked, SNMP version 1 and version 2 (which use the Read-Only and Read-Write Communities) are enabled. Uncheck to only allow the more secure version 3 to be used to access the SLC unit via SNMP. The default is enabled.
Enable Traps	<p>Traps are notifications of certain critical events. Disabled by default. This feature is applicable when SNMP is enabled. Traps that the SLC unit sends include:</p> <ul style="list-style-type: none"> ◆ coldStart (generic trap 0, OID 1.3.6.1.6.3.1.1.5.1) ◆ linkDown (generic trap 2, OID 1.3.6.1.6.3.1.1.5.3) ◆ linkUp (generic trap 3, OID 1.3.6.1.6.3.1.1.5.4) ◆ authenticationFailure (generic trap 4, OID 1.3.6.1.6.3.1.1.5.5) ◆ slcEventPowerSupply (1.3.6.1.4.1.244.1.1.0.1) ◆ slcEventSysadminPassword (1.3.6.1.4.1.244.1.1.0.2) ◆ slcEventSLCShutdown (1.3.6.1.4.1.244.1.1.0.3) ◆ slcEventDevicePortData (1.3.6.1.4.1.244.1.1.0.4) ◆ slcEventDevicePortSLMData (1.3.6.1.4.1.244.1.1.0.5) ◆ slcEventDevicePortSLMConfig (1.3.6.1.4.1.244.1.1.0.6) ◆ slcEventDevicePortDeviceLowTemp (1.3.6.1.4.1.244.1.1.0.7) ◆ slcEventDevicePortDeviceHighTemp (1.3.6.1.4.1.244.1.1.0.8) ◆ slcEventDevicePortDeviceLowHumidity (1.3.6.1.4.1.244.1.1.0.9) ◆ slcEventDevicePortDeviceHighHumidity (1.3.6.1.4.1.244.1.1.0.10) ◆ slcEventDevicePortDeviceError (1.3.6.1.4.1.244.1.1.0.11) ◆ slcEventUSBAction (1.3.6.1.4.1.244.1.1.0.14) ◆ slcEventInternalTemp (1.3.6.1.4.1.244.1.1.0.13) ◆ slcEventDevicePortError (1.3.6.1.4.1.244.1.1.0.15) ◆ slcEventSDCardAction (1.3.6.1.4.1.244.1.1.0.16) ◆ slcEventNoDialToneAlarm (1.3.6.1.4.1.244.1.1.0.17) ◆ slcEventDevicePortDeviceContactChanged (1.3.6.1.4.1.244.1.1.0.20) ◆ slcEventSFPAction (1.3.6.1.4.1.244.1.1.0.21) <p>The SLC unit sends the traps to the host identified in the NMS #1 and NMS #2 field using the selected Trap Version.</p> <p>For information on these traps, view the SLC enterprise MIB, which is available on the SNMP web page.</p>
Trap Version	When traps are sent, which SNMP version to use when sending the trap: v1, v2c or v3. The default is v2c.
NMS #1 (or #2)	When SNMP is enabled, an NMS (Network Management System) acts as a central server, requesting and receiving SNMP-type information from any computer using SNMP. The NMS can request information from the SLC 8000 advanced console manager and receive traps from the SLC unit. Enter the IPv4 or IPv6 address of the NMS server. At least NMS #1 is required if you selected Enable Traps .
Alarm Delay	Number of seconds delay between outgoing SNMP traps.
Engine ID	The unique SNMP engine identifier for the SLC. This identifier may be required by the NMS in order to received v3 traps.
Location	Physical location of the SLC 8000 advanced console manager (optional). Useful for managing the SLC unit using SNMP. Up to 20 characters.
Contact	Description of the person responsible for maintaining the SLC 8000 advanced console manager, for example, a name (optional). Up to 20 characters.

v1/v2c Communities

Read-Only	A string that SNMP agent provides. The default is public .
Read-Write	A string that acts like a password for an SNMP manager to access the read-only data from the SLC unit SNMP, like a password for an SNMP manager to access the read-only data the SLC SNMP agent provides, and to modify data where permitted. The default is private .
Trap	The trap used for outgoing generic and enterprise traps. Traps sent with the Event trigger mechanism still use the trap community specified with the Event action. The default is public .

Version 3

Security	Levels of security available with SNMP v. 3. <ul style="list-style-type: none"> ◆ No Auth/No Encrypt: No authentication or encryption. ◆ Auth/No Encrypt: Authentication but no encryption. (default) ◆ Auth/Encrypt: Authentication and encryption.
Auth with	For Auth/No Encrypt or Auth/Encrypt , the authentication method: <ul style="list-style-type: none"> ◆ MD5: Message-Digest algorithm 5 (default) ◆ SHA: Secure Hash Algorithm
Encrypt with	Encryption standard to use: <ul style="list-style-type: none"> ◆ DES: Data Encryption Standard (default) ◆ AES: Advanced Encryption Standard

V3 User Read-Only

User Name	SNMP v3 is secure and requires user-based authorization to access SLC MIB objects. Enter a user ID. The default is snmpuser . Up to 20 characters.
Password/Retype Password	Password for a user with read-only authority to use to access SNMP v3. The default is SNMPPASS . Up to 20 characters.
Passphrase/Retype Passphrase	Passphrase associated with the password for a user with read-only authority. Up to 20 characters. If this is not specified it will default to the v3 Read-Only Password.

V3 User Read-Write

User Name	SNMP v3 is secure and requires user-based authorization to access SLC MIB objects. Enter a user ID for users with read-write authority. The default is snmprwuser . Up to 20 characters.
Password/Retype Password	Password for the user with read-write authority to use to access SNMP v3. The default is SNMPRWPASS . Up to 20 characters.
Passphrase/Retype Passphrase	Passphrase associated with the password for a user with read-write authority. Up to 20 characters. If this is not specified it will default to the v3 Read-Write Password.

V3 User Trap

User Name	SNMP v3 is secure and requires user-based authorization to access SLC unit MIB objects. Enter a user ID for users with authority to send traps. The default is snmptrapuser . Up to 20 characters.
------------------	---

Password/ Retype Password	Password for the user with authority to send v3 traps. The default is SNMPTRAPPASS. Up to 20 characters.
Passphrase/ Retype Passphrase	Passphrase associated with the password for a user with authority to send v3 traps. Up to 20 characters. If this is not specified it will default to the v3 Trap Password.

3. To save, click the **Apply** button.

SNMP, SSH, Telnet, and Logging Commands

The following CLI commands correspond to the web page entries described above.

To configure services (system logging, SSH and Telnet access, SSH and Telnet timeout, SNMP agent, email (SMTP) server, and audit log):

```
set services <one or more services parameters>
```

Parameters

```
netlog <off|error|warning|info|debug>
authlog <off|error|warning|info|debug>
diaglog <off|error|warning|info|debug>
servlog <off|error|warning|info|debug>
devlog <off|error|warning|info|debug>
genlog <off|error|warning|info|debug>
syslogserver1 <IP Address or Name>
syslogserver2 <IP Address or Name>
rpmlogsize <5-40 Kbytes>
otherlogsize <5-400 Kbytes>
telnet <enable|disable>
timeouttelnet <disable|1-30 minutes>
telnetdatadir <netin|netout|both>
webtelnet <enable|disable>

escapeseqtelnet <1-10 Chars>

outgoingtelnet <enable|disable>
ssh <enable|disable>
portssh <TCP Port>
v1ssh <enable|disable>
timeoutssh <disable|1-30 minutes>

sshdatadir <netin|netout|both>
dsakeys <enable|disable>
webssh <enable|disable>
smtpserver <IP Address or Name>
smtpsender <Email Address>

auditlog <enable|disable>
auditsize <1-500 Kbytes>
clicommands <enable|disable>
includesyslog <enable|disable>
snmp <enable|disable>
v1v2 <enable|disable>
traps <enable|disable>
trapversion <1|2|3>
nms1 <IP Address or Name>
nms2 <IP Address or Name>
alarmdelay <1-6000 Seconds>
location <Physical Location>
contact <Admin Contact Info>
rocommunity <Read-Only
Community>
rwcommunity <Read-Write
Community>
trapcommunity <Trap Community>
v3user <v3 RO User>
v3rwuser <v3 RW User>
v3trapuser <v3 Trap User>
v3security
<noauth|auth|authencrypt>
v3auth <md5|sha>
v3encrypt <des|aes>
phonehome <enable|disable>
phoneip <IP Address>
termbufsize <Number of Lines>
```

To set SNMP v3 read-only password or passphrase, or read-write password or passphrase:

```
set services v3password|v3phrase|v3rwpassword|v3rwphrase|v3trappassword
|v3trapphrase
```

To view current services:

```
show services
```

NFS and SMB/CIFS

Use the [Services > NFS & SMB/CIFS](#) page if you want to save configuration and logging data onto a remote NFS server, or export configurations by means of an exported CIFS share.

Mounting an NFS shared directory on a remote network server onto a local SLC directory enables the SLC advanced console manager to store device port logging data on that network server. This configuration avoids possible limitations in the amount of disk space on the SLC unit available for the logging file(s). You may also save SLC configurations on the network server.

Similarly, use SMB/CIFS (Server Message Block/Common Internet File System), Microsoft's file-sharing protocol, to export a directory on the SLC 8000 advanced console manager as an SMB/CIFS share. The SLC unit exports a single read-write CIFS share called "public," with the subdirectory the config directory, which contains saved configurations and is read-write.

The share allows users to access the contents of the directory or map the directory onto a Windows computer.

To configure NFS and SMB/CIFS:

1. Click the **Services** tab and select the **NFS/CIFS** option. The following page displays:

Figure 7-3 Services > NFS & SMB/CIFS

NFS Mounts

	Remote Directory	Local Directory	Read-Write	Mount	Mounted
#1:	<input type="text"/>	<input type="text"/>	<input type="checkbox"/>	<input type="checkbox"/>	
#2:	<input type="text"/>	<input type="text"/>	<input type="checkbox"/>	<input type="checkbox"/>	
#3:	<input type="text"/>	<input type="text"/>	<input type="checkbox"/>	<input type="checkbox"/>	

SMB/CIFS Share

The SLC can be configured to share a directory containing the system logs to a Microsoft Windows network. This directory can also be used for saving SLC configurations via [Firmware & Configurations](#).

Share SMB/CIFS directory:

Network Interfaces: Eth1 (172.19.100.148) Eth2

CIFS User Password:

Retype Password:

Workgroup:

The SMB/CIFS share can be accessed by the 'cifsuser' login.

2. Enter the following for up to three directories:

NFS Mounts

Remote Directory	The remote NFS share directory in the format: nfs_server_hostname or ipaddr:/exported/path
Local Directory	The local directory on the SLC 8000 advanced console manager on which to mount the remote directory. The SLC unit creates the local directory automatically.
Read-Write	If enabled, indicates that the SLC 8000 advanced console manager can write files to the remote directory. If you plan to log port data or save configurations to this directory, you must enable this option.
Mount	Select the checkbox to enable the SLC unit to mount the file to the NFS server. Disabled by default.
Mounted	Indicates if the SLC was able to successfully mount the NFS share directory.

3. Enter the following:

SMB/CIFS Share

Share SMB/CIFS directory	Select the checkbox to enable the SLC 8000 advanced console manager to export an SMB/CIFS share called "public." Disabled by default.
Network Interfaces	Select the network ports from which the share can be seen. The default is for the share to be visible on both network ports.
CIFS User Password/Retype Password	Only one user special username (cifsuser) can access the CIFS share. Enter the CIFS user password in both password fields. The default user password is CIFSPASS . More than one user can access the share with the cifsuser user name and password at the same time.
Workgroup	The Windows workgroup to which the SLC unit belongs. Every PC exporting a CIFS share must belong to a workgroup. Can have up to 15 characters.

4. To save, click the **Apply** button.
5. Click the Firmware & Configurations link to access the [Firmware & Configurations \(on page 271\)](#) to save SLC configuration, as desired.

NFS and SMB/CIFS Commands

The following CLI commands correspond to the web page entries described above.

To mount a remote NFS share:

```
set nfs mount <one or more parameters>
```

Parameters

```
locdir <Directory>
mount <enable|disable>
remdir <Remote NFS Directory>
rw <enable|disable>
```

Enables read/write access to remote directory.

Note: *The remdir and locdir parameters are required, but if you specified them previously, you do not need to provide them again.*

To unmount a remote NFS share:

```
set nfs unmount <1|2|3>
```

To view NFS share settings:

```
show nfs
```

To configure the SMB/CIFS share, which contains the system and device port logs:

```
set cifs <one or more parameters>
```

Parameters

```
eth1 <enable|disable>
eth2 <enable|disable>
state <enable|disable>
```

```
workgroup <Windows Workgroup>
```

Note: The admin config command saves SLC configurations on the SMB/CIFS share.

To change the password for the SMB/CIFS share login (default is cifsuser):

```
set cifs password
```

To view SMB/CIFS settings:

```
show cifs
```

Secure Lantronix Network

Use the **Secure Lantronix Network** option to view and manage SLC and SLB console managers, SLC 8000 advanced console managers, and Lantronix Spider® devices on the local subnet.

Note: Status and statistics shown on the web interface represent a snapshot in time. To see the most recent data, reload the web page.

To access SLC and SLB console managers, and Lantronix Spider devices on the local network:

1. Click the **Services** tab and select the **Secure Lantronix Network** option. The following page displays.

Figure 7-4 Services > Secure Lantronix Network

LANTRONIX[®] SLC 8048

Logout Host: slc4331 User: sysadmin

Select port for Configuration WebSSH (DP only) Connected Device (DP only)

Network Services User Authentication Devices Maintenance Quick Setup

SSH/Telnet/Logging SNMP NFS/CIFS Secure Lantronix Network Date & Time Web Server

Secure Lantronix Network Help ?

Secure Lantronix Managers and Spiders on the local subnet.
Each host can be managed by selecting its IP address. [Search Options](#) [Refresh](#)

9 Device(s) found.

Hostname	Model	IP Address/ Web Interface	FW Ver	SSH/ Telnet to CLI	Ports Click on bright green ports to Web SSH or Web Telnet.																																																
slc4331	SLC8048	172.19.100.124	7.4.0.0B4	SSH Telnet	<table border="1"> <tr><td>1</td><td>3</td><td>5</td><td>7</td><td>9</td><td>11</td><td>13</td><td>15</td><td>17</td><td>19</td><td>21</td><td>23</td><td>25</td><td>27</td><td>29</td><td>31</td><td>33</td><td>35</td><td>37</td><td>39</td><td>41</td><td>43</td><td>45</td><td>47</td></tr> <tr><td>2</td><td>4</td><td>6</td><td>8</td><td>10</td><td>12</td><td>14</td><td>16</td><td>18</td><td>20</td><td>22</td><td>24</td><td>26</td><td>28</td><td>30</td><td>32</td><td>34</td><td>36</td><td>38</td><td>40</td><td>42</td><td>44</td><td>46</td><td>48</td></tr> </table>	1	3	5	7	9	11	13	15	17	19	21	23	25	27	29	31	33	35	37	39	41	43	45	47	2	4	6	8	10	12	14	16	18	20	22	24	26	28	30	32	34	36	38	40	42	44	46	48
1	3	5	7	9	11	13	15	17	19	21	23	25	27	29	31	33	35	37	39	41	43	45	47																														
2	4	6	8	10	12	14	16	18	20	22	24	26	28	30	32	34	36	38	40	42	44	46	48																														
slcfc61	SLC8016	172.19.100.82	7.4.0.0R3	N/A	<table border="1"> <tr><td>1</td><td>3</td><td>5</td><td>7</td><td>9</td><td>11</td><td>13</td><td>15</td></tr> <tr><td>2</td><td>4</td><td>6</td><td>8</td><td>10</td><td>12</td><td>14</td><td>16</td></tr> </table>	1	3	5	7	9	11	13	15	2	4	6	8	10	12	14	16																																
1	3	5	7	9	11	13	15																																														
2	4	6	8	10	12	14	16																																														
slc48250120-740B4	SLC8048	172.19.250.120	7.4.0.0B4	SSH Telnet	<table border="1"> <tr><td>1</td><td>3</td><td>5</td><td>7</td><td>9</td><td>11</td><td>13</td><td>15</td><td>17</td><td>19</td><td>21</td><td>23</td><td>25</td><td>27</td><td>29</td><td>31</td><td>33</td><td>35</td><td>37</td><td>39</td><td>41</td><td>43</td><td>45</td><td>47</td></tr> <tr><td>2</td><td>4</td><td>6</td><td>8</td><td>10</td><td>12</td><td>14</td><td>16</td><td>18</td><td>20</td><td>22</td><td>24</td><td>26</td><td>28</td><td>30</td><td>32</td><td>34</td><td>36</td><td>38</td><td>40</td><td>42</td><td>44</td><td>46</td><td>48</td></tr> </table>	1	3	5	7	9	11	13	15	17	19	21	23	25	27	29	31	33	35	37	39	41	43	45	47	2	4	6	8	10	12	14	16	18	20	22	24	26	28	30	32	34	36	38	40	42	44	46	48
1	3	5	7	9	11	13	15	17	19	21	23	25	27	29	31	33	35	37	39	41	43	45	47																														
2	4	6	8	10	12	14	16	18	20	22	24	26	28	30	32	34	36	38	40	42	44	46	48																														
slc	SLC8048	172.19.100.154	7.0.0.0R11	N/A	<table border="1"> <tr><td>1</td><td>3</td><td>5</td><td>7</td><td>9</td><td>11</td><td>13</td><td>15</td><td>17</td><td>19</td><td>21</td><td>23</td><td>25</td><td>27</td><td>29</td><td>31</td><td>33</td><td>35</td><td>37</td><td>39</td><td>41</td><td>43</td><td>45</td><td>47</td></tr> <tr><td>2</td><td>4</td><td>6</td><td>8</td><td>10</td><td>12</td><td>14</td><td>16</td><td>18</td><td>20</td><td>22</td><td>24</td><td>26</td><td>28</td><td>30</td><td>32</td><td>34</td><td>36</td><td>38</td><td>40</td><td>42</td><td>44</td><td>46</td><td>48</td></tr> </table>	1	3	5	7	9	11	13	15	17	19	21	23	25	27	29	31	33	35	37	39	41	43	45	47	2	4	6	8	10	12	14	16	18	20	22	24	26	28	30	32	34	36	38	40	42	44	46	48
1	3	5	7	9	11	13	15	17	19	21	23	25	27	29	31	33	35	37	39	41	43	45	47																														
2	4	6	8	10	12	14	16	18	20	22	24	26	28	30	32	34	36	38	40	42	44	46	48																														
slc48SFP251-7400B4	SLC8016	172.19.39.251	7.4.0.0B4	SSH Telnet	<table border="1"> <tr><td>1</td><td>3</td><td>5</td><td>7</td><td>9</td><td>11</td><td>13</td><td>15</td></tr> <tr><td>2</td><td>4</td><td>6</td><td>8</td><td>10</td><td>12</td><td>14</td><td>16</td></tr> </table>	1	3	5	7	9	11	13	15	2	4	6	8	10	12	14	16																																
1	3	5	7	9	11	13	15																																														
2	4	6	8	10	12	14	16																																														
slc-md	SLC8048	172.19.226.40	7.3.0.6A2	N/A	<table border="1"> <tr><td>1</td><td>3</td><td>5</td><td>7</td><td>9</td><td>11</td><td>13</td><td>15</td><td>17</td><td>19</td><td>21</td><td>23</td><td>25</td><td>27</td><td>29</td><td>31</td><td>33</td><td>35</td><td>37</td><td>39</td><td>41</td><td>43</td><td>45</td><td>47</td></tr> <tr><td>2</td><td>4</td><td>6</td><td>8</td><td>10</td><td>12</td><td>14</td><td>16</td><td>18</td><td>20</td><td>22</td><td>24</td><td>26</td><td>28</td><td>30</td><td>32</td><td>34</td><td>36</td><td>38</td><td>40</td><td>42</td><td>44</td><td>46</td><td>48</td></tr> </table>	1	3	5	7	9	11	13	15	17	19	21	23	25	27	29	31	33	35	37	39	41	43	45	47	2	4	6	8	10	12	14	16	18	20	22	24	26	28	30	32	34	36	38	40	42	44	46	48
1	3	5	7	9	11	13	15	17	19	21	23	25	27	29	31	33	35	37	39	41	43	45	47																														
2	4	6	8	10	12	14	16	18	20	22	24	26	28	30	32	34	36	38	40	42	44	46	48																														
slcfc57	SLC8016	172.19.100.167	7.4.0.0B4	N/A	<table border="1"> <tr><td>1</td><td>3</td><td>5</td><td>7</td><td>9</td><td>11</td><td>13</td><td>15</td></tr> <tr><td>2</td><td>4</td><td>6</td><td>8</td><td>10</td><td>12</td><td>14</td><td>16</td></tr> </table>	1	3	5	7	9	11	13	15	2	4	6	8	10	12	14	16																																
1	3	5	7	9	11	13	15																																														
2	4	6	8	10	12	14	16																																														
slc035c	SLC8016	172.19.100.30	7.3.0.6A2	SSH Telnet	<table border="1"> <tr><td>1</td><td>3</td><td>5</td><td>7</td><td>9</td><td>11</td><td>13</td><td>15</td></tr> <tr><td>2</td><td>4</td><td>6</td><td>8</td><td>10</td><td>12</td><td>14</td><td>16</td></tr> </table>	1	3	5	7	9	11	13	15	2	4	6	8	10	12	14	16																																
1	3	5	7	9	11	13	15																																														
2	4	6	8	10	12	14	16																																														
slcfc2b	SLC8016	172.19.217.201	7.4.0.0R3	N/A	<table border="1"> <tr><td>1</td><td>3</td><td>5</td><td>7</td><td>9</td><td>11</td><td>13</td><td>15</td></tr> <tr><td>2</td><td>4</td><td>6</td><td>8</td><td>10</td><td>12</td><td>14</td><td>16</td></tr> </table>	1	3	5	7	9	11	13	15	2	4	6	8	10	12	14	16																																
1	3	5	7	9	11	13	15																																														
2	4	6	8	10	12	14	16																																														

2. Access your device or device port through any of the methods below.

To directly access the web interface for a secure Lantronix device:

1. Make sure Web Telnet and Web SSH is enabled for the specific device or device port.
2. Click the IP address of a specific secure Lantronix device to open a new browser page with the web interface for the selected secure Lantronix device.
3. Log in as usual.

Figure 7-5 IP Address Login Page

To directly access the CLI interface for a device:

1. Click the **SSH** or **Telnet** link in the SSH/Telnet to CLI column directly beside the port you would like to access.

Note: For SLC console managers with 7.2.0.0 firmware releases and earlier, an SSH or Telnet popup window for Java appears (see [Figure 7-6](#)) before login. Click OK to dismiss this popup window and continue on to the login. For SLC console managers with 7.3.0.0 firmware releases and later, the SSH or Telnet popup window is bypassed and you are brought directly to the login in a non-Java based browser window (see [Figure 7-7](#)). For tips on troubleshooting browser issues for the non-Java based Web SSH/Telnet application, see [Browser Issues \(on page 105\)](#).

Figure 7-6 SSH and Telnet Opening File Popups

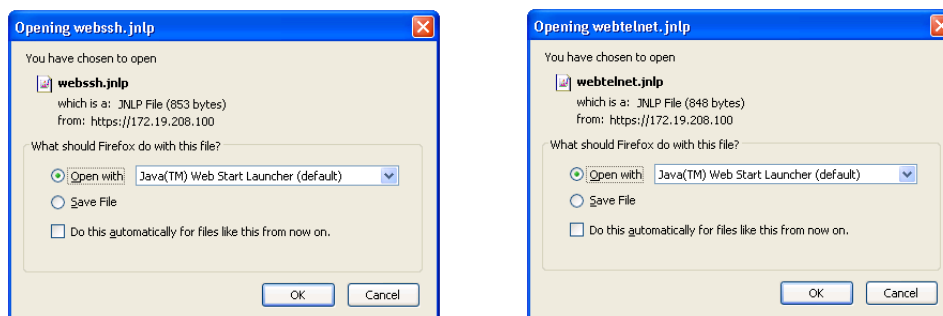

2. Click your mouse into the CLI login interface that appears and login. The CLI interface will indicate when your connection is established.
3. When using the non-Java Web SSH or Web Telnet window, to terminate the session, use either the host's logoff command. You may also use `^]` to terminate a Telnet session or `~.` to terminate an SSH session.

Figure 7-7 SSH or Telnet CLI Session

```

Lantronix SLC8048 WebTelnet: Connected to 172.19.39.251 Port 23 - Google Chrome
Connecting from 172.28.28.233 to 172.19.39.251 port 23...
To exit use the host's logoff command or use the escape sequence.
Trying 172.19.39.251...
Connected to 172.19.39.251.
Escape sequence is 'ESC T'.

*****
* This is a legal Welcome check. It is used to check the*
* maximum size supported by the Securlinux Devices. They*
* should support upto 1024 characters. If you have come*
* across this login by accident or an attempt to try to*
* crack into this system illegally, trust you are just*
* wasting your time. Here I will do better than that,*
* the User login name is sysadmin, and the default pass-*
* word is PASS.*
*
* Sorry to take the fun out of the crack, but I feel*
* since you are not going to believe me, I might as well*
* cut down on my bandwidth overhead and give you the key*
* to get inside. Since you will not be able to*
* physically take the system.*
* ~!@#% Rem. it is still illegal so enjoy-Welcome.*
*****

login: sysadmin
Password:

*****
* This is a legal Login check. It is used to check the*
* maximum size supported by the Securlinux Devices. They*
* should support upto 1024 characters. If you have come*
* across this login by accident or an attempt to try to*
* crack into this system illegally, trust you are just*
* wasting your time. Here I will do better than that,*
* the User Login name is sysadmin, and the default pass-*
* word is PASS.*
*
* Sorry to take the fun out of the crack, but I feel*
* since you are not going to believe me, I might as well*
* cut down on my bandwidth overhead and give you the key*
* to get inside. Since you will not be able to*
* physically take the system.*
* ~!@#% Rem. it is still illegal so enjoy-Logged In.*
*****

Welcome to the Lantronix SLC8000 Advanced Console Manager
Model Number: SLC8048
For a list of commands, type 'help'.

[slc485FP251-7400R5]>

```

To directly access a specific port on a particular device:

1. You have two options:

- Dashboard

Make sure the **WebSSH (DP only)** radio button directly beneath the Dashboard is selected and click the desired port number. The Dashboard is located on the upper right corner of each Web Manager page (see [Chapter 5: Web Page Layout](#).) An SSH popup window appears.

Note: *WebTelnet is not available from the Dashboard. See [Dashboard on page 60](#) as the dashboard may vary in appearance.*

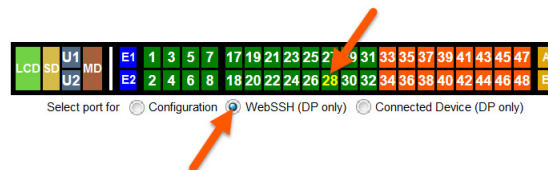

- Secure Lantronix Page

Click the **Services** tab, then click the **Secure Lantronix Network** link (see [Figure 7-4](#).) Select the port you want to configure. Enabled port numbers are in bright green boxes and will allow you to select either a **WebSSH** or a **WebTelnet** session. If enabled, an SSH or Telnet popup window appears depending on what is clicked. For SLC console managers with 7.2.0.0 firmware releases and earlier, an SSH or Telnet popup window for Java

appears (see [Figure 7-6](#)) before login. Click OK to dismiss this popup window and continue on to the login. For SLC console managers with 7.3.0.0 firmware releases and later, the SSH or Telnet popup window is bypassed and you are brought directly to the login in a non-Java based window (see [Figure 7-7](#)). For tips on troubleshooting browser issues for the non-Java based Web SSH/Telnet application, see [Browser Issues \(on page 105\)](#).

Note: Port numbers that are disabled are in dark green boxes; clicking a disabled port number generates a popup window indicating the port is disabled (see [Figure 7-8](#) below.)

Figure 7-8 Disabled Port Number Popup Window

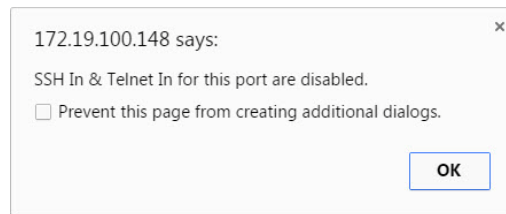

2. Click your mouse into the CLI login interface that appears (see [Figure 7-7](#)) and login. The CLI interface will indicate when your connection is established.
3. When using the non-Java Web SSH or Web Telnet window, to terminate the session, use either the host's logoff command, or use `^]` to terminate a Telnet session or `~.` to terminate an SSH session.

Browser Issues

Please check the Lantronix Knowledge Base at <http://ltxfaq.custhelp.com/app/answers/list> to research any browser errors.

To configure how secure Lantronix devices are searched for on the network:

1. Click the **Search Options** link on the top right of the [Services > Secure Lantronix Network](#) page. The following web page displays:

Figure 7-9 Services > Secure Lantronix Network > Search Options

The screenshot shows the Lantronix SLC 8048 web interface. At the top, there is a navigation bar with a 'Logout' button and user information: Host: slc4331, User: sysadmin. Below this is a menu with 'Services' selected. The main content area is titled 'Secure Lantronix Network - Search Options'. It features three radio buttons for search options: 'Local Subnet', 'Manually Entered IP Address List', and 'Both' (which is selected). There is an 'IP Address:' input field, an 'Add IP Address' button, a 'Delete IP Address' button, and an 'Apply' button. On the right, there is an 'IP Address List' box that currently displays 'No IP Address'. A 'Help?' link is visible in the top right corner of the main content area.

2. Enter the following:

Secure Lantronix Network Search	<p>Select the type of search you want to conduct.</p> <ul style="list-style-type: none"> ◆ Local Subnet performs a broadcast to detect secure Lantronix devices on the local subnet. ◆ Manually Entered IP Address List provides a list of IP addresses that may not respond to a broadcast because of how the network is configured. ◆ Both is the default selection.
IP Address	<p>If you selected Manually Entered IP Address List or Both, enter the IP address of the secure Lantronix device you want to find and manage.</p>

3. If you entered an IP address, click the **Add IP Address** button. The IP address displays in the IP Address List.
4. Repeat steps 2 and 3 for each IP address you want to add.
5. To delete an IP address from the IP Address List, select the address and click the **Delete IP Address** button.
6. Click the **Apply** button. When the confirmation message displays, click **Secure Lantronix Network** on the main menu. The [Services > Secure Lantronix Network](#) page displays the secure Lantronix devices resulting from the search. You can now manage these devices.

Secure Lantronix Network Commands

The following commands for the command line interface correspond to the web page entries described above.

To detect and view all SLC advanced console managers or user-defined IP addresses on the local network:

```
set slcnetwork <one or more parameters>
```

Parameters

```
add <IP Address>
delete <IP Address>
search <localsubnet|ipaddrlist|both>
```

To detect and display all SLC and SLB console managers and Lantronix Spider devices on the local network:

```
show slcnetwork [ipaddrlist <all|Address Mask>]
```

Note: Without the `ipaddrlist` parameter, the command searches the network according to the search setting. With the `ipaddrlist` parameter, the command displays a sorted list of all IP addresses or displays the IP addresses that match the mask (for example, `172.19.255.255` would display all IP addresses that start with `172.19`).

Date and Time

Use the Date and Time Settings page to specify the local date, time, and time zone at the SLC location, or enable the SLC unit to use NTP to synchronize with other NTP devices on your network. Note that changing the date/time and/or timezone, or enabling NTP may affect the user's ability to login to the web; if this happens, use the CLI `admin web restart` command to restart the web server.

The CLI `show ntp` command will display the current NTP status if NTP is enabled. The column headings are as follows: the host names or addresses shown in the remote column correspond to configured NTP server names; however, the DNS names might not agree if the names listed are not the canonical DNS names. The `refid` column shows the current source of synchronization, while the `st` column reveals the stratum, `t` the type (`u` = unicast, `m` = multicast, `l` = local, `-` = don't know), and `poll` the poll interval in seconds. The `when` column shows the time since the peer was last heard in seconds, while the `reach` column shows the status of the reachability register (see RFC-1305) in octal. The remaining entries show the latest delay, offset and jitter in milliseconds. The symbol at the left margin displays the synchronization status of each peer. The currently selected peer is marked `*`, while additional peers designated acceptable for synchronization, but not currently selected, are marked `+`. Peers marked `*` and `+` are included in the weighted average computation to set the local clock; the data produced by peers marked with other symbols are discarded.

To set the local date, time, and time zone:

1. Click the **Services** tab and select the **Date & Time** option. The following page displays:

Figure 7-10 Services > Date & Time

LANTRONIX® SLC 8048

Logout Host: slc4331 User: sysadmin

Select port for Configuration WebSSH (DP only) Connected Device (DP only)

Network Services User Authentication Devices Maintenance Quick Setup

SSH/Telnet/Logging SNMP NFS/CIFS Secure Lantronix Network Date & Time Web Server

Date & Time Help ?

Change Date/Time:

Date:

Time: : :

Time Zone:

Enable NTP: The SLC can synchronize its clock with a remote time server using NTP.

Current NTP status:

remote	refid	st	t	when	poll	reach	delay	offset	jitter
104.156.99.226	204.123.2.72	2	u	14	64	1	32.182	0.304	0.001
*LOCAL(0)	.LOCL.	10	l	13	64	1	0.000	0.000	0.001

Synchronize via: Broadcast from NTP Server Poll NTP Server(s):

Local: #1:
 #2:
 #3:

Public:

2. Enter the following:

Change Date/Time	Select the checkbox to manually enter the date and time at the SLC location.
Date	From the drop-down lists, select the current month, day, and year.
Time	From the drop-down lists, select the current hour and minute.
Time Zone	From the drop-down list, select the appropriate time zone. For information on each timezone, see http://en.wikipedia.org/wiki/List_of_tz_database_time_zones

3. To save, click the **Apply** button.

To synchronize the SLC 8000 advanced console manager with a remote timeserver using NTP:

1. Enter the following:

Enable NTP	Select the checkbox to enable NTP synchronization. NTP is disabled by default.
Current NTP status	Displays the current NTP status if NTP is enabled above.

Synchronize via	<p>Select one of the following:</p> <ul style="list-style-type: none"> ◆ Broadcast from NTP Server: Enables the SLC unit to accept time information periodically transmitted by the NTP server. This is the default if you enable NTP. ◆ Poll NTP Server: Enables the SLC 8000 advanced console manager to query the NTP Server for the correct time. If you select this option, complete one of the following: <ul style="list-style-type: none"> ➤ Local: Select this option if the NTP servers are on a local network, and enter the IPv4 or IPv6 address of up to three NTP servers. This is the default, and it is highly recommended. ➤ Public: Select this option if you want to use a public NTP server, and select the address of the NTP server from the drop-down list. This is not recommended because of the high load on many public NTP servers. All servers in the drop-down list are stratum-2 servers. (See www.ntp.org for more information.) Each public NTP server has its own usage rules --please refer to the appropriate web site before using one. Our listing them here is to provide easy configuration but does not indicate any permission for use.
------------------------	---

2. To save, click the **Apply** button.

Date and Time Commands

The following CLI commands correspond to the web page entries described above.

To set the local date, time, and local time zone (one parameter at a time):

```
set datetime <one parameter>
```

Parameters

```
date <MMDDYYhhmm[ss]>
timezone <Time Zone>
```

Note: If you do not know a valid <Time Zone>, enter 'timezone <invalid time zone>' and you will be guided through selecting one from the available time zones.

To view the local date, time, and time zone:

```
show datetime
```

To synchronize the SLC 8000 unit with a remote time server using NTP:

```
set ntp <one or more ntp parameters>
```

Parameters

```
localserver1 <IP Address or Hostname>
localserver2 <IP Address or Hostname>
localserver3 <IP Address or Hostname>
poll <local|public>
publicserver <IP Address or Hostname>
state <enable|disable>
sync <broadcast|poll>
```

To view NTP settings:

```
show ntp
```

Web Server

The Web Server supports all versions of the TLS protocol, but due to security concerns, does not support any versions of the SSL protocol. The Web Server page allows the system administrator to:

- ◆ Configure attributes of the web server.
- ◆ View and terminate current web sessions.
- ◆ Import a site-specific SSL certificate.
- ◆ Enable an iGoogle gadget that displays the status of ports on multiple SLC units.

To configure the Web Server:

1. Click the **Services** tab and select the **Web Server** option. The following page appears:

Figure 7-11 Services > Web Server

The screenshot shows the Lantronix SLC 8048 Web Server configuration page. At the top, there is a navigation bar with tabs for Network, Services, User Authentication, Devices, Maintenance, and Quick Setup. The Services tab is selected, and the Web Server option is highlighted. The page displays the following configuration options:

- Timeout:** Radio buttons for No (selected) and Yes, minutes (5-120): . Links for [Web Sessions >](#) and [SSL Certificate >](#) are visible.
- Enable TLS v1.0 Protocol:**
- Enable TLS v1.1 Protocol:**
- Cipher:** Radio buttons for High (256,168,128), High (256,168,128), Medium (128) (selected), and FIPS Approved.
- Note:** Changing TLS protocol or cipher requires a reboot or the CLI command "admin web restart".
- Group Access:**
- Banner:**
- Note:** Line feeds can be included in the banner with the '\n' character sequence.
- Network Interfaces:** Eth1 Eth2 PPP
- Run Web Server:** Setting can be changed via the CLI.
- Enable iGoogle Gadget Web Content:**

2. Enter the following fields:

Timeout	<ul style="list-style-type: none"> ◆ Select No to disable Timeout. ◆ Select Yes, minutes (5-120) to enable timeout. Enter the number of minutes (must be between 30 and 120 minutes) after which the SLC web session times out. The default is 5. <p>Note: <i>If a session times out, refresh the browser page and login to a new web session. If you close the browser without logging off the SLC unit first, you will have to wait for the timeout time to expire. You can also end a web session by using the admin web terminate command at the CLI or by asking your system administrator to terminate your active web session.</i></p> <ul style="list-style-type: none"> ◆ To view or terminate current web sessions, click the Web Sessions link. See Services - Web Sessions. ◆ To view, import, or reset the SSL Certificate, click the SSL Certificate link. See Services - SSL Certificate.
Enable TLS v1.0 Protocol	By default, the web supports the TLS v1.0 protocol. Uncheck this to disable the TLS v1.0 protocol. Changing this option requires a reboot or restarting the web server with the CLI command "admin web restart" for the change to take effect.
Enable TLS v1.1 Protocol	By default, the web supports the TLS v1.1 protocol. Uncheck this to disable the TLS v1.1 protocol. Changing this option requires a reboot or restarting the web server with the CLI command "admin web restart" for the change to take effect.
Cipher	By default, the web uses High/Medium security (128 bits or higher) for the cipher. This option can be used to configure the web to also support just High security ciphers (256 bit, 168 bit and some 128 bit), or FIPS approved ciphers (see Security .) Changing this option requires a reboot or restarting the web server with the CLI command <code>admin web restart</code> for the change to take effect.
Group Access	Specify one or more groups to allow access to the Web Manager user interface. If undefined, any group can access the web. If one or more groups are specified (groups are delimited by the characters ',' (comma) or ';' (semicolon)), then any user who logs into the web must be a member of one of the specified groups, otherwise access will be denied. Users authenticated via RADIUS may have a group (or groups) provided by the RADIUS server via the Filter-Id attribute that overrides the group defined for a user on the SLC. A group provided by a remote server must be either a single group or multiple groups delimited by the characters ',' (comma), ';' (semicolon), or '=' (equals) - for example "group=group1,group2," or "group1,group2,group3".
Banner	Enter to replace default text displayed on the Web Manager home page after the user logs in. May contain up to 1024 characters. Blank by default. To create additional lines in the banner use the \n character sequence.
Network Interfaces	The interfaces that the web server is available on. By default, Eth1, Eth2 and PPP interfaces on modems are enabled.
Run Web Server	If enabled, the web server will run and listen on TCP ports 80 and 443 (all requests to port 80 are redirected to port 443). By default, the web server is enabled. The web server supports TLS 1.0, TLS 1.1, and TLS 1.2. Due to security vulnerabilities, SSL is not supported. Note: <i>This option can only be changed at the CLI.</i>

3. Click the **Apply** button to save.

Admin Web Commands

The following CLI commands correspond to the web page entries described above.

To configure the timeout for web sessions:

```
admin web timeout <disable|5-120 minutes>
```

To configure the strength of the cipher used by the web server (high is 256, 168 and some 128 bit, medium is 128 bit):

```
admin web cipher <high|himed|fips>
```

To enable or disable TLS v1.0:

```
admin web tlsv10 <enable|disable>
```

To enable or disable TLS v1.1:

```
admin web tlsv11 <enable|disable>
```

To enable or disable iGoogle Gadget web content:

```
admin web gadget <enable|disable>
```

To configure the group that can access the web:

```
admin web group <Local or Remote Group Name>
```

To enable or disable the web server (TCP ports 80 and 443):

```
admin web server <enable|disable>
```

To configure the banner displayed on the web home page:

```
admin web banner <Banner Text>
```

To define a list of network interfaces the web is available on:

```
admin web iface <none,eth1,eth2,ppp>
```

To terminate a web session:

```
admin web terminate <Session ID>
```

To view the current sessions, with optional extra sessions or current ciphers:

```
admin web show [viewcipherlist <enable|disable>]
               [viewslmsessions <enable|disable>]
```

To restart the web server:

```
admin web restart
```

To import an SSL certificate or reset the web server certificate to the default:

```
admin web certificate import via <sftp|scp> certfile <Certificate File>
privfile <Private Key File> host <IP Address or Name>
login <User Login> [path <Path to Files>]
admin web certificate reset
admin web certificate show
```

To generate a custom self-signed SSL certificate:

```
admin web certificate custom
```

Services - Web Sessions

The [Services > Web Server](#) page enables you to view and terminate current web sessions.

To view or terminate current web sessions:

1. On the **Services** tab, click the **Web Server** page and click the **Web Sessions** link to the right. The following page displays:

Figure 7-12 Web Sessions

The screenshot shows the Lantronix SLC 8048 web interface. At the top, there's a navigation bar with 'Services' selected. Below it, there's a sub-menu with 'Web Sessions' highlighted. The main content area is titled 'Web Server - Web Sessions'. A table titled 'Current Web Sessions' is displayed, showing one session for user 'sysadmin' with login time '05/21/16 00:44' and idle time '0:00:00:00'. A 'Terminate' button is located to the right of the table.

Id	User	Login Time	Idle Time	
1	sysadmin	05/21/16 00:44	0:00:00:00	<input type="checkbox"/>

2. To terminate, click the check box in the row of the session you want to terminate and click the **Terminate** button.
3. To return to the [Services > Web Server](#) page, click the **Back to Web Server** link.

Services - SSL Certificate

The [Services > Web Server](#) page enables you to view and update SSL certificate information. The SSL certificate, consisting of a public/private key pair used to encrypt HTTP data, is associated with the web server. You can import a site-specific SSL certificate or generate a custom self-signed SSL certificate. The custom self-signed SSL certificates generated by the SLC use the SHA256 hash algorithm.

To view, reset, import, or change an SSL Certificate:

1. On the **Services** tab, click the **Web Server** page and click the **SSL Certificate** link. The following page displays the current SSL certificate.

Figure 7-13 SSL Certificate

LANTRONIX[®] SLC 8048

Logout Host: slc4331 User: sysadmin

Select port for Configuration WebSSH (DP only) Connected Device (DP only)

Network Services User Authentication Devices Maintenance Quick Setup

SSH/Telnet/Logging SNMP NFS/CIFS Secure Lantronix Network Date & Time Web Server

Web Server - SSL Certificate Help?

Current SSL Certificate (Default)

```

Certificate:
Data:
  Version: 1 (0x0)
  Serial Number:
    92:18:6a:c1:26:cf:b3:20
  Signature Algorithm: sha1WithRSAEncryption
  Issuer: C=US, ST=California, L=Irvine, O=Lantronix, CN=SLC
  Validity
    Not Before: Jan 25 13:16:34 2016 GMT
    Not After : Jan 24 13:16:34 2026 GMT
  Subject: C=US, ST=California, L=Irvine, O=Lantronix, CN=SLC
  Subject Public Key Info:
    Public Key Algorithm: rsaEncryption
    Public-Key: (2048 bit)
    Modulus:
      00:c1:05:fa:da:9a:06:9c:8e:c7:6a:cc:44:48:2a:
  
```

Reset to Default Certificate: **Note:** changing the SSL Certificate requires a reboot or restarting the web server for the update to take effect.

Import SSL Certificate: Generate custom self-signed SSL Certificate:

Import via: **HTTPS**

Number of Bits: **2048**

Number of Days:

Country Name:

State or Province Name:

Locality Name:

Organization Name:

Organization Unit Name:

Hostname or Common Name:

Email Address:

Optional Challenge Password:

Retype Password:

Certificate Filename: [Upload File >](#)
 Key Filename: [Upload File >](#)
 Passphrase:
 Retype Passphrase:
 Host:
 Login:
 Path:
 Password:
 Retype Password:

[Back to Web Server](#)

2. If desired, enter the following:

Reset to Default Certificate	To reset to the default certificate, select the checkbox to reset to the default certificate. Unselected by default.
-------------------------------------	--

Import SSL Certificate	To import your own SSL Certificate, select the checkbox. Unselected by default.
Import via	From the drop-down list, select the method of importing the certificate (SCP , SFTP , or HTTPS). The default is HTTPS .
Certificate Filename	Filename of the certificate. If HTTPS is selected as the method for import, the Upload File link will be selectable to upload a certificate file.
Key Filename	Filename of the private key for the certificate. If HTTPS is selected as the method for import, the Upload File link will be selectable to upload a key file.
Passphrase / Retype Passphrase	Enter the passphrase associated with the SSL certificate if the private key is encrypted.
Host	Host name or IPAddress of the host from which to import the file.
Path	Path of the directory where the certificate will be stored.
Login	User ID to use to SCP or SFTP the file.
Password / Retype Password	Password to use to SCP or SFTP the file.
Generate custom self-signed SSL Certificate	To generate your own custom self-signed certificate with attributes specific to your site, select the checkbox. The SHA256 hashing algorithm will be used to generate the certificate. Unselected by default.
Number of Bits	The number of bits to use when generating the certificate: 2048, 3072 or 4096.
Number of Days	The number of days that the certificate can be used before it expires, up to 7500 days.
Country Name	The two letter country code for the custom certificate, e.g. "US" or "FR".
State or Province Name	The state or province for the custom certificate, e.g. "California". Must be at least 2 characters long.
Locality Name	The locality or city for the custom certificate, e.g. "Irvine". Must be at least 2 characters long.
Organization Name	The organization or company name for the custom certificate, e.g. "Lantronix". Must be at least 2 characters long.
Organization Unit Name	The unit name for the custom certificate, e.g. "Engineering" or "Sales". Must be at least 2 characters long.
Hostname or Common Name	The hostname or other name associated with the SLC the certificate is generated on, e.g., "slc100.engineering.lantronix.com". Must be at least 2 characters long.
Email Address	An optional email address to associate with the custom certificate.
Optional Challenge Password & Retype Password	An optional password use to encrypt the custom certificate.

3. Click the **Apply** button.

Note: You must reboot the SLC advanced console manager for the update to take effect.

4. To return to the [Services > Web Server](#) page, click the **Back to Web Server** link.

iGoogle Gadgets

You can create iGoogle gadgets that enables you to view the status of the ports of multiple SLC 8000 advanced console managers on one web page.

Anyone with a Google email account (gmail.com) can create an iGoogle gadget for viewing web pages. There are two types of iGoogle gadgets: public gadgets and private gadgets. The public gadgets are listed for import on iGoogle web pages. The SLC gadget is a private gadget, whose location is not publicly advertised.

To set up an SLC iGoogle gadget:

1. Load the following XML code on a web server that is accessible over the Internet. This code describes how to retrieve information and how to format the data for display.

```
<?xml version="1.0" encoding="UTF-8" ?>
- <Module>
  <ModulePrefs title="__UP_model__ Devport Status"
    title_url="http://www.lantronix.com"
    directory_title="SLC/ Status" description="Devport
      status and counters" scrolling="true" width="400"
      height="360" />
  <UserPref name="model" display_name="Model" datatype="enum"
    default_value="slc">
    <EnumValue value="SLC" display_value="SLC" />
    <EnumValue value="SLC" display_value="SLC" />
  </UserPref>
  <UserPref name="ip" display_name="IP Address" required="true" />
- <UserPref name="rate" display_name="Refresh Rate"
  datatype="enum" default_value="10">
  <EnumValue value="1" display_value="1 second" />
  <EnumValue value="5" display_value="5 seconds" />
  <EnumValue value="10" display_value="10 seconds" />
  <EnumValue value="30" display_value="30 seconds" />
  <EnumValue value="60" display_value="1 minute" />
  <EnumValue value="300" display_value="5 minutes" />
  <EnumValue value="600" display_value="10 minutes" />
  /UserPref>
  <Content type="url" href="http://__UP_ip__/devstatus.htm" />
</Module>
```

2. On the iGoogle web page, click the **Add stuff** link.
3. On the new page, click the **Add feed or gadget** link.
4. In the field that displays, type the URL of the gadget location.
5. Return to the gadget viewing page and complete the SLC gadget configuration fields. You should see an iGoogle gadget similar to the following:

Figure 7-14 iGoogle Gadget Example

The screenshot shows an iGoogle interface. At the top, there is the iGoogle logo, a search bar, and buttons for 'Google Search' and 'I'm Feeling Lucky'. To the right of the search bar are links for 'Advanced Search', 'Search Preferences', and 'Language Tools'. Below the search bar, there is a navigation bar with 'Home', 'Lantronix' (selected), and 'Add a tab'. The main content area features a gadget titled 'Lantronix SLC Device Port Status' with a green header. The gadget displays the host/model '10.0.0.203/SLB1684' and a table of port status information.

No	Name	DSR	Bytes Input/Output	Errors	Connection Status
1	Port-1	No	0/0	0	Idle
2	Port-2	No	0/0	0	Idle
3	Port-3	Yes	0/0	0	Idle
4	Port-4	Yes	0/0	0	Idle
5	Port-5	No	0/0	0	Idle
6	Port-6	No	0/0	0	Idle
7	Port-7	No	0/0	0	Idle
8	Port-8	No	0/0	0	Idle

8: Device Ports

This chapter describes how to configure and use an SLC advanced console manager port connected to an external device, such as a server or a modem. The subsequent chapter, [Chapter 11: Connections](#) describes how to use the [Devices > Connections](#) web page to connect external devices and outbound network connections (such as Telnet or SSH) in various configurations. The [Devices > Console Port](#) page allows you to configure the console port, if desired.

Connection Methods

A user can connect to a device port in one of the following ways:

1. Telnet or SSH to the Eth1 or Eth2 IP address, or connect to the console port, and log in to the command line interface. At the command line interface, issue the connect direct or connect listen commands.
2. If Telnet is enabled for a device port, Telnet to `<Eth1 IP address>:<telnet port number>` or `<Eth2 IP address>:<telnet port number>`, where telnet port number is uniquely assigned for each device port.
3. If SSH is enabled for a device port, SSH to `<Eth1 IP address>:<ssh port number>` or `<Eth2 IP address>:<ssh port number>`, where ssh port number is uniquely assigned for each device port.
4. If TCP is enabled for a device port, establish a raw TCP connection to `<Eth1 IP address>:<tcp port number>` or `<Eth2 IP address>:<tcp port number>`, where tcp port number is uniquely assigned for each device port.
5. If a device port has an IP address assigned to it, you can Telnet, SSH, or establish a raw TCP connection to the IP address. For Telnet and SSH, use the default TCP port number (23 and 22, respectively) to connect to the device port. For raw TCP, use the TCP port number defined for TCP In to the device port according to the [Device Ports - Settings \(on page 123\)](#) section.
6. Connect a terminal or a terminal emulation program directly to the device port. If logins are enabled, the user is prompted for a username/password and logs in to the command line interface.

For #2, #3, #4, #5, and #6, if logins or authentication are not enabled, the user is directly connected to the device port with no authentication.

For #1 and #6, if logins are enabled, the user is authenticated first, and then logged into the command line interface. The user login determines permissions for accessing device ports.

Permissions

There are three types of permissions:

1. **Direct (or data) mode:** The user can interact with and monitor the device port (connect direct command).
2. **Listen mode:** The user can only monitor the device port (connect listen command).
3. **Clear mode:** The user can clear the contents of the device port buffer (set locallog <port> clear buffer command).

The administrator and users with local user rights may assign individual port permissions to local users. The administrator and users with remote authentication rights assign port access to users authenticated by NIS, RADIUS, LDAP, Kerberos and TACACS+.

I/O Modules

The SLC module port configuration can be changed by adding or replacing I/O modules in the I/O module bays. Any changes to the I/O modules must be done while the SLC unit is powered off. The following I/O module configurations are supported (Bay 1 is the leftmost bay when viewing the back of the SLC 8000 advanced console manager where the device ports are located):

Table 8-1 Supported I/O Module Configurations

Model	Bay 1	Bay 2	Bay 3
SLC 8008	8-port module	Empty	Empty
SLC 8016	16-port module	Empty	Empty
SLC 8024	8-port module	16-port module	Empty
SLC 8032	16-port module	16-port module	Empty
SLC 8040	8-port module	16-port module	16-port module
SLC 8048	16-port module	16-port module	16-port module

Note: A 16-port RJ45 module is shown as "RJ45-16" in the About page in the Web interface and the output of the `admin version` command in the CLI, and a 8-port module is shown as "RJ45-08". A 16-port USB module is shown as "USB-16." For example, I/O Module Type(s): RJ45-08, RJ45-16, and RJ45-16 indicate that the SLC unit has an 8-port I/O module in Bay 1, and 16-port modules in Bay 2 and 3. Please note that only the following configurations are available from Lantronix: SLC 8008, SLC 8016, SLC 8032 and SLC 8048 modules. The SLC 8024 and SLC 8040 console managers can only be created by adding 16-port RJ45 modules to an existing SLC 8008 unit.

The number of device ports in a SLC 8000 advanced console manager can be expanded by adding 16-port I/O modules in Bay 2 and Bay 3, or by swapping an 8-port I/O module in Bay 1 for a 16-port module. The configurations listed above are the only valid configurations; if any other configuration is detected at boot, the SLC unit will still boot, disable use of the device ports, and provide indications in the boot messages, in the CLI and in the web that the I/O configuration is invalid. When an invalid configuration is corrected by reconfiguring the I/O modules into a valid configuration, after the SLC module is powered up and booted, the valid configuration will be detected and the SLC module ports can be used again.

For the SLC 8024 and SLC 8040 modules, with an 8-port I/O module in Bay 1, the device ports will be numbered 1-8 and 17-32 (for the SLC 8024 model) and 1-8 and 17-48 (for the SLC 8040 model). See [Figure 8-2 Devices > Device Status on page 120](#).

Restoring a configuration to the SLC 8000 advanced console manager will automatically adjust the number of device ports to reflect the number of ports in the SLC unit the configuration is being restored to. For example, a configuration that is saved on an SLC 8048 unit and restored to an SLC 8016 unit will have the last 32 ports removed from the configuration. Conversely, a configuration that is saved on a SLC 8016 unit and restored to a SLC 8048 unit will have 32 device ports (with factory default settings) added to the configuration.

Device Status

The [Devices > Device Status](#) page displays the status of the SLC ports, USB ports and SD card ports.

1. Click the **Devices** tab and select the **Device Status** option. The following page displays:

Figure 8-2 Devices > Device Status

The screenshot shows the LANTRONIX SLC 8048 web interface. At the top, there is a navigation menu with tabs for Network, Services, User Authentication, Devices, Maintenance, and Quick Setup. The 'Devices' tab is selected, and the 'Device Status' sub-tab is active. The page displays the following information:

Host: slc4331
User: sysadmin

Select port for: Configuration WebSSH (DP only) Connected Device (DP only)

Console Port: **Connected**

Device Port Status and Counters					
No	Name	DSR	Bytes Input/Output	Errors	Connection Status
1	Port-1	Yes	32/0	0	Idle
2	Port-2	Yes	0/32	0	Command Line Interface
3	Port-3	Yes	0/0	0	Idle
4	Port-4	Yes	0/0	0	Idle
5	Port-5	Yes	0/0	0	Idle
6	Port-6	Yes	0/0	0	Idle
7	Port-7	No	0/4	0	Idle
8	Port-8	No	0/0	0	Idle
9	Port-9	No	0/0	0	Idle
10	Port-10	No	0/0	0	Idle
11	Port-11	No	0/0	0	Idle
12	Port-12	No	0/0	0	Idle
13	Port-13	No	0/0	0	Idle
14	Port-14	No	0/0	0	Idle
15	Port-15	No	0/0	0	Idle
16	Port-16	No	0/0	0	Idle
17	Port-17	No	0/0	0	Idle
18	Port-18	No	0/0	0	Idle
19	Port-19	No	0/0	0	Idle
20	Port-20	No	0/0	0	Idle
21	Port-21	No	0/0	0	Idle
22	Port-22	No	0/0	0	Idle
23	Port-23	No	0/0	0	Idle
24	Port-24	No	0/0	0	Idle
25	Port-25	No	0/0	0	Idle
26	Port-26	No	0/0	0	Idle
27	Port-27	No	0/0	0	Idle
28	Port-28	No	0/0	0	Idle
29	Port-29	No	0/0	0	Idle
30	Port-30	No	0/0	0	Idle
31	Port-31	Yes	0/0	0	Idle
32	Port-32	No	0/0	0	Idle
33	Port-33	No	0/0	0	Idle
34	Port-34	No	0/0	0	Idle
35	Port-35	No	0/0	0	Idle
36	Port-36	No	0/0	0	Idle
37	Port-37	No	0/0	0	Idle
38	Port-38	No	0/0	0	Idle
39	Port-39	No	0/0	0	Idle
40	Port-40	No	0/0	0	Idle
41	Port-41	No	0/0	0	Idle
42	Port-42	No	0/0	0	Idle
43	Port-43	No	0/0	0	Idle
44	Port-44	No	0/0	0	Idle
45	Port-45	No	0/0	0	Idle
46	Port-46	No	0/0	0	Idle
47	Port-47	No	0/0	0	Idle
48	Port-48	No	0/0	0	Idle

USB Ports / SD Card			
Port	Device	Type	State
U1	none	N/A	N/A
U2	none	N/A	N/A
SD Card	none	N/A	N/A

Device Ports

On the [Devices > Device Ports](#) page, you can set up the numbering of Telnet, SSH, and TCP ports, view a summary of current port modes, establish the maximum number of direct connections for each device port, and select individual ports to configure.

1. Click the **Devices** tab and select the **Device Ports** option. The following page displays:

Figure 8-3 Devices > Device Ports

The screenshot shows the LANTRONIX SLC 8048 web interface. At the top, there is a navigation menu with tabs for Network, Services, User Authentication, Devices, Maintenance, and Quick Setup. Below the menu, there are links for Device Status, Device Ports, Console Port, USB / SD Card, RPMs, Connections, Host Lists, Scripts, and Sites. The main content area is titled 'Device Ports' and contains a 'Telnet/SSH/TCP In Port Numbers' section with input fields for 'Starting Telnet Port: 2001', 'Starting SSH Port: 3001', and 'Starting TCP Port: 4001', along with an 'Apply' button. To the right is a table of 16 ports, each with a 'No', 'Name', 'Mode', and 'Select' column. The 'Mode' column shows 'Idle' for all ports, and the 'Select' column has radio buttons.

No	Name	Mode	Select
1	Port-1	Idle	<input type="radio"/>
2	Port-2	Idle	<input type="radio"/>
3	Port-3	Idle	<input type="radio"/>
4	Port-4	Idle	<input type="radio"/>
5	Port-5	Idle	<input type="radio"/>
6	Port-6	Idle	<input type="radio"/>
7	Port-7	Idle	<input type="radio"/>
8	Port-8	Idle	<input type="radio"/>
9	Port-9	Idle	<input type="radio"/>
10	Port-10	Idle	<input type="radio"/>
11	Port-11	Idle	<input type="radio"/>
12	Port-12	Idle	<input type="radio"/>
13	Port-13	Idle	<input type="radio"/>
14	Port-14	Idle	<input type="radio"/>
15	Port-15	Idle	<input type="radio"/>
16	Port-16	Idle	<input type="radio"/>

Current port numbering schemes for Telnet, SSH, and TCP ports display on the left. The list of ports 1-16 on the right includes the individual ports and their current mode.

Note: For units with more ports, click the buttons above the table to view additional ports.

Icons that represent some of the possible modes include:

	The port is not in use.
	The port is in data/text mode. Note: You may set up ports to allow Telnet access using the IP Setting per Device Ports - Settings (on page 123) .
	An external modem is connected to the port. The user may dial into or out of the port.
	Telnet in or SSH in is enabled for the device port. The device port is either waiting for a Telnet or SSH login or has received a Telnet or SSH login (a user has logged in).

To set up Telnet, SSH, and TCP port numbering:

1. Enter the following:

Telnet/SSH/TCP in Port Numbers

Starting Telnet Port	Each port is assigned a number for connecting via Telnet. Enter a number (1025-65528) that represents the first port. The default is 2000 plus the port number. For example, if you enter 2001, port 1 will be 2001 and subsequent 2000 ports are automatically assigned numbers 2001, 2002, and so on.
Starting SSH Port	Each port is assigned a number for connecting via SSH. Enter a number (1025-65528) that represents the first port. The default is 3000 plus the port number. For example, if you enter 3001, port 1 will be 3001 and subsequent 3000 ports are automatically assigned numbers 3001, 3002, and so on.
Starting TCP Port	Each port is assigned a number for connecting through a raw TCP connection. Enter a number (1025-65528) that represents the first port. The default is 4000 plus the port number. For example, if you enter 4001, port 1 will be 4001 and subsequent 4000 ports are automatically assigned numbers 4001, 4002, and so on. You can use a raw TCP connection in situations where a TCP/IP connection is to communicate with a serial device. For example, you can connect a serial printer to a device port and use a raw TCP connection to send print jobs to the printer over the network. Note: When using raw TCP connections to transmit binary data, or where the break command (escape sequence) is not required, set the Break Sequence of the respective device port to null (clear it).

Caution: Ports 1-1024 are RFC-assigned and may conflict with services running on the SLC 8000 advanced console manager. Avoid this range.

2. Click the **Apply** button to save the settings.

To set limits on direct connections:

1. Enter the maximum number (1-10) of simultaneous direct connections for each device port. The default is 1.
2. Click the **Apply** button to save the settings.

To configure a specific port:

1. You have two options:
 - Select the port from the ports list and click the **Configure** button. The [Device Ports > Settings](#) page for the port displays.
 - Click the port number on the green bar at the top of each page.
2. Continue with directions in the section, [Device Ports - Settings \(on page 123\)](#).

Global Commands

The following CLI commands correspond to the web page entries described above.

To configure settings for all or a group of device ports:

```
set deviceport global <one or more parameters>
```

Parameters

```
sshport <TCP Port>
tcpport <TCP Port>
telnetport <TCP Port>
```

Port is a port number between 1025 and 65528.

To view global settings for device ports:

```
show deviceport global
```

Device Ports - Settings

On the [Device Ports > Settings](#) page, configure IP and data (serial) settings for individual ports, and if the port connects to an external modem, modem settings as well.

To open the Device Ports - Settings page:

1. You have two options:

- **Dashboard**

Make sure the **Configuration** radio button directly beneath the [Dashboard](#) is selected and click the desired port number in the [Dashboard](#). The Dashboard is located on the upper right corner of each Web Manager page (see [Chapter 5: Web Page Layout](#).)



- **Device Ports Page**

Click the Devices tab, then click the Device Ports link. Select the port you want to configure and then click the Configure button. Higher numbered ports can be displayed using the "1-16", "17-32" and "33-48" buttons at the top of the Device Port list.

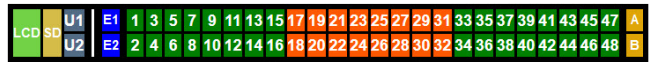

Logout

Host: slc4331
User: sysadmin

Select port for Configuration WebSSH (DP only) Connected Device (DP only)

Network Services User Authentication **Devices** Maintenance Quick Setup



Device Status Device Ports Console Port USB / SD Card RPMs Connections Host Lists Scripts Sites

Device Ports

Help?

Telnet/SSH/TCP In Port Numbers

Renumber the Telnet In, SSH In or TCP In Port Number for all Device Ports.

Starting Telnet Port:

Starting SSH Port:

Starting TCP Port:

Apply

Ports:			
No	Name	Mode	Select
1	Port-1	Idle	<input type="radio"/>
2	Port-2	Idle	<input type="radio"/>
3	Port-3	Idle	<input type="radio"/>
4	Port-4	Idle	<input type="radio"/>
5	Port-5	Idle	<input type="radio"/>
6	Port-6	Idle	<input type="radio"/>
7	Port-7	Idle	<input type="radio"/>
8	Port-8	Idle	<input type="radio"/>
9	Port-9	Idle	<input type="radio"/>
10	Port-10	Idle	<input type="radio"/>
11	Port-11	Idle	<input type="radio"/>
12	Port-12	Idle	<input type="radio"/>
13	Port-13	Idle	<input type="radio"/>
14	Port-14	Idle	<input type="radio"/>
15	Port-15	Idle	<input type="radio"/>
16	Port-16	Idle	<input type="radio"/>

The following page displays:

Figure 8-4 Device Ports > Settings

LANTRONIX[®] SLC 8048

Host: slc4331
User: sysadmin

Select port for: Configuration WebSSH (DP only) Connected Device (DP only)

Logout

Network Services User Authentication Devices Maintenance Quick Setup

Device Status Device Ports Console Port USB / SD Card RPMs Connections Host Lists Scripts Sites

Device Ports - Settings Help ?

Port: 7
Mode: Idle
Name: Port-7
Group Access:
Banner:
of Sessions Msg:
Idle Timeout Msg:
Connected Msg:
Minimize Latency:
Break Sequence:
Note: remove Break Sequence for Device Ports connected to raw binary connections.
View Port Log Seq:
View Port Log:
Zero Port Counters:

Logging & Events: [Settings >](#)
Power Management: [Settings >](#)
Connected to: undefined

IP Settings

Telnet In: Port: 2007 Authentication:
Telnet Timeout: Seconds: 600 Data Direction: Both Directions
Telnet Soft IAC Mode:
SSH In: Port: 3007 Authentication:
SSH Timeout: Seconds: 600 Data Direction: Both Directions
TCP In: Port: 4007 Authentication:
TCP Timeout: Seconds: 600 Data Direction: Incoming Network
IP Address/Netmask Bits:
Send Term String: Term String:
Web SSH/Telnet Columns: 80 Rows: 24

Data Settings

Baud: 9600
Data Bits: 8
Stop Bits: 1
Parity: none
Flow Control: none
Enable Logins:
Max Direct Connects: 1
Show Lines On Connecting: No
 Yes, # of lines: 24

Hardware Signals

Check DSR on Connect:
Disconnect on DSR:
Assert DTR:
Toggle DTR:
Reverse Pinout:
USB VBUS:

Port Status and Counters	
DSR/CD	No
DTR	Yes
CTS	No
RTS	Yes
Bytes input	0
Bytes output	0
Framing errors	0
Parity errors	0
Overrun errors	0
Flow Control errors	0
Seconds since zeroed	31169

Modem Settings [View Modem Log >](#)

State: Disabled
Mode: Text PPP
Use Sites:
Initialization Script:
Modem Timeout: No Yes, seconds (1-9999):
Caller ID Logging: Modem Command:
Dial-back Number: Local User Number
 Fixed Number:
Dial-back Delay: 15 seconds
Dial-back Retries: 3

Text Mode

Timeout Logins: No Yes, minutes (1-30):
Dial-in Host List: undefined [Host Lists >](#)

PPP Mode

Negotiate IP Address: Yes No Local IP:
 Remote IP:
Authentication: PAP CHAP
Host/User Name:
CHAP Handshake: Secret/User Password:
Retype Password:
CHAP Auth Uses: CHAP Host Local Users
Same authentication for Dial-in & Dial-on-Demand (DOD):
DOD Authentication: PAP CHAP
Host/User Name:
DOD CHAP Handshake: Secret/User Password:
Retype Password:
Enable NAT: Note: Enabling NAT requires IP Forwarding to be enabled.
Dial-out Number:
Remote/Dial-out Login:
Remote/Dial-out Password: Retype:
Restart Delay: 30 seconds
CBCP Server
Allow No Callback:
CBCP Client Type: Admin-defined Number User-defined Number

[Back to Device Ports](#) Apply Settings: none to Device Ports:
Note: In addition to applying settings to the currently selected Device Port, all or some of the settings can also be applied to other Device Ports.

2. Enter the following:

Device Port Settings

Port	Displays number of port; displays automatically.
Mode	The status of the port; displays automatically.
USB Device	This field is only displayed for USB ports. If a USB device is connected to the device port, this displays the USB version, speed, and a short type description for the USB device. The SLC supports up to 48 USB type A (Host) devices at data rates of HS (480 Mbit/s), FS (12 Mbit/s) or LS (1.5 Mbit/s). Each port has VBUS 5V support of up to 100mA (but not too exceed 600mA total per 16-port USB I/O module). Drawing more than 150 mA on a USB device port will shut down the VBUS 5V. USB ports are designed for data traffic only, and are not designed for charging or powering devices. Overcurrent conditions may disrupt operations.
Name	The name of the port. Valid characters are letters, numbers, dashes (-), periods, and underscores (_).
Group Access	If undefined, any group can access the device port. If one or more groups are specified (groups are delimited by the characters ' ' (space), ',' (comma), or ';' (semicolon)), then any user who logs into the device port must be a member of one of the specified groups, otherwise access will be denied. Users authenticated via RADIUS may have a group (or groups) provided by the RADIUS server via the Filter-Id attribute that overrides the group defined for a user on the SLC unit. A group provided by a remote server must be either a single group or multiple groups delimited by the characters ' ' (space), ',' (comma), ';' (semicolon), or '=' (equals) - for example "group=group1,group2;" or "group1,group2,group3".
Banner	Text to display when a user connects to a device port by means of Telnet, SSH, or TCP. If authentication is enabled for the device port, the banner displays once the user successfully logs in. Blank is the default.
# of Sessions Msg	If enabled, a message will be displayed to a user when connecting to a device port that indicates how many users are currently connected to the device port. Disabled by default.
Idle Timeout Msg	If enabled, a message will be displayed to a user when their connection to a device port will be terminated soon due to the connection being idle. Disabled by default. <i>Note: When the Idle Timeout Msg is enabled, the terminal application timeout values for Telnet, SSH and TCP should be set to a value greater than 15 seconds.</i>
Connected Msg	If enabled, a message will be displayed to a user when they initially connect to a device port. Enabled by default.
Minimize Latency	Minimize device port latency by reducing read delays. This may improve communication efficiency in scenarios where a series of short messages are exchanged, but may increase CPU utilization and decrease throughput in cases where large messages are transmitted. Disabled by default.
Break Sequence	A series of one to ten characters users can enter on the command line interface to send a break signal to the external device. A suggested value is Esc+B (escape key, then uppercase "B" performed quickly but not simultaneously). You would specify this value as x1bB , which is hexadecimal (x) character 27 (1B) followed by a B . See Key Sequences on page 183 for notes on key sequence precedence and behavior.

View Port Log Seq	The key sequence used to view the Port Log while in Connect Direct mode. Non-printing characters can be specified by giving their hexadecimal code (see Break Sequence above). The default is Esc+V (x1bV). See Key Sequences on page 183 for notes on key sequence precedence and behavior.
View Port Log	Select to allow the user to enter the View Port Log Sequence to view the Port Log during Connect Direct mode. The default is disabled.
Zero Port Counters	Resets all of the numerical values in the Port Counters table at the bottom of the page to zero (0).
Logging & Events	Click the Settings link to configure file logging (see Device Ports - Logging and Events on page 142), email logging, local logging, and USB logging.
Power Management	Click the Settings link to configure power supplies for the device connected to this device port on the Device Ports - Power Management page.
Connected to	The type of device connected to the device port. Currently, the SLC unit supports Remote Power Managers (PDUs and UPSes) from 140+ vendors, as well as Sensorsoft devices. If the connected device is an RPM, the user can assign an RPM to the device port by either select an existing RPM (via the Select dropdown) or clicking the Add RPM link to configure a new RPM for the SLC. If an RPM is already assigned to the device port, the user can click on the Selected RPM link to view status and configuration for the RPM. If the connected device is a Sensorsoft device, the user can click on Device Commands to manage the Sensorsoft device. If the type of device connected to the device port is not listed, select Undefined . <i>Note: Sensorsoft temperature/humidity devices are supported with USB-to-serial adapters (ftdi/pl2303/cp210x) but are not supported for use with USB-to-Serial CDC_ACM devices.</i>

IP Settings

Telnet In	Enables access to this port through Telnet. Disabled by default.
SSH In	Enables access to this port through SSH. Disabled by default.
TCP in	Enables access to this port through a raw TCP connection. Disabled by default: <i>Note: When using raw TCP connections to transmit binary data, or where the break command (escape sequence) is not required, set the Break Sequence of the respective device port to null (clear it).</i>
Port	Automatically assigned Telnet, SSH, and TCP port numbers. You may override this value, if desired. The value must be unique on the SLC 8000; for example, you cannot have two or more ports numbered 10001.
Authentication	If selected, the SLC unit requires user authentication before granting access to the port. Authenticate is selected by default for Telnet in and SSH in , but not for TCP in .
Telnet/SSH/TCP Timeout	Select the checkbox to cause an idle Telnet, SSH or TCP connection to disconnect after a specified number of seconds as defined in the Seconds field to the right.
Seconds	Enter a value from 1 to 1800 seconds if selecting the Telnet, SSH or TCP Timeout checkbox to the left. The default is 600 seconds. <i>Note: When the Idle Timeout Msg is enabled, the terminal application timeout values for Telnet, SSH and TCP should be set to a value greater than 15 seconds.</i>

Data Direction	If a Telnet, SSH or TCP connection has the idle Timeout enabled, this setting indicates the direction of data use to determine if the connection has timed out: incoming network data, outgoing network data, or data from both directions. The default is Both Directions for Telnet and SSH , and Incoming Network data for TCP .
Telnet Soft IAC Mode	When Telnet Soft IAC mode is enabled, the Telnet server will not block waiting for the initial Telnet protocol IAC option responses. An abbreviated list of IAC options will be sent to the client, including a request for client side Echoing. Disabled by default.
IP Address/Netmask Bits	IP address used for this device port so a user can Telnet, SSH, or establish a raw TCP connection to this address and connect directly to the device port. The optional netmask bits specify the netmask to use for the IP address. For example, for a netmask of 255.255.255.0 specify 24 bits. If the netmask bits are not specified, a default netmask used for the class of network that the IP address falls in will be used. For Telnet and SSH, the default TCP port numbers (22 and 23, respectively) are used to connect to the device port. For raw TCP, the TCP port number defined for TCP In to the device port is used. <i>Note: If Ethernet Bonding is enabled, assigning individual IP Addresses to Device Ports is not supported. Note that the IP address will be bound to Eth1 only, so if Eth2 is connected and configured, and Eth1 is not, this feature will not work.</i>
Send Term String/Term String	If Send Term String is enabled and a Term String is defined, when a network connection to a device port is terminated, the termination string is sent to the device connected to the device port. The string should be defined so that it sends the appropriate command(s) to the device to terminate any active user sessions, e.g. "logout" or "exit". The string may contain multiple commands separated by a newline ("\n") character. This is a security mechanism used to close sessions that are inadvertently left open by users.

Data Settings

Note: Check the serial device's equipment settings and documentation for the proper settings. The device port and the attached serial device must have the same settings.

Baud	The speed with which the device port exchanges data with the attached serial device. From the drop-down list, select the baud rate. Most devices use 9600 for the administration port, so the device port defaults to this value. Check the equipment settings and documentation for the proper baud rate.
Data Bits	Number of data bits used to transmit a character. From the drop-down list, select the number of data bits. The default is 8 data bits.
Stop Bits	The number of stop bit(s) used to indicate that a byte of data has been transmitted. From the drop-down list, select the number of stop bits. The default is 1.
Parity	Parity checking is a rudimentary method of detecting simple, single-bit errors. From the drop-down list, select the parity. The default is none .
Flow Control	A method of preventing buffer overflow and loss of data. The available methods include none , xon/xoff (software), and rts/cts (hardware). The default is none .

Enable Logins	<p>For serial devices connected to the device port, displays a login prompt and authenticates users. Successfully authenticated users are logged into the command line interface.</p> <p>The default is disabled. This is the correct setting if the device port is the endpoint for a network connection.</p>
Max Direct Connects	<p>Enter the maximum number (1-15) of simultaneous connections for the device port. The default is 1.</p>
Show Lines on Connecting	<p>If enabled, when the user either does a <code>connect direct</code> from the CLI or connects directly to the port using Telnet or SSH, the SLC outputs up to 24 lines of buffered data as soon as the serial port is connected.</p> <p>For example, an SLC user issues a <code>connect direct device 1</code> command to connect port 1 to a Linux server.</p> <p>For example, if the SLC user issues the <code>ls</code> command to display a directory on a Linux server, then exits the connection, the results of the <code>ls</code> will be stored in the buffer. When the SLC user then issues another <code>direct connect device 1</code>, the last 24 lines of the <code>ls</code> command is displayed so the user can see what state the server was left in.</p>

Hardware Signal Triggers

Check DSR on Connect	<p>If this setting is enabled, the device port only establishes a connection if DSR (Data Set Ready) is in an asserted state. DSR should already be in an asserted state, not transitioning to, when a connection attempt is made. Disabled by default unless dial-in, dial-out, or dial-back is enabled for the device port.</p> <p><i>Note: Applies to serial RJ45 device ports only.</i></p>
Disconnect on DSR	<p>If a connection to a device port is currently in session, and the DSR signal transitions to a de-asserted state, the connection disconnects immediately. Disabled is the default unless dial-in, dial-out, or dial-back is enabled for the device port.</p> <p><i>Note: Applies to serial RJ45 device ports only.</i></p>
Assert DTR	<p>By default, DTR is asserted on a device port nearly all of the time (except momentarily when a port is opened for operations). Unchecking this option will deassert DTR, simulating a cable disconnection for the device that is connected to a device port.</p> <p><i>Note: Applies to serial RJ45 device ports only.</i></p>
Toggle DTR	<p>Applies to RJ45 device ports only. If enabled, when a user disconnects from a device port, DTR will be toggled. This feature can be used when a serial connection requires DSR to be active for the attached device to connect. In this case, toggling DTR will end any active connection on the device.</p>
Reverse Pinout	<p>If enabled, swaps the positions of the serial lines, such that the direction of data or the signal is reversed. For instance, TX is swapped with RX. Enabling Reverse Pinout facilitates connections to Cisco and Sun style RS-45 console ports using a straight through Ethernet patch cable, without the need for a rolled cable or adapter. Enabled by default.</p> <p><i>Note: Applies to serial RJ45 device ports only. All Lantronix serial adapters are intended to be used with Reverse Pinout disabled. If you are replacing an original SLC unit with an SLC 8000 advanced console manager, disable the reverse pinout so you can use the original cables and adapters.</i></p>

USB VBUS	<p>For USB Device Ports only. If enabled, the USB VBUS signal provides power to the USB device attached to a device port. Disabling VBUS will power down the device as long as it is bus-powered instead of self-powered. The VBUS 5V signal is up to 100 mA per port, but not to exceed 600mA total per USB I/O Module. Drawing more than 150 mA on a USB port will shut down the VBUS 5V.</p> <p>Caution: <i>USB ports are designed for data traffic only. They are not designed for charging or powering devices. Over-current conditions on VBUS 5V may disrupt operations.</i></p>
-----------------	--

Modem Settings (Device Ports)

Note: Depending on the **State** and **Mode** you select, different fields are available.

State	Used if an external modem is attached to the device port. If enabling, set the modem to dial-out, dial-in, dial-back, dial-on-demand, dial-in/host list, dial-back & dial-on-demand, dial in & dial-on-demand, CBCP Server, and CBCP Client. Disabled by default. See Modem Dialing States (on page 178) for more information.
Mode	<p>The format in which the data flows back and forth:</p> <ul style="list-style-type: none"> ◆ Text: In this mode, the SLC advanced console manager assumes that the modem will be used for remotely logging into the command line. Text mode can only be used for dialing in or dialing back. Text is the default. ◆ PPP: This mode establishes an IP-based link over the modem. PPP connections can be used in dial-out mode (e.g., the SLC unit connects to an external network), dial-in mode (e.g., the external computer connects to the network that the SLC 8000 advanced console manager is part of), or dial-on-demand.
Use Sites	Enables the use of site-oriented modem parameters which can be activated by various modem-related events (authentication, outbound network traffic for dial-on-demand connections, etc.). Sites can be used with the following modem states: dial-in, dial-back, dial-on-demand, dial-in & dial-on-demand, dial-back & dial-on-demand, and CBCP server.
Initialization Script	<p>Commands sent to configure the modem may have up to 100 characters. Consult your modem's documentation for recommended initialization options. If you do not specify an initialization script, the SLC unit uses a default initialization string of <code>AT S7=45 SO=0 L1 V1 X4 &D2 &c1 E1 Q0</code>.</p> <p>Note: <i>We recommend that the modem initialization script always be preceded with AT and include E1 V1 x4 Q0 so that the SLC 8000 advanced console manager may properly control the modem. For information on AT commands, refer to the modem user guide, or do a web search for at command set. Serial modems may need to include &B1 in the modem initialization string to set the DTE rate to a fixed baud rate.</i></p>
Modem Timeout	Timeout for all modem connections. Select Yes (default) for the SLC unit to terminate the connection if no traffic is received during the configured idle time. Enter a value of from 1 to 9999 seconds. The default is 30 seconds.
Caller ID Logging	<p>Select to enable the SLC advanced console manager to log caller IDs on incoming calls. Disabled by default.</p> <p>Note: <i>For the Caller ID AT command, refer to the modem user guide.</i></p>
Modem Command	<p>Modem AT command used to initiate caller ID logging by the modem.</p> <p>Note: <i>For the AT command, refer to the modem user guide.</i></p>

Dial-back Number	<p>Users with dial-back access can dial into the SLC device and enter their login and password. Once the SLC 8000 advanced console manager authenticates them, the modem hangs up and dials them back.</p> <p>Select the phone number the modem dials back on –a fixed number or a number associated with their login. If you select Fixed Number, enter the number (in the format 2123456789).</p> <p>The dial-back number is also used for CBCP client as the number for a user-defined number. See Device Ports - Settings (on page 123) for more information.</p>
Dial-back Delay	For dial-back and CBCP Server, the number of seconds between the dial-in and dial-out portions of the dialing sequence.
Dial-back Retries	For dial-back and CBCP Server, the number of times the SLC unit will retry the dial-out portion of the dialing sequence if the first attempt to dial-out fails.

Modem Settings: Text Mode

Timeout Logins	If you selected Text mode, you can enable logins to time out after the connection is inactive for a specified number of minutes. The default is No . This setting is only applicable for text mode connections. PPP mode connections stay connected until either side drops the connection. Disabled by default.
Dial-in Host List	<p>From the drop-down list, select the desired host list. The host list is a prioritized list of SSH, Telnet, and TCP hosts that are available for establishing outgoing modem connections or for connect direct at the CLI. The hosts in the list are cycled through until the SLC 8000 advanced console manager successfully connects to one.</p> <p>To establish and configure host lists, click the Host Lists link.</p>

Modem Settings: PPP Mode

Negotiate IP Address	<p>If the SLC unit and/or the serial device have dynamic IP addresses (e.g., IP addresses assigned by a DHCP server), select Yes. Yes is the default.</p> <p>If the SLC advanced console manager or the modem have fixed IP addresses, select No, and enter the Local IP (IP address of the port) and Remote IP (IP address of the modem).</p>
Authentication	Enables PAP or CHAP authentication for modem logins. PAP is the default. With PAP, users are authenticated by means of the Local Users and any of the remote authentication methods that are enabled. With CHAP, the CHAP Handshake fields authenticate the user.
CHAP Handshake	The Host/User Name (for UNIX systems) or Secret/User Password (for Windows systems) used for CHAP authentication. May have up to 128 characters.
CHAP Auth Uses	For CHAP authentication, determines what is used to validate the CHAP host/user sent by the remote peer: either the CHAP Host defined for the modem, or any of the users in the Local Users list.
Same authentication for Dial-in & Dial-on-Demand (DOD)	Select this option to let incoming connections (dial-in) use the same authentication settings as outgoing connections (dial-on-demand). If this option is not selected, then the dial-on-demand connections take their authentication settings from the DOD parameter settings. If DOD Authentication is PAP , then the DOD CHAP Handshake field is not used.
DOD Authentication	Enables PAP or CHAP authentication for dial-in & dial-on-demand. PAP is the default. With PAP, users are authenticated by means of the Local Users and any of the remote authentication methods that are enabled. With CHAP , the DOD CHAP Handshake fields authenticate the user.

DOD CHAP Handshake	For DOD Authentication , enter the Host/User Name for UNIX systems) or Secret/User Password (for Windows systems) used for CHAP authentication. May have up to 128 characters.
Enable NAT	Select to enable Network Address Translation (NAT) for dial-in and dial-out PPP connections on a per modem (device port or USB port) basis. Users dialing into the SLC 8000 advanced console manager access the network connected to Eth1 and/or Eth2. <i>Note: IP forwarding must be enabled on the Network > Network Settings page for NAT to work. See Chapter 6: Basic Parameters on page 66.</i>
Dial-out Number	Phone number for dialing out to a remote system or serial device. May have up to 20 characters. Any format is acceptable.
Remote/Dial-out Login	User ID for dialing out to a remote system. May have up to 32 characters.
Remote/Dial-out Password	Password for dialing out to a remote system. May have up to 64 characters.
Retype	Re-enter remote/dial-out password for dialing out to a remote system. May have up to 64 characters.
Restart Delay	The number of seconds after the timeout and before the SLC unit attempts another connection. The default is 30 seconds.
CBCP Server Allow No Callback	For CBCP Server state, allows "No Callback" as an option in the CBCP handshake in addition to User-defined Number and Admin-defined Number.
CBCP Client Type	For CBCP Client, this selects the number that the client would like to use for callback - either a user-defined number passed to the server (specified by the Fixed Dial-back Number) or an administrator-defined number determined by the server based on the login that is PAP or CHAP authenticated.

3. To save settings for just this port, click the **Apply** button.
4. To save selected settings to ports other than the one you are configuring:
 - From the **Apply Settings** drop-down box, select none, a group of settings, or All.
 - In to **Device Ports**, type the device port numbers, separated by commas; indicate a range of port numbers with a hyphen (e.g., 2, 5, 7-10).

Note: *It may take a few minutes for the system to apply the settings to multiple ports.*

Port Status and Counters

Port Counters describe the status of signals and interfaces. SLC advanced console manager updates and increments the port counters as signals change and data flows in and out of the system. These counters help troubleshoot connections or diagnose problems because they give the user an overview of the state of various parameters. By setting them to zero and then re-checking them later, the user can view changes in status.

The chart in the middle of the page displays the flow control lines and port statistics for the device port. The system automatically updates these values. To reset them to zeros, select the **Zero** port counters checkbox in the IP Settings section of the page.

Note: Status and statistics shown on the web interface represent a snapshot in time. To see the most recent data, you must reload the web page. Status may display "N/A" if SLC is unable to dynamically determine the connected/inserted device.

Table 8-5 Port Status and Counters

Port Status and Counters	
DSR/CD	No
DTR	Yes
CTS	No
RTS	Yes
Bytes input	0
Bytes output	0
Framing errors	0
Parity errors	0
Overrun errors	0
Flow Control errors	0
Seconds since zeroed	106734

Device Ports - Power Management

In the Device Ports - Power Management page, configure power supplies that provide power to the device or server connected to the device port. Up to 4 power supplies can be configured, by selecting an RPM, an outlet on the RPM, and defining a unique name for the RPM/outlet pair. The RPM outlet pair can also be controlled (power cycled, turned on, turned off).

This page also allows the user to define the Power Management Sequence, which, when entered while the user is connected to a device port via the connect direct command, will display the Power Management menu:

```
-----
Power Management Menu
-----
```

```
RPM/outlet>>> trippOUT4          sentry3OUT15
A. Status      D. Turn On      G. Turn On
B. Help        E. Turn Off    H. Turn Off
C. Quit        F. Power Cycle I. Power Cycle
```

This menu allows the administrator to query status and control any of the power supplies that provide power to the device connected to the device port.

To configure power management settings for a device port:

1. Connect to a specific port on the **Devices > Device Ports** page according to instructions in [To open the Device Ports - Settings page: \(on page 123\)](#).
2. Click the **Settings** link beside **Power Management** to access the [Device Ports - Power Management](#) page.

Figure 8-6 Device Ports - Power Management

LANTRONIX[®] SLC 8048

Logout Host: slc4331 User: sysadmin

Select port for Configuration WebSSH (DP only) Connected Device (DP only)

Network Services User Authentication Devices Maintenance Quick Setup

Device Status Device Ports Console Port USB / SD Card Internal Modem RPMs Connections Host Lists Scripts Sites

Device Ports - Power Management Help?

Port: 5
Name: Port-5

Power Management Sequence:

Select up to 4 RPM outlets which provide power for the device connected to this device port. Typing the Power Management Sequence while connected to a device port will display a menu for controlling each of the power supplies.

Managed Power Supplies		RPM Outlets: SLP16snmp
#1	RPM: SLP16snmp Outlet: <input type="text"/> Name: <input type="text"/> State: <input type="text"/> Action: None	1 TowerA_Outlet1 2 TowerA_Outlet2 3 TowerA_Outlet3 4 TowerA_Outlet4 5 TowerA_Outlet5 6 TowerA_Outlet6 7 TowerA_Outlet7 8 TowerA_Outlet8 9 TowerA_Outlet9 10 TowerA_Outlet10 11 TowerA_Outlet11 12 TowerA_Outlet12 13 TowerA_Outlet13 14 TowerA_Outlet14 15 TowerA_Outlet15 16 TowerA_Outlet16
#2	RPM: select RPM Outlet: <input type="text"/> Name: <input type="text"/> State: <input type="text"/> Action: None	
#3	RPM: select RPM Outlet: <input type="text"/> Name: <input type="text"/> State: <input type="text"/> Action: None	
#4	RPM: select RPM Outlet: <input type="text"/> Name: <input type="text"/> State: <input type="text"/> Action: None	

[Back to Device Port Settings](#)

3. Enter the following:

Power Management Sequence	A series of one to ten characters that will display the Power Management menu when connected to the device port. The default value is Esc+P (escape key, then uppercase "P"). This value is specified as <code>\x1bP</code> , which is hexadecimal (<code>\x</code>) character 27 (1B) followed by a P. See Key Sequences on page 183 for notes on key sequence precedence and behavior.
RPM	For each managed power supply, select a RPM, most likely a PDU, which has outlets that can be individually controlled, and which provides power to the device connected to the device port.

Outlet	For each managed power supply, enter the outlet on the selected RPM. As an aid to selecting the outlet, click the View Outlets button, then select an outlet from the list and click the Select Outlet button. The managed power supply outlet number will be filled in, as well as the managed power supply outlet name if a name is listed for the outlet and one has not already been defined for the managed power supply. A unique name for the managed power supply name is required; this is what will be displayed on the Power Management menu.
Name	For each managed power supply, enter the name on the selected RPM. As an aid to selecting the name, click the View Outlets button, then select an outlet from the list and click the Select Outlet button. The managed power supply outlet number will be filled in, as well as the managed power supply outlet name if a name is listed for the outlet and one has not already been defined for the managed power supply. A unique name for the managed power supply name is required; this is what will be displayed on the Power Management menu.
State	Displays the current state of the outlet when the Device Ports - Power Management web page is loaded: on , off or unknown if the RPM does not provide status for individual outlets or the SLC was unable to obtain the status of the outlet.
Action	The action to take on the outlet: Cycle Power, On or Off .

- To save, click **Apply**.

Device Ports - RPMs - Add Device

On the [Devices > Device Ports](#) page, access the [Device Ports > RPMs - Add Device](#) page to configure a new managed remote power manager (RPM) for the SLC configuration.

To add a new managed RPM :

- Connect to a specific port on the **Devices > Device Ports** page according to instructions in [To open the Device Ports - Settings page: \(on page 123\)](#).
- In the **Connected to** drop-down menu above the IP Settings section of the [Device Ports > Settings](#) page, select **RPM**.
- Click the **Add RPM** link. The [Device Ports > RPMs - Add Device](#) page displays.
Note: The [Device Ports > RPMs - Add Device](#) page can also be accessed via the [Devices > RPMs](#) page.
- Update the configuration settings on this page according to directions in [RPMs - Add Device \(on page 196\)](#).

Figure 8-7 Device Ports > RPMs - Add Device

LANTRONIX® SLC 8048

Logout Host: slc4331 User: sysadmin

Select port for Configuration WebSSH (DP only) Connected Device (DP only)

Network Services User Authentication Devices Maintenance Quick Setup

Device Status Device Ports Console Port USB / SD Card RPMs Connections Host Lists Scripts Sites

RPMs - Add Device Help?

Vendor: (U) - USB, (S) - Serial, (N) - Network, (P) - SNMP

Model:

Managed via: USB Serial Network SNMP

USB Device:

Name:

of Outlets:

IP Address:

Port: Enter "0" for a front USB port.

Driver Opts:

Login:

Password:

Retype Password:

Log Status: No Yes, minutes:

Critical SNMP Traps:

Critical Emails:

Low Battery: Shutdown this UPS Shutdown all UPSes Allow battery failure Shutdown both SLC UPSes

Shutdown Order:

Provides SLC Power:

Device Port - Sensorsoft Device

Devices made by Sensorsoft are used to monitor environmental conditions.

1. In the **Connected to** drop-down menu above the IP Settings section of the [Device Ports > Settings](#) page, select **Sensorsoft**.

Note: Sensorsoft temperature/humidity devices are supported with USB-to-serial adapters (ftdi/pl2303/cp210x) but not supported for use with USB-to-Serial CDC_ACM devices.

2. Click the **Device Commands** link. The following page displays:

Figure 8-8 Devices > Device Ports > Sensorsoft

The screenshot shows the LANTRONIX SLC 8048 web interface. At the top, there is a navigation bar with tabs for Network, Services, User Authentication, Devices, Maintenance, and Quick Setup. Below this is a sub-menu with links for Device Status, Device Ports, Console Port, USB / SD Card, Internal Modem, RPMs, Connections, Host Lists, Scripts, and Sites. The main content area is titled "Device Ports - Sensorsoft" and contains a table of sensorsoft devices. The table has columns for Dev Port, Device Port Name, Curr Temp, Low Temp, High Temp, Use °F, Humidity (%), Low Humidity, High Humidity, Contact, Traps, and Show Status. The table shows one device with Dev Port 5, Device Port Name Port-5, Curr Temp 0.0 °C, Low Temp 0, High Temp 25, Use °F unchecked, Humidity 0.0, Low Humidity 0, High Humidity 100, Contact N/A, and Traps checked. Below the table are links for "Back to Device Port Settings" and an "Apply" button.

Dev Port	Device Port Name	Curr Temp	Low Temp	High Temp	Use °F	Humidity (%)	Low Humidity	High Humidity	Contact	Traps	Show Status
5	Port-5	0.0 °C	0	25	<input type="checkbox"/>	0.0	0	100	N/A	<input checked="" type="checkbox"/>	<input type="radio"/>

3. Select a port and enter or view the following information:

Dev Port	Displays the number of the SLC port.
Device Port Name	Displays the name of the SLC port.
Curr Temp	Current temperature (degrees Celsius) on the device the sensor is monitoring.
Low Temp	Enter the temperature (degrees Celsius) permitted on the monitored device below which the SLC 8000 advanced console manager sends a trap.
High Temp	Enter the temperature (degrees Celsius) permitted on the monitored device above which the SLC unit sends a trap.
Use °F	Display and set the temperature for this device in degrees Fahrenheit, instead of Celsius, which is the default.
Humidity (%)	Current relative humidity on the device the sensor is monitoring.
Low Humidity	Enter the relative humidity permitted on the device the sensor is monitoring below which the sensor sends a trap to the SLC advanced console manager.
High Humidity	Enter the highest relative acceptable humidity permitted on the device above which the sensor sends a trap to the SLC unit.
Contact	Displays the current contact closure status of the sensor, if supported by the connected Sensorsoft device. If the Sensorsoft device does not report a contact status, N/A will be displayed. If Traps are enabled for the Sensorsoft device, an <code>slcEventDevicePortDeviceContactChanged</code> trap will be sent when the contact state changes from Open to Closed and from Closed to Open.
Traps	Select to indicate whether the SLC 8000 unit should send a trap or configured Event Alert when the sensor detects an out-of-range configured threshold.

4. Click the **Apply** button.
5. To view the status detected by the Sensorsoft, click the **Show Status** link in the far right column of the table.

Figure 8-9 Sensorsoft Status

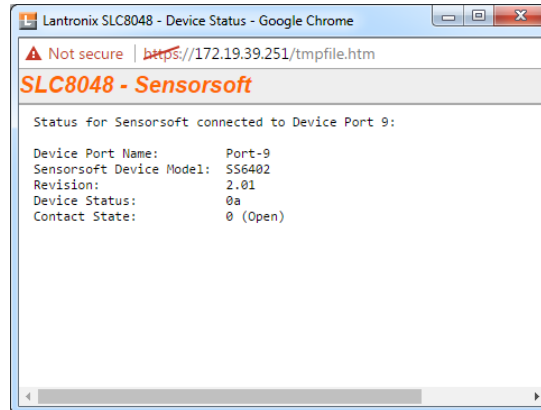

Device Port Commands

The following CLI commands correspond to the web page entries described above.

To configure a single port or a group of ports (for example, set deviceport port 2-5,6,12,15-16 baud 2400):

```
set deviceport port <Device Port List or Name> <one or more device port parameters>
```

Parameters

```

assertdtr <enable|disable>
auth <pap|chap>
banner <Banner Text>
baud <300-230400>
breakseq <1-10 Chars>
calleridcmd <Modem Command String>
calleridlogging <enable|disable>
cbcpnocalback <enable|disable>
cbcptype <admin|user>
chapauth <chaphost|localusers>
chaphost <CHAP Host or User Name>
checkdsr <enable|disable>
closedsr <enable|disable>
connectedmsg <enable|disable>
databits <7|8>
device <none|sensorsoft|rpm> dialbackeretrieves <1-10>
dialbackdelay <PPP Dial-back Delay>
dialinlist <Host List for Dial-in>
dialoutnumber <Phone Number>
dialoutlogin <User Login>
dialbacknumber <username|Phone Number>
dodauth <pap|chap>
dodchaphost <CHAP Host or User Name>

```

```

flowcontrol <none|xon/xoff|rts/cts>
group <Local or Remote Group Name>
idletimeout <disable|1-9999 seconds>
idletimeoutmsg <enable|disable>
ipaddr <IP Address>
initscript <Modem Initialization Script>
localipaddr <negotiate|IP Address>
logins <enable|disable>
maxdirect <1-15>
minimizelatency <enable|disable>
modemmode <text|ppp>
modemstate <disable|dialout|dialin|dialback|dialondemand|
dialin+ondemand|dialinhostlist>|dialback+ondemand|cbcpclient|cbcpserver
modemtimeout <disable|1-9999 seconds>
name <Device Port Name>
nat <enable|disable>
numsessionsmsg <enable|disable>
parity <none|odd|even>
portlogseq <1-10 Chars>
powermgmtseq <1-10 Chars>
remoteipaddr <negotiate|IP Address>
restartdelay <PPP Restart Delay>
reversepinout <enable|disable>
sendtermstr <enable|disable>
showlines <disable|1-50 lines>
sshauth <enable|disable>
sshdattadir <netin|netout|both>
sshin <enable|disable>
sshport <TCP Port>
sstimeout <disable|1-1800 seconds>
stopbits <1|2>
tcpauth <enable|disable>
tcpdatadir <netin|netout|both>
tcpin <enable|disable>
tcpport <TCP Port>
tcptimeout <disable|1-1800 seconds>
telnetauth <enable|disable>
telnetdatadir <netin|netout|both>
telnetin <enable|disable>
telnetport <TCP Port>
telnetsoftiac <enable|disable>
telnettimeout <disable|1-1800 sec>
termstr <Termination String>
timeoutlogins <disable or 1-30 minutes>
toggledtr <enable|disable>
usbvbus <enable|disable>
usesites <enable|disable>
viewportlog <enable|disable>

```

To set the dialout password and CHAP secrets:

```

set deviceport port <Device Port # or List or Name> dialoutpassword
set deviceport port <Device Port # or List or Name> chapsecret
set deviceport port <Device Port # or List or Name> dodchapsecret

```

To reset a device port, terminating and restarting all relevant connections:

```
set deviceport port <Device Port # or List or Name> reset
```

To configure up to 4 managed power supplies for device connected to a device port:

```
set deviceport port <Device Port # or Name> managepower
```

To view the settings for one or more device ports:

```
show deviceport port <Device Port List or Name> [display  
<ip|data|modem|logging|device>]
```

To view a list of all device port names:

```
show deviceport names
```

To view a list of all device port types (RJ45 or USB):

```
show deviceport types
```

To view global device port settings:

```
show deviceport global
```

To view the modes and states of one or more device port(s):

Note: You can optionally email the displayed information.

```
show portstatus [deviceport <Device Port List or Name>] [email <Email  
Address>]
```

To view device port statistics and errors for one or more ports:

Note: You can optionally email the displayed information.

```
show portcounters [deviceport <Device Port List or Name>] [email <Email  
Address>]
```

To zero the port counters for one or more device ports:

```
show portcounters zerocounters <Device Port List or Name>
```

Device Commands

The following CLI commands correspond to the web page entries described above.

To send commands to (or control) a device connected to an SLC unit port over the serial port:

Note: Currently the only devices supported for this type of interaction are the Sensorsoft devices.

```
set command <Device Port # or Name or List> <one or more parameters>
```

Parameters

`sensorsoft lowtemp <Low Temperature>`

Sets the lowest temperature permitted for the port.

`sensorsoft hightemp <High Temperature>`

Sets the highest temperature permitted for the port.

`sensorsoft lowhumidity <Low Humidity %>`

Sets the lowest humidity permitted for the port.

`sensorsoft highhumidity <High Humidity %>`

Sets the highest humidity permitted for the port.

`sensorsoft degrees <celsius|fahrenheit>`

Enables or disables temperature settings as Celcius or Fahrenheit.

`sensorsoft traps <enable|disable>`

Enables or disables traps when specified conditions are met.

`sensorsoft status`

Displays the status of the port.

`sensorsoft showall`

Displays the status for all connected Sensorsoft devices and ignores the device port list.

Note: *The Sensorsoft lowtemp and hightemp settings are given in the scale specified by the degrees setting.*

For commands to control RPMs, see [RPM Commands \(on page 206\)](#).

Interacting with a Device Port

Once a device port has been configured and connected to an external device such as the console port of an external server, the data received over the device port can be monitored at the command line interface with the connect listen command, as follows:

To connect to a device port to monitor it:

`connect listen deviceport <Port # or Name>`

In addition, you can send data out the device port (for example, commands issued to an external server) with the connect direct command, as follows:

To connect to a device port to monitor and/or interact with it, or to establish an outbound network connection:

`connect direct <endpoint>`

endpoint is one of:

`deviceport <Port # or Name>`

`ssh <IP Address> [port <TCP Port>][<SSH flags>]`

where:

```
<SSH flags> is one or more of:
user <Login Name>
version <1|2>
command <Command to Execute>
tcp <IP Address> port <TCP Port>
telnet <IP Address> [port <TCP Port>]
udp <IP Address> port <UDP Port>
hostlist <Host List>
```

Notes: To escape from the `connect direct` command when the endpoint of the command is `deviceport`, `tcp`, or `udp` and return to the command line interface, type the escape sequence assigned to the currently logged in user. If the endpoint is `telnet` or `SSH`, logging out returns the user to the command line prompt.

To escape from the `connect listen` command, press any key. Setting up a user with an escape sequence is optional. For any NIS, LDAP, RADIUS, Kerberos, or TACACS+ user, or any local user who does not have an escape sequence defined, the default escape sequence is `Esc+A`.

When connecting to a USB device port, buffered data collected while there was no active connection to the device port may be displayed initially. This is due to clearing internal buffers in preparation for the new connection to the device port.

Device Ports - Logging and Events

The SLC products support port buffering of the data on the system's device ports as well as notification of receiving data on a device port. Port logging is disabled by default. You can enable more than one type of logging (local, NFS file, token and data detection, SD card, or USB port) at a time. The buffer containing device port data is cleared when any type of logging is enabled.

Local Logging

If local logging is enabled, each device port stores 256 Kbytes (approximately 400 screens) of I/O data in a true FIFO buffer. You may view this data (in ASCII format) at the CLI with the `show locallog` command or on the [Devices > Device Ports - Logging & Events](#) page. Buffered data is normally stored in RAM and is lost in the event of a power failure if it is not logged using an NFS mount solution. If the buffer data overflows the buffer capacity, only the oldest data is lost, and only in the amount of overrun (not in large blocks of memory).

NFS File Logging

Data can be logged to a file on a remote NFS server. Data logged locally to the SLC 8000 advanced console manager is limited to 256 Kbytes and may be lost in the event of a power loss. Data logged to a file on an NFS server does not have these limitations. The system administrator can define the directory for saving logged data on a port-by-port basis and configure file size and number of files per port.

The directory path must be the local directory for one of the NFS mounts. For each logging file, once the file size reaches the maximum, a new file opens for logging. Once the number of files reaches the maximum, the oldest file is overwritten. The file naming convention is: `<Device Port Number>_<Device Port Name>_<File number>.log`.

Examples:

```
02_Port-2_1.log
02_Port-2_2.log
02_Port-2_3.log
02_Port-2_4.log
02_Port-2_5.log
```

USB and SD Card Logging

Data can be logged to a USB flash drive that is loaded into the USB ports or the SD card slot on the front of the SLC unit and properly mounted. Data logged locally to the SLC advanced console manager is limited to 256 Kbytes and may be lost in the event of a power loss. Data logged to a USB flash drive or SD card does not have these limitations. The system administrator can define the file size and number of files per port. For each logging file, once the file size reaches the maximum, a new file opens for logging. Once the number of files reaches the maximum, the oldest file is overwritten. The file naming convention is:

```
<Device Port Number>_<Device Port Name>_<File number>.log
```

Examples:

```
02_Port-2_1.log
02_Port-2_2.log
02_Port-2_3.log
02_Port-2_4.log
02_Port-2_5.log
```

Token/Data Detection

The system administrator can configure the device log to detect when a user-defined string or number of characters is received from the device, and automatically perform one or more actions: send a message to the system log, send an SNMP trap, send an email alert, send a string to the device, or control one of the power supplies associated with the device.

Syslog Logging

Data can be logged to the system log. If this feature is enabled, the data will appear in the Device Ports log, under the Info level. The log level for the Device Ports log must be set to Info for the data to be saved to the system log. See [Device Ports - Logging and Events \(on page 142\)](#).

To set logging parameters:

1. In the top section of the [Device Port Settings](#) page, click the **Settings** link in the Logging field. The following page displays:

Figure 8-10 Devices > Device Ports - Logging & Events

LANTRONIX® SLC 8048

Host: slc4331
User: sysadmin

Select port for Configuration WebSSH (DP only) Connected Device (DP only)

Network Services User Authentication **Devices** Maintenance Quick Setup

Device Status Device Ports Console Port USB / SD Card RPMs Connections Host Lists Scripts Sites

Device Ports - Logging & Events Help?

Port: 14
Name: Port-14

For NFS File Logging, the directory to log to must reside on an external NFS server. Specify the local directory for the [NFS mount](#).

Token & Data Detection:

Trigger on: Data Byte Count Token/Character String

Byte Threshold:

Token:

Actions

Syslog:

SNMP Trap:

Email:

Email To:

Email Subject:

Send String to Device:

String to Send:

Control Power Supply:

Power Supply:

Cycle Power

Power Action: Turn On Turn Off

See online help for how Delay parameters affect Actions.

Action Delay: seconds

Restart Delay: seconds

[Back to Device Port Settings](#)

Apply settings to Device Ports:

Note: In addition to applying settings to the currently selected Device Port, the settings can also be applied to other Device Ports.

Local Logging:

Clear Local Log: [View Local Log](#)

Log Viewing Attributes

Display: Tail Head

Number of Lines:

NFS File Logging:

NFS Log to View: [View](#)

Directory to Log to:

Max Number of Files:

Max Size of Files: bytes

USB / SD Card Logging:

Log to View: [View](#)

Log to: Port U1 Port U2 SD Card

Max Number of Files:

Max Size of Files: bytes

Syslog Logging:

Note: The logging level for the Device Ports log must be set to 'Info' to view Syslog entries for Device Port logging.

2. Enter the following:

Token & Data Detection

Token & Data Detection	Select to enable token and data detection on the selected device port, with a set of actions that can be enabled if a data trigger occurs. The default is disabled.
Trigger on	<p>Select the method of triggering an action:</p> <ul style="list-style-type: none"> ◆ Data Byte Count: A specific number of bytes of data. This is the default. ◆ Token/Character String: A specific pattern of characters, which you can define by a regular expression. <p>Note: Token/Character String recognition may negatively impact the SLC unit's performance, particularly when regular expressions are used.</p>

Byte Threshold	<p>The number of bytes of data the port will receive before the SLC unit will capture log data and initiate the selected actions. The default is 100 bytes.</p> <p>In most cases, the console port of your device does not send any data unless there is an alarm condition. After the SLC unit receives a small number of bytes, it perceives that your device needs some attention.</p> <p>A threshold set to 30 characters means that as soon as the unit receives 30 bytes of data, it performs the actions that are selected for this port.</p>
Token	<p>The specific pattern of characters the SLC unit must recognize before initiating the actions configured for this port. The maximum is 100 characters. You may use a regular expression to define the pattern. For example, the regular expression "abc[def]g" recognizes the strings abcdg, abceg, abcfg.</p> <p>The SLC console manager supports GNU regular expressions; for more information, see:</p> <ul style="list-style-type: none"> ◆ http://www.gnu.org/software/libc/manual/html_node/Regular-Expressions.html ◆ http://www.delorie.com/gnu/docs/regex/regex.html
Actions	<p>Select one or more actions to perform if there is a data trigger:</p> <ul style="list-style-type: none"> ◆ Syslog: A message is logged to the system log indicating what the data trigger was along with the initial portion of the data received. ◆ SNMP Trap: A slcEventDevicePortData trap will be sent to the NMS configured in the SNMP settings. ◆ Email: An email alert will be sent to the address configured for the device port. ◆ Send String to Device: A string will be sent to the device connected to the device port. ◆ Control Power Supply: The state of one or more of the device port power supplies can be changed.
Email to	<p>The email address of the message recipient(s) for an email alert. To enter more than one email address, separate the addresses with a single space. You can enter a total of 128 characters.</p>
Email Subject	<p>A subject text appropriate for your site. May have up to 128 characters.</p> <p>The email subject line is pre-defined for each port with its port number. You can use the email subject to inform the desired recipients of the problem on a certain server or location (e.g., server location or other classification of your equipment).</p> <p><i>Note: The character sequence %d anywhere in the email subject is automatically replaced with the device port number.</i></p>
String to Send	<p>The string to send to the device connected to the device port. The string supports the following special characters: newline (" \n "), double quote (" \" "), single quote (" \' "), and escape (" \x1b "). You can enter a total of 128 characters.</p>
Power Supply	<p>The power supply that provides power to the device connected to the device port which to control. Select either all power supplies or an individual power supply.</p>
Power Action	<p>The action to perform on the selected power supply or power supplies - Cycle Power, Turn On or Turn Off.</p>
Action Delay	<p>A time limit of how long, in seconds, the device port will capture data after the data trigger is detected and before closing the log file (with a fixed internal buffer maximum capacity of 1500 bytes) and performing the selected actions. The default is 60 seconds.</p>
Restart Delay	<p>The number of seconds for the period of time, after performing the selected action, during which the device port will ignore additional characters received. The data will simply be ignored and not trigger additional actions until this time elapses. The default is 60 seconds.</p>

Local Logging

Local Logging	If you enable local logging, each device port stores 256 Kbytes (approximately 400 screens) of I/O data in a true FIFO buffer. Disabled by default.
Clear Local Log	Select the checkbox to clear the local log.
View Local Log	Click this link to see the local log in text format.

Log Viewing Attributes

Display	Select to view either the beginning (Head) or end (Tail) of the log.
Number of Lines	Number of lines from the head or tail of the log to display.

NFS File Logging

NFS File Logging	Select the checkbox to log all data sent to the device port to one or more files on an external NFS server. Disabled by default.
NFS Log to View	Available log files in the selected NFS Directory to view.
Directory to Log to	The path of the directory where the log files will be stored. <i>Note: This directory must be a directory exported from an NFS server mounted on the SLC 8000 advanced console manager Specify the local directory path for the NFS mount.</i>
Max Number of Files	The maximum number of files to create to contain log data to the port. These files keep a history of the data received from the port. Once this limit is exceeded, the oldest file is overwritten. The default is 10 .
Max Size of Files	The maximum allowable file size in bytes. The default is 2048 bytes. Once the maximum size of a file is reached, the SLC unit begins generating a new file.

USB / SD Card Logging

USB / SD Card Logging	Select to enable USB / SD card logging. A USB thumb drive or SD card must be loaded into one of the ports of the SLC and properly mounted. Disabled by default.
Log to View	Available log files in the selected USB / SD card slot to view.
Log To	Select the USB port or SD card to use for logging.
Max Number of Files	The maximum number of files to create to contain log data to the port. These files keep a history of the data received from the port. Once this limit is exceeded, the oldest file is overwritten. The default is 10.
Max Size of Files	The maximum allowable file size in bytes. The default is 2048 bytes. Once the maximum size of a file is reached, the SLC 8000 advanced console manager begins generating a new file. The default is 2048 bytes.

Syslog Logging

Syslog Logging	Select to enable system logging. <i>Note: The logging level for the device ports log must be set to Info to view Syslog entries for Device Port logging on the Services > SSH/Telnet/Logging page.</i>
-----------------------	--

Note: To apply the settings to additional device ports, in the Apply settings to Device Ports field, enter the additional ports, (e.g., 1-3, 5, 6)

- To apply settings to other device ports in addition to the currently selected port, select the

Apply settings to Device Ports and enter port numbers separated by commas. Indicate a range of port numbers with a hyphen (e.g., 2, 5, 7-10), and separate ranges with commas.

4. To save, click the **Apply** button.

Logging Commands

The following CLI commands correspond to the web page entries described above.

To configure logging settings for one or more device ports:

```
set deviceport port <Device Port List or Name> <one or more parameters>
```

Note: Local logging must be enabled for a device port for the `locallog` commands to be executed. To use the `set locallog clear` command, the user must have permission to clear port buffers (see [Chapter 12: User Authentication on page 217](#)).

Example:

```
set deviceport port 2-5,6,12,15-16 locallogging enable
```

Parameters

```
actiondelay <Action Delay>
actionrestart <Restart Delay>
bytethreshold <# of Characters>
emailsubj <Email Subject>
emailto <Email Address>
locallogging <enable|disable>
nfsdir <Logging Directory>
nfslogging <enable|disable>
nfsmaxfiles <Max # of Files>
nfsmaxsize <Size in Bytes>
poweraction <on|off|cycle>
powersupply <Managed Power Supply Name>
sendstring <String to Send|QUOTEDSTRING>
sysloglogging <enable|disable>
tokenaction <List of none,log,trap,email,string,power>
tokendatadetect <enable|disable>
tokenstring <Regex String>
tokentrigger <bytecnt|charstr>
usblogging <enable|disable>
usbmaxfiles <max # of Files>
usbmaxsize <Size in Bytes>
usbport <U1|U2|SD>
```

To view a specific number of bytes of data for a device port:

```
show locallog <Device Port # or Name> [bytes <Bytes To Display>]
```

1 Kbyte is the default.

To clear the local log for a device port:

```
set locallog clear <Device Port # or Name>
```

Note: The `locallog` commands can only be executed for a device port if local logging is enabled for the port. The `set locallog clear` command can only be executed if the user has permission to clear port buffers (see [Chapter 12: User Authentication on page 217](#)).

Console Port

The console port initially has the same defaults as the device ports. Use the [Devices > Console Port](#) page to change the settings, if desired.

To set console port parameters:

1. Click the **Devices** tab and select **Console Port**. The following page displays:

Figure 8-11 Devices > Console Port

The screenshot shows the LANTRONIX SLC 8048 web interface. At the top, there is a navigation bar with tabs for Network, Services, User Authentication, Devices (selected), Maintenance, and Quick Setup. Below the navigation bar, there are links for Device Status, Device Ports, Console Port (selected), USB / SD Card, RPMs, Connections, Host Lists, Scripts, and Sites. The main content area is titled 'Console Port' and shows the following configuration options:

- Status: Not Connected
- Baud: 9600 (dropdown)
- Data Bits: 8 (dropdown)
- Stop Bits: 1 (dropdown)
- Parity: none (dropdown)
- Flow Control: none (dropdown)
- Timeout: No Yes, minutes:
- Show Lines On Connecting: No Yes, # of lines:
- Group Access:
- Apply button

2. Change the following as desired:

Baud	The speed with which the device port exchanges data with the attached serial device. From the drop-down list, select the baud rate. Most devices use 9600 for the administration port, so the console port defaults to this value.
Data Bits	Number of data bits used to transmit a character. From the drop-down list, select the number of data bits. The default is 8 data bits.
Stop Bits	The number of stop bits that indicate that a byte of data has been transmitted. From the drop-down list, select the number of stop bits. The default is 1 .
Parity	Parity checking is a rudimentary method of detecting simple, single-bit errors. From the drop-down list, select the parity. The default is none .
Flow Control	A method of preventing buffer overflow and loss of data. The available methods include none , xon/xoff (software), and rts/cts (hardware). The default is none .

Timeout	The number of minutes (1-30) after which an idle session on the console is automatically logged out. Disabled by default.
Show Lines on Connecting	If selected, when you connect to the console port with a terminal emulator, you will see the last lines output to the console, for example, the SLC boot messages or the last lines output during a CLI session on the console.
Group Access	If undefined, any group can access the console port. If one or more groups are specified (groups are delimited by the characters ' ' (space), ',' (comma), or ';' (semicolon)), then any user who logs into the console port must be a member of one of the specified groups, otherwise access will be denied. Users authenticated via RADIUS may have a group (or groups) provided by the RADIUS server via the Filter-Id attribute that overrides the group defined for a user on the SLC 8000 advanced console manager. A group provided by a remote server must be either a single group or multiple groups delimited by the characters ' ' (space), ',' (comma), ';' (semicolon), or '=' (equals) - for example "group=group1,group2;" or "group1,group2,group3".

3. Click the **Apply** button to save the changes.

Console Port Commands

The following CLI commands correspond to the web page entries described above.

To configure console port settings:

```
set consoleport <one or more parameters>
```

Parameters

```

baud <300-230400>
databits <7|8>
stopbits <1|2>
group <Local or Remote Group Name>
parity <none|odd|even>
flowcontrol <none|xon/xoff|rts/cts>
showlines <disable|1-50 lines>
timeout <disable|1-30>

```

To view console port settings:

```
show consoleport
```

Internal Modem Settings

This section describes how to configure an internal modem in the SLC advanced console manager. The SLC 8000 internal modem is an optional part. If the modem is installed, a message will be displayed when the SLC unit is booted:

```
Internal modem installed.
```

The presence of the modem will also be displayed in the CLI `admin version` command, the web [About SLC](#) page, and the System Configuration report. The internal modem provides a subset of the modem functionality available for modems connected to a Device Port and USB modems. If the internal modem is installed, the Internal Modem web page can be displayed by selecting the Internal Modem option from the main menu, or by selecting the **MD** button in the [Sample Dashboards](#) on the upper right corner of the web page.

Note: *The internal modem only supports Dial-in, Dial-out and Dial-back.*

Setting Up Internal Modem Storage

An internal modem may be configured on the [Devices > Internal Modem](#) page and accessed through the [Sample Dashboards](#) only if it is installed into the SLC 8000 advanced console manager.

To set up internal modem storage in the SLC 8000 advanced console manager:

1. Insert an internal modem into the SLC unit according to the instructions in [Modem Installation \(on page 41\)](#).

Note: *Your internal modem will appear in the [Sample Dashboards](#) in the upper right hand corner once the SLC unit is reboots.*

2. Reboot the SLC 8000 advanced console manager.
3. Log into the SLC unit and click **Devices**.
4. Click **Internal Modem**. [Figure 8-12](#) shows the page that displays.

Figure 8-12 Devices > Internal Modem

LANTRONIX[®] SLC 8048

Logout Host: slc4331 User: sysadmin

Select port for Configuration WebSSH (DP only) Connected Device (DP only)

Network Services User Authentication **Devices** Maintenance Quick Setup

Device Status Device Ports Console Port USB / SD Card Internal Modem RPMs Connections Host Lists Scripts Sites

Internal Modem Help ?

[View Modem Log >](#)

State: PPP Logging:

Mode: Text PPP PPP Debug:

Use Sites:

Group Access:

Initialization Script:

Modem Timeout: No Yes, seconds (1-9999):

Caller ID Logging: Modem Command:

Check Dial Tone: No Yes, minutes (5-600):

Dial-back Number: Local User Number Fixed Number:

Dial-back Delay: seconds

Dial-back Retries:

Text Mode

Timeout Logins: No Yes, minutes (1-30):

PPP Mode

Negotiate IP Address: Yes No Local IP:

Remote IP:

Authentication: PAP CHAP

Host/User Name:

CHAP Handshake: Secret/User Password:

Retype Password:

CHAP Auth Uses: CHAP Host Local Users

Enable NAT: **Note:** Enabling NAT requires [IP Forwarding](#) to be enabled.

Dial-out Number:

Remote/Dial-out Login:

Remote/Dial-out Password: Retype:

Restart Delay: seconds

5. Enter the following fields.

State	Indicates whether the internal is enabled. When enabling, set the modem to Disabled , Dial-in , Dial-out , and Dial-back . Disabled by default.
Mode	The format in which the data flows back and forth. <ul style="list-style-type: none"> ◆ With Text selected, the SLC unit assumes that the modem will be used for remotely logging into the command line. Text mode is only for dialing in. This is the default. ◆ PPP establishes an IP-based link over the modem. PPP connections can be used in dial-out mode (e.g., the SLC unit connects to an external network) or dial-in mode (e.g., the external computer connects to the network that the SLC unit is part of), dial-back (dial-in followed by dial-out), CBCP server and CBCP client.
Use Sites	For more information see Sites (on page 174) .
Group Access	If undefined, any group can access the modem (text login only). If one or more groups are specified (groups are delimited by the characters ',' (comma) or ';' (semicolon)), then any user who logs into the modem must be a member of one of the specified groups, otherwise access will be denied. Users authenticated via RADIUS may have a group (or groups) provided by the RADIUS server via the Filter-Id attribute that overrides the group defined for a user on the SLC unit. A group provided by a remote server must be either a single group or multiple groups delimited by the characters ',' (comma), ';' (semicolon), or '=' (equals) - for example "group=group1,group2;" or "group1,group2,group3".
Initialization Script	Commands sent to configure the modem may have up to 100 characters. Consult your modem's documentation for recommended initialization options. If you do not specify an initialization script, the SLC uses a default initialization string of: <pre>AT S7=45 SO=0 L1 V1 X4 &D2 &c1 E1 Q0</pre> <p>Note: We recommend that the modem initialization script always be pre-pended with AT and include E1 V1 x4 Q0 so that the SLC unit may properly control the modem.</p>
Modem Timeout	Timeout for modem connections. Set to No by default. To configure the modem connection to time out when no traffic is received choose Yes and enter a value of 1 to 9999 seconds.
Caller ID Logging	Select to enable the SLC unit to log caller IDs on incoming calls. Disabled by default.
Modem Command	Modem AT command used to initiate caller ID logging by the modem. Note: For the AT command, use +VCID=1 to enable Caller ID with formatted presentation, and use +VCID=2 to enable Caller ID with unformatted presentation. This is subject to subscribing to a Caller ID service for the modem line.
Check Dial Tone	If set to Yes , the SLC will periodically check the modem for a dial tone while waiting for a dial in (e.g., if the Modem State is set to Dial-in, or if the Modem State is set to Dial-back and the SLC unit is in the Dial-in portion of the sequence). The SLC unit can issue a trap or an event can be setup to notify the user if no dial tone is detected. Set to Yes by default (every 15 minutes).

Dial-back Number	<p>Users with Dial-back can dial into the SLC unit and enter their login and password. Once the SLC unit authenticates them, the modem hangs up and dials them back .</p> <p>Select the phone number the modem dials back on: a fixed number or a number associated with their login. If you select Fixed Number, enter the number (in the format 2123456789).</p> <p>The dial-back number is also used for CBCP client as the number for a user-defined number. See CBCP Server and CBCP Client for more information.</p>
Dial-back Delay	For dial-back and CBCP Server, the number of seconds between the dial-in and dial-out portions of the dialing sequence.
Dial-back Retries	For dial-back and CBCP Server, the number of times the SLC unit will retry the dial-out portion of the dialing sequence if the first attempt to dial-out fails.
Timeout Logins	If you selected text mode, you can enable logins to time out after the connection is inactive for a specified number of minutes. The default is No . This setting only applies to text mode connections. PPP mode connections stay connected until either side drops the connection. Disabled by default.
Negotiate IP Address	<p>If the SLC and/or the serial device have dynamic IP addresses (e.g., IP addresses assigned by a DHCP server), select Yes. This is the default.</p> <p>If the SLC unit or the modem have fixed IP addresses, select No, and enter the Local IP (IP address of the internal modem) and Remote IP (IP address of the modem).</p>
Authentication	<p>Enables PAP or CHAP authentication for modem logins. PAP is the default.</p> <p>With PAP, users are authenticated by means of the Local Users and any of the remote authentication methods that are enabled.</p> <p>With CHAP, the CHAP Handshake fields authenticate the user.</p>
CHAP Handshake	The Host/User Name (for UNIX systems) or Secret/User Password (for Windows systems) used for CHAP authentication. May have up to 128 characters.
CHAP Auth Uses	For CHAP authentication, determines what is used to validate the CHAP host/user sent by the remote peer: either the CHAP Host defined for the modem, or any of the users in the Local Users list.
Enable NAT	<p>Select to enable Network Address Translation (NAT) for dial-in and dial-out PPP connections on a per modem (device port, USB port, or internal modem) basis. Users dialing into the SLC unit access the network connected to Eth1 and/or Eth2.</p> <p>Note: IP forwarding must be enabled on the Network Settings (on page 54) for NAT to work.</p>
Dial-out Number	Phone number for dialing out to a remote system or serial device. May have up to 20 characters. Any format is acceptable.
Remote/Dial-out Login	User ID for authentication when dialing out to a remote system, or if a remote system requests authentication from the SLC module when it dials in. May have up to 32 characters.
Remote/Dial-out Password/ Retype	Password for authentication when dialing out to a remote system, or if a remote system requests authentication from the SLC unit when it dials in. May have up to 20 characters.
Restart Delay	The number of seconds after the timeout and before the SLC module attempts another connection. The default is 30 seconds.

6. Click **Apply**.

Internal Modem Commands

Configure the internal modem:

```
set intmodem <parameters>
```

Parameters

```
auth <pap|chap>
calleridcmd <Modem Command String>
calleridlogging <enable|disable>
modemstate <disable|dialin|dialout|dialback>
usesites <enable|disable>
modemmode <text|ppp>
group <Local or Remote Group Name>
timeoutlogins <disable|1-30 minutes>
modemtimeout <disable|1-9999 sec>
localipaddr <negotiate|IP Address>
restartdelay <PPP Restart Delay>
remoteipaddr <negotiate|IP Address>
chaphost <CHAP Host or User Name>
initscript <Modem Init Script>
nat <enable|disable>
chapauth <chaphost|localusers>
checkdialtone <disable|5-600 min>
dialbacknumber <username|Phone Number>
dialoutnumber <Phone Number>
dialbackdelay <PPP Dialback Delay>
dialoutlogin <Remote User Login>
dialbackretries <1-10>
```

Set the modem password and CHAP secret (any extra parameters will be ignored):

```
set intmodem dialoutpassword
set intmodem chapsecret
```

Note: *It is recommended that the initscript be prepended with 'AT' and include 'E1 V1 x4 Q0' so that the SLC may properly control the modem.*

Display settings for the internal modem:

```
show intmodem
```

Host Lists

A host list is a prioritized list of SSH, Telnet, and TCP hosts available for establishing incoming modem connections or for the `connect direct` command on the CLI. The SLC unit cycles through the list until it successfully connects to one.

To add a host list:

1. Click the **Devices** tab and select the **Host Lists** option. The following page displays:

Figure 8-13 Devices > Host Lists

The screenshot shows the LANTRONIX SLC 8048 web interface. At the top, there is a navigation bar with tabs for Network, Services, User Authentication, Devices, Maintenance, and Quick Setup. The 'Devices' tab is selected, and the 'Host Lists' option is highlighted. Below the navigation bar, there is a 'Host Lists' section with a table containing columns for 'Id' and 'Name'. To the right of the table are buttons for 'View Host List' and 'Delete Host List'. Below the table, there are input fields for 'Host List Id' (set to 0), 'Host List Name', 'Retry Count', and 'Authentication'. To the right of these fields are buttons for 'Clear Host List', 'Add Host List', and 'Edit Host List'. Below the input fields, there is a 'Host Parameters' section with fields for 'Host', 'Protocol' (set to TCP), 'Port', and 'Escape Sequence', along with a 'Clear Host Parameters' button. To the right of the 'Host Parameters' section is a 'Hosts (in order of precedence)' section, which is a large empty box with up and down arrow buttons for adding and removing hosts.

2. Enter the following:

Note: To clear fields in the lower part of the page, click the **Clear Host List** button.





Host List Id	Displays after a host list is saved.
Host List Name	Enter a name for the host list.
Retry Count	Enter the number of times the SLC advanced console manager should attempt to retry connecting to the host list.
Authentication	Select to require authentication when the SLC unit connects to a host.

3. You have the following options:

- To save the host list without adding hosts at this time, click the **Add Host List** button.
- To add hosts, enter the following:

Host Parameters

Host	Name or IP address of the host.
Protocol	Protocol for connecting to the host (TCP, SSH, or Telnet).
Port	Port on the host to connect to.
Escape Sequence	<p>The escape character used to get the attention of the SSH or Telnet client. It is optional, and if not specified, Telnet and SSH use their default escape character. For Telnet, the escape character is either a single character or a two-character sequence consisting of '^' followed by one character. If the second character is '?', the DEL character is selected. Otherwise, the second character is converted to a control character and used as the escape character. For SSH, the escape character is a single character.</p> <p>Note: When the Device Port Esc Sequence/ViewLog/PowerMenu Escape Sequence is configured, the following escape sequence precedent behavior can be expected: 1) Escape 2) PowerMenu 3) ViewLogs A clear/restart of the remaining escape events occurs when there is a match in any configured sequence. All the sequences should have unique sequence defined and user should avoid overlapping sequence strings. When detecting key sequences, after receiving the first character(s) of a sequence, the SLC will wait 3 or more seconds for the remaining characters, before timing out and sending all characters to the device. For example, if the Escape Sequence is ABCD, and the user types "AB", the SLC will wait at least 3 seconds for the next character ("C") before timing out and sending the "AB" characters to the device.</p>

4. Click the right  arrow. The host displays in the Hosts box.
5. Repeat steps 2-4 to add more hosts to the host list.
6. Click the **Clear Host Parameters** button to clear fields before adding the next host.
7. You have the following options:
 - To remove a host from the host list, select the host in the Hosts box and click the left  arrow.
 - To give the host a higher precedence, select the host in the Hosts box and click the up  arrow.
 - To give the host a lower precedence, select the host in the Hosts box and click the down  arrow.
8. Click the **Add Host List** button. After the process completes, a link back to the [Device Ports > Settings](#) page displays.

To view or update a host list:

1. In the Host Lists table, select the host list and click the **View Host List** button. The list of hosts display in the Hosts box.





Figure 8-14 View Host Lists

2. View, add, or update the following:

Host List Id	Displays after a host list is saved.
Host List Name	Enter a name for the host list.
Retry Count	Enter the number of times the SLC 8000 advanced console manager should attempt to retry connecting to the host list.
Authentication	Select to require authentication when the SLC unit connects to a host.

Host Parameters

Host	Name or IP address of the host.
Protocol	Protocol for connecting to the host (TCP, SSH, or Telnet).
Port	Port on the host to connect to SLC advanced console manager
Escape Sequence	The escape character used to get the attention of the SSH or Telnet client. It is optional, and if not specified, Telnet and SSH use their default escape character. For Telnet, the escape character is either a single character or a two-character sequence consisting of '^' followed by one character. If the second character is '?', the DEL character is selected. Otherwise, the second character is converted to a control character and used as the escape character. For SSH, the escape character is a single character.

3. You have the following options:
 - To add a host to the host list, click the right  arrow. The host displays in the Hosts box.
 - To remove a host from the host list, select the host in the Hosts box and click the left  arrow.
 - To give the host a higher precedence, select the host in the Hosts box and click the up  arrow.
 - To give the host a lower precedence, select the host in the Hosts box and click the down  arrow.
4. Click the **Edit Host List** button. After the process completes, a link back to the [Device Ports > Settings](#) page displays.

To delete a host list:

1. Select the host list in the Host Lists table.
2. Click the **Delete Host List** button. After the process completes, a link back to the [Device Ports > Settings](#) page displays.

Host List Commands

The following CLI commands correspond to the web page entries described above.

To configure a prioritized list of hosts to be used for modem dial-in connections:

```
set hostlist add|edit <Host List Name> [<parameters>]
```

Parameters

```
name <Host List Name> (edit only)
retrycount <1-10>
auth <enable|disable>
```

Default: retrycount=3, auth=enable.

To add a new host entry to a list or edit an existing entry:

```
set hostlist add|edit <Host List Name> entry <Host Number>
[<parameters>]
```

Parameters

```
host <IP Address or Name>
protocol <ssh|telnet|tcp>
port <TCP Port>
escapeseq <1-10 Chars>
```

To move a host entry to a new position in the host list:

```
set hostlist edit <Host List Name> move <Host Number> position <Host
Number>
```

To delete a host list, or a single host entry from a host list:

```
set hostlist delete <Host List> [entry <Host Number>]
```

To display the members of a host list:

```
show hostlist <all|names|Host List Name>
```

Scripts

The SLC unit supports two types of scripts:

- ◆ **Interface Scripts** which use a subset of the Expect/Tcl scripting language to perform pattern detection and action generation on Device Port output.
- ◆ **Batch Scripts** which are a series of CLI commands. A user can create scripts at the web, view scripts at the web and the CLI, and utilize scripts at the CLI. For a description of the syntax allowed in Interface Scripts, see Interface Script Syntax at the end of this page.

All scripts have permissions associated with them; a user who runs a script must have the permissions associated with the script in order to run the script.

To add a script:

1. Click the **Devices** tab and select the **Scripts** option. This page displays.

Figure 8-15 Devices > Scripts

LANTRONIX® SLC 8048

Logout Host: slc4331 User: sysadmin

Select port for Configuration WebSSH (DP only) Connected Device (DP only)

Network Services User Authentication Devices Maintenance Quick Setup

Device Status Device Ports Console Port USB / SD Card RPMs Connections Host Lists Scripts Sites

Scripts Help?

Add Script

Edit Script

Rename Script

New Name:

Delete Script

Change Permissions

Default Users

Group: Power Users Administrators

Full Administrative:

Networking:

Services:

Secure Lantronix Network:

Date/Time:

Local Users:

Remote Authentication:

SSH Keys:

User Menu:

Web Access:

Diagnostics & Reports:

Reboot & Shutdown:

Firmware & Configuration:

Device Port Operations:

Device Port Configuration:

USB:

Internal Modem:

SD Card:

RPMs:

Scripts			
Name	Type	Grp	Permissions

2. Click the **Add Scripts** button. The page for editing script attributes displays.

Figure 8-16 Adding or Editing New Scripts

LANTRONIX[®] SLC 8048

Logout Host: slc4331 User: sysadmin

Select port for Configuration WebSSH (DP only) Connected Device (DP only)

Network Services User Authentication Devices Maintenance Quick Setup

Device Status Device Ports Console Port USB / SD Card RPMs Connections Host Lists Scripts Sites

Scripts Help?

Script Name:

Type: Interface Batch

User Rights

Group: Default Users Power Users Administrators

Full Administrative: Local Users: Firmware & Configuration:

Networking: Remote Authentication: Internal Modem:

Services: SSH Keys: Device Port Operations:

Secure Lantronix Network: User Menus: Device Port Configuration:

Date/Time: Web Access: USB:

Reboot & Shutdown: Diagnostics & Reports: SD Card:

RPMs:

[Back to Scripts](#)

3. Enter the following:

Scripts

Script Name	A unique identifier for the script.
Type	<ul style="list-style-type: none"> ◆ Select Interface for a script that utilizes Expect/Tcl to perform pattern detection and action generation on Device Port output. ◆ Select Batch for a script of CLI commands.

4. In the **User Rights** section, select the user **Group** to which NIS users will belong:

User Rights

Group	<p>Select the group to which the NIS users will belong:</p> <ul style="list-style-type: none"> ◆ Default Users: This group has only the most basic rights. You can specify additional rights for the individual user. ◆ Power Users: This group has the same rights as Default Users plus Web Access, Networking, Date/Time, Reboot & Shutdown, and Diagnostics & Reports. ◆ Administrators: This group has all possible rights.
--------------	---

5. Assign or unassign **User Rights** for the specific user by checking or unchecking the following boxes:

Full Administrative	Right to add, update, and delete all editable fields.
Networking	Right to enter Network settings.
Services	Right to enable and disable system logging, SSH and Telnet logins, SNMP, and SMTP.
Secure Lantronix Network	Right to view and manage secure Lantronix units (e.g., Spider, or SLC devices) on the local subnet.
Date/Time	Right to set the date and time.
Reboot & Shutdown	Right to shut down and reboot the SLC unit.
Local Users	Right to add or delete local users on the system.
Remote Authentication	Right to assign a remote user to a user group and assign a set of rights to the user.
SSH Keys	Right to set SSH keys for authenticating users.
User Menus	Right to create a custom user menu for the CLI.
Web Access	Right to access Web-Manager.
Diagnostics & Reports	Right to obtain diagnostic information and reports about the unit.
Firmware & Configuration	Right to upgrade the firmware on the unit and save or restore a configuration (all settings). Selecting this option automatically selects Reboot & Shutdown.
Internal Modem	Right to configure internal modem settings.
Device Port Operations	Right to control device ports.
Device Port Configuration	Right to enter device port configurations.
USB	Right to enter modem settings for USB modems and to control USB storage devices.
SD Card	Right to view and enter settings for SD card.
RPM	Right to view and enter remote power manager settings.

6. To save, click the **Apply** button. If the type of script is Interface, the script will be validated before it is saved. Once the script is saved, the main *Scripts* page is displayed.

To view or update a script:

1. In the Scripts table, select the script and click the **Edit Script** button. The page for editing script attributes displays (see [Figure 8-16](#)).
2. Update the script **attributes** (see *To add a script:* above).

3. To save, click the **Apply** button.

To rename a script:

1. In the Scripts table, select the script and enter a new script name in the **New Name** field.
2. Click the **Rename Script** button. The script will be renamed and the *Devices > Scripts* page redisplay.

To delete a script:

1. In the Scripts table, select the script to delete.
2. Click the **Delete Script** button. After a confirmation, the script will be deleted and the *Devices > Scripts* page redisplay.

To change the permissions for a script:

1. In the Scripts table, select the script and select the new Group and/or Permissions.
2. Click the **Change Permissions** button. The script updates and the *Devices > Scripts* page redisplay.

To use a script at the CLI:

1. To run an Interface Script on a device port for pattern recognition and action generation, use the `connect script <Script Name> deviceport <Device Port # or Name>` command.
2. To run a Batch Script at the CLI with a series of CLI commands, use the `set script runcli <Script Name>` command.

Set Script CLI Commands

To run a CLI batch script:

```
set script runcli <Script Name>
```

To import a script:

```
set script import <interface|batch> via <ftp|scp|coppypaste>
    [file <Script File>] [name <Script Name>] [host <IP Address or Name>]
    [login <User Login>] [path <Path to Script File>]
```

Note: *Interface scripts will be given default/do user rights; Batch scripts will be given admin/ad user rights. The name of the script will be the same as the file name (if it is a valid script name), otherwise a script name must be specified for import.*

```
set script update <interface|batch> name <Script Name>
    [group <default|power|admin>] [permissions <Permission List>]
```

Note: See 'help user permissions' for information on groups and user rights.

To rename a script:

```
set script rename <interface|batch> name <Script Name> newname
```

```
<New Script Name>
```

To delete a script

```
set script delete <interface|batch> name <Script Name>
```

To connect an interface script to a Device Port and run it:

```
connect script <Script Name> deviceport <Device Port # or Name>
```

To display list of Device Port (interface) scripts or CLI (batch) scripts, or view the contents of a script:

```
show script [type <interface|batch> [name <Script Name>]]
```

Show Script CLI Commands**To run a CLI batch script:**

```
set script runcli <Script Name>
```

To import a script:

```
set script import <interface|batch> via <ftp|scp|coppypaste>
    [file <Script File>] [name <Script Name>] [host <IP Address or Name>]
    [login <User Login>] [path <Path to Script File>]
```

Note: *Interface scripts will be given default/do user rights; Batch scripts will be given admin/ad user rights. The name of the script will be the same as the file name (if it is a valid script name), otherwise a script name must be specified for import.*

```
set script update <interface|batch> name <Script Name>
    [group <default|power|admin>] [permissions <Permission List>]
See 'help user permissions' for information on groups and user rights.
```

To rename a script:

```
set script rename <interface|batch> name <Script Name> newname <New
Script Name>
```

To delete a script

```
set script delete <interface|batch> name <Script Name>
```

To connect an interface script to a Device Port and run it:

```
connect script <Script Name> deviceport <Device Port # or Name>
```

To display list of Device Port (interface) scripts or CLI (batch) scripts, or view the contents of a script:

```
show script [type <interface|batch> [name <Script Name>]]
```

Batch Script Syntax

The syntax for Batch Scripts is exactly the same as the commands that can be typed at the CLI, with the additions described in this section.

The `sleep` command suspends execution of the script (puts it to 'sleep') for the specified number of seconds. Syntax:

```
sleep <value>
```

The `while` command allows a loop containing CLI commands to be executed. Syntax:

```
while {<Boolean expression>} {
    CLI command 1
    CLI command 2
    ...
    CLI command n
}
```

Note: The closing left brace '`}`' must be on a line without any other characters. To support a `while` command, the `set` command, variables, and secondary commands are also supported.

Interface Script Syntax

This section describes the abbreviated scripting syntax for Interface Scripts. This limited syntax was created to prevent the creation of scripts containing potentially harmful commands. Script commands are divided into three groups: Primary, Secondary and Control Flow. Primary commands provide the basic functionality of a script and are generally the first element on a line of a script, as in:

```
send_user "Password:"
```

Secondary commands provide support for the primary commands and are generally not useful by themselves. For example, the `expr` command can be used to generate a value for a `set` command.

```
set <my_var> [expr 1 + 1]
```

Control Flow commands allow conditional execution of other commands based on the results of the evaluation of a Boolean expression.

Table 8-17 Definitions

Term	Definition
Word	A contiguous group of characters delimited on either side by spaces. Not enclosed by double quotes.
Primary Command	One of the primary commands listed in this section.
Secondary Command	One of the secondary commands defined in this section.
Quoted String	A group of characters enclosed by double quote (") characters. A quoted string may include any characters, including space characters. If a double quote character is to be included in a quoted string it must be preceded (escaped) by a backslash character (\).
Variable Reference	A word (as defined above) preceded by a dollar sign character ('\$').
CLI Command	A quoted string containing a valid CLI <code>show</code> command.

Term	Definition
Arithmetic Operator	<p>A single character representing a simple arithmetic operation. The character may be one of the following:</p> <ul style="list-style-type: none"> ◆ A plus sign (+) representing addition ◆ A minus sign (-) representing subtraction ◆ An asterisk sign (*) representing multiplication ◆ A forward slash (/) representing division ◆ A percent sign (%) representing a modulus
Boolean Expression	<p>An expression which evaluates to TRUE or FALSE. A Boolean expression has the following syntax:</p> <p><value> <Boolean operator> <value></p> <p>Each can be either a word or a variable reference.</p>
Boolean Operator	<p>A binary operator which expresses a comparison between two operands and evaluates to TRUE or FALSE. The following Boolean operators are valid:</p> <ul style="list-style-type: none"> ◆ '<' less than ◆ '>' greater than ◆ '<=' less than or equal to ◆ '>=' greater than or equal to ◆ '==' equal to ◆ '!=' not equal to

Primary Commands

These are *stand-alone* commands which provide the primary functionality in a script. These commands may rely on one or more of the Secondary Commands to provide values for some parameters. The preprocessor will require that these commands appear only as the first element of a command line. The start of a command line is delimited by any of the following:

- ◆ The start of a new line of text in the script
- ◆ A semicolon (;)
- ◆ A left brace ({)

Table 8-18 Primary Commands

Command	Description
set	<p>The <code>set</code> command assigns a value to a variable. Syntax:</p> <p><code>set <variable> <value></code></p> <p>where <variable> is a word, and <value> can be defined in one of the following ways:</p> <ul style="list-style-type: none"> ◆ A quoted string ◆ A word ◆ A variable reference ◆ A value generated via one of the string secondary commands (<code>compare</code>, <code>match</code>, <code>first</code>, etc.) ◆ A value generated via the <code>expr</code> secondary command ◆ A value generated via the <code>format</code> secondary command ◆ A value generated via the <code>expr timestamp</code> command
unset	<p>This command removes the definition of a variable within a script. Syntax:</p> <p><code>unset <variable></code></p> <p>where <variable> is a word.</p>

Command	Description
scan	The <code>scan</code> command is analogous to the C language <code>scanf()</code> . Syntax: <code>scan <variable> <format string> <value 1> <value 2> ... <value n></code> where <code><variable></code> a variable reference, and <code><format string></code> is a quoted string. Each of the <code><value x></code> elements will be a word.
sleep	The <code>sleep</code> command suspends execution of the script (puts it to 'sleep') for the specified number of seconds. Syntax: <code>sleep <value></code> where <code><value></code> can be a word, a quoted string or a variable reference.
exec	The <code>exec</code> command executes a single CLI command. Currently only CLI 'show' commands may be executed via <code>exec</code> . Syntax: <code>exec <CLI command></code>
send, send_user	The <code>send</code> command sends output to a sub-process, The <code>send_user</code> command sends output to the standard output. Both commands have the same syntax: <code>send <string></code> <code>send_user <string></code> where <code><string></code> can be either a quoted string or a variable reference.
expect, expect_user, expect_before, expect_after, expect_background	The <code>expect</code> command waits for input and attempts to match it against one or more patterns. If one of the patterns matches the input the corresponding (optional) command is executed. All <code>expect</code> commands have the same syntax: <code>expect {<string 1> {command 1} <string 2> {command 2} ... <string n> {command n}}</code> where <code><string x></code> will either be a quoted string, a variable reference or the reserved word 'timeout.' The command <code>x</code> is optional, but the curly braces ('{' and '}') are required. If present it must be a primary command.
return	The <code>return</code> command terminates execution of the script and returns an optional value to the calling environment. Syntax: <code>return <value></code> where <code><value></code> can be a word or a variable reference.

Secondary Commands

These are commands which provide data or other support to the Primary commands. These commands are never used by themselves in a script. The preprocessor will require that these commands always follow a left square bracket ('[') character and be followed on a single line by a right bracket (']').

Table 8-19 Secondary Commands

Command	Description
string	<p>The <code>string</code> command provides a series of string manipulation operations. The <code>string</code> command will only be used with the <code>set</code> command to generate a value for a variable. There are nine operations provided by the <code>string</code> command. Syntax (varies by operation):</p> <pre>string compare <str 1> <str 2> Compare two strings string match <str 1> <str 2> Determine if two strings are equal string first <str needle> <str haystack> Find and return the index of the first occurrence of 'str_needle' in 'str_haystack' string last <str needle> <str haystack> Find and return the index of the last occurrence of 'str_needle' in 'str_haystack' string length <str> Return the length of 'str' string index <str> <int> Return the character located at position 'int' in 'str' string range <str> <int start> <int end> Return a string consisting of the characters in 'str' between 'int start' and 'int end' string tolower <str> Convert <str> to lowercase string toupper <str> Convert <str> to uppercase string trim <str 1> <str 2> Trim 'str 2' from 'str 1' string trimleft <str 1> <str 2> Trim 'str 2' from the beginning of 'str 1' string trimright <str 1> <str 2> Trim 'str 2' from the end of 'str 1'</pre> <p>In each of the above operations, each <code><str *></code> element can either be a quoted string or a variable reference. The <code><int *></code> elements will be either words or variable references.</p>

Command	Description
<code>expr</code>	<p>This command evaluates an arithmetic expression and returns the result. The <code>expr</code> command will only be used in combination with the <code>set</code> command to generate a value for a variable. Syntax:</p> <pre>expr <value> <operation> <value></pre> <p>Each <code><value></code> will be either a word or a variable reference, and <code><operation></code> an arithmetic operation.</p>
<code>timestamp</code>	<p>This command returns the current time of day as determined by the SLC. The <code>timestamp</code> command will only be used in combination with the <code>set</code> command to produce the value for a variable. Syntax:</p> <pre>timestamp <format></pre> <p>where <code><format></code> is a quoted string.</p>
<code>format</code>	<p>The <code>format</code> command is analogous to the C language <code>sprintf()</code>. The <code>format</code> command will only be used in combination with the <code>set</code> command to produce the value for a variable. Syntax:</p> <pre>format <format string> <value 1> <value 2> ... <value n></pre> <p>where <code><format string></code> will be a quoted string. Each of the <code><value x></code> elements will be a word, a quoted string or a variable reference.</p>

Control Flow Commands

The `control flow` commands allow conditional execution of blocks of other commands. The preprocessor treats these as Primary commands, allowing them to appear anywhere in a script that a Primary command is appropriate.

Table 8-20 Control Flow Commands

Command	Description
<code>while</code>	<p>The <code>while</code> command executes an associated block of commands as long as its Boolean expression evaluates to TRUE. After each iteration the Boolean expression is re-evaluated; when the Boolean expression evaluates to FALSE execution passes to the first command following the associated block. Each command within the block must be a Primary command. Syntax:</p> <pre>while {<Boolean expression>} { command 1 command 2 ... command n }</pre>

Command	Description
if, elseif and else	<p>The <code>if</code> command executes an associated block of commands if its Boolean expression evaluates to TRUE. Each command within the block must be a Primary command. Syntax:</p> <pre>if {<Boolean expression>} { command 1 command 2 ... command n }</pre> <p>The <code>elseif</code> command is used in association with an <code>if</code> command - it must immediately follow an <code>if</code> or <code>elseif</code> command. It executes an associated block of commands if its Boolean expression evaluates to TRUE. Each command within the block must be a Primary command. Syntax:</p> <pre>elseif {<Boolean expression>} { command 1 command 2 ... command n }</pre> <p>The <code>else</code> command is used in combination with an <code>if</code> or <code>elseif</code> command to provide a default path of execution. If the Boolean expressions for all preceding <code>if</code> and <code>elseif</code> commands evaluate to FALSE the associated block of commands is executed. Each command within the block must be a primary command. Syntax:</p> <pre>else { command 1 command 2 ... command n }</pre>

Sample Scripts

Interface Script—Monitor Port

The Monitor Port (Monport) script connects directly to a device port by logging into the SLC port, gets the device hostname, loops a couple of times to get port interface statistics, and logs out. The following is the script:

```
set monPort 7
set monTime 5
set sleepTime 2
set prompt ">"
set login "sysadmin"
set pwd "PASS"
#Send CR to echo prompt
send "\r"
sleep $sleepTime
#Log in or check for Command Prompt
```

```

expect {
  #Did not capture "ogin" or Command Prompt
  timeout { send_user "Time out login.....\r\n"; return }
  #Got login prompt
  "login" {
    send_user "Logging in....\r\n"
    send "$login\r"
    expect {
      timeout { send_user "Time out waiting for pwd
        prompt.....\r\n"; return }
      #Got password prompt
      "password" {
#Send Password
send "$pwd\r"
    expect {
      timeout { send_user "Time out waiting for prompt.....\r\n";
        return }
      $prompt {}
    }
  }
}
}
}
#Already Logged in got Command Prompt
$prompt {
send_user "Already Logged....\r\n"
}
}
#Get hostname info
send "show network port 1 host\r"
expect {
  timeout { send_user "Time out Getting Hostname 1\r\n"; return }
  "Domain" {
    #Get Hostname from SLC
    set hostname "[string range $expect_out(buffer) [string first
      Hostname:
      $expect_out(buffer)] [expr [string first Domain
      $expect_out(buffer)]-2]]"
  }
}
}
send_user "\r\n\r\n\r\n\r\n\r\n"
send_user "Device [string toupper $hostname]\r\n"
send_user "_____ \r\n"
send_user "Monitored Port: Port $monPort \r\n"
send_user "Monitor Interval Time: $monTime Seconds \r\n"
set loopCtr 0
set loopMax 2
while { $loopCtr < $loopMax } {
  #Get current time

```

The following is the screen output:

```
slc247glenn]> conn script ex4 deviceport 7
login: Logging in....
sysadmin
sysadmin
Password: PASS
Welcome to the Secure Lantronix Console Manager
Model Number: SLC 48
For a list of commands, type 'help'.
[SLC251glenn]> show network port 1 host
show network port 1 host
____Current Hostname Settings____
Hostname: SLC251glenn
Domain: support.int.lantronix.com
[SLC251glen
Device HOSTNAME: SLC 251GLENN

____
Monitored Port: Port 7
Monitor Interval Time: 5 Seconds
[Current Time:21:16:43]
show portcounter deviceport 7
n]> show portcounter deviceport 7
Device Port: 7 Seconds since zeroed: 1453619
Bytes input: 0 Bytes output: 0
Framing errors: 0 Flow control errors: 0
Overrun errors: 0 Parity errors: 0
[SLC251glenn]>
[Current Time:21:16:58]
show portcounter deviceport 7
show portcounter deviceport 7
Device Port: 7 Seconds since zeroed: 1453634
Bytes input: 0 Bytes output: 0
Framing errors: 0 Flow control errors: 0
Overrun errors: 0 Parity errors: 0
[SLC251glenn]>
Port Counter Monitor Script Ending.....

____
Login Out.....
logout
Returning to command line
[slc247glenn]>
```

Batch Script—SLC CLI

This script runs the following SLC CLI commands, then runs the Monport Interface script:

- ◆ show network port 1 host
- ◆ show deviceport names
- ◆ show script
- ◆ connect script monport deviceport 7

The following is the screen output of the script:

```
[slc247glenn]> se script runcli cli
[slc247glenn]> show network port 1 host
___Current Hostname Settings___
Hostname: slc247glenn
Domain: <none>
[slc247glenn]>
[slc247glenn]> show deviceport names
___Current Device Port Names___
01 - SCS_ALIAS_Test 05 - Port-5
02 - Port-2 06 - Port-6
03 - Port-3 07 - SLC -251
04 - Port-4 08 - Port-8
[slc247glenn]>
[slc247glenn]> show script
___Interface Scripts___Group/Permissions___
getSLC Adm/ad,nt,sv,dt,lu,ra,um,dp,pc,rp,rs,fc,dr,sn,wb,sk,po,do
Test Adm/ad,nt,sv,dt,lu,ra,um,dp,pc,rp,rs,fc,dr,sn,wb,sk,po,do
monport Adm/<none>
___Batch Scripts___Group/Permissions___
cli Adm/ad,nt,sv,dt,lu,ra,um,dp,pc,rs,fc,dr,sn,wb,sk,po,do,rp
[slc247glenn]>
[slc247glenn]> connect script monport deviceport 7
login: Logging in....
sysadmin
sysadmin
Password: PASS
Welcome to the Secure Lantronix Console Manager
Model Number: SLC 48
For a list of commands, type 'help'.
[SLC251glenn]> show network port 1 host
show network port 1 host
___Current Hostname Settings___
Hostname: SLC251glenn
Domain: support.int.
Device HOSTNAME: SLC 251GLENN

Monitored Port: Port 7
Monitor Interval Time: 5 Seconds
[Current Time:21:25:04]
show portcounter deviceport 7
lantronix.com
[SLC251glenn]> show portcounter deviceport 7
Device Port: 7 Seconds since zeroed: 1454120
Bytes input: 0 Bytes output: 0
Framing errors: 0 Flow control errors: 0
Overrun errors: 0 Parity errors: 0
[SLC251glenn]>
[Current Time:21:25:20]
show portcounter deviceport 7
show portcounter deviceport 7
Device Port: 7 Seconds since zeroed: 1454136
Bytes input: 0 Bytes output: 0
```

```
Framing errors: 0 Flow control errors: 0
Overrun errors: 0 Parity errors: 0
[SLC251glenn]>
Port Counter Monitor Script Ending.....
```

```
Login Out.....
```

```
logout
```

```
Returning to command line
```

```
[slcvz249_glenn]> show script
```

```
___Interface Scripts___ Group/Permissions___
```

```
test3 Def/do
```

```
___Batch Scripts___ Group/Permissions___
```

```
test1 Adm/
```

```
ad, nt, sv, dt, lu, ra, um, dp, ub, rs, fc, dr, rp, sn, wb, sk, po, do
```

```
[slcvz249_glenn]>
```

Sites

A site is a group of site-oriented modem parameters that can be activated by various modem-related events (authentication on dial-in, outbound network traffic for a dial-on-demand connection, etc.). The site parameters will override parameters that are configured for a modem.

To use sites with a modem, create one or more sites (described below), then enable **Use Sites** for the modem. Sites can be used with the following modem states: dial-in, dial-back, CBCP Server, dial-on-demand, dial-in & dial-on-demand, and dial-back & dial-on-demand. For more information on how sites are used with each modem state, see [Modem Dialing States on page 178](#).

To add a site:

1. Click the **Devices** tab and select the **Sites** option. The Sites page displays:

Figure 8-21 Devices > Sites

LANTRONIX[®] SLC 8048

Logout Host: slc4331 User: sysadmin

Select port for Configuration WebSSH (DP only) Connected Device (DP only)

Network Services User Authentication Devices Maintenance Quick Setup

Device Status Device Ports Console Port USB / SD Card RPMs Connections Host Lists Scripts Sites

Sites Help ?

Sites		View Site	Delete Site
Id	Name		
0			

Site Id: 0 Reset Site Add Site Edit Site

Site Name:

Port: None Internal Modem Device Port: USB Port U1 USB Port U2

Login/CHAP Host:

CHAP Secret: Retype:

Authentication: PAP CHAP

Timeout Logins: No Yes: minutes

Negotiate IP Address: Yes Local IP: No Remote IP:

Static Route IP Address:

Static Route Subnet Mask:

Static Route Gateway:

Dial-out Number:

Dial-out Login:

Dial-out Password:

Retype Password:

Dial-back Number:

Allow Dial-back:

Dial-back Delay: 15 seconds

Dial-back Retries: 3

Modem Timeout: No Yes: seconds

Restart Delay: 30 seconds

CBCP Server

Allow No Callback:

Enable NAT:

2. In the lower section of the page, enter the following:

Note: To clear fields in the lower part of the page, click the **Reset Site** button.

Site Id (view only)	Displays after a site is created.
Site Name	Enter a name for the site.
Port	Select the port: None , Internal Modem , Device Port , USB Port U1 , or USB Port U2 the site is assigned to. For dial-on-demand sites, a port must be selected. For any other sites, the port selection can be set to None . See Modem Dialing States on page 178 .

Login/CHAP Host	The login name (for PAP authentication) or CHAP host (for CHAP authentication) associated with this site. If a modem has sites enabled and the authentication is successful at dial-in (for modem states dial-in, dial-back, CBCP server, dial-in & dial-on-demand, or dial-back & dial-on-demand), and the name that was authenticated matches the Login/CHAP Host, the site parameters will be used for the remainder of the modem connection.
CHAP Secret/Retype	The CHAP secret associated with this site. If a modem has sites enabled and CHAP authentication enabled, then at dial-in, if the remote server sends a name in the CHAP challenge response that matches the CHAP host of a site, the CHAP secret for the site will be used to authenticate the CHAP challenge response sent by the remote server.
Authentication	The type of authentication, PAP or CHAP , for which this site is applicable. On dial-in authentication, only sites with the authentication type that matches the authentication type configured for the modem will be used to try to find a matching site.
Timeout Logins	For text dial-in connections, the connection can time out after the connection is inactive for a specified number of minutes.
Negotiate IP Address	If the SLC advanced console manager and the remote server should negotiate the IP addresses for each side of the PPP connection, select Yes. Select No if the address of the SLC unit (Local IP) and remote server (Remote IP) need to be specified.
Static Route IP Address	The Static Route IP Address, Subnet Mask and Gateway must be configured for dial-on-demand sites. The SLC 8000 advanced console manager will automatically dial-out and establish a PPP connection when IP traffic destined for the network specified by the static route needs to be sent. <i>Note: Static Routing must be enabled on the Network - Routing page for dial-on-demand connections.</i>
Static Route Subnet Mask	The subnet mask for a dial-on-demand connection.
Static Route Gateway	The gateway for a dial-on-demand connection.
Dial-out Number	The dial-out number must be specified for dial-on-demand sites. This indicates the phone number to dial when the SLC unit needs to send IP traffic for a dial-on-demand connection.
Dial-out Login	User ID for authentication when dialing out to a remote system, or when a remote system requests authentication from the SLC 8000 unit when it dials in. May have up to 32 characters. This ID is used for authenticating the SLC 8000 advanced console manager during the dial-out portion of a dial-back (including CBCP server) and dial-on-demand.
Dial-out Password	Password for authentication when dialing out to a remote system, or if a remote system requests authentication from the SLC unit when it dials in. May have up to 64 characters
Retype Password	Re-enter password for dialing out to a remote system. May have up to 64 characters.
Dial-back Number	The phone number to dial on callback for text or PPP dial-back connections. A site must successfully authenticate, have Allow Dial-back enabled and have a Dial-back Number defined in order for the site to be used for callback.
Allow Dial-back	If enabled, the site is allowed to be used for dial-back connections.
Dial-back Delay	For dial-back and CBCP Server, the number of seconds between the dial-in and dial-out portions of the dialing sequence.
Dial-back Retries	For dial-back and CBCP Server, the number of times the SLC unit will retry the dial-out portion of the dialing sequence if the first attempt to dial-out fails.

Modem Timeout	Timeout for dial-in and dial-on-demand PPP connections. Select Yes (default) for the SLC 8000 advanced console manager to terminate the connection if no traffic is received during the configured idle time. Enter a value of from 1 to 9999 seconds. The default is 30 seconds.
Restart Delay	The number of seconds after the modem timeout and before the SLC unit attempts another connection. The default is 30 seconds.
CBCP Server Allow No Callback	For a CBCP Server site, allows "No Callback" as an option in the CBCP handshake in addition to User-defined Number and Admin-defined Number.
Enable NAT	Select to enable Network Address Translation (NAT) for PPP connections. <i>Note: IP forwarding must be enabled on Network Settings (on page 54) for NAT to work.</i>

3. Click the **Add Site** button.

To view or update a site:

1. In the **Sites** table, select the site and click the **View Site** button. The site attributes are displayed in the bottom half of the page.
2. Update any of the site attributes.
3. Click the **Edit Site** button.

To delete a site:

1. Select the site in the **Sites** table.
2. Click the **Delete Site** button.

Configures a set of site-oriented modem parameters that can be activated by various modem-related events (authentication, outbound network traffic for DOD connections, etc.).

The site parameters will override any parameters configured for the modem.

Uses sites with a modem, enable 'usesites'. Sites can be used with the following modem states: dialin, dialback, cbcpserver, dialondemand, dialin+ondemand, and dialback+ondemand.

To create or edit a site:

```
set site add|edit <Site Name> [<parameters>]
```

Parameters

```
name <Site Name> (edit only)
deviceport <Device Port # or Name or none>
usbport <U1|U2>
internal modem
auth <pap|chap>
loginhost <User Login/CHAP Host>
localipaddr <negotiate|IP Address>
remoteipaddr <negotiate|IP Address>
routeipaddr <IP Address>
routemask <Mask>
routegateway <Gateway>
nat <enable|disable>
dialoutnumber <Phone Number>
dialoutlogin <User Login>
```

```

allowdialback <enable|disable>
dialbacknumber <Phone Number>
dialbackdelay <Dial-back Delay>
dialbackretries <1-10>
timeoutlogins <disable|1-30 minutes>
modemtimeout <disable|1-9999 secs>
restartdelay <PPP Restart Delay>
cbcpnocalback <enable|disable>

```

To set the site password and CHAP secret:

```

set site dialoutpassword <Site Name>
set site chapsecret <Site Name>

```

To add passwords to a site:

```

set site dialoutpassword <Site Name>
set site chapsecret <Site Name>

```

To delete a site:

```

set site delete <Site Name>

```

To display details for all sites, the names of all sites, or details for just one site:

```

show site <all|names|Site Name>

```

Modem Dialing States

This section describes how each modem state that supports sites operates when sites are enabled.

Dial In

The SLC 8000 advanced console manager waits for a peer to call the SLC unit to establish a text (command line) or PPP connection.

- ◆ For text connections, the user will be prompted for a login and password, and will be authenticated via the currently enabled authentication methods (Local Users, NIS, LDAP, etc). The site list will be searched for a site that (a) the **Login/CHAP Host** matches the name that was authenticated, (b) **Authentication** is set to PAP, and (c) the **Port** is set to **None** or matches the port the modem is on. If a matching site is found, the **Timeout Logins** parameter configured for the site will be used for the rest of the dial-in connection instead of the **Timeout Logins** parameter configured for the modem. Once authenticated, a CLI session will be initiated, and the user will remain connected to the SLC 8000 advanced console manager until they either logout of the CLI session, or (if **Timeout Logins** is enabled) the CLI session is terminated if it has been idle.
- ◆ For PPP connections, the user will be authenticated via PAP or CHAP (determined by the **Authentication** setting for the modem). For PAP, the Local/Remote User list will be used to authenticate the login and password sent by the PPP peer, and the site list will be searched for a site that (a) the **Login/CHAP Host** matches the name that was authenticated, (b) **Authentication** is set to PAP, and (c) the **Port** is set to **None** or matches the port the modem is on. For CHAP, the site list will be searched for a site that (a) the **Login/CHAP Host** and

CHAP Secret match the name and secret sent in the CHAP Challenge response by the PPP peer, (b) **Authentication** is set to CHAP, and (c) the **Port** is set to **None** or matches the port the modem is on. If the remote peer requests PAP or CHAP authentication from the SLC unit, the **Remote/Dial-out Login** and **Remote/Dial-out Password** configured for the modem (not the site) will be provided as authentication tokens.

If a matching site is found, its **Negotiate IP Address**, **NAT**, and **Modem Timeout** parameters will be used for the rest of the dial-in connection instead of the parameters configured for the modem. Once authenticated, a PPP session will be established using either negotiated IP addresses or specific IP addresses (determined by the **Negotiate IP Address** setting). The PPP connection will stay active until no IP traffic is sent for **Modem Timeout** seconds.

Dial-back

The SLC advanced console manager waits for a peer to call the SLC unit, establishes a text (command line) or PPP connection, authenticates the user, and if the SLC 8000 advanced console manager is able to determine a dial-back number to use, hangs up and calls the dial-back number to establish either a text or PPP connection.

- ◆ For text connections, the user will be prompted for a login and password, and will be authenticated via the currently enabled authentication methods (Local Users, NIS, LDAP, etc). The site list will be searched for a site that (a) the **Login/CHAP Host** matches the name that was authenticated, (b) **Authentication** is set to PAP, and (c) the **Port** is set to **None** or matches the port the modem is on.
If a matching site is found, its **Timeout Logins**, **Dial-back Number**, **Allow Dial-back**, and **Dial-back Delay** parameters will be used for the rest of the dial-back connection instead of the parameters configured for the modem. Once the remote server is authenticated, if **Allow Dial-back** is enabled for the site and a **Dial-back Number** is defined, the SLC unit will hang up and wait **Dial-back Delay** seconds before initiating the dial-back. The SLC 8000 advanced console manager will dial, prompt the user again for a login and password, and a CLI session will be initiated. The user will remain connected to the SLC unit until they either logout of the CLI session, or (if **Timeout Logins** is enabled) the CLI session is terminated if it has been idle.
- ◆ For PPP connections, the user will be authenticated via PAP or CHAP (determined by the **Authentication** setting for the modem). For PAP, the Local/Remote User list will be used to authenticate the login and password sent by the PPP peer, and the site list will be searched for a site that (a) the **Login/CHAP Host** matches the name that was authenticated, (b) **Authentication** is set to PAP, and (c) the **Port** is set to **None** or matches the port the modem is on. For CHAP, the site list will be searched for a site that (a) the **Login/CHAP Host** and **CHAP Secret** match the name and secret sent in the CHAP Challenge response by the PPP peer, (b) **Authentication** is set to CHAP, and (c) the **Port** is set to **None** or matches the port the modem is on. If the remote peer requests PAP or CHAP authentication from the SLC 8000 advanced console manager, the **Remote/Dial-out Login** and **Remote/Dial-out Password** configured for the modem (not the site) will be provided as authentication tokens.
If a matching site is found, its **Dial-back Number**, **Allow Dial-back**, **Dial-back Delay**, **Dial-out Login**, **Dial-out Password**, **Negotiate IP Address**, **NAT**, and **Modem Timeout** parameters will be used for the rest of the dial-back connection instead of the parameters configured for the modem. Once the remote server is authenticated, if **Allow Dial-back** is enabled for the site and a **Dial-back Number** is defined, the SLC unit will hang up and wait **Dial-back Delay** seconds before initiating the dial-back. The SLC 8000 advanced console manager will dial, and if the remote peer requests PAP or CHAP authentication, provide the **Dial-out Login** and **Dial-out Password** as authentication tokens. Once authenticated, a PPP session will be established using either negotiated IP addresses or specific IP addresses (determined by the **Negotiate IP Address** setting).

Dial-on-demand

The SLC unit automatically dial outs and establishes a PPP connection when IP traffic destined for a remote network needs to be sent. It will remain connected until no data packets have been sent to the peer for a specified amount of time.

When this modem state is initiated, the SLC 8000 advanced console manager searches the site list for all sites that (a) have a **Dial-out Number** defined, (b) have a **Static Route IP Address**, **Static Route Subnet Mask** and **Static Route Gateway** defined, and (c) the **Port** matches the port the modem is on. A dial-on-demand connection will be started for each, waiting for IP traffic destined for a remote network.

When IP traffic needs to be sent, the SLC unit dials the appropriate **Dial-out Number** for the site, and if the remote peer requests PAP or CHAP authentication, provides the **Dial-out Login** and **Dial-out Password** as authentication tokens. Once authenticated, a PPP session will be established using either negotiated IP addresses or specific IP addresses (determined by the **Negotiate IP Address** setting). The PPP connection will stay active until no IP traffic is sent for **Modem Timeout** seconds. Once the timeout has expired, the PPP connection will be terminated and will not be reestablished for at least **Restart Delay** seconds.

Dial-in & Dial-on-demand

A modem is configured to be in two modes: answering incoming calls to establish a PPP connection, and automatically dialing out to establish a PPP connection when IP traffic destined for a remote network needs to be sent. When either event occurs (an incoming call or IP traffic destined for the remote network), the other mode will be disabled.

- ◆ For Dial-in, the user will be authenticated via PAP or CHAP (determined by the **Authentication** setting for the modem). For PAP, the Local/Remote User list will be used to authenticate the login and password sent by the PPP peer, and the site list will be searched for a site that (a) the **Login/CHAP Host** matches the name that was authenticated, (b) **Authentication** is set to PAP, and (c) the **Port** is set to **None** or matches the port the modem is on. For CHAP, the site list will be searched for a site that (a) the **Login/CHAP Host** and **CHAP Secret** match the name and secret sent in the CHAP Challenge response by the PPP peer, (b) **Authentication** is set to CHAP, and (c) the **Port** is set to **None** or matches the port the modem is on. If the remote peer requests PAP or CHAP authentication from the SLC advanced console manager, the **Remote/Dial-out Login** and **Remote/Dial-out Password** configured for the modem (not the site) will be provided as authentication tokens. If a matching site is found, its **Negotiate IP Address**, **NAT**, and **Modem Timeout** parameters will be used for the rest of the dial-in connection instead of the parameters configured for the modem. Once authenticated, a PPP session will be established using either negotiated IP addresses or specific IP addresses (determined by the **Negotiate IP Address** setting). The PPP connection will stay active until no IP traffic is sent for **Modem Timeout** seconds.
- ◆ For Dial-on-Demand, the SLC unit searches the site list for all sites that (a) have a **Dial-out Number** defined, (b) have a **Static Route IP Address**, **Static Route Subnet Mask** and **Static Route Gateway** defined, and (c) the **Port** matches the port the modem is on. A dial-on-demand connection will be started for each, waiting for IP traffic destined for a remote network. When IP traffic needs to be sent, the SLC 8000 advanced console manager dials the appropriate **Dial-out Number** for the site, and if the remote peer requests PAP or CHAP authentication, provides the **Dial-out Login** and **Dial-out Password** as authentication tokens. Once authenticated, a PPP session will be established using either negotiated IP addresses or specific IP addresses (determined by the **Negotiate IP Address** setting). The PPP connection will stay active until no IP traffic is sent for **Modem Timeout** seconds. Once the timeout has expired, the PPP connection will be terminated and will not be reestablished for at least **Restart Delay** seconds.

Dial-back & Dial-on-demand

A modem is configured to be in two modes: answering incoming calls to initiate a dial-back, and automatically dialing out to establish a PPP connection when IP traffic destined for a remote network needs to be sent. When either event occurs (an incoming call or IP traffic destined for the remote network), the other mode will be disabled.

- ◆ For Dial-back, the user will be authenticated via PAP or CHAP (determined by the **Authentication** setting for the modem). For PAP, the Local/Remote User list will be used to authenticate the login and password sent by the PPP peer, and the site list will be searched for a site that (a) the **Login/CHAP Host** matches the name that was authenticated, (b) **Authentication** is set to PAP, and (c) the **Port** is set to **None** or matches the port the modem is on. For CHAP, the site list will be searched for a site that (a) the **Login/CHAP Host** and **CHAP Secret** match the name and secret sent in the CHAP Challenge response by the PPP peer, (b) **Authentication** is set to CHAP, and (c) the **Port** is set to **None** or matches the port the modem is on. If the remote peer requests PAP or CHAP authentication from the SLC unit, the **Remote/Dial-out Login** and **Remote/Dial-out Password** configured for the modem (not the site) will be provided as authentication tokens. If a matching site is found, its **Dial-back Number**, **Allow Dial-back**, **Dial-back Delay**, **Dial-out Login**, **Dial-out Password**, **Negotiate IP Address**, **NAT**, and **Modem Timeout** parameters will be used for the rest of the dial-back connection instead of the parameters configured for the modem. Once the remote server is authenticated, if **Allow Dial-back** is enabled for the site and a **Dial-back Number** is defined, the SLC 8000 advanced console manager will hang up and wait **Dial-back Delay** seconds before initiating the dial-back. The SLC unit will dial, and if the remote peer requests PAP or CHAP authentication, provide the **Dial-out Login** and **Dial-out Password** as authentication tokens. Once authenticated, a PPP session will be established using either negotiated IP addresses or specific IP addresses (determined by the **Negotiate IP Address** setting).
- ◆ For Dial-on-Demand, the SLC 8000 advanced console manager searches the site list for all sites that (a) have a **Dial-out Number** defined, (b) have a **Static Route IP Address**, **Static Route Subnet Mask** and **Static Route Gateway** defined, and (c) the **Port** matches the port the modem is on. A dial-on-demand connection will be started for each, waiting for IP traffic destined for a remote network. When IP traffic needs to be sent, the SLC unit dials the appropriate **Dial-out Number** for the site, and if the remote peer requests PAP or CHAP authentication, provides the **Dial-out Login** and **Dial-out Password** as authentication tokens. Once authenticated, a PPP session will be established using either negotiated IP addresses or specific IP addresses (determined by the **Negotiate IP Address** setting). The PPP connection will stay active until no IP traffic is sent for **Modem Timeout** seconds. Once the timeout has expired, the PPP connection will be terminated and will not be reestablished for at least **Restart Delay** seconds.

CBCP Server and CBCP Client

Callback Control Protocol (CBCP) is a PPP option that negotiates the use of callback where the server, after authenticating the client, terminates the connection and calls the client back at a phone number that is determined by the CBCP handshake. For more information on CBCP, see <http://technet.microsoft.com/en-us/library/cc957979.aspx>. CBCP is used primarily by Microsoft PPP peers. CBCP supports two options for determining the number to dial on callback: the client can specify a user-defined number for the server to dial on callback, or the client can request the server use an administrator-defined number to dial on callback. Optionally, some servers may also allow "no callback" as an option.

CBCP Server

The SLC 8000 advanced console manager waits for a client to call the SLC unit, establishes a PPP connection, authenticates the user, and negotiates a dial-back number with the client using CBCP. If the SLC 8000 advanced console manager is able to determine a dial-back number to use, it hangs up and calls the dial-back number.

When a call is received, a PPP connection is established, and the user will be authenticated via PAP or CHAP (configured with the **Authentication** setting). For PAP, the Local/Remote list will be used to authenticate the login and password sent by the PPP peer. For CHAP, the **CHAP Handshake Host/User Name** and **Secret/User Password** will be used to authenticate CHAP Challenge response sent by the PPP peer. If the remote peer requests PAP or CHAP authentication from the SLC unit, the **Remote/Dial-out Login** and **Remote/Dial-out Password** will be provided as authentication tokens. Once authenticated, the CBCP handshake with the client determines the number to use for dial-back. The SLC unit will present the client with the available options: if the authenticated user is a Local/Remote User with **Allow Dial-back** enabled and a Dial-back Number defined, the administrator-defined option is allowed; if this is not the case, the user-defined number is allowed. Additionally, if **CBCP Server Allow No Callback** is enabled, the client can also select no callback (the PPP connection established at dial-in will remain up). The client will select from the available callback options. If the SLC unit can determine a dial-back number to use, it will hang up and wait **Dial-back Delay** seconds before initiating the dial-back (if the dial-back fails, the SLC will try **Dial-back Retries** times to dial-back). The SLC unit will call back the previously authenticated remote peer, and if the remote peer requests PAP or CHAP authentication, provide the **Remote/Dial-out Login** and **Remote/Dial-out Password** as authentication tokens. Once authenticated, a PPP session will be established using either negotiated IP addresses or specific IP addresses (determined by the **Negotiate IP Address** setting).

CBCP Client

The SLC unit will dial out to a CBCP server, establish a PPP connection, negotiate a callback number with the server using CBCP, terminate the connection, and wait for the server to call back. The SLC unit dials the **Dial-out Number**, and if the remote peer requests PAP or CHAP authentication, provides the **Remote/Dial-out Login** and **Remote/Dial-out Password** as authentication tokens. Once authenticated, the CBCP handshake with the server determines the number to use for dial-back. The SLC device will request the type of number defined by **CBCP Client Type** - either an Admin-defined Number (the CBCP server determines the number to call) or a User-defined Number (the SLC unit will provide the **Fixed Dial-back Number** as the number to call). If the CBCP handshake is successful, the SLC unit will terminate the PPP connection, hang up, and wait for the server to dial back. When the remote server calls back the SLC unit and the PPP connection is established, the user will be authenticated via PAP or CHAP (configured with the **Authentication** setting). For PAP, the Local/Remote list will be used to authenticate the login and password sent by the PPP peer. For CHAP, the **CHAP Handshake Host/User Name** and **Secret/User Password** will be used to authenticate CHAP Challenge response sent by the PPP peer. Once authenticated, a PPP session will be established using either negotiated IP addresses or specific IP addresses (determined by the **Negotiate IP Address** setting).

Notes:

- ◆ *In a state where the modem will be answering a call, the modem should always be configured for manual answer, not auto answer.*
- ◆ *When answering a call, the SLC unit answers after the 2nd ring.*
- ◆ *Any text or PPP connection can be terminated by setting the modem state to disabled.*

Key Sequences

The default values for the various key sequences (Escape Sequence, Break Sequence, View Port Log Sequence, Power Menu Sequence) are set to different key sequences, and it is recommended that they always be set to different key sequences so that the SLC can properly handle each of the functions accessed by the key sequence while connected to a device.

For example, if the View Port Log Sequence is set to the same sequence as the Power Menu Sequence, and this sequence is typed while connected to a device port, both the Power Menu and the option to display Port Log will be displayed, with the Power Menu taking precedence and processing user input.

If any of the key sequences are set to the same value, the precedence used to process the key sequences is:

- ◆ Escape Sequence
- ◆ Power Management Sequence
- ◆ View Port Log Sequence

It is also recommended that the key sequences not share a significant amount of overlap other than the first character. For example, if the View Port Log Sequence is set to **ABCD** and the Power Management Sequence is set to **ABCE**, the first three characters of both sequences are the same - this is not recommended.

When any portion of key sequences overlap, typing a complete escape sequence for one of the sequences will reset recognition of the other sequences back to the beginning of the key sequence. For example, with the default View Port Log sequence of **ESC-V** and the default Power Management sequence of **ESC-P**, if the user types "ESC-V" and views the port log and then returns to interacting with the device, they need to type "ESC-P" to view the Power Menu, and not just "P".

When detecting key sequences, after receiving the first character(s) of a sequence, the SLC will wait 3 or more seconds for the remaining characters, before timing out and sending all characters to the device. For example, if the Escape Sequence is **ABCD**, and the user types "AB", the SLC will wait at least 3 seconds for the next character ("C") before timing out and sending the "AB" characters to the device.

9: USB/SD Card Port

This chapter describes how to configure storage by using the [Devices > USB / SD Card](#) page and CLI. This page can be used to configure the thumb drive and modems. The thumb drive or SD card is useful for firmware updates, saving and restoring configurations and for device port logging. See [Firmware & Configurations \(on page 271\)](#).

The SLC advanced console manager supports a variety of thumb drives.

This chapter describes the Web Manager pages and available CLI commands that configure the SLC USB, ports and SD card. This chapter contains the following sections:

- ◆ [Set Up of USB/SD Card Storage](#)
- ◆ [Manage Files](#)
- ◆ [USB Commands](#)

Set Up of USB/SD Card Storage

The [Devices > USB / SD Card](#) page has a checkbox for both USB Access and SD card access. These checkboxes are a security feature to ensure that access to any USB device or the SD card is disabled if the box is unchecked. If unchecked, the SLC unit ignores any device plugged into the port.

To set up USB or SD card storage in the SLC 8000 advanced console manager:

1. Insert any of the supported storage devices into the USB port or the SD card slot on the front of the SLC unit. You can do this before or after powering up the SLC 8000 advanced console manager. If the first partition on the storage device is formatted with a file system supported by the SLC unit (ext2, FAT16 and FAT32), the card mounts automatically.
2. Log into the SLC unit and click **Devices**.
3. Click **USB / SD Card**. [Figure 9-1](#) shows the page that displays. Your storage device should display in the appropriate row of the USB ports / SD card table if you have inserted it. If it does not display and you have inserted it, refresh the web page.
4. View the USB/SD card information and options available on the page:

Port (view only)	Port on the SLC unit where the USB device or SD card is inserted.
Device (view only)	Type of USB device or SD card (modem or storage).
Type (view only)	Information read from USB device or SD card.
State (view only)	Indicates if the device is mounted, and if mounted, how much space is available.
USB Access (check box)	Check to enable USB Access . Uncheck to disable USB access.
SD Card Access (check box)	Check to enable SD Card Access . Uncheck to disable SD card access.

Figure 9-1 Devices > USB / SD Card

LANTRONIX[®] SLC 8048

Logout Host: slc48250120-740B4 User: sysadmin

Select port for Configuration WebSSH (DP only) Connected Device (DP only)

Network Services User Authentication **Devices** Maintenance Quick Setup

Device Status Device Ports Console Port **USB / SD Card** Internal Modem RPMs Connections Host Lists Scripts Sites

USB / SD Card Help?

Port	Device	Type	State	
U1	modem	U.S. Robotics	inserted	<input type="radio"/>
U2	storage	Chipsbank Microelectronics Co., Ltd CBM2080 Flash drive controller	fat32, mounted, Size/Used/Avail 31.2M/122.0K/31.1M	<input type="radio"/>
SD	storage	256MB	ext2, mounted, Size/Used/Avail 234.0M/2.2M/219.7M	<input type="radio"/>

[USB Devices](#)

If a USB device or SD Card has been inserted but is not visible in the table, please refresh the web page.

To configure the settings for a USB device or SD Card, select the radio button in the right column.

USB Access:
SD Card Access:

To configure a USB/SD card storage port, from the USB Ports / SD Card table,

1. Click the radio button (on the far right) of a USB or SD card device storage port.
2. Click **Configure**.
 - [Figure 9-2](#) shows the page that displays if a USB storage device is inserted.
 - [Figure 9-3](#) shows the page that displays if an SD Card is inserted.

Figure 9-2 Devices > SD Card > Configure

LANTRONIX[®] SLC 8048

Logout Host: slc4331 User: sysadmin

Select port for Configuration WebSSH (DP only) Connected Device (DP only)

Network Services User Authentication **Devices** Maintenance Quick Setup

Device Status Device Ports Console Port **USB / SD Card** RPMs Connections Host Lists Scripts Sites

USB / SD Card - Storage Help?

Port: **SD** Mount:

Device: **Storage** Unmount:

Type: **256MB** Format:

State: **ext2, mounted, Size/Used/Avail 234.0M/2.2M/219.7M** Filesystem: Ext2 FAT16 FAT32

Filesystem Check:

[Manage Files on Storage Device](#)

Figure 9-3 Devices > USB > Configure

The screenshot shows the LANTRONIX SLC 8048 web interface. At the top, there is a navigation menu with options: Network, Services, User Authentication, Devices (selected), Maintenance, and Quick Setup. Below the menu, there are links for Device Status, Device Ports, Console Port, USB / SD Card (selected), RPMs, Connections, Host Lists, Scripts, and Sites. The main content area is titled "USB / SD Card - Storage" and includes a "Help?" link. The configuration options are as follows:

- Port: U1 (selected)
- Device: Storage
- Type: Toshiba Corp. Kingston DataTraveler 2.0 Stick (2GB)
- State: fat32, mounted, Size/Used/Avail 14.4G/167.7M/14.3G
- Mount:
- Unmount:
- Format:
- Filesystem: Ext2 FAT16 FAT32
- Filesystem Check:
- [Manage Files on Storage Device](#)
-

3. Enter the following fields.

Mount	Select the checkbox to mount the first partition of the storage device on the SLC unit (if not currently mounted). Once mounted, a USB thumb drive or SD card is used for firmware updates, device port logging and saving/restoring configurations.
Unmount	To eject the USB thumb drive or SD card from the SLC unit , first unmount the thumb drive or SD card . Select the checkbox to unmount it. Warning: <i>If you eject a thumb drive or SD card from the SLC unit without unmounting it, subsequent mounts of a USB thumb drive or SD card in may fail, and you will need to reboot the device to restore thumb drive or SD card functionality.</i>
Format	Select to: <ul style="list-style-type: none"> ◆ Unmount the USB/SD card device (if it is mounted) ◆ Remove all existing partitions ◆ Create one partition ◆ Format it with the selected file system (ext2, FAT16 or FAT32) ◆ Mount the USB device
Filesystem	Select Ext2 , FAT16 or FAT32 , the filesystems the SLC supports.
Filesystem Check	Select to run a filesystem integrity check on the thumb drive. This is recommended if the filesystem does not mount or if the filesystem has errors.

4. Click **Apply**.
5. Click the **Manage Files on Storage Device** link to view and manage files on the selected USB thumb drive or SD Card. Files on the storage device may then be deleted, downloaded or renamed. See [Manage Files on page 191](#) for more information.

To configure the USB Modem port, from the USB Ports table:

1. Click the radio button (on the far right) for Port U1 or U2.
2. Click **Configure**. [Figure 9-4](#) shows the page that displays if a USB modem is inserted in Port U1, or if Port U2 is selected.

Figure 9-4 Devices > USB > Modem

LANTRONIX[®] SLC 8048

Logout Host: slc4331 User: sysadmin

Select port for Configuration WebSSH (DP only) Connected Device (DP only)

Network Services User Authentication **Devices** Maintenance Quick Setup

Device Status Device Ports Console Port USB / SD Card **RPMs** Connections Host Lists Scripts Sites

USB - Modem Help?

Port: U1 State: Dial-in [View Modem Log](#)

Device: Modem Mode: Text PPP PPP Logging:

Type: Hitachi, Ltd Use Sites: PPP Debug:

State: N/A Group Access:

Initialization Script: ATE1V1x4QOM0

Modem Timeout: No Yes, seconds (1-9999):

Caller ID Logging: Modem Command:

Dial-back Number: Local User Number Fixed Number:

Dial-back Delay: 15 seconds

Dial-back Retries: 3

Text Mode

Timeout Logins: No Yes, minutes (1-30):

Dial-in Host List: undefined [Host Lists](#)

PPP Mode

Negotiate IP Address: Yes Local IP: 12.1.1.1 No Remote IP: 12.1.1.2

Authentication: PAP CHAP

Host/User Name:

CHAP Handshake: Secret/User Password: Retype Password:

CHAP Auth Uses: CHAP Host Local Users

Same authentication for Dial-in & Dial-on-Demand (DOD):

DOD Authentication: PAP CHAP

Host/User Name:

DOD CHAP Handshake: Secret/User Password: Retype Password:

Enable NAT: **Note:** Enabling NAT requires [IP Forwarding](#) to be enabled.

Dial-out Number:

Remote/Dial-out Login:

Remote/Dial-out Pwd: Retype:

Restart Delay: 30 seconds

CBCP Server

Allow No Callback:

CBCP Client Type: Admin-defined Number User-defined Number

IP Settings

Service: None Telnet SSH TCP

Telnet Port: 2049 Authenticate:

SSH Port: 3049 Authenticate:

TCP Port: 4049 Authenticate:

3. Enter the following fields.

Data Settings

Note: Check the modem's equipment settings and documentation for the proper settings. The attached modem must have the same settings.

Baud	The speed with which the device port exchanges data with the attached serial device. From the drop-down list, select the baud rate. Most devices use 9600 for the administration port, so the device port defaults to this value. Check the equipment settings and documentation for the proper baud rate. Note: Cypress ACM-based USB to serial chip set does not support 230400 baud rate.
Data Bits	Number of data bits used to transmit a character. From the drop-down list, select the number of data bits. The default is 8 data bits.
Parity	Parity checking is a rudimentary method of detecting simple, single-bit errors. From the drop-down list, select the parity. The default is none .
Stop Bits	The number of stop bit(s) used to indicate that a byte of data has been transmitted. From the drop-down list, select the number of stop bits. The default is 1 .
Flow Control	A method of preventing buffer overflow and loss of data. The available methods include none , xon/xoff (software), and rts/cts (hardware). The default is none .

Modem Settings

Note: Depending on the **State** and **Mode** you select, different fields are available.

State	Indicates whether an external modem is attached to the device port. If enabling, set the modem to dial-out, dial-in, dial-back, dial-on-demand, dial-in/host list, or dial in, dial-on-demand, CBCP Server, and CBCP Client. Disabled by default. See Modem Dialing States (on page 178) for more information.
Mode	The format in which the data flows back and forth: <ul style="list-style-type: none"> ◆ Text: In this mode, the SLC unit assumes that the modem will be used for remotely logging into the command line. Text mode can only be used for dialing in or dialing back. Text is the default. ◆ PPP: This mode establishes an IP-based link over the modem. PPP connections can be used in dial-out mode (e.g., the SLC 8000 advanced console manager connects to an external network), dial-in mode (e.g., the external computer connects to the network that the SLC unit is part of), or dial-on-demand.
Use Sites	Enables the use of site-oriented modem parameters which can be activated by various modem-related events (authentication, outbound network traffic for dial-on-demand connections, etc.). Sites can be used with the following modem states: dial-in, dial-back, dial-on-demand, dial-in & dial-on-demand, dial-back & dial-on-demand, and CBCP server.

Group Access	If undefined, any group can access the modem (text login only). If one or more groups are specified (groups are delimited by the characters ' ' (space), ',' (comma), or ';' (semicolon)), then any user who logs into the modem must be a member of one of the specified groups, otherwise access will be denied. Users authenticated via RADIUS may have a group (or groups) provided by the RADIUS server via the Filter-Id attribute that overrides the group defined for a user on the SLC 8000 advanced console manager. A group provided by a remote server must be either a single group or multiple groups delimited by the characters ' ' (space), ',' (comma), ';' (semicolon), or '=' (equals) - for example "group=group1,group2;" or "group1,group2,group3".
Initialization Script	Commands sent to configure the modem may have up to 100 characters. Consult your modem's documentation for recommended initialization options. If you do not specify an initialization script, the SLC unit uses a default initialization string of <code>AT S7=45 SO=0 L1 V1 X4 &D2 &c1 E1 Q0</code> . <i>Note: We recommend that the modem initialization script always be preceded with AT and include E1 V1 x4 Q0 so that the SLC unit may properly control the modem.</i>
Modem Timeout	Timeout for all modem connections. Select Yes (default) for the SLC 8000 advanced console manager to terminate the connection if no traffic is received during the configured idle time. Enter a value of from 1 to 9999 seconds. The default is 30 seconds.
Caller ID Logging	Select to enable the SLC unit to log caller IDs on incoming calls. Disabled by default. <i>Note: For the Caller ID AT command, refer to the modem user guide.</i>
Modem Command	Modem AT command used to initiate caller ID logging by the modem. <i>Note: For the AT command, refer to the modem user guide.</i>
Dial-back Number	Users with dial-back access can dial into the SLC 8000 advanced console manager and enter their login and password. Once the SLC unit authenticates them, the modem hangs up and dials them back. Select the phone number the modem dials back on -a fixed number or a number associated with their login. If you select Fixed Number , enter the number (in the format 2123456789). The dial-back number is also used for CBCP client as the number for a user-defined number. See Device Ports - Settings (on page 123) for more information.
Dial-back Delay	For dial-back and CBCP Server, the number of seconds between the dial-in and dial-out portions of the dialing sequence.
Dial-back Retries	Specify the number of times to retry dialing back.

Text Mode

Timeout Logins	If you selected Text mode, you can enable logins to time out after the connection is inactive for a specified number of minutes. The default is No . This setting is only applicable for text mode connections. PPP mode connections stay connected until either side drops the connection. Disabled by default.
Dial-in Host List	From the drop-down list, select the desired host list. The host list is a prioritized list of SSH, Telnet, and TCP hosts that are available for establishing outgoing modem connections or for connect direct at the CLI. The hosts in the list are cycled through until the SLC unit successfully connects to one. To establish and configure host lists, click the Host Lists link.

PPP Mode

Negotiate IP Address	If the SLC unit and/or the serial device have dynamic IP addresses (e.g., IP addresses assigned by a DHCP server), select Yes . Yes is the default. If the SLC unit or the modem have fixed IP addresses, select No , and enter the Local IP (IP address of the port) and Remote IP (IP address of the modem).
Authentication	Enables PAP or CHAP authentication for modem logins. PAP is the default. With PAP, users are authenticated by means of the Local Users and any of the remote authentication methods that are enabled. With CHAP, the CHAP Handshake fields authenticate the user.
CHAP Handshake	The Host/User Name (for UNIX systems) or Secret/User Password (for Windows systems) used for CHAP authentication. May have up to 128 characters.
CHAP Auth Uses	For CHAP authentication, determines what is used to validate the CHAP Host and Chap Local host/user sent by the remote peer: either the CHAP Host defined for the modem, or any of the users in the Local Users list.
Same authentication for Dial-in & Dial-on-Demand (DOD)	Select this option to let incoming connections (dial-in) use the same authentication settings as outgoing connections (dial-on-demand). If this option is not selected, then the dial-on-demand connections take their authentication settings from the DOD parameter settings. If DOD Authentication is PAP , then the DOD CHAP Handshake field is not used.
DOD Authentication	Enables PAP or CHAP authentication for dial-in & dial-on-demand. PAP is the default. With PAP, users are authenticated by means of the Local Users and any of the remote authentication methods that are enabled. With CHAP, the DOD CHAP Handshake fields authenticate the user.
DOD CHAP Handshake	For DOD Authentication , enter the Host/User Name for UNIX systems) or Secret/User Password (for Windows systems) used for CHAP authentication. May have up to 128 characters.
Enable NAT	Select to enable Network Address Translation (NAT) for dial-in and dial-out PPP connections on a per modem (device port or USB port) basis. Users dialing into the SLC access the network connected to Eth1 and/or Eth2. Note: IP forwarding must be enabled on the Network > Network Settings page for NAT to work. See Chapter 6: Basic Parameters on page 66 .
Dial-out Number	Phone number for dialing out to a remote system or serial device. May have up to 20 characters. Any format is acceptable.
Remote/Dial-out Login	User ID for authentication when dialing out to a remote system, or if a remote system requests authentication from the SLC device when it dials in. May have up to 32 characters. This ID is used for authenticating the SLC unit during the dial-out portion of a dial-back (including CBCP server) and dial-on-demand.
Remote/Dial-out Pwd	Password for authentication when dialing out to a remote system, or if a remote system requests authentication from the SLC unit when it dials in. May have up to 64 characters.
Retype	Re-enter password for dialing out to a remote system. May have up to 64 characters.
Restart Delay	The number of seconds after the timeout and before the SLC 8000 advanced console manager attempts another connection. The default is 30 seconds.
CBCP Server Allow No Callback	For CBCP Server state, allows "No Callback" as an option in the CBCP handshake in addition to User-defined Number and Admin-defined Number.
CBCP Client Type	For CBCP Client, this selects the number that the client would like to use for callback - either a user-defined number passed to the server (specified by the Fixed Dial-back Number) or an administrator-defined number determined by the server based on the login that is PAP or CHAP authenticated.

IP Settings

Service	The available connection services for this modem port (None , Telnet , SSH , or TCP). Only one can be active at a time. The default is None .
Telnet Port	Telnet Port Telnet session port number to use if you selected Telnet. Defaults: <ul style="list-style-type: none"> ◆ USB Port U1: 2049 ◆ USB Port U2: 2050 ◆ Range: 1025-65535
SSH Port	The SSH session port number to use if you selected SSH. Defaults: <ul style="list-style-type: none"> ◆ USB Port U1: 3049 ◆ USB Port U2: 3050 ◆ Range: 1025-65535
TCP Port	The TCP (raw) session port number to use if you selected TCP. Defaults: <ul style="list-style-type: none"> ◆ USB Port U1: 4049 ◆ USB Port U2: 4050 ◆ Range: 1025-65535
Authenticate (checkbox)	If selected, the SLC unit requires user authentication before granting access to the port. Authenticate is selected by default for Telnet Port and SSH Port , but not for TCP Port .

4. Click **Apply**.

Manage Files

To manage files, perform the following steps.

1. Click the **Manage Files on the Storage Device** link on the [Devices > USB > Configure](#) page.

Figure 9-5 Firmware and Configurations - Manage Files

The screenshot shows the LANTRONIX SLC 8048 web interface. At the top, there is a navigation bar with tabs for Network, Services, User Authentication, Devices, Maintenance, and Quick Setup. Below this, there are links for Device Status, Device Ports, Console Port, USB / SD Card, RPMs, Connections, Host Lists, Scripts, and Sites. The main heading is 'Firmware & Configurations - Manage Files'. A 'Back to USB / SD Card - Storage' link is visible. The main content area shows a table titled 'Files - USB Port U1' with the following data:

Name	Date/Time Saved	SSH Keys	SSL Certificate	Scripts	
slccpy-slccfg.tgz	04/13/16 23:43:18	N	N	N	<input type="checkbox"/>
apassslc48Ref-120-slccfg.tgz	04/14/16 08:55:08	Y	Y	Y	<input type="checkbox"/>
slcRef48120_73R5-slccfg.tgz	04/14/16 09:04:32	Y	Y	Y	<input type="checkbox"/>
SLC-UPDATE-7.2.0.0R20.rom	06/25/15 07:33:58	N/A	N/A	N/A	<input type="checkbox"/>
rootfs.ubifs	06/25/15 07:11:08	N/A	N/A	N/A	<input type="checkbox"/>

Note: The **Delete**, **Download**, and **Rename** options are at the bottom of the page ([Figure 9-5](#)).

2. To delete a file, click the check box next to the filename and click **Delete File**. A confirmation message displays.
3. To download a file, click the **Download File** button. Select the file from the list.
4. To rename a file, click the check box next to the filename and enter a new name in the **New File Name** field.
5. Click **Rename File**.

USB Commands

The following CLI commands correspond to the USB port. For more information, see [Chapter 15: Command Reference on page 308](#).

- ◆ set usb access
- ◆ set usb modem
- ◆ set usb storage mount
- ◆ set usb storage unmount
- ◆ set usb storage dir
- ◆ set usb storage rename
- ◆ set usb storage copy
- ◆ set usb storage delete
- ◆ set usb storage format
- ◆ set usb storage fsck
- ◆ show usb
- ◆ show usb storage
- ◆ show usb modem
- ◆ show usb devices

SD Card Commands

The following CLI commands correspond to the SD Card. For more information, see [Chapter 15: Command Reference on page 308](#).

- ◆ set sdcard access
- ◆ set sdcard mount
- ◆ set sdcard unmount
- ◆ set sdcard format
- ◆ set sdcard fsck
- ◆ set sdcard dir
- ◆ set sdcard rename
- ◆ set sdcard copy
- ◆ set sdcard delete
- ◆ show sdcard

10: Remote Power Managers

The SLC supports managing remote power managers (RPMs) for devices from over 140 vendors. The RPMs can be either PDUs or UPSes, and can be managed via SNMP, serial port, network and USB connections. The RPMs web page displays a list of all currently managed RPMs with an overview of their current status, with options to control and view detailed status for each RPM, depending on its supported capabilities.

Network and SNMP managed RPMs are disabled in FIPS mode. The only action that can be performed on a network or SNMP managed RPM in FIPS mode is that it can be deleted via the CLI.

For notes on optimizing the management of specific devices, see [Optimizing and Troubleshooting RPM Behavior \(on page 205\)](#).

Devices - RPMs

To control or view status for an RPM:

1. Click the **Devices** tab and select the **RPMs** option. The RPMs page displays.

Figure 10-1 Devices > RPMs

The screenshot shows the LANTRONIX SLC 8048 web interface. At the top, there is a navigation bar with tabs for Network, Services, User Authentication, Devices, Maintenance, and Quick Setup. Below this, there are sub-tabs for Device Status, Device Ports, Console Port, USB / SD Card, Internal Modem, RPMs, Connections, Host Lists, Scripts, and Sites. The RPMs page is active, showing a table with 3 devices. The table has columns for Id, Name, Managed Via, Type, Outlet #, On, Input (V), Power (VA), Power (W), Battery (%), Load (%), Beeper, Status, and a radio button for selection. The devices listed are SLP16snmp, CyberPower-900-UPS, and STech16SNMP.

Id	Name	Managed Via	Type	Outlet #, On	Input (V)	Power (VA)	Power (W)	Battery (%)	Load (%)	Beeper	Status	
1	SLP16snmp	SNMP-172.19.237.30	PDU	16, 16	N/A	N/A	N/A	N/A	N/A	N/A	normal	<input checked="" type="radio"/>
2	CyberPower-900-UPS	USB-front port	UPS	10, N/A	114	N/A	68	100	0	on	OL	<input type="radio"/>
3	STech16SNMP	SNMP-172.19.100.24	PDU	6, 16	113	52	38	N/A	N/A	N/A	normal	<input type="radio"/>

2. In the lower section of the page, select an RPM by clicking on the radio button to the far right in the RPM's row. The options that are available for that RPM will be available (ungreyed). Select one of the following options:

Refresh	Refreshes the information in the RPMs table.
Add Device	Displays the Device Ports > RPMs - Add Device to add a new managed PDU or UPS.
Shutdown Order	Displays the order in which all UPS devices are shutdown in the event that a UPS reaches a low battery state. See Figure 10-2 . For more information, see RPM Shutdown Procedure .

Notifications	Displays the notifications configured for each PDU and UPS. See Figure 10-3 .
Raw Data	Displays a window with all of the information returned by the driver when a query for status is requested. This option is available for all RPMs. See Figure 10-4 .
Logs	Displays a window with any logging information that has been accumulated for the selected RPM, if logging is enabled for the RPM. This option is available for all RPMs. See Figure 10-5 .
Environmental	Displays a window with any environmental (humidity and temperature) information that may be available for the selected RPM, if sensors are installed for the RPM. This option is available for all RPMs. See Figure 10-6 .
Managed Device	Displays the RPMs - Manage Device page, with the complete status and configuration for the selected RPM. This option is available for all RPMs.
Outlets	Displays the RPMs - Outlets page for RPMs that support individual outlet control and status.
Beeper: Enable, Mute, Disable	If the RPM has a beeper that can be controlled, these options allow the administrator to Enable , Mute , or Disable the beeper. If you try to use Mute to silence a beeper and the beeper continues to sound, the UPS most likely does not support mute, and the Disable option will be the only way to silence the beeper.
Reboot	Reboots the RPM immediately, which may interrupt the power provided by the RPM while it is rebooting. Some PDUs and UPSes have a default delay that they will wait before initiating a reboot; this setting may be visible in the raw data (see above) as "ups.delay.reboot".
Shutdown	Shutsdown the RPM immediately, which will interrupt the power provided by the RPM. Some PDUs and UPSes have a default delay that they will wait before initiating a shutdown; this setting may be visible in the raw data (see above) as "ups.delay.shutdown".
Delete	Deletes the selected RPM, after a confirmation.

Figure 10-2 RPM Shutdown Order

Shutdown Order for UPS Remote Power Managers				
RPM Id	Name	Shutdown Order	Low Battery Action	Provides SLC Power
2	Eaton	2	Shutdown this UPS	No
5	Cyber	50	Shutdown this UPS	Yes

2 UPS(s).

Figure 10-3 RPM Notifications

Notification Configuration for Remote Power Managers

RPM Id	Name	Log Status	SNMP Trap	Email Address
1	APC750	1 min	Yes	[none]
2	Eaton	1 min	Yes	[none]
3	ServerTechTelnet	1 min	Yes	[none]
4	SerTechSNMP	1 min	Yes	[none]
5	Cyber	1 min	Yes	[none]

5 RPM(s).

Figure 10-4 RPM Raw Data Log

```

ambient.2.humidity: 41.00
ambient.2.temperature: 24.00
device.mfr: Lantronix SLP
device.model: Glenn-Tower
device.serial: 13900002
device.type: SLP PDU
driver.name: snmp-ups
driver.parameter.pollinterval: 2
driver.parameter.port: 172.19.237.30
driver.parameter.synchronous: no
driver.version: 2.7.3
driver.version.data: slp MIB 17.12.07
driver.version.internal: 0.72
outlet.1.desc: TowerA_Outlet1
outlet.1.id: A1

```

Figure 10-5 RPM Logs

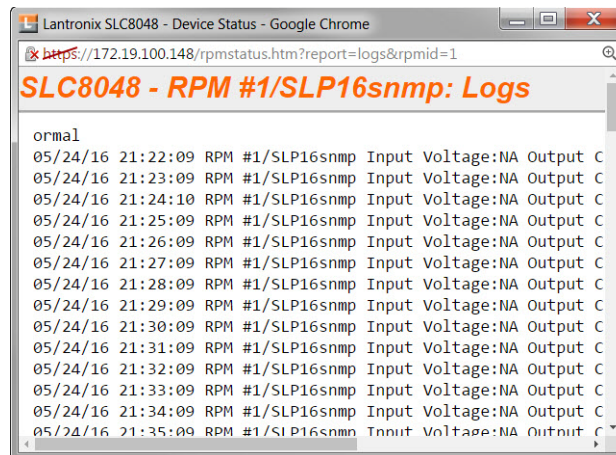
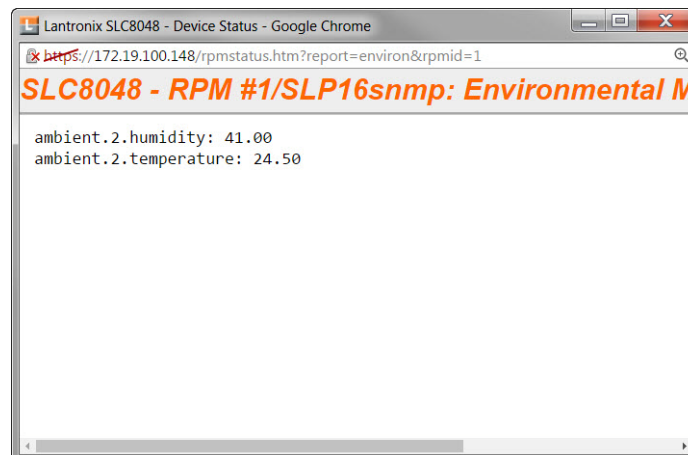

Figure 10-6 RPM Environmental Log



RPMs - Add Device

The **Add Device** page assists the administrator with adding a new managed RPM to the SLC configuration. With over 140 different vendors and nearly 1000 different models that are supported, the key to ensuring the SLC can properly manage a PDU or UPS is selecting the right model (with its associated driver) and any required driver options, especially for USB managed devices. On the [Devices > RPMs](#) page, access the [Device Ports > RPMs - Add Device](#) page to configure a new managed remote power manager (RPM) for the SLC configuration.

Note: The [Device Ports > RPMs - Add Device](#) page with the same functionality can also be accessed through the [Devices > Device Ports](#) page.

To add a new managed RPM :

1. Click the **Devices** tab and select the **RPMs** option. [Figure 10-1](#) shows the page that displays.
2. Click the **Add Device** link on the [Devices > RPMs](#) page. The following page displays.

Figure 10-7 Device Ports > RPMs - Add Device

LANTRONIX® SLC 8048

Logout Host: slc4331 User: sysadmin

Select port for Configuration WebSSH (DP only) Connected Device (DP only)

Network Services User Authentication Devices Maintenance Quick Setup

Device Status Device Ports Console Port USB / SD Card RPMs Connections Host Lists Scripts Sites

RPMs - Add Device Help?

Vendor: (U) - USB, (S) - Serial, (N) - Network, (P) - SNMP

Model:

Managed via: USB Serial Network SNMP

USB Device:

Name:

of Outlets:

IP Address:

Port: Enter "0" for a front USB port.

Driver Opts:

Login:

Password:

Retype Password:

Log Status: No Yes, minutes:

Critical SNMP Traps:

Critical Emails:

Low Battery: Shutdown this UPS Shutdown all UPSes Allow battery failure Shutdown both SLC UPSes

Shutdown Order:

Provides SLC Power:

3. Enter the following:

Vendor	Select the correct vendor from the drop-down menu.
---------------	--

Model	Select the Model in the drop-down menu. The drop-down menu will be populated with models supported for the selected vendor above. To the left of each model name is one or two letters in parentheses that indicate the type of control available for the selected model: P - SNMP, S - serial port, U - USB port, N - network. Some of the model names in the dropdown may be truncated because the list of models is very long - in this case, hover over the model name and the complete model name(s) will be displayed.
Managed via	If there is more than one way to manage the selected model, select the appropriate management method.
USB Device	For USB controlled devices, if the RPM is connected to a USB port, the device should be displayed in the USB Device dropdown. Select the correct device. This will automatically fill in the Port with the correct port number and the Driver Opts with the USB vendor and product ID (see below).
Name	Specify the unique name of the RPM (up to 20 characters).
# of Outlets	Specify the number of outlets on the RPM (maximum of 120 outlets).
IP Address	For SNMP and Network (Telnet) managed RPMs, specify the IP address of the RPM.
Port	For network (Telnet) managed RPMs, this is assumed to be port 23 (if left blank), or it can be filled in with an alternate TCP port. For USB managed RPMs, this is one of the front USB ports ("0") or the device port that the RPM is connected to on the SLC (this may be automatically filled in when the USB Device is selected). For serially controlled RPMs, this is the device port that the RPM is connect to on the SLC.
Driver Opts	For the driver associated with the RPM device, these are extra options which may be required to make the driver work. The most frequent use of the driver options is for USB devices (the vendor and product ID may be required so that the SLC can find the correct device on the USB bus), or in the event that the default driver options do not work with the RPM. The vendor and product ID may be automatically filled in if a USB Device is selected. There may also be other driver options that are filled in by the SLC from an internal table - these will be automatically set and can be viewed after the RPM has been added, and can always be overridden by driver options set by the user. For a complete list of RPM models, drivers and driver options, refer to the Network UPS Tools Hardware Compatibility List . The format of the driver options setting is one or more comma-separated parameters-value pairs, e.g. <parameter name>=<value>.
Login	For Network and serially managed RPMs, this is the administrator login.
Password/Retype Password	For Network and serially managed RPMs, this is the administrator password.
Read Community	For SNMP managed RPMs, this is the SNMP read (get) community.
Write Community/Retype Write Comm	For SNMP managed RPMs, this is the SNMP write (set) community.
Log Status	Indicates if the status of the RPM is periodically logged. Select Yes, minutes to log the status periodically and enter a value between 1 and 60 minutes. The logs can be viewed by viewing the Devices > RPMs page and clicking on "Logs".
Critical SNMP Traps	If enabled, under critical conditions (UPS goes onto battery power, UPS battery is low, UPS forced shutdown in progress, UPS on line power, UPS battery needs to be replaced, RPM is unavailable, communications with RPM lost, communications with RPM established), a <code>slcEventRPMAction</code> trap will be sent to the NMS configured in the SNMP settings. This requires that SNMP traps be enabled.

Critical Emails	If an email address is specified, under critical conditions (see Critical SNMP Traps above), an email notification will be sent to the email address. The Server and Sender configured in the SMTP settings will be used to send the email.
Low Battery	For UPS devices only. Indicates the behavior to take when the UPS reaches a low battery state. Options are to Shutdown this UPS - shutdown only the UPS that has reached a low battery state; Shutdown all UPSes - shutdown all UPSes managed by the SLC; Allow battery failure - allow the battery to completely fail, which may result in the unsafe shutdown of the devices it provides power to; Shutdown both SLC UPSes - shutdown both UPSes that provide power to the SLC, including the UPS with that has reached a low battery state (some SLCs have dual power supplies). For more information, see RPM Shutdown Procedure .
Shutdown Order	For UPS devices only. If any of the UPSes managed by the SLC reaches a low battery state AND is configured for Shutdown all UPSes for its Low Battery setting, this indicates the order in which this UPS will be shutdown. All UPSes with a shutdown order of "1" will be shutdown first, followed by all UPSes with a shutdown order of "2", etc. Shutdown orders are in the range of 1 to 49, with 50 being reserved for UPSes that provide power to the SLC - they will always be shutdown last (see Provides SLC Power below).
Provides SLC Power	For UPS devices only. Indicates if this UPS provides power to the SLC.

4. Click **Apply** to Save.

RPMs - Manage Device

The **Manage Device** page allows the administrator to modify the settings for a managed RPM.

To modify a managed RPM:

1. Click the **Devices** tab and select the **RPMs** option. [Figure 10-1 Devices > RPMs](#) shows the page which displays.
2. Select an RPM and click the **Manage Device** link. [Figure 10-8 RPMs - Managed Device](#) shows the page which displays.

Figure 10-8 RPMs - Managed Device

The screenshot shows the LANTRONIX SLC 8048 web interface. At the top, there is a navigation bar with tabs for Network, Services, User Authentication, Devices, Maintenance, and Quick Setup. Below this is a sub-navigation bar with links for Device Status, Device Ports, Console Port, USB / SD Card, Internal Modem, RPMs, Connections, Host Lists, Scripts, and Sites. The main content area is titled 'RPMs - Manage Device' and contains two columns of configuration fields.

Left Column Fields:

- RPM Id: 1
- Name: SLP16snmp
- Status: normal
- Vendor: Lantronix SLP
- Model: Glenn-Tower
- # of Outlets: 16
- Outlets On: 16
- F/W Version: SecureLinux Power Manager Version 5.3p
- Serial Num: 13900002
- MAC Address: [none]
- Current: 0.5 amps
- Input Voltage: N/A
- Apparent Power: N/A
- Nominal Apparent Power: N/A
- Real Power: N/A
- Nominal Real Power: N/A

Right Column Fields:

- Managed via: SNMP
- IP Address: 172.19.237.30
- Port: []
- Driver Opts: []
- Read Community: public
- Write Community: []
- Retype Write Comm: []
- Log Status: No Yes, minutes: 1
- Critical SNMP Traps:
- Critical Emails: []
- Low Battery: Shutdown this UPS Shutdown all UPSes Allow battery failure Shutdown both SLC UPSes
- Shutdown Order: []
- Provides SLC Power:

Buttons: Logout, Apply, Outlets >

3. Enter the following:

RPM Id (view only)	The unique number associated with the RPM.
Name	Specify the unique name of the RPM (up to 20 characters).
Status (view only)	The current status of the RPM. Any error status will be shown here.
Vendor (view only)	The manufacturer of the RPM.
Model (view only)	The model of the RPM. The model is read from the device, if it is provided; not all RPMs provide a model string. If the device normally provides the device model and becomes unreachable, or does not provide a model string, the Model is derived from the supported model list strings.
# of Outlets	Specify the number of outlets on the RPM (maximum of 120 outlets).
Outlets On (view only)	The number of outlets that are currently turned on, if this information is provided by the RPM.
F/W Version (view only)	The firmware version of the RPM, if this information is provided by the RPM.
Serial Num (view only)	The serial number of the RPM, if this information is provided by the RPM.
MAC Address (view only)	The MAC address of the RPM, if this information is provided by the RPM.

Current (view only)	The total current value for the RPM in Amperes, if this information is provided by the RPM. If the RPM consists of two separate towers or units, each with its own current value, both current values will be displayed, separated by a slash.
Input Voltage (view only)	The input voltage for the RPM in Volts, if this information is provided by the RPM. If the RPM consists of two separate towers or units, each with its own input voltage value, both voltage values will be displayed, separated by a slash.
Apparent Power (view only)	The apparent power value for the RPM in Volt-Amperes, if this information is provided by the RPM. If the RPM consists of two separate towers or units, each with its own apparent power value, both power values will be displayed, separated by a slash.
Nominal Apparent Power (view only)	The nominal apparent power value for the RPM in Volt-Amperes, if this information is provided by the RPM. If the RPM consists of two separate towers or units, each with its own nominal apparent power value, both power values will be displayed, separated by a slash.
Real Power (view only)	The real power value for the RPM in Watts, if this information is provided by the RPM. If the RPM consists of two separate towers or units, each with its own real power value, both power values will be displayed, separated by a slash.
Battery Charge (view only)	For UPS devices only. Displays the current charge level for the battery, as a percentage.
Battery Runtime (view only)	For UPS devices only. Displays the amount of time remaining in the UPS battery life.
Beeper Status (view only)	For UPS devices only. Displays the current state of the UPS beeper.
Managed via (view only)	Displays the method used to control the RPM device (SNMP, Network, Serial Port, USB port).
IP Address	For SNMP and Network (Telnet) managed RPMs, specify the IP address of the RPM.
Port	For network (Telnet) managed RPMs, this is assumed to be port 23 (if left blank), or it can be filled in with an alternate TCP port. For USB managed RPMs, this is one of the front USB ports ("0") or the device port that the RPM is connected to on the SLC. For serially controlled RPMs, this is the device port that the RPM is connect to on the SLC.
Driver Opts	For the driver associated with the RPM device, these are extra options which may be required to make the driver work. The most frequent use of the driver options is for USB devices (the vendor and product ID may be required so that the SLC can find the correct device on the USB bus), or in the event that the default driver options do not work with the RPM. There may also be other driver options that are filled in by the SLC from an internal table - these will be automatically set and can be viewed after the RPM has been added, and can always be overridden by driver options set by the user. For a complete list of RPM models, drivers and driver options, refer to Network UPS Tools Hardware Compatibility List . The format of the driver options setting is one or more comma-separated parameters-value pairs, e.g. "<parameter name>=<value>".
Login	For Network and serially managed RPMs, this is the administrator login.
Password/Retype Password	For Network and serially managed RPMs, this is the administrator password.
Read Community	For SNMP managed RPMs, this is the SNMP read (get) community.
Write Community/Retype Write Comm	For SNMP managed RPMs, this is the SNMP write (set) community.

Log Status	Indicates if the status of the RPM is periodically logged. Select Yes, minutes to log the status periodically and enter a value between 1 and 60 minutes. The logs can be viewed by viewing the RPMs web page and clicking on "Logs".
Critical SNMP Traps	If enabled, under critical conditions (UPS goes onto battery power, UPS battery is low, UPS forced shutdown in progress, UPS on line power, UPS battery needs to be replaced, RPM is unavailable, communications with RPM lost, communications with RPM established), a slcEventRPMAction trap will be sent to the NMS configured in SNMP settings. This requires that SNMP traps be enabled.
Critical Emails	If an email address is specified, under critical conditions (see Critical SNMP Traps above), an email notification will be sent to the email address. The Server and Sender configured in the SMTP settings will be used to send the email.
Low Battery	For UPS devices only. Indicates the behavior to take when the UPS reaches a low battery state. Options are to Shutdown this UPS - shutdown only the UPS that has reached a low battery state; Shutdown all UPSes - shutdown all UPSes managed by the SLC; Allow battery failure - allow the battery to completely fail, which may result in the unsafe shutdown of the devices it provides power to; Shutdown both SLC UPSes - shutdown both UPSes that provide power to the SLC, including the UPS with that has reached a low battery state (some SLCs have dual power supplies). For more information, see RPM Shutdown Procedure
Shutdown Order	For UPS devices only. If any of the UPSes managed by the SLC reaches a low battery state AND is configured for Shutdown all UPSes for its Low Battery setting, this indicates the order in which this UPS will be shutdown. All UPSes with a shutdown order of "1" will be shutdown first, followed by all UPSes with a shutdown order of "2", etc. Shutdown orders are in the range of 1 to 49, with 50 being reserved for UPSes that provide power to the SLC - they will always be shutdown last (see Provides SLC Power in the next field below).
Provides SLC Power	For UPS devices only. Indicates if this UPS provides power to the SLC.

- To save, click **Apply**.

RPMs - Outlets

The **Outlets** page allows the administrator to view the current status of each individual outlet on an RPM, and change the state of the outlets. Not all RPMs support individual outlet status and control.

To control and view status for RPM outlets:

- Click the **Devices** tab and select the **RPMs** option. [Figure 10-1 Devices > RPMs](#) shows the page which displays.
- Select an RPM and click the **Outlets** link. [Figure 10-9 RPMs - Outlets](#) shows the page which displays. This page will, at a minimum, list the outlet numbers and their state - **On** or **Off**. If the RPM provides additional information for the outlets, the custom name and the current reading in Amperes will also be displayed for each outlet.

Figure 10-9 RPMs - Outlets

LANTRONIX[®] SLC 8048

Logout Host: slc4331 User: sysadmin

Select port for Configuration WebSSH (DP only) Connected Device (DP only)

Network Services User Authentication Devices Maintenance Quick Setup

Device Status Device Ports Console Port USB / SD Card Internal Modem RPMs Connections Host Lists Scripts Sites

RPMs - Outlets [Help ?](#)

[Refresh >](#)

RPM #3-STech16SNMP				Outlet: <input type="button" value="Cycle Power"/> <input type="button" value="Turn On"/> <input type="button" value="Turn Off"/>	
Id	State	Description	Current (amps)	<input type="checkbox"/>	<input type="checkbox"/>
1	on	Outlet1	0.00	<input type="checkbox"/>	<input type="checkbox"/>
2	on	TowerA_Outlet2	0.00	<input type="checkbox"/>	<input type="checkbox"/>
3	on	TowerA_Outlet3	0.00	<input type="checkbox"/>	<input type="checkbox"/>
4	on	TowerA_Outlet4	0.00	<input type="checkbox"/>	<input type="checkbox"/>
5	on	TowerA_Outlet5	0.00	<input type="checkbox"/>	<input type="checkbox"/>
6	on	TowerA_Outlet6	0.00	<input type="checkbox"/>	<input type="checkbox"/>

- To change the state of one or more outlets, select the outlets, and click the **Cycle Power**, **Turn On** or **Turn Off** buttons. The command will be sent to the RPM and the page will refresh. It may take one or two minutes before the new outlet state(s) are reflected on the Outlets page.

RPM Shutdown Procedure

This section applies to UPS-type RPMs only, and does not apply to PDU-type RPMs. This section describes the shutdown process when a UPS managed by the SLC reaches a low battery state. When one UPS reaches a low battery state, the SLC can be configured to allow the UPS to continue to run until its battery fails completely, to shutdown just the UPS with the low battery, or to shutdown one or more UPSes. UPS-type RPMs can report the following states:

- ◆ **OL** - On line power
- ◆ **OB** - On battery power
- ◆ **LB** - Low battery
- ◆ **HB** - High battery
- ◆ **RB** - The battery needs to be replaced
- ◆ **CHRG** - The battery is charging
- ◆ **DISCHRG** - The battery is discharging (inverter is providing load power)
- ◆ **BYPASS** - UPS bypass circuit is active - no battery protection available
- ◆ **CAL** - UPS is currently performing runtime calibration (on battery)
- ◆ **OFF** - UPS is offline and is not supplying power to the load
- ◆ **OVER** - UPS is overloaded
- ◆ **TRIM** - UPS is trimming incoming voltage

- ◆ **BOOST** - UPS is boosting incoming voltage
- ◆ **FSD** - UPS is in forced shutdown due to a critical condition

Once a UPS is on line power (status is **OL**) and goes off of line power and onto battery power (status is **OB**), it may reach a low battery state (status is **OB**, **LB** or **LB**). Switching from line power to battery power, and reaching a low battery state are critical states that can result in syslog, email and SNMP trap notifications. The exact point at which a UPS reaches a low battery state is device dependent and is related to the **battery.charge**, **battery.charge.low**, **battery.runtime** and **battery.runtime.low** settings which can be viewed in the "Raw Data" report.

Once a UPS reaches a low battery state, the **Shutdown Order**, **Low Battery Action** and **Provides SLC Power** settings determine which UPSes to shutdown, and in what order. The UPS with the low battery will be placed into **FSD** (Forced Shutdown) mode. The following actions will be performed based on the **Low Battery Action** setting for the UPS with the failed battery:

- ◆ **Allow Battery Failure** - The UPS battery will be allowed to run until it fails completely. If the UPS provides power to the SLC and the battery fails, the SLC will not be cleanly shutdown. In this scenario, the **Shutdown Order** setting will be ignored. The **Shutdown Order** setting may be used if another UPS reaches the low battery state (see **Shutdown all UPSes** below).
- ◆ **Shutdown This UPS** - If the UPS provides power to the SLC, the SLC will begin shutdown procedures, shutting down the UPS last. If the UPS does not provide power to the SLC, the UPS will be shutdown, but will continued to be monitored in case it comes back online.
- ◆ **Shutdown all UPSes** - The SLC will begin shutting down all UPSes with a non-zero **Shutdown Order**, shutting down UPSes with a shutdown order of "1" first, UPSes with a shutdown order of "2" second, etc. Any UPS which provides power to the SLC is always forced to have its **Shutdown Order** set to 50, which the highest (and last) Shutdown Order. If the UPS with the failed battery provides power to the SLC (and thus has a Shutdown Order set to 50), the SLC will also begin shutdown procedures, shutting down the failed UPS last. If none of the UPSes provide power to the SLC, after they are all shutdown their drivers will remaining running in case the UPS comes back online. In this case, any queries to an RPM while it is still offline may report "RPM driver data is stale". If the **Low Battery Action** for a UPS is set to **Allow Battery Failure**, but the UPS has a non-zero **Shutdown Order**, the UPS will still be shutdown if another UPS reaches the low battery state and has its **Low Battery Action** set to **Shutdown all UPSes**.
- ◆ **Shutdown Both SLC UPSes** - This setting should only be used on dual-power SLC units which have each power supply connected to separate (different) UPS devices, and both UPS devices are being managed by the SLC. If a UPS is configured for **Shutdown Both SLC UPSes** but does not have **Provides SLC Power** enabled, this is an ambiguous configuration, and no shutdown action will occur.

For this configuration, when one of the UPSes providing power to the SLC reaches a low battery state, the event will be noted in the system log, and the SLC will continue to run with no further actions until the second UPS providing power to the SLC reaches a low battery state. At this point the SLC will begin shutdown procedures, shutting down both failed UPSes last.

Optimizing and Troubleshooting RPM Behavior

This section gives tips on how to optimize the management of specific PDUs and UPSes, and how to troubleshoot any problems with the SLC connecting to and managing an RPM.

- ◆ **Sentry3 - Network and Serially Managed PDUs** - Some Sentry3 PDUs have a CLI timeout, with a default setting of 5 minutes. This timeout may cause frequent query errors when requesting information from the Sentry3 PDU. It is recommended that the timeout be set as high as possible to reduce the frequency of the query errors.
- ◆ **Serially Managed RPMs with Administrator Logins** - Some serially managed devices will have an administrator login for the console port. It is recommended that any active sessions be logged out before adding the device as an RPM, otherwise the RPM may experience query errors.

If the SLC is unable to communicate with an RPM, or an RPM is displaying the error "driver is not running", the following steps can be used to troubleshoot the driver issues:

- ◆ **Correct Driver** - The CLI command `set rpm driver <RPM Id or Name> action show` can be used to display the current running driver for the RPM. Some serially and network managed RPMs do not have drivers; if this is the case for the RPM, the CLI command will indicate this. Otherwise it will display the driver that is running for the RPM, and it should match the driver listed for the device at [Network UPS Tools Hardware Compatibility List](#). If the wrong driver is shown, the RPM will need to be deleted and re-added, with the correct vendor and model selected. If no driver is shown, the driver may not be able to start for a variety of reasons; see remaining steps.
- ◆ **SNMP Settings** - For SNMP managed devices, verify the **IP Address**, **Read Community** and **Write Community** settings are correct.
- ◆ **Reverse Pinout Setting** - For serially managed devices, verify the **Reverse Pinout** setting (located in the [Device Port Settings](#) page) is set correctly.
- ◆ **VendorId and ProductId Driver Options** - For USB managed devices, verify the `vendorid` and `productid` shown in the RPM driver options are correct. These can be set automatically by the SLC from an internal table, set by the user by selecting a specific USB device when adding a USB-managed RPM, or changed by the user at any time. The CLI command `show usb devices` displays all connected USB devices with their port, Product ID and Vendor ID.
- ◆ **Extra Driver Options** - The driver documentation at [Network UPS Tools Hardware Compatibility List](#) may indicate that extra driver options are required for the RPM. Select the driver name link under the Driver column to see any special requirements for the UPS or PDU.
- ◆ **Driver Debug Mode** - The driver can be run in debug mode at the CLI and the output examined to determine why the driver is not starting or is unable to communicate with the RPM. The CLI command `set rpm driver <RPM Id or Name> action debug [level <1|2|3>]` will stop any currently running driver and restart the driver in debug mode with output sent to a local file. Running `set rpm driver <RPM Id or Name> action show` should show a driver running with one or more **-D** flags. The debug output can be examined or emailed with the `set rpm driver <RPM Id or Name> action viewoutput [email <Email Address>] [display <head|tail>] [numlines <Number or Lines>]` command. To return the driver to its normal non-debug state, run `set rpm driver <RPM Id or Name> action restart`. Note that drivers running in debug mode will generate copious output, and for disk space reasons should not be left running in debug mode for long periods of time (e.g. more than an hour).

RPM Commands

set rpm add

Syntax

```
set rpm add <RPM Name>
```

Description

Adds an RPM to be managed (prompts will guide selection of RPM vendor and model).

set RPM command

Syntax

```
set rpm command <RPM Id or Name>  
    outlet <all|Outlet # or List> state <on|off|cyclepower>
```

Description

Sends a command to control one or more outlets on an RPM.

Syntax

```
set rpm command <RPM Id or Name> device <reboot|shutdown>
```

Description

Sends a command to control an RPM device.

Syntax

```
set rpm command <RPM Id or Name> beeper <mute|enable|disable>
```

Description

Sends a command to control an RPM beeper.

set rpm delete

Syntax

```
set rpm delete <RPM Id or Name>
```

Description

Deletes an RPM.

set rpm driver**Syntax**

```
set rpm driver <RPM Id or Name> action restart
set rpm driver <RPM Id or Name> action debug [level <1|2|3>]
set rpm driver <RPM Id or Name> action show
set rpm driver <RPM Id or Name> action viewoutput [email <Email Address>]
    [display <head|tail>] [numlines <Number of Lines>]
```

Description

Control and debug the RPM driver if the driver is not properly communicating with the PDU or UPS: restart the driver; restart the driver with debug output to a file; show the running driver; view and email the driver debug output.

Note: *Drivers running in debug mode will generate copious output and for disk space reasons should not be left running in debug mode for long periods of time.*

set rpm edit**Syntax**

```
set rpm edit <RPM Id or Name> <one or more parameters>
```

Parameters

```
name <New RPM Name>
    outlets <# of Outlets>
    ipaddr <IP Address>
    port <TCP or Device Port>
    login <RPM Admin Login>
    rocommunity <SNMP Read-Only Community>
    rwcommunity <SNMP Read-Write Community>
    logstatus <disable|1-60 minutes>
    snmptraps <enable|disable>
    emailaddress <Email Address>
    upslowbattery <shutdown|shutdownall|shutdownboth|allowfailure>
    sdorder <disable|1-49>
    powertoslc <enable|disable>
    driveropts <Driver Options Override>
```

Description

Configure and control Remote Power Managers (RPMs), including PDUs and UPSes.

set rpm password**Syntax**

```
set rpm password <RPM Id or Name>
```

Description

Set RPM administrative password.

show RPM**Syntax**

```
show rpm [type <ups|pdu>]
         [config <sdorder|notify>]
         [device <RPM Name or Id> [data <raw|logs|envmon>]]
```

Note: *The show rpm envmon command for RPM-configured ServerTech Serial/Network Mode is not supported by NUT/Powerman.*

Description

Display a list of all RPMs, RPMs of a specific type, UPS shutdown and notification configuration, or details and outlets for a single RPM device.

11: Connections

[Chapter 8: Device Ports on page 118](#) described how to configure and interact with an SLC advanced console server port connected to an external device. This chapter describes how to use the [Devices > Connections](#) page to connect external devices and outbound network connections (such as Telnet or SSH) in various configurations.

An SLC unit port attached to an external device can be connected to one of the following endpoints:

- ◆ Another device port attached to an external device
- ◆ Another device port with a modem attached
- ◆ An outgoing Telnet or SSH session
- ◆ An outgoing TCP or UDP network connection

This enables the user to set up connections such as those described in the next section. You can establish a connection at various times:

- ◆ Immediately. These connections are always re-established after reboot.
- ◆ At a specified date and time. These connections connect if the date and time have already passed.
- ◆ After a specified amount of data or a specified sequence of data passes through the connection. Following reboot, the connection is not reestablished until the specified data passes through the connection.

Typical Setup Scenarios for the SLC Unit

Following are typical configurations in which SLC connections can be used, with references to settings on the [Devices > Connections](#) and [Device Ports > Settings](#) web pages.

Terminal Server

In this setup, the SLC 8000 advanced console manager acts as a multiplexer of serial data to a single server computer. Terminal devices are connected to the serial ports of the SLC unit and configured as a Device Port to Telnet out type connection on the [Devices > Connections](#) page. The users of the terminals can access the server as if they were connected directly to it by local serial ports or a console.

Figure 11-1 Terminal Server

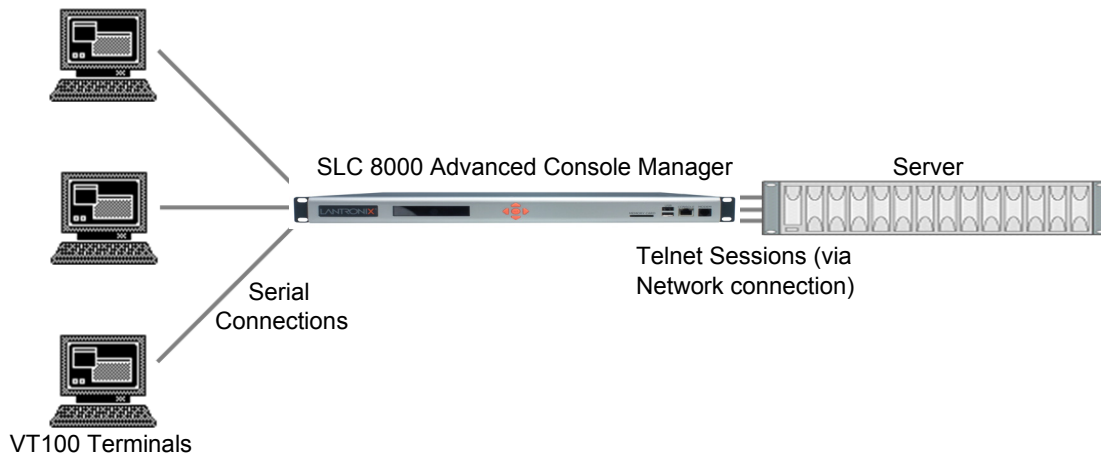

Remote Access Server

In this setup, the SLC 8000 advanced console manager is connected to one or more modems by its device ports. Configure the device ports on the [Device Ports > Settings](#) web page by selecting the Dial-in option in the Modem Settings section. Most customers use the modems in PPP mode to establish an IP connection to the SLC unit and either Telnet or SSH into the SLC 8000 advanced console manager. They could also select text mode where, using a terminal emulation program, a user could dial into the SLC unit and connect to the command line interface.

Figure 11-2 Remote Access Server



Reverse Terminal Server

In this scenario, the SLC 8000 advanced console manager has one or more device ports connected to one or more serial ports of a mainframe server. Users can access a terminal session by establishing a Telnet or SSH session to the SLC unit. To configure the SLC console manager, select the **Enable Telnet In** or **Enable SSH In** option on the [Device Ports > Settings](#) page.

Figure 11-3 Reverse Terminal Server

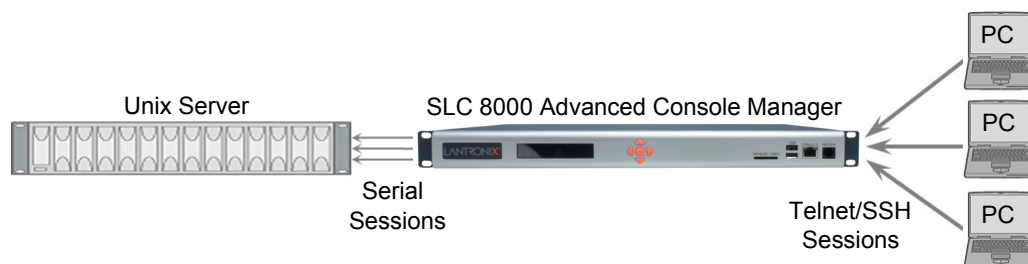

Multiport Device Server

A PC can use the device ports on the SLC unit as virtual serial ports, enabling the ports to act as if they are local ports to the PC. To use the SLC 8000 advanced console manager in this setup, the PC requires special software, for example, Com Port Redirector (available on www.lantronix.com) or similar software).

Figure 11-4 Multiport Device Server



Console Server

For this situation, the SLC unit is configured so that the user can manage a number of servers or pieces of network equipment using their console ports. The device ports on the SLC 8000 advanced console manager are connected to the console ports of the equipment that the user would like to manage. To manage a specific piece of equipment, the user can Telnet or SSH to a specific port or IP address on the SLC unit and be connected directly to the console port of the end server or device. To configure this setup, set the **Enable Telnet In** or **Enable SSH In** option on the [Device Ports > Settings](#) page for the device port in question. The user can implement an extra remote management capability by adding a modem to one of the device ports and setting the **Dial-in** option in the Modem Settings section of the [Device Ports > Settings](#) page. A user could then dial into the SLC 8000 advanced console manager using another modem and terminal emulation program at a remote location.

Figure 11-5 Console Server

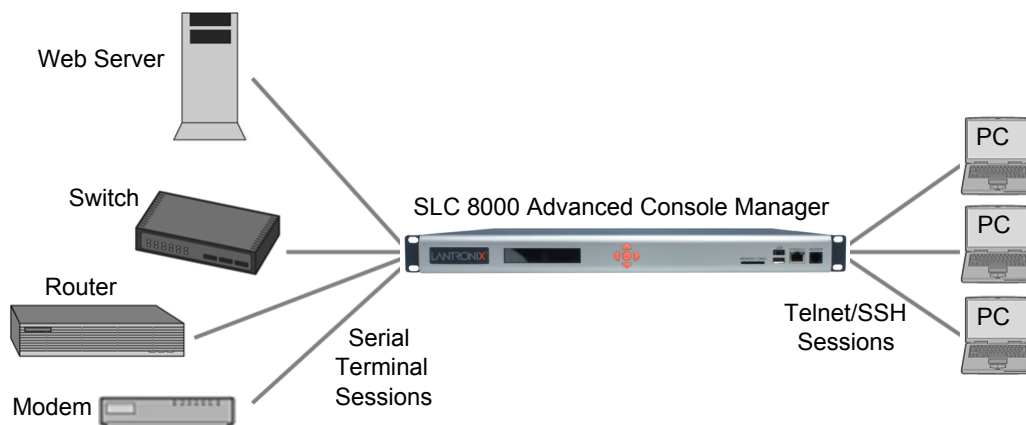

Connection Configuration

Note: These are advanced connection settings for specific applications. If the SLC 8000 advanced console manager is being used as a console or device server it is unlikely that you will need any of the Connection settings described below.

To create a connection:

1. Click the **Devices** tab and select the **Connections** option. The following page displays:

Figure 11-6 Devices > Connections

LANTRONIX[®] SLC 8048

Logout Host: slc4331 User: sysadmin

Select port for Configuration WebSSH (DP only) Connected Device (DP only)

Network Services User Authentication **Devices** Maintenance Quick Setup

Device Status Device Ports Console Port USB / SD Card RPMs Connections Host Lists Scripts Sites

Connections Help?

Outgoing Connection Timeout: No Yes: seconds

Connect: Device Port
 Port: [Settings >](#)

Data Flow:

to: Device Port
 Hostname:
 Port: [Settings >](#)

SSH Out Options
 User:
 Version: None 1 2
 Command:

Trigger: Connect now
 Connect at date/time: May 24 2016 07 : 18 am
 Auto-connect on characters transferring:
 at least characters
 character sequence:

To view details for a connection, hold the mouse over the arrow icon in the Flow column
 If a connection can be modified, the fields above will be filled in; modify the connection and select 'Configure'
 To terminate a connection, select the radio button in the right column below and select 'Terminate'
 Web connections can be viewed [here >](#)

Current Connections		Configure	Terminate	Keep Connection: <input type="checkbox"/>	Restart
Port/Service	Flow	Port/Service	User	Time	<input type="checkbox"/>
Console Port		Command Line	N/A	83:24:58	<input type="checkbox"/>

2. For a device port, enter the following:

Outgoing Connection Timeout	Select to turn on or turn off the connection timeout: <ul style="list-style-type: none"> ◆ No for no timeout ◆ Yes for a timeout. Specify the number of seconds in the seconds field.
------------------------------------	---

Port	<p>The number of the device port you are connecting.</p> <p>This device port must be connected to an external serial device and must not have command line interface logins enabled, be connected to a modem, or be running a loopback test.</p> <p>Note: To see the current settings for this device port, click the Settings link.</p>
Data Flow	Select the arrow showing the direction (bidirectional or unidirectional) the data will flow in relationship to the device port you are connecting.
to	<p>From the drop-down list, select a destination for the connection: a device port connected to a serial device, a device port connected to a modem, or an outbound network connection (Telnet out, SSH out, TCP Port, or UDP Port).</p> <p>Note: To see the current settings for a selected device port, click the Settings link.</p>
Hostname	The host name or IP Address of the destination. This entry is required if the to field is set to Telnet out, SSH out, TCP port, or UDP port.
Port	<p>If the to field is set to Device Port or Modem on Device Port, enter the number of the device port. For all other options, this is the TCP/UDP port number, which is optional for Telnet out and SSH out, but required for TCP Port and UDP Port.</p> <p>Note: If you select Device Port, it must not have command line interface logins enabled or be running a loopback test. To view the device port's settings, click the Settings link to the right of the port number.</p>
SSH Out Options	<p>Select one of the following optional flags to use for the SSH connection.</p> <ul style="list-style-type: none"> ◆ User: Login ID to use for authenticating on the remote host. ◆ Version: Version of SSH. Select 1 or 2. ◆ Command: Enter a specific command on the remote host (for example, reboot).
Trigger	<p>Select the condition that will trigger a connection. Options include:</p> <ul style="list-style-type: none"> ◆ Connect now: Connects immediately, or if you reboot the SLC 8000 advanced console manager, immediately on reboot. ◆ Connect at date/time: Connects at a specified date and time. Use the drop-down lists to complete the date and time. Upon rebooting, the SLC unit reestablishes the connection if the date/time has passed. ◆ Auto-connect on characters transferring: Select the arrow indicating the direction of the data transfer and either the minimum number of characters or a specific character sequence that will trigger the connection. <p>You can select the direction of the data transfer only if Data Flow is bidirectional. Upon rebooting, the SLC 8000 advanced console manager does not reestablish the connection until the specified data has passed through one of the endpoints of the connection.</p>

3. To save, click the **Apply** button.

To view, update, or disconnect a current connection:

The bottom of the [Current Connections](#) page displays current connections.

Figure 11-7 Current Connections

To view details for a connection, hold the mouse over the arrow icon in the Flow column. If a connection can be modified, the fields above will be filled in; modify the connection and select 'Configure'. To terminate a connection, select the radio button in the right column below and select 'Terminate'. Web connections can be viewed [here](#).

Current Connections					
		Configure	Terminate	Keep Connection: <input type="checkbox"/>	Restart
Port/Service	Flow	Port/Service	User	Time	
Console Port		Command Line	sysadmin	2:49:03	<input type="checkbox"/>

1. To view details about a connection, hold the mouse over the arrow in the **Flow** column.
2. To disconnect (delete) a connection, select the connection in the **Select** column and click the **Terminate** button.
3. To reestablish the connection, create the connection again in the top part of the page.
4. To view information about Web connections, click the **here** link in the text above the table. The [Maintenance > Firmware & Configurations](#) page displays.

Connection Commands

These commands for configuring connections correspond to the web page entries described above.

To connect to a device port to monitor and/or interact with it, or to establish an outbound network connection:

```
connect direct <endpoint>
```

Endpoint is one of:

```
deviceport <Port # or Name>
```

```
ssh <IP Address or Name> [port <TCP Port>] [<SSH flags>]
```

where <SSH flags> is one or more of:

```
user <Login Name>
```

```
version <1|2>
```

```
command <Command to Execute>
```

```
tcp <IP Address> [port <TCP Port>]
```

```
telnet <IP Address or Name> [port <TCP Port>]
```

```
udp <IP Address> [port <UDP Port>]
```

```
hostlist <Host List>
```

To configure initial timeout for outgoing connections:

```
connect global outgoingtimeout <disable|1-9999 seconds>
```

Note: This is not a TCP timeout.

To monitor a device port:

```
connect listen deviceport <Device Port # or Name>
```

To connect a device port to another device port or an outbound network connection (data flows in both directions):

```
connect bidirection <Port # or Name> <endpoint>
```

Endpoint is one of:

```

charcount <# of Chars>
charseq <Char Sequence>
charxfer <toendpoint|fromendpoint>
deviceport <Device Port # or Name>
date <MMDDYYhhmm[ss]>
exclusive <enable|disable>
ssh <IP Address or Name> [port <TCP Port>] [<SSH flags>]

```

where <SSH flags> is one or more of:

```

user <Login Name>
version <1|2>
command <Command to Execute>
tcp <IP Address> [port <TCP Port>]
telnet <IP Address or Name> [port <TCP Port>]
trigger <now|datetime|chars>
udp <IP Address> [port <UDP Port>]

```

Note: If the trigger is *datetime* (establish connection at a specified date/time), enter the *date* parameter. If the trigger is *chars* (establish connection on receipt of a specified number or characters or a character sequence), enter the *charxfer* parameter and either the *charcount* or the *charseq* parameter.

To connect a device port to another device port or an outbound network connection (data flows in one direction):

```

connect unidirection <Device Port # or Name> dataflow <toendpoint|
fromendpoint> <endpoint>

```

Endpoint is one of:

```

charcount <# of Chars>
charseq <Char Sequence>
datetime <MMDDYYhhmm[ss]>
deviceport <Port # or Name>
exclusive <enable|disable>
ssh <IP Address or Name> [port <TCP Port>] >
<SSH flags>]

```

where <SSH flags> is one or more of:

```

user <Login Name>
version <1|2>
command <Command to Execute>
tcp <IP Address> [port <TCP Port>]
telnet <IP Address or Name> [port <TCP Port>]
trigger <now|datetime|chars>
udp <IP Address> [port <UDP Port>]

```

Note: If the trigger is *datetime* (establish connection at a specified date/time), enter the *date* parameter. If the trigger is *chars* (establish connection on receipt of a specified number or characters or a character sequence), enter either the *charcount* or the *charseq* parameter.

To terminate a bidirectional or unidirectional connection:

```
connect terminate <Connection ID>
```

To view connections and their IDs:

```
show connections [email <Email Address>].
```

You can optionally email the displayed information.

Note: *The connection IDs are in the left column of the resulting table. The connection ID associated with a particular connection may change if connection times out and is restarted.*

To display details for a single connection:

```
show connections connid <Connection ID> [email <Email Address>
```

You can optionally email the displayed information.

To display global connections:

```
connect global show
```

12: User Authentication

Users who attempt to log in to the SLC advanced console manager by means of Telnet, SSH, the console port, or one of the device ports are granted access by one or more authentication methods.

The User Authentication page provides a submenu of methods (Local Users, NIS, LDAP, RADIUS, Kerberos, and TACACS+) for authenticating users attempting to log in. Use this page to assign the order in which the SLC unit will use the methods. By default, local user authentication is enabled and is the first method the SLC 8000 advanced console manager uses to authenticate users. If desired, you can disable local user authentication or assign it a lower precedence.

Note: *Regardless of whether local user authentication is enabled, the local user sysadmin account is always available for login.*

Authentication can occur using all methods, in the order of precedence, until a successful authentication is obtained, or using only the first authentication method that responds (in the event that a server is down).

If you have the same user name defined in multiple authentication methods, the result is unknown.

Example:

There is an LDAP user "joe" and an NIS user "joe" and the order of authentication methods is:

1. Local Users
2. LDAP
3. NIS

User "joe" tries to log in. Because there is an LDAP user "joe," the SLC unit tries to authenticate him against his LDAP password first. If he fails to log in, then the SLC 8000 advanced console manager may (or may not) try to authenticate him against his NIS "joe" user password.

To enable, disable, and set the precedence of authentication methods:

1. From the main menu, select **User Authentication**. The following page displays:

Figure 12-1 User Authentication > Authentication Methods

The SLC can be configured to use one or more authentication methods. Each authentication method is assigned a precedence, indicating the order that the method is used to authenticate a user who logs in to the SLC via SSH, Telnet, the Web or the Console Port.

Enabled methods (in order of precedence):

- Local Users

Disabled methods:

- NIS
- LDAP
- RADIUS
- Kerberos
- TACACS+

Authentication can occur using all methods, in the order of their precedence, using the next method if the previous one rejected the authentication; or using only the first authentication method that responds.



Attempt next method on authentication rejection

Apply

- To enable a method currently in the **Disabled methods** list, select the method and press the left arrow to the left of the list. The methods include:

NIS (Network Information System)	A network naming and administration system developed by Sun Microsystems for smaller networks. Each host client or server computer in the system has knowledge about the entire system. A user at any host can access files or applications on any host in the network with a single user identification and password. NIS uses the client/server model and the Remote Procedure Call (RPC) interface for communication between hosts. NIS consists of a server, a library of client programs, and some administrative tools. NIS is often used with the Network File System (NFS).
LDAP (Lightweight Directory Access Protocol)	A set of protocols for accessing information directories, specifically X.500-based directory services. LDAP runs over TCP/IP or other connection-oriented transfer services.
RADIUS (Remote Authentication Dial-In User Service)	An authentication and accounting system used by many Internet Service Providers (ISPs). A client/server protocol, it enables remote access servers to authenticate dial-in users and authorize their access to the requested system or service. RADIUS allows a company to maintain user profiles in a central database that all remote servers can share. It increases security, allowing a company to set up a policy that can be applied at a single administered network point.
Kerberos	Kerberos is a network authentication protocol that enables two parties to exchange private information across an unprotected network. It works by assigning a unique electronic credential, called a ticket, to each user who logs on to the network. The ticket is embedded in messages to identify the sender.

TACACS+ (Terminal Access Controller Access Control System)	TACACS+ allows a remote access server to communicate with an authentication server to determine whether the user has access to the network. TACACS+ is a completely new protocol and is not compatible with TACACS or XTACACS. The SLC 8000 advanced console manager supports TACACS+ only.
Local Users	Local accounts on the SLC unit used to authenticate users who log in using SSH, Telnet, the web, or the console port.

3. To disable a method currently in the **Enabled methods** list, select the method and click the right  arrow between the lists.
4. To set the order in which the SLC unit will authenticate users, use the up  and down  arrows to the left of the **Enabled methods** list.
5. For **Attempt next method on authentication rejection**, you have the following options:
 - To enable the SLC 8000 advanced console manager to use all methods, in order of precedence, until it obtains a successful authentication, select the check box. This is the default.
 - To enable the SLC unit to use only the first authentication method that responds (in case a server is down or unavailable), clear the check box.
6. Click **Apply**.

Now that you have enabled one or more authentication methods, you must configure them.

Authentication Commands

The following command for the command line interface corresponds to the web page entries described above.

To set ordering of authentication methods:

Note: *Local Users authentication is always the first method used. Any methods omitted from the command will be disabled.*

```
set auth <one or more parameters>
```

Parameters

```
authusenextmethod <enable|disable>
kerberos <1-6>
ldap <1-6>
localusers <1-6>
nis <1-6>
radius <1-6>
tacacs+ <1-6>
```

To view authentication methods and their order of precedence:

```
show auth
```

User Rights

The SLC has three user groups: Administrators, Power Users, and Default Users. Each has a predefined set of rights; users inherit rights from the user group to which they belong. These rights are in addition to the current functions that a user can perform at the command line interface:

- ◆ connect direct/listen
- ◆ set locallog/password/history/cli
- ◆ show datetime/deviceport/locallog/portstatus/portcounters/
- ◆ history/cli/user

The table below shows the mapping of groups and user rights.

Table 12-2 User Types and Rights

User Right	Administrator	Power Users	Default Users
Full Administrative Rights	X		
Networking	X	X	
Services	X		
Date/Time	X	X	
Local Users	X		
Remote Authentication	X		
SSH Keys	X		
User Menus	X		
Device Port Operations	X		
Device Port Configuration	X		
USB	X		
Reboot/Shutdown	X	X	
Firmware/Configuration	X		
Diagnostics and Reports	X	X	
Secure Lantronix Network	X		
Web Access	X	X	
Internal Modem	X		
RPMs	X		
SD Card	X		

You cannot deny a user rights defined for the group, but you can add or remove all other rights at any time.

By default, the system assigns new users to the Default Users group, but you can change their group membership at any time. If you change a user's rights while the user is logged into the web or CLI, the results do not take effect until the next time the user logs in.

Local and Remote User Settings

The system administrator can configure the SLC 8000 advanced console manager to use local accounts and remote accounts to authenticate users.

1. Click the **User Authentication** tab and select the **Local/Remote Users** option. The following page displays.

Figure 12-3 User Authentication > Local/Remote Users

LANTRONIX® SLC 8048

Host: slc4331
User: sysadmin

Select port for: Configuration WebSSH (DP only) Connected Device (DP only)

Logout

Network Services **User Authentication** Devices Maintenance Quick Setup

Auth Methods Local/Remote Users NIS LDAP RADIUS Kerberos TACACS+ Groups SSH Keys Custom Menus

Local/Remote Users [Help?](#)

Enable Local Users: Local and remote accounts on the SLC are used to authenticate users who login to the SLC via SSH, Telnet, the Web or the Console Port.

Multiple Sysadmin Web Logins:

Sysadmin Access Limited to Console Port:

Authenticate only remote users who are in the remote users list: Note: remove Escape & Break Sequences for users making raw binary connections to Device Ports.

Local User Passwords

Complex Passwords: Password Lifetime: days

Allow Reuse: Warning Period: No Yes: days

Reuse History: Max Login Attempts: No Yes:

Lockout Period: No Yes: minutes

Select the radio button in the right column to edit or delete a user. Shaded users are locked (cannot login).

Local Users (1 users) & Remote Users (0 users)											<input type="button" value="View Local Users"/>	<input type="button" value="View Remote Users"/>
Login	Auth	UID	Group	Permissions	Esc Seq	Brk Seq	Custom Menu	DB	Listen	Data	Clear	
sysadmin	Local	0	Adm	fa.nt.sv.lu.ra.dt.sk.um.dp.do.ub.rs.fc.dr.sn.wb.sd.md.rp	\x1bA	\x1bB		N	1-48,U1,U2	1-48,U1,U2	1-48,U1,U2	<input type="radio"/>

The top of the page has entry fields for enabling local and remote users and for setting password requirements. The bottom of the page displays a table listing and describing all local and remote users.

To enable local and/or remote users:

- 1) Enter the following:

Enable Local Users	Select to enable all local users except sysadmin. The sysadmin is always available regardless of how you set the check box. Enabled by default.
Multiple Sysadmin Web Logins	Select to allow the sysadmin to have multiple simultaneous logins to the web interface. Disabled by default.
Sysadmin Access Limited to Console Port	Select to limit sysadmin logins to the Console Port only. Disabled by default.
Authenticate only remote users who are in the remote users list	Select the check box to authenticate users listed in the Remote Users list in the lower part of the page. Disabled by default.

2) Continue to set **Local User Passwords**:

Complex Passwords	Select to enable the SLC unit to enforce rules concerning the password structure (e.g., alphanumeric requirements, number of characters, punctuation marks). Disabled by default. Complexity rules: Passwords must be at least eight characters long. They must contain one upper case letter (A-Z), one lower case letter (a-z), one digit (0-9), and one punctuation character ((` ~ ! @ # \$ % ^ & * - + = \ }] ; : " ' < > . ? / _).
Allow Reuse	Select to enable users to continue to reuse old passwords. If you disable the check box, they cannot use any of the Reuse History number of passwords. Enabled by default.
Reuse History	The number of passwords the user must use before reusing an old password. The default is 4 . For example, if you set reuse history to 4, the user may reuse an old password after using 4 other passwords.
Password Lifetime (days)	The number of days until the password expires. The default setting is 90 .
Warning Period (days)	The number of days ahead that the system warns that the user's password will expire. The default setting is 7 .
Max Login Attempts	The number of times (up to 8) the user can attempt to log in unsuccessfully before the system locks the user out. The default setting is 0 (disabled).
Lockout Period (minutes)	The number of minutes (up to 90) the locked-out user must wait before trying to log in to the web interface again. The default setting is 0 (disabled).

2. Click the **Apply** button.**Adding, Editing or Deleting a User**

Through this [User Authentication > Local/Remote Users](#) page, you can delete a user listed in the table or open a page for adding or editing a user.

To add a user:

1. On the [User Authentication > Local/Remote Users](#), click the **Add/Edit User** button. The [User Authentication > Local/Remote User > Add/Edit User](#) page displays.

Figure 12-4 User Authentication > Local/Remote User > Add/Edit User

LANTRONIX® SLC 8048

Logout Host: slc4331 User: sysadmin

Select port for Configuration WebSSH (DP only) Connected Device (DP only)

Network Services **User Authentication** Devices Maintenance Quick Setup

Auth Methods Local/Remote Users NIS LDAP RADIUS Kerberos TACACS+ Groups SSH Keys Custom Menus

Local/Remote User Settings Help?

Login:

Authentication: Local Remote

UID:

Listen Ports:

Data Ports:

Clear Port Buffers:

Enable for Dial-back:

Dial-back Number:

Escape Sequence:

Break Sequence:

Custom Menu:

Display Menu at Login:

Password:

Retype Password:

Password Expires:

Allow Password Change:

Change Password on Next Login:

Lock Account:

Account Status: **Active**

Group: Default Users Power Users Administrators Custom Group:

Each user is a member of a group which has predefined user rights associated with it. User rights that are associated with a group cannot be modified for individual users.

Full Administrative: Local Users: Firmware & Configuration:

Networking: Remote Authentication: Internal Modem:

Services: SSH Keys: Device Port Operations:

Secure Lantronix Network: User Menus: Device Port Configuration:

Date/Time: Web Access: USB:

Reboot & Shutdown: Diagnostics & Reports: SD Card:

RPMS:

[Back to Local/Remote Users](#)

2. Enter the following information for the user:

Login	User ID of selected user.
Authentication	Select the type of authenticated user: <ul style="list-style-type: none"> ◆ Local: User listed in the SLC database. ◆ Remote: User not listed in the SLC database.
UID	A unique numeric identifier the system administrator assigns to each user. Valid UIDs are 101-4294967295. <p>Note: The UID must be unique. If it is not, SLC unit automatically increments it. Starting at 101, the SLC 8000 advanced console manager finds the next unused UID.</p>
Listen Ports	The device ports that the user may access to view data using the connect listen command. Enter the port numbers or the range of port numbers (for example, 1, 5, 8, 10-15). U1 and U2 denote the USB upper and lower ports on the front of the SLC unit.
Data Ports	The device ports with which the user may interact using the connect direct command. Enter the port numbers or the range of port numbers.
Clear Port Buffers	The device port buffers the users may clear using the <code>set locallog clear</code> command. Enter the port numbers or the range of port numbers.

Enable for Dial-back	Select to grant a local user dial-back access. Users with dial-back access can dial into the SLC unit and enter their login and password. Once the SLC 8000 advanced console manager authenticates them, the modem hangs up and dials them back. Disabled by default.
Dial-back Number	The phone number the modem dials back on depends on this setting for the device port. The user is either dialed back on a fixed number (specified on the Device Port - Settings page), or on a number that is associated with the user's login (specified here).
Escape Sequence	<p>A single character or a two-character sequence that causes the SLC unit to leave direct (interactive) mode. (To leave listen mode, press any key.)</p> <p>A suggested value is Esc+A (escape key, then uppercase "A" performed quickly but not simultaneously). You would specify this value as \x1bA, which is hexadecimal (\x) character 27 (1B) followed by an A.</p> <p>This setting allows the user to terminate the <code>connect direct</code> command on the command line interface when the endpoint of the command is <code>deviceport</code>, <code>tcp</code>, or <code>udp</code>.</p> <p>See Key Sequences on page 183 for notes on key sequence precedence and behavior.</p>
Break Sequence	<p>A series of 1-10 characters users can enter on the command line interface to send a break signal to the external device. A suggested value is Esc+B (escape key, then uppercase "B" performed quickly but not simultaneously). You would specify this value as \x1bB, which is hexadecimal (\x) character 27 (1B) followed by a B.</p> <p>See Key Sequences on page 183 for notes on key sequence precedence and behavior.</p>
Custom Menu	<p>If custom menus have been created, you can assign a default custom menu to the user. The custom menu will display at login.</p> <p>Note: In the <i>Local Users</i> table, if the menu assigned to a local user no longer exists, it is marked with an asterisk (*).</p>
Display Menu at Login	If custom menus have been created, select to enable the menu to display when the user logs into the CLI.
Password / Retype Password	When a user logs into the SLC 8000 advanced console manager, the SLC unit prompts for a password (up to 64 characters). The sysadmin establishes that password here.
Password Expires	If not selected, allows the user to keep a password indefinitely. If selected the user keeps the password for a set period. (See the section, Local and Remote User Settings (on page 221) for information on specifying the length of time before the password expires.)
Allow Password Change	Select to allow the user to change password.
Change Password on Next Login	Indicate whether the user must change the password at the next login.
Lock Account	Select to lock the account indefinitely.
Account Status	<p>Displays the current account status:</p> <ul style="list-style-type: none"> ◆ Active ◆ Locked ◆ Locked (invalid logins)

3. In the **User Rights** section, select the user group to which local/remote users will belong.

Group	<p>Select the group to which the local or remote user will belong:</p> <ul style="list-style-type: none"> ◆ Default Users: This group has only the most basic rights. You can specify additional rights for the individual user. ◆ Power Users: This group has the same rights as Default Users plus Web Access, Networking, Date/Time, Reboot & Shutdown, and Diagnostics & Reports. ◆ Administrators: This group has all possible rights. ◆ Custom Group: Select a custom group from the drop-down menu.
--------------	---

4. Select or clear the checkboxes for the following rights:

Full Administrative	Right to add, update, and delete all editable fields.
Networking	Right to enter Network settings.
Services	Right to enable and disable system logging, SSH and Telnet logins, SNMP, and SMTP.
Secure Lantronix Network	Right to view and manage Secure Lantronix units (e.g., Spider, or SLC units) on the local subnet.
Date/Time	Right to set the date and time.
Reboot & Shutdown	Right to shut down and reboot the SLC unit.
Local Users	Right to add or delete local users on the system.
Remote Authentication	Right to assign a remote user to a user group and assign a set of rights to the user.
SSH Keys	Right to set SSH keys for authenticating users.
User Menus	Right to create a custom user menu for the CLI.
Web Access	Right to access Web-Manager.
Diagnostics & Reports	Right to obtain diagnostic information and reports about the unit.
Firmware & Configuration	Right to upgrade the firmware on the unit and save or restore a configuration (all settings). Selecting this option automatically selects Reboot & Shutdown.
Internal Modem	Right to update internal modem settings.
Device Port Operations	Right to control device ports.
Device Port Configuration	Right to enter device port settings.
USB	Right to enter modem settings for USB devices and control USB storage devices.
SD Card	Right to enter settings for SD card.
RPM	Right to manage and control remote power managers.

5. Click the **Apply** button.
6. Click the **Back to Local/Remote Users** link to return to the Local/Remote User Settings page.
7. Add another user or click the **Back to Local/Remote Users** link. The Local/Remote Users page displays with the new user(s) listed in the table.

Note: The logged-in user's name displays at the top of the web page. Only the tabs and options for which the user has rights display.

Shortcut

To add a user based on an existing user:

1. Display the existing user on the [User Authentication > Local/Remote Users](#) page. The fields in the top part of the page display the current values for the user.
2. Change the Login to that of the new user. It is best to change the Password too.
3. Click the **Apply** button.

To edit a local user:

1. On the [User Authentication > Local/Remote Users](#) page, select the user and click the **Add/Edit User** button. The Local/Remote User Settings page displays.
2. Update values as desired.
3. Click the **Apply** button.

To delete a local user:

1. On the [User Authentication > Local/Remote Users](#) page, select the user and click the **Add/Edit User** button. The Local/Remote User Settings page displays.
2. Click the **Delete User** button.
3. Click the **Apply** button.

To change the sysadmin password:

1. On the [User Authentication > Local/Remote Users](#) page, select **sysadmin** and click the **Add/Edit User** button. The Local/Remote User Settings page displays.
2. Enter the new password in the Password and Retype Password fields.

Note: You can change Escape Sequence and Break Sequence, if desired. You cannot delete the UID or change the UID, port permissions, or custom menu.

3. Click the **Apply** button.

Local Users Commands

The following CLI commands correspond to the web page entries described above.

To configure local accounts (including sysadmin) who log in to the SLC 8000 advanced console manager by means of SSH, Telnet, the Web, or the console port:

```
set localusers add|edit <User Login> <parameters>
```

Parameters

```
allowdialback <enable|disable>
breakseq <1-10 Chars>
changenextlogin <enable|disable>
changepassword <enable|disable>
clearports <Port List>
custommenu <Menu Name>
```

```

dataports <Port List>
dialbacknumber <Phone Number>
displaymenu <enable|disable>
escapeseq <1-10 Chars>
group <default|power|admin|Custom Group Name>
listenports <Port List>
passwordexpires <enable|disable>
permissions <Permission List>
uid <User Identifier>

```

To configure settings for local user passwords and logins:

```

set localusers complexpasswords <enable|disable>
set localusers allowreuse <enable|disable>
set localusers reusehistory <Number of Passwords>
set localusers lifetime <Number of Days>
set localusers periodwarning <Number of Days>
set localusers maxloginattempts <Number of Logins>
set localusers periodlockout <Number of Minutes>
set localusers multipleadminlogins <enable|disable>
set localusers consoleonlyadmin <enable|disable>

```

To enable or disable authentication of local users:

```

set localusers state <enable|disable>

```

To set a login password for the local user:

```

set localusers password <User Login>

```

To delete a local user:

```

set localusers delete <User Login>

```

To view settings for all users or a local user:

```

show localusers [display <brief|extended>][user <User Login>]

```

To allow (unlock) or block (lock) to a user's ability to log in:

```

set localusers lock|unlock <User Login>

```

Local User Rights Commands

The following CLI commands correspond to the web page entries described above.

To add a local user to a user group or to change the group the user belongs to:

```

set localusers add|edit <user> group <default|power|admin>

```

To set a local user's permissions (not defined by the user group):

```

set localusers add|edit <user> permissions <Permission List>

```

where

<Permission List> is one or more of nt, sv, dt, lu, ra, sk, um, dp, do, ub, rp, rs, rc, dr, wb, sn, ad, md, sd

To remove a permission, type a minus sign before the two-letter abbreviation for a user right.

To view the rights of the currently logged-in user:

```
show user
```

Remote User Commands

The following CLI commands correspond to the web page entries described above.

To configure whether remote users who are not part of the remote user list will be authenticated:

```
set remoteusers listonlyauth <enable|disable>
```

To configure attributes for users who log in by a remote authentication method:

```
set remoteusers add|edit <User Login> [<parameters>]
```

Parameters

```
allowdialback <enable|disable>
breakseq <1-10 Chars>
clearports <Port List>
custommenu <Menu Name>
dataports <Port List>
dialbacknumber <Phone Number>
displaymenu <enable|disable>
escapeseq <1-10 Chars>
group <default|power|admin|Custom Group Name>
listenports <Port List>
permissions <Permissions List>
```

where

<Permission List> is one or more of nt, sv, dt, lu, ra, sk, um, dp, do, ub, rp, rs, rc, dr, wb, sn, ad, md, sd

To remove a permission, type a minus sign before the two-letter abbreviation for a user right.

To remove a remote user:

```
set remoteusers delete <User Login>
```

Allow (unlock) or block (lock) a user's ability to login:

```
set remoteusers lock|unlock <User Login>
```

To view settings for all remote users:

```
show remoteusers[display <brief|extended>] [user <User Login>]
```

To view the rights of the currently logged-in user:

```
show user
```

NIS

The system administrator can configure the SLC advanced console manager to use NIS to authenticate users attempting to log in to the SLC unit through the Web, SSH, Telnet, or the console port. If NIS does not provide port permissions, you can use this page to grant device port access to users who are authenticated through NIS.

All NIS users are members of a group that has predefined user rights associated with it. You can assign additional user rights that are not defined by the group.

To configure the SLC unit to use NIS to authenticate users:

1. Click the **User Authentication** tab and select the **NIS** option.

Figure 12-5 User Authentication > NIS

LANTRONIX® SLC 8048

Logout Host: slc4331 User: sysadmin

Select port for Configuration WebSSH (DP only) Connected Device (DP only)

Network Services **User Authentication** Devices Maintenance Quick Setup

Auth Methods Local/Remote Users NIS LDAP RADIUS Kerberos TACACS+ Groups SSH Keys Custom Menus

NIS Help?

Enable NIS:

NIS Domain:

Note: The NIS Domain must match the NIS domain name on the NIS Server.

Broadcast for NIS Server:

NIS Master Server:

NIS Slave Server #1:

NIS Slave Server #2:

NIS Slave Server #3:

NIS Slave Server #4:

NIS Slave Server #5:

Custom Menu:

Escape Sequence:

Break Sequence:

Enable for Dial-back:

Dial-back Number:

Data Ports:

Listen Ports:

Clear Port Buffers:

User Rights

Group: Default Users Power Users Administrators

All NIS users are members of a group which has predefined user rights associated with it. Additional rights which are not defined by the group can be added.

Full Administrative: Local Users: Firmware & Configuration:

Networking: Remote Authentication: Internal Modem:

Services: SSH Keys: Device Port Operations:

Secure Lantronix Network: User Menus: Device Port Configuration:

Date/Time: Web Access: USB:

Reboot & Shutdown: Diagnostics & Reports: SD Card:

RPMs:

Apply

2. Enter the following:

Enable NIS	Displays selected if you enabled this method on the Authentication Methods page. If you want to set up this authentication method but not enable it immediately, clear the checkbox. <i>Note:</i> You can enable NIS here or on the first User Authentication page. If you enable NIS here, it automatically displays at the end of the order of precedence on the User Authentication page.
NIS Domain	The NIS domain of the SLC 8000 advanced console manager must be the same as the NIS domain of the NIS server.
Broadcast for NIS Server	If selected, the SLC unit sends a broadcast datagram to find the NIS Server on the local network.
NIS Master Server	The IP address or host name of the master server.
NIS Slave Servers #1 -5	The IP addresses or host names of up to five slave servers.
Custom Menu	If custom menus have been created you can assign a default custom menu to NIS users.
Escape Sequence	A single character or a two-character sequence that causes the SLC 8000 advanced console manager to leave direct (interactive) mode. (To leave listen mode, press any key.) A suggested value is Esc+A (escape key, then uppercase "A" performed quickly but not simultaneously). You would specify this value as \x1bA , which is hexadecimal (\x) character 27 (1B) followed by an A . This setting allows the user to terminate the connect direct command on the command line interface when the endpoint of the command is deviceport, tcp, or udp. See Key Sequences on page 183 for notes on key sequence precedence and behavior.
Break Sequence	A series of 1-10 characters users can enter on the command line interface to send a break signal to the external device. A suggested value is Esc+B (escape key, then uppercase "B" performed quickly but not simultaneously). You would specify this value as \x1bB , which is hexadecimal (\x) character 27 (1B) followed by a B .
Enable for Dial-back	Select to grant a user Dial-back (on page 179) . Users with dial-back access can dial into the SLC 8000 advanced console manager and enter their login and password. Once the SLC unit authenticates them, the modem hangs up and dials them back. Disabled by default.
Dial-back Number	The phone number the modem dials back on depends on this setting for the device port. The user is either dialed back on a fixed number, or on a number that is associated with the user's login (specified here).
Data Ports	The ports users are able to monitor and interact with using the connect direct command. Enter the port numbers or the range of port numbers (for example, 1, 5, 8, 10-15). U1 and U2 denote the USB upper and lower ports on the front of the SLC unit.
Listen Ports	The ports users are able to monitor using the connect listen command.
Clear Port Buffers	The ports whose port buffer users may clear using the set locallog clear command.

3. In the **User Rights** section, select the user **Group** to which NIS users will belong:

Group	<p>Select the group to which the NIS users will belong:</p> <ul style="list-style-type: none"> ◆ Default Users: This group has only the most basic rights. You can specify additional rights for the individual user . ◆ Power Users: This group has the same rights as Default Users plus Web Access, Networking, Date/Time, Reboot & Shutdown, and Diagnostics & Reports. ◆ Administrators: This group has all possible rights.
--------------	--

4. Assign or unassign **User Rights** for the specific user by checking or unchecking the following checkboxes:

Full Administrative	Right to add, update, and delete all editable fields.
Networking	Right to enter Network settings.
Services	Right to enable and disable system logging, SSH and Telnet logins, SNMP, and SMTP.
Secure Lantronix Network	Right to view and manage secure Lantronix units (e.g., Spider, or SLC units) on the local subnet.
Date/Time	Right to set the date and time.
Reboot & Shutdown	Right to shut down and reboot the SLC unit.
Local Users	Right to add or delete local users on the system.
Remote Authentication	Right to assign a remote user to a user group and assign a set of rights to the user.
SSH Keys	Right to set SSH keys for authenticating users.
User Menus	Right to create a custom user menu for the CLI.
Web Access	Right to access Web-Manager.
Diagnostics & Reports	Right to obtain diagnostic information and reports about the unit.
Firmware & Configuration	Right to upgrade the firmware on the unit and save or restore a configuration (all settings). Selecting this option automatically selects Reboot & Shutdown.
Internal Modem	Right to update internal modem settings.
Device Port Operations	Right to control device ports.
Device Port Configuration	Right to enter device port settings.
USB	Right to enter modem settings for USB devices and control USB storage devices.
SD Card	Right to enter settings for SD card.
RPM	Right to manage and control remote power managers.

5. Click the **Apply** button.

Note: You must reboot the unit before your changes will take effect.

NIS Commands

These commands for the CLI correspond to the web page entries described above.

To configure the SLC unit to use NIS to authenticate users who log in via the Web, SSH, Telnet, or the console port:

```
set nis <one or more parameters>
```

Parameters

```
allowdialback <enable|disable>
breakseq <1-10 Chars>
broadcast <enable|disable>
clearports <Port List>
dataports <Port List>
dialbacknumber <Phone Number>
domain <NIS Domain Name>
escapeseq <1-10 Chars>
listenports <Port List>
master <IP Address or Hostname>
slave1 <IP Address or Hostname>
slave2 <IP Address or Hostname>
slave3 <IP Address or Hostname>
slave4 <IP Address or Hostname>
slave5 <IP Address or Hostname>
state <enable|disable>
```

To set group and permissions for NIS users:

```
set nis group <default|power|admin>
```

To set permissions for NIS users not already defined by the user rights group:

```
set nis permissions <Permission List>
```

where

<Permission List> is one or more of nt, sv, dt, lu, ra, sk, um, dp, do, ub, rp, rs, rc, dr, wb, sn, ad, md, sd

To remove a permission, type a minus sign before the two-letter abbreviation for a user right.

To set a default custom menu for NIS users:

```
set nis custommenu <Menu Name>
```

To view NIS settings:

```
show nis
```

LDAP

The system administrator can configure the SLC 8000 advanced console manager to use LDAP to authenticate users attempting to log in using the Web, Telnet, SSH, or the console port.

LDAP allows SLC unit users to authenticate using a wide variety of LDAP servers, such as OpenLDAP and Microsoft Active Directory. The LDAP implementation supports LDAP servers that do not allow anonymous queries.

Users who are authenticated through LDAP are granted device port access through the port permissions on this page.

All LDAP users are members of a group that has predefined user rights associated with it. You can add additional user rights that are not defined by the group.

To configure the SLC unit to use LDAP to authenticate users:

1. Click the **User Authentication** tab and select **LDAP**. The following page displays.

Figure 12-6 User Authentication > LDAP

LANTRONIX[®] SLC 8048

Logout Host: slc4331 User: sysadmin

Select port for Configuration WebSSH (DP only) Connected Device (DP only)

LDAP [Help ?](#)

Enable LDAP:

Server #1:

Server #2:

Port:

Base:
(example: dc=domain,dc=com)

Bind Name:

Bind Password:

Retype Password:

Bind with Login: 'Slogin' in the Bind Name will be substituted with the login

User Login Attribute:

Group Filter Objectclass:

Group Member Attribute:

Group Member Value: DN Name

Use LDAP Schema: for User Attributes and Permissions

Active Directory Support:

Encrypt Messages: Disabled Start TLS SSL

Certificate Authority: [Upload File >](#)

Certificate File: [Upload File >](#)

Key File: [Upload File >](#)

Custom Menu:

Escape Sequence:

Break Sequence:

Data Ports:

Listen Ports:

Clear Port Buffers:

Enable for Dial-back:

Dial-back Number:

User Rights

Group: Default Users Power Users Administrators

All LDAP users are members of a group which has predefined user rights associated with it. Additional rights which are not defined by the group can be added.

Full Administrative:

Networking:

Services:

Secure Lantronix Network:

Date/Time:

Reboot & Shutdown:

RPMs:

Local Users:

Remote Authentication:

SSH Keys:

User Menus:

Web Access:

Diagnostics & Reports:

Firmware & Configuration:

Internal Modem:

Device Port Operations:

Device Port Configuration:

USB:

SD Card:

2. Enter the following:

<p>Enable LDAP</p>	<p>Displays selected if you enabled this method on the first User Authentication page. If you want to set up this authentication method but not enable it immediately, clear the checkbox.</p>
---------------------------	--

Server #1 (or Server #2)	The IPv4 or IPv6 address or host name of the primary and secondary LDAP servers. The secondary LDAP server will be used for authentication in the event that the primary LDAP server cannot be reached.
Port	Number of the TCP port on the LDAP server to which the SLC talks. The default is 389 .
Base	The name of the LDAP search base (e.g., dc=company, dc=com). May have up to 80 characters.
Bind Name	The name for a non-anonymous bind to an LDAP server. This item has the same format as LDAP Base. One example is cn=administrator,cn=Users,dc=domain,dc=com
Bind Password / Retype Password	Password for a non-anonymous bind. This entry is optional. Acceptable characters are a-z , A-Z , and 0-9 . The maximum length is 127 characters.
Bind with Login	Select to bind with the login and password that a user is authenticating with. This requires that the Bind Name contain the \$login token, which will be replaced with the current login. For example, if the Bind Name is uid=\$login,ou=People,dc=lantronix,dc=com, and user roberts logs into the SLC 8000 advanced console manager, LDAP will bind with uid=roberts,ou=People,dc=lantronix,dc=com and the password entered by roberts.
User Login Attribute	The attribute used by the LDAP server for user logins. If nothing is specified for the user filter, the SLC unit will use "uid". For AD LDAP servers, the attribute for user logins is typically "sAMAccountName".
Group Filter Objectclass	The objectclass used by the LDAP server for groups. If nothing is specified for the group filter, the SLC 8000 advanced console manager will use "posixGroup". For AD LDAP servers, the objectclass for groups is typically "Group".
Group Member Attribute	The attribute used by the LDAP server for group membership. This attribute may be used to search for a name (ie, "msmith") or a Distinguished Name (ie, "uid=msmith,ou=People,dc=lantronix,dc=com"). Select either Name or DN as appropriate for the LDAP server. If nothing is specified for the group membership attribute, the SLC unit will use "memberUID" for name and "uniqueMember" for DN. For AD LDAP servers, the Group Membership Value is typically DN, with the Group Membership Attribute of "member".
Group Member Value	The attribute used by the LDAP server for group membership. This attribute may be used to search for a name (ie, "msmith") or a Distinguished Name (ie, "uid=msmith,ou=People,dc=lantronix,dc=com"). Select either Name or DN as appropriate for the LDAP server. If nothing is specified for the group membership attribute, the SLC 8000 advanced console manager will use "memberUID" for name and "uniqueMember" for DN. For AD LDAP servers, the Group Membership Value is typically DN, with the Group Membership Attribute of "member".
Use LDAP Schema	Select the check box to obtain remote user attributes (group/permissions and port access) from an Active Directory server's scheme via the user attribute 'Secure LantronixPerms' (see details below). Disabled by default.
Active Directory Support	Select to enable. Active Directory is a directory service from Microsoft that is a part of Windows 2000 and later versions of Windows. It is LDAP- and Kerberos-compliant. Disabled by default.

Encrypt Messages	Select Start TLS or SSL to encrypt messages between the SLC unit and the LDAP server. If Start TLS is selected, the port will automatically be set to 389 and the StartTLS extension will be used to initiate a secure connection; if SSL is selected, the port will automatically be set to 636 and a SSL tunnel will be used for LDAP communication. The port number can be changed to a non-standard LDAP port; if the port number is set to anything other than 636, Start TLS will be used as the encryption method. Disabled by default.
Certificate Authority	A certificate can be uploaded to the SLC unit for peer authentication. In non-FIPS mode, the uploaded certificate may contain a Certificate Authority file, a Certificate file (with an optional Key file), or both. A Key file alone is not a valid certificate. In FIPS mode, all 3 files (CA, certificate and key) are required. The Certificate Authority and Certificate File are in PEM format, for instance: -----BEGIN CERTIFICATE----- (certificate in base64 encoding) -----END CERTIFICATE----- The Key File is in PEM format, eg: -----BEGIN RSA PRIVATE KEY----- (private key in base64 encoding) -----END RSA PRIVATE KEY-----
Certificate File	
Key File	
Custom Menu	If custom menus have been created, you can assign a default custom menu to LDAP users. (See “Custom Menus” on page 264.)
Escape Sequence	A single character or a two-character sequence that causes the SLC 8000 advanced console manager to leave direct (interactive) mode. (To leave listen mode, press any key.) A suggested value is Esc+A (escape key, then uppercase "A" performed quickly but not simultaneously). You would specify this value as \x1bA , which is hexadecimal (\x) character 27 (1B) followed by an A . This setting allows the user to terminate the <code>connect direct</code> command on the command line interface when the endpoint of the command is deviceport, tcp, or udp. See Key Sequences on page 183 for notes on key sequence precedence and behavior.
Break Sequence	A series of 1-10 characters users can enter on the command line interface to send a break signal to the external device. A suggested value is Esc+B (escape key, then uppercase "B" performed quickly but not simultaneously). You would specify this value as \x1bB , which is hexadecimal (\x) character 27 (1B) followed by a B .
Enable for Dial-back	Select to grant a user dial-back access. Users with dial-back access can dial into the SLC unit and enter their login and password. Once the SLC 8000 advanced console manager authenticates them, the modem hangs up and dials them back. Disabled by default.
Dial-back Number	The phone number the modem dials back on depends on this setting for the device port. The user is either dialed back on a fixed number, or on a number that is associated with the user's login (specified here).
Data Ports	The ports users are able to monitor and interact with using the <code>connect direct</code> command. U1 and U2 denote the USB upper and lower ports on the front of the SLC unit.
Listen Ports	The ports users are able to monitor using the <code>connect listen</code> command.
Clear Port Buffers	The ports whose port buffer users may clear using the <code>set locallog clear</code> command.

3. In the **User Rights** section, select the user group to which LDAP users will belong:

Group	<p>Select the group to which the LDAP users will belong:</p> <ul style="list-style-type: none"> ◆ Default Users: This group has only the most basic rights. You can specify additional rights for the individual user. ◆ Power Users: This group has the same rights as Default Users plus Web Access, Networking, Date/Time, Reboot & Shutdown, and Diagnostics & Reports. ◆ Administrators: This group has all possible rights.
--------------	--

4. Select or clear the checkboxes for the following rights:

Full Administrative	Right to add, update, and delete all editable fields.
Networking	Right to enter Network settings.
Services	Right to enable and disable system logging, SSH and Telnet logins, SNMP, and SMTP.
Secure Lantronix Network	Right to view and manage secure Lantronix units (e.g., Spider, or SLC devices) on the local subnet.
Date/Time	Right to set the date and time.
Reboot & Shutdown	Right to shut down and reboot the SLC unit.
Local Users	Right to add or delete local users on the system.
Remote Authentication	Right to assign a remote user to a user group and assign a set of rights to the user.
SSH Keys	Right to set SSH keys for authenticating users.
User Menus	Right to create a custom user menu for the CLI.
Web Access	Right to access Web-Manager.
Diagnostics & Reports	Right to obtain diagnostic information and reports about the unit.
Firmware & Configuration	Right to upgrade the firmware on the unit and save or restore a configuration (all settings). Selecting this option automatically selects Reboot & Shutdown.
Internal Modem	Right to configure internal modem settings.
Device Port Operations	Right to control device ports.
Device Port Configuration	Right to enter device port configurations.
USB	Right to enter modem settings for USB.
SD Card	Right to view and enter settings for SD card.
RPM	Right to manage and control remote power managers.

5. Click the **Apply** button.

Note: You must reboot the unit before your changes will take effect.

LDAP Commands

These commands for the command line interface correspond to the web page entries described above.

To configure the SLC unit to use LDAP to authenticate users who log in via the Web, SSH, Telnet, or the console port:

```
set ldap <one or more parameters>
```

Parameters

```
adsupport <enable|disable>
allowdialback <enable|disable>
base <LDAP Base>
bindname <Bind Name>
bindwithlogin <enable|disable>
breakseq <1-10 Chars>
clearports <Port List>
custommenu <Menu Name>
dataports <Port List>
dialbacknumber <Phone Number>
encrypt <starttls|ssl|disable>
escapeseq <1-10 Chars>
filtergroup <Group Objectclass>
filteruser <User Login Attribute>
grmemberattr <Group Membership Attribute>
grmembervalue <dn|name>
group <default|power|admin>
listenports <Port List>
permissions <Permission>
port <TCP Port>
server1 <IP Address or Name>
server2 <IP Address or Name>
state <enable|disable>
useldapschema <enable|disable>
```

To set user group and permissions for LDAP users:

```
set ldap group <default|power|admin>
```

To set permissions for LDAP users not already defined by the user rights group:

```
set ldap permissions <Permission List>
```

where

<Permission List> is one or more of nt, sv, dt, lu, ra, sk, um, dp, do, ub, rp, rs, rc, dr, wb, sn, ad, md, sd

To remove a permission, type a minus sign before the two-letter abbreviation for a user right.

To set a default custom menu for LDAP users:

```
custommenu <Menu Name>
```

To set the LDAP bind password:

```
set ldap set ldap bindpassword
```

To import or delete a certificate:

```
set ldap certificate import via <sftp|scp> rootfile <Cert Auth File>  
    certfile <Certificate File> keyfile <Key File>  
    host <IP Address or Name> login <User Login> [path <Path to Files>]  
set ldap certificate delete
```

To view LDAP settings:

```
show ldap
```

RADIUS

The system administrator can configure the SLC 8000 advanced console manager to use RADIUS to authenticate users attempting to log in using the Web, Telnet, SSH, or the console port.

Users who are authenticated through RADIUS are granted device port access through the port permissions on this page.

All RADIUS users are members of a group that has predefined user rights associated with it. You can add additional user rights that are not defined by the group.

To configure the SLC unit to use RADIUS to authenticate users:

1. Click the **User Authentication** tab and select **RADIUS**. The following page displays.

Figure 12-7 User Authentication > RADIUS

LANTRONIX[®] SLC 8048

Logout Host: slc4331 User: sysadmin

Select port for: Configuration WebSSH (DP only) Connected Device (DP only)

Network Services **User Authentication** Devices Maintenance Quick Setup

Auth Methods Local/Remote Users NIS LDAP RADIUS Kerberos TACACS+ Groups SSH Keys Custom Menus

RADIUS Help ?

Enable RADIUS:

The SLC can be configured to use RADIUS to authenticate users who login to the SLC via SSH, Telnet, the Web or the Console Port. RADIUS users are granted Device Port access through the port permissions below.

RADIUS Server #1:

Server #1 Port:

Server #1 Secret:

RADIUS Server #2:

Server #2 Port:

Server #2 Secret:

Timeout: seconds

Use VSA: for User Attributes and Permissions

Custom Menu:

Escape Sequence:

Break Sequence:

Enable for Dial-back:

Dial-back Number:

Data Ports:

Listen Ports:

Clear Port Buffers:

User Rights

All RADIUS users are members of a group which has predefined user rights associated with it. Additional rights which are not defined by the group can be added.

Group: Default Users Power Users Administrators

Full Administrative:

Networking:

Services:

Secure Lantronix Network:

Date/Time:

Reboot & Shutdown:

RPMs:

Local Users:

Remote Authentication:

SSH Keys:

User Menus:

Web Access:

Diagnostics & Reports:

Firmware & Configuration:

Internal Modem:

Device Port Operations:

Device Port Configuration:

USB:

SD Card:

2. Enter the following:

Enable RADIUS	Displays selected if you enabled this method on the User Authentication page. If you want to set up this authentication method but not enable it immediately, clear the checkbox. Note: You can enable RADIUS here or on the first User Authentication page. If you enable RADIUS here, it automatically displays at the end of the order of precedence on the User Authentication page.
RADIUS Server #1	IPv4 or IPv6 address or hostname of the primary RADIUS server. This RADIUS server may be a proxy for SecurID. SecurID is a two-factor authentication method based on the user's SecurID token and pin number. The SecurID token displays a string of digits called a token code that changes once a minute (some tokens are set to change codes every 30 seconds).
Server #1 Port	Number of the TCP port on the RADIUS server used for the RADIUS service. If you do not specify an optional port, the SLC unit uses the default RADIUS port (1812).

Server #1 Secret	Text that serves as a shared secret between a RADIUS client and the server (SLC unit). The shared secret is used to encrypt a password sent between the client and the server. May have up to 128 characters.
RADIUS Server #2	IPv4 or IPv6 address or host name of the secondary RADIUS server. This server can be used as a SecurID proxy.
Server #2 Port	Number of the TCP port on the RADIUS server used for the RADIUS service. If you do not specify an optional port, the SLC 8000 advanced console manager uses the default RADIUS port (1812).
Server #2 Secret	Text that serves as a shared secret between a RADIUS client and the server (SLC unit). The shared secret is used to encrypt a password sent between the client and the server. May have up to 128 characters.
Timeout	The number of seconds (1-30) after which the connection attempt times out. The default is 30 seconds.
Use VSA	Select the check box to obtain remote user attributes (group/permissions and port access) from the RADIUS server via the Vendor-Specific Attribute (VSA). For details on the format of the VSA, see User Attributes & Permissions from LDAP Schema or RADIUS VSA on page 243 .
Custom Menu	If custom menus have been created, you can assign a default custom menu to RADIUS users.
Escape Sequence	A single character or a two-character sequence that causes the SLC unit to leave direct (interactive) mode. (To leave listen mode, press any key.) A suggested value is Esc+A (escape key, then uppercase "A" performed quickly but not simultaneously). You would specify this value as \x1bA , which is hexadecimal (x) character 27 (1B) followed by an A . This setting allows the user to terminate the <code>connect direct</code> command on the command line interface when the endpoint of the command is <code>deviceport</code> , <code>tcp</code> , or <code>udp</code> . See Key Sequences on page 183 for notes on key sequence precedence and behavior.
Break Sequence	A series of 1-10 characters users can enter on the command line interface to send a break signal to the external device. A suggested value is Esc+B (escape key, then uppercase "B" performed quickly but not simultaneously). You would specify this value as \x1bB , which is hexadecimal (x) character 27 (1B) followed by a B .
Enable for Dial-back	Select to grant a user dial-back access. Users with dial-back access can dial into the SLC 8000 advanced console manager and enter their login and password. Once the SLC device authenticates them, the modem hangs up and dials them back. Disabled by default.
Dial-back Number	The phone number the modem dials back on depends on this setting for the device port. The user is either dialed back on a fixed number, or on a number that is associated with the user's login (specified here).
Data Ports	The ports users are able to monitor and interact with using the <code>connect direct</code> command. U1 and U2 denote the USB upper and lower ports on the front of the SLC unit.
Listen Port	The ports users are able to monitor using the <code>connect listen</code> command.
Clear Port Buffers	The ports whose port buffer users may clear using the <code>set locallog clear</code> command.

Note: Older RADIUS servers may use **1645** as the default port. Check your RADIUS server configuration.

3. In the **User Rights** section, select the user group to which RADIUS users will belong.

Group	Select the group to which the RADIUS users will belong: <ul style="list-style-type: none"> ◆ Default Users: This group has only the most basic rights. You can specify additional rights for the individual user. ◆ Power Users: This group has the same rights as Default Users plus Web Access, Networking, Date/Time, Reboot & Shutdown, and Diagnostics & Reports. ◆ Administrators: This group has all possible rights.
--------------	---

4. Select or clear the checkboxes for the following rights:

Full Administrative	Right to add, update, and delete all editable fields.
Networking	Right to enter Network settings.
Services	Right to enable and disable system logging, SSH and Telnet logins, SNMP, and SMTP.
Secure Lantronix Network	Right to view and manage Secure Lantronix units (e.g., Spider, or SLC units) on the local subnet.
Date/Time	Right to set the date and time.
Reboot & Shutdown	Right to shut down and reboot the SLC unit.
Local Users	Right to add or delete local users on the system.
Remote Authentication	Right to assign a remote user to a user group and assign a set of rights to the user.
SSH Keys	Right to set SSH keys for authenticating users.
User Menus	Right to create a custom user menu for the CLI.
Web Access	Right to access Web-Manager.
Diagnostics & Reports	Right to obtain diagnostic information and reports about the unit.
Firmware & Configuration	Right to upgrade the firmware on the unit and save or restore a configuration (all settings). Selecting this option automatically selects Reboot & Shutdown.
Internal Modem	Right to update internal modem settings.
Device Port Operations	Right to control device ports.
Device Port Configuration	Right to enter device port settings.
USB	Right to enter modem settings for USB devices and control USB storage devices.
SD Card	Right to enter settings for SD card.
RPM	Right to manage and control remote power managers.

5. Click the **Apply** button.

RADIUS Commands

These commands for the command line interface correspond to the web page entries described above.

To configure the SLC unit to use RADIUS to authenticate users who log in via the Web, SSH, Telnet, or the console port:

```
set radius <one or more parameters>
```

Parameters

```

allowdialback <enable|disable>
breakseq <1-10 Chars>
clearports <Port List>
dataports <Port List>
dialbacknumber <Phone Number>
escapeseq <1-10 Chars>
listenports <Port List>
state <enable|disable>
usevsa <enable|disable>

```

To identify the RADIUS server(s), the text secret, and the number of the TCP port on the RADIUS server:

```

set radius server <1|2> host <IP Address or Hostname> secret <Secret>
[port <TCP Port>]

```

The default port is 1812.

To set the number of seconds after which the connection attempt times out:

```

set radius timeout <disable|1-30>

```

May be 1-30 seconds.

To set user group and permissions for RADIUS users:

```

set radius group <default|power|admin>

```

To set permissions for RADIUS users not already defined by the user rights group:

```

set radius permissions <Permission List>

```

where

<Permission List> is one or more of nt, sv, dt, lu, ra, sk, um, dp, do, ub, rp, rs, rc, dr, wb, sn, ad, md, sd

To remove a permission, type a minus sign before the two-letter abbreviation for a user right.

To set a default custom menu for RADIUS users:

```

set radius custommenu <Menu Name>

```

To view RADIUS settings:

```

show radius

```

User Attributes & Permissions from LDAP Schema or RADIUS VSA

Remote user attributes (group/permissions and port access) can be obtained from an Active Directory server's schema via the user attribute 'secureLinxSLCPerms', or from a RADIUS server's Vendor-Specific Attribute (see below). This attribute is a set of parameter-value pairs. Each parameter and value is separated by a space, and a space separates each parameter-value pair. Whitespace is not supported in the value strings. The parameters that are supported are:

- ◆ **rights** - User rights. The value string is a comma-separated list of two letter user permissions. Example: "nt,wb,ra".
- ◆ **data** - Data port access. The value string specifies the list of ports the user has 'direct' access to. Example: "2,4-18,U1,U2".
- ◆ **listen** - Listen port access. The value string specifies the list of ports the user has 'listen' access to.
- ◆ **clear** - Clear port access. The value string specifies the list of port buffers the user has the right to clear.
- ◆ **group** - User group. Valid values for the value string are "default", "power", and "admin", and any SLC custom group name. If a custom group name is specified and it matches a current SLC custom group name, any rights attribute will be ignored, and the custom group's rights (permissions) will be used instead. A group name with spaces cannot be specified.
- ◆ **escseq** - Escape sequence. The value string specifies the user's escape sequence. Use "\x" to specify non-printable characters. For example, "\x1bA" specifies the sequence "ESC-A".
- ◆ **brkseq** - Break sequence. The value string specifies the user's break sequence.
- ◆ **menu** - Custom user menu. The value string specifies the user's custom user menu.
- ◆ **display** - Display custom user menu when a user logs into the CLI. Valid values for the value string are "yes" and "no".
- ◆ **dbnumber** - Dial-back number. The value string specifies the user's dial-back number for modem dial-back connections.
- ◆ **allowdb** - Allow a user to have dial-back access. Valid values for the value string are "yes" and "no".

RADIUS servers will need to be configured to support the Lantronix Vendor-Specific Attribute. For example, on a FreeRADIUS server, the dictionary will need be updated with the Lantronix definition by including the contents below in a file named *dictionary.lantronix*, and including it in the RADIUS server dictionary definitions by adding the appropriate `$INCLUDE` directive to the main dictionary file.

```
# dictionary.lantronix
#
# Lantronix SLC Console Manager
# Provides SLC-specific user attributes
#
VENDOR Lantronix 244

BEGIN-VENDOR Lantronix

ATTRIBUTE Lantronix-User-Attributes 1 string

END-VENDOR Lantronix
```

Once this is complete, the users file can be updated to include the Lantronix VSA for any user:

```
myuser    Auth-Type := Local, User-Password == "myuser_pwd"
          Reply-Message = "Hello, %u",
          Lantronix-User-Attributes = "data 1-4 listen 1-6 clear 1-4
          group power"
```

Kerberos

Kerberos is a network authentication protocol that provides strong authentication for client/server applications by using secret-key cryptography.

The system administrator can configure the SLC 8000 advanced console manager to use Kerberos to authenticate users attempting to log in using the Web, Telnet, SSH, or the console port.

Users who are authenticated through Kerberos are granted device port access through the port permissions on this page.

All Kerberos users are members of a group that has predefined user rights associated with it. You can add additional user rights that are not defined by the group.

To configure the SLC 8000 advanced console manager to use Kerberos to authenticate users:

1. Click the **User Authentication** tab and select the **Kerberos** option. The following page displays.

Figure 12-8 User Authentication > Kerberos

LANTRONIX[®] SLC 8000

Logout Host: slc4331 User: sysadmin

Select port for Configuration WebSSH (DP only) Connected Device (DP only)

User Authentication | Devices | Maintenance | Quick Setup

Auth Methods | Local/Remote Users | NIS | LDAP | RADIUS | Kerberos | TACACS+ | Groups | SSH Keys | Custom Menus

Kerberos Help ?

Enable Kerberos:

The SLC can be configured to use Kerberos to authenticate users who login to the SLC via SSH, Telnet, the Web or the Console Port. Kerberos users are granted Device Port access through the port permissions below.

Realm:

KDC:

KDC IP Address:

KDC Port:

Use LDAP:

Note: If LDAP is used for user lookup, please configure the [LDAP settings](#).

Custom Menu:

Escape Sequence:

Break Sequence:

Enable for Dial-back:

Dial-back Number:

Data Ports:

Listen Ports:

Clear Port Buffers:

User Rights

Group: Default Users Power Users Administrators

All Kerberos users are members of a group which has predefined user rights associated with it. Additional rights which are not defined by the group can be added.

Full Administrative:

Networking:

Services:

Secure Lantronix Network:

Date/Time:

Reboot & Shutdown:

RPMs:

Local Users:

Remote Authentication:

SSH Keys:

User Menus:

Web Access:

Diagnostics & Reports:

Firmware & Configuration:

Internal Modem:

Device Port Operations:

Device Port Configuration:

USB:

SD Card:

2. Enter the following:

Enable Kerberos	<p>Displays selected if you enabled this method on the User Authentication page. If you want to set up this authentication method but not enable it immediately, clear the checkbox.</p> <p>Note: You can enable Kerberos here or on the first User Authentication page. If you enable Kerberos here, it automatically displays at the end of the order of precedence on the User Authentication page.</p>
Realm	<p>Enter the name of the logical network served by a single Kerberos database and a set of Key Distribution Centers. Usually, realm names are all uppercase letters to differentiate the realm from the Internet domain. Realm is similar in concept to an NT domain.</p>
KDC	<p>A key distribution center (KDC) is a server that issues Kerberos tickets. A ticket is a temporary set of electronic credentials that verify the identity of a client for a particular service.</p> <p>Enter the KDC in the fully qualified domain format (FQDN). An example is SLC.local.</p>
KDC IP Address	<p>Enter the IPv4 or IPv6 address of the Key Distribution Center (KDC).</p>
KDC Port	<p>Port on the KDC listening for requests. Enter an integer with a maximum value of 65535. The default is 88.</p>
Use LDAP	<p>Indicate whether Kerberos should rely on LDAP to look up user IDs and Group IDs. This setting is disabled by default.</p> <p>Note: Make sure to configure LDAP if you select this option.</p>
Custom Menu	<p>If custom menus have been created, you can assign a default custom menu to RADIUS users.</p>
Escape Sequence	<p>A single character or a two-character sequence that causes the SLC 8000 advanced console manager to leave direct (interactive) mode. (To leave listen mode, press any key.)</p> <p>A suggested value is Esc+A (escape key, then uppercase "A" performed quickly but not simultaneously). You would specify this value as \x1bA, which is hexadecimal (x) character 27 (1B) followed by an A.</p> <p>This setting allows the user to terminate the <code>connect direct</code> command on the command line interface when the endpoint of the command is <code>deviceport</code>, <code>tcp</code>, or <code>udp</code>.</p> <p>See Key Sequences on page 183 for notes on key sequence precedence and behavior.</p>
Break Sequence	<p>A series of 1-10 characters users can enter on the command line interface to send a break signal to the external device. A suggested value is Esc+B (escape key, then uppercase "B" performed quickly but not simultaneously). You would specify this value as \x1bB, which is hexadecimal (x) character 27 (1B) followed by a B.</p>
Enable for Dial-back	<p>Select to grant a user dial-back access. Users with dial-back access can dial into the SLC 8000 advanced console manager and enter their login and password. Once the SLC unit authenticates them, the modem hangs up and dials them back. Disabled by default.</p>
Dial-back Number	<p>The phone number the modem dials back on depends on this setting for the device port. The user is either dialed back on a fixed number, or on a number that is associated with the user's login (specified here).</p>
Data Ports	<p>The ports users are able to monitor and interact with using the <code>connect direct</code> command. U1 and U2 denote the USB upper and lower ports on the front of the SLC unit.</p>
Listen Port	<p>The ports users are able to monitor using the <code>connect listen</code> command.</p>

Clear Port Buffers	The ports whose port buffer users may clear using the <code>set locallog clear</code> command.
---------------------------	--

3. In the **User Rights** section, select the user group to which Kerberos users will belong.

Group	<p>Select the group to which the Kerberos users will belong:</p> <ul style="list-style-type: none"> ◆ Default Users: This group has only the most basic rights. You can specify additional rights for the individual user. ◆ Power Users: This group has the same rights as Default Users plus Web Access, Networking, Date/Time, Reboot & Shutdown, and Diagnostics & Reports. ◆ Administrators: This group has all possible rights.
--------------	--

4. Select or clear the checkboxes for the following rights:

Full Administrative	Right to add, update, and delete all editable fields.
Networking	Right to enter Network settings.
Services	Right to enable and disable system logging, SSH and Telnet logins, SNMP, and SMTP.
Secure Lantronix Network	Right to view and manage secure Lantronix units (e.g., Spider, or SLC units) on the local subnet.
Date/Time	Right to set the date and time.
Reboot & Shutdown	Right to shut down and reboot the SLC unit.
Local Users	Right to add or delete local users on the system.
Remote Authentication	Right to assign a remote user to a user group and assign a set of rights to the user.
SSH Keys	Right to set SSH keys for authenticating users.
User Menus	Right to create a custom user menu for the CLI.
Web Access	Right to access Web-Manager.
Diagnostics & Reports	Right to obtain diagnostic information and reports about the unit.
Firmware & Configuration	Right to upgrade the firmware on the unit and save or restore a configuration (all settings). Selecting this option automatically selects Reboot & Shutdown.
Internal Modem	Right to update internal modem settings.
Device Port Operations	Right to control device ports.
Device Port Configuration	Right to enter device port settings.
USB	Right to enter modem settings for USB devices and control USB storage devices.
SD Card	Right to enter settings for SD card.
RPM	Right to manage and control remote power managers.

5. Click the **Apply** button.

Note: You must reboot the unit before your changes will take effect.

Kerberos Commands

These commands for the command line interface correspond to the web page entries described above.

To configure the SLC unit to use Kerberos to authenticate users who log in via the Web, SSH, Telnet, or the console port:

```
set kerberos <one or more parameters>
```

Parameters

```
allowdialback <enable|disable>
breakseq <1-10 Chars>
clearports <Port List>
custommenu <Menu Name>
dataports <Port List>
dialbacknumber <Phone Number>
escapeseq <1-10 Chars>
group <default|power|admin>
ipaddr <Key Distribution Center IP Address>
kdc <Key Distribution Center>
listenports <Port List>
permissions <Permission List>
port <Key Distribution Center TCP Port>
realm <Kerberos Realm>
state <enable|disable>
useldapforlookup <enable|disable>
```

To set user group and permissions for Kerberos users:

```
set kerberos group <default|power|admin>
```

To set permissions for Kerberos users not already defined by the user rights group:

```
set kerberos permissions <Permission List>
```

where

<Permission List> is one or more of nt, sv, dt, lu, ra, sk, um, dp, do, ub, rp, rs, rc, dr, wb, sn, ad, md, sd

To remove a permission, type a minus sign before the two-letter abbreviation for a user right.

To set a default custom menu for Kerberos users:

```
set kerberos custommenu <Menu Name>
```

To view Kerberos settings:

```
show kerberos
```

TACACS+

Similar to RADIUS, the main function of TACACS+ is to perform authentication for remote access. The SLC 8000 advanced console manager supports the TACACS+ protocol (not the older TACACS or XTACACS protocols).

The system administrator can configure the SLC unit to use TACACS+ to authenticate users attempting to log in using the Web, Telnet, SSH, or the console port.

Users who are authenticated through Kerberos are granted device port access through the port permissions on this page.

All TACACS+ users are members of a group with associated predefined user rights. You may add additional user rights that are not defined by the group.

To configure the SLC unit to use TACACS+ to authenticate users:

1. Click the **TACACS+** tab and select **TACACS+**. The following page displays.

Figure 12-9 User Authentication > TACACS+

LANTRONIX[®] SLC 8048

Host: slc48SFP251-7400R11
User: sysadmin

Select port for: Configuration WebSSH (DP only) Connected Device (DP only)

Network Services **User Authentication** Devices Maintenance Quick Setup

Auth Methods Local/Remote Users NIS LDAP RADIUS Kerberos **TACACS+** Groups SSH Keys Custom Menus

TACACS+

Enable TACACS+

TACACS+ Server #1:

TACACS+ Server #2:

TACACS+ Server #3:

Secret:

Encrypt Messages:

Authentication Service: ASCII Login PPP/PAP PPP/CHAP

Timeout: 5 seconds

Custom Menu: <none>

Escape Sequence:

Break Sequence:

Enable for Dial-back:

Dial-back Number:

Data Ports:

Listen Ports:

Clear Port Buffers:

The SLC can be configured to use TACACS+ to authenticate users who login to the SLC via SSH, Telnet, the Web or the Console Port. TACACS+ users are granted Device Port access through the port permissions below.

User Rights

Group: Default Users Power Users Administrators

All TACACS+ users are members of a group which has predefined user rights associated with it. Additional rights which are not defined by the group can be added.

Full Administrative:

Networking:

Services:

Secure Lantronix Network:

Date/Time:

Reboot & Shutdown:

RPMs:

Local Users:

Remote Authentication:

SSH Keys:

User Menus:

Web Access:

Diagnostics & Reports:

Firmware & Configuration:

Internal Modem:

Device Port Operations:

Device Port Configuration:

USB:

SD Card:

Apply

2. Enter the following:

Enable TACACS+	Displays selected if you enabled this method on the User Authentication page. If you want to set up this authentication method but not enable it immediately, clear the checkbox. You can enable TACACS+ here or on the first User Authentication page. If you enable TACACS+ here, it automatically displays at the end of the order of precedence on the User Authentication page.
TACACS+ Servers 1-3	IPv4 or IPv6 address or host name of up to three TACACS+ servers.
Secret	Shared secret for message encryption between the SLC 8000 advanced console manager and the TACACS+ server. Enter an alphanumeric secret of up to 127 characters.
Encrypt Messages	Select the checkbox to encrypt messages between the SLC unit and the TACACS+ server. Selected by default.
Authentication Service	The type of service used to pass the authentication tokens (e.g., login and password) between the SLC and the TACACS+ server. Options are: ASCII Login (login and password are transmitted in clear, unencrypted text), PPP/PAP (login and password are transmitted in clear, unencrypted text via a PAP protocol packet), and PPP/CHAP (the TACACS+ server sends a challenge that consists of a session ID and an arbitrary challenge string, and the user name and password are encrypted before they are sent back to the server). PPP/PAP is the default.
Timeout	The timeout in seconds when attempting to connect to a TACACS+ server. Timeout range is 1 to 10 seconds. 5 seconds is the default.
Custom Menu	If custom menus have been created (see Custom User Menu Commands), you can assign a default custom menu to TACACS+ users.
Escape Sequence	A single character or a two-character sequence that causes the SLC 8000 advanced console manager to leave direct (interactive) mode. (To leave listen mode, press any key.) A suggested value is Esc+A (escape key, then uppercase "A" performed quickly but not simultaneously). You would specify this value as \x1bA , which is hexadecimal (\x) character 27 (1B) followed by an A . This setting allows the user to terminate the <code>connect direct</code> command on the command line interface when the endpoint of the command is <code>deviceport</code> , <code>tcp</code> , or <code>udp</code> .
Break Sequence	A series of 1-10 characters users can enter on the command line interface to send a break signal to the external device. A suggested value is Esc+B (escape key, then uppercase "B" performed quickly but not simultaneously). You would specify this value as \x1bB , which is hexadecimal (\x) character 27 (1B) followed by a B . See Key Sequences for notes on key sequence precedence and behavior.
Enable for Dial-back	Select to grant a user Dial-back access. Users with dial-back access can dial into the SLC unit and enter their login and password. Once the SLC 8000 advanced console manager authenticates them, the modem hangs up and dials them back. Disabled by default.
Dial-back Number	The phone number the modem dials back on depends on this setting for the device port. The user is either Dial-back on a fixed number, or on a number that is associated with the user's login (specified here).
Data Ports	The ports users are able to monitor and interact with using the <code>connect direct</code> command. U1 and U2 denote the USB upper and lower ports on the front of the SLC unit.
Listen Ports	The ports users are able to monitor using the <code>connect listen</code> command.

Clear Port Buffers	The ports whose port buffer users may clear using the <code>set locallog clear</code> command.
---------------------------	--

3. In the **User Rights** section, select the user group to which TACACS+ users will belong.

Group	<p>Select the group to which the TACACS+ users will belong:</p> <ul style="list-style-type: none"> ◆ Default Users: This group has only the most basic rights. You can specify additional rights for the individual user. ◆ Power Users: This group has the same rights as Default Users plus Web Access, Networking, Date/Time, Reboot & Shutdown, and Diagnostics & Reports. ◆ Administrators: This group has all possible rights.
--------------	---

4. Select or clear the checkboxes for the following rights:

Full Administrative	Right to add, update, and delete all editable fields.
Networking	Right to enter Network settings.
Services	Right to enable and disable system logging, SSH and Telnet logins, SNMP, and SMTP.
Secure Lantronix Network	Right to view and manage secure Lantronix units (e.g., Spider, or SLC units) on the local subnet.
Date/Time	Right to set the date and time.
Reboot & Shutdown	Right to shut down and reboot the SLC unit.
Local Users	Right to add or delete local users on the system.
Remote Authentication	Right to assign a remote user to a user group and assign a set of rights to the user.
SSH Keys	Right to set SSH keys for authenticating users.
User Menus	Right to create a custom user menu for the CLI.
Web Access	Right to access Web-Manager.
Diagnostics & Reports	Right to obtain diagnostic information and reports about the unit.
Firmware & Configuration	Right to upgrade the firmware on the unit and save or restore a configuration (all settings). Selecting this option automatically selects Reboot & Shutdown.
Internal Modem	Right to update internal modem settings.
Device Port Operations	Right to control device ports.
Device Port Configuration	Right to enter device port settings.
USB	Right to enter modem settings for USB devices and control USB storage devices.
SD Card	Right to enter settings for SD card.
RPM	Right to manage and control remote power managers.

5. Click the **Apply** button.

Note: You must reboot the unit before your changes will take effect.

TACACS+ Commands

These commands for the command line interface correspond to the web page entries described above.

To configure the SLC unit to use TACACS+ to authenticate users who log in via the Web, SSH, Telnet, or the console port:

```
set tacacs+ <one or more parameters>
```

Parameters

```
state <enable|disable>
server1 <IP Address or Name>
server2 <IP Address or Name>
server3 <IP Address or Name>
secret <TACACS+ Secret>
encrypt <enable|disable>
authservice <login|pap|chap>
timeout <1-10 seconds>
dataports <Port List>
listenports <Port List>
clearports <Port List>
escapeseq <1-10 Chars>
breakseq <1-10 Chars>
custommenu <Menu Name>
allowdialback <enable|disable>
dialbacknumber <Phone Number>
group <default|power|admin>
permissions <Permission List>
```

Notes: See [User Attributes & Permissions from LDAP Schema or RADIUS VSA](#) (on page 243) for information on groups and user rights.

To set user group and permissions for TACACS+ users:

```
set tacacs+ group <default|power|admin>
```

To set permissions for TACACS+ users not already defined by the user rights group:

```
set tacacs+ permissions <Permission List>
```

where

<Permission List> is one or more of nt, sv, dt, lu, ra, sk, um, dp, do, ub, rp, rs, rc, dr, wb, sn, ad, md, sd

To remove a permission, type a minus sign before the two-letter abbreviation for a user right.

To set a default custom menu for TACACS+ users:

```
set tacacs+ custommenu <Menu Name>
```

To view TACACS+ settings:

```
show tacacs+
```

Groups

The SLC 8000 advanced console manager has 3 pre-defined groups: Administrators, Power Users, and Default Users. Custom groups can also be created; each custom group is a set of user attributes and permissions. Local Users and Remote Users defined on the SLC unit can be assigned to one of the pre-defined groups or a custom group. When a user authenticates, if they belong to custom group, they will be granted the custom group attributes and permissions, rather than their individual attributes and permissions. The SLC 8000 advanced console manager supports querying a LDAP server for groups that a LDAP user is a member of; if any of the LDAP group names match a (Custom Group Name), the LDAP user will be granted the rights of the custom group.

A custom group cannot be given the name of one of the pre-defined groups: "Admin", "Power" or "Default" (or any version of these names where the case of the letters is different) since these names are used for the SLC pre-defined groups. Any LDAP group that matches one of these pre-defined group names will be ignored and not used to assign rights to a user.

To configure Groups in the SLC unit:

1. From the main menu, select **User Authentication - Groups**. The following page displays.

Note: If the fields in the lower part of the page have been populated by viewing another group, the fields can be cleared by selecting the Reset Group button.

Figure 12-10 User Authentication > Groups

LANTRONIX[®] SLC 8048

Logout Host: slc4331 User: sysadmin

Select port for Configuration WebSSH (DP only) Connected Device (DP only)

Network Services **User Authentication** Devices Maintenance Quick Setup

Auth Methods Local/Remote Users NIS LDAP RADIUS Kerberos TACACS+ Groups SSH Keys Custom Menus

Groups Help?

Groups									
Id	Name	Permissions	Esc Seq	Brk Seq	Custom Menu	DB	Listen	Data	Clear
0									

Group Id: 0

Group Name:

Listen Ports: Enable for Dial-back: Custom Menu:

Data Ports: Dial-back Number: Display Menu at Login:

Clear Port Buffers: Escape Sequence: Break Sequence:

Full Administrative: Local Users: Firmware & Configuration:
 Networking: Remote Authentication: Internal Modem:
 Services: SSH Keys: Device Port Operations:
 Secure Lantronix Network: User Menus: Device Port Configuration:
 Date/Time: Web Access: USB:
 Reboot & Shutdown: Diagnostics & Reports: SD Card:
 RPMs:

2. Enter the following:

Group Name	Enter a name for the group.
Listen Ports	The ports users are able to monitor using the <code>connect listen</code> command.
Data Ports	The ports users are able to monitor and interact with using the <code>connect direct</code> command. U1 and U2 denote the USB upper and lower ports on the front of the SLC unit.
Clear Port Buffers	The ports whose port buffer users may clear using the <code>set locallog clear</code> command.
Enable for Dial-back	Select to grant a user. Users with dial-back access can dial into the SLC unit and enter their login and password. Once the SLC 8000 advanced console manager authenticates them, the modem hangs up and dials them back. Disabled by default.
Dial-back Number	The phone number the modem dials back on depends on this setting for the device port. The user is either on a fixed number, or on a number that is associated with the user's login (specified here).

Escape Sequence	<p>A single character or a two-character sequence that causes the SLC 8000 advanced console manager to leave direct (interactive) mode. (To leave listen mode, press any key.)</p> <p>A suggested value is Esc+A (escape key, then uppercase "A" performed quickly but not simultaneously). You would specify this value as \x1bA, which is hexadecimal (\x) character 27 (1B) followed by an A.</p> <p>This setting allows the user to terminate the <code>connect direct</code> command on the command line interface when the endpoint of the command is <code>deviceport</code>, <code>tcp</code>, or <code>udp</code>.</p>
Break Sequence	<p>A series of one to ten characters users can enter on the command line interface to send a break signal to the external device. A suggested value is Esc+B (escape key, then uppercase "B" performed quickly but not simultaneously). You would specify this value as \x1bB, which is hexadecimal (\x) character 27 (1B) followed by a B.</p>
Custom Menu	<p>If custom menus have been created you can assign a default custom menu to the group. See Custom Menus for more information.</p>
Display Menu at Login	<p>Check the checkbox to display the menu at login.</p>

3. Select or clear the checkboxes for the following rights:

Full Administrative	Right to add, update, and delete all editable fields.
Networking	Right to enter Network settings.
Services	Right to enable and disable system logging, SSH and Telnet logins, SNMP, and SMTP.
Secure Lantronix Network	Right to view and manage Secure Lantronix units (e.g., Spider, or SLC units) on the local subnet.
Date/Time	Right to set the date and time.
Reboot & Shutdown	Right to shut down and reboot the SLC unit.
Local Users	Right to add or delete local users on the system.
Remote Authentication	Right to assign a remote user to a user group and assign a set of rights to the user.
SSH Keys	Right to set SSH keys for authenticating users.
User Menus	Right to create a custom user menu for the CLI.
Web Access	Right to access Web-Manager.
Diagnostics & Reports	Right to obtain diagnostic information and reports about the unit.
Firmware & Configuration	Right to upgrade the firmware on the unit and save or restore a configuration (all settings). Selecting this option automatically selects Reboot & Shutdown .
Internal Modem	Right to update internal modem settings.
Device Port Operations	Right to control device ports.
Device Port Configuration	Right to enter device port settings.
USB	Right to enter modem settings for USB devices and control USB storage devices.
SD Card	Right to enter settings for SD card.
RPM	Right to manage and control remote power managers.

4. Click the **Add Group** button.

To view or update a group:

1. In the **Groups** table, select the group and click the **View Group** button. The group attributes and permissions will be displayed in the lower section of the page.
2. Modify the group attributes and permissions and click the **Edit Group** button.

To delete a group:

1. Select the group in the **Groups** table.
2. Click the **Delete Group** button.

Group Commands

```
set groups add|edit <Group Name> [<parameters>]
```

Syntax

```
set groups add|edit <Group Name> [<parameters>]
```

Parameters

```
dataports <Port List>  
listenports <Port List>  
clearports <Port List>  
escapeseq <1-10 Chars>  
breakseq <1-10 Chars>  
custommenu <Menu Name>  
displaymenu <enable|disable>  
allowdialback <enable|disable>  
dialbacknumber <Phone Number>  
permissions <Permission List>
```

Note: See 'help user permissions' for information on user rights.

Rename a group:

```
set groups rename <Group Name> newname <New Group Name>
```

Delete a group:

```
set groups delete <Group Name>
```

Show one or more groups:

```
show groups [name <Group Name>] members <enable|disable>
```

SSH Keys

The SLC 8000 advanced console manager can import and export SSH keys to facilitate shared key authentication for all incoming and outgoing SSH connections. By using a public/private key pair, a user can access multiple hosts with a single passphrase, or, if a passphrase is not used, a user can access multiple hosts without entering a password. In either case, the authentication is protected against security attacks because both the public key and the private key are required to authenticate. For both imported and exported SSH keys, the SLC unit supports both RSA and DSA keys, and can import and export keys in OpenSSH and SECSH formats. Imported and exported keys are saved with the SLC console manager configuration, and the administrator has the option of retaining the SSH keys during a reset to factory defaults.

The SLC unit can also update the SSH RSA1, RSA and DSA host keys that the SSH server uses with site-specific host keys or reset them to the default values.

Imported Keys

Imported SSH keys must be associated with an SLC 8000 advanced console manager local user. The key can be generated on host "MyHost" for user "MyUser," and when the key is imported into the SLC unit, it must be associated with either "MyUser" (if "MyUser" is an existing SLC console manager local user) or an alternate SLC local user. The public key file can be imported via SCP, SFTP, or FTP; once imported, you can view or delete the public key. Any SSH connection into the SLC unit from the designated host/user combination uses the SSH key for authentication.

Exported Keys

The SLC can generate SSH keys for SSH connections out of the SLC advanced console manager for any SLC user. The SLC 8000 advanced console manager retains both the private and public key on the SLC unit, and makes the public key available for export via SCP, SFTP, FTP, or copy and paste. The name of the key is used to generate the name of the public key file that is exported (for example, <keyname>.pub), and the exported keys are organized by user and key name. Once a key is generated and exported, you can delete the key or view the public portion. Any SSH connection out of the SLC console manager for the designated host/user combination uses the SSH key for authentication.

To configure the SLC unit to use SSH keys to authenticate users:

1. From the main menu, select **User Authentication - SSH Keys**. The following page displays.

Figure 12-11 User Authentication > SSH Keys

LANTRONIX[®] SLC 8048

Logout Host: slc4331 User: sysadmin

Select port for Configuration WebSSH (DP only) Connected Device (DP only)

Network Services **User Authentication** Devices Maintenance Quick Setup

Auth Methods Local/Remote Users NIS LDAP RADIUS Kerberos TACACS+ Groups SSH Keys Custom Menus

SSH Keys Help?

[SSH Server/Host Keys >](#)

Imported Keys (SSH In)

Host & User Associated with Key
(not required if host and SLC Local User login are declared in imported key file; ignored if file contains multiple keys)

Host:
 User:

Host & Login for Import

Import via:

Public Key:
 Host:
 Path:
 Login:
 Password:
 Retype Password:

Imported SSH Keys			<input type="button" value="View"/>	<input type="button" value="Delete"/>
User	Host	Type		

Exported Keys (SSH Out)

Export: New Key for User All Previously Created Keys

User:
 Key Name:
 Key Type: RSA DSA
 Number of Bits:
 Passphrase:
 Retype Passphrase:
 SECSH Format:
 Public Key Filename:

Host & Login for Export

Export via:

Host:
 Path:
 Login:
 Password:
 Retype Password:

Exported SSH Keys			<input type="button" value="View"/>	<input type="button" value="Download"/>	<input type="button" value="Delete"/>
User	Key Name	Type			

2. Enter the following:

Imported Keys (SSH In)

Host & User Associated with Key

These entries are required in the following cases:

- ◆ The imported key file does not contain the host that the user will be making an SSH connection from, or
- ◆ The SLC local user login for the connection is different from the user name the key was generated from or is not included in the imported key file, or
- ◆ The imported key file contains multiple keys; in this case, each key must include the user name and host at the end of the line in the standard `<key> <user name>@<host>` format.

If either of these conditions is true, or the imported file is in SECSH format, you must specify the user and host. The following is an example of a public key file that includes the user and host:

```
ssh-rsa AAAAB3NzaC1yc2EAAAABIwAAAEEApUHCX9EWsHt+jmUGXa1YC3us
ABYxIXUhSU1N+NU9HNaUADUff8LYz8/gUnUSH4Ksm8GRT7/8/Sn9jCVfGPh
UQ== asallaway@winserver
```

Host	The host name or IP address which will be associated with the SSH Key, typically the host that the key was generated on. Once imported, the key can be used to access the SLC from any host, not just the host associated with the key.
User	The User ID of the user being given secure access to the SLC unit.

Host & Login for Import

Import via	Select SCP , SFTP , FTP , HTTPS , or Copy/Paste as the method for importing the SSH keys. SCP is the default. If SCP, SFTP or FTP are selected, the Filename, Host, Path, Login, and Password fields are filled in. If HTTPS is selected, the Upload File link will become active to upload a file containing a public key to the SLC. If Copy/Paste is selected, the public key will be entered into the Filename/ Public Key field.
Filename Public Key	The name of the file that was uploaded via HTTPS, or to be copied via SCP, SFTP or FTP (may contain multiple keys); or the public key (optionally including "user@host" at the end) if Copy/Paste is used.
Host	IP address of the remote server from which to SCP, SFTP or FTP the public key file.
Path	Optional pathname to the public key file.
Login	User ID to use to SCP, SFTP or FTP the file.
Password / Retype Password	Password to use to SCP, SFTP or FTP the file.

Exported Keys (SSH Out)

Export	Enables you to export created public keys. Select one of the following: <ul style="list-style-type: none"> ◆ New Key for User: Enables you to create a new key for a user and export the public key in a file. ◆ All Previously Created Keys: Does not create any keys, but exports all previously created public keys in one file.
User	User ID of the person given secure access to the remote server.

Key Name	Name of the key. This will generate the public key filename (e.g., <keyname>.pub).
Key Type	Select either the RSA or the DSA encryption standard. RSA is the default.
Number of Bits	Select the number of bits in the key (1024 , 2048 , 3072 , or 4096). The default is 2048 .
Passphrase / Retype Passphrase	Optionally, enter a passphrase associated with the key. The passphrase may have up to 50 characters. The passphrase is an optional password that can be associated with an SSH key. It is unique to each user and to each key. See Key Sequences for notes on key sequence precedence and behavior.
SECSH Format	Indicate whether the keys will be exported in SECSH format (by default the key is exported in OpenSSH format).
Public Key Filename	Filename of the public host key.

Host and Login for Export

Export via	Select the method (SCP , SFTP , FTP , HTTPS , or Copy/Paste) of exporting the key to the remote server. Copy/Paste , the default, requires no other parameters for export.
Host	IP address of the remote server to which the SLC 8000 advanced console manager will SCP, SFTP or FTP the public key file.
Path	Optional path of the file on the host to SCP, SFTP or FTP the public key too.
Login	User ID to use to SCP, SFTP or FTP the public key file.
Password / Retype Password	Password to use to SCP, SFTP or FTP the public key file.

To view or delete a key:

1. Select the key from the appropriate table. The **View** and **Delete** buttons become active.
2. To view the key, click the **View** button. A pop-up page displays the key.

```
Imported key for sysadmin@DaveSLM:
ssh-rsa AAAAB3NzaC1yc2EAAAABIwAAAIEAxGxPGY9HsG9VqroDo98B89Cf
haqB6jG//0tTMKkb3zrpPu0HHAXaiVXHAvv71Ate31VTpoXdLAXN0uCvuJLf
aL/LvvGmoEWBuBSu5051QHfL70ijxZWOEVTJGFqUQTSq8Ls3/v31kUJEX51n
2AlQx0F40I5wNEC0+m3d5QE+FKc= sysadmin@DaveSLM
```

3. To delete the key, click the **Delete** button.

To view, reset, or import SSH RSA1, RSA, And DSA host keys:

1. On the **User Authentication - SSH Keys** page, click the **SSH Server/Host Keys** link at the top right. The following page displays the current host keys. In the example below, the current keys are the defaults.

Figure 12-12 Current Host Keys

LANTRONIX® SLC 8048

Logout Host: slc4331 User: sysadmin

Select port for Configuration WebSSH (DP only) Connected Device (DP only)

Network Services User Authentication Devices Maintenance Quick Setup

Auth Methods Local/Remote Users NIS LDAP RADIUS Kerberos TACACS+ Groups SSH Keys Custom Menus

SSH Server/Host Keys Help?

Current Host RSA1 Public Key (Default Key)

Fingerprint:
2048 be:2b:0b:f9:18:03:12:e8:2a:5c:1c:b1:14:9f:cd:d9 root@(none) (RSA1)

Current Host RSA Public Key (Default Key)

```
ssh-rsa AAAAB3NzaC1yc2EAAAADAQABAAQCYXZodmEzPP/Frovhxvfrv81BnIvX1SRaQx0FJ5TJe
4roEB0mHcM4zvJ+GM913y9ihFHH1vGtL7HG7wh0Pf6eC+CQt7ia02Rhx686s3123v3++KI6TrX/MrxLU
sqS67AGTYwH4LZIM6VtyfKVsWl/6SOWgTwmMhIUomMGj+/pHcnvSeAY0ZirpXZ1824UA9SfAnTBY6d/
T2wRH9SojQURPTOfNxxw6F8f33F9uoHTVzhIzxWj8/bhBo8Vr9g84TGyo3Y9TWzW9qpuovweqm8hpzn/F
ZNVy7YdkBI99s0Qw35+Fc+nHPMw46BT9huvFrMhDUycR7L00xKdvmjDM11ZP root@slc4331
```

Fingerprint:
2048 23:45:f4:96:50:bd:c5:0d:c8:25:96:8c:d2:e8:1d:40 root@slc4331 (RSA)

Current Host DSA Public Key (Default Key)

```
ssh-dss AAAAB3NzaC1kc3MAAACBAK3PpSoIhkg96hcQF0U5t4my9SSBpXHZ6qzLIJnLuPupQunBGxm
j/Coa7QkzgszJTFKTwSoHzQBkLmqdNnf1C5CrFFftQizzPxB0c0beerhkzawtLkxdGZsOpXaLirABE6
pEGGhXSnzXDzBp0/80vcJru6Qmgj4FH9mS2m3rqTAAAFQCu3jEm6dm9u2xMmOALN0/XJPSQ6wAAAI3
byUhqKsrkFn7IzBNjb2uWskS0f01zmPYQ4vywpKFR1SLQxuaMPQ/wSfbp48vL5xW4BiKiqSR9Lmt/zQ
wIaYSGIWMQSDnNB/dbcN9sm5dTbage9I6tmyG/pw9zhOtTqM0CcDaybHMhdyN9rG6YrrYj1fRv9/GnsQ
Mp4AwzOUuAAAAIBL0cAdGu64dD4AElgpmRA11jxd4pBsBm3hGUYzcVxpz13i/WEVJogen6CehWA3bNL0
k1sA4zgKkUW0mefXQ/GyCt+UF6F5x2H2AR7ktGwvNPoyUHqITddD6/Ly43bU62Jqy9kMjIdXWe7Afj/q
McjexvnyWk1gmEqhecPHnONYTQ== root@(none)
```

Fingerprint:
1024 37:99:6a:02:7c:10:1b:55:a2:93:e5:41:51:23:b2:e2 root@(none) (DSA)

Reset to Default Host Key: All Keys RSA1 RSA DSA

Note: changing a host key requires a reboot for the update to take effect.

Import Host Key:

Type:

Import via:

Public Key Filename:

Private Key Filename:

Host:

Path:

Login:

Password:

Retype Password:

[Back to SSH Keys](#)

2. View or enter the following:

Reset to Default Host Key	Select the All Keys checkbox to reset all default key(s), or select one or more checkboxes to reset defaults for RSA1 , RSA , or DSA keys. All checkboxes are unselected by default.
Import Host Key	To import a site-specific host key, select the checkbox. Unselected by default.
Type	From the drop-down list, select the type of host key to import.

Import via	From the drop-down list, select the method of importing the host key (SCP or SFTP). The default is SFTP .
Public Key Filename	Filename of the public host key.
Private Key Filename	Filename of the private host key.
Host	Host name or IPaddress of the host from which to import the key.
Path	Path of the directory where the host key will be stored.
Login	User ID to use to SCP or SFTP the file.
Password / Retype Password	Password to use to SCP or SFTP the file.

3. Click the **Apply** button.
4. Repeat steps 2-3 for each key you want to import.
5. To return to the SSH Keys page, click the **Back to SSH Keys** link.

SSH Commands

These commands for the command line interface correspond to the web page entries described above.

To import an SSH key:

```
set sshkey import <ftp|sftp|scp|coppypaste> <one or more parameters>
```

Parameters

```
[keyhost <SSH Key IP Address or Name>]
[keyuser <SSH Key User>]
[path <Path to Public Key File>]
[file <Public Key File>]
[host <IP Address or Name>]
[login <User Login>]
```

To export a key:

```
set sshkey export <ftp|sftp|scp|coppypaste> <one or more parameters>
```

Parameters

```
[format <openssh|secsh>]
[host <IP Address or Name>]
[login <User Login>]
[path <Path to Copy Key>]
[bits <1024|2048|3072|4096>]
keyname <SSH Key Name>
keyuser <SSH Key User>
type <rsa|dsa>
```

To export the public keys of all previously created SSH keys:

```
set sshkey all export <ftp|sftp|scp|coppypaste> [pubfile <Public Key File>] [host <IP Address or Name>] [login <User Login>] [path <Path to Copy Keys>]
```

To delete a key:

```
set sshkey delete <one or more parameters>
```

Parameters

```
keyhost <SSH Key Host>
keyname <SSH Key Name>
keyuser <SSH Key User>
```

Note: Specify the key user and key host to delete an imported key; specify the keyuser and keyname to delete an exported key.

To import an SLC host key or to reset a SLC host key to the default:

```
set sshkey server import type <rsa1|rsa|dsa> via <sftp|scp>
pubfile <Public Key File> privfile <Private Key File>
host <IP Address or Name> login <User Login> [path <Path to Key File>]
```

To reset defaults for all or selected host keys:

```
set sshkey server reset [type <all|rsa1|rsa|dsa>]
```

To display SSH keys that have been imported:

```
show sshkey import <one or more parameters>
```

Parameters

```
[keyhost <SSH Key IP Address or Name>]
[keyuser <SSH Key User>]
[viewkey <enable|disable>]
```

To display SSH keys that have been exported:

```
show sshkey export <one or more parameters>
```

Parameters

```
[keyname <SSH Key Name>]
[keyuser <SSH Key User>]
[viewkey <enable|disable>]
```

To display host keys (public key only):

```
show sshkey server [type <all|rsa1|rsa|dsa>]
```

1. Click the **Apply** button. New entries display in the Imported SSH Keys table and Exported SSH Keys table, as applicable.

Custom Menus

Users can have custom user menus as their command line interface, rather than the standard CLI command set. Each custom user menu can contain up to 50 commands ('logout' is always the last command). Instead of typing each command, the user enters the number associated with the command. Each command can also have a nickname associated with it, which can be displayed in the menu instead of the command. The commands `showmenu <Menu Name>` and `returnmenu` can be entered to display another menu from a menu, or to return to the prior menu. The command `returncli` can be used to break out of a menu and return to the regular CLI.

To add a custom menu:

1. Click the **User Authentication** tab and select the **Custom Menus** option. The Custom Menus page displays:

Figure 12-13 User Authentication > Custom Menus

The screenshot shows the LANTRONIX SLC 8048 web interface. At the top, there is a status bar with 'Logout', host information (slc4331, sysadmin), and a port selection menu. Below this is a navigation menu with 'User Authentication' selected. The main content area is titled 'Custom Menus' and contains a table of existing custom menus and a configuration form for a new menu.

Custom Menu	
Name	
glenn1	<input type="checkbox"/>
glenn2	<input type="checkbox"/>
glenn3	<input type="checkbox"/>
glenn4	<input type="checkbox"/>
glenntacac1	<input type="checkbox"/>
glenntacac2	<input type="checkbox"/>
glenntacac3	<input type="checkbox"/>
glennkrb1	<input type="checkbox"/>
glennkrb2	<input type="checkbox"/>
glennkrb3	<input type="checkbox"/>
bart1	<input type="checkbox"/>
bart2	<input type="checkbox"/>
bart3	<input type="checkbox"/>
glennnis1	<input type="checkbox"/>
glennnis2	<input type="checkbox"/>
glennnis3	<input type="checkbox"/>

Buttons: View Custom Menu, Delete Custom Menu, Copy Custom Menu (New Menu Name:)

Configuration Form:

Menu Name: Nicknames: Clear Custom Menu

Title: Redisplay Menu: Add Custom Menu

Command: →

Nickname: ←

QuickEdit Mode:

Commands/Nicknames List:

```
logout(logout)
```

Buttons: Delete Command & Nickname, Clear Command & Nickname, Unselect Command & Nickname

2. In the lower section of the page, enter the following:

Note: To clear fields in the lower part of the page, click the **Clear Custom Menu** button.

Menu Name	Enter a name for the custom menu.
Title	Enter an optional title which will be displayed about the menu at the CLI.

Nicknames	Select to enable nicknames to be displayed in the menu instead of the commands. If the custom menu will have nicknames, this should also be selected prior to entering the commands in the web page, as this will facilitate entry of the nicknames.
Redisplay Menu	Select to redisplay the custom menu each time before the CLI prompt is displayed.





3. You have the following options:

- To save the custom menu without any more commands than the default **logout** command, click the **Add Custom Menu** button.
- To add menu commands, select the **QuickEdit Mode** box. This will move the cursor from **Command** to **Nickname** and back to **Command** (if **Nicknames** is selected), or keep the cursor on **Command** (if **Nicknames** is not selected). Commands (and the optional nicknames) are added to the **Menu Commands/Nicknames** list when carriage return is entered at the **Command** field (if **Nicknames** is not selected) or the **Nickname** field (if **Nicknames** is selected). Most browsers have a "Select All" keystroke (such as Control-A) which allow you to select all of the text in a field; this can be used in conjunction with the Delete key to clear the contents of a field before entering a new command or nickname. The **Clear Command & Nickname** button can also be used to delete the contents of the Command and Nickname fields.

Commands can also be added to the list when **QuickEdit Mode** is not selected. Enter the command and the optional nickname and click the **right**  **arrow**. The command will be added before the logout command (if a command/nickname is not selected in the list) or will replace the currently selected command/nickname in the list. The **Unselect Command & Nickname** button can be used to unselect the currently selected command/nickname in the list.

4. To add more commands to the custom menu, repeat step 3.

5. You also have the following options:

- To edit a command/nickname in the custom menu, select the command in the **Commands/Nicknames List** box and select the **left**  **arrow** button. Change the command and/or the nickname, and with the same command still selected in the list, select the **right**  **arrow** button.
- To remove a command/nickname from the custom menu, select the command in the **Commands/Nicknames List** box and select the **Delete Command & Nickname** button.
- To move a command higher up in the menu (the commands are shown in the order they will be presented in the custom menu, with command #1 listed first), select the command in the **Commands/Nicknames List** box and click the **up**  **arrow**.
- To move a command further down in the menu, select the menu in the **Commands/Nicknames List** and click the **down**  **arrow**.

6. Click the **Add Custom Menu** button.

To view or update a custom menu:

1. In the **Custom Menus** table, select the custom menu and click the **View Custom Menu** button. The custom menu attributes appear in the lower part of the page.
2. Update the menu attributes following the instructions for adding a menu above.
3. Click the **Edit Custom Menu** button.

To delete a custom menu:

1. Select the custom menu in the **Custom Menus** table.
2. Click the **Delete Custom Menu** button.

To create a new custom menu from an existing custom menu:

1. Select the custom menu in the **Custom Menus** table.
2. Enter a name for the new menu in the **New Menu Name** field.
3. Click the **Copy Custom Menu** button.

Custom User Menu Commands

From the current menu, a user can display another menu, thus allowing menus to be nested. The special command `showmenu <Menu Name>` displays a specified menu. The special command `returnmenu` redisplay the parent menu if the current menu was displayed from a `showmenu` command.

The user with appropriate rights creates and manages custom user menus from the command line interface, but can assign a custom user menu to a user from either the command line or the web interface.

When creating a custom user menu, note the following limitations:

- ◆ Maximum of 20 custom user menus
- ◆ Maximum of 50 commands per custom user menu (`logout` is always the last command)
- ◆ Maximum of 15 characters for menu names
- ◆ Maximum of five nested menus can be called.
- ◆ No syntax checking (Enter each command correctly.)

To assign a custom user menu to a local or remote user:

```
set localusers add|edit <User Login> menu <Menu Name>
```

To create a new custom user menu or add a command to an existing custom user menu:

```
set menu add <Menu Name> [command <Command Number>]
```

To change a command or nickname within an existing custom user menu:

```
set menu edit <Menu Name> command <Command Number>  
set menu edit <Menu Name> nickname <Command Number>
```

To set the optional title for a menu:

```
set menu edit <Menu Name> title <Menu Title>
```

To enable or disable the display of command nicknames instead of commands:

```
set menu edit <Menu Name> shownicknames <enable|disable>
```

To enable or disable the redisplay of the menu before each prompt:

```
set menu edit <Menu Name> redisplaymenu <enable|disable>
```

To delete a custom user menu or one command within a custom user menu:

```
set menu delete <Menu Name> [command <Command Number>]
```

To view a list of all menu names or all commands for a specific menu:

```
show menu <all|Menu Name>
```

To test an existing menu:

```
set cli menu <Menu Name>
```

Example:

The system administrator creates two custom user menus, with menu1 having a nested menu (menu2):

```
[SLC]> set menu add menu1
Enter optional menu title (<return> for none): Menu1 Title
Specify nickname for each command? [no] y
Enter each command, up to 50 commands ('logout' is always the last
command).
Press <return> when the menu command set is complete.
Command #1: connect direct deviceport 1
Nickname #1: connect Port-1
Command #2: connect direct deviceport 2
Nickname #2: connect Port-2
Command #3: showmenu menu2
Warning: menu 'menu2' does not exist.
Nickname #3: menu2
Command #4:
Command #4: logout
Nickname #4: log off
Custom User Menu settings successfully updated.
[SLC]> set menu add menu2
Enter optional menu title (<return> for none): Menu2 Title
Specify nickname for each command? [no]
Enter each command, up to 50 commands ('logout' is always the last
command).
Press <return> when the menu command set is complete.
Command #1: connect direct deviceport 3
Command #2: connect direct deviceport 4
Command #3: show datetime
Command #4: returnmenu
Command #5:
Command #5: logout
Custom User Menu settings successfully updated.
[SLC]> show menu all
___Custom User
Menus_____
menu1_____ menu2
```

```

[SLC]> show menu menu1
__Custom User
Menus_____
Menu: menu1
Title: Menu1 Title
Show Nicknames: enabled
Redisplay Menu: disabled
Command  1: connect direct deviceport 1
Nickname 1: connect Port-1
Command  2: connect direct deviceport 2
Nickname 2: connect Port-2
Command  3: showmenu menu2
Nickname 3: menu2
Command  4: logout
Nickname 4: log off
[SLC]> show menu menu2

__Custom User
Menus_____
Menu: menu2
Title: Menu2 Title
Show Nicknames: disabled
Redisplay Menu: disabled
Command  1: connect direct deviceport 3
Nickname 1: <none>
Command  2: connect direct deviceport 4
Nickname 2: <none>
Command  3: show datetime
Nickname 3: <none>
Command  4: returnmenu
Nickname 4: <none>
Command  5: logout
Nickname 5: <none>

```

The system administrator configures local user 'john' to use custom menu 'menu1':

```

[SLC]> set localusers edit john custommenu menu1
Local users settings successfully updated.
[SLC]> show localusers user john
__Current Local Users
Settings_____
Login: john
  Password: <set>  UID: 101
  Listen Ports: 1-32
  Data Ports: 1-32
  Clear Ports: 1-32
  Escape Sequence: \x1bA  Break Sequence: \x1bB
  Custom Menu: menu1
  Allow Dialback: disabled
  Dialback Number: <none>

```

User 'john' logs into the command line interface, initially sees menu1, executes the command to jump to nested menu menu2, and then returns to menu1:

```
Welcome to the SLC-Console Server
Model Number: SLC32
For a list of commands, type 'help'.
[Enter 1-4]> help
```

```
Menu1 Title
```

```
-----
1) connect Port-1                3) menu2
2) connect Port-2                4) log off
```

```
[Enter 1-4]> 3
Executing: showmenu menu2
[Enter 1-5]> help
Menu2 Title
```

```
-----
1) connect direct deviceport 3
2) connect direct deviceport 4
3) show datetime
4) returnmenu
5) logout
```

```
[Enter 1-5]> 3
Executing: show datetime
Date/Time: Tue Sep  7 19:13:35 2004
Timezone: UTC
[Enter 1-5]> 4
Executing: returnmenu
[Enter 1-4]> help
```

```
Menu1 Title
```

```
-----
1) connect Port-1                3) menu2
2) connect Port-2                4) log off
```

```
[Enter 1-4]> 4
Executing: logout
Logging out...
```

13: Maintenance

The system administrator performs maintenance activities and operates the SLC advanced console manager using the options for the Maintenance tab and additional commands on the command line interface.

Firmware & Configurations

The Firmware & Configuration page allows the system administrator to:

- ◆ Configure the FTP, SFTP, or TFTP server that will be used to provide firmware updates and save/restore configurations. (TFTP is only used for firmware updates and configurations restored via DHCP/TFTP [Zero Touch Provisioning Configuration Restore](#).)
- ◆ Set up the location or method that will be used to save or restore configurations (Local Disk, FTP, SFTP, NFS, CIFS, USB, HTTPS or SD card). Update the version of the firmware running on the SLC unit.
- ◆ Save a snapshot of all settings on the SLC device (save a configuration).
- ◆ Restore the configuration, either to a previously saved configuration, or to the factory defaults.
- ◆ Configurations can also be pushed to the SLC via the [HTTPS Push Configuration Restore](#) feature.

Zero Touch Provisioning Configuration Restore

The Zero Touch Provisioning feature allows a factory defaulted SLC to acquire a default configuration from a DHCP server and TFTP server when it is booted. At boot-time, before the normal startup process, a unit will attempt to acquire network parameters and a configuration file, first over Eth1, and then over Eth2:

- ◆ The unit will broadcast on the Eth1 network port for a DHCP server on the local subnet, requesting DHCP options "TFTP Server" (DHCP option #66) and "Boot Filename" (DHCP option #67).
- ◆ If it receives both options from the DHCP server, and the Boot Filename is a valid SLC configuration filename ending in "-slccfg.tgz", it will attempt to download the Boot Filename from the TFTP Server.
- ◆ If it is able to download the Boot Filename from the TFTP Server, it will restore the configuration onto the SLC, and begin the normal startup process.
- ◆ If any of these steps fail for the Eth1 network port, it will repeat the process of trying to acquire a configuration over the Eth2 network port.
- ◆ After attempting to acquire a configuration over the Eth2 network port, the unit will begin the normal startup process.

Any results of attempting to acquire and restore a configuration file will be output to the console port and the system log. Configurations for firmware versions that are newer than the firmware version running on the unit will not be restored. Spaces are not supported in either the directory or filename portion of the Boot Filename path.

HTTPS Push Configuration Restore

The HTTPS Push Configuration feature allows a saved configuration to be pushed to a SLC via a command line tool such as "curl" that includes the configuration to upload:

```
% curl --insecure --request POST --form "file=@/home/users/admin/
current-slccfg.tgz" https://myslc.company.com/
cfgupdate.htm?login=sysadmin&password=PASS&config=all&comment=FirmwareUp
date
```

The arguments that are passed with the URL are:

- ◆ **login** - Login token to use for authentication. This must be a local user with firmware/config and reboot/shutdown rights.
- ◆ **password** - Clear text password for the login token.
- ◆ **config** - Indicates the portion of the configuration to restore, either all, or any combination of the following separated by commas: network, datetime, services, localusers, devports, usb, rpms, remouteauth, connections, events, ipfilter, groups, hostlist, nfscifs, maintenance, sites, scripts, slcnetwork, consoleport, menus, sshkeys, or sslcerts.
- ◆ **comment** - optional comment to include in the system log and audit log. If spaces are included in the comment they should be URL encoded as shown in this bash script:

```
#!/bin/bash
```

```
url="https://myslc.company.com/
cfgupdate.htm?login=sysadmin&password=PASS&config=all&comment=Update
myslc.company.com with default configuration"
```

```
curl --insecure --request POST --form "file=@/home/users/admin/current-
slccfg.tgz" "$( echo $url | sed 's/ /%20/g' )"
```

If an HTTPS Push Config command is accepted and initiated by the SLC, the SLC will respond with "Configuration restore initiated; SLC will reboot.", the restore will be performed, a message will be logged to the audit log and the system log, and the SLC will reboot. Any errors in the process will result in an error message being displayed.

To configure settings:

1. Click the **Maintenance** tab. The *Maintenance > Firmware & Configurations* page displays.

Figure 13-1 Maintenance > Firmware & Configurations

LANTRONIX® SLC 8048

Logout Host: slc48SFP251-7400R11 User: sysadmin

Select port for Configuration WebSSH (DP only) Connected Device (DP only)

Network Services User Authentication Devices **Maintenance** Quick Setup

Firmware/Config System Log Audit Log Email Log Diagnostics Status/Reports Events LCD/Keypad Banners

Firmware & Configurations Help?

General

Reboot: Shutdown:

Internal Temperature

Current: 58 °C / 136 °F

Low: °C / 32 °F

High: °C / 149 °F

Calibrate Offset: °C / 0 °F

Note: Temperatures can be entered in either Celsius or Fahrenheit, to indicate a temperature is Fahrenheit, append the degrees with an 'F', eg "75F".

Site Information

Data Center Rack Row:

Data Center Rack Cluster:

Data Center Rack:

SLC Firmware

Current Version: 7.4.0.0R11

Clear FW Update Log: [Firmware Update Log >](#)

Update Firmware:

Firmware Filename:

Key:

Load Firmware via:

Note: Firmware files stored on NFS, SD Card and USB can be managed by clicking the Manage link below.

Load Firmware Via Options

HTTPS: [Upload File >](#)

NFS Mounted Dir:

USB Port: Port U1 Port U2

FTP/SFTP/TFTP Server:

Path:

Login:

Password:

Retype Password:

Boot Banks

Bank 1: 7.4.0.0R10

Bank 2: 7.4.0.0R11 (current)

Next Boot Bank:

Switch to Bank 1:

Watchdog Timer: seconds

Copy configuration from Bank 2 to Bank 1 during firmware update:

Boot Count:

Boot Limit:

Boot Delay: seconds

Configuration Management

No Save/Restore

Save Configuration Tarball Format (HTTPS only)

Restore Factory Defaults

Restore Saved Configuration

Save with Config or Preserve with Restore:

SSH Keys SSL Certificate

Scripts

Preserve Configuration after Restore:

Networking Local Users

Date/Time Device Ports

Services USB

Remote Auth

Configuration Name to Save To or Restore From:

Location for Save, Restore or [Manage >](#)

Local Disk Saved Configurations:

FTP Server Use: FTP SFTP

NFS Mounted Directory:

CIFS Share Saved Configurations:

USB Use: Port U1 Port U2

Saved Configurations:

HTTPS [Upload File for Restore >](#) File will be uploaded to Local Disk.

SD Card Saved Configurations:

2. Enter the following:

Reboot	Select this option to reboot the SLC 8000 advanced console manager immediately. The default is No . <i>Note:</i> The front panel LCD displays the “Rebooting the SLC” message, and the normal boot sequence occurs.
Shutdown	Select this option to shut down the SLC unit. The default is No .

Internal Temperature

Current	Displays current temperature.
Low	Sets the acceptable minimum for the internal temperature of the SLC 8000 advanced console manager. If the temperature of the SLC device changes to be outside of this range, the SLC console manager will issue an SNMP trap.
High	Sets the acceptable maximum for the internal temperature of the SLC unit. If the temperature of the SLC 8000 advanced console manager changes to be outside of this range, the SLC unit will issue an SNMP trap.
Calibrate Offset	An offset for calibrating the internal temperature of the SLC console manager. The offset will be applied one hour after setting the calibration value. Zeroing the offset will take effect immediately and will cancel any current and/or pending calibration.

Site Information

Data Center Rack Row	Set these fields to define the rack row the SLC unit is located within a large data center. The default for these fields is 1.
Data Center Rack Cluster	Set these fields to define the rack cluster the SLC 8000 advanced console manager is located within a large data center. The default for these fields is 1.
Data Center Rack	Set these fields to define the rack the SLC unit is located within a large data center. The default for these fields is 1.

SLC Firmware

Note: The non-active boot bank is updated during the firmware update, without requiring a reboot. The configuration on the current boot bank may optionally be copied to the non-active boot bank during the firmware update.

Current Version	Displays the current firmware version.
Clear FW Update Log (checkbox)	Clears the contents of the Firmware Update log file.
Firmware Update Log (link)	To view a log of all prior firmware updates, click the Firmware Update Log link.
Update Firmware	<ul style="list-style-type: none"> ◆ To update the SLC firmware, select the checkbox. If you select this option, the SLC unit reboots after you apply the update. The first time boot for each bank may take up to 5 minutes. Subsequent boot times will be approximately 2 minutes. ◆ To view a log of all prior firmware updates, click the Firmware Update Log link.
Firmware Filename	The name of the firmware update file downloaded from the Lantronix web site.
Key	A key for validating the firmware file. The key is provided with the firmware file (32 hex characters).

Load Firmware Via	<p>From the drop-down list, select the method of loading the firmware. Options are FTP, TFTP, HTTPS, NFS, USB, and SD Card. FTP is the default.</p> <ul style="list-style-type: none"> ◆ If you select HTTPS, the Upload File link becomes active. Select the link to open a popup window that allows you to browse to a firmware update file to upload. ◆ If you select NFS, the mount directory must be specified. ◆ The SD Card option must be selected if an SD card is to be used. <p>Note: Connections available depend on the model of the SLC unit.</p>
--------------------------	--

Boot Banks

Bank 1	<p>Displays the version of SLC firmware in bank 1.</p> <p>Note: The word "current" displays next to the bank from which the SLC booted.</p>
Bank 2	Displays the version of SLC firmware in bank 2.
Next Boot Bank	Displays the current setting for bank to boot from at next reboot.
Switch to Bank 2	If desired, select the alternate bank to boot from at next reboot.
Copy configuration from Bank 1 to Bank 2 during firmware update	If checked, will copy the configuration from the current bank to the bank being updated. The two numbers are automatically generated so that the first number is the current bank.
Boot Count, Boot Delay, Boot Limit	<p>Parameters that control how the SLC boots and when it switches to the alternate boot bank.</p> <ul style="list-style-type: none"> ◆ Boot Delay - how many seconds the bootloader pauses before booting the SLC. Default is 3 seconds, range is 3 - 1800 seconds. ◆ Boot Limit - how many times the SLC will fail to boot before switching to the alternate boot bank. After the SLC fails to boot 2 times Boot limit (so it has attempted to boot Boot Limit times on each bank), the SLC will go into advanced recovery mode, which may require support from Technical Support to resolve so that the SLC can be booted again. Default is 3 boots, range is 3 - 20. ◆ Boot Count - how many times the SLC has failed to boot. If this value reaches Boot Limit, the SLC will switch to the alternate boot bank. The SLC will switch to the alternate boot bank only once. For example, if it fails to boot Boot Limit times on bank 1, it will automatically switch to bank 2; if it fails to boot Boot Limit times on bank 2, it will enter advanced recovery mode. If Boot Count has reached Boot Limit, setting this value to 0 will enable the SLC to boot again. Default is 0, range is 0 - 1.
Watchdog Timer	Timer that will reboot the SLC if the boot fails to properly complete. If the timer expires without a successful boot of the SLC, the timer will automatically reboot the SLC. The default is 300 seconds. A value of zero will disable the watchdog timer.

Load Firmware Via Options

Note: Prior to firmware update, the current configuration is saved to the Local Disk location with the name "before_MMDDYY_HHMM".

HTTPS	Click Upload File to update the SLC firmware.
NFS Mounted Dir	Select the NFS mounted directory from the drop-down menu.
USB Port	Click to select USB port.
FTP/SFTP/TFTP Server	The IP address or host name of the server used for obtaining updates and saving or restoring configurations. May have up to 64 alphanumeric characters; may include hyphens and underscores.

Path	The default path on the server for obtaining firmware update files and getting and putting configuration save files.
Login	The userid for accessing the FTP server. May be blank.
Password / Retype Password	The FTP user password.

Configuration Management

Configuration Management	<p>From the option list, select one of the following:</p> <ul style="list-style-type: none"> ◆ No Save/Restore: Does not save or restore a configuration. ◆ Save Configuration: Saves all settings to file, which can be backed up to a location that is not on the SLC 8000 advanced console manager. If Tarball Format is checked, the configuration will be saved in the old (insecure) compressed tar file format, instead of the password protected zip file format. ◆ Restore Factory Defaults: Restores factory defaults. If you select this option, the SLC unit reboots after you apply the update. ◆ Restore Saved Configuration: Returns the SLC settings to a previously saved configuration. If you select this option, the SLC console manager reboots after you apply the update.
Save with Config or Preserve with Restore	<ul style="list-style-type: none"> ◆ Select the SSH Keys checkbox to save any imported or exported SSH keys. ◆ Select the SSL Certificate checkbox to save an imported certificate. ◆ Select the Scripts checkbox to save any interface or batch scripts. Disabled by default.
Preserve Configuration after Restore	<p>Allows the user to keep a subset of the current configuration after restoring a configuration or resetting to factory defaults.</p> <p>Select the checkbox for each part of the current configuration you want to keep, for example, Networking, Services, or Device Ports.</p>
Configuration Name to Save to or Restore From	If you selected to save or restore a configuration, enter a name for the configuration file (up to 12 characters).
Location for Save, Restore, or Manage	<p>If you selected to save or restore a configuration, select one of the following options:</p> <ul style="list-style-type: none"> ◆ Manage: This link allows you to view and delete all configurations saved to the selected location. This feature is available for the Local Disk, NFS Mounts, CIFS Share, USB, and SD Card locations. See Manage Files on page 277. ◆ Local Disk – Saved Configurations: If restoring, select a saved configuration from the drop-down list. ◆ FTP Server: The FTP server specified in the FTP/SFTP/TFTP section. If you select this option, select FTP or SFTP to transfer the configuration file. ◆ NFS Mounted Directory: Local directory of the NFS server for mounting files. ◆ CIFS Share – Saved Configurations: If restoring, select a saved configuration from the drop-down list. ◆ USB: If a USB device is loaded into one of the USB ports of the SLC 8000 advanced console manager, and properly mounted, the configuration can be saved to or restored from this location. If you select this option, select the port in which the USB thumb drive is mounted; then click a saved configuration from the drop-down list. ◆ HTTPS: For saving, the browser will prompt the user to save the configuration. For restoring, the configuration will be uploaded to the Local Disk location. ◆ SD Card: If an SD card is loaded into a card slots of the SLC and properly mounted, the configuration can be saved to or restored from this location.

3. To view a log of all prior firmware updates, click the **Firmware Update Log** (blue link near the

center of the web page).

4. Click **Apply**.

Note: If you selected an option that forces a reboot (restore configuration, update firmware, or reset factory defaults), the SLC unit automatically reboots at the end of the process.

Figure 13-2 Network > Firmware/Config > Manage

The screenshot shows the LANTRONIX SLC 8048 web interface. At the top, there is a navigation bar with tabs for Network, Services, User Authentication, Devices, Maintenance, and Quick Setup. The Maintenance tab is active, and the sub-menu 'Firmware/Config' is selected. The main heading is 'Firmware & Configurations - Manage Files'. Below this is a table titled 'Configurations - Local Disk' with the following data:

Name	Date/Time Saved	SSH Keys	SSL Certificate	Scripts	
slc4873R7_250120all-slcfcfg.tgz	05/18/16 23:29:30	Y	Y	Y	<input type="checkbox"/>
before_051216_2222-slcfcfg.tgz	05/12/16 22:22:54	Y	Y	Y	<input type="checkbox"/>
syscon-slcfcfg.tgz	05/20/16 16:07:18	Y	Y	Y	<input type="checkbox"/>
slc73dhcp-slcfcfg.tgz	05/20/16 19:52:19	Y	Y	Y	<input type="checkbox"/>
before_051216_2245-slcfcfg.tgz	05/12/16 22:45:05	Y	Y	Y	<input type="checkbox"/>

Below the table are buttons for 'Delete File', 'Download File', and 'Rename File', and a text input field for 'New File Name:'.

Manage Files

The **Manage Files** web page allows you to view the firmware and configuration files saved to the selected location and rename, download or delete any of the files. This feature is available for the Local Disk, NFS Mounts, CIFS Share, USB, and SD card locations.

To manage files:

1. On the [Maintenance > Firmware & Configurations](#) page, click the **Manage** link. The [Network > Firmware/Config > Manage \(on page 277\)](#) page appears and displays the name and the time and date the file was saved.
2. To rename a file, select a file, enter the **New File Name**, and click the **Rename File** button.
3. To download a file, select a file and click the **Download File** button.
4. To delete files, select one, multiple files, or all files, and click the **Delete File** button. A verification message showing files deleted will appear. Click **Back to Manage Files** to return to the [Network > Firmware/Config > Manage](#) page.

Note: When deleting multiple files with a single command, the list of files that have been deleted will only be shown if 10 or fewer files are deleted.

Administrative Commands

These commands for the command line interface correspond to the web page entries described above.

To immediately terminate all connections and reboot the SLC 8000 advanced console manager:

```
admin reboot
```

Note: The front panel LCD displays the "Rebooting the SLC" message, and the normal boot sequence occurs.

To prepare the SLC 8000 advanced console manager to be powered off:

```
admin shutdown
```

Note: When you use this command to shut down the SLC unit, the LCD front panel displays "Shutting down the SLC," followed by a pause, and then "Shutdown complete." When "Shutdown complete" displays, it is safe to power off the SLC 8000 advanced console manager.

To list current hardware and firmware information:

```
admin version
```

To update SLC firmware to a new revision:

Note: For updates via FTP, TFTP or SFTP, the firmware file should be accessible via the settings displayed by `admin ftp show`. The SLC 8000 advanced console manager automatically reboots after successful update.

```
admin firmware update <ftp|tftp|sftp|nfs|usb|sdcard> file <Firmware File> key <Checksum Key> [nfmdir <NFS Mounted Directory>][usbport <U1|U2>]
```

To list the current firmware revision:

```
admin firmware show [viewlog <enable|disable>]
```

Lists the current firmware revision and optionally displays the log containing details about firmware updates.

To clear the firmware update log:

```
admin firmware clearlog
```

To configure parameters that control how the SLC boots and when it switches to the alternate boot bank:

```
admin firmware bootcount <0|1>
admin firmware bootlimit <3-20>
admin firmware bootdelay <3-1800>
```

To configure how long the SLC waits for boot completion before forcing a reboot:

```
admin firmware watchdog <disable|180-1800 seconds>
```

Sets the boot bank to be used at the next SLC reboot (for dual-boot SLCs):

```
admin firmware bootbank <1|2>
```

Note: It is recommended that you wait at least two weeks before copying a newly upgraded bank to the original boot bank. This allows you to roll back the upgrade in the unlikely event that there is an issue.

To set the FTP/TFTP/SFTP server used for firmware updates and configuration save/restore:

```
admin ftp server <IP Address or Hostname> [login <User Login>] [path <Directory>]
```

To view FTP settings:

```
admin ftp show
```

To set the FTP server password and prevent it from being echoed:

```
admin ftp password
```

To restore the SLC unit to factory default settings:

```
admin config factorydefaults [savesshkeys <enable|disable>] [savesslcert <enable|disable>] [savescripts<enable|disable>] [preserveconfig <Config Params to Preserve>]
```

<Config Params to Preserve> is a comma-separated list of current configuration parameters to retain after the config restore or factorydefaults:

```
nt - Networking          lu - Local Users
sv - Services           dp - Device Ports
dt - Date/Time          ub - USB Port/SD Card
ra - Remote Authentication
```

To restore a saved configuration to the SLC 8000 advanced console manager:

```
admin config restore <Config Name> location
<local|ftp|sftp|nfs|cifs|usb|sdcard> [nfsdir <NFS Mounted Dir>]
[usbport <U1|U2>] [savescripts<enable|disable>] [savesshkeys
<enable|disable>] [savesslcert <enable|disable>]
[preserveconfig <Config Params to Prserve>]
```

<Config Params to Preserve> is a comma-separated list of current configuration parameters to retain after the config restore or factory defaults:

```
nt - Networking          lu - Local Users
sv - Services           dp - Device Ports
dt - Date/Time          ub - USB Port/SD Card
ra - Remote Authentication
```

To save the current SLC configuration to a selected location:

```
admin config save <Config Name> location
<local|ftp|sftp|nfs|cifs|usb|sdcard> [nfsdir <NFS Mounted Dir>] [usbport
<U1|U2>]
```

To rename a saved configuration:

```
admin config rename <Config Name> location <local|nfs|cifs|usb|sdcard>
[nfsdir <NFS Mounted Dir>] [usbport <U1|U2>]
```

To delete a saved configuration:

```
admin config delete <Config Name> location <local|nfs|cifs|usb|sdcard>
[usbport <U1|U2>]
```

To list the configurations saved to a location:

```
admin config show <local|ftp|sftp|nfs|cifs|usb|sdcard> [nfsdir <NFS
Mounted Dir>] [usbport <U1|U2>]
```

Displays a checksum for the current configuration to determine if the configuration has changed:

```
admin config checksum
```

Copies the current configuration (or optionally, a configuration from another location) to the other bank (for dual-boot SLCs):

```
admin config copy <current|Config Name>
      [location <local|nfs|cifs|usb|sdcard>
      [nfsdir <NFS Mounted Directory>] [usbport <U1|U2>] ]
```

To set the acceptable range for the internal temperature sensor (an SNMP trap is sent if the temperature is outside of this range):

```
set temperature <one or more parameters>
```

Parameters

```
low <Low Temperature in C. or F.>
high <High Temperature in C. or F.>
calibrate <Temperature Calibration in C. or F.|cancel>
```

Note: The calibration offset will be applied one hour after setting the value.

To display the acceptable range and current reading from the internal temperature sensor:

```
show temperature
```

System Logs

The [Maintenance > System Logs](#) page allows you to view various system logs. (See [Chapter 7: Services on page 89](#) for more information about system logs.) You can also clear logs on this page.

To view system logs:

1. Click the **Maintenance** tab and select the **System Logs** option. The following page displays:

Figure 13-3 Maintenance > System Logs

The screenshot shows the LANTRONIX SLC 8048 web interface. At the top, there is a status bar with 'Host: slc4331' and 'User: sysadmin'. Below this is a navigation menu with tabs for 'Network', 'Services', 'User Authentication', 'Devices', 'Maintenance', and 'Quick Setup'. The 'Maintenance' tab is active, and the 'System Log' sub-tab is selected. The 'System Logs' section has a 'Help?' link. Under 'Log', the 'All' radio button is selected. Under 'Level', the 'Error' radio button is selected. The 'Starting at' section has 'Beginning of Log' selected. The 'Ending at' section has 'End of Log' selected. There are 'View Log' and 'Clear Log' buttons at the bottom.

2. Enter the following to define the parameters of the log you would like to view:

Log	Select the type(s) of log you want to view: <ul style="list-style-type: none"> ◆ All ◆ Network ◆ Services ◆ Authentication ◆ Device Ports ◆ Diagnostics ◆ General ◆ Software
Level	Select the alert level you want to view for the selected log: <ul style="list-style-type: none"> ◆ Error ◆ Warning ◆ Info ◆ Debug
Starting at	Select the starting point of the range you want to view: <ul style="list-style-type: none"> ◆ Beginning of Log: to view the log from the earliest available beginning time and date. ◆ Date: to view the log starting from a specific starting date and time.

Ending at	Select the endpoint of the range you want to view: <ul style="list-style-type: none"> ◆ End of Log: to view the log from the latest available ending time and date. ◆ Date: to view the log up to the last available log ending date and time.
------------------	--

- Click the **View Log** button. Your specified system log displays. For example, if you select the type **All** and the level **Error**, the SLC unit displays a log similar to this:

Figure 13-4 System Logs

The screenshot shows the Lantronix SLC 8048 web interface. At the top, there's a header with the product name and a status bar showing 'Logout', 'Host: slc4331', and 'User: sysadmin'. Below this is a navigation menu with tabs for 'Network', 'Services', 'User Authentication', 'Devices', 'Maintenance', and 'Quick Setup'. The 'Maintenance' tab is active, and the 'System Log' sub-tab is selected. The main content area is titled 'System Logs' and includes a 'Log: All - Error Level' dropdown, an 'Email Output' button, and a 'Comment:' field. A 'Stop Refresh' button is also present. The log content is displayed in a scrollable text area, showing various system messages and errors.

```

May 20 21:58:29 2016 slc4331 SLC-SLB: last message repeated 2 times
May 20 21:58:27 2016 slc4331 SLC-SLB/xwsd: sw/err-recvfrom error: Interrupted system call
May 20 19:53:39 2016 slc4331 SLC-SLB/lcd: sw/err-Power Supply A failed
May 20 19:53:06 2016 slc4331 SLC-SLB/kernel: Cannot find map file.
May 20 19:53:03 2016 (none) SLC-SLB/kernel: et0 Link Up: 100FD
May 20 19:53:03 2016 (none) SLC-SLB/kernel: IPv6: ADDRCONF(NETDEV_CHANGE): eth0: link becomes ready
May 20 19:52:56 2016 (none) SLC-SLB/kernel: xhci_hcd 0001:01:00.0: xHCI Host Controller
May 20 19:52:56 2016 (none) SLC-SLB/kernel: xhci_hcd 0001:01:00.0: xHCI Host Controller
May 20 19:52:56 2016 (none) SLC-SLB/kernel: xhci_hcd 0001:01:00.0: new USB bus registered, assigned bus number 4
May 20 19:52:56 2016 (none) SLC-SLB/kernel: xhci_hcd 0001:01:00.0: new USB bus registered, assigned bus number 3
May 20 19:52:56 2016 (none) SLC-SLB/kernel: xhci_hcd 0001:01:00.0: irq 169, io mem 0x40000000
May 20 19:52:56 2016 (none) SLC-SLB/kernel: xhci-hcd xhci-hcd: xHCI Host Controller
May 20 19:52:56 2016 (none) SLC-SLB/kernel: xhci-hcd xhci-hcd: xHCI Host Controller
May 20 19:52:56 2016 (none) SLC-SLB/kernel: xhci-hcd xhci-hcd: new USB bus registered, assigned bus number 6
May 20 19:52:56 2016 (none) SLC-SLB/kernel: xhci-hcd xhci-hcd: new USB bus registered, assigned bus number 5
May 20 19:52:56 2016 (none) SLC-SLB/kernel: xhci-hcd xhci-hcd: irq 112, io mem 0x18023000

```

From a queried system log (e.g., [Figure 13-4](#)), you may email this information to a specific individual or to Lantronix Technical Support. See [Emailing Logs and Reports \(on page 293\)](#).

To clear system logs:

- From the [Maintenance > System Logs](#) page, select **Maintenance - System Logs**.
- Click the **Clear Log** button to clear all log information.

System Log Command

The following command for the command line interface corresponds to the web page entries described above.

To view the system logs containing information and error messages:

```
show syslog [<parameters>]
```

Parameters

```
[email <Email Address>]
```

```
level <error|warning|info|debug>
log <all|netlog|servlog|authlog|devlog|diaglog|genlog>
display <head|tail> [numlines <Number of Lines>]
startingtime <MMDDYYhhmm[ss]
endtime <MMDDYYhhmm[ss]
```

Note: The level and time parameters cannot be used simultaneously.

To clear one or all of the system logs:

```
show syslog clear
<all|netlog|servlog|authlog|devlog|diaglog|genlog>
```

Audit Log

The [Maintenance > Audit Log](#) page displays a log of all actions that have changed the configuration of the SLC 8000 advanced console manager. The audit log is disabled by default. Use the [Services > SSH/Telnet/Logging](#) page ([Chapter 7: Services](#)) to enable the audit log and to configure its maximum size.

Each entry in the log file contains a date/time stamp, user login, and the action performed by the user. The user may clear the log file and sort the log by date/time, user, and command. The audit log is saved through SLC reboots.

1. Click the **Maintenance** tab and select the **Audit Log** option. The following page displays:

Figure 13-5 Maintenance > Audit Log

LANTRONIX® SLC 8048

Logout Host: slc4331 User: sysadmin

Select port for Configuration WebSSH (DP only) Connected Device (DP only)

Network Services User Authentication Devices Maintenance Quick Setup

Firmware/Config System Log Audit Log Email Log Diagnostics Status/Reports Events LCD/Keypad Banners

Audit Log Help?

Sorted by: **Date/Time**

Sort by: Comment:

to:

May 24 06:45:02 2016	sysadmin	Host List 'abc' updated
May 24 06:24:14 2016	sysadmin	Web Authentication Success for user sysadmin
May 24 05:33:07 2016	sysadmin	Web Authentication Success for user sysadmin
May 24 02:08:52 2016	sysadmin	Web Authentication Success for user sysadmin
May 24 00:29:54 2016		User sysadmin logged off of SSH session
May 24 00:24:18 2016	sysadmin	Web Authentication Success for user sysadmin
May 24 00:24:06 2016	sysadmin	Local user settings updated
May 24 00:24:05 2016	sysadmin	Auth order: Local Users=1 NIS=0 LDAP=0 RADIUS=0 Kerberos=0 TACACS=0
May 24 00:23:52 2016		SSH Authentication Success for user sysadmin
May 24 00:23:30 2016	sysadmin	Web Authentication Failure for user sysadmin
May 24 00:16:27 2016	sysadmin	Web Authentication Success for user sysadmin
May 23 23:00:32 2016	sysadmin	Web Authentication Success for user sysadmin
May 23 21:02:35 2016	sysadmin	Web Authentication Failure for user sysadmin
May 23 20:40:42 2016	sysadmin	Web Authentication Success for user sysadmin
May 21 06:21:45 2016	sysadmin	Web Authentication Success for user sysadmin
May 21 04:14:48 2016	sysadmin	Web Authentication Success for user sysadmin
May 21 00:44:34 2016	sysadmin	Web Authentication Success for user sysadmin
May 20 21:09:38 2016	sysadmin	Web Authentication Success for user sysadmin
May 20 20:32:34 2016	sysadmin	Web Authentication Success for user sysadmin
May 20 19:54:39 2016	sysadmin	Local user 'sysadmin' attributes updated

- To select a sort option, click the appropriate button:
 - To sort by date and time, click the sort by **Date/Time** button (this is the default.)
 - To sort by user, click the sort by **User** button.
 - To sort by command/action, click the sort by **Command** button.
- To email this log, follow the instructions in [Emailing Logs and Reports \(on page 293\)](#).
- To clear the log, click the **Clear Log** button.
- To freeze or stop automatic refreshing of the log, click the **Stop Refresh** button.

Email Log

The [Maintenance > Email Log](#) page displays a log of all attempted emails. The log file can be cleared from here. The email log is saved through SLC reboots.

- Click the Maintenance tab and select the Email Log option. The following page displays:

Figure 13-6 Maintenance > Email Log

LANTRONIX[®] SLC 8048

Logout Host: slc4331 User: sysadmin

Select port for Configuration WebSSH (DP only) Connected Device (DP only)

Network Services User Authentication Devices Maintenance Quick Setup

Firmware/Config System Log Audit Log Email Log Diagnostics Status/Reports Events LCD/Keypad Banners

Email Log Help ?

Clear Log Comment:

Stop Refresh to:

```

Send Failures: 1
Emails Sent: 16
Bytes Sent: 2954

05/18/16 19:21 gefountain@lantronix.com Message Sent (SLC Internal Temperature out of Range)
05/18/16 19:20 gefountain@lantronix.com Message Sent (SLC Internal Temperature out of Range)
05/18/16 19:19 gefountain@lantronix.com Message Sent (SLC Internal Temperature out of Range)
05/18/16 19:18 gefountain@lantronix.com Message Sent (SLC Internal Temperature out of Range)
05/18/16 19:17 gefountain@lantronix.com Message Sent (SLC Internal Temperature out of Range)
05/18/16 19:16 gefountain@lantronix.com Message Sent (SLC Internal Temperature out of Range)
05/18/16 19:15 gefountain@lantronix.com Message Sent (SLC Internal Temperature out of Range)
05/18/16 19:14 gefountain@lantronix.com Message Sent (SLC Internal Temperature out of Range)
05/18/16 19:13 gefountain@lantronix.com Message Sent (SLC Internal Temperature out of Range)
05/18/16 19:12 gefountain@lantronix.com Message Sent (SLC Internal Temperature out of Range)
05/18/16 19:11 gefountain@lantronix.com Message Sent (SLC Internal Temperature out of Range)
05/18/16 19:10 gefountain@lantronix.com Message Sent (SLC Internal Temperature out of Range)
05/18/16 19:09 gefountain@lantronix.com Message Sent (SLC Internal Temperature out of Range)
05/18/16 19:08 gefountain@lantronix.com cannot locate host 2putt.lantronix.com: Name or service
not known
05/18/16 18:35 gefountain@lantronix.com Message Sent (SLC Internal Temperature out of Range)

```

2. To email this log, follow the instructions in [Emailing Logs and Reports \(on page 293\)](#).
3. To clear the log, click the **Clear Log** button.

Diagnostics

The [Maintenance > Diagnostics](#) page provides methods for diagnosing problems such as network connectivity and device port input/output problems. You can use equivalent commands on the command line interface.

1. Click the **Maintenance** tab and select the **Diagnostics** option. The following page displays:

Figure 13-7 Maintenance > Diagnostics

LANTRONIX[®] SLC 8048

Logout Host: slc4331 User: sysadmin

Select port for Configuration WebSSH (DP only) Connected Device (DP only)

Network Services User Authentication Devices Maintenance Quick Setup

Firmware/Config System Log Audit Log Email Log Diagnostics Status/Reports Events LCD/Keypad Banners

Diagnostics [Help?](#)

Select Diagnostics: All

ARP Table

Netstat Protocol: All TCP UDP

Host Lookup Hostname:

Ping Hostname:

Ethernet Port: Both Eth1 Eth2

IPv6:

Send Packet Protocol: TCP UDP

Hostname:

Port:

String:

Count:

Loopback Device Port:

Test: Internal External

SLC Internals

USB Devices Tree Display:

Map Device:

2. Select **Diagnostics** from checklist (one or more diagnostic methods you want to run, or select **All** to run them all):

IPv4 ARP Table	The IPv4 Address Resolution Protocol (ARP) table used to view the IP address-to-hardware address mapping.
IPv6 Neighbor Table	The IPv6 Neighbor table is used to view a list of neighbor's IPv6 addresses on the same network, and their corresponding MAC addresses.
Netstat	Displays network connections. If you select the checkbox, select the TCP or UDP protocol, or select All for both protocols to control the output of the Netstat report.

Host Lookup	Select to verify that the SLC 8000 advanced console manager can resolve the host name into an IP address (if DNS is enabled). If selected, also enter a host name in the corresponding Hostname field,
Ping	Select to verify that the host is up and running. If selected, also do the following: <ul style="list-style-type: none"> ◆ Enter a host name in the corresponding Hostname field ◆ Specify Ethernet Port (Both, Eth1 or Eth2) ◆ Check if the IPv6 version of ping should be used.
Send Packet	This option sends an Ethernet packet out one of the Ethernet ports, mainly as a network connectivity test. For UDP, the number of times the string is sent is equal to the number of packets sent. For TCP, the number of times the string is sent may (or may not) be equal to the number of packets sent, because TCP controls how data is packetized and sent out. Enter the following: <ul style="list-style-type: none"> ◆ Protocol: Select the type of packet to send (TCP or UDP). ◆ Hostname: Specify a host name or IPaddress of the host to send the packet to. ◆ Port: Specify a TCP or UDP port number of the host to send the packet to. ◆ String: Enter a set of up to 64 characters. The string is encapsulated in the packet (so you could use a network sniffer to track the packet and, by looking at its contents, verify that it was sent). ◆ Count: The count is the number of times the string is sent.
Loopback	Specify loopback information: <ul style="list-style-type: none"> ◆ Device Port ◆ Select either an Internal or External test <p><i>Note: The External test is currently not supported for USB device ports</i></p>
SLC Internals	Select to display information on the internal memory, storage and processes of the SLC 8000 advanced console manager.
USB Devices	Select to display information about USB buses and the devices connected to them, including a mapping between a USB device and the SLC ports.

3. Click the **Run Diagnostics** button. The [Maintenance > Diagnostics](#) page displays.

Figure 13-8 Maintenance > Diagnostics

LANTRONIX[®] SLC 8048

Logout Host: slc4331 User: sysadmin

Select port for Configuration WebSSH (DP only) Connected Device (DP only)

Network Services User Authentication Devices Maintenance Quick Setup

Firmware/Config System Log Audit Log Email Log Diagnostics Status/Reports Events LCD/Keypad Banners

Diagnostics Help?

Select Diagnostics: All

- IPv4 Arp Table
- IPv6 Neighbor Table
- Netstat Protocol: All TCP UDP
- Host Lookup Hostname:
- Ping Hostname:
- Send Packet Ethernet Port: Both Eth1 Eth2
- Loopback IPv6:
- SLC Internals Protocol: TCP UDP
- USB Devices Hostname:
- Port:
- String:
- Count:
- Device Port:
- Test: Internal External
- Tree Display:
- Map Device:

4. To view a report, click the link for that report.
5. To email this report, follow the instructions in [Emailing Logs and Reports \(on page 293\)](#).

Diagnostic Commands

The following CLI commands correspond to the web page entries described above.

To display the Address Resolution Protocol table (for IPv4) or the Neighbor table (for IPv6) for mapping IP Addresses to hardware addresses:

```
diag arp|arp6 [email <Email Address>]
```

Note: You can optionally email the displayed information.

To display a report of network connections:

```
diag netstat [protocol <all|tcp|udp>] [email <Email Address>]
```

Note: You can optionally email the displayed information.

To resolve a host name into an IP address:

```
diag lookup <Hostname> [email <Email Address>]
```

You can optionally email the displayed information.

To test a device port by transmitting data out the port and verifying that it is received correctly:

```
diag loopback <Device Port Number or Name>[<parameters>]
```

Parameters

```
test <internal|external>
```

```
xferdatasize <Size In Kbytes to Transfer>
```

Default is 1 Kbyte.

Note: A special loopback cable comes with the SLC unit. To test a device port, plug the cable into the device port and run this command. The command sends the specified Kbytes to the device port and reports success or failure. The test is performed at 9600 baud. Only an external test requires a loopback cable. The External test is currently not supported for USB device ports.

To display the route that packets take to get to a network host:

```
diag traceroute <IP Address or Hostname>
```

To verify that a host is up and running:

```
diag ping|ping6 <IP Address or Name> [<parameters>]
```

Parameters

```
ethport <1|2> count <Number of Times to Ping>
```

The default is 5.

```
packetsize <Size in Bytes>
```

The default is 64.

To display performance statistics for an Ethernet port or a device port (averaged over the last 5 seconds):

```
diag perfstat [ethport <1|2>] [deviceport <Device Port # or Name>]
```

To generate and send Ethernet packets:

```
diag sendpacket host <IP Address or Name> port <TCP or UDP Port Number>
[string <Packet String>] [protocol <tcp|udp>] [count <Number of
Packets>]
```

The default protocol is tcp and the default count is 1.

To display all network traffic, applying optional filters:

Note: This command is not available on the web interface.

```
diag nettrace <one or more parameters>
```

Parameters

```
ethport <1|2>
host <IP Address or Name>
numpackets <Number of Packets>
protocol <tcp|udp|icmp|esp>
verbose <enable|low|medium|high|disable>
```

To display CPU usage, memory usage and tasks.

```
diag top [parameters]
```

Parameters

```
continuous <enable|disable>
count <Number of Iterations to Display>
delay <Delay in Seconds>
numlines <Number of Lines to Display>
```

Defaults: count=1, delay = 5 seconds

To display information on the internal memory, storage and processes of the SLC 8000 advanced console manager:

```
diag internals
```

Enable debug printing on the next SLC reboot:

```
diag internals [printapplication <enable|disable>
  printconnection <enable|disable>
  printmanagement <enable|disable>
```

Note: This command is available on the web interface as SLC Internals under **Maintenance > Diagnostics**.

To display information about USB buses and the devices connected to them, including the mapping between a USB device and the SLC port:

```
diag usb [<parameters>]
```

Parameters

```
treedisplay <enable|disable>
mapdevice <enable|disable>
email <Email Address>
Defaults: treedisplay=enable
```

Note: For "mapdevice enable", the port numbers will display at the end of the line in square brackets.

Status/Reports

On this page, you can view the status of the SLC ports and power supplies and generate a selection of reports.

Note: Status and statistics shown on the web interface represent a snapshot in time. To see the most recent data, you must reload the web page.

1. Click the **Maintenance** tab and select the **Status/Reports** option. The following page displays:

Figure 13-9 Maintenance > Status/Reports

The screenshot shows the LANTRONIX SLC 8048 web interface. At the top, there's a navigation bar with tabs for Network, Services, User Authentication, Devices, Maintenance (selected), and Quick Setup. Below this is a sub-navigation bar with links for Firmware/Config, System Log, Audit Log, Email Log, Diagnostics, Status/Reports (selected), Events, LCD/Keypad, and Banners. The main content area is titled 'Status/Reports' and contains several sections:

- System Status:**
 - Eth1: Up (Green)
 - Eth2: Down (Red)
 - Power Supply A: Failed (Red)
 - Power Supply B: OK (Green)
 - Console Port: Not Connected (Red)
 - Internal Modem: Not Installed (Green)
 - Internal Temperature: 52 °C (125 °F) (Green)
- Device Ports:** A grid of 48 ports, all showing 'OK' with a green checkmark.
- View Report:** A list of checkboxes for selecting reports:
 - All
 - Port Status
 - Port Counters
 - IP Routes
 - Connections
 - System Configuration - Complete
 - System Configuration - Basic
 - System Configuration - Authentication
 - System Configuration - Devices
- Generate Report:** A button to generate the selected report.

The top half of the page displays the status of each port, power supply, and the internal modem:

- **Green** indicates that the port connection or power supply is active and functioning correctly.
- **Red** indicates an error or failure or that the device is off.

2. Select the desired reports to view under **View Report**:

View Report

All	Displays all reports.
Port Status	Displays the status of each device port: mode, user, any related connections, and serial port settings.
Port Counters	Displays statistics related to the flow of data through each device port.
IP Routes	Displays the routing table.
Connections	Displays all active connections for the SLC unit: Telnet, SSH, TCP, UDP, device port, and modem.

System Configuration – Complete	Displays a complete snapshot of the SLC settings.
System Configuration – Basic	Displays a snapshot of the SLC unit's basic settings (for example, network, date/time, routing, services, console port).
System Configuration – Authentication	Displays a snapshot of authentication settings only (including a list of all localusers).
System Configuration - Devices	Displays a snapshot of settings for each device port, USB Port, Modem, and Host Lists.

- Click the **Generate Report** button. In the upper left of the *Generated Status/Reports* page displays a list of reports generated.

Figure 13-10 Generated Status/Reports

The screenshot shows the LANTRONIX SLC 8048 web interface. At the top, there is a navigation bar with buttons for Network, Services, User Authentication, Devices, Maintenance, and Quick Setup. Below this is a sub-navigation bar with links for Firmware/Config, System Log, Audit Log, Email Log, Diagnostics, Status/Reports, Events, LCD/Keypad, and Banners. The main content area is titled "Status/Reports" and includes a "Help?" button. There are input fields for "Report(s):", "Email Output", and "Comment:". Below these, there are links for "IP Routes" and "Connections". The "IP Routes" section displays two tables: "Kernel IP routing table" and "Kernel IPv6 routing table". The "Connections" section displays a table with columns for Id Port/Service, Flw Port/Service, User, and Uptime. The total connections are listed as 1.

Kernel IP routing table

Destination	Gateway	Genmask	Flags	MSS	Window	irtt	Iface
0.0.0.0	172.19.0.1	0.0.0.0	UG	0	0	0	eth0
172.19.0.0	172.19.100.148	255.255.0.0	U	0	0	0	eth0

Kernel IPv6 routing table

Destination	Next	Hop	Flags	Metric	Ref	Use	Iface
::1/128			::			U	0 2 1 lo
2001:db80:ac13:d91e:280:a3ff:fe96:4331/128			::			U	0 0 1 lo
2001:db80:ac13:d91e::/64			::			UA	256 0 0 eth0
fe80::280:a3ff:fe96:4331/128			::			U	0 0 1 lo
fe80::/64			::			U	256 0 0 eth0
ff02::1/128			ff02::1			UC	0 3 0 eth0
ff00::/8			::			U	256 0 0 eth0
::/0			fe80::20c:29ff:fee9:bc25			UGDA	1024 0 0 eth0
::/0			fe80::6600:f1ff:feb6:586e			UGDA	1024 0 0 eth0

Connections

Id	Port/Service	Flw	Port/Service	User	Uptime
2	Console Port	<->	Command Line		84:22:31

Total Connections: 1

- To email these report(s), follow the instructions in *Emailing Logs and Reports (on page 293)*.

Status Commands

These commands for the command line interface correspond to the web page entries described above.

To display device port modes and states for one or more ports:

```
show portstatus [deviceport <Device Port List or Name>] [email <Email Address>]
```

You can optionally email the displayed information.

To display a snapshot of configurable parameters:

```
show sysconfig [display <basic|auth|devices>] [email <Email Address>]
```

You can optionally email the displayed information.

Displays a report of all configurable parameters or a shorter report with basic system settings, authentication settings, or device settings.

To generate a report for one or more ports: You can optionally email the displayed information.

```
show portcounters [deviceport <Device Port List or Name>] [email <Email Address>]
```

To display the overall status of all SLC units:

```
show sysstatus [email <Email Address>]
```

You can optionally email the displayed information.

To display a list of all current connections:

```
show connections [email <Email Address>]
```

You can optionally email the displayed information.

To provide details, e.g., endpoint parameters and trigger, for a specific connection:

```
show connections connid <Connection ID> [email <Email Address>]
```

You can optionally email the displayed information.

Note: Use the *basic* `show connections` command to obtain the Connection ID.

Emailing Logs and Reports

The following logs and reports can be directly emailed to a specific individual or to Lantronix Technical Support directly from the log page:

- ◆ System Log ([Figure 13-4](#))
- ◆ Audit Log ([Figure 13-5](#))
- ◆ Email Log ([Figure 13-6](#))

- ◆ Diagnostic Reports ([Figure 13-8](#))
- ◆ Status/Reports ([Figure 13-10](#))

To email a log to an individual:

1. In the **Comment** field of a particular log or report page, enter a comment (if desired).
2. Select the **to** field beside the empty field where you then enter the person's email address.
3. Press the **Email Output** button. An email is immediately sent out and a confirmation appears on the screen.

Figure 13-11 Emailed Log or Report

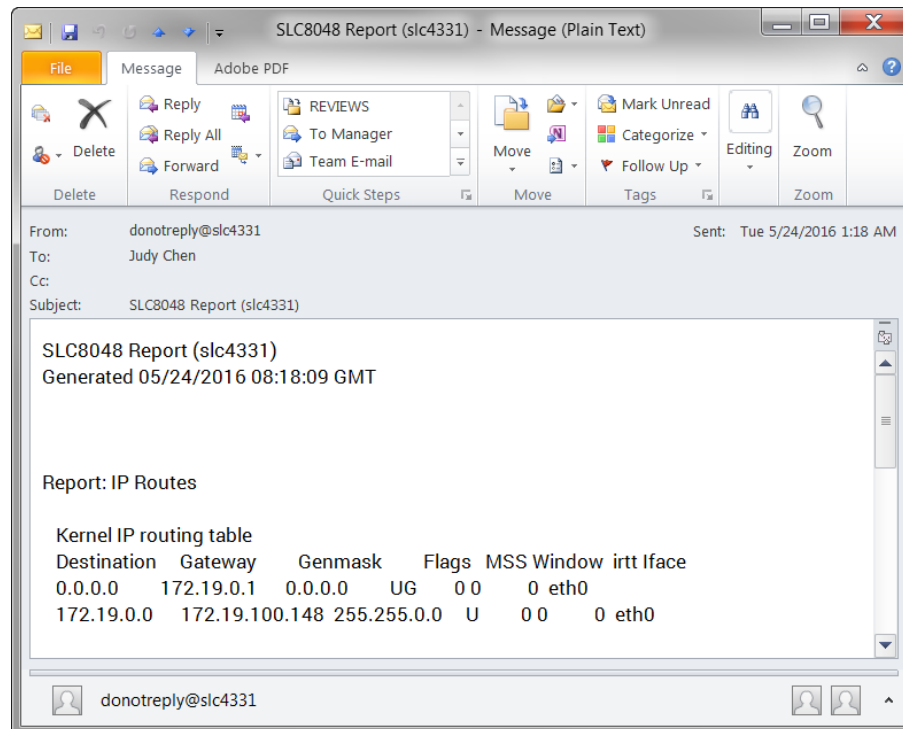

To view information about the SLC unit and contact information for Lantronix:

1. Click the [?](#) button on the upper right portion of any web page to access the **About SLC** page (see [Figure 13-12](#)).

Figure 13-12 About SLC

Click to go forward, hold to see history

LANTRONIX SLC 8048

Host: **slc48SFP251-7400R11**
User: **sysadmin**

Logout

Select port for Configuration WebSSH (DP only) Connected Device (DP only)

Network Services User Authentication Devices Maintenance Quick Setup

About SLC 8048

Model: **SLC 8048**
 Number of USB Ports: **2**
 Internal Modem: **Not Installed**
 Power Supply: **AC, 1 power supply**
 S/N: **0080A3968D02**

Memory: **512 MB**
 Flash Size: **512 MB**
 Eth1 HW Address: **00:80:a3:96:8d:02**
 Eth2 HW Address: **00:80:a3:96:8d:03**
 NIC Board Type: **SFP**
 NIC Board Revision: **02FPA**
 NIC Board Eth1 SFP: **1000BASE-LX Single Mode (Vendor: OEM PN: SFPGLCLHSMST Rev: 1.0)**
 NIC Board Eth2 SFP: **Generic (Vendor: FiberStore PN: SFP-GE-BX Rev: A0)**

Uptime: **1 day, 2 hours, 52 minutes**

Firmware Version: **7.4.0.0R11**
 OS Version:
 Bootloader Version: **2.0.0.0R8**
 Main Board Revision: **080-542-R/330-298-R (Rev 2)**
 I/O Module Type(s): **RJ45-16, RJ45-16, RJ45-16**
 I/O Module Revision(s): **16SPB, 16SPB, 16SPB**

Software Revisions:
 Kernel: **3.6.5**
 SSH/SSL: **OpenSSH_6.7p1, OpenSSL 1.0.2k 26 Jan 2017**
 Telnet: **netkit-telnet-0.17**
 NTP: **ntpd 4.2.6p5**
 SMB/CIFS: **Version 3.6.14**
 RIP: **zebra version 0.99.22.1**
 Web Server: **mini_httpd/1.24**
 PAM/NIS: **1.1.4**
 LDAP: **153**
 RADIUS: **1.4.0**
 Kerberos: **2.4.8**
 TACACS+: **1.3.9**
 ShellInABox: **2.19**

Bootloader Configuration:
 Number of Ports: **48**
 Model Number: **101**
 Product Name: **SLC**
 Options: **00000000000000000000000000000002**

© 2003-2017, Lantronix, All rights reserved.

Lantronix Corporate Headquarters
 7535 Irvine Center Drive, Suite 100
 Irvine, CA 92618 USA
 Tel: +1 (949) 453-3990
 Fax: +1 (949) 453-3995

Technical Support
 Hours: 6:00a - 5:00p PST
 Monday - Friday (excluding holidays)
 Tel: (800) 422-7044 (US only)
 Tel: (949) 453-7198
 Fax: (949) 450-7226
 FTP: ftp.lantronix.com

Events

On this [Maintenance > Events](#) page, you can define what action you want to take for events that may occur in the SLC unit.

1. Click the **Maintenance** tab and select the **Events** option. The following page displays:

Figure 13-13 Maintenance > Events

LANTRONIX® SLC 8048

Logout Host: slc4331 User: sysadmin

Select port for Configuration WebSSH (DP only) Connected Device (DP only)

Network Services User Authentication Devices Maintenance Quick Setup

Firmware/Config System Log Audit Log Email Log Diagnostics Status/Reports Events LCD/Keypad Banners

Events Help?

Trigger: Action:

Host to Ping:

RPM:

Outlet: (optional)

Threshold: Amps or Load %

Ethernet: Eth1 Eth2

Modem Connection: USB Port U1 USB Port U2 Device Port:

NMS/Host to forward trap to:

SNMP Community:

SNMP Trap OID:

Email Address:

To edit or delete an event, select the radio button in the right column below.

Events				
Id	Trigger	Options	Action	Options

2. Enter the following:

Event Trigger	From the drop-down list, select the type of incident that triggers an event. Currently, the options are: <ul style="list-style-type: none"> ◆ Receive Trap ◆ Temperature Over/Under Limit (for Sensorsoft devices) ◆ Humidity Over/Under Limit (for Sensorsoft devices) ◆ Device Port Data Drop ◆ No Internal Modem Dial Tone ◆ Ping Host Fails ◆ RPM Load Over Threshold
Host to Ping	When the trigger is set to Ping Host Fails , enter the hostname, IPv4 address or IPv6 address of the host to ping. The host will be pinged every 2 minutes.
RPM	When the trigger is set to RPM Load over Threshold , select the RPM that will be monitored for a current that exceeds a defined threshold. The RPM needs to support providing a current level as part of its status information. The RPM current will be checked every 2 minutes.

Outlet	When the trigger is set to RPM Load over Threshold , select the outlet that will be monitored for a current that exceeds a defined threshold. The RPM needs to support providing a current level for the selected outlet as part of its status information. If an outlet is not specified, the current level for the entire device will be monitored. The RPM current will be checked every 2 minutes.
Threshold	When the trigger is set to RPM Load over Threshold , specify the maximum allowable threshold for the current; any current readings over this threshold will trigger the selected action. The threshold can be specified in Amps (e.g. 8.5) or as a percentage (e.g. 90%).
Action	From the drop-down list, select the action taken because of the trigger. For example, the action can be writing an entry into the syslog with details of the event or sending the trap(s) to the Ethernet or modem connection. <ul style="list-style-type: none"> ◆ Syslog ◆ Forward All Traps to Ethernet ◆ Forward Selected Trap to Ethernet ◆ Forward all Traps to a Modem Connection ◆ Forward Selected Trap to a Modem Connection ◆ Email Alert ◆ SNMP Trap
Ethernet	For actions that require an Ethernet connection (for example, Forward All Traps to Ethernet), select the Ethernet port to use.
Modem Connection on	For actions that require a modem connection (for example, Forward All Traps to a Modem Connection), select which modem connection to use (Device Port , USB Port U1 , USB Port U2 , or the Internal Modem). Connections available depend on the model of the SLC unit.
NMS/Host to forward trap to	For actions that forward a trap, enter the IP address of the computer to forward the trap to. The computer does not have to be an SNMP NMS; it just has to be capable of receiving SNMP traps.
SNMP Community	Forwarded traps are sent with this SNMP community value There is no default.
SNMP Trap OID	Enter a unique identifier for an SNMP object. (An SNMP object is anything that can hold a value and can be read using an SNMP "get" action.) The OID consists of a string of numbers separated by periods (for example, 1.1.3.2.1). Each number is part of a group represented by the number on its left.
Email Addresses	Enter an email address to receive email alerts.

3. You have the following options:

- To add the defined event, click the **Add Event** button. The event displays in the Events table at the bottom of the page.
- To edit an event, select the event from the Events table and click the **Edit Event** button. The [Maintenance > Events](#) page displays the event.
- To delete an event, select the event from the Events table and click the **Delete Event** button. A message asks for confirmation. Click **OK**.

4. To save, click **Apply**.

Events Commands

To manage the response to events that occur in the SLC 8000 advanced console manager:

```
admin events add <trigger> <response>
  <trigger> is one of: dpmatadrop, humidlimit, nomodemdial, pingfails,
  receivetraps, rpmload or templimit
  |receivetraps|templimit|humidlimit|overcurrent|dpmatadrop
  <response> is one of:
  action <syslog>
  action <fwdalltrapsseth|fwdseltrapseth> ethport <1|2> nms <SNMP NMS>
  community <SNMP Community> [oid <SNMP OID>]
  action <fwdalltrapsmodem|fwdseltrapmodem> deviceport <Device Port
  # or Name> nms <SNMP NMS> community <SNMP Community> [oid <SNMP
  Trap OID>]
  action <fwdalltrapsmodem|fwdseltrapmodem> usbport <U1|U2>
  nms <SNMP NMS> community <SNMP Community> [oid <SNMP Trap OID>]
  action <fwdalltrapsmodem|fwdseltrapmodem> internal modem
  nms <SNMP NMS> community <SNMP Community> [oid <SNMP Trap OID>]
  action <emailalert> emailaddress <destination email address>
```

To update event definitions:

```
admin events edit <Event ID> <parameters>
```

Parameters

```
community <SNMP Community>
deviceport <Device Port # or Name>
ethport <1|2>
host <IP Address or Name>
internal modem
nms <SNMP NMS>
oid <SNMP Trap OID>
outlet <Outlet #>
rpm <RPM Id or Name>
threshold <Load Percentage|Current in Amps>
usbport <U1|U2>
emailaddress <destination email address>
```

To delete an event:

```
admin events delete <Event ID>
```

To view events:

```
admin events show
```

LCD/Keypad

The LCD has a series of screens, consisting of 2 lines of 24 characters each. Specific screens and the display order can be configured. The keypad associated with the LCD can also be configured. The types of screens include: current time, network settings, console settings, date and time, release version, location, and custom user strings.

Enabling the **Auto-Scroll LCD Screens** option enables scrolling through the screens and pausing the number of seconds specified by the **Scroll Delay** between each screen. After any input to the keypad, the LCD waits until the keypad has been idle for the number of seconds specified by the **Idle Delay** before scrolling of the screens continues.

To configure the LCD and Keypad:



1. Click the **Maintenance** tab and select the **LCD/Keypad** option.



Figure 13-14 Maintenance > LCD/Keypad

The screenshot shows the LANTRONIX SLC 8048 web interface. At the top, there's a navigation bar with tabs: Network, Services, User Authentication, Devices, Maintenance (selected), and Quick Setup. Below this is a sub-menu with links: Firmware/Config, System Log, Audit Log, Email Log, Diagnostics, Status/Reports, Events, LCD/Keypad (selected), and Banners. The main content area is titled 'LCD/Keypad' and has a 'Help?' link. It is split into two sections: 'LCD Settings' and 'Keypad Settings'.
LCD Settings:
 - 'Enabled screens (in display order):' list: Current Time, Network, Console, Date/Time, Release. Arrows on the left allow moving screens up/down. Arrows on the right allow moving screens to the disabled list.
 - 'Disabled screens:' list: Device Ports, Location, User Strings, Internal Temp. Arrows on the right allow moving screens to the enabled list.
 - 'User Strings - Line 1:' and 'Line 2:' input fields.
 - 'Auto-Scroll LCD Screens:' checkbox (unchecked).
 - 'Scroll Delay: 5 seconds' and 'Idle Delay: 10 seconds' input fields.
 - 'Apply' button.
Keypad Settings:
 - 'Keypad Locked:' checkbox (unchecked).
 - 'Restore Factory Defaults Password:' and 'Retype Password:' input fields.

To configure the LCD:

The screens that are currently enabled are displayed in order in the left Enabled screens list.

1. Select a screen to be removed from the **Enabled Screens** and click the  button. The screen moves to the **Disabled Screens** list to the right.
2. Select a screen to be added from the **Disabled Screens** list and click the  button. The screen is added to the **Enabled Screens** to the left.

3. Select a screen in the **Enabled Screens** list and click the  or  button to change the order of the screens.

Note: The *User Strings* screen displays the 2 lines defined by the *User Strings - Line 1* and *Line 2* fields. By default, these user strings are blank.

4. Click **Apply** to save.

To configure the Keypad:

1. Enter the following fields.

Keypad Locked	Select this to lock out any input to the keypad. The default is for the keypad to be unlocked.
Restore Factory Defaults Password / Retype Password	Enter the 6 digit key sequence entered at the keypad to restore the SLC unit to factory defaults. The default is 999999 .

2. Click **Apply** to save.

LCD/Keypad Commands

The following CLI commands correspond to the [Maintenance > LCD/Keypad](#) page. For more information, see [Chapter 15: Command Reference on page 308](#).

- ◆ admin keypad
- ◆ admin keypad password
- ◆ admin keypad show
- ◆ admin lcd reset
- ◆ admin lcd default
- ◆ admin lcd screens
- ◆ admin lcd line1
- ◆ admin lcd scrolling
- ◆ admin lcd show

Banners

The [Maintenance > Banners](#) page allows the system administrator to customize text messages that display to users.

To configure banner settings:

1. Click the **Maintenance** tab and select **Banners** option.

Figure 13-15 Maintenance > Banners

LANTRONIX[®] SLC 8048

Logout Host: slc4331 User: sysadmin

Select port for Configuration WebSSH (DP only) Connected Device (DP only)

Network Services User Authentication Devices Maintenance Quick Setup

Firmware/Config System Log Audit Log Email Log Diagnostics Status/Reports Events LCD/Keypad Banners

Banners Help ?

Welcome Banner:

Login Banner:

Logout Banner:

SSH Banner:

Note: Line feeds can be included in the banners with the '\n' character sequence.
The web banner can be configured [here](#) >.

Apply

2. Enter the following fields.

Welcome Banner	The text to display on the command line interface before the user logs in. May contain up to 1024 characters. Single quote and double quote characters are not supported. Welcome to the SLC is the default. Note: To create more lines use the <code>\n</code> character sequence.
Login Banner	The text to display on the command line interface after the user logs in. May contain up to 1024 characters. Single quote and double quote characters are not supported. Default is blank. Note: To create more lines, use the <code>\n</code> character sequence.
Logout Banner	The text to display on the command line interface after the user logs out. May contain up to 1024 characters. Single quote and double quote characters are not supported. Default is blank. Note: To create more lines use, the <code>\n</code> character sequence.
SSH Banner	The text to display when a user logs into the SLC via SSH, prior to authentication. May contain up to 1024 characters. Single quote and double quote characters are not supported. Blank by default. Note: To create more lines use the <code>\n</code> character sequence.

3. Click **Apply** to save.

Banner Commands

The following CLI commands correspond to the [Maintenance > Banners](#) page. For more information, see [Chapter 15: Command Reference on page 308](#).

- ◆ admin banner login
- ◆ admin banner logout
- ◆ admin banner show
- ◆ admin banner ssh
- ◆ admin banner welcome

14: Application Examples

Each SLC advanced console manager has multiple serial ports and two network ports. Each serial port can be connected to the console port of an IT device. Using a network port (in-band) or a modem (out-of-band) for dial-up connection, an administrator can remotely access any of the connected IT devices using Telnet or SSH.

Figure 14-1 SLC - Console Manager Configuration

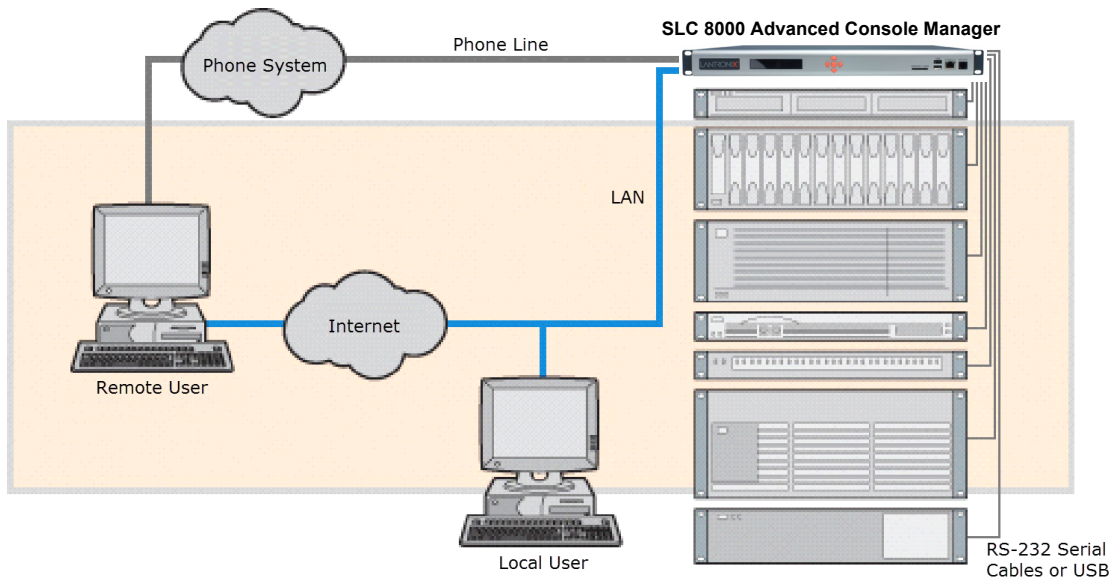

This chapter includes three typical scenarios for using the SLC unit. The scenarios assume that the SLC 8000 advanced console manager is connected to the network and has already been assigned an IP address. In the examples, we use the command line interface. You can do the same things using the web page interface except for directly interacting with the SLC unit (`direct` command).

Telnet/SSH to a Remote Device

The following figure shows a Sun server connected to port 2 of the SLC 8000 advanced console manager.

Figure 14-2 Remote User Connected to a SUN Server via the SLC unit

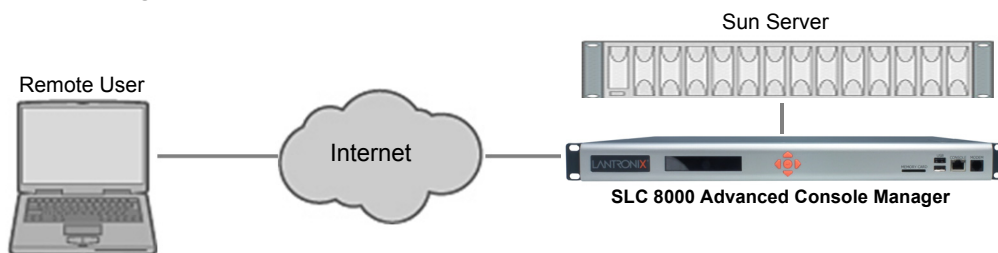

In this example, the sysadmin would:

1. Display the current settings for device port 2:

```
[SLC]> show deviceport port 2
___Current Device Port
Settings_____
Number: 2 Name: Port-2

Modem Settings-----Data Settings-----IP Settings-----
Modem State: disabled      Baud Rate: 9600      Telnet: disabled
Modem Mode: text           Data Bits: 8         Telnet Port: 2002
Timeout Logins: disabled  Stop Bits: 1        SSH: disabled
Local IP: negotiate        Parity: none         SSH Port: 3002
Remote IP: negotiate       Flow Control: xon/xoff IP: <none>
Authentication: PAP        Logins: disabled
CHAP Host: <none>          Break Sequence: \x1bB
CHAP Secret: <none>        Check DSR: disabled
NAT: disabled              Close DSR: disabled
Dial-out Login: <none>
Dial-out Password: <none>
Dial-out Number: <none>
Dial-back Number: usernumber
Initialization Script: <none>
```

```
Logging Settings-----
Local Logging: disabled    USB Logging: disabled
Email Logging: disabled    Log to: upper slot
Byte Threshold: 100        Max number of files: 10
Email Delay: 60 seconds    Max size of files: 2048
Restart Delay: 60 seconds
Email To: <none>
Email Subject: Port %d Logging
Email String: <none>
NFS File Logging: disabled
Directory to log to: <none>
Max number of files: 10
Max size of files: 2048
```

2. Change the baud to 57600 and disable flow control:

```
[SLC]> set deviceport port 2 baud 57600 flowcontrol none
Device Port settings successfully updated.
```

3. Connect to the device port:

```
[SLC]> connect direct deviceport 2
```

4. View messages from the SUN server console:

```
Mar 15 09:09:44 tssf280r sendmail[292]: [ID 702911 mail.info] starting
daemon (8.12.2+Sun): SMTP+queueing@00:15:00
Mar 15 09:09:44 tssf280r sendmail[293]: [ID 702911 mail.info] starting
daemon (8.12.2+Sun): queueing@00:15:00
Mar 15 14:44:40 tssf280r sendmail[275]: [ID 702911 mail.info] starting
daemon (8.12.2+Sun): SMTP+queueing@00:15:00
Mar 15 14:44:40 tssf280r sendmail[276]: [ID 702911 mail.info] starting
daemon (8.12.2+Sun): queueing@00:15:00
```

5. Reboot the SUN server:

```
Reboot
```

<shutdown messages from SUN>

6. Use the escape sequence to escape from direct mode back to the command line interface.

Dial-in (Text Mode) to a Remote Device

This example shows a phone line connection to the internal modem of the SLC, and a Sun server connected to a device port. You can configure the modem for text mode dial-in, so a remote user can dial into the modem using a terminal emulation program and access the Sun server.

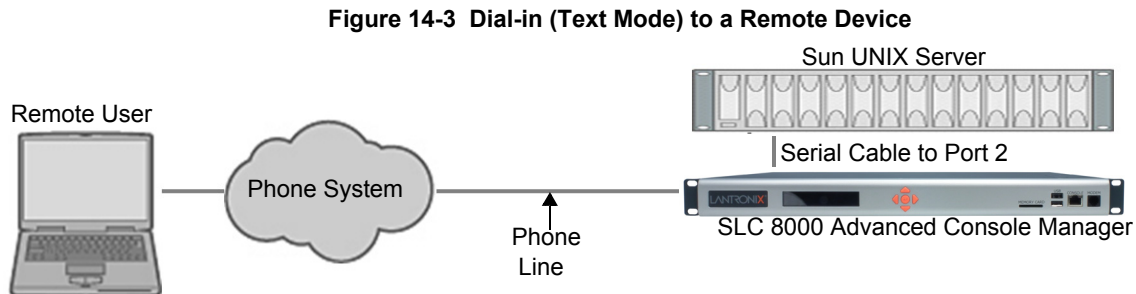

In this example, the sysadmin would:

1. Configure the device port that the modem is connected to for dial-in:

```
[SLC]> set deviceport port 1 modemmode text
Device Port settings successfully updated.
[SLC]> set deviceport port 1 initscript "AT&F&K3&C1&D2%COA"
Device Port settings successfully updated.
[SLC]> set deviceport port 1 auth pap
Device Port settings successfully updated.
[SLC]> set deviceport port 1 localsecret "password"
Device Port settings successfully updated.
[SLC]> set deviceport port 1 modemstate dialin
Device Port settings successfully updated.
[SLC]>
```

2. Configure the device port that is connected to the console port of the Sun UNIX server:

```
[SLC]> set deviceport port 2 baud 57600 flowcontrol none
Device Port settings successfully updated.
```

3. Dial into the SLC 8000 advanced console manager via the modem using a terminal emulation program on a remote PC. A command line prompt displays.

4. Log into the SLC unit.

```
CONNECT 57600
Welcome to the SLC
login: sysadmin
Password:
Welcome to the SLC Console Manager
Model Number: SLC 8048
For a list of commands, type 'help'.
[SLC]>
```

5. Connect to the SUN Unix server using the direct command.

```
[SLC]> connect direct deviceport 2
SunOS 5.7
login: frank
Password:
Last login: Wed Jul 14 16:07:49 from computer
Sun Microsystems Inc.SunOS 5.7Generic October 1998
SunOS computer 5.7 Generic_123485-05 sun4m sparc SUNW,SPARCstation-20
$
```

6. Use the escape sequence to escape from direct mode back to the command line interface.

Local Serial Connection to Network Device via Telnet

This example shows a terminal device connected to an SLC device port, and a Sun server connected over the network to the SLC device. When a connection is established between the device port and an outbound Telnet session, users can access the Sun server as though they were directly connected to it. (See [Chapter 11: Connections on page 209](#)).

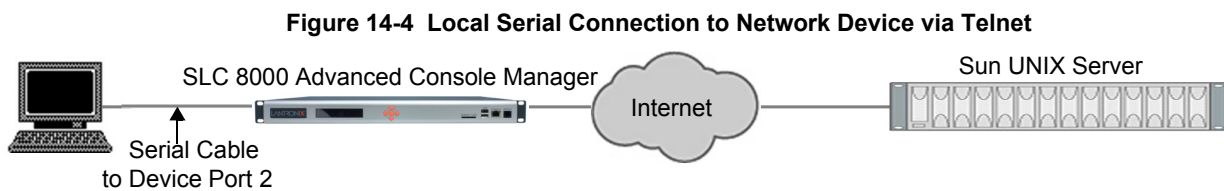

In this example, the sysadmin would:

1. Display the current settings for device port 2:

```
[SLC]> show deviceport port 2
__Current Device Port
Settings_____
Number: 2 Name: Port-2
Modem Settings-----Data Settings-----IP Settings-----
Modem State: disabled      Baud Rate: 9600          Telnet: disabled
Modem Mode: text           Data Bits: 8             Telnet Port: 2002
Timeout Logins: disabled   Stop Bits: 1            SSH: disabled
Local IP: negotiate        Parity: none            SSH Port: 3002
Remote IP: negotiate       Flow Control: xon/xoff   IP: <none>
Authentication: PAP        Logins: disabled
CHAP Host: <none>          Break Sequence: \x1bB
CHAP Secret: <none>       Check DSR: disabled
NAT: disabled             Close DSR: disabled
Dial-out Login: <none>
Dial-out Password: <none>
Dial-out Number: <none>
Dial-back Number: usernumber
Initialization Script: <none>
```

```

Logging Settings-----
Local Logging: disabled      USB Logging: disabled
Email Logging: disabled     Log to: upper slot
Byte Threshold: 100         Max number of files: 10
Email Delay: 60 seconds     Max size of files: 2048
Restart Delay: 60 seconds
Email To: <none>
Email Subject: Port %d Logging
Email String: <none>
NFS File Logging: disabled
Directory to log to: <none>
Max number of files: 10
Max size of files: 2048

```

2. Change the serial settings to match the serial settings for the vt100 terminal - changes baud to 57600 and disables flow control:

```

[SLC]> set deviceport port 2 baud 57600 flowcontrol none
Device Port settings successfully updated.

```

3. Create a connection between the vt100 terminal connected to device port 2 and an outbound telnet session to the server. (The IP address of the server is 192.168.1.1):

```

[SLC]> connect bidirection 2 telnet 192.168.1.1
Connection settings successfully updated.

```

4. At the VT100 terminal, hit <return> a couple of times. The Telnet prompt from the server displays:

```

Trying 192.168.1.1...
Connected to 192.168.1.1.
Escape character is '^]'.

```

```

Sun OS 8.0
login:

```

At this point, a user can log in and interact with the Sun server at the VT100 terminal as if directly connected to the server.

15: Command Reference

After an introduction to using commands, this chapter lists and describes all of the commands available on the SLC command line interface accessed through Telnet, SSH, or a serial connection. The commands are in alphabetical order by category.

Introduction to Commands

Following is some information about command syntax, command line help, and tips for using commands.

Command Syntax

Commands have the following format:

```
<action> <category> <parameter(s)>
```

where

<action> is set, show, connect, admin, diag, or logout.

<category> is a group of related parameters whose settings you want to configure or view. Examples are ntp, deviceport, and network.

<parameter(s)> is one or more name-value pairs in one of the following formats:

<parameter name> <aa bb>	User must specify one of the values (aa or bb) separated by a vertical line (). The values are in all lowercase and must be entered exactly as shown. Bold indicates a default value.
<parameter name> <Value>	User must specify an appropriate value, for example, an IP address. The parameter values are in mixed case. Square brackets [] indicate optional parameters.

Table 15-1 Actions and Category Options

Action	Category
set	auth cifs cli command consoleport datetime deviceport groups history hostlist intmodem ipfilter kerberos ldap localusers log menu network nfs nis ntp password radius remoteusers routing rpm script sdcard security services site slcnetwork sshkey tacacs+ temperature usb vpn
show	auth auditlog cifs cli connections consoleport datetime deviceport emaillog groups history hostlist intmodem ipfilter kerberos ldap localusers log menu network nfs nis ntp portcounters portstatus radius remoteusers routing rpm script sdcard security services site slcnetwork sshkey sysconfig syslog sysstatus tacacs+ temperature usb user vpn
connect	bidirection direct global listen restart script terminate unidirection

Action (continued)	Category
diag	arp arp6 internals lookup loopback netstat nettrace perfstat ping ping6 sendpacket top traceroute usb
admin	banner chip clear config events firmware ftp keypad lcd memory quicksetup reboot shutdown site version web
logout	Terminates CLI session.

Command Line Help

For general Help and to display the commands to which you have rights, type:

```
help
```

For general command line Help, type:

```
help command line
```

For release notes for the current firmware release, type:

```
help release
```

For more information about a specific command, type help followed by the command, for example:





```
help set network or help admin firmware
```

Tips

- ◆ Type enough characters to identify the action, category, or parameter name uniquely. For parameter values, type the entire value. For example, you can shorten:

```
set network port 1 state static ipaddr 122.3.10.1 mask 255.255.0.0
```

 to

```
se net po 1 st static ip 122.3.10.1 ma 255.255.0.0
```
- ◆ Use the Tab key to automatically complete action, category, or parameter names. Type a partial name and press **Tab** either to complete the name if only one is possible, or to display the possible names if more than one is possible. Following a space after the preceding name, Tab displays all possible names.
- ◆ Should you make a mistake while typing, backspace by pressing the Backspace key and/or the Delete key, depending on how you accessed the interface. Both keys work if you use VT100 emulation in your terminal access program when connecting to the console port. Use the left  and right  arrow keys to move within a command.
- ◆ Use the up  and down  arrows to scroll through previously entered commands. If desired, select one and edit it. You can scroll through up to 100 previous commands entered in the session.
- ◆ To clear an IP address, type 0.0.0.0, or to clear a non-IP address value, type CLEAR.

- ◆ When the number of lines displayed by a command exceeds the size of the window (the default is 25), the command output is halted until the user is ready to continue. To display the next line, press **Enter**, and to display the page, press the space bar. You can override the number of lines (or disable the feature altogether) with the `set cli` command.
- ◆ Keyboard Shortcuts:
 - Control-a**: move to the start of the line
 - Control-e**: move to the end of the line
 - Control-b**: move back to the start of the current word
 - Control-f**: move forward to the end of the next word
 - Control-u**: erase from cursor to the beginning of the line
 - Control-k**: erase from cursor to end of the line

Administrative Commands

admin banner login

Syntax

```
admin banner login <Banner Text>
```

Description

Configures the banner displayed after the user logs in.

Note: To go to the next line, type `\n` and press **Enter**.

admin banner logout0

Syntax

```
admin banner logout <Banner Text>
```

Description

Configures the banner displayed after the user logs out.

Note: To go to the next line, type `\n` and press **Enter**.

admin banner show

Syntax

```
admin banner show
```

Description

Displays the welcome, SSH, login, and logout banners.

admin banner ssh**Syntax**

```
admin banner ssh <Banner Text>
```

Description

Configures the banner that displays prior to SSH authorization.

admin banner welcome**Syntax**

```
admin banner welcome <Banner Text>
```

Description

Configures the banner displayed before the user logs in.

Note: To go to the next line, type `\n` and press **Enter**.

admin config checksum**Syntax**

```
admin config checksum
```

Description

Displays a checksum for the current configuration. Can be used to determine if the configuration has changed.

admin config copy**Syntax**

```
admin config copy <current|Config Name>  
                [location <local|nfs|cifs|usb|sdcard>  
                [nfsdir <NFS Mounted Directory>] [usbport <U1|U2>] ]
```

Description

Copies the current configuration (or optionally, a configuration from another location) to the other bank (for dual-boot SLCs).

admin config rename|delete**Syntax**

```
admin config delete <Config Name> location <local|nfs|cifs|usb|sdcard>
[usbport <U1|U2>] [nfsdir <NFS Mounted Directory>]
admin config rename <Config Name> location <local|nfs|cifs|usb|sdcard>
[usbport <U1|U2>] [nfsdir <NFS Mounted Directory>]
```

Description

Deletes or renames a configuration.

admin config factorydefaults**Syntax**

```
admin config factorydefaults [savesshkeys <enable|disable>] [savesslcert
<enable|disable>] [preserveconfig <Config Params to Preserve>]
[savescripts <enable|disable>]
```

<Config Params to Preserve> is a comma-separated list of current configuration parameters to retain after the config restore or factorydefaults:

nt	Networking
sv	Services
dt	Date/Time
lu	Local Users
dp	Device Ports
ra	Remote Authentication
ub	USB Port/SD Card

Description

Restores the SLC unit to factory default settings.

admin config restore**Syntax**

```
admin config restore <Config Name> location
<local|ftp|sftp|nfs|cifs|usb|sdcard> [nfsdir <NFS Mounted Directory>]
[usbport <U1|U2>] [preserveconfig <Config Params to Preserve>]
[savesshkeys <enable|disable>]
[savesslcert <enable|disable>]
[savescripts <enable|disable>]
```

<Config Params to Preserve> is a comma-separated list of current configuration parameters to retain after the config restore or factorydefaults:

nt	Networking
sv	Services
dt	Date/Time
lu	Local Users
ra	Remote Authentication
dp	Device Ports
ub	USB Port/SD Card

Description

Restores a saved configuration to the SLC 8000 advanced console manager.

admin config save

Syntax

```
admin config save <Config Name> location
<local|ftp|sftp|nfs|cifs|usb|sdcard> [nfsdir <NFS Mounted Dir>] [usbport
<U1|U2>]
[savesshkeys <enable|disable>]
[savesslcert <enable|disable>]
[savescripts <enable|disable>]
```

Description

Saves the current SLC configuration to a selected location.

admin config show

Syntax

```
admin config show <local|ftp|sftp|nfs|cifs|usb|sdcard> [nfsdir <NFS
Mounted Dir>] [usbport <U1|U2>]
```

Description

Lists the configurations saved to a location.

admin firmware bootbank

Syntax

```
admin firmware bootbank <1|2>
```

Description

Sets the boot bank to be used at the next SLC reboot.

admin firmware bootcount**Syntax**

```
admin firmware bootcount <0|1>
```

Description

Configures bootcount parameterse that control how many times the SLC has failed to boot. If this value reaches Boot Limit, the SLC will switch to the alternate boot bank. The SLC will switch to the alternate boot bank only once. For example, if it fails to boot Boot Limit times on bank 1, it will automatically switch to bank 2; if it fails to boot Boot Limit times on bank 2, it will enter advanced recovery mode. If Boot Count has reached Boot Limit, setting this value to 0 will enable the SLC to boot again. Default is 0, range is 0 - 1.

admin firmware bootlimit**Syntax**

```
admin firmware bootlimit <3-20>
```

Description

Configures bootlimit parameters that control how many times the SLC will fail to boot before switching to the alternate boot bank. After the SLC fails to boot 2 times Boot limit (so it has attempted to boot Boot Limit times on each bank), the SLC will go into advanced recovery mode, which may require support from Technical Support to resolve so that the SLC can be booted again. Default is 3 boots, range is 3 - 20.

admin firmware bootdelay**Syntax**

```
admin firmware bootdelay <3-1800>
```

Description

Configures bootcount parameters that control how seconds the bootloader pauses before booting the SLC. The default is 3 seconds and the range is between 3 and 1800 seconds.

admin firmware watchdog**Syntax**

```
admin firmware watchdog <disable|180-1800 seconds>
```

Description

Configures how long the SLC waits for boot completion before forcing a reboot.

admin firmware show**Syntax**

```
admin firmware show [viewlog <enable|disable>]
```

Description

Lists the current firmware revision, the boot bank status, and optionally displays the log containing details about firmware updates.

admin firmware update**Syntax**

```
admin firmware update <ftp|tftp|sftp|nfs|usb|sdcard> file <Firmware File> key <Checksum Key> [nfsdir <NFS Mounted Dir>] [usbport <U1|U2>]
```

Description

Updates SLC firmware to a new revision.

You should be able to access the firmware file using the settings `admin ftp show` displays if FTP, TFTP or SFTP are used to load the firmware file. The SLC 8000 advanced console manager automatically reboots after successful update.

admin firmware clearlog**Syntax**

```
admin firmware clearlog
```

Description

Clears the firmware update log.

admin ftp password**Syntax**

```
admin ftp password
```

Description

Sets the FTP server password and prevent it from being echoed.

admin ftp server**Syntax**

```
admin ftp server <IP Address or Hostname> [login <User Login>] [path <Directory>]
```

Description

Sets the FTP/TFTP/SFTP server used for firmware updates and configuration save/restore.

admin ftp show

Syntax

```
admin ftp show
```

Description

Displays FTP settings.

admin keypad

Syntax

```
admin keypad <lock|unlock>
```

Description

Locks or unlocks the LCD keypad.

If the keypad is locked, you can scroll through settings but not change them.

admin keypad password

Syntax

```
admin keypad password
```

Must be 6 digits.

Description

Changes the Restore Factory Defaults password used at the LCD to return the SLC advanced console server to the factory settings.

admin keypad show

Syntax

```
admin keypad show
```

Description

Displays keypad settings.

admin lcd reset

Syntax

```
admin lcd reset
```

Description

Restarts the program that controls the LCD.

```
admin lcd default
```

Syntax

```
admin lcd default
```

Description

Restores the LCD screens to their factory default settings.

```
admin lcd screens
```

Syntax

```
admin lcd screens  
<zero or more parameters>
```

Parameters

```
currtime <1-9>  
network <1-9>  
console <1-9>  
datetime <1-9>  
release <1-9>  
devports <1-9>  
location <1-9>  
temp <1-9>  
userstrings <1-9>
```

Description

Sets which screens will be displayed on the LCD, and their order.

```
admin lcd line1
```

Syntax

```
admin lcd line1  
<1-24 Chars> line2 <1-24 Chars>
```

Description

Sets the strings displayed on the LCD user string screen.

```
admin lcd scrolling
```

Syntax

```
admin lcd scrolling <enable|disable>
```

```
[scrollldelay <Delay in Seconds>] [idledelay <Delay in Seconds>]
```

Description

Configures auto-scroll of the LCD screens, including the number of seconds after keypad input before auto-scrolling restarts.

admin memory show**Syntax**

```
admin memory show
```

Description

Displays information about SLC memory usage.

admin memory swap add**Syntax**

```
admin memory swap add <Size of Swap in MB> usbport <U1|U2>
```

Description

Creates a swap space from an external storage device.

admin memory swap delete**Syntax**

```
admin memory swap delete
```

Description

Deletes the swap space from an external storage device.

admin quicksetup**Syntax**

```
admin quicksetup
```

Description

Runs the quick setup script.

admin reboot**Syntax**

```
admin reboot
```

Description

Immediately terminates all connections and reboots the SLC 8000 advanced console manager. The front panel LCD displays the “Rebooting the SLC” message, and the normal boot sequence occurs.

admin shutdown**Syntax**

```
admin shutdown
```

Description

Prepares the SLC 8000 advanced console manager to be powered off.

When you use this command to shut down the SLC console manager, the LCD front panel displays the “Shutting down the SLC” message, followed by a pause, and then “Shutdown complete.” When “Shutdown complete” displays, it is safe to power off the SLC 8000 advanced console manager.

admin site**Syntax**

```
admin site row <Data Center Rack Row Number>
admin site cluster <Data Center Rack Group Number>
admin site rack <Data Center Rack Number>
```

Description

Configures information about the site where the SLC 8000 advanced console manager is located.

admin version**Syntax**

```
admin version
```

Description

Displays current hardware and firmware information.

admin web certificate import**Syntax**

```
admin web certificate import via <sftp|scp> certfile <Certificate File>
privfile <Private Key File> host <IP Address or Name>
login <User Login> [path <Path to Files>]
```

Description

Imports an SSL certificate.

```
admin web certificate reset
```

Syntax

```
admin web certificate reset
```

Description

Resets the web server to the default SSL certificate.

```
admin web certificate custom
```

Syntax

```
admin web certificate custom
```

Description

Generates a custom self-signed SSL certificate. The SHA256 hashing algorithm will be used to generate the certificate.

```
admin web certificate show
```

Syntax

```
admin web certificate show
```

Description

Displays the web server SSL certificate.

```
admin web gadget
```

Syntax

```
admin web gadget <enable|disable>
```

Description

Enables or disables iGoogle Gadget web content.

```
admin web group
```

Syntax

```
admin web group <Local or Remote Group Name>
```

Description

Configures the group that can access the web.

admin web server**Syntax**

```
admin web server <enable|disable>
```

Description

Enables or disables running the web server (TCP ports 80 and 443).

```
admin web server <enable|disable>
```

admin web timeout**Syntax**

```
admin web timeout <disable|5-120>
```

Description

Configures the timeout for web sessions.

admin web terminate**Syntax**

```
admin web terminate <Session ID>
```

Description

Terminates a web session.

admin web show**Syntax**

```
admin web show [viewcipherlist <enable|disable>]
```

Description

Displays the current sessions, with optional extra sessions or current ciphers.

admin web banner**Syntax**

```
admin web banner
```

Description

Configures the banner displayed on the web home page.

```
admin web iface
```

Syntax

```
admin web iface <none,eth1,eth2,ppp>
```

Description

Defines a list of network interfaces the web is available on.

```
admin web cipher
```

Syntax

```
admin web cipher <high|himed|fips>
```

Description

Configures the strength of the cipher used by the web server (high is 256, 168 and some 128 bit, medium is 128 bit)

```
admin web tlsv10
```

Syntax

```
admin web tlsv10 <enable|disable>
```

Description

Enables or disables TLS v1.0.

```
admin web tlsv11
```

Syntax

```
admin web tlsv11 <enable|disable>
```

Description

Enables or disables TLS v1.1.

```
admin web restart
```

Syntax

```
admin web restart
```

Description

Restarts the web server.

Warning: *The following admin chip commands should only be used under the direction of Lantronix Technical Support.*

```
admin chip resetmodem
```

Description

Resets the internal modem chip in key system chips.

Syntax

```
admin chip resetmodem
admin chip reseti2cmux
```

Description

Resets the I2C Mux chip in key system chips.

Syntax

```
admin chip reseti2cmux
admin chip resetsfp ethport <1|2>
```

Description

Resets the SFP chip in key system chips.

Syntax

```
admin chip resetsfp ethport <1|2>
```

Audit Log Commands

```
show auditlog
```

Syntax

```
show auditlog [command|user|clear]
```

Description

Displays audit log. By default, shows the audit log sorted by date/time. You can sort it by user or command, or clear the audit log.

Authentication Commands

set auth

Syntax

```
set auth <one or more parameters>
```

Parameters

```
authusenextmethod <enable|disable>  
kerberos <1-6>  
ldap <1-6>  
localusers <1-6>  
nis <1-6>  
radius <1-6>  
tacacs+ <1-6>
```

Description

Sets ordering of authentication methods.

Local Users authentication is always the first method used. Any methods omitted from the command are disabled.

show auth

Syntax

```
show auth
```

Description

Displays authentication methods and their order of precedence.

show user

Syntax

```
show user
```

Description

Displays attributes of the currently logged in user.

Kerberos Commands

set kerberos

Syntax

```
set kerberos <one or more parameters>
```

Parameters

```
allowdialback <enable|disable>
clearports <Port List>
custommenu <Menu Name>
dataports <Port List>
dialbacknumber <Phone Number>
breakseq <1-10 Chars>
escapeseq <1-10 Chars>
group <default|power|admin>
ipaddr <Key Distribution Center IP Address>
kdc <Key Distribution Center>
listenports <Port List>
permissions <Permission List>
```

Note: See [User Permissions Commands \(on page 334\)](#) for information on groups and user rights.

```
port <Key Distribution Center TCP Port>
realm <Kerberos Realm>
state <enable|disable>
usedapforlookup <enable|disable>
```

Description

Configures the SLC 8000 advanced console manager to use Kerberos to authenticate users who log in via the Web, SSH, Telnet, or the console port.

show kerberos

Syntax

```
show kerberos
```

Description

Displays Kerberos settings.

LDAP Commands

set ldap

Syntax

```
set ldap <one or more parameters>
```

Parameters

```
state <enable|disable>
server1 <IP Address or Name>
server2 <IP Address or Name>
port <TCP Port>
base <LDAP Base>
bindname <Bind Name>
bindwithlogin <enable|disable>
useldapschema <enable|disable>
adssupport <enable|disable>
filteruser <User Login Attribute>
filtergroup <Group Objectclass>
grmemberattr <Group Membership Attribute>
grmembervalue <dn|name>
encrypt <starttls|ssl|disable>
dataports <Port List>
listenports <Port List>
clearports <Port List>
escapeseq <1-10 Chars>
breakseq <1-10 Chars>
custommenu <Menu Name>
allowdialback <enable|disable>
dialbacknumber <Phone Number>
group <default|power|admin>
permissions <Permission List>
```

Note: See [User Permissions Commands \(on page 334\)](#) for information on groups and user rights.

Description

Configures the SLC 8000 advanced console manager to use LDAP to authenticate users who log in via the Web, SSH, Telnet, or the console port.

set ldap bindpassword

Description

Set the LDAP bind password.

Syntax

```
set ldap bindpassword
```

set ldap certificate import**Description**

To upload X.509/PEM certificate for Start TLS encrypted connections:

Syntax

```
set ldap certificate import via <sftp|scp> rootfile <Cert Auth File>
    certfile <Certificate File> keyfile <Key File>
    host <IP Address or Name> login <User Login> [path <Path to Files>]
```

set ldap certificate delete**Description**

To delete an LDAP certificate.

Syntax

```
set ldap certificate delete
```

show ldap**Syntax**

```
show ldap
```

Description

Displays LDAP settings.

Local Users Commands

set localusers add|edit**Syntax**

```
set localusers add|edit <User Login> <one or more parameters>
```

Parameters

```
allowdialback <enable|disable>
breakseq <1-10 Chars>
changenextlogin <enable|disable>
changepassword <enable|disable>
clearports <Port List>
dataports <Port List>
dialbacknumber <Phone Number>
displaymenu <enable|disable>
escapeseq <1-10 Chars>
```

```
listenports <Port List>  
custommenu <Menu Name>  
uid <User Identifier>  
group <default|power|admin|Custom Group Name>  
passwordexpires <enable|disable>  
permissions <Permission List>
```

Note: See [User Permissions Commands \(on page 334\)](#) for information on groups and user rights. Remove Escape & Break Sequences for users making raw binary connections to Device Ports.

Description

Configures local accounts (including sysadmin) who log in to the SLC 8000 advanced console manager by means of the Web, SSH, Telnet, or the console port.

set localusers allowreuse

Syntax

```
set localusers allowreuse <enable|disable>
```

Description

Sets whether a login password can be reused.

set local users complexpasswords

Syntax

```
set localusers complexpasswords <enable|disable>
```

Description

Sets whether a complex login password is required. Complex passwords require at least one uppercase character, one lowercase character, one digit, and one non-alphanumeric character.

set localusers state

Syntax

```
set localusers state <enable|disable>
```

Description

Enables or disables authentication of local users.

set localusers delete

Syntax

```
set localusers delete <User Login>
```

Description

Deletes a local user.

set localusers lifetime**Syntax**

```
set localusers lifetime <Number of Days>
```

Description

Sets the number of days the login password may be used. The default is 90 days.

set localusers maxloginattempts**Syntax**

```
set localusers maxloginattempts <Number of Logins>
```

Description

Sets the maximum number of login attempts before the account is locked. Disabled by default.

set localusers password**Syntax**

```
set localusers password <User Login>
```

Description

Sets a login password for the local user.

set localusers periodlockout**Syntax**

```
set localusers periodlockout <Number of Minutes>
```

Description

Sets the number of minutes after a lockout before the user can try to log in again. Disabled by default.

set localusers periodwarning**Syntax**

```
set localusers periodwarning <Number of Days>
```

Description

Sets the number of days the system warns the user that the password will be expiring. The default is 7 days.

set localusers reusehistory**Syntax**

```
set localusers reusehistory <Number of Passwords>
```

Description

Sets the number of passwords the user must use before reusing an old password. The default is 4.

set localusers multipleadminlogins**Syntax**

```
set localusers multipleadminlogins <enable|disable>
```

Description

Allows multiple admin logins among local users to the web server.

set localusers consoleonlyadmin**Syntax**

```
set localusers consoleonlyadmin <enable|disable>
```

Description

Sets local users. to console only admin setting. If enabled, the admin user can only log into the SLC via the console, and will be prevented from logging in via the web, SSH or Telnet.

show localusers**Syntax**

```
show localusers [display <brief|extended>] [user <User Login>]
```

Description

Displays local users.

set localusers lock**Syntax**

```
set localusers lock <User Login>
```

Description

Blocks (locks) a user's ability to login.

set localusers unlock**Syntax**

```
set localusers unlock <User Login>
```

Description

Allows (unlocks) a user's ability to login.

set localusers permissions**Syntax**

```
set localusers add|edit <user> permissions <Permission List>
```

where

<Permission List> is one or more of nt, sv, dt, lu, ra, sk, um, dp, do, ub, rp, rs, rc, dr, wb, sn, ad, md, sd

To remove a permission, type a minus sign before the two-letter abbreviation for a user permission.

Description

Sets a local user's permissions (not defined by the user group).

NIS Commands

set nis**Syntax**

```
set nis <one or more parameters>
```

Parameters

```
allowdialback <enable|disable>
```

```
broadcast <enable|disable>
```

```
clearports <Port List>
```

```
custommenu <Menu Name>
```

```
dialbacknumber <Phone Number>
dataports <Port List>
domain <NIS Domain Name>
breakseq <1-10 Chars>
escapeseq <1-10 Chars>
group <default|power|admin>
listenports <Port List>
master <IP Address or Hostname>
permissions <Permission List>
```

Note: See *User Permissions Commands* on page 334 for information on groups and user rights.

```
slave1 <IP Address or Hostname>
slave2 <IP Address or Hostname>
slave3 <IP Address or Hostname>
slave4 <IP Address or Hostname>
slave5 <IP Address or Hostname>
state <enable|disable>
```

Description

Configures the SLC 8000 advanced console manager to use NIS to authenticate users who log in via the Web, SSH, Telnet, or the console port.

show nis

Syntax

```
show nis
```

Description

Displays NIS settings.

RADIUS Commands

set radius

Syntax

```
set radius <one or more parameters>
```

Parameters

```
state <enable|disable>
allowdialback <enable|disable>
clearports <Port List>
custommenu <Menu Name>
dataports <Port List>
dialbacknumber <Phone Number>
```

```
breakseq <1-10 Chars>
escapeseq <1-10 Chars>
group <default|power|admin>
listenports <Port List>
permissions <Permission List>
```

Note: See *User Permissions Commands* on page 334 for information on groups and user rights.

```
timeout <enable|1-30>
```

Note: Sets the number of seconds after which the connection attempt times out. It may be 1-30 seconds.

Description

Configures the SLC 8000 advanced console manager to use RADIUS to authenticate users who log in via the Web, SSH, Telnet, or the console port.

set radius server

Syntax

```
set radius server <1|2> host <IP Address or Hostname> secret <Secret>
[port <TCP Port>]
```

Description

Identifies the RADIUS server(s), the text secret, and the number of the TCP port on the RADIUS server.

Note: The default port is 1812.

show radius

Syntax

```
show radius
```

Description

Displays RADIUS settings.

TACACS+ Commands

set tacacs+

Syntax

```
set tacacs+ <one or more parameters>
```

Parameters

```

state <enable|disable>
server1 <IP Address or Name>
server2 <IP Address or Name>
server3 <IP Address or Name>
secret <TACACS+ Secret>
encrypt <enable|disable>
authservice <login|pap|chap>
timeout <1-10 seconds>
dataports <Port List>
listenports <Port List>
clearports <Port List>
escapeseq <1-10 Chars>
breakseq <1-10 Chars>
custommenu <Menu Name>
allowdialback <enable|disable>
dialbacknumber <Phone Number>
group <default|power|admin>
permissions <Permission List>

```

Note: See [User Permissions Commands \(on page 334\)](#) for information on groups and user rights.

Description

Configures the SLC 8000 advanced console manager to use TACACS+ to authenticate users who log in via the Web, SSH, Telnet, or the console port.

show tacacs+

Syntax

```
show tacacs+
```

Description

Displays TACACS+ settings.

User Permissions Commands

set localusers group

Syntax

```
set localusers add|edit <user> group <default|power|admin|custom group name>
```

Description

Adds a local user to a user group or changes the group the user belongs to.

set localusers lock**Syntax**

```
set localusers lock <User Login>
```

Description

Blocks (locks) a user's ability to login.

set localusers unlock**Syntax**

```
set local users unlock <User Login>
```

Description

Allows (unlocks) a user's ability to login.

set localusers permissions**Syntax**

```
set localusers add|edit <user> permissions <Permission List>
```

where

<Permission List> is one or more of nt, sv, dt, lu, ra, sk, um, dp, do, ub, rp, rs, rc, dr, wb, sn, ad, md, sd

To remove a permission, type a minus sign before the two-letter abbreviation for a user permission.

Description

Sets a local user's permissions (not defined by the user group).

set <nis|ldap|radius|kerberos|tacacs+> permissions**Syntax**

```
set <nis|ldap|radius|kerberos|tacacs> permissions <Permission List>
```

where

<Permission List> is one or more of nt, sv, dt, lu, ra, sk, um, dp, do, ub, rp, rs, rc, dr, wb, sn, ad, md, sd

Description

Sets permissions not already defined by the assigned permissions group.

show user**Syntax**

```
show user
```

Description

Displays the rights of the currently logged-in user.

Remote User Commands**set remoteusers add|edit****Syntax**

```
set remoteusers add|edit <User Login> [<parameters>]
```

Parameters

```
dataports <Port List>
breakseq <1-10 Chars>
escapeseq <1-10 Chars>
listenports <Port List>
clearports <Port List>
custommenu <Menu Name>
displaymenu <enable|disable>
allowdialback <enable|disable>
dialbacknumber <Phone Number>
group <default|power|admin|Custom Group Name>
permissions <Permissions List>
```

where

<Permission List> is one or more of nt, sv, dt, lu, ra, sk, um, dp, do, ub, rp, rs, rc, dr, wb, sn, ad, md, sd

To remove a permission, type a minus sign before the two-letter abbreviation for a user right.

Description

Sets attributes for users who log in by a remote authentication method.

set remoteusers listonlyauth**Syntax**

```
set remoteusers listonlyauth <enable|disable>
```

Description

Sets whether remote users who are not part of the remote user list will be authenticated.

set remoteusers lock|unlock**Syntax**

```
set remoteusers lock|unlock <User Login>
```

Description

Allow (unlock) or block (lock) a user's ability to login.

set remoteusers delete**Syntax**

```
set remoteusers delete <User Login>
```

Description

Removes a remote user.

show remoteusers**Syntax**

```
show remoteusers
```

Description

Displays settings for all remote users

set <nis|ldap|radius|kerberos|tacacs+> group**Syntax**

```
set <nis|ldap|radius|kerberos|tacacs> group <default|power|admin>
```

Description

Sets a permission group for remotely authorized users.

CLI Commands

set cli**Syntax**

```
set cli scscommands <enable|disable>
```

Parameters

```
set cli scscommands <enable|disable>
set cli terminallines <disable|Number of Lines>
set cli menu <start|Menu Name>
show cli
```

Description

Allows you to use SCS-compatible commands as shortcuts for executing commands. It is disabled by default.

Note: Settings are retained between CLI sessions for local users and users listed in the remote users list.

set cli menu

Description

If a menu is associated with the current user and the menu was not displayed at login, 'start' will run the menu. Users with full administrative or menu user rights can also specify the name of any menu to run.

Syntax

```
set cli menu <start|Menu Name>
set cli terminallines
set cli terminallines <disable|Number of lines>
```

Description

Sets the number of lines in the terminal emulation (screen) for paging through text one screenful at a time, if the SLC 8000 advanced console manager cannot detect the size of the terminal automatically.

Note: Settings are retained between CLI sessions for local users and users listed in the remote users list.

show cli

Syntax

```
show cli
```

Description

Displays current CLI settings.

show user

Syntax

```
show user
```

Description

Displays attributes of the currently logged in user.

set history**Syntax**

```
set history clear
```

Description

Clears the commands that have been entered during the command line interface session.

show history**Syntax**

```
show history
```

Description

Displays the last 100 commands entered during the session.

Connection Commands

connect bidirection**Syntax**

```
connect bidirection <Port # or Name> <endpoint> <one or more Parameters>
```

Parameters

Endpoint is one of:

```
charcount <# of Chars>
```

```
charseq <Char Sequence>
```

```
charxfer <toendpoint|fromendpoint>
```

```
date <MMDDYYhhmm[ss]>
```

```
deviceport <Device Port # or Name>
```

```
exclusive <enable|disable>
```

```
ssh <IP Address or Name> [port <TCP Port>][<SSH flags>]
```

where <SSH flags> is one or more of:

```
user <Login Name>
```

```
version <1|2>
```

```
command <Command to Execute>
```

```
tcp <IP Address> [port <TCP Port>]
```

```
telnet <IP Address or Name> [port <TCP Port>]
```

```
trigger <now|datetime|chars>
```

If the trigger is `datetime` (establish connection at a specified date/time), enter the `date` parameter. If the trigger is `chars` (establish connection on receipt of a specified number or characters or a character sequence), enter the `charxfer` parameter and either the `charcount` or the `charseq` parameter.

```
udp <IP Address> [port <UDP Port>]
```

Description

Connects a device port to another device port or an outbound network connection (data flows in both directions).

connect direct

Syntax

```
connect direct <endpoint>
```

Parameters

Endpoint is one of:

```
deviceport <Device Port # or Name>
```

```
ssh <IP Address or Name> [port <TCP Port>][<SSH flags>]
```

where <SSH flags> is one or more of:

```
user <Login Name>
```

```
version <1|2>
```

```
command <Command to Execute>
```

```
tcp <IP Address> [port <TCP Port>]
```

```
telnet <IP Address or Name> [port <TCP Port>]
```

```
udp <IP Address> [port <UDP Port>]
```

Description

Connects to a device port to monitor and/or interact with it, or establishes an outbound network connection.

connect global outgoingtimeout

Syntax

```
connect global outgoingtimeout <disable|1-9999 seconds>
```

Description

Sets the amount of time the SLC 8000 advanced console manager will wait for a response (sign of life) from an SSH/Telnet server that it is trying to connect to.

Note: *This is not a TCP timeout.*

connect listen deviceport**Syntax**

```
connect listen deviceport <Device Port # or Name>
```

Description

Monitors a device port.

connect terminate**Syntax**

```
connect terminate <Connection ID>
```

Description

Terminates a connection.

connect unidirection**Syntax**

```
connect unidirection <Device Port # or Name> dataflow
<toendpoint|fromendpoint> <endpoint>
```

Parameters

Endpoint is one of:

```
charcount <# of Chars>
charseq <Char Sequence>
datetime <MMDDYYhhmm[ss]>
deviceport <Port # or Name>
exclusive <enable|disable>
ssh <IP Address or Name> [port <TCP Port>][<SSH flags>]
```

where <SSH flags> is one or more of:

```
user <Login Name>
version <1|2>
command <Command to Execute>
```

```
tcp <IP Address> [port <TCP Port>]
telnet <IP Address or Name> [port <TCP Port>]
trigger <now|datetime|chars>
```

If the trigger is `datetime` (establish connection at a specified date/time), enter the date parameter. If the trigger is `chars` (establish connection on receipt of a specified number or characters or a character sequence), enter either the `charcount` or the `charseq` parameter.

```
udp <IP Address> [port <UDP Port>]
```

Description

Connects a device port to another device port or an outbound network connection (data flows in one direction).

show connections**Syntax**

```
show connections [email <Email Address>]
```

Description

Displays connections and their IDs. You can optionally email the displayed information.

The connection IDs are in the left column of the resulting table. The connection ID associated with a particular connection may change if the connection times out and is restarted.

show connections connid**Syntax**

```
show connections connid <Connection ID> [email <Email Address>]
```

Description

Displays details for a single connection. You can optionally email the displayed information.

Console Port Commands

set consoleport**Syntax**

```
set consoleport <one or more parameters>
```

Parameters

```
baud <300-230400>  
databits <7|8>  
flowcontrol <none|xon/xoff|rts/cts>  
group <Local or Remote Group Name>  
parity <none|odd|even>  
showlines <disable|1-50 lines>  
stopbits <1|2>  
timeout <disable|1-30>
```

Description

Configures console port settings.

show consoleport**Syntax**

```
show consoleport
```

Description

Displays console port settings.

Custom User Menu Commands

When creating a custom user menu, note the following limitations:

- ◆ Maximum of 20 custom user menus.
- ◆ Maximum of 50 commands per custom user menu (`logout` is always the last command).
- ◆ Maximum of 15 characters for menu names.
- ◆ Maximum of five nested menus can be called.
- ◆ No syntax checking. (Enter each command correctly.)

set localusers**Syntax**

```
set localusers add|edit <User Login> custom menu <Menu Name>
```

Description

Assigns a custom user menu to a local user.

set menu add**Syntax**

```
set menu add <Menu Name> [command <Command Number>]
```

Description

Creates a new custom user menu or adds a command to an existing custom user menu.

```
set menu edit
```

Syntax

```
set menu edit <Menu Name> <parameter>
```

Parameters

```
command <Command Number>  
nickname <Command Number>  
redisplaymenu <enable|disable>
```

```
shownicknames <enable|disable>
title <Menu Title>
```

Description

Changes a command within an existing custom user menu. Changes a nickname within an existing custom user menu. Enables or disables the redisplay of the menu before each prompt. Enables or disables the display of command nicknames instead of commands. Sets the optional title for a menu.

set menu delete**Syntax**

```
set menu delete <Menu Name> [command <Command Number>]
```

Description

Deletes a custom user menu or one command within a custom user menu.

set <nis|ldap|radius|kerberos|tacacs+> custommenu**Syntax**

```
set <nis|ldap|radius|kerberos|tacacs+> custommenu <Menu Name>
```

Description

Assigns a custom menu to users who authenticate via NIS, LDAP, Radius, Kerberos, or TACACS+.

set remoteusers add|edit**Syntax**

```
set remoteusers add|edit <User Login> custommenu <Menu Name>
```

Description

Sets a default custom menu for remotely authorized users.

show menu**Syntax**

```
show menu <all|Menu Name>
```

Description

Displays a list of all menu names or all commands for a specific menu.

Date and Time Commands

set datetime

Syntax

```
set datetime <one parameter>
```

Parameters

```
date <MMDDYYhhmm[ss]>
timezone <Time Zone>
```

Note: If you do not know a valid <Time Zone>, enter 'timezone <invalid time zone>' and you will be guided through selecting one from the available time zones.

Description

Sets the local date, time, and local time zone (one parameter at a time).

show datetime

Syntax

```
show datetime
```

Description

Displays the local date, time, and time zone.

set ntp

Syntax

```
set ntp <one or more ntp parameters>
```

Parameters

```
localserver1 <IP Address or Hostname>
localserver2 <IP Address or Hostname>
localserver3 <IP Address or Hostname>
poll <local|public>
publicserver <IP Address or Hostname>
state <enable|disable>
sync <broadcast|poll>
```

Description

Synchronizes the SLC 8000 advanced console manager with a remote time server using NTP.

show ntp**Syntax**

```
show ntp
```

Description

Displays NTP settings.

Device Commands

set command**Syntax**

```
set command <Device Port # or Name or List> <one or more parameters>
```

Parameters

```
sensorsoft lowtemp <Low Temperature>
```

Sets the lowest temperature permitted for the port.

```
sensorsoft hightemp <High Temperature>
```

Sets the highest temperature permitted for the port.

```
sensorsoft lowhumidity <Low Humidity %>
```

Sets the lowest humidity permitted for the port.

```
sensorsoft highhumidity <High Humidity %>
```

Sets the lowest humidity permitted for the port.

```
sensorsoft degrees <celsius|fahrenheit>
```

Enables or disables temperature settings as celcius or fahrenheit.

```
sensorsoft traps <enable|disable>
```

Enables or disables traps when specified conditions are met.

```
sensorsoft status
```

Displays the status of the port.

```
sensorsoft showall
```

Displays the status for all connected Sensorsoft devices and ignores the device port\list.

Note: The Sensorsoft lowtemp and hightemp settings are given in the scale specified by the degrees setting.

Description

Sends commands to (or control) a device connected to an SLC device port over the serial port.

Note: Currently the only devices supported for this type of interaction are Sensorsoft devices.

Device Port Commands

set deviceport port

Description

Sets the dialout password.

Syntax

```
set deviceport port <Device Port # or List or Name> <one or more device
port parameters>
```

Example: set deviceport port 2-5,6,12,15-16 baud 2400

Parameters

```
actiondelay <Action Delay>
actionrestart <Restart Delay>
assertdtr <enable|disable>
auth <pap|chap>
banner <Banner Text>
baud <300-230400>
breakseq <1-10 Chars>
bytethreshold <# of Characters>
calleridcmd <Modem Command String>
calleridlogging <enable| disable>
cbcptype <admin|user>
cbcpnocallback <enable|disable>
chapauth <chaphost|localusers>
chaphost <CHAP Host or User Name>
checkdsr <enable|disable>
closedsr <enable|disable>
connectedmsg <enable|disable>
databits <7|8>
device <none|sensorsoft|rpm> dialbackdelay <PPP Dial-back Delay>
dialbacknumber <username|Phone Number>
dialbackretries <1-10>
dialinlist <Host List for Dial-in>
dialoutlogin <Remote User Login>
dialoutnumber <Phone Number>
dodauth <pap|chap>
dodchaphost <CHAP Host or User Name>
emailsubj <Email Subject>
emailto <Email Address>
flowcontrol <none|xon/xoff|rts/cts>
group <Local or Remote Group Name>
idletimeoutmsg <enable|disable>
initscript <Modem Initialization Script>
```

```

ipaddr <IP Address[/Mask Bits]>
locallogging <enable|disable>
maxdirect <1-15>

```

Note: We recommend preceding the *initscript* with **AT** and include **E1 V1 x4 Q0** so that the SLC 8000 advanced console manager may properly control the modem.

```

localipaddr <negotiate|IP Address>
logins <enable|disable>
minimizelatency <enable|disable>
modemmode <text|ppp>
modemstate <disable|dialin|dialout|dialback|dialinhostlist|dialondemand|
    dialin+ondemand|dialback+ondemand|cbcpclient|cbcpserver>
modemtimeout <disable|1-9999 seconds>
name <Device Port Name>
nat <enable|disable>
nfsdir <Logging Directory>
nfslogging <enable|disable>
nfsmaxfiles <Max # of Files>
nfsmaxsize <Size in Bytes>
numsessionsmsg <enable|disable>
parity <none|odd|even>
portlogseq <1-10 Chars>
poweraction <on|off|cycle>
powermgmtseq <1-10 Chars>
powersupply <Managed Power Supply Name>
remoteipaddr <negotiate|IP Address>
restartdelay <PPP Restart Delay>
reversepinout<enable|disable>
sendstring <String to Send|QUOTEDSTRING>
sendtermstr <enable|disable>
showlines <disable|1-50 lines>
slmlogging <enable|disable>
slmnms <NMS IP Address>
slmthreshold <Threshold>
slmtime <Time Frame>
sshauth <enable|disable>
sshdattadir <netin|netout|both>
sshin <enable|disable>
sshport <TCP Port>
sstimeout <disable|1-1800 seconds>
stopbits <1|2>
sysloglogging <enable|disable>
tcpauth <enable|disable>
tcpdatadir <netin|netout|both>
tcpin <enable|disable>
tcpport <TCP Port>
tcptimeout <disable|1-1800>
telnetauth <enable|disable>
telnetdatadir <netin|netout|both>
telnetin <enable|disable>
telnetport <TCP Port>
telnetsoftiac <enable|disable>
telnettimeout <disable|1-1800 sec>

```

```

termstr <Termination String>
timeoutlogins <disable or 1-30 minutes>
toggledtr <enable|disable>
tokenaction <List of none,log,trap,email,string,power>
tokendatadetect <enable|disable>
tokenstring <Regex String>
tokentrigger <bytecnt|charstr>
usblogging <enable|disable>
usbmaxfiles <Max # of Files>
usbmaxsize <Size in Bytes>
usbport <U1|U2|SD>
usbvbus <enable|disable>
usesites <enable|disable>
viewportlog <enable|disable>

```

Description

Configures a single port or a group of ports.

Set the modem password and CHAP secrets (any extra parameters will be ignored):

```

set deviceport port <Device Port # or List or Name> dialoutpassword
set deviceport port <Device Port # or List or Name> chapsecret
set deviceport port <Device Port # or List or Name> dodchapsecret

```

Reset a device port, terminating and restarting all relevant connections:

```

set deviceport port <Device Port # or List or Name> reset

```

Configure up to 4 managed power supplies for device connected to a device port:

```

set deviceport port <Device Port # or Name> managepower

```

Reset a device port, terminating and restarting all relevant connections:

```

set deviceport port <Device Port # or List or Name> reset

```

Note: A group of device ports can be configured by specifying a comma-separated list of ports (i.e., '1-4,8,10-12') or 'ALL'. Remove breakseq for Device Ports connected to raw binary connections. The logging level for the Device Ports log must be set to 'Info' to view Syslog entries for Device Port logging. It is recommended that the 'initscript' be prepended with 'AT' and include 'E1 V1 x4 Q0' so that the SLC may properly control the modem.

set deviceport global

Syntax

```

set deviceport global <one or more parameters>

```

Parameters

```

sshport <TCP Port>
telnetport <TCP Port>
tcpport <TCP Port>

```

Description

Configures settings for all or a group of device ports.

```
show deviceport global
```

Syntax

```
show deviceport global
```

Description

Displays global settings for device ports.

```
show deviceport names
```

Syntax

```
show deviceport names
```

Description

Displays a list of all device port names.

```
show deviceport port
```

Syntax

```
show deviceport port <Device Port List or Name>  
    [display <ip|data|modem|logging|device>]
```

Description

Displays the settings for one or more device ports.

```
show deviceport types
```

Syntax

```
show deviceport types
```

Description

Displays the list of port types (RJ45 or USB) for all device ports.

```
show portcounters
```

Syntax

```
show portcounters [deviceport <Device Port List or Name>] [email <Email  
Address>]
```

Description

Displays device port statistics and errors for one or more ports. You can optionally email the displayed information.

```
show portcounters zerocounters
```

Syntax

```
show portcounters zerocounters <Device Port List or Name>
```

Description

Zeros the port counters for one or more device ports.

```
show portstatus
```

Syntax

```
show portstatus [deviceport <Device Port List or Name>] [email <Email Address>]
```

Description

Displays the modes and states of one or more device port(s). You can optionally email the displayed information.

Diagnostic Commands

```
diag arp
```

Syntax

```
diag arp|arp6 [email <Email Address>]
```

Description

Displays the Address Resolution Protocol table (for IPv4) or the Neighbor table (for IPv6) for mapping IP Addresses to hardware addresses.

```
diag internals
```

Syntax

```
diag internals [email <Email Address>]
```

Enable debug printing on the next SLC reboot:

```
diag internals [printapplication <enable|disable>  
  printconnection <enable|disable>  
  printmanagement <enable|disable>
```

Description

Displays information on the internal memory, storage and processes of the SLC 8000 advanced console manager. You can optionally email the displayed information.

diag lookup**Syntax**

```
diag lookup <Name> [email <Email Address>]
```

Description

Resolves a host name into an IP address. You can optionally email the displayed information.

diag loopback**Syntax**

```
diag loopback <Device Port Number or Name>[<parameters>]
```

Parameters

```
test <internal|external>
xferdatasize <Size In Kbytes to Transfer>
Defaults: test=external, xferdatasize=1K
```

Description

Tests a device port by transmitting data out the port and verifying that it is received correctly.

A special loopback cable comes with the SLC 8000 advanced console manager. To test a device port, plug the cable into the device port and run this command. The command sends the specified Kbytes to the device port and reports success or failure. The test is performed at 9600 baud. Only an external test requires a loopback cable. The External test is currently not supported for USB device ports.

diag netstat**Syntax**

```
diag netstat [protocol <all|tcp|udp>] [email <Email Address>]
Defaults: protocol=all
```

Description

To display a report of network connections. You can optionally email the displayed information.

diag nettrace**Syntax**

```
diag nettrace <one or more parameters>
```

Parameters

```
ethport <1|2>
protocol <tcp|udp|icmp|esp>
host <IP Address or Name>
numpackets <Number of Packets>
verbose <low|medium|high|disable>
```

Description

Displays all network traffic, applying optional filters. This command is available in the CLI but not the web.

diag perfstat**Description**

Display performance statistics for an Ethernet Port or Device Port, averaged over the last 5 seconds. Must specify an Ethernet Port or Device Port.

Syntax

```
diag perfstat [ethport <1|2>] [deviceport <Device Port # or Name>]
```

diag ping|ping6**Description**

Verifies if the SLC can reach a host over the network.

```
diag ping|ping6 <IP Address or Name> [<parameters>]
```

Parameters

```
count <Number Of Times To Ping>
packetsize <Size In Bytes>
ethport <1|2>
Defaults: count=5, packetsize=64
```

diag sendpacket host**Description**

Generate and send Ethernet packets.

Syntax

```
diag sendpacket host <IP Address or Name> port <TCP or UDP Port Number>
    [string <Packet String>] [protocol <tcp|udp>]
    [count <Number of Packets>]
```

diag top**Syntax**

```
diag top [parameters]
```

Description

Displays CPU usage, memory usage and tasks.

Parameters

```
continuous <enable|disable>  
count <Number of Iterations to Display>  
delay <Delay in Seconds>  
numlines <Number of Lines to Display>
```

Defaults:

```
count=1, delay = 5 seconds
```

diag traceroute**Syntax**

```
diag traceroute <IP Address or Hostname>
```

Description

Displays the route that packets take to get to a network host.

diag usb**Syntax**

```
diag usb [<parameters>]
```

Description

To display information about USB buses and the devices connected to them, including the mapping between a USB device and the SLC port. For "mapdevice enable", the port numbers will be displayed at the end of the line in square brackets.

Parameters

```
treedisplay <enable|disable>  
mapdevice <enable|disable>  
email <Email Address>  
Defaults: treedisplay=enable
```

Events Commands

admin events add

Syntax

```
admin events add <trigger> <response>
```

<trigger> is one of:

```
dpdatadrop, humidlimit, pingfails, receivetrp, rpmload,
nomodemdialor templimit.
```

<response> is one of:

```
action syslog
action emailalert emailaddress <destination email address>
action snmptrap nms <SNMP NMS> community <SNMP Community>
action <fwdalltrapseth|fwdseltrapeth> ethport <1|2> nms <SNMP NMS>
    community <SNMP Community> [oid <SNMP OID>]
action <fwdalltrapsmodem|fwdseltrapmodem> deviceport <Device Port #
or Name> nms <SNMP NMS> community <SNMP Community> [oid <SNMP Trap
OID>]
action <fwdalltrapsmodem|fwdseltrapmodem> usbport <U1|U2>
    nms <SNMP NMS> community <SNMP Community> [oid <SNMP Trap OID>]
action <fwdalltrapsmodem|fwdseltrapmodem> internal modem
    nms <SNMP NMS> community <SNMP Community> [oid <SNMP Trap OID>]
```

Description

Defines events.

admin events delete

Syntax

```
admin events delete <Event ID>
```

Description

Deletes an event definition.

admin events edit

Syntax

```
admin events edit <Event ID> <parameters>
```

Parameters

```

community <SNMP Community>
deviceport <Device Port # or Name>
ethport <1|2>
nms <SNMP NMS>
host <IP Address or Name>
oid <SNMP Trap OID>
outlet <Outlet #>
rpm <RPM Id or Name>
threshold <Load Percentage|Current in Amps>usbport <u1|u2>
internal modem
emailaddress <destination email address>

```

Description

Edits event definitions.

admin events show**Syntax**

```
admin events show
```

Description

Displays event definitions.

Group Commands

```
set groups add|edit <Group Name> [<parameters>]
```

Syntax

```
set groups add|edit <Group Name> [<parameters>]
```

Parameters

```

dataports <Port List>
listenports <Port List>
clearports <Port List>
escapeseq <1-10 Chars>
breakseq <1-10 Chars>
custommenu <Menu Name>
displaymenu <enable|disable>
allowdialback <enable|disable>
dialbacknumber <Phone Number>
permissions <Permission List>

```

Note: See 'help user permissions' for information on user rights.

Rename a group:

```
set groups rename <Group Name> newname <New Group Name>
```

Delete a group:

```
set groups delete <Group Name>
```

Show one or more groups:

```
show groups [name <Group Name>] members <enable|disable>
```

Host List Commands

```
set hostlist add|edit <Host List Name>
```

Syntax

```
set hostlist add|edit <Host List Name> [<parameters>]
```

Parameters

name <Host List Name> (edit only)

retrycount <1-10>

Default: retrycount=3, auth=enable.

auth <enable|disable>

Description

Configures a prioritized list of hosts to be used for modem dial-in connections.

```
set hostlist add|edit <Host List Name> entry
```

Syntax

```
set hostlist add|edit <Host List Name> entry <Host Number>  
[<parameters>]
```

Parameters

host <IP Address or Name>

protocol <ssh|telnet|tcp>

port <TCP Port>

escapeseq <1-10 Chars>

Description

Adds a new host entry to a list or edit an existing entry.

set hostlist edit <Host List Name> move**Syntax**

```
set hostlist edit <Host List Name> move <Host Number> position <Host Number>
```

Description

Moves a host entry to a new position in the host list.

set hostlist delete**Syntax**

```
set hostlist delete <Host List> [entry <Host Number>]
```

Description

Deletes a host list, or a single host entry from a host list.

show hostlist**Syntax**

```
show hostlist <all|names|Host List Name>
```

Description

Displays the members of a host list.

Internal Modem Commands

Configure the internal modem:

```
set intmodem <parameters>
```

Parameters

```
auth <pap|chap>
calleridcmd <Modem Command String>
calleridlogging <enable|disable>
modemstate <disable|dialin|dialout|dialback>
usesites <enable|disable>
modemmode <text|ppp>
group <Local or Remote Group Name>
timeoutlogins <disable|1-30 minutes>
modemtimeout <disable|1-9999 sec>
localipaddr <negotiate|IP Address>
restartdelay <PPP Restart Delay>
remoteipaddr <negotiate|IP Address>
chaphost <CHAP Host or User Name>
```

```

initscript <Modem Init Script>
nat <enable|disable>
chapauth <chaphost|localusers>
checkdialtone <disable|5-600 min>
dialbacknumber <username|Phone Number>
dialoutnumber <Phone Number>
dialbackdelay <PPP Dialback Delay>
dialoutlogin <Remote User Login>
dialbackretries <1-10>

```

Set the modem password and CHAP secret (any extra parameters will be ignored):

```

set intmodem dialoutpassword
set intmodem chapsecret

```

Note: *It is recommended that the initscript be prepended with 'AT' and include 'E1 V1 x4 Q0' so that the SLC may properly control the modem.*

Display settings for the internal modem:

```

show intmodem

```

IP Filter Commands

set ipfilter state

Syntax

```

set ipfilter state <enable|disable> [testtimer <disable|1-120 minutes>]

```

Description

Enables or disables IP filtering for incoming network traffic.

set ipfilter mapping

Syntax

```

set ipfilter mapping <parameters>

```

Parameters

```

ethernet <1|2|bond0> state <disable>
ethernet <1|2|bond0> state <enable> ruleset <Ruleset Name>
deviceport <1..48> state <disable>
deviceport <1..48> state <enable> ruleset <Ruleset Name>
usbport <U1|U2> state <disable>
usbport <U1|U2> state <enable> ruleset <Ruleset Name>
internal modem state <disable>
internal modem state <enable> ruleset <Ruleset Name>

```

Description

Maps an IP filter to an interface.

set ip filter rules**Syntax**

```
set ipfilter rules <parameters>
```

Parameters

```
add <Ruleset Name>
delete <Ruleset Name>
edit <Ruleset Name> <Edit Parameters>
```

Edit Parameters

```
append
insert <Rule Number>
replace <Rule Number>
delete <Rule Number>
```

Description

Sets IP filter rules.

Logging Commands

set deviceport port**Syntax**

```
set deviceport port <Device Port List or Name> <one or more deviceport
parameters>
```

Parameters

```
actiondelay <Action Delay>
actionrestart <Restart Delay>
bytethreshold <# of Characters>
emailsubj <Email Subject>
emailto <Email Address>
locallogging <enable|disable>
nfsdir <Logging Directory>
nfslogging <enable|disable>
nfsmaxfiles <Max # of Files>
nfsmaxsize <Size in Bytes>
poweraction <on|off|cycle>
powersupply <Managed Power Supply Name>
sendstring <String to Send|QUOTEDSTRING>
tokenaction <List of none,log,trap,email,string,power>
```



```

tokendatadetect <enable|disable>
tokenstring <Regex String>
tokentrigger <bytecnt|charstr>
usblogging <enable|disable>
usbmaxfiles <Max # of Files>
usbmaxsize <Size in Bytes>
usbport <u1|u2|sd>
sysloglogging <enable|disable>

```

Description

Configures logging settings for one or more device ports.

Local logging must be enabled for a device port for the `locallog` commands to be executed. To use the `set locallog clear` command, the user must have permission to clear port buffers (see [Chapter 12: User Authentication](#).)

Example

```
set deviceport port 2-5,6,12,15-16 locallogging enable
```

```
show locallog
```

Syntax

```
show locallog <Device Port # or Name> [bytes <Bytes To Display>]
           [startbyte <Byte Index>]
```

Description

Displays a specific number of bytes of data for a device port. 1K is the default.

```
set locallog clear
```

Syntax

```
set locallog clear <Device Port # or Name>
```

Description

Clears the local log for a device port.

The `locallog` commands can only be executed for a device port if local logging is enabled for the port. The `set locallog clear` command can only be executed if the user has permission to clear port buffers (see [Chapter 12: User Authentication](#)).

```
set log clear modem
```

Syntax

```
set log clear modem
```

Description

Clear the modem log (the modem log is automatically pruned when it reaches 50K):

```
set log modem ppplog
```

Syntax

```
set log modem ppplog <enable|disable>
```

Description

Enables PPP activity messages in the modem log.

```
set log modem ppplog <enable|disable>
```

Syntax

```
set log modem pppdebug
```

Description

Enables PPP debugging messages in the modem log:

```
set log modem pppdebug <enable|disable>
```

Syntax

```
show log modem
```

Description

View the modem activity log for external modems and USB modems:

```
show log modem [display <head|tail>][numlines <Number of Lines>]
```

```
show log local
```

Syntax

```
show log local
```

Description

View the log for local, NFS, or USB logging (NFS and USB use the current logging settings for the Device Port). Default is to show the log tail:

```
show log local|nfs|usb|sdcard <Device Port # or Name> [<parameters>]
```

Parameters

```
display <head|tail>
numlines <Number of Lines>
bytes <Bytes to Display>
```

```
startbyte <Byte Index>
logfile <NFS, USB or SD card Log File>
Defaults: bytes=1000, startbyte=1, numlines=40
```

Lists the NFS, USB, or SD card log files, either for a specific device port, or all log files in a USB, NFS, or SD card location:

```
show log files nfs|usb|sdcard [localdir <NFS Mount Local Directory>]
[usbport <U1|U2>]
[deviceport <Device Port # or name>]
```

Network Commands

set network

Syntax

```
set network <parameters>
```

Parameters

```
interval <1-99999 Seconds>
ipforwarding <enable|disable>
probes <Number of Probes>
startprobes <1-99999 Seconds>
```

Description

Sets TCP Keepalive and IP Forwarding network parameters.

set network bonding

Syntax

```
set network bonding <disabled|active-backup|802.3ad|load-balancing>
```

Description

Configure Ethernet Bonding.

set network dns

Syntax

```
set network dns <1|2|3> ipaddr <IP Address>
```

Description

Configures up to three DNS servers.

set network dnsipv4prec**Syntax**

```
set network dnsipv4prec <enable|disable>
```

Description

Configures IPv4/IPv6 lookup precedence.

set network gateway**Syntax**

```
set network gateway <parameters>
```

Parameters

```
default <IP Address>
ipv6default <IPv6 Address>
precedence <dhcp|default>
alternate <IP Address>
pingip <IP Address>
ethport <1 or 2>
pingdelay <1-250 seconds>
failedpings <1-250>
```

Description

Sets default and alternate gateways. The alternate gateway is used if an IP address usually accessible through the default gateway fails to return one or more pings.

set network host**Syntax**

```
set network host <Hostname> [domain <Domain Name>]
```

Description

Sets the SLC host name and domain name.

set network port**Syntax**

```
set network port <1|2> <parameters>
```

Parameters

```
state <dhcp|bootp|static|disable> [ipaddr <IP Address> mask <Mask>]
ipv6addr <IPv6 Address/Prefix>
```

```
mode <auto|10mbit-half|100mbit-half|10mbit-full|100mbit-full|
  1000mbit-full>
mtu <Maximum Transmission Unit>
set network ipv6 <enable|disable>
```

Description

Displays DNS settings.

show network dns**Syntax**

```
show network dns
```

Description

Displays DNS settings.

show network gateway**Syntax**

```
show network gateway
```

Description

Displays gateway settings.

show network host**Syntax**

```
show network host
```

Description

Displays the network host name of the SLC 8000 advanced console manager.

show network port**Syntax**

```
show network port <1|2>
```

Description

Displays Ethernet port settings and counters.

show network ipv6**Syntax**

```
show network ipv6
```

Description

Displays all ipv6 settings.

```
show network sfp
```

Syntax

```
show network sfp
```

Description

Displays network port 1 and port 2 SFP diagnostics.

show network all**Syntax**

```
show network all
```

Description

Displays all network settings.

NFS and SMB/CIFS Commands

set nfs mount**Syntax**

```
set nfs mount <one or more parameters>
```

Parameters

```
locdir <Directory>
```

```
mount <enable|disable>
```

```
remdir <Remote NFS Directory>
```

```
rw <enable|disable>
```

Enables or disables read/write access to remote directory.

Description

Mounts a remote NFS share.

The `remdir` and `locdir` parameters are required, but if they have been specified previously, you do not need to provide them again.

set nfs unmount**Syntax**

```
set nfs unmount <1|2|3>
```

Description

Unmounts a remote NFS share.

set cifs**Syntax**

```
set cifs <one or more parameters>
```

Parameters

```
eth1 <enable|disable>  
eth2 <enable|disable>  
state <enable|disable>  
workgroup <Windows workgroup>
```

Description

Configures the SMB/CIFS share, which contains the system and device port logs. The `admin config` command saves SLC configurations on the SMB/CIFS share.

set cifs password**Syntax**

```
set cifs password
```

Description

Changes the password for the SMB/CIFS share login (default is **cifsuser**).

show cifs**Syntax**

```
show cifs
```

Description

Displays SMB/CIFS settings.

show nfs**Syntax**

```
show nfs
```

Description

Displays NFS share settings.

Routing Commands

set routing**Syntax**

```
set routing [parameters]
```

Parameters

```
rip <enable|disable>  
route <1-64> ipaddr <IP Address> mask <Netmask> gateway <IP Address>  
static <enable|disable>  
version <1|2|both>
```

Description

Configures static or dynamic routing.

To delete a static route, set the IP address, mask, and gateway parameters to **0.0.0.0**.

show routing**Syntax**

```
show routing [resolveip <enable|disable>] [email <Email Address>]
```

Description

Sets the routing table to display IP addresses (disable) or the corresponding host names (enable). You can optionally email the displayed information.

RPM Commands

set rpm add**Syntax**

```
set rpm add <RPM Name>
```

Description

Adds an RPM to be managed (prompts will guide selection of RPM vendor and model).

set RPM command**Syntax**

```
set rpm command <RPM Id or Name>
      outlet <all|Outlet # or List> state <on|off|cyclepower>
```

Description

Sends a command to control one or more outlets on an RPM.

Syntax

```
set rpm command <RPM Id or Name> device <reboot|shutdown>
```

Description

Sends a command to control an RPM device.

Syntax

```
set rpm command <RPM Id or Name> beeper <mute|enable|disable>
```

Description

Sends a command to control an RPM beeper.

set rpm delete**Syntax**

```
set rpm delete <RPM Id or Name>
```

Description

Deletes an RPM.

set rpm driver**Syntax**

```
set rpm driver <RPM Id or Name> action restart
set rpm driver <RPM Id or Name> action debug [level <1|2|3>]
set rpm driver <RPM Id or Name> action show
set rpm driver <RPM Id or Name> action viewoutput [email <Email Address>]
      [display <head|tail>] [numlines <Number of Lines>]
```

Description

Control and debug the RPM driver if the driver is not properly communicating with the PDU or UPS: restart the driver; restart the driver with debug output to a file; show the running driver; view and email the driver debug output.

Note: Drivers running in debug mode will generate copious output and for disk space reasons should not be left running in debug mode for long periods of time.

set rpm edit

Syntax

```
set rpm edit <RPM Id or Name> <one or more parameters>
```

Parameters

```
name <New RPM Name>
outlets <# of Outlets>
ipaddr <IP Address>
port <TCP or Device Port>
login <RPM Admin Login>
rocommunity <SNMP Read-Only Community>
rwcommunity <SNMP Read-Write Community>
logstatus <disable|1-60 minutes>
snmptraps <enable|disable>
emailaddress <Email Address>
upslowbattery <shutdown|shutdownall|shutdownboth|allowfailure>
sdorder <disable|1-49>
powertoslc <enable|disable>
driveropts <Driver Options Override>
```

Description

Configure and control Remote Power Managers (RPMs), including PDUs and UPSes.

set rpm password

Syntax

```
set rpm password <RPM Id or Name>
```

Description

Set RPM administrative password.

show RPM

Syntax

```
show rpm [type <ups|pdu>]
        [config <sdorder|notify>]
        [device <RPM Name or Id> [data <raw|logs|envmon>]]
```

Note: The `show rpm envmon` command for RPM-configured ServerTech Serial/Network Mode is not supported by NUT/Powerman.

Description

Display a list of all RPMs, RPMs of a specific type, UPS shutdown and notification configuration, or details and outlets for a single RPM device.

SD Card Commands

Enables or disables access to SD Card devices:

```
set sdcard access <enable|disable>
```

Mounts a SD Card for use as a storage device. The SD Card can be used for saving configurations, firmware updates and device logging.

```
set sdcard mount
```

Unmounts a SD Card:

```
set sdcard unmount
```

Formats a SD Card:

```
set sdcard format [filesystem <ext2|fat16|fat32>]
```

Defaults: filesystem=ext2

Runs a filesystem check on a SD Card (recommended if it does not mount):

```
set sdcard fsck
```

Displays a directory listing of a SD Card:

```
set sdcard dir
```

Renames a file on a SD Card:

```
set sdcard rename <Filename> newfile <New Filename>
```

Copies a file on a SD Card:

```
set sdcard copy <Filename> newfile <New Filename>
```

Removes a file on a SD Card:

```
set sdcard delete <Current Filename>
```

Displays information about the SD Card device:

```
show sdcard
```

Security Commands**set security****Description**

Configures SLC security and FIPS settings.

Parameters

```
set security <parameters>
```

fipsmode**Parameters**

```
fipsmode <enable|disable>
```

show security**Description**

Displays security settings and current status.

Parameters

```
show security
```

Services Commands**set services****Syntax**

```
set services <one or more services parameters>
```

Parameters

netlog <off error warning info debug>	auditlog <enable disable>
authlog <off error warning info debug>	auditsize <1-500 Kbytes>
diaglog <off error warning info debug>	clicommands <enable disable>
servlog <off error warning info debug>	includesyslog <enable disable>
devlog <off error warning info debug>	snmp <enable disable>
genlog <off error warning info debug>	v1v2 <enable disable>
syslogserver1 <IP Address or Name>	traps <enable disable>
syslogserver2 <IP Address or Name>	trapversion <1 2 3>
rpmlogsize <5-40 Kbytes>	nms1 <IP Address or Name>
otherlogsize <5-400 Kbytes>	nms2 <IP Address or Name>
telnet <enable disable>	alarmdelay <1-6000 Seconds>
timeouttelnet <disable 1-30 minutes>	location <Physical Location>
telnetdatadir <netin netout both>	contact <Admin Contact Info>
webtelnet <enable disable>	rocommunity <Read-Only Community>
escapeseqtelnet <1-10 Chars>	rwcommunity <Read-Write Community>
outgoingtelnet <enable disable>	trapcommunity <Trap Community>
ssh <enable disable>	v3user <v3 RO User>
portssh <TCP Port>	v3rwuser <v3 RW User>
v1ssh <enable disable>	v3trapuser <v3 Trap User>

timeoutssh <disable 1-30 minutes>	v3security
sshdatadir <netin netout both>	<noauth auth authencrypt>
dsakeys <enable disable>	v3auth <md5 sha>
webssh <enable disable>	v3encrypt <des aes>
smtpserver <IP Address or Name>	phonehome <enable disable>
smtpsender <Email Address>	phoneip <IP Address>
	termbufsize <Number of Lines>

Description

Configures services (system logging, SSH and Telnet access, SSH and Telnet timeout, SNMP agent, email [SMTP] server, and audit log.)

set services v3password**Description**

Set SNMP v3 read-only, read-write and trap password/passphrase.

Syntax

```
set services v3password|v3phrase|v3rwpasswd|v3rwphrase|v3trappasswd
|v3trapphrase
```

show services**Syntax**

```
show services
```

Description

Displays current service settings.

SLC Network Commands

set slcnetwork**Syntax**

```
set slcnetwork <one or more parameters>
```

Parameters

```
add <IP Address>
delete <IP Address>
search <localsubnet|ipaddrlist|both>
```

Description

Detects and displays all SLC 8000 advanced console manager or user-defined IP addresses on the local network.

```
show slcnetwork
```

Syntax

```
show slcnetwork [ipaddrlist <all|Address Mask>]
```

Description

Detects and displays all SLC 8000 advanced console managers on the local network.

Without the `ipaddrlist` parameter, the command searches the SLC network. With the `ipaddrlist` parameter, the command displays a sorted list of all IP addresses or displays the IP addresses that match the mask (for example, 172.19.255.255 would display all IP addresses that start with 172.19).

SSH Key Commands

```
set sshkey all export
```

Syntax

```
set sshkey allexport <ftp|sftp|scp|coppypaste> [pubfile <Public Key File>] [host <IP Address or Name>] [login <User Login>] [path <Path to Copy Keys>]
```

Description

Exports the public keys all of the previously created SSH keys.

```
set sshkey delete
```

Syntax

```
set sshkey delete <one or more parameters>
```

Parameters

```
keyhost <SSH Key Host>
```

```
keyname <SSH Key Name>
```

```
keyuser <SSH Key User>
```

Description

Deletes an ssh key.

Specify the `keyuser` and `keyhost` to delete an imported key; specify the `keyuser` and `keyname` to delete exported key.

set sshkey export**Syntax**

```
set sshkey export <ftp|sftp|scp|copypaste> <one or more parameters>
```

Parameters

```
[format <openssh|secsh>]
[host <IP Address or Name>]
[login <User Login>]
[path <Path to Copy Key>]
[bits <1024|2048|3072|4096>]
keyname <SSH Key Name>
keyuser <SSH Key User>
type <rsa|dsa>
```

Description

Exports an sshkey.

set sshkey import**Syntax**

```
set sshkey import
```

Description

```
set sshkey import <ftp|sftp|scp|copypaste> <one or more parameters>
```

Parameters

```
[keyhost <SSH Key IP Address or Name>]
[keyuser <SSH Key User>]
[path <Path to Public Key File>]
file <Public Key File>
host <IP Address or Name>
login <User Login>
```

Description

Imports an SSH key.

set sshkey server import type**Syntax**

```
set sshkey server import type <rsa|rsa|dsa> via <sftp|scp>
  pubfile <Public Key File> privfile <Private Key File>
  host <IP Address or Name> login <User Login> [path <Path to Key File>]
```

Description

Imports an SLC host key.

```
set sshkey server reset
```

Syntax

```
set sshkey server reset [type <all|rsa1|rsa|dsa>]
```

Description

Resets defaults for all or selected host keys.

```
show sshkey export
```

Syntax

```
show sshkey export <one or more parameters>
```

Parameters

```
[keyhost <SSH Key IP Address or Name>]  
[keyname <SSH Key Name>]  
[keyuser <SSH Key User>]  
[viewkey <enable|disable>]
```

Description

Displays all exported keys or keys for a specific user, IP address, or name.

```
show sshkey import
```

Syntax

```
show sshkey import <one or more parameters>]
```

Parameters

```
[keyhost <SSH Key IP Address or Name>]  
[keyuser <SSH Key User>]  
[viewkey <enable|disable>]
```

Description

Displays all keys that have been imported or keys for a specific user, IP address, or name.

```
show sshkey server
```

Syntax

```
show sshkey server [type <all|rsa1|rsa|dsa>]
```

Description

Displays host keys (public key only).

Status Commands

show connections**Syntax**

```
show connections [email <Email Address>]
```

Description

Displays a list of current connections. Optionally emails the displayed information. The connection IDs are in the left column of the resulting table. The connection ID associated with a particular connection may change if the connection times out and is restarted.

show connections connid**Syntax**

```
show connections connid <Connection ID> [email <Email Address>]
```

Description

Provides details, for example, endpoint parameters and trigger, for a specific connection. Optionally emails the displayed information.

Note: Use the basic `show connections` command to obtain the Connection ID.

show portcounters**Syntax**

```
show portcounters [deviceport <Device Port List or Name>]  
[email <Email Address>]
```

Description

Generates a device port statistics report for one or more ports. Optionally emails the displayed information.

show portstatus**Syntax**

```
show portstatus [deviceport <Device Port List or Name>] [email <Email  
Address>]
```

Description

Displays device port modes and states for one or more ports. Optionally emails the displayed information.

```
show sysconfig
```

Syntax

```
show sysconfig [display <basic|auth|devices>] [email <Email Address>]
```

Description

Displays a snapshot of all configurable parameters. Optionally emails the displayed information.

```
show sysstatus
```

Syntax

```
show sysstatus [email <Email Address>]
```

Description

To display the overall status of all SLC units. Optionally emails the displayed information.

System Log Commands

```
show syslog
```

Syntax

```
show syslog [<parameters>]
```

Parameters

```
[email <Email Address>]  
level <error|warning|info|debug>  
log <all|netlog|servlog|authlog|devlog|diaglog|genlog>  
display <head|tail> [numlines <Number of Lines>]  
starttime <MMDDYYhhmm[ss]>  
endtime <MMDDYYhhmm[ss]>
```

Description

Displays the system logs containing information and error messages.

Note: *The level, display, and time parameters cannot be used simultaneously.*

show syslog clear**Syntax**

```
show syslog clear <all|netlog|servlog|authlog|devlog|diaglog|genlog>
```

Description

Clears one or all of the system logs.

USB Access Commands

set usb access**Syntax**

```
set usb access <enable|disable>
```

Description

Enables or disables access to USB devices.

USB Device Commands

show usb devices**Syntax**

```
show usb devices
```

Description

Displays all usb devices with the port each device is connected to.

diag usb**Syntax**

```
diag usb [<parameters>]
```

Parameters

```
treedisplay <enable|disable>
```

```
mapdevice <enable|disable>
```

```
email <Email Address>
```

Defaults: treedisplay=enable

Description

Displays information about USB buses and the devices connected to them, including the mapping between a USB device and the SLC port.

Note: For "mapdevice enable", the port names will be displayed at the end of the line in square brackets. To see a list of USB devices with vendor id and product id, use 'treedisplay disable'.

USB Storage Commands

set usb storage dir

Syntax

```
set usb storage dir <U1|U2>
```

Description

Views a directory listing of a USB flash drive.

set usb storage fsck

Syntax

```
set usb storage fsck <U1|U2>
```

Description

Runs a file system check on a thumb drive (recommended if it does not mount).

set usb storage format

Syntax

```
set usb storage format <U1|U2> [filesystem <ext2|fat16|fat32>]
```

Description

Formats a USB flash drive.

set usb storage mount

Syntax

```
set usb storage mount <U1|U2>
```

Description

Mounts a USB flash drive in the SLC 8000 advanced console manager for use as a storage device.

The USB flash drive must be formatted with an ext2 or FAT file system before you mount it.

set usb storage unmount

Syntax

```
set usb storage unmount <U1|U2>
```

Description

Unmounts a USB flash drive. Enter this command before removing the USB device.

set usb storage rename

Description

Renames a file on a thumb drive.

Syntax

```
set usb storage rename <U1|U2> file <Filename> newfile <New Filename>
```

set usb storage copy

Description

Copies a file on a thumb drive.

Syntax

```
set usb storage copy <U1|U2> file <Filename> newfile <New Filename>
```

set usb storage delete

Description

Removes a file on a thumb drive.

Syntax

```
set usb storage delete <U1|U2> file <Current Filename>
```

show usb storage

Description

Display product information and settings for any USB thumb drive.

Syntax

```
show usb storage
```

show usb**Description**

Display currently attached USB devices with product information and settings.

Syntax

```
show usb
show usb modem
```

Description

Display product information and settings for any USB modem:

Syntax

```
show usb modem
```

USB Modem Commands

set usb modem**Syntax**

```
set usb modem <u1|u2> <parameters>
```

Parameters

```
auth <pap|chap>
baud <300-115200>
```

9600 is the default.

```
calleridcmd <Modem Command String>
calleridlogging <enable|disable>
cbcpnocalldata <enable|disable>
cbctype <admin|user>
chapauth <chaphost|localusers>
chaphost <CHAP Host or User Name>
checkdialtone <disable|5-600 minutes>
databits <7|8>
dialbackdelay <PPP Dialback Delay>
dialbacknumber <username|Phone Number>
dialbackretries <1-10>
dialinlist <Host List for Dial-in>
dialoutlogin <Remote User Login>
dialoutnumber <Phone Number>
dodauth <pap|chap>
dodchaphost <CHAP Host or User Name>
flowcontrol <none|xon/xoff|rts/cts>
group <Local or Remote Group Name>
```

```

initscript <Modem Init Script>
localipaddr <negotiate|IP Address>
modemmode <text|ppp>
modemstate
<disable|dialin|dialout|dialback|cbcpserver|cbcpclient|dialondemand|
    dialin+ondemand|dialback+ondemand|dialinhostlist>
modemtimeout <disable|1-9999 sec>
nat <enable|disable>
parity <none|odd|even>
remoteipaddr <negotiate|IP Address>
restartdelay <PPP Restart Delay>
service <none|telnet|ssh|tcp>
sshauth <enable|disable>
sshport <TCP Port>
stopbits <1|2>
tcpauth <enable|disable>
tcpport <TCP Port>
telnetauth <enable|disable>
telnetport <TCP Port>
timeoutlogins <disable|1-30 minutes>
usesites <enable|disable>

```

Description

Configures a currently loaded USB Modem.

Note: *It is recommended that the initscript be prepended with 'AT' and include 'E1 V1 x4 Q0' so that the SLC may properly control the modem.*

Set the dialout password and CHAP secrets:

```

set usb modem <U1|U2> dialoutpassword
set usb modem <U1|U2> chapsecret
set usb modem <U1|U2> dodchapsecret

```

show usb modem**Description**

Display product information and settings for any USB modem:

Syntax

```
show usb modem
```

VPN Commands

set vpn**Syntax**

```
set vpn
```

Description

Configures setting for an IPsec VPN tunnel.

Parameters

```

set vpn <parameters>
name <VPN Tunnel Name>
ethport <1|2>
auth <rsa|psk>
auth <rsa|psk|x509>
remotehost <Remote Host IP Address or Name>
remoteid <Authentication Name>
remotehop <IP Address>
remotesubnet <one or more subnets in CIDR notation>
localid <Authentication name>
localhop <IP Address>
localsubnet <one or more subnets in CIDR notation>
ikenegotiation <main|aggressive>
ikeenc <any|3des|aes>
ikeauth <any|sha1|md5|sha2_256|sha2_512>
ikedhgroup <any|dh2|dh5|dh14|dh15>
espec <any|3des|aes>
espauth <any|sha1|md5|sha2_256|sha2_512>
espdhgroup <any|dh2|dh5|dh14|dh15>
pfs <enable|disable>
lifetime <SA Lifetime in Seconds>
modeconfig <enable|disable>
xauthclient <enable|disable>
xauthlogin <User Login>
remotepeertype <ietf|cisco>
forceencaps <enable|disable>
deadpeerdelay <disable|1-300 seconds>
deadpeertimeout <5-1200 seconds>
deadpeeraction <restart|hold|clear>

```

Enter RSA public key or Pre-Shared Key of remote host:

```
set vpn key
```

Configure X.509 certificate for remote peer or local peer.

```

set vpn certificate local via <sftp|scp> rootfile <Cert Authority File>
certfile <Certificate File> keyfile <Private Key File>
host <IP Address or Name> login <User Login> [path <Path to Files>]
set vpn certificate remote via <sftp|scp> [rootfile
  <Cert Authority File>]
certfile <Certificate File> host <IP Address or Name>
login <User Login> [path <Path to Files>]

```

Delete X.509 certificate for local and/or remote peer.

```
set vpn certificate delete
```

Enter XAUTH password:

```
set vpn xauthpassword
```

show vpn

Syntax

```
show vpn
```

Description

Shows the settings for the IPsec VPN tunnel.

Parameters

Display all VPN settings and current status:

```
show vpn [email <Email Address>]
```

Display detailed VPN status:

```
show vpn status [email <Email Address>]
```

Display VPN logs:

```
show vpn viewlog [numlines <Number of Lines>] [email <Email Address>]
```

Display RSA public key of the SLC:

```
show vpn rsakey
```

set temperature

Syntax

```
set temperature
```

Description

Sets the acceptable range for the internal temperature sensor (an SNMP trap is sent if the temperature is outside of this range). Temperatures can be entered in either Celsius or Fahrenheit; to indicate a temperature is Fahrenheit, append the degrees with an 'F', i.e., "75F".

Parameter

```
set temperature <one or more parameters>
```

Parameters: low <Low Temperature in C. or F.>

high <High Temperature in C. or F.>

calibrate <Temperature Calibration in C. or F.|cancel>

Note: The calibration offset will be applied one hour after setting the value.

Description

Displays the acceptable range and the current reading from the internal temperature sensor.

show temperature

Syntax

```
show temperature
```

Description

Shows the temperature.

Appendix A: Security Considerations

The SLC advanced console manager provides data path security by means of SSH or Web/SSL. Even with the use of SSH/SSL, however, do not assume you have complete security. Securing the data path is only one measure needed to ensure security. This appendix briefly discusses some important security considerations.

Security Practice

Develop and document a Security Practice. The Security Practice should state:

- ◆ The dos and don'ts of maintaining security. For example, the power of SSH and SSL is compromised if users leave sessions open or advertise their password.
- ◆ The assumptions that users can make about the facility and network infrastructure, for example, how vulnerable the CAT 5 wiring is to tapping.

Factors Affecting Security

External factors affect the security provided by the SLC unit, for example:

- ◆ Telnet sends the login exchange as clear text across Ethernet. A person snooping on a subnet may read your password.
- ◆ A terminal to the SLC may be secure, but the path from the SLC 8000 advanced console manager to the end device may not be secure.
- ◆ With the right tools, a person with physical access to open the SLC unit may be able to read the encryption keys.
- ◆ There is no true test for a denial-of-service attack. There is always a legitimate scenario for a request storm. A denial-of-service filter locks out some high-performance automated/scripted requests. The SLC 8000 advanced console manager will attempt to service all requests and will not filter out potential denial-of-service attacks.

Appendix B: Safety Information

Safety Precautions

Please follow the safety precautions described below when installing and operating the SLC advanced console manager.

Caution: *EQUIPMENT IS FOR INDOOR USE ONLY!*

Fuse Caution Statement

For protection against fire, replace the power-input-module fuse with the same type and rating.

Pour préserver la protection contre l'incendie, remplacez toujours le fusible du module d'alimentation électrique par un modèle du même type et de la même capacité.

Ersetzen Sie die Netzteilsicherung nur durch eine Sicherung desselben Typs und derselben Nennstromstärke um die Gefahr eines Brandes zu vermeiden.

Para proteger la unidad contra el fuego, sustituya el fusible del módulo de entrada de alimentación por otro del mismo tipo y capacidad.

주의 – 전원 입력 모듈 퓨즈를 교환할 때는 화재 예방을 위해 형식과 정격 전압 전류가 동일한 퓨즈를 사용하십시오 .

Предупреждение : Для защиты от пожара заменяйте предохранитель блока питания на предохранитель такого же типа и с такой же характеристикой.

Cover

- ◆ Do not remove the cover of the chassis. There are no user-serviceable parts inside. Opening or removing the cover may expose you to dangerous voltage that could cause fire or electric shock. The exception is access to the internal modem and RTC battery. For these you don't have to remove the chassis cover, but just the battery/modem door.
- ◆ Refer all servicing to Lantronix.

Power Plug

- ◆ When disconnecting the power cable from the socket, pull on the plug, not the cord.
- ◆ Always connect the power cord to a properly wired and grounded power source. Do not use adapter plugs or remove the grounding prong from the cord.
- ◆ Only use a power cord with a voltage and current rating greater than the voltage and current rating marked on the SLC unit.
- ◆ The SLC 8000 unit must be connected to a branch circuit provided with 15A or 20A, single pole circuit breaker.
- ◆ Install the SLC 8000 advanced console manager near an AC outlet that is easily accessible.
- ◆ Always connect any equipment used with the product to properly wired and grounded power sources.
- ◆ To help protect the product from sudden, transient increases and decreases in electrical power, use a surge suppressor, line conditioner, or uninterruptible power supply (UPS).

- ◆ Do not connect or disconnect this product during an electrical storm.

Input Supply

Caution: *Disconnect all power supply sources before servicing to avoid electric shock.*

- ◆ Check nameplate ratings to assure there is no overloading of supply circuits that could affect over current protection and supply wiring.

Grounding

1. Maintain reliable grounding of this product.
2. Pay particular attention to supply connections when connecting to power strips, rather than directly to the branch circuit.

Rack

If rack mounted SLC 8000 advanced console managers are installed in a closed or multi-unit rack assembly, they may require further evaluation by Certification Agencies. The following items must be considered:

- ◆ Do not install the SLC unit in a rack in such a way that a hazardous stability condition results because of uneven loading. A drop or fall could cause injury.
- ◆ The ambient temperature (T_{ma}) inside the rack may be greater than the room ambient temperature. Make sure to install the SLC 8000 advanced console manager in an environment with an ambient temperature less than the maximum operating temperature of the SLC unit. See [Technical Specifications \(on page 34\)](#).
- ◆ Install the equipment in a rack in such a way that the amount of airflow required for safe operation of the equipment is not compromised.
- ◆ Mount the equipment in the rack so that a hazardous condition is not achieved due to uneven mechanical loading.
- ◆ Maintain reliable earthing of rack-mounted equipment. Give particular attention to supply connections other than direct connections to the branch circuit (e.g. use of power strips).
- ◆ Before operating the SLC 8000 advanced console manager, make sure the SLC unit is secured to the rack.

Port Connections

- ◆ Only connect the network port to an Ethernet network that supports 10/100/1000 Base-T.
- ◆ Only connect device ports to equipment with serial ports that support EIA-232 (formerly RS-232C).
- ◆ Only connect the console port to equipment with serial ports that support EIA-232 (formerly RS-232C).
- ◆ Only connect a telephone line to the MODEM port.

Caution: *To reduce the risk of fire, use only number 26 AWG or larger (e.g., 24 AWG) UL-listed or CSA-certified telecommunication line cord.*

Appendix C: Adapters and Pinouts

The serial device ports of the SLC products match the RJ45 pinouts of the console ports of many popular devices found in a network environment. The SLC advanced console manager uses conventional straight-through Category 5 fully pinned network cables for all connections when used with Lantronix adapters. The cables are available in various lengths.

In most cases, you will need an adapter for your serial devices. Lantronix offers a variety of RJ45-to-serial connector adapters for many devices. These adapters convert the RJ45 connection on the SLC unit to a 9-pin or 25-pin serial connector found on other manufacturers' serial devices or re-route the serial signals for connections to other devices that use RJ45 serial connectors.

The console port is wired the same way as the device ports and has the same signal options.

Note: You can view or change the console port settings using the LCDs and keypads on the front panel, the [Devices > Console Port](#) page, or the command line interface `show console port` and `set consoleport` commands.

The adapters illustrated below are compatible with the Lantronix SLC models.

Figure C-1 RJ45. Receptacle to DB25M DCE Adapter for the SLC unit (PN 200.2066A)

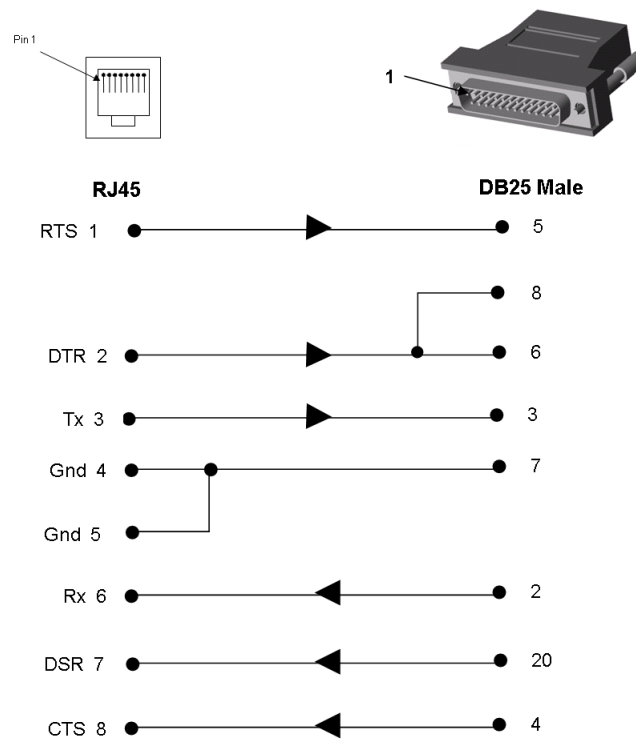

Use PN 200.2066A adapter with a dumb terminal or with many SUN applications.

Figure C-2 RJ45 Receptacle to DB25F DCE Adapter for the SLC unit (PN 200.2067A)

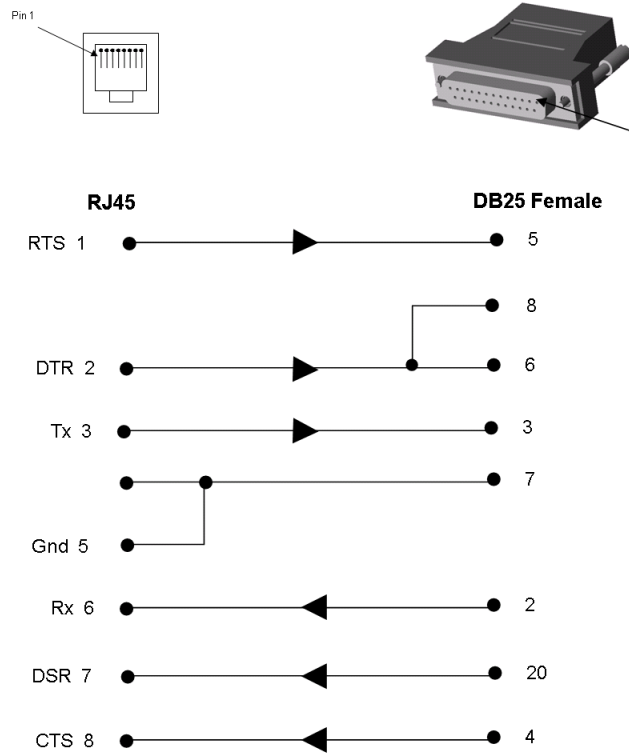

Figure C-3 RJ45 Receptacle to DB9M DCE Adapter for the SLC unit (PN 200.2069A)

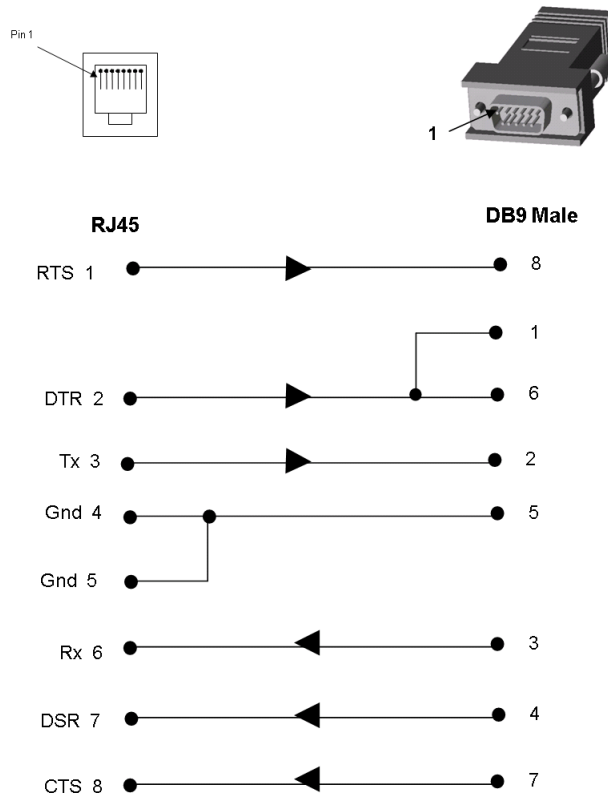
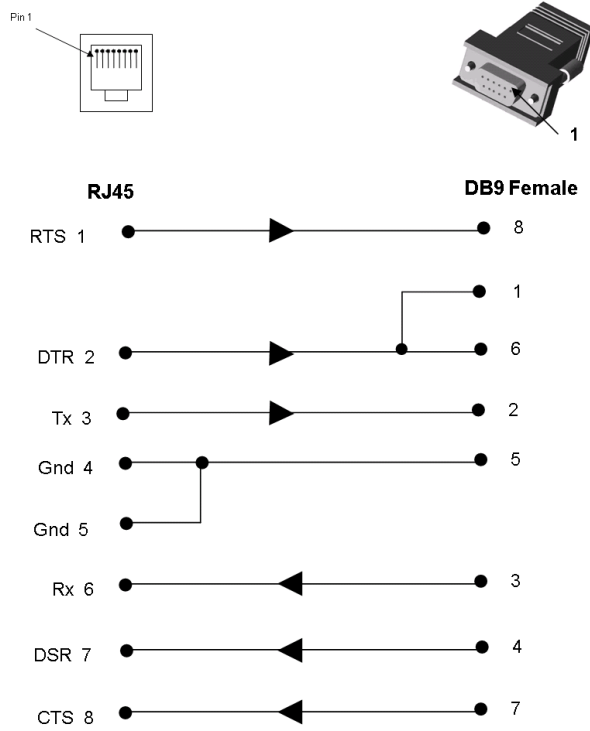
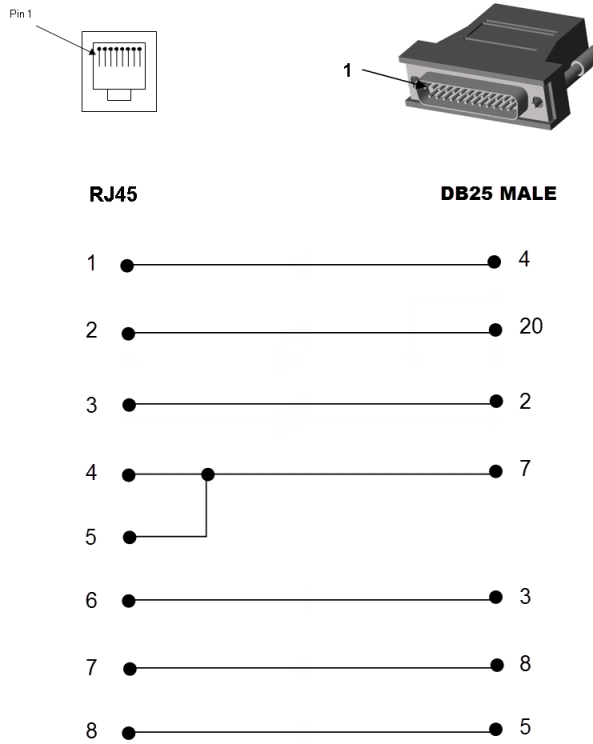

Figure C-4 RJ45 Receptacle to DB9F DCE Adapter for the SLC unit (PN 200.2070A)



Use PN 200.2070A adapter with a PC's serial port.

Figure C-5 RJ45 Receptacle to DB25M DTE Adapter (PN 200.2073)



Appendix D: Protocol Glossary

BOOTP (Bootstrap Protocol)

Similar to DHCP, but for smaller networks. Automatically assigns the IP address for a specific duration of time.

CHAP (Challenge Handshake Authentication Protocol)

A secure protocol for connecting to a system; it is more secure than the PAP.

DHCP (Dynamic Host Configuration Protocol)

Internet protocol for automating the configuration of computers that use TCP/IP.

DNS (Domain Name Servers)

A system that allows a network nameserver to translate text host names into numeric IP addresses.

IPsec

A protocol suite for securing Internet Protocol (IP) communications by authenticating and encrypting each IP packet of a communication session.

Kerberos

A network authentication protocol that provides strong authentication for client/server applications by using secret-key cryptography.

LDAP (Lightweight Directory Access Protocol)

A protocol for accessing directory information.

NAT (Network Address Translation)

An Internet standard that enables a LAN to use one set of IP addresses for internal traffic and a second set of addresses for external traffic. This enables a company to shield internal addresses from the public Internet.

NFS (Network File System)

A protocol that allows file sharing across a network. Users can view, store, and update files on a remote computer. You can use NFS to mount all or a portion of a file system. Users can access the portion mounted with the same privileges as the user's access to each file.

NIS (Network Information System)

System developed by Sun Microsystems for distributing system data such as user and host names among computers on a network.

NMS (Network Management System)

NMS acts as a central server, requesting and receiving SNMP-type information from any computer using SNMP.

NTP (Network Time Protocol)

A protocol used to synchronize time on networked computers and equipment.

PAP (Password Authentication Protocol)

A method of user authentication in which the username and password are transmitted over a network and compared to a table of name-password pairs.

PPP (Point-to-Point Protocol)

A protocol for creating and running IP and other network protocols over a serial link.

RADIUS (Remote Authentication Dial-In User Service)

An authentication and accounting protocol. Enables remote access servers to communicate with a central server to authenticate dial-in users and their access permissions. A company stores user profiles in a central database that all remote servers can share.

SMB/CIFS

(Server Message Block/Common Internet File System): Microsoft's protocol for allowing all applications as well as Web browsers to share files across the Internet. CIFS runs on TCP/IP and uses the SMB protocol in Microsoft Windows for accessing files. With CIFS, users with different platforms and computers can share files without having to install new software.

SNMP (Simple Network Management Protocol)

A protocol that system administrators use to monitor networks and connected devices and to respond to queries from other network hosts.

SMTP (Simple Mail Transfer Protocol)

TCP/IP protocol for sending email between servers.

SSL (Secure Sockets Layer)

A protocol that provides authentication and encryption services between a web server and a web browser.

SSH (Secure Shell)

A secure transport protocol based on public-key cryptography.

TACACS+ (Terminal Access Controller Access Control System)

A method of authentication used in UNIX networks. It allows a remote access server to communicate with an authentication server to determine whether the user has access to the network.

Telnet

A terminal protocol that provides an easy-to-use method of creating terminal connections to a network host.

Appendix E: Compliance Information

Manufacturer's Name & Address

Lantronix Inc., 7535 Irvine Center Drive, Suite100, Irvine, CA 92618 USA

Declares that the following product:

Product Name(s): SLC™ Advanced Console Manager

Conforms to the following standards or other normative documents:

Safety

- ◆ IEC 60950-1:2005 (2nd Edition); Am 1:2009 + A2:2013
- ◆ EN 60950-1:2006 + A11:2009 + A1:2010 + + A12:2011 + A2:2013
- ◆ UL 60950-1, 2nd Edition, 2014-10-14 (Information Technology Equipment - Safety - Part 1: General Requirements)
- ◆ CAN/CSA C22.2 No. 60950-1-07, 2nd Edition, 2014-10 (Information Technology Equipment - Safety - Part 1: General Requirements)
- ◆ GB4943.1: 2011 China Product Safety Compliance for ITE

Electromagnetic Emissions

- ◆ FCC Part 15, Subpart B, Class A EN 55022: 2011 (IEC/CISPR 22: 2009), class A
- ◆ EN 55032: 2012 + AC: 2013 (IEC/CISPR 32: 2015), class A
- ◆ KN 22: 2008 and KN 32: 2015 Korea Radio Disturbance Characteristics Compliance for ITE
- ◆ GB9254: 2008 China Radio Disturbance Characteristics Compliance for ITE

Electromagnetic Immunity

- ◆ EN 55024: 2010 Information Technology Equipment-Immunity Characteristics
- ◆ EN 61000-4-2: 2008, KN 61000-4-2 Electro-Static Discharge Test
- ◆ EN 61000-4-3: 2010, KN 61000-4-3 Radiated Immunity Field Test
- ◆ EN 61000-4-4: 2012, KN 61000-4-4 Electrical Fast Transient Test
- ◆ EN 61000-4-5: 2014, KN 61000-4-5 Power Supply Surge Test
- ◆ EN 61000-4-6: 2013, KN 61000-4-6 Conducted Immunity Test
- ◆ EN 61000-4-8: 2009, KN 61000-4-8 Magnetic Field Test
- ◆ EN 61000-4-11: 2004, KN 61000-4-11 Voltage Dips & Interrupts
- ◆ KN 24:2008 and KN 35: 2015 Korea Immunity Characteristics Compliance for ITE

Supplementary Information

This Class A digital apparatus complies with Canadian ICES-003 (CSA) and has been verified as being compliant within the Class A limits of the FCC Radio Frequency Device Rules (FCC Title 47, Part 15, Subpart B CLASS A), measured to CISPR 22: 2008 limits and methods of measurement of Radio Disturbance Characteristics of Information Technology Equipment. The product complies with the requirements of the Low Voltage Directive 72/23/EEC and the EMC Directive 89/336/EEC.

Additional Agency Approvals and Certifications

- ◆ VCCI
- ◆ UL/CUL
- ◆ C-Tick
- ◆ CB Scheme
- ◆ NIST-certified implementation of AES as specified by FIPS 197
- ◆ CCC
- ◆ KC

This product carries the CE mark since it has been tested and found compliant with the following standards:

- ◆ Safety: EN 60950-1
- ◆ Emissions: EN 55022, EN 55032 Class A
- ◆ Immunity: EN 55024

RoHS, REACH and WEEE Compliance Statement

Please visit <http://www.lantronix.com/legal/rohs/> for Lantronix's statement about RoHS, REACH and WEEE compliance.