



AL2000 Aluminum Surface Raceway

INSTALLATION INSTRUCTIONS

Wiremold Electrical Systems conform with, and should be installed and properly grounded in compliance with requirement of the current National Electrical Code or codes administered by local authorities.

All electrical products may represent a possible shock or fire hazard if improperly installed or used. Wiremold electrical products are UL listed, made for interior use and should be installed by qualified electrical people in conformance with current local and/or the National Electrical Code.

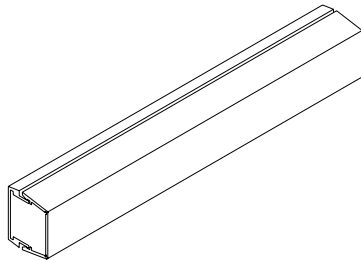

MAXIMUM CROSS SECTION

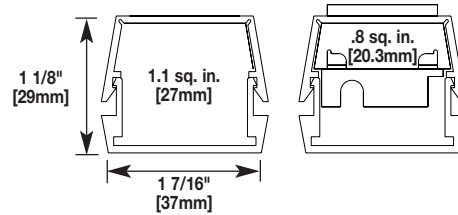

Note: Raceway may be configured in single or multiple channels to accommodate power or communications wiring.

AL2000 RACEWAY WIRE FILL CAPACITIES FOR POWER

	WIRE TYPE	TW	THW	RHH/RHW	THHN/THWN
POWER WIRING WITHOUT DEVICE 1.1 sq. in. cross section	6 AWG	5	5	4	8
	8 AWG	9	7	5	12
	10 AWG	20	14	10	24
	12 AWG	26	17	16	38
	14 AWG	33	21	19	51
POWER WIRING AWG WITH DEVICE 515 amp devices .8 sq. in. cross section	6 AWG	3	2	2	3
	8AWG	4	3	2	6
	10 AWG	5	3	3	8

AL2000 RACEWAY WIRE FILL CAPACITIES FOR DATA/COMMUNICATION

CABLE/WIRE SIZE		OD		20% FILL*	40% FILL**
		[In.]	[mm]		
UNSHIELDED TWISTED PAIR	4-pair, 24 AWG, Cat 5	0.220	[5.6]	5	11
	4-pair, 24 AWG, Cat, 3	0.190	[4.8]	7	15
TELEPHONE	2-pair, 24 AWG	0.140	[3.6]	14	28
	3-pair, 24 AWG	0.150	[3.8]	12	25
	4-pair, 24 AWG	0.190	[4.8]	7	15
	25-pair, 24 AWG	0.410	[10.4]	1	3
COAXIAL	RG58/U	0.195	[5.0]	7	14
	RG59/U	0.242	[6.1]	4	9
	RG62/U	0.242	[6.1]	4	9
	RG6/U	0.270	[6.9]	3	7
TWINAXIAL	100 Ohm	0.330	[8.4]	2	5
SHELDDED TWISTED PAIR	Type 1	0.390	[9.9]	1	3
	Type 2	0.465	[11.8]	1	2
	Type 3	0.245	[6.2]	4	9

NOTE:* 20% cable fill is calculated to approximate reduction in cable capacity due to connectors mounted within raceway and fittings that may restrict cross sectional area.

** 40% cable fill is the maximum designed cable fill base on a proposed revision to TIA/EIA 569-A.

AL2000 SYSTEM PRODUCT APPLICATIONS

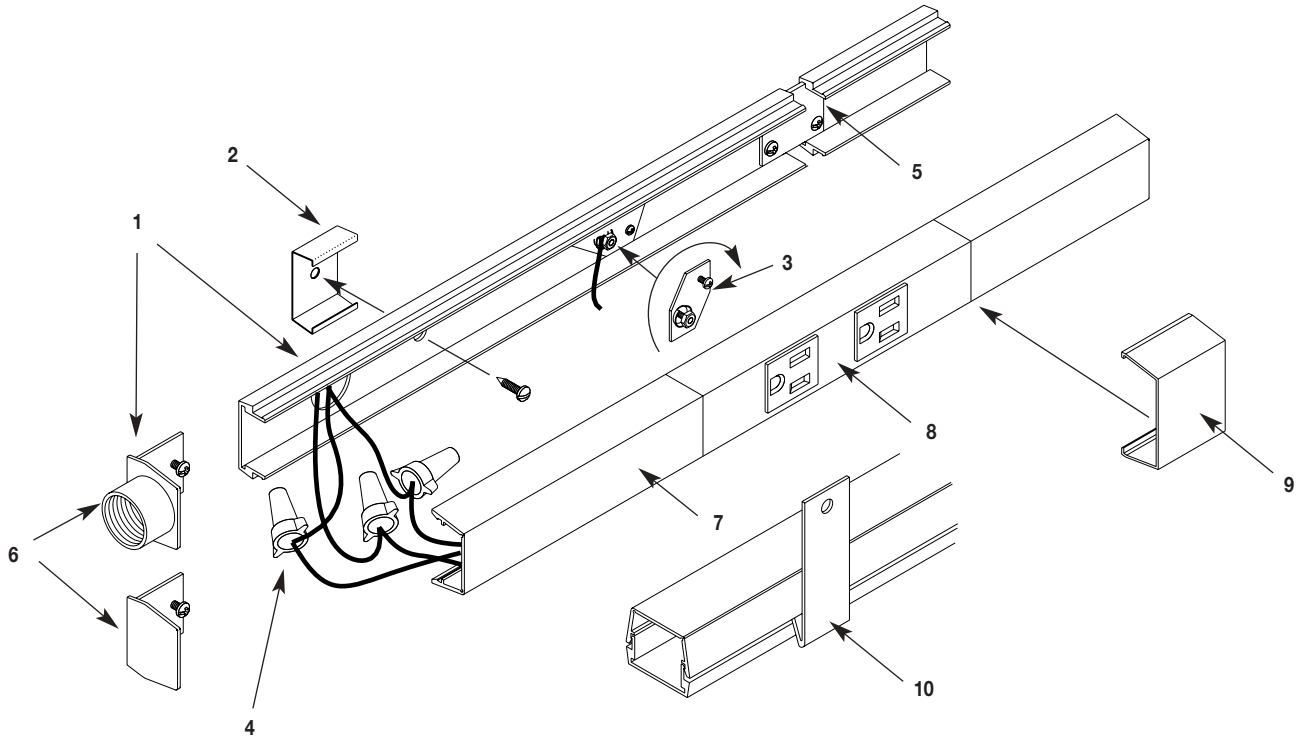

INSTALLATION:

1. Supply conductors may be fed from 1/2" trade size KO in base, or through Feed End Fitting (AL2010A). This system is designed with capacity for additional feed or circuitry conductors.
2. Attach base section on mounting surface with AL2003 Spring Mounting Clips, or by drilling 9/32" holes in the base and use #8 set screws.
3. Use Ground Adapter (AL2009) provided to secure ground connection. To relocate, loosen set screw and twist counter clockwise. Position in between receptacles (to avoid interference) and assemble in reverse order.
4. Connect circuit wires with connectors.
5. Additional multiple outlet sections or AL2000 raceway section may be attached at end with AL2001 coupler.
6. Close ends with blank end fitting (AL2010B) or (AL2010A).
7. Snap in cover section.
8. In-Line receptacle AL2043.
9. Snap in cover clip to cover joint where lengths of cover or base come together.
10. To remove cover, insert removal tool into groove, push down and twist.

Note: All mounting methods must result in flush interior surface. Consult factory for special outlet assemblies manufactured to your specification.

AL2003 MOUNTING CLIP

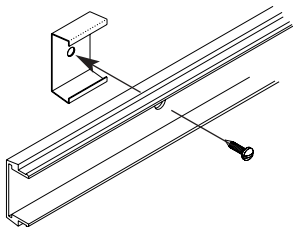

Use for external support of raceway. To install attach AL2003 to mounting surface with screws. Snap raceway base into AL2003.

AL2006 COVER CLIP

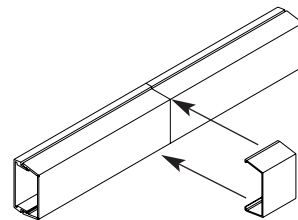

To close any gaps that occur from field cutting, snap AL2006 Cover Clip over joints, where two adjoining pieces come together.

**AL2010A FEED END FITTING
AL2010B BLANK END FITTING**

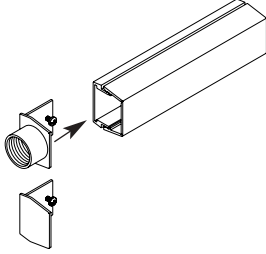

At end of AL2000B base raceway run, slide AL2000A or AL2000B fitting in last base section. Secure in place by tightening screw.

AI2043 IN-LINE RECEPTACLE

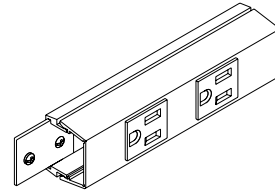

For AL2043 Series Two 15A, 120V U-ground factory prewired receptacles. To install slide coupler into grooves of AL2000B end base raceway and push sections together. Connect wires, tighten. Screws and snap in cover.

**AL2043IG IN-LINE ISOLATED
GROUND RECEPTACLE**

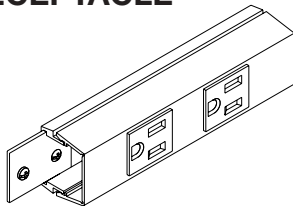

For AL2043IG Series Two 15A, 120V Isolated ground factory prewired receptacles. To install slide coupler into grooves of AL2000B base raceway and push sections together. Connect wires, tighten screws and snap in cover.

AL2040A IN-LINE SINGLE POLE SWITCH

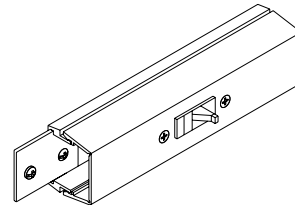

Single Pole Switch 15A. 120V. To Install slide coupler into groove of AL2400B base raceway and push sections together. Tighten screws and snap in cover.

**AL2038 SERIES ROUND
FIXTURE BOX**

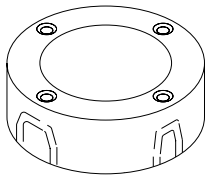

**AL2044 SERIES DEEP
DEVICE BOX**

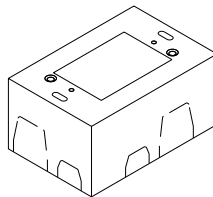

**AL2047 SERIES SHALLOW SWITCH
AND RECEPTACLE BOX**

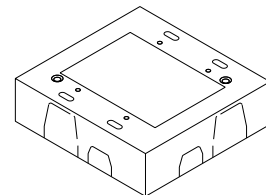

TO INSTALL

1. Attach back plate to 2x4 outlet utility box or mounting surface.
2. If back plate is not attached to box, use cover to close opening.
3. 1/2" or 3/4" conduit connections may be connected to back cover.
4. Slide AL2000B base raceway into slot of back plate. Tighten set screws to secure connections and for ground continuity.
5. Twist out KOs in cover section where raceway enters. Attach cover with screws.
6. Attach device (if required) to cover section.
7. Install standard cover plate.

AL2011 90° FLAT ELBOW

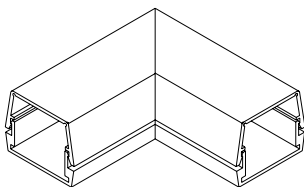

At 90° turn on same surface, position AL2011 Flat Elbow at end of AL200B base. Position next base section onto other end of AL2011. Center coupling over base joints and over base joints and tighten screws. Install fitting cover after wiring.

AL2017 INTERNAL ELBOW

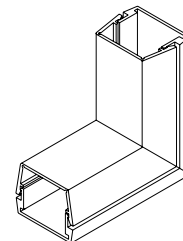

Install AL2017 to raceway base BEFORE mounting raceway base. Fasten section to surface joints, tighten set screws. Center coupling over base and tighten screws. Install fitting cover after wiring.

AL2015 TEE ELBOW

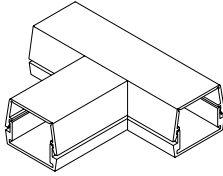

AL2015 Tee Fitting, position fitting at end of AL2000B base. Install other base section to other end of fitting. Center couplings on joints and tighten screws. Install fitting cover after wiring.

AL2018 EXTERNAL ELBOW

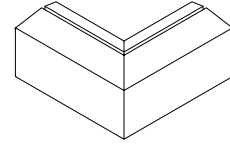

At 90° outside corner, position AL2018 External Elbow at end of joints and tighten screws. Install fitting cover after wiring.

AL2416 CROSS ELBOW

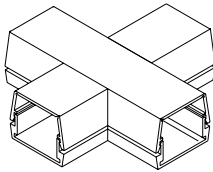

AL2416 Cross Elbow, position fitting at end of AL2000B base. Install other base sections to other ends of the fitting. Center couplings on joints tighten screws. Install cover fitting after wiring.

AL2000WC WIRE CLIP

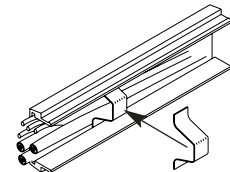

For retaining wires in long raceway run, Snap-in AL2000 WC Wire Clip approximately 30" apart into AL2000B base.

AL2000B BASE

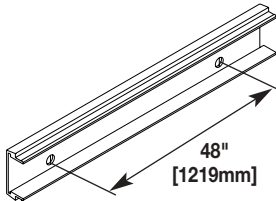

To attach AL2000B base sections to mounting surface, drill 9/32" holes in the base (approx. 48" o.c.). Fasten base with #8 flathead head screws.

AL2001 COUPLING

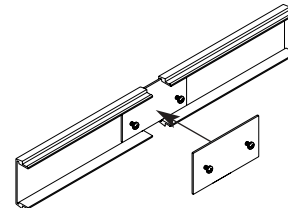

At AL2000B base section butt joints, slide AL2001 Coupling into first base section mount next base to surface. Center coupling on joints. Tighten locking screws.

AL2051H BOX ADAPTOR

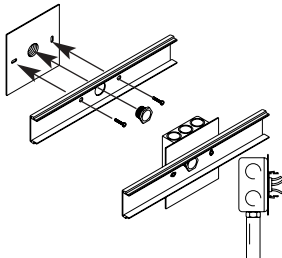

Use for feed raceway from existing wall outlet box. To install, attach adaptor to outlet box with two screws. This system is designed with capacity for additional feed or circuitry conductors.

AL2009 GROUND CLAMP

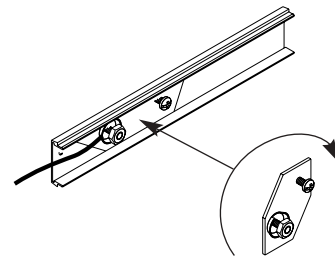

Position AL 2009 Ground Clamp into rib in AL2000B raceway base. Tighten locking screw. Attach ground wire using brass cup washer and green hex nut to ground lug.



The Wiremold Company

U.S. and International:

60 Woodlawn Street • West Hartford, CT 06110

1-800-421-6196 • FAX 860-232-2062 • Outside U.S. 860-233-6251

