

# User's Guide

RJ-2030

RJ-2050

RJ-2140

RJ-2150

Before using this printer, be sure to read this User's Guide.

We suggest that you keep this manual in a handy place for future reference.

# Introduction

## Important Notice

---

- The contents of this document and the specifications of this product are subject to change without notice.
- Brother reserves the right to make changes without notice in the specifications and materials contained herein and shall not be responsible for any damages (including consequential) caused by reliance on the materials presented, including but not limited to typographical and other errors relating to the publications.
- Screen images in this document may differ depending on your computer's operating system.
- Before using the printer, be sure to read all documents included with the printer for information about safety and correct operation.
- Illustrations and text displays shown in this manual are for RJ-2140/2150. Illustrations for RJ-2030/2050 may also be shown in this manual if necessary.

## Available Manuals

---

You can download the latest manuals from the Brother support website at [support.brother.com](http://support.brother.com)





Product Safety Guide <sup>1, 2</sup>	This guide provides safety information; read it thoroughly before using your printer.
Quick Setup Guide <sup>1, 2</sup>	This guide provides basic information about using your printer along with detailed troubleshooting tips.
User's Guide <sup>2</sup>	This guide includes the contents of the Quick Setup Guide, and additional information about your printer settings, operations, safety precautions, network connection settings, troubleshooting tips, and maintenance instructions.
AirPrint Guide <sup>2</sup>	This guide provides information for using AirPrint to print from an Apple device.
P-touch Template Manual <sup>2</sup>	This manual provides information on P-touch Template.
Raster Command Reference <sup>2</sup>	This manual provides information about printer control commands for controlling your printer directly.

<sup>1</sup> Printed manual in the box.





<sup>2</sup> PDF manual on the Brother support website.



## Symbols Used in This Guide

The following symbols are used throughout this guide.

 <b>WARNING</b>	Tells you what to do to avoid the risk of injury.
 <b>CAUTION</b>	Tells you about procedures you must follow to avoid minor personal injury or damage to the printer.
 <b>Important</b>	Indicates information or directions that should be followed. Ignoring them may result in damage, or failed operations.
 <b>Note</b>	Indicates notes that provide information or directions that can help you better understand and use the product more efficiently.

## Important safety instructions

 <b>WARNING</b>	
	DO NOT use the printer where its use is prohibited, such as on an airplane. This could affect the airplane's equipment, resulting in an accident.
	DO NOT use the printer in special environments, such as near medical equipment. Electromagnetic waves may cause the medical equipment to malfunction.
	DO NOT allow organic solvents, such as benzene, thinner, polish remover, or deodorizers, to come into contact with the plastic cover. These may cause the plastic cover to warp or dissolve, resulting in an electrical shock or fire.
	

 <b>CAUTION</b>	
	RD Rolls use thermal paper, therefore the color of the label and the printing may change or fade if exposed to sunlight or heat. When using outdoors and when durability is important, we DO NOT recommend using RD Rolls.
	Depending on the area, material, and environmental conditions, the label may unpeel or become permanently affixed, and the color of the label may change or be transferred to other objects. Before affixing the label, check the environmental conditions and the material. Test the label by affixing a small piece of it to an inconspicuous area of the intended surface.

<b>IMPORTANT</b>	
<ul style="list-style-type: none"><li>■ DO NOT remove the labels affixed to the printer. These labels provide operational information and indicate the printer's model number.</li><li>■ DO NOT push the power switch with an object that has a sharp point, such as a pen. This could damage the switch or LED.</li><li>■ DO NOT transport the printer while cables are connected to the DC connector or mini-USB port. The connector and ports could be damaged.</li><li>■ DO NOT store the printer in an area exposed to high temperatures, high humidity, direct sunlight, or dust. These could cause discoloration or a malfunction.</li></ul>	

## General Precautions

### Printer

- If the Bluetooth and wireless LAN functions are both turned on, the communication speed may decrease due to radio wave interference. If this occurs, turn off the function you are not using (Bluetooth or wireless LAN function).
- DO NOT cover or insert foreign objects into the paper exit slot, DC connector, or mini-USB port.
- DO NOT use paint thinner, benzene, alcohol or any other organic solvents to clean the printer. Doing so may cause damage to the surface finish. You can use isopropyl alcohol or ethanol only when cleaning the print head or roller. Use a soft, dry cloth to clean the printer.
- When not used for an extended period, remove the media roll from the printer.
- Always keep the media roll compartment cover closed when printing.
- When using optional accessories, use them as described in their instruction manuals.
- This printer uses thermal paper. If the printed paper is marked with ink, for example written on or stamped, the ink may cause the printed text to fade or become discolored. In addition the applied ink may take some time to dry. Printed text may fade or become discolored if the label comes into contact with any of the following: vinyl chloride products, leather goods such as wallets and purses, organic compounds such as alcohol, ketones, or esters, adhesive tape, erasers, rubber mats, magic marker ink, permanent marker ink, correction fluid, carbon, glue, diazo sensitized paper, hand lotion, hair care products, cosmetics, water, or sweat.
- DO NOT touch the printer with wet hands.
- DO NOT use folded, wet or damp paper, otherwise a paper misfeed or malfunction may occur.
- DO NOT touch paper or labels with wet hands, otherwise a malfunction may occur.

### RD Roll

- Use only genuine Brother accessories and supplies (indicated by the  mark).
- If the label is affixed to a wet, dirty, or oily surface, it may peel off easily. Before affixing the label, clean the surface to which the label will be affixed.
- RD Rolls use thermal paper, therefore ultraviolet rays, wind, and rain may cause the color of the label to fade and the ends of the label to peel off.
- DO NOT expose the RD Roll to direct sunlight, high temperatures, high humidity, or dust. Store in a cool, dark place. Use the RD Roll soon after opening the package.
- Scratching the printed surface of the label with your finger nails or metal objects, or touching the printed surface with hands dampened by water, sweat, or medicated cream, etc., can cause the color to change or fade.
- DO NOT affix labels to people, animals, or plants. Never affix labels to public or private property without permission.
- The last labels of the RD Roll may not be printed correctly, therefore, each roll contains more labels than is indicated on the package.
- When a label is removed after being affixed to a surface, a portion of the label may remain.
- Once a label is affixed, it may be difficult to remove the label.

## IMPORTANT NOTE

- This product is approved for use in the country of purchase only. Do not use this product outside the country of purchase as it may violate the wireless telecommunication and power regulations of that country.
- Windows Vista in this document represents all editions of Windows Vista.
- Windows 7 in this document represents all editions of Windows 7.
- Windows 8 in this document represents all editions of Windows 8.
- Windows 8.1 in this document represents all editions of Windows 8.1.
- Windows 10 in this document represents Windows 10 Home, Windows 10 Pro, Windows 10 Enterprise, and Windows 10 Education.  
Windows 10 in this document does not represent Windows 10 Mobile, Windows 10 Mobile Enterprise, or Windows 10 IoT Core.
- Windows Server 2008 in this document represents all editions of Windows Server 2008 and Windows Server 2008 R2.
- Windows Server 2012 in this document represents all editions of Windows Server 2012 and Windows Server 2012 R2.
- Not all models are available in all countries.

© 2016 Brother Industries, Ltd. All rights reserved.

# Table of Contents

## Section I Basic Operations

<b>1</b>	<b>Setting Up the Printer</b>	<b>2</b>
	General Description .....	2
	LCD .....	3
	LED Indicators .....	4
	Button Functions.....	5
	Battery Installation/Removal .....	6
	Installing the Battery .....	6
	Removing the Battery .....	7
	Recharging the Battery .....	8
	While Installed in the Printer.....	8
	Recharging the Battery Using the AC Adapter (Optional) .....	9
	Recharging the Battery Using the Car Adapter (Optional) .....	10
	Recharging the Battery Using the Battery Charger (Optional) .....	10
	Stopping Rechargeable Li-ion Battery Charging .....	11
	Tips on Using the Rechargeable Li-ion Battery .....	11
	Turning the Printer On or Off .....	12
	Setting the Language of the LCD .....	12
	Inserting the Paper or Label Roll .....	12
	For RJ-2030/2050.....	12
	For RJ-2140/2150.....	14
	Cutting Roll Paper .....	16
	Removing the Receipt/Label Roll .....	17
	For RJ-2030/2050.....	17
	For RJ-2140/2150.....	18
	Attaching the Belt Clip .....	19
	Install Software to Your Computer or Mobile Device .....	21
	Available Software.....	21
	Installing the Printer Driver and Software (When Using a Computer) .....	23
	Connecting the Printer to a Computer or Mobile Device .....	24
	Connecting Using USB.....	24
	Connecting Using Bluetooth (RJ-2030/2050/2150 Only).....	25
	Connecting Using Wi-Fi® (RJ-2050/2140/2150 Only).....	26
	LCD .....	30
	LCD Settings .....	30
<b>2</b>	<b>Using the Printer</b>	<b>32</b>
	Printing from Computers.....	32
	Printing with the Printer Driver .....	32
	Setting Printer Driver Options.....	32
	Printing from Mobile Device.....	33

---

### **3 Changing the Printer Settings 34**

---

Printer Setting Tool .....	34
Before Using the Printer Setting Tool .....	34
Using the Printer Setting Tool .....	35
Communication Settings .....	37
Settings Dialog Box .....	37
Menu Bar .....	39
General Tab .....	42
Wireless LAN Tab (RJ-2050/2140/2150 Only) .....	45
Wireless Direct Tab (RJ-2050/2140/2150 Only) .....	49
Bluetooth Tab (RJ-2030/2050/2150 Only) .....	50
Applying Setting Changes to Multiple Printers .....	51
Device Settings .....	52
Settings Dialog Box .....	52
Menu Bar .....	54
Basic Tab .....	56
Advanced Tab .....	58
Sensor Adjustment Tab .....	59
Display Settings Tab .....	60
Applying Setting Changes to Multiple printers .....	61
P-touch Template Settings .....	62
P-touch Template .....	62
P-touch Template Settings Dialog Box .....	63
Paper Size Setup .....	65
Paper Size Setup Dialog Box .....	65
Distributing Paper Formats .....	70
Changing Settings When Printing from a Mobile Device .....	70

---

### **4 Other Functions 71**

---

Printing the Printer Information .....	71
Mass Storage Mode .....	72
Description .....	72
Using the Mass Storage Mode .....	72
JPEG Printing .....	73
Remote Update .....	73

---

### **5 Maintaining the Printer 74**

---

Print Head Maintenance .....	74
Roller Maintenance .....	75
Paper Exit Slot Maintenance .....	76

## **Section II Application**

---

### **6 How to Use P-touch Editor 78**

---

Using P-touch Editor .....	78
Using P-touch Editor .....	78

Tips for Creating Templates .....	82
Creating a Template .....	82
Linking a Database to a Template .....	85

---

## **7 How to Use P-touch Transfer Manager & P-touch Library 87**

---

Using P-touch Transfer Manager .....	88
Transferring the Template to P-Touch Transfer Manager .....	88
Transferring Templates or Other Data from the Computer to the Printer .....	91
Backing up Templates or Other Data Saved in the Printer .....	96
Deleting All the Printer Data .....	97
Creating a BLF File or a PDZ File .....	98
Using P-touch Library .....	99
Starting P-touch Library .....	99
Opening and Editing Templates .....	100
Printing Templates .....	101
Searching for Templates or Other Data .....	101

---

## **8 Transferring Templates with P-touch Transfer Express 103**

---

Preparing P-touch Transfer Express .....	103
Transferring the Template to P-Touch Transfer Manager .....	104
Saving the Template as a Transfer Package File (.pdz) .....	105
Distributing the Transfer Package File (.pdz) and P-Touch Transfer Express to the User .....	107
Transferring the Transfer Package File (.pdz) to Your Printer .....	108

---

## **9 How to Update P-touch Software 111**

---

Updating P-touch Editor .....	111
Updating the Firmware .....	113

## **Section III Wireless network (RJ-2050/2140/2150 Only)**

---

### **10 Introduction 116**

---

Network Features .....	116
------------------------	-----

---

### **11 Changing Your Printer's Network Settings 117**

---

Changing Your Printer's Network Settings (IP Address, Subnet Mask and Gateway) .....	117
Using the BRAdmin Light Utility .....	117
Other Management Utilities .....	119
Using the Web Based Management (Web Browser) .....	119
Using the BRAdmin Professional Utility .....	119

---

### **12 Web Based Management 120**

---

Overview .....	120
Configuring the Printer Settings Using Web Based Management (Web Browser) .....	121



## Section IV Appendix

<b>13</b>	<b>Product Specifications</b>	<b>123</b>
<b>14</b>	<b>Troubleshooting</b>	<b>125</b>
	Overview .....	125
	Printing Problems .....	125
	Printed Image Problems .....	127
	Printer Problems .....	128
	Network Setup Problems .....	130
	Cannot Print over the Network	
	Printer Is Not Found on the Network Even after Successful Installation .....	131
	Security Software Problems .....	131
	Checking the Operation of Network Devices .....	132
	Error Messages from the Printer .....	132
<b>15</b>	<b>Supported Protocols and Security Features</b>	<b>134</b>
<b>16</b>	<b>Network Terms and Information</b>	<b>135</b>
	Types of Network Connections and Protocols .....	135
	Types of Network Connections .....	135
	Configuring Your Printer for a Network .....	137
	IP Addresses, Subnet Masks and Gateways .....	137
	Wireless Network Terms and Concepts .....	139
	Security Terms .....	139



# Basic Operations

---



<b>Setting Up the Printer</b>	<b>2</b>
<b>Using the Printer</b>	<b>32</b>
<b>Changing the Printer Settings</b>	<b>34</b>
<b>Other Functions</b>	<b>71</b>
<b>Maintaining the Printer</b>	<b>74</b>

# 1

## Setting Up the Printer

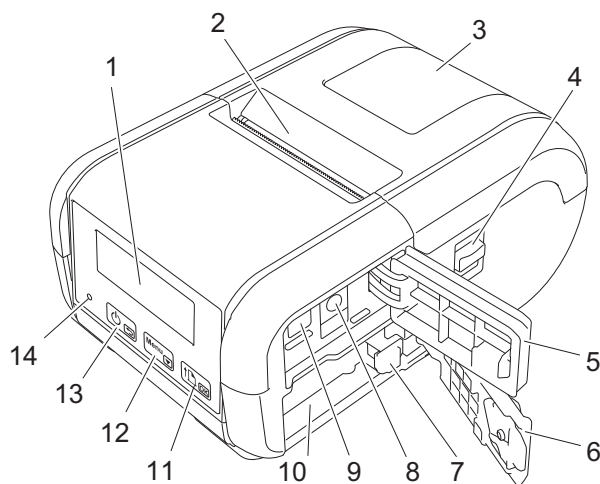
### General Description



- 1 LCD
- 2 Paper exit slot
- 3 Media roll compartment cover
- 4 Media roll cover open lever
- 5 Interface cover
- 6 Battery cover
- 7 Battery latch
- 8 DC connector
- 9 Mini-USB port
- 10 Battery compartment
- 11  (Feed) button/OK button  
To feed the paper or print your printer settings
- 12  Menu button/▼ button
- 13  (Power) button/↩ (Back) button  
To turn your printer on/off
- 14 LED indicator

## LCD

When the printer is turned on, the main screen appears.



### 1 Update icon (RJ-2050/2140/2150 only)

Indicates whether updated templates, databases, and other data are available.

: There is new data.

(flashing): Update of the data failed.

(flashing): Cannot communicate with the server.

### 2 Wireless Direct icon (RJ-2050/2140/2150 only)

### 3 WLAN icon (RJ-2050/2140/2150 only)



: The network is connected correctly.

: Your printer is searching for the network.

### 4 Bluetooth icon (RJ-2030/2050/2150 only)

### 5 Battery level

Indicates the remaining battery level.

■ Full:

■ Half:

■ Low:





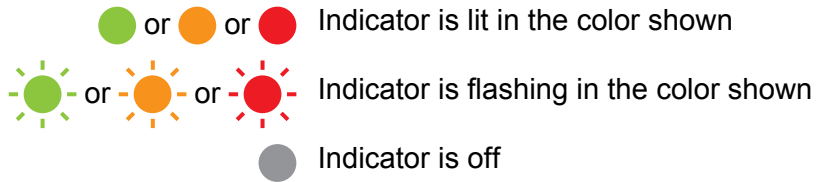

■ Charging:

### 6 Printer status





## LED Indicators



The indicator lights and flashes to indicate your printer's status. The symbols used in this section explain the meaning of the different indicator colors and patterns:







Indicator status	Condition
	Power off Charging complete (when power is turned off)
	Battery level: one-third or more Charging complete (when power is turned on)
	Charging
	Program transfer failed
	Battery level: low
	Battery level: empty Wrong media error Cover open error System error Mass storage error Communication error WPS connection error Memory full error Database search error No template error

## Button Functions

 (Power) button/  (Back) button function	Operation
Turn the printer on	While the printer is turned off, press and hold the  (Power) button until the LCD turns on.
Turn the printer off	While the printer is turned on, press and hold the  (Power) button until the message [System Off] appears on the LCD. (If the <b>[Auto Power Off]</b> feature is enabled in the Device settings, the printer will turn itself off automatically after the selected period of inactivity.)
Start the printer in mass storage mode	If you press and hold this button while also pressing the [Menu] button, the printer starts in mass storage mode (see <i>Mass Storage Mode</i> on page 72).

 button/  button function	Operation
Enter the menu selection mode	While the printer is turned on, press the [Menu] button.
Select the menu option	When the menu is displayed, press the [  ] button to select the next option.
Execute a file stored in the mass storage area	If you press this button while the printer is running in mass storage mode, you can execute a command file stored in the mass storage area (see <i>Mass Storage Mode</i> on page 72).

 (Feed) button/ OK button function	Operation
Feed the paper	When the paper type is set to <b>[Die-cut Label]</b> (RJ-2140/2150 only) or <b>[Media With Marks]</b> : Press the  (Feed) button to automatically feed the paper to the print position.  When the paper type is set to <b>[Continuous Length Tape]</b> : Press the  (Feed) button to feed the paper.
Print the printer information	Make sure that a roll is set, and then press and hold the  (Feed) button. The printer starts printing its settings (see <i>Printing the Printer Information</i> on page 71).
Activate the function mode for the selected item	Press the [OK] button to activate the selected menu option.
Enable or disable the function for automatically connecting again using Bluetooth	<ol style="list-style-type: none"> <li>1 Press the [Menu] button to select the [Bluetooth] menu, and then press the [OK] button.</li> <li>2 Select [On] or [Off], and then press and hold the [OK] button until the screen changes.</li> </ol>

# Battery Installation/Removal

## Installing the Battery

- 1 Move the battery cover lock to the unlock position, and then open the battery cover.

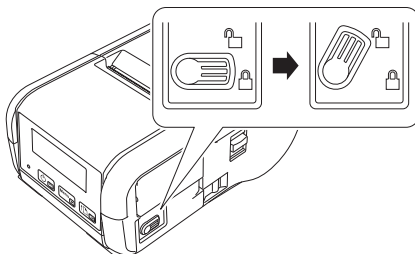

- 2 Insert the battery into the battery compartment until the battery latch locks into place. Make sure that the terminal end of the battery is facing inwards and oriented correctly as shown. Do NOT use excessive force to install the battery.

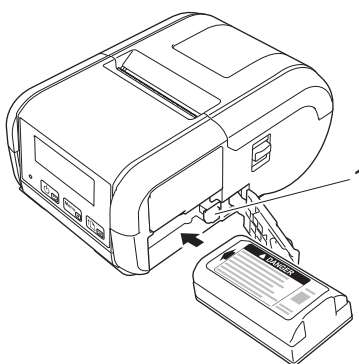

### 1 Battery latch

- 3 Close the battery cover, and then move the battery cover lock to the lock position.

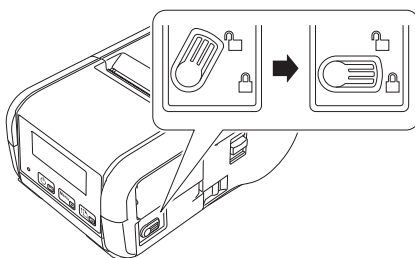

## Removing the Battery

- 1 Move the battery cover lock to the unlock position, and then open the battery cover.

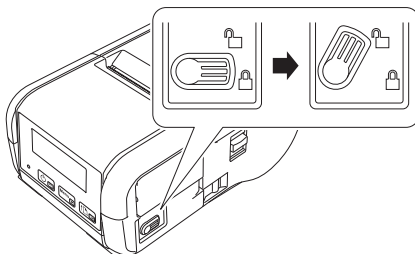

- 2 While pushing the battery latch, remove the battery.

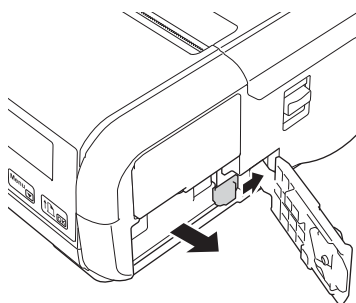

- 3 Close the battery cover, and then move the battery cover lock to the lock position.

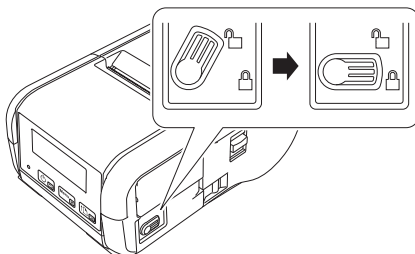



## Recharging the Battery

### While Installed in the Printer

---

To charge the rechargeable Li-ion battery (PA-BT-003), insert it into the printer and do the following:



#### Note

---

- Before using the rechargeable Li-ion battery, use the following procedure to charge it.
  - Print speed varies with the available battery power.
- 



1 Make sure that the rechargeable Li-ion battery is installed in the printer.



2 Use the compatible Brother AC adapter (PA-AD-600A) and AC power cord to connect the printer to an AC power outlet (see *Recharging the Battery Using the AC Adapter (Optional)* on page 9), or use the Brother compatible car adapter to connect the printer to a DC power outlet (see *Recharging the Battery Using the Car Adapter (Optional)* on page 10).



#### Note

---

The LED indicator light is orange when the battery is charging.

When the rechargeable Li-ion battery is fully charged, the LED indicator turns off (when power is turned off) or lights in green (when power is turned on). Disconnect the AC adapter or car adapter from the battery's DC connector.

---

## Recharging the Battery Using the AC Adapter (Optional)

- 1 Make sure that the rechargeable Li-ion battery is installed in the printer.
- 2 Open the interface cover and connect the AC adapter to your printer.
- 3 Connect the AC power cord to the AC adapter.
- 4 Connect the AC power cord to a nearby AC power outlet (100 - 240 VAC, 50 - 60 Hz).

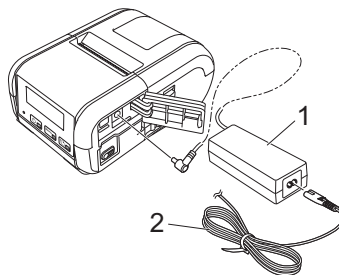

- 1 AC adapter
- 2 AC power cord



### Note

The AC adapter and AC power cord are optional accessories. When purchasing, purchase the adapter and power cord appropriate for the region where the printer will be used.

## Recharging the Battery Using the Car Adapter (Optional)

Connect your printer to your vehicle's 12 V DC power outlet (cigarette lighter or similar) to charge the rechargeable battery.

- 1 Make sure that the rechargeable Li-ion battery is installed in the printer.
- 2 Connect the car adapter to the vehicle's 12 V DC power outlet.
- 3 Open the interface cover and connect the car adapter to your printer.

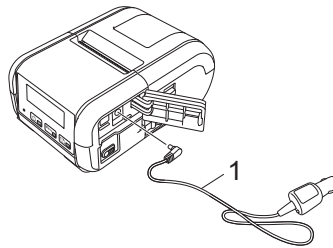

### 1 Car adapter



**Note**

The car adapter is an optional accessory.

## Recharging the Battery Using the Battery Charger (Optional)

When you use an AC power outlet, up to four battery chargers can be connected together for charging at the same time.

For more information, see the operation manual that is included with the battery charger.

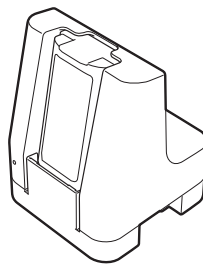

## Stopping Rechargeable Li-ion Battery Charging

---

To stop the battery charging, disconnect the AC adapter or car adapter from the DC connector.

1

## Tips on Using the Rechargeable Li-ion Battery

---

- High density (dark) printing discharges the battery faster than low density printing. You can adjust the print density setting in the Device settings (see *Device Settings* on page 52).
- The battery charging must take place in an environment with a temperature between 32°F and 104°F (0°C and 40°C), otherwise the battery will not be charged. If the charging stops because the environment temperature is too low or too high, place your printer in an environment with a temperature between 32°F and 104°F (0°C and 40°C) and try charging again.
- If you use your printer when both the battery is installed and the AC adapter or car adapter is connected, charging may stop even if the battery is not fully charged.

## Rechargeable Li-ion Battery Characteristics

To ensure the highest performance and longest life from the battery:



- Do not use or store the battery in a location exposed to extreme high or low temperatures as it may deteriorate more quickly.
- Remove the battery when storing your printer for long periods of time.
- Store batteries with less than a 50% charge in a cool dry place out of direct sunlight.
- Recharge the battery every six months if it is stored for long periods of time.
- It is normal and safe for the printer to become warm while charging. Disconnect the charger and stop using the printer if it becomes hot to the touch.
- See the *Product Safety Guide* for other precautions.

## Turning the Printer On or Off

On: Press and hold the  (Power) button until the LCD turns on.

Off: Press and hold the  (Power) button until the message [System Off] appears on the LCD.

## Setting the Language of the LCD

- 1 Press the [Menu], [] button to select the [Settings] menu, and then press the [OK] button.
- 2 Select [ Language], and then press the [OK] button.
- 3 Select a language, and then press the [OK] button.

## Inserting the Paper or Label Roll

### For RJ-2030/2050

- 1 Pull the cover open lever in the direction shown to open the media roll compartment cover.

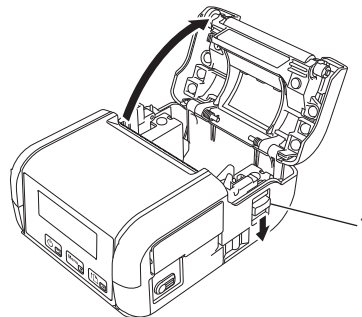

1 Cover open lever

- 2 Insert the media roll into the media roll compartment with the roll feeding from the bottom as shown.

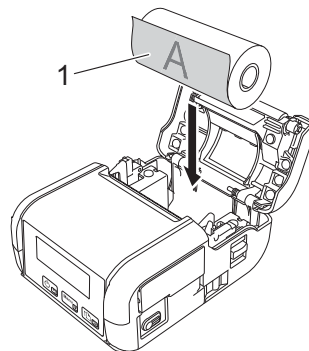

1 Print surface  
(faces outwards on the roll)

**!** Important

The thermal sensitive side must be on the outside of the roll and installed as shown to print correctly.

- 3 Close the media roll compartment by pressing down on the center of the cover until it locks into place.

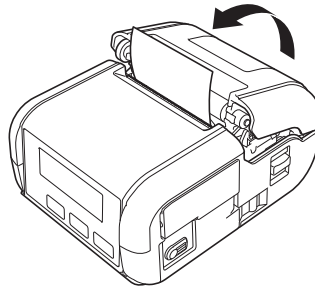

## For RJ-2140/2150

1

- 1 Pull the cover open lever in the direction shown to open the media roll compartment cover.

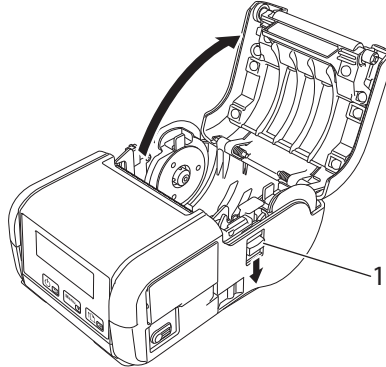

### 1 Cover open lever

- 2 Open the roll guides by lifting the roll guide adjustment lever and pulling both roll guides outwards. Insert the media roll into the media roll compartment with the roll feeding from the bottom as shown.

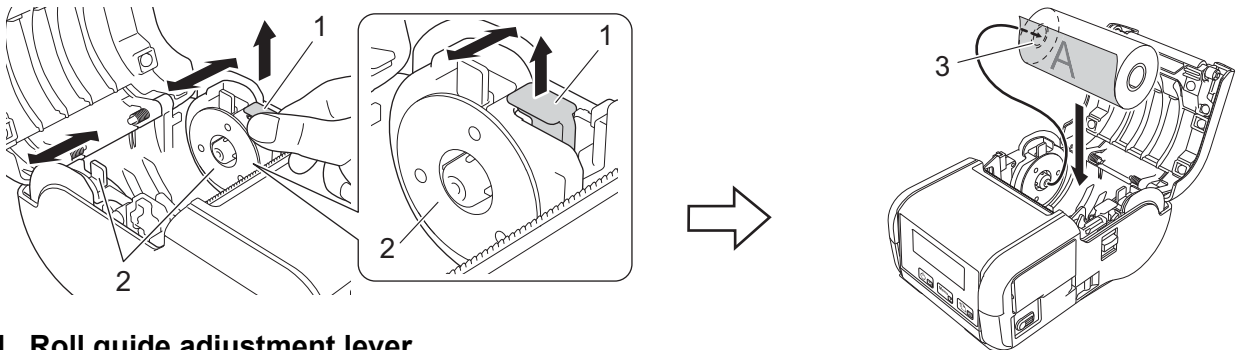

### 1 Roll guide adjustment lever

### 2 Roll guide

### 3 Print surface (faces outwards on the roll)

### ! Important

- Make sure that both roll guides are correctly positioned to prevent the media roll from moving sideways.
- The thermal sensitive side must be on the outside of the roll and installed as shown to print correctly.

- 3 While lifting the roll guide adjustment lever, push in both roll guides to the roll width. Insert the media roll so that it is positioned straight in the media roll compartment.

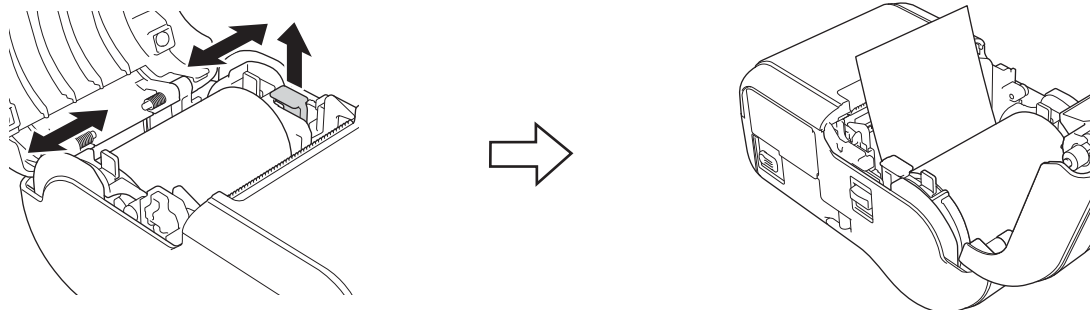

- 4 Close the media roll compartment by pressing down on the center of the cover until it locks into place.

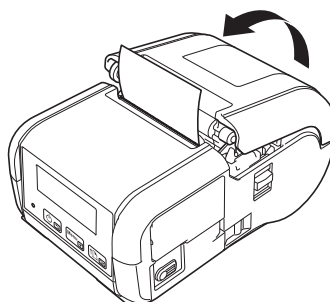

 **Note**

When using die-cut label (RJ-2140/2150 only), press the  (Feed) button after inserting the media roll. The printer will adjust the label to the correct starting position.

 **Important**

Use genuine Brother media.



## Cutting Roll Paper

To cut roll paper, use the printer's tear bar. Pull one edge of the ejected paper up and towards the other edge diagonally.

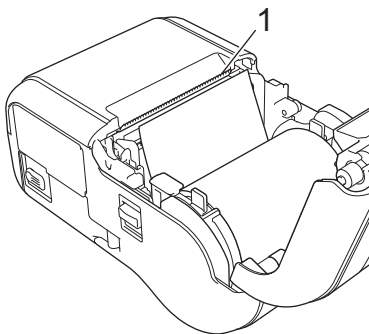

### 1 Tear bar

#### **!** WARNING

The tear bar is sharp. To avoid injury, do not touch the tear bar.

## Removing the Receipt/Label Roll

### For RJ-2030/2050

---

- 1 Pull the cover open lever in the direction shown to open the media roll compartment cover.



- 2 Remove the roll.

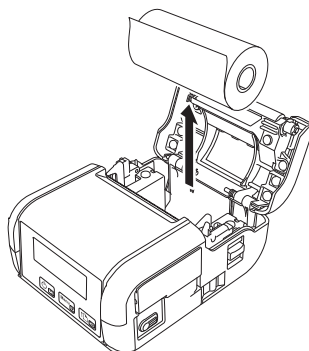

**Note**

---

It is not necessary to adjust the roll holder once it is correctly adjusted to the media roll width.

---

## For RJ-2140/2150

- 1 Pull the cover open lever in the direction shown to open the media roll compartment cover.

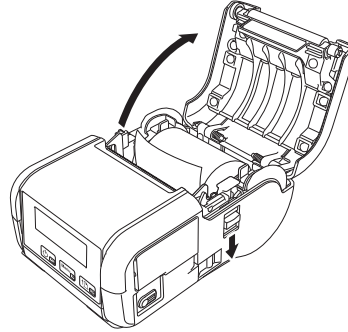

- 2 While pushing the roll release lever, tilt one of the roll guides slightly, and then remove the roll. The roll can be removed without changing the position of the roll guides. Do not forcefully tilt the roll guides too far. Otherwise, the roll guides could break.

### 1 Roll release lever

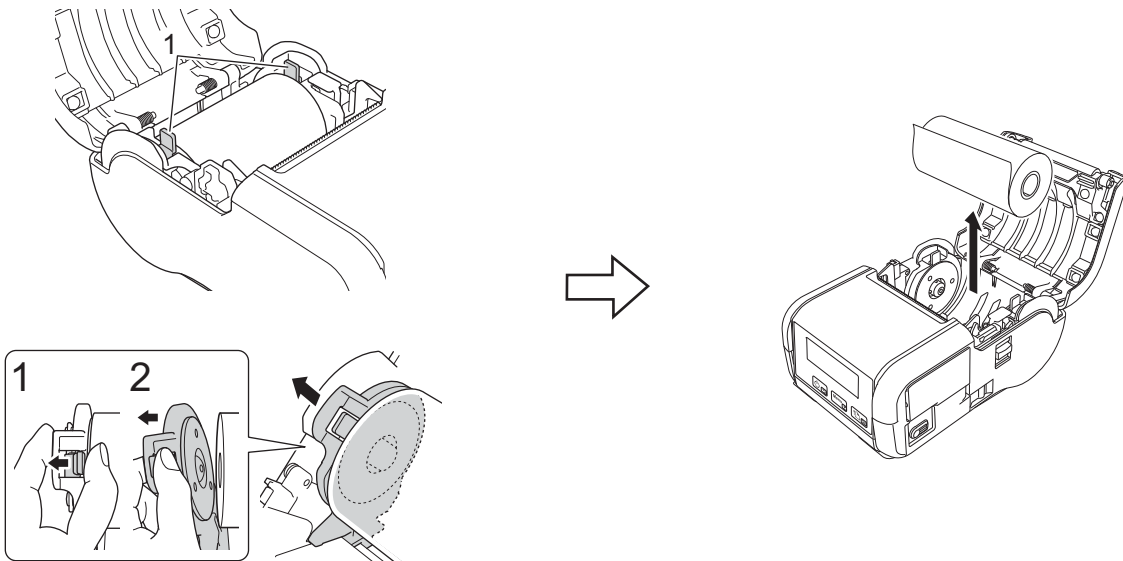

## Attaching the Belt Clip

You can carry the printer on your belt by attaching the included belt clip. Follow the instructions below to attach the clip to the printer and your belt. You can attach the included clip to your printer and secure it to your belt.

- 1 Secure the belt clip to the rear of your printer using the Phillips-head screws as shown:

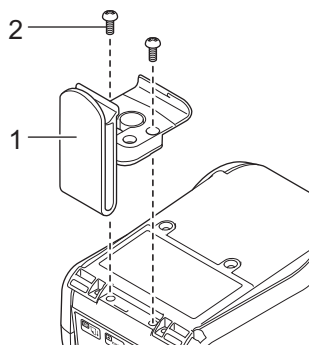

- 1 Belt clip
- 2 Phillips screw

**2** Attach the clip to your belt.

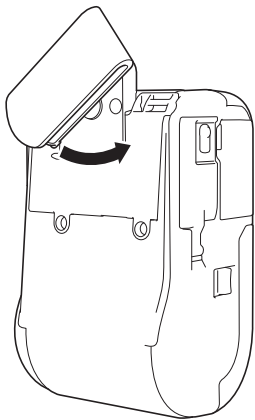
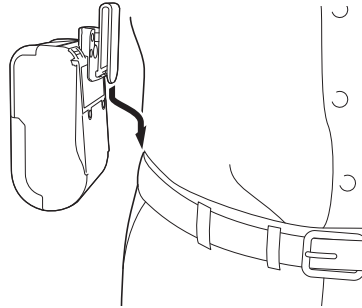

Turn the clip as shown to lock the belt clip.

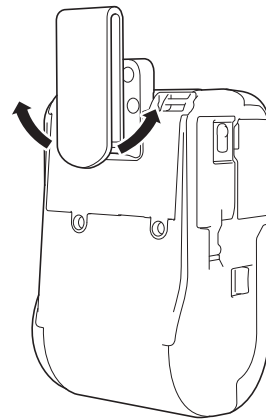

Turn the clip to the left or right to unlock the belt clip.

**!** **Important**

Make sure you attach the belt clip securely to your printer. There is a risk of injury or damage if the belt clip is not attached securely and your printer falls.

## Install Software to Your Computer or Mobile Device

Several printing methods are available depending on your printer model and the computer or mobile device you use to print from.

See the following tables and install other applications on your computer or mobile device as needed.

### Available Software

#### For PCs

To connect the printer to your computer, the printer driver must be installed.

Software		RJ-2030	RJ-2050	RJ-2140	RJ-2150	Features	
1	Printer driver	✓	✓	✓	✓	—	
2	Printer Setting Tool	Communication Settings	✓	✓	✓	✓	Allows you to specify the printer's communication settings and device settings from the computer.
		Device Settings	✓	✓	✓	✓	
	P-touch Template Setting Tool	✓	✓	✓	✓	Allows you to configure the P-touch Template settings. P-touch Template provides functions for inserting data from a device (such as a barcode reader connected to the printer) into text and barcode objects in layouts saved on the printer, useful for printing templates and barcodes.	
3	P-touch Editor	✓	✓	✓	✓	Allows you to design custom documents, store templates, connect to databases, and use a large library of labels and tags.	
4	P-touch Transfer Manager	✓	✓	✓	✓	Allows you to transfer files created with P-touch Editor to a printer and store the files in the printer's memory. You can print them from the printer's memory without connecting to your computer.	
5	Transfer Express	✓	✓	✓	✓	Allows you to transfer documents to the printer.	
6	P-touch Update Software	✓	✓	✓	✓	Allows you to update the firmware and software.	

Software		RJ-2030	RJ-2050	RJ-2140	RJ-2150	Features
7	BRAdmin Professional	—	✓	✓	✓	BRAdmin Professional has more powerful features for managing network printers than BRAdmin Light. You can configure and check the status of your network connected printers, and transfer the template to the printer via a network.
8	BRAdmin Light	—	✓	✓	✓	Allows you to configure the initial settings of network connected printers.
9	BRAgent	—	✓	✓	✓	Allows you to manage printers in different segments*, and send data to the PC on which BRAdmin Professional is installed. * A segment is the area managed by a single router.
10	Web Based Management	—	✓	✓	✓	Allows you to use a standard web browser to manage a printer on your network using HTTP.

**For mobile devices**

Software		RJ-2030	RJ-2050	RJ-2140	RJ-2150	Features
1	Mobile Transfer Express	✓ (Android only)	✓	✓	✓	Mobile Transfer Express is an application that allows you to use a mobile device to transfer files (templates, databases and images) which were prepared using P-touch Transfer Manager (Windows version), to a printer.
2	AirPrint (For Apple device)	—	✓	✓	✓	AirPrint allows you to print from an Apple device (iPad, iPhone, or iPod touch) without installing additional applications.
3	Web Based Management	—	✓	✓	✓	Allows you to use a standard web browser to manage a printer on your network using HTTP.
4	Print Service Plugin (Android only)	✓	✓	✓	✓	Print Service Plugin allows you to print from an Android device without installing additional applications.

A software development kit (SDK) is also available.

Visit the Brother Developer Center ([www.brother.com/product/dev/index.htm](http://www.brother.com/product/dev/index.htm)).

## Installing the Printer Driver and Software (When Using a Computer)

To print from your computer, install the printer driver, P-touch Editor and other applications on your computer.

- 1 Visit our website ([install.brother](http://install.brother)) and download the installer for the software and manuals.
- 2 Double-click the downloaded .exe file and follow the on-screen instructions to proceed with the installation. Select the software you want in the installer's software selection window.



## Connecting the Printer to a Computer or Mobile Device

Refer to the directions for the type or connection method:

■ USB cable connection

See *Connecting Using USB* on page 24.

■ Bluetooth Connection

See *Connecting Using Bluetooth (RJ-2030/2050/2150 Only)* on page 25.

■ Wireless LAN connection

See *Connecting Using Wi-Fi® (RJ-2050/2140/2150 Only)* on page 26.

### Connecting Using USB

---

- 1 Before connecting the USB cable, make sure that the printer is turned off.
- 2 Connect the printer end of the USB cable to the mini-USB port on the side of the printer.
- 3 Connect the other end of the USB cable to the USB port on the computer.
- 4 Turn your printer on.

## Connecting Using Bluetooth (RJ-2030/2050/2150 Only)

---



### Note

Follow the recommendations of the manufacturer of your Bluetooth-equipped devices (computers and mobile devices) or Bluetooth adapter and install any necessary hardware and software.

---

Use this procedure to pair the printer with the computer using the Bluetooth management software.

- 1 Press the [Menu] button to select the [Bluetooth] menu, and then press the [OK] button.  
Select [On].
- 2 Use your Bluetooth management software to discover the printer.  
Bluetooth communication is now available.



### Note

You can also change the printer's network settings using the Communication Settings (see *Communication Settings* on page 37).

---

## Connecting Using Wi-Fi® (RJ-2050/2140/2150 Only)

The following Wi-Fi connection methods are available:

- Wireless Direct
- Infrastructure Mode
- Infrastructure Mode + Wireless Direct
- Ad-hoc Mode (To set the Ad-Hoc mode, use the Printer Setting Tool (see *Changing the Printer Settings* on page 34).) (Not all computers, mobile devices, and operating systems, may support Ad-hoc mode.)
- WPS (Wi-Fi Protected Setup™)

### Wireless Direct

Wireless Direct allows you to connect the printer to your computer or mobile device directly without a Wi-Fi access point/router; the printer serves as a Wi-Fi access point.

- 1 Confirm the Wireless Direct settings of the printer.
  - Using your printer
    - 1 On your printer, press the [Menu], [▼] button to select the [WLAN] menu, and then press the [OK] button.
    - 2 Press the [▼] button to select the [Mode] menu, and then press the [OK] button.
    - 3 Select [Direct], and then press the [OK] button. The Wireless Direct icon appears on the LCD.
  - For computers
 

Connect the printer and computer with a USB cable. Start the Printer Setting Tool on your computer, and click the [Communication Settings] button. Confirm that [Wireless Direct] is selected for [Selected Interface] in the [General] tab.

See *Communication Settings* on page 37 for more information on the Communication Settings.
- 2 On your printer, press the [Menu], [▼] button to select the [WLAN] menu, and then press the [OK] button. Set [On/Off] to [On].
- 3 Use your computer or mobile device to select the SSID of your printer ("DIRECT-\*\*\*\*\*\_RJ-XXXX"). If required, enter the password ("205\*\*\*\*\*" for RJ-2050, "214\*\*\*\*\*" for RJ-2140, or "215\*\*\*\*\*" for RJ-2150). \*\*\*\*\* is the last five digits of the serial number.



#### Note

- You can change the printer's network settings using the Printer Setting Tool (see *Changing the Printer Settings* on page 34).
- The Printer Setting Tool also allows you to apply the network settings changes to multiple printers. (See *Applying Setting Changes to Multiple Printers* on page 51.)
- You can find the serial number label on the back of the printer.  
You can also confirm the serial number by printing the printer information (see *Printing the Printer Information* on page 71).
- You cannot connect to the Internet via Wi-Fi while using Wireless Direct. To use the Internet, connect using Infrastructure Mode.







## Infrastructure Mode

Infrastructure Mode allows you to connect the printer to a computer or mobile device via a Wi-Fi access point/router.

### ■ Before You Begin

First you must configure the Wi-Fi settings of your printer to communicate with your Wi-Fi access point/router. After the printer is configured, computers or mobile devices on your network will have access to the printer.



### ❗ Important

- If you are going to connect the printer to your network, we recommend that you contact your system administrator prior to installation. You must confirm your Wi-Fi settings before you proceed with this installation.
- To configure the Wi-Fi settings again, or if the status of the Wi-Fi connection for your printer is unknown, reset the Wi-Fi settings of the printer.
  - 1 Press and hold the  (Power) button to turn the printer off.
  - 2 Press and hold the  (Feed) button and the  (Power) button for about three seconds. The LED indicator starts blinking in green.
  - 3 While pressing the  (Power) button, press the  (Feed) button twice.
  - 4 Release the  (Power) button.

### Note

To achieve the best results with normal everyday document printing, use the printer as close to the Wi-Fi access point/router as possible with minimal obstructions. Large objects and walls between the two devices as well as interference from other electronic devices can affect the data transfer speed of your documents.

### ■ Connecting the printer to your Wi-Fi access point/router

- 1 First, write down the SSID (network name) and password (network key) of your Wi-Fi access point/router.
- 2 Connect the printer and computer with a USB cable.
- 3 On your printer, press the [Menu], [] button to select the [WLAN] menu, and then press the [OK] button.  
Set [On/Off] to [On].
- 4 Configure the Infrastructure Mode settings of the printer.
  - Using your printer
    - 1 On your printer, press the [Menu], [] button to select the [WLAN] menu, and then press the [OK] button.
    - 2 Press the [] button to select the [Mode] menu, and then press the [OK] button.
    - 3 Select [Infrastructure], and then press the [OK] button.

■ For computers

Start the Printer Setting Tool on your computer, and click the **[Communication Settings]** button. Select **[Wireless LAN]** for **[Selected Interface]** in the **[General]** tab, and select **[Infrastructure]** for **[Communication Mode]** in **[Wireless Settings]** in the **[Wireless LAN]** tab.

See *Communication Settings* on page 37 for more information on the Communication Settings.

- 5 Start the Printer Setting Tool on your computer, and click the **[Communication Settings]** button. Select **[Wireless Settings]** in the **[Wireless LAN]** tab. Enter the SSID that you wrote down, or click **[Search]** and select the SSID from the displayed list.
- 6 Enter the password as **[Passphrase]**.



**Note**

The required information depends on the authentication method and encryption mode; enter only the information relevant to your network environment.

- 7 Click **[Apply]**.  
When the connection between the printer and your Wi-Fi access point/router is established, the  (WLAN) icon appears on your printer's LCD. Computers and mobile devices that are on the same network as the printer will have access to the printer.



**Note**

- To change any other network settings, use the Printer Setting Tool (see *Changing the Printer Settings* on page 34).
- To connect your mobile device to the Wi-Fi access point/router, select the SSID and enter the password of the Wi-Fi access point/router to establish the connection between the mobile device and Wi-Fi access point/router.

## Infrastructure Mode + Wireless Direct

Infrastructure Mode and Wireless Direct can be used at the same time.

■ Using your printer

- 1 On your printer, press the **[Menu]**, **[▼]** button to select the **[WLAN]** menu, and then press the **[OK]** button.
- 2 Press the **[▼]** button to select the **[Mode]** menu, and then press the **[OK]** button.
- 3 Select **[Direct/Infra]**, and then press the **[OK]** button.

■ For computers

- 1 Start the Printer Setting Tool on your computer, and click the **[Communication Settings]** button.
- 2 Select **[Infrastructure and WirelessDirect]** for **[Selected Interface]** in the **[General]** tab. See *Communication Settings* on page 37 for more information on the Communication Settings.

## WPS (Wi-Fi Protected Setup™)

If your Wi-Fi access point/router supports WPS, settings and connections can be configured quickly.

- 1 First, confirm that your Wi-Fi access point/router has the WPS symbol.



- 2 Place your printer within the range of your Wi-Fi access point/router. The range may differ depending on your environment. See the instructions provided with your Wi-Fi access point/router.
- 3 Press the WPS button on your Wi-Fi access point/router.
- 4 On your printer, press the [Menu], [▼] button to select the [WLAN] menu, and then press the [OK] button.
- 5 Press the [▼] button to select the [WPS] menu, and then press the [OK] button.
- 6 Select [Start], and then press the [OK] button.

When the connection is established, the WLAN icon appears on your printer's LCD. Computers and mobile devices that are on the same network as the printer will have access to the printer.



### Note

---

Your printer will try to connect using WPS for two minutes. If the [Menu] button is pressed during that time, the printer will continue trying to connect for an additional two minutes.

---

# LCD

## LCD Settings

You can specify the LCD settings either by using the printer, or by using the Printer Setting Tool on a computer connected to the printer. For more information about connecting a computer and specifying settings, see *Changing the Printer Settings* on page 34.

### Specifying Settings from the Printer

Press the [Menu], [▼] button to select a menu option, and then press the [OK] button. Press [▼] to select an option, and then press the [OK] button.



- 1 The currently selected option is highlighted.
- 2 The scroll bar indicates the first parameter with the up arrow, and the last parameter with the down arrow. If the last parameter is selected, pressing [▼] scrolls to the first parameter.

### Displaying the Media Information

- 1 Press the [Menu], [▼] button to select the [Media] menu, and then press the [OK] button.

### Setting the LCD Contrast

- 1 Press the [Menu], [▼] button to select the [Settings] menu, and then press the [OK] button.
- 2 Select [LCD Contrast], and then press the [OK] button. Select the option, and then press the [OK] button.

### Setting the Beeper

Select whether the printer beeps when an operation button is pressed.

- 1 Press the [Menu], [▼] button to select the [Settings] menu, and then press the [OK] button.
- 2 Select [Beeper], and then press the [OK] button. Select the option, and then press the [OK] button.

## Updating the Printer (RJ-2050/2140/2150 only)

Connect to the FTP server and download the templates, databases, and other updated files. Set the information of the FTP server in advance using **[Communication Settings]** in the Printer Setting Tool. For more information, see *Communication Settings* on page 37.

This item appears when the FTP server is set and updated files are available.

- 1 Press the [Menu], [▼] button to select the [Update] menu, and then press the [OK] button.
- 2 Select [Start], and then press the [OK] button.  
When the update starts, [Receiving] or [Downloading] appears on the LCD.



## Printing from Computers

### Printing with the Printer Driver

---

- 1 Open the document you want to print.
- 2 Turn the printer on.
- 3 Connect the printer to a computer using USB, Bluetooth or Wi-Fi (see *Connecting the Printer to a Computer or Mobile Device* on page 24).
- 4 Insert the media roll.

**Note**

If necessary, change the printer settings in the printer driver's dialog box, or in the Printer Setting Tool (see *Changing the Printer Settings* on page 34).

---

- 5 Print from the application.  
The message [Printing] appears on the LCD. When printing is finished, the mode you selected before printing started returns.
- 6 Turn the printer off.

**Note**

- When turning the printer off, keep the battery installed until the LCD turns off.
  - To print a JPEG image without using the printer driver, see *JPEG Printing* on page 73.
- 

### Making Prints Lighter or Darker

You can make prints lighter or darker by adjusting the print density setting in the Device settings (see *Device Settings* on page 52).

When using the battery, changing the print density setting may result in slight changes in printing speed and the number of pages that can be printed on a single charge.

### Setting Printer Driver Options

---

You can configure various settings such as paper size and number of copies, in the printer driver screen.

**Note**

You can also use the Printer Setting Tool (see *Changing the Printer Settings* on page 34) to configure advanced settings.

---

## Printing from Mobile Device

You can print from your mobile device using AirPrint (RJ-2050/2140/2150 only).

For more information, see the *AirPrint Guide*. Visit your model's Manuals page on the Brother support website at [support.brother.com](http://support.brother.com) to download the guide.

A software development kit (SDK) is also available.

Visit the Brother Developer Center ([www.brother.com/product/dev/index.htm](http://www.brother.com/product/dev/index.htm)).

## Printer Setting Tool

Using the Printer Setting Tool, you can specify the printer's communication settings, device settings, P-touch Template settings and Paper Size Setup from a Windows computer.



### Note

The Printer Setting Tool is installed automatically when you use the initial installer to install the printer driver. For more information, see *Install Software to Your Computer or Mobile Device* on page 21.



### Important

The Printer Setting Tool is available only with compatible printers.

## Before Using the Printer Setting Tool

- Make sure a fully-charged battery is installed.
- Make sure the printer driver has been installed correctly and you can print.
- Connect this printer to a computer with a USB cable. Settings cannot be specified using Wi-Fi using this tool.

## Using the Printer Setting Tool

- 1 Connect the printer you want to configure to the computer.
- 2 Start the Printer Setting Tool.
  - **For Windows Vista / Windows 7 / Windows Server 2008 / Windows Server 2008 R2:**  
From the Start button, click [All Programs] - [Brother] - [Label & Mobile Printer] - [Printer Setting Tool].
  - **For Windows 8 / Windows 8.1 / Windows Server 2012 / Windows Server 2012 R2:**  
Click the [Printer Setting Tool] icon on the [Apps] screen.
  - **For Windows 10:**  
From the Start button, (select [All apps], and then) click [Brother] - [Label & Mobile Printer] - [Printer Setting Tool].  
The main window appears.

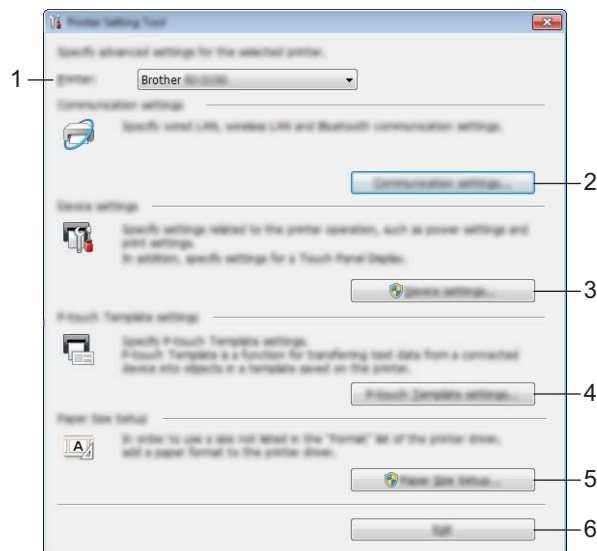

### 1 Printer

Lists the connected printers.

### 2 Communication settings

Specify wireless LAN (RJ-2050/2140/2150 only) and Bluetooth (RJ-2030/2050/2150 only) communication settings.

### 3 Device settings

Specifies printer device settings, such as power settings and printer settings. Settings can also be specified for the LCD.

### 4 P-touch Template settings

Specifies P-touch Template settings.

For more information on P-touch Template, download the *P-touch Template Manual/Raster Command Reference* (English only) from the Brother support website at [support.brother.com](http://support.brother.com)

## 5 Paper Size Setup

Add media information and settings to the printer driver to use a size not listed in the **[Paper Size]** list of the printer driver.

### ! Important

---

To open **[Paper Size Setup]**, you must be logged on with administrator rights.

---

## 6 Exit

Closes the window.

- 3 Check that the printer you want to configure appears next to **[Printer]**. If a different printer appears, select the printer you want from the drop-down list.
- 4 Select the setting you want to change, and then specify or change the settings in the dialog box. For more information on the settings dialog boxes, see *Communication Settings* on page 37, *Device Settings* on page 52, *P-touch Template Settings* on page 62, or *Paper Size Setup* on page 65.
- 5 Click **[Apply]** - **[Exit]** in the settings dialog box to apply the settings to the printer.
- 6 Click **[Exit]** in the main window to finish specifying settings.

### ! Important

---

Use the Printer Setting Tool to configure the printer only when the printer is in standby. The printer may malfunction if you try to configure it while it is handling a job.

---

# Communication Settings

With [**Communication settings**] in the Printer Setting Tool, the printer communication information can be specified or changed when connecting the printer and computer with a USB cable or via a Bluetooth connection (RJ-2030/2050/2150 only). Not only can you change the communication settings for one printer, but you can also apply the same settings to multiple printers.

## Settings Dialog Box

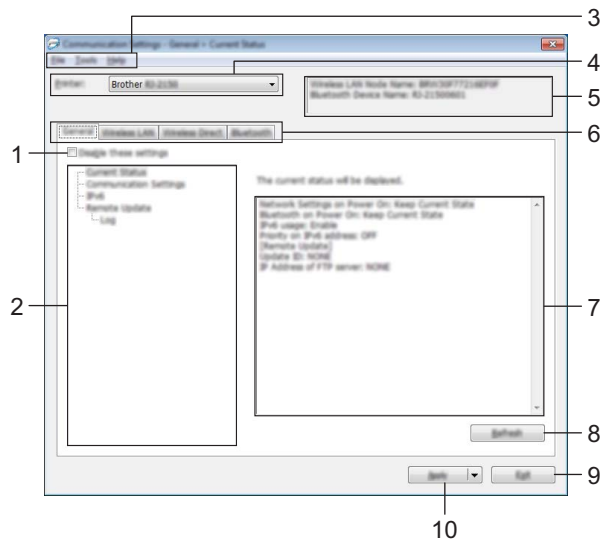

### 1 Disable these settings

When this check box is selected,  appears in the tab, and the settings can no longer be specified or changed.

Settings in a tab where  appears will not be applied to the printer even if [**Apply**] is clicked. In addition, the settings in the tab will not be saved or exported when the [**Save in Command File**] or [**Export**] command is executed.

To apply the settings to the printer or save or export them, make sure you clear the check box.

### 2 Items

When [**Current Status**] is selected, the current settings appear in the settings display/change area. Select the item for the settings that you want to change.

### 3 Menu Bar

### 4 Printer

Lists the connected printers.

### 5 Node Name

Displays the node name (nodes can be renamed). (See 7 *Change Node Name/Bluetooth Device Name in Menu Bar* on page 39.)

## 6 Settings Tabs

Contains settings that may be specified or changed.

If  appears in the tab, the settings in that tab will not be applied to the printer.

## 7 Settings Display/Change Area

Displays the current settings for the selected item.

## 8 Refresh

Updates the displayed settings with the most recent information.

## 9 Exit

Exits [**Communication settings**], and returns to the main window of the Printer Setting Tool.

### ! Important

---

Settings are not applied to printers if [**Exit**] is clicked without clicking the [**Apply**] button after changing settings.

---

## 10 Apply

Applies the settings to the printer.

To save the specified settings in a command file, select [**Save in Command File**] from the drop-down list. The saved command file can be used with the mass storage mode to apply the settings to a printer. (See *Mass Storage Mode* on page 72.)

### ! Important

---

Clicking [**Apply**] applies all settings in all tabs to the printer.

If the [**Disable these settings**] check box is selected, the settings in that tab are not applied.

---

## Menu Bar

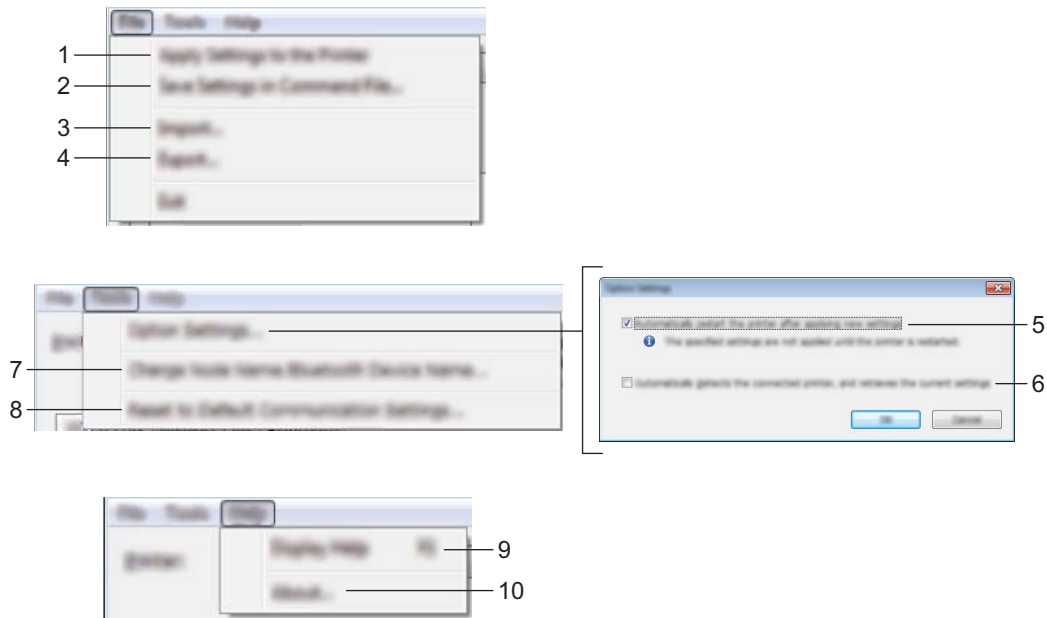

### 1 Apply Settings to the Printer

Applies the settings to the printer.

### 2 Save Settings in Command File

Saves the specified settings in a command file. The file extension is .bin.

The saved command file can be used with the mass storage mode to apply the settings to a printer. (See *Mass Storage Mode* on page 72.)



### Note

If the [**Disable these settings**] check box is selected, the settings in that tab are not saved.

### ! Important

- The following information is not saved with the command file:
  - Node name
  - IP address, subnet mask and default gateway (when the IP address is set to **[STATIC]**)
- The saved communication settings commands are intended to be used only for applying settings to a printer. To apply the settings to the printer using this command file, use the mass storage mode.
- Saved command files contain authentication keys and passwords. Take necessary measures to protect saved command files, for example, save them in a location that cannot be accessed by other users.
- Do not send the command file to a different printer model.



### 3 Import

#### ■ Import from the current computer wireless settings

Imports the settings from the computer.



#### Note

- When importing the computer wireless settings, administrator privileges for the computer are needed.
- Only personal security authentication settings (open system, public key authentication and WPA/WPA2-PSK) can be imported. Enterprise security authentication (such as LEAP and EAP-FAST), WPA2-PSK (TKIP) and WPA-PSK (AES) settings cannot be imported.
- If multiple wireless LANs are enabled for the computer you use, the first wireless settings (only personal settings) that are detected will be considered for the import data.
- Only the settings (communication mode, SSID, authentication method, encryption mode and authentication key) from the **[Wireless LAN]** tab - **[Wireless Settings]** pane can be imported.

#### ■ Select a Profile to import

Imports the exported file and applies the settings to a printer.

Click **[Browse]** and select the file you want to import. The settings in the selected file appear in the settings display/change area.



#### Note

- All settings (such as wireless settings or TCP/IP settings) can be imported, except for node names.
- Only profiles that are compatible with the selected printer can be imported.
- If the imported profile's IP address is set to **[STATIC]**, change the IP address of the imported profile, if needed, so that it does not duplicate the IP address of an existing configured printer on the network.

### 4 Export

Saves the current settings in a file.



#### Note

If the **[Disable these settings]** check box is selected, the settings in that tab are not saved.



#### Important

Exported files are not encrypted.

### 5 Automatically restart the printer after applying new settings

If this check box is selected, the printer automatically restarts after communication settings are applied.

If this check box is cleared, you must restart the printer manually.



#### Note

When configuring multiple printers, you can reduce the time needed to change settings by clearing this check box. In this case, we recommend selecting this check box when configuring the first printer so that you can confirm that each setting is operating as intended.

## 6 Automatically detects the connected printer, and retrieves the current settings

If this check box is selected and a printer is connected to the computer, the printer is automatically detected and the printer's current settings are displayed in the [**Current Status**] pane.



### Note

If the model of the connected printer is different from that of the printer shown in the [**Printer**] drop-down list, the settings available on all tabs change to match the connected printer.

## 7 Change Node Name/Bluetooth Device Name

Allows renaming a node.

## 8 Reset to Default Communication Settings

Returns the communication settings to their factory settings.

## 9 Display Help

Displays the Help.

## 10 About

Displays the version information.

## General Tab

### Communication Settings

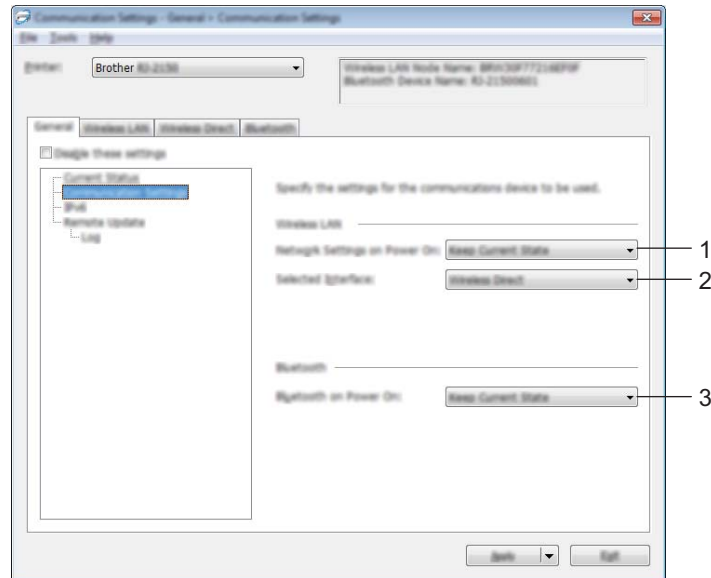

#### 1 Network Settings on Power On

Specifies the conditions for connecting via Wi-Fi when the printer is turned on. Select **[On by Default]**, **[Off by Default]** or **[Keep Current State]**.

#### 2 Selected Interface

Select **[Infrastructure or Ad-hoc]**, **[Infrastructure and Wireless Direct]** or **[Wireless Direct]**.

#### 3 Bluetooth on Power On

Specifies the conditions for connecting via Bluetooth when the printer is turned on. Select **[On by default]**, **[Off by default]** or **[Keep Current State]**.

## IPv6

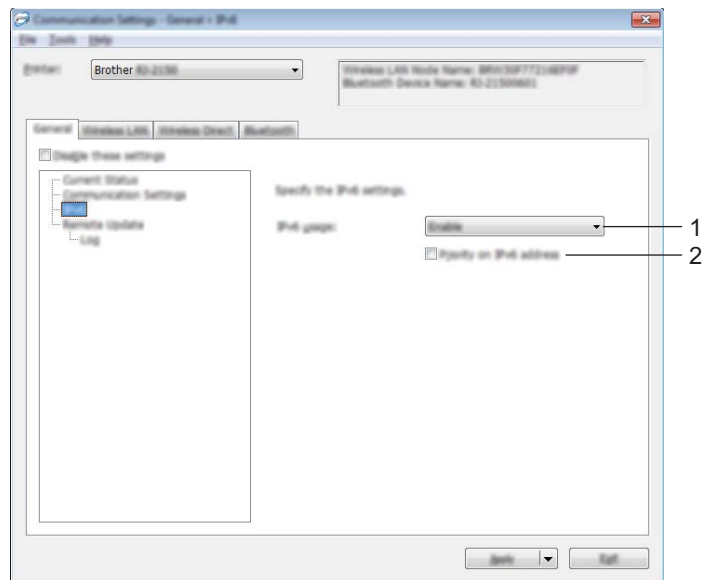

### 1 IPv6 usage

Select [Enable] or [Disable].

### 2 Priority on IPv6 address

Select to give priority to an IPv6 address.

## Remote Update (RJ-2050/2140/2150 only)

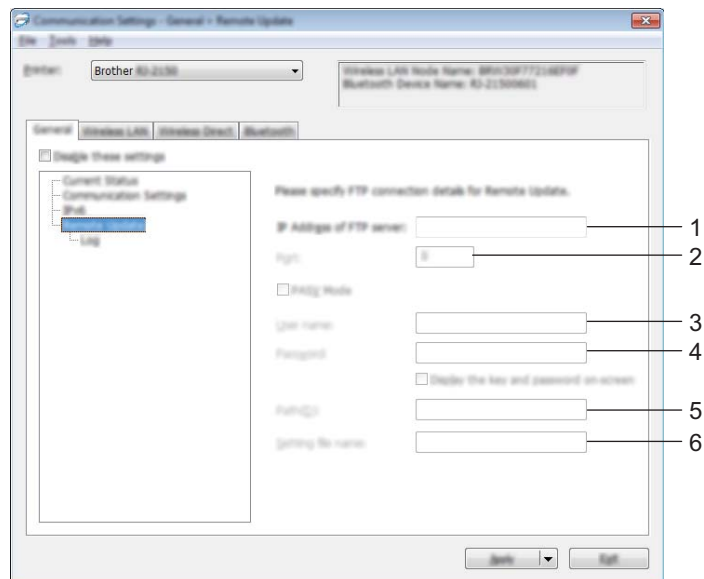

### 1 IP Address of FTP server

Type the FTP server address.

**2 Port**

Specifies the port number used to access the FTP server.

**3 User name**

Type a user name that has permission to login to the FTP server.

**4 Password**

Type the password associated with the user name you entered in the Username field.

**5 Path**

Type the path to the folder on the FTP server where you want to download the update file from.

**6 Setting file name**

Specifies the update file name on the FTP server.

■ **Log**

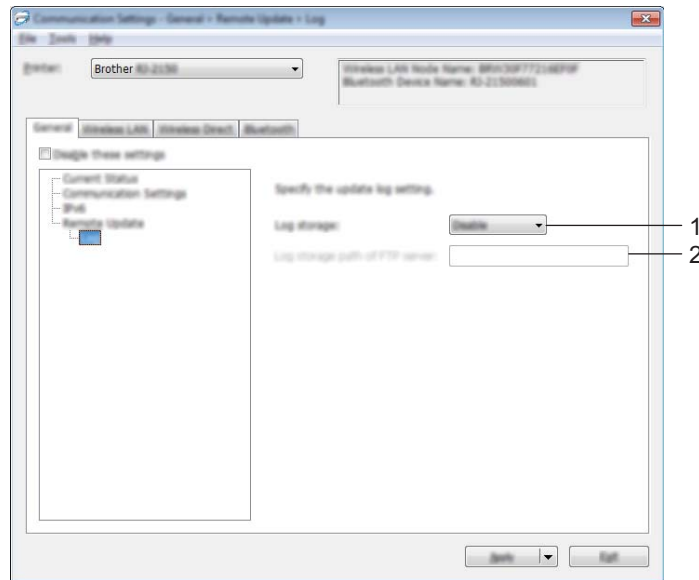

**1 Log storage**

Select whether to export the update log to the FTP server.

**2 Log storage path of FTP server**

Type the path to the folder on the FTP server where you want to export the log data.

## Wireless LAN Tab (RJ-2050/2140/2150 Only)

### TCP/IP (Wireless)

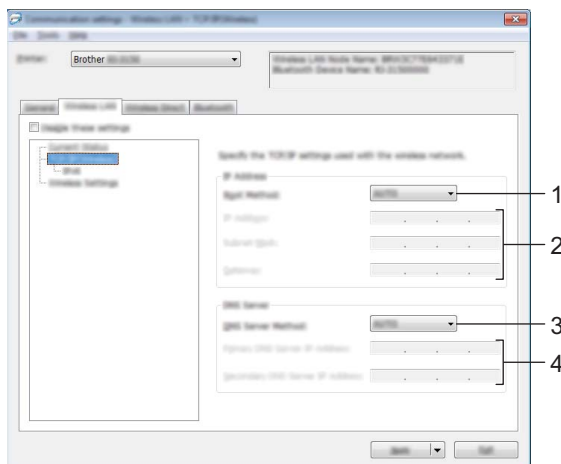

#### 1 Boot Method

Select [AUTO], [BOOTP], [DHCP], [RARP] or [STATIC].

#### 2 IP Address/Subnet Mask/Gateway

Specify the various values.

You can type these settings only when the IP address is set to [STATIC].

#### 3 DNS Server Method

Select [AUTO] or [STATIC].

#### 4 Primary DNS Server IP Address/Secondary DNS Server IP Address

You can type these settings only when the DNS server is set to [STATIC].

## IPv6

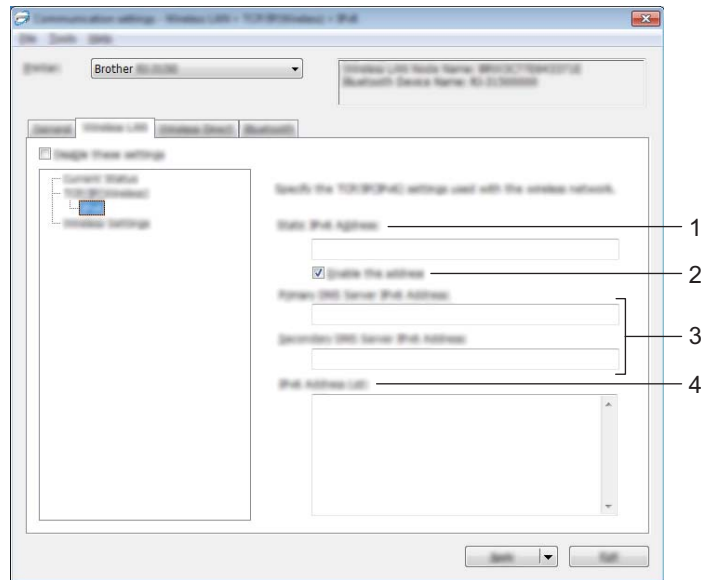

### 1 Static IPv6 Address

Specifies a permanent IPv6 address.

### 2 Enable this address

Enables the specified static IPv6 address.

### 3 Primary DNS Server IPv6 Address/Secondary DNS Server IPv6 Address

Specifies the DNS server IPv6 addresses.

### 4 IPv6 Address List

Displays the list of IPv6 addresses.

## Wireless Settings

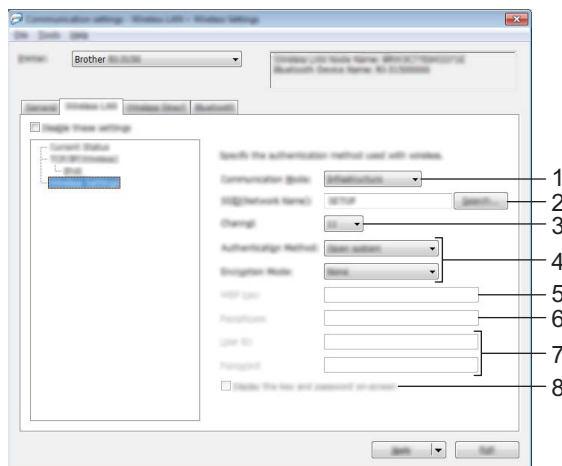

### 1 Communication Mode

Select [Infrastructure] or [Ad-hoc].

### 2 SSID (Network Name)

Clicking [Search] displays the available SSID selections in a separate dialog box.

### 3 Channel

Lists available channels.



### Note

- This setting is valid only in Ad-Hoc mode.
- Not all computers, mobile devices, and operating systems, may support Ad-hoc mode.

### 4 Authentication Method/Encryption Mode

The supported encryption modes for the authentication methods are as shown in *Communication Modes and Authentication Methods/Encryption Modes* on page 48.

### 5 WEP Key

You can specify a setting only when WEP is selected as the encryption mode.

### 6 Passphrase

You can specify a setting only when WPA/WPA2-PSK is selected as the authentication method.

### 7 User ID/Password

You can specify settings only when LEAP, EAP-FAST, PEAP, EAP-TTLS or EAP-TLS is selected as the authentication method. In addition, with EAP-TLS, it is not necessary to register a password, but a client certificate must be registered. To register a certificate, connect to the printer from a web browser, and then specify the certificate. For more information on using a web browser, see *Web Based Management* on page 120.

### 8 Display the key and password on-screen

If this check box is selected, keys and passwords are displayed in plain (non-encrypted) text.



## Communication Modes and Authentication Methods/Encryption Modes

- When [Communication Mode] is set to [Ad-hoc]

Authentication Method	Encryption Mode
Open System	None / WEP

- When [Communication Mode] is set to [Infrastructure]

Authentication Method	Encryption Mode
Open System	None / WEP
Shared Key	WEP
WPA/WPA2-PSK	TKIP+AES / AES
LEAP	CKIP
EAP-FAST/NONE	TKIP+AES / AES
EAP-FAST/MS-CHAPv2	TKIP+AES / AES
EAP-FAST/GTC	TKIP+AES / AES
PEAP/MS-CHAPv2	TKIP+AES / AES
PEAP/GTC	TKIP+AES / AES
EAP-TTLS/CHAP	TKIP+AES / AES
EAP-TTLS/MS-CHAP	TKIP+AES / AES
EAP-TTLS/MS-CHAPv2	TKIP+AES / AES
EAP-TTLS/PAP	TKIP+AES / AES
EAP-TLS	TKIP+AES / AES

### ! Important

To specify higher level security settings:

When performing certificate verification with EAP-FAST, PEAP, EAP-TTLS or EAP-TLS authentication methods, the certificate cannot be specified from the Printer Setting Tool. After the printer is configured to connect to the network, specify the certificate by accessing the printer from a web browser.

For more information on using a web browser, see *Web Based Management* on page 120.

## Wireless Direct Tab (RJ-2050/2140/2150 Only)

### Wireless Direct Settings

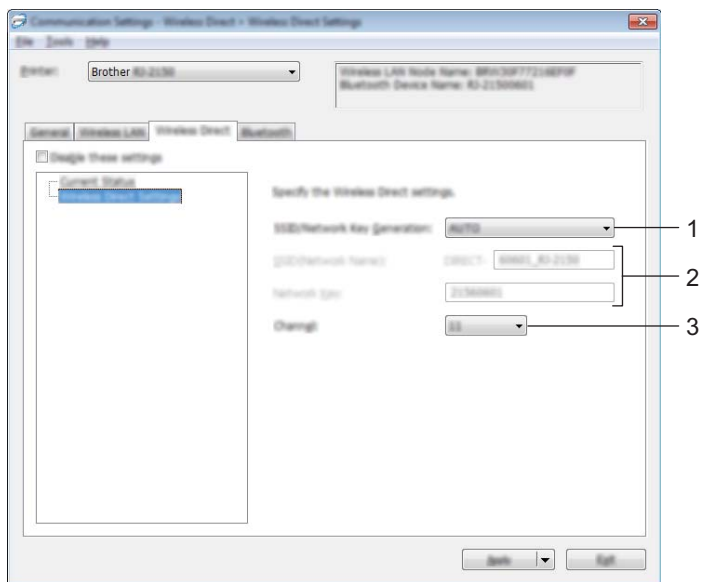

#### 1 SSID/Network Key Generation

Select [AUTO] or [STATIC].

#### 2 SSID (Network Name)/Network Key

Specifies the SSID (25 ASCII characters or fewer) and the network key (63 characters or fewer) you want to use in the Wireless Direct mode.

You can only specify a setting when [STATIC] is selected for [SSID/Network Key Generation].



#### Note

The factory default SSID is "DIRECT-\*\*\*\*\*\_RJ-XXXX" and password is "205\*\*\*\*\*" for RJ-2050, "214\*\*\*\*\*" for RJ-2140, or "215\*\*\*\*\*" for RJ-2150.

\*\*\*\*\* is the last five digits of the serial number.

(You can find the serial number label on the back of the printer.)

#### 3 Channel

Specifies the channel to use in the Wireless Direct mode.

## Bluetooth Tab (RJ-2030/2050/2150 Only)

### Bluetooth Settings

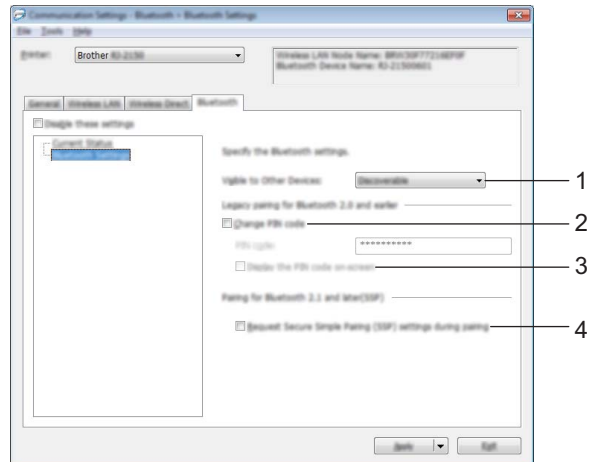

#### 1 Visible to Other Devices

Allows the printer to be “discovered” by other Bluetooth devices.

Available settings: **[Discoverable]**, **[Not Discoverable]**

#### 2 Change PIN code

If this check box is selected, you can change the PIN code.

#### 3 Display the PIN code on-screen

If this check box is selected, your computer displays the PIN by default.

#### 4 Request Secure Simple Pairing (SSP) settings during pairing

If this check box is selected, pairing can be performed using the printer buttons for devices that are compliant with Bluetooth 2.1 or later.

## Applying Setting Changes to Multiple Printers

---

- 1 After applying settings to the first printer, disconnect the printer from the computer, and then connect the second printer to the computer.
- 2 Select the newly connected printer from the **[Printer]** drop-down list.

 **Note**

If the **[Automatically detects the connected printer, and retrieves the current settings]** check box in the **[Option Settings]** dialog box is selected, the printer connected with the USB cable is automatically selected.

For more information, see *Communication Settings* on page 37.

---

- 3 Click **[Apply]**.  
The same settings that were applied to the first printer are applied to the second printer.

 **Note**

We recommend selecting the **[Automatically restart the printer after applying new settings]** check box when configuring the first printer so that you can confirm that a connection with the wireless access point/router can be correctly established with the settings. For more information, see *Communication Settings* on page 37.

---

- 4 Repeat steps 1 – 3 for all printers whose settings you want to change.

 **Important**

If the IP address is set to **[STATIC]**, the printer's IP address will also be changed to the same address as the first printer.  
Change the IP address if needed.

---

 **Note**

To save the current settings in a file, click **[File]** - **[Export]**.

The same settings can be applied to another printer by clicking **[File]** - **[Import]**, then selecting the exported settings file. (See *Communication Settings* on page 37.)

---

## Device Settings

With [**Device settings**] in the Printer Setting Tool, printer settings can be specified or changed when connecting the printer and computer with a USB cable or via a Bluetooth connection (RJ-2030/2050/2150 only). Not only can you change the device settings for one printer, but you can also apply the same settings to multiple printers.

When printing from a computer application, various print settings can be specified from the printer driver; however, by using [**Device settings**] in the Printer Setting Tool, more advanced settings can be specified.

When [**Device settings**] is opened, the printer's current settings are retrieved and displayed. If the current settings could not be retrieved, the previous settings are displayed. If the current settings could not be retrieved and previous settings have not been specified, this tool's factory settings are displayed.

## Settings Dialog Box

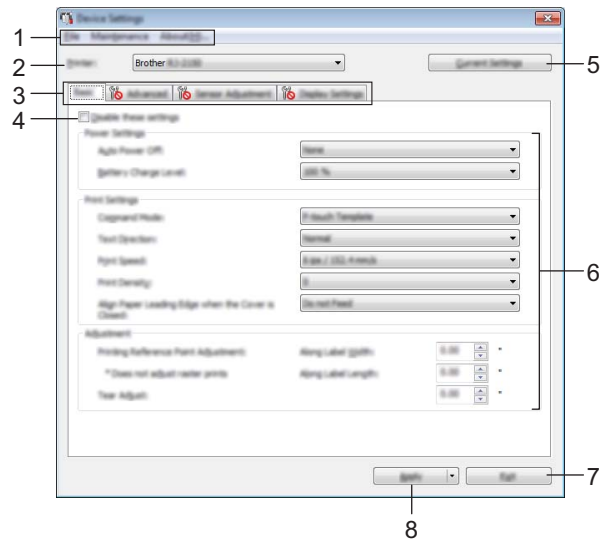

### 1 Menu Bar

Select a command contained in each menu from the list.

### 2 Printer

Specifies the printer whose device settings are to be configured.

If only one printer is connected, it is unnecessary to make a selection because only that printer will appear.

### 3 Settings Tabs

Contains settings that may be specified or changed.



### Note

If  appears in the tab, the settings in that tab cannot be specified or changed. In addition, the settings in the tab will not be applied to the printer even if [**Apply**] is clicked. The settings in the tab will also not be saved or exported when the [**Save in Command File**] or [**Export**] command is executed.

#### 4 Disable these settings

When this check box is selected,  appears in the tab, and the settings can no longer be specified or changed.

Settings in a tab where  appears will not be applied to the printer even if **[Apply]** is clicked. In addition, the settings in the tab will not be saved or exported when the **[Save in Command File]** or **[Export]** command is executed.

#### 5 Current Settings

Retrieves the settings from the currently connected printer and displays them in the dialog box. Settings will also be retrieved for parameters on tabs with .

#### 6 Parameters

Displays the current settings.

#### 7 Exit

Exits **[Device settings]**, and returns to the main window of the Printer Setting Tool.

#### 8 Apply

Applies the settings to the printer.

To save the specified settings in a command file, select **[Save in Command File]** from the drop-down list. The saved command file can be used with the mass storage mode to apply the settings to a printer. (See *Mass Storage Mode* on page 72.)

## Menu Bar

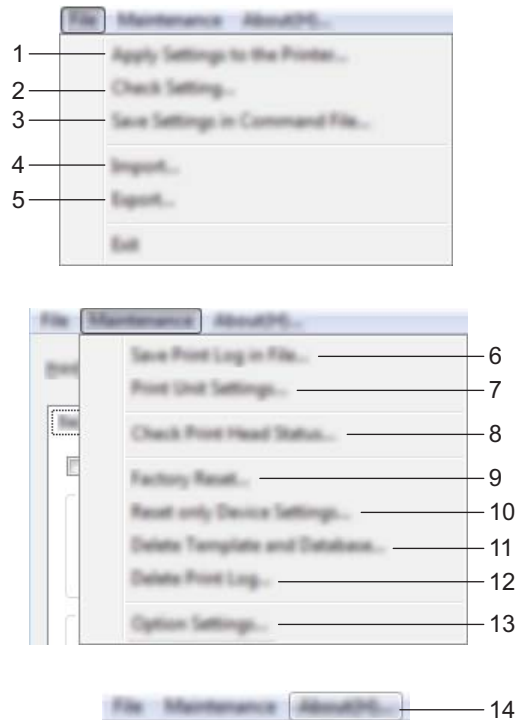

### 1 Apply Settings to the Printer

Applies the settings to the printer.

Performs the same operation as when **[Apply]** is clicked.

### 2 Check Setting

Displays the current settings.

### 3 Save Settings in Command File

Saves the specified settings in a command file.

Performs the same operation as when **[Save in Command File]** is selected from the **[Apply]** drop-down list.

### 4 Import

Imports the exported file.

### 5 Export

Saves the current settings in a file.

### 6 Save Print Log in File

Saves the print log in a file in the CSV format.

## 7 Print Unit Settings

Prints a report containing firmware version and device setting information.

You can also print this report using the  (Feed) button (see *Printing the Printer Information* on page 71).

## 8 Check Print Head Status

Checks the print head for broken lines.

## 9 Factory Reset

Resets all printer settings to factory settings.

## 10 Reset only Device settings

Resets the settings that can be changed in the Device Settings to factory settings.

## 11 Delete Template and Database

Deletes the templates and databases stored in the printer.

## 12 Delete Print Log

Deletes the print log stored in the printer.

## 13 Option Settings

If the [**Do not display an error message if the current settings cannot be retrieved at startup.**] check box is selected, a message will not be displayed next time.

## 14 About

Displays the version information.



## Basic Tab

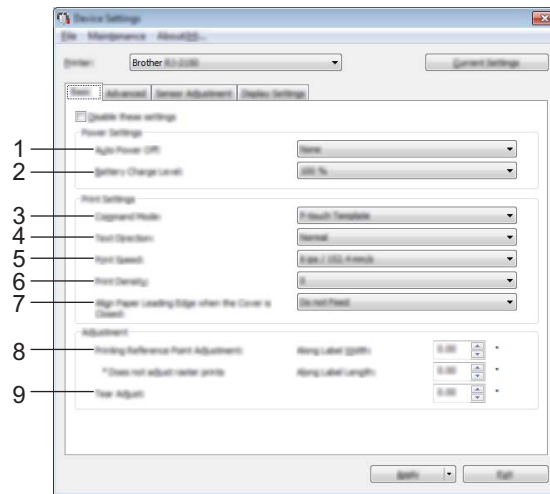

### 1 Auto Power Off

Specify the amount of time that passes before the printer turns off automatically.  
Available settings: **[None]**, 1/2/3/4/5/6/7/8/9/10/20/30/40/50/60 minutes

### 2 Battery Charge Level

Specify the charging level.  
Available settings: **[80 %]**, **[100 %]**



### Note

To get the longest life from the battery, select **[80 %]**. Although the number of pages that can be printed on a single charge will be less when you select **[80 %]**, you can get a longer life from the battery.

### 3 Command Mode

Select the printer's command format.  
Available settings: **[Raster]**, **[ESC/P]**, **[P-touch Template]**, **[CPCL emulation]**, **[CPCL Line Print emulation]**

### 4 Text Direction

Select the printing orientation.  
Available settings: **[Normal]**, **[Inverted 180 Degrees]**  
This setting is applied only if the printer driver is not used. If the printer driver is used, the setting specified in the driver will be applied.

### 5 Print Speed

Select the printer's printing speed.  
Available settings: **[3 ips / 76.2 mm/s]**, **[4 ips / 101.6 mm/s]**, **[5 ips / 127 mm/s]**, **[6 ips / 152.4 mm/s]**

### 6 Print Density

Adjust the printer's printing density.  
Available settings: -5—+5

### **7 Align Paper Leading Edge when the Cover is Closed**

Select whether or not the paper is automatically fed when the cover is closed.

Available settings: [Feed], [Do not Feed]

### **8 Printing Reference Point Adjustment Along Label Width / Printing Reference Point Adjustment Along Label Length**

Adjust the position of the reference point (point of origin for printing). This corrects printing misalignments resulting from differences in printer models or from the fixed margins of some applications.

The reference point cannot be adjusted for raster printing.

### **9 Tear Adjust**

Adjust the tear bar tear off position for paper media.

Available settings: -0.39" to 0.39" (-10.0 mm to 10.0 mm)

## Advanced Tab

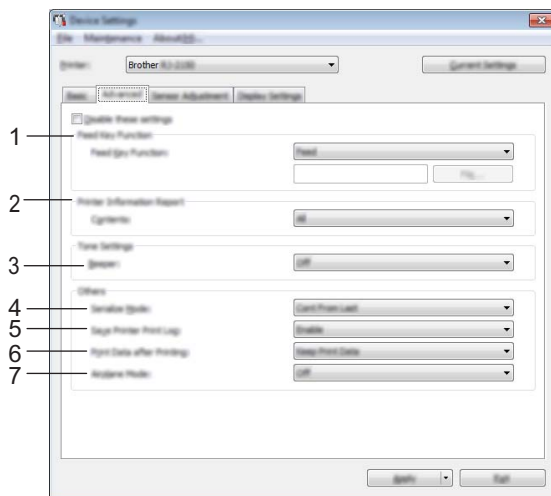

### 1 Feed Key Function

Select the operation that is performed when the  (Feed) button is pressed.

If **[Program Settings]** is selected, click the **[File]** button and select the command file.

Available settings: **[Feed]**, **[Program Settings]**

### 2 Printer Information Report

Select which sections are printed when printing the printer setup information.

Available settings: **[All]**, **[Usage Log]**, **[Printer Settings]**, **[Printer Transfer Data]**

(See *Printing the Printer Information* on page 71)

### 3 Beeper

Select whether the printer beeps when an operation panel button is pressed.

Available settings: **[On]**, **[Off]**

### 4 Serialize Mode

Select whether or not to serialize from the last number printed.

Available settings: **[Cont From Last]**, **[From Starting#]**

### 5 Save Printer Print Log

Select whether or not to save the printer's print log. If **[Disable]** is selected, **[Tools]** - **[Save Print Log in File]** cannot be enabled.

Available settings: **[Enable]**, **[Disable]**

### 6 Print Data after Printing

Select whether or not print data is erased automatically after it is printed.

Available settings: **[Erase All Print Data]**, **[Keep Print Data]**

### 7 Airplane Mode

Allows disabling the Bluetooth or Wi-Fi connection. This function is useful when you use the printer in a place where signal transmissions are not allowed.

Available settings: **[On]**, **[Off]**

## Sensor Adjustment Tab

If RD Rolls are being used, it is unnecessary to adjust the sensors.

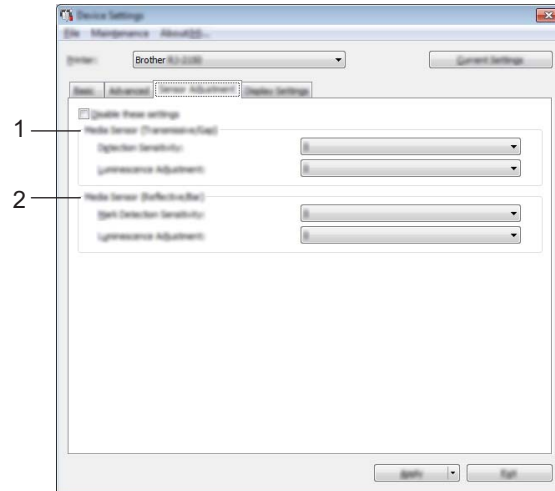

### 1 Media Sensor (Transmissive/Gap) (RJ-2140/2150 only)

If RJ-2030/2050 was selected for [Printer], this item is unavailable. The following transmissive/gap sensor parameters can be adjusted.

#### [Detection Sensitivity]

Adjust the precision of the sensor that detects the gaps (spacing) for die-cut labels.

Available settings: -2--+2

#### [Luminescence Adjustment]

Adjust the amount of light emitted by the transmissive/gap sensor.

Available settings: -2--+2

### 2 Media Sensor (Reflective/Bar)

The following reflective/black mark sensor parameters can be adjusted.

#### [Mark Detection Sensitivity]

Adjust the precision of the sensor that detects the black marks.

Available settings: -2--+2

#### [Luminescence Adjustment]

Adjust the amount of light emitted by the reflective/black mark sensor.

Available settings: -2--+2

## Display Settings Tab

---

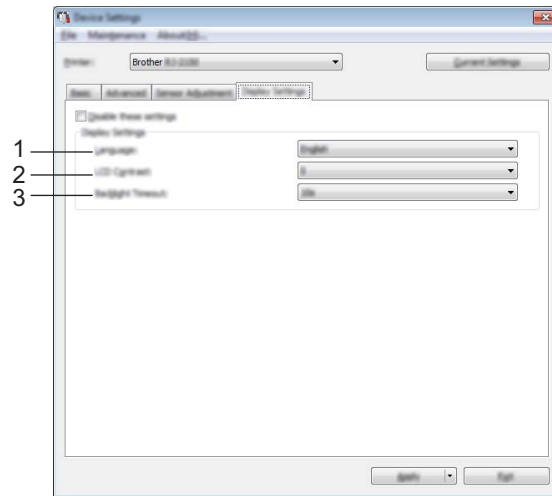

### 1 Language

Select the language of the LCD.

Available settings: **[English]**, **[Español]**, **[Français]**, **[Português]**, **[Deutsch]**, **[Nederlands]**, **[Italiano]**, **[Dansk]**, **[Svenska]**, **[Norsk]**, **[Suomi]**, [中文], [日本語]



#### Note

The possible display languages may differ depending on the printer model being used. If the selected language cannot be used for the LCD, the display language will not be changed.

Make sure that the LCD can display the selected language.

### 2 LCD Contrast

Select the brightness of the LCD.

Available settings: -2--+2

### 3 Backlight Timeout

Specify the amount of time of inactivity that passes before the backlight of the LCD turns off automatically.

Available settings: **[Off]**, **[5s]**, **[10s]**, **[20s]**, **[30s]**, **[60s]**

## Applying Setting Changes to Multiple printers

---

- 1 After applying settings to the first printer, disconnect the printer from the computer, and then connect the second printer to the computer.
- 2 Select the newly connected printer from the **[Printer]** drop-down list.
- 3 Click **[Apply]**.  
The same settings that were applied to the first printer are applied to the second printer.
- 4 Repeat steps 1 – 3 for all printers whose settings you want to change.



### Note

---

To save the current settings in a file, click **[File]** - **[Export]**.

The same settings can be applied to another printer by clicking **[File]** - **[Import]**, and then selecting the exported settings file. (See *Device Settings* on page 52.)

---

## P-touch Template Settings

P-touch Template mode provides functions for inserting data from a device (such as a barcode reader connected to the printer) into text and barcode objects in layouts saved on the printer, useful for printing templates and barcodes.

With [**P-touch Template settings**] in the Printer Setting Tool, settings for using the P-touch Template functions can be specified or changed.

To use the P-touch Template functions, you must send the template to the printer using the transfer function. For more information about the transfer function, see *How to Use P-touch Transfer Manager & P-touch Library* on page 87.

### P-touch Template

---

The following are the P-touch Template functions:

#### Basic operations

- Preset template printing

If frequently used templates are stored in the printer, they can be reprinted by simply scanning the barcode for each template.

- Barcode printing

A barcode scanned with the barcode reader can be printed with the protocol and size of a previously created template.

- Database-assisted template printing

By linking objects in a template to a database, then scanning the key barcodes for the database, the template can be printed with objects in the template replaced with database data.

#### Advanced operations

- Numbering function (serialized number) printing

Templates can be printed while automatically incrementing a number or barcode in the templates.



#### Note

If a command reference is used, see the *P-touch Template Manual/Raster Command Reference*. You can download the latest versions from the Brother support website.

[support.brother.com](http://support.brother.com)

Select the product, and then select [**Manuals**].

---

## P-touch Template Settings Dialog Box

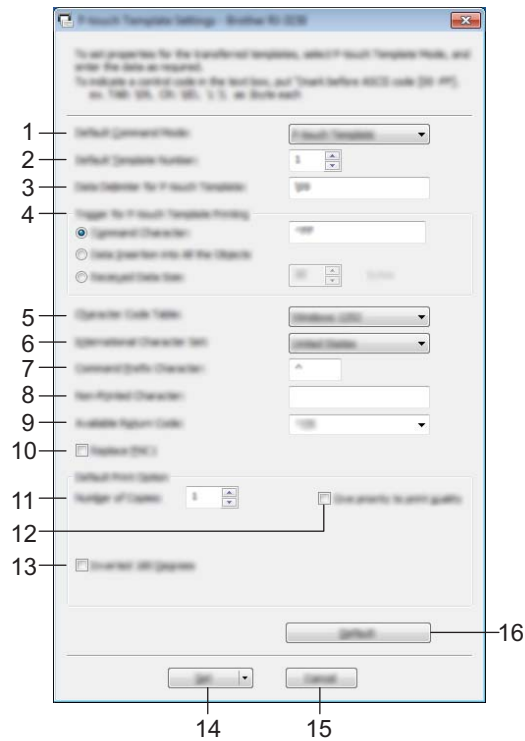

### 1 Default Command Mode

Specifies the P-touch Template mode as the default mode.  
To change the mode, use the Device Settings.

### 2 Default Template Number

Specifies a template number to select as default when the printer is turned on.  
However, if a template is not to be transferred to the printer, do not specify a template number.

### 3 Data Delimiter for P-touch Template

A symbol used to indicate the boundaries between groups of data in a file. Between 1 and 20 characters can be specified.

### 4 Trigger for P-touch Template Printing

You can specify a trigger to begin printing from a number of options.

**[Command Character]:** Printing starts when the command character specified here is received.

**[Data Insertion into All the Objects]:** Printing starts when the delimiter for the last object is received.

**[Received Data Size]:** Printing starts when the number of characters specified here is received. However, delimiters are not counted in the number of characters.

### 5 Character Code Table

Select one of the following character code sets:

Available settings: **[Windows 1252]**, **[Windows 1250 Eastern Europe]**, **[Brother standard]**



## 6 International Character Set

Lists character sets for specific countries.

Available settings: [United States], [France], [Germany], [Britain], [Denmark], [Sweden], [Italy], [Spain], [Japan], [Norway], [Denmark II], [Spain II], [Latin America], [Korea], [Legal]

The following 12 codes are switched depending on the country selected from the list above:

23h 24h 40h 5Bh 5Ch 5Dh 5Eh 60h 7Bh 7Ch 7Dh 7Eh

For switched characters, see the *P-touch Template Manual/Raster Command Reference* (which can be downloaded from the Brother support website).

## 7 Command Prefix Character

Specifies the prefix character code, which identifies commands used in P-touch Template mode.

## 8 Non-Printed Character

Characters specified here are not printed when data is received. Specify 1 to 20 characters.

## 9 Available Return Code

The line feed code is used when feeding data to indicate that the following data should be moved to the next line in a text object. One of the following four line feed codes can be selected, or 1 to 20 characters can be specified as the line feed code.

Available settings: [^CR], [\0D\0A], [\0A], [\0D]

## 10 Replace FNC1

## 11 Number of Copies

Set the number of copies. A number between 1 and 99 can be specified.

## 12 Give priority to print quality

Select the print quality setting. If this check box is selected, priority is given to the print quality.

If this check box is cleared, priority is given to the print speed.

## 13 Inverted 180 Degrees

If this check box is selected, the data will be printed after it has been rotated 180 degrees.

## 14 Set

After the [Set] button is clicked, the settings are saved as an .ini file when the dialog box is closed.

To save the specified settings in a command file, select [Save in Command File] from the drop-down menu. The saved command file can be used with the mass storage feature to apply the settings to a printer. (See *Mass Storage Mode* on page 72.)

## 15 Cancel

Cancels the settings and closes the dialog box. The settings will remain unchanged.

## 16 Default

Click this button to return the settings to their factory defaults.

## Paper Size Setup

With **[Paper Size Setup]** in the Printer Setting Tool, paper sizes not available in the **[Paper Size]** list of the printer driver can be added.

As opposed to specifying paper settings for a normal printer, the paper format must be sent to the printer to add the paper size to the printer.

Printing with a paper format not registered with the printer may produce incorrect print results.

### Paper Size Setup Dialog Box

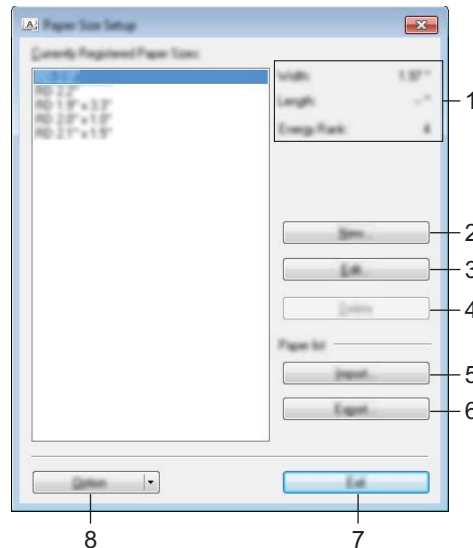

#### 1 Current settings

Displays the current settings for the selected paper format.

#### 2 New

Click this button to display the **[New]** dialog box and register a new paper format. For details, see *New Dialog Box* on page 67.

#### ! Important

Do not register a paper size that has already been registered, to avoid incorrect print results.

To use paper of the same size as one that is currently registered, select the size you want from the **[Currently Registered Paper Sizes]** list in the **[Paper Size Setup]** dialog box, and then change and overwrite the settings from the **[Edit]** dialog box.

#### 3 Edit

Edits the settings for the selected paper format.

To save the selected paper format with the new settings, click **[Overwrite]**. To add a paper format with the new settings, change the name in the **[Paper Size Name]** box, and then click **[Add]**.

#### 4 Delete

Deletes the selected paper format. A deleted paper format cannot be restored.

## 5 Import

Reads the text file containing the paper format settings and uses it to replace the contents of the **[Currently Registered Paper Sizes]** list.

### Important

When the list is imported, the entire contents of the **[Currently Registered Paper Sizes]** list will be replaced with the imported paper formats.

## 6 Export

Exports the paper formats in the **[Currently Registered Paper Sizes]** list to a file. The exported formats can then be distributed to other computers. For details, see *Distributing Paper Formats* on page 70.

## 7 Exit

Exits **[Paper Size Setup]**, and returns to the main window of the Printer Setting Tool.

## 8 Option

Click the ▼ button, and then select an operation.

Click **[Register Paper Size With Printer]** to register the settings for the selected paper format in your printer.

Click **[Save in Command File]** to export the paper settings as a command file. (The file extension is “.bin”.)



### Note

- When the paper format is registered with the printer and **[Exit]** is clicked, the **[Paper Size Setup]** dialog box appears with the added paper size in the **[Currently Registered Paper Sizes]** list. If the application is running, exit the application, and then restart it for the new paper format to appear in the list.
- If the following functions are being used, you can quickly apply their settings to the printer.
  - Mass storage feature (page 72)
  - Bluetooth (Object Push Profile (OPP))
  - Wi-Fi® (File Transfer Protocol (FTP))

### Important

These settings commands are only intended to be used for applying settings to a printer. These commands cannot be imported into **[Paper Size Setup]**.

## New Dialog Box

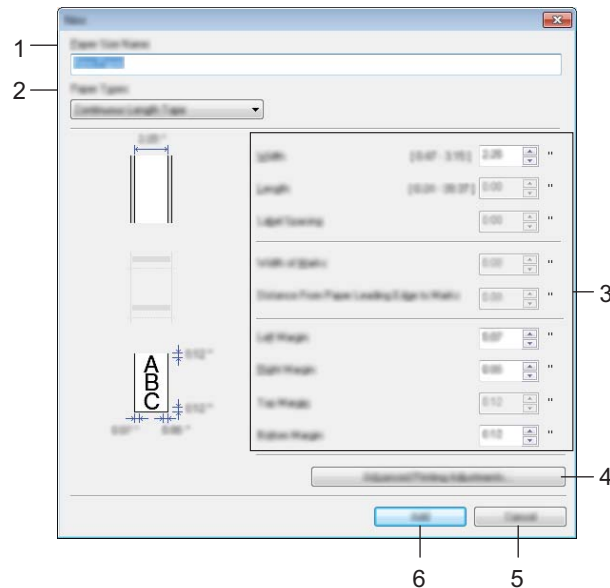

### 1 Paper Size Name

Type in the name of the paper format to be added.

### 2 Paper Types

Select the paper type.

Available settings: **[Continuous Length Tape]**, **[Die-cut Label]** (RJ-2140/2150 only), **[Media With Marks]**

### 3 Detailed settings

Specify details for the paper format to be added.

### 4 Advanced Printing Adjustments

Click this button to display the **[Advanced Printing Adjustments]** dialog box and make advanced printing adjustments for each paper format. For details, see *Advanced Printing Adjustments Dialog Box* on page 68.

### 5 Cancel

Cancels the settings and closes the dialog box. The settings will remain unchanged.

### 6 Add

Click this button to add the paper format.

## Advanced Printing Adjustments Dialog Box

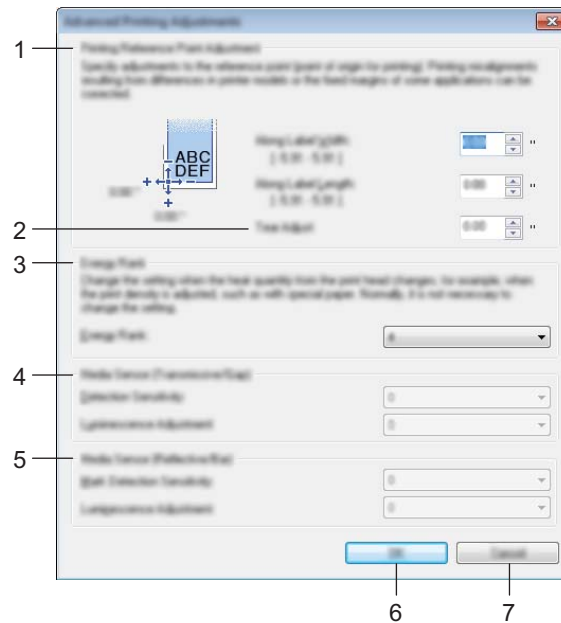

### 1 Printing Reference Point Adjustment

Adjust the position of the reference point (point of origin for printing). This corrects printing misalignments resulting from differences in printer models or from the fixed margins of some applications.

### 2 Tear Adjust

Adjust the cutting position when the paper is cut using the tear bar.

Available settings: -0.39" to 0.39" (-10.0 mm to 10.0 mm)

### 3 Energy Rank

Select a setting when it is necessary to adjust the amount of heat (energy) from the print head, for example, with special paper.



#### Note

- When using "Premium Receipt Paper"\*, select **[RD 2.00" (50 mm)]** in the **[Paper Size Setup]** dialog box, click the **[Edit]** button, and then set **[Energy Rank]** to **[4]** in the **[Advanced Printing Adjustments]** dialog box.

When using "Standard Receipt Paper"\*, set **[Energy Rank]** to **[4]**.

\* Available paper types vary by country.

- There may be contrast variations in the print result due to the operating environment and media used. Change the setting if necessary.

**4 Media Sensor (Transmissive/Gap) (RJ-2140/2150 only)**

Adjust the precision with which the transmissive/gap sensor detects the gaps (spacing) for die-cut labels and the amount of light emitted by the sensor.

Settings can be specified when **[Paper Types]** is set to **[Die-cut Label]**.



**Note**

Because the settings for **[Media Sensor (Transmissive/Gap)]** in the **[Device settings]** dialog box (See *Sensor Adjustment Tab* on page 59) will have an effect, specify appropriate values.

Example of the settings:

	Setting EX1	Setting EX2
<b>Device settings</b>	+2	-2
<b>Paper Size Setup</b>	+2	+2
Actual effect	<b>4</b>	<b>0</b>

**5 Media Sensor (Reflective/Bar)**

Adjust the precision with which the reflective/black mark sensor detects black marks and the amount of light emitted by the sensor.

Settings can be specified when **[Paper Types]** is set to **[Media With Marks]**.



**Note**

Because the settings for **[Media Sensor (Reflective/Bar)]** in the **[Device settings]** dialog box (See *Sensor Adjustment Tab* on page 59) will have an effect, specify appropriate values.

Example of the settings:

	Setting EX1	Setting EX2
<b>Device settings</b>	+2	-2
<b>Paper Size Setup</b>	+2	+2
Actual effect	<b>4</b>	<b>0</b>

**6 OK**

Saves the settings and returns to the previous dialog box.

**7 Cancel**

Cancels the settings and closes the dialog box. The settings will remain unchanged.

## Distributing Paper Formats

---

The paper formats exported from the [Currently Registered Paper Sizes] list can be distributed to other computers.

### Distributing Only Paper Formats

If the printer driver has been installed on the recipient's computer, only the paper formats need to be distributed.

- 1 At the sender's computer, specify the paper format settings, and then click [Export]. (For details, see *Paper Size Setup* on page 65.)  
The following files are created.  
RJ-2030:  
bsr203ed.txt, bsr203ed.ptd, pdt3637.bin  
RJ-2050:  
bsr205ed.txt, bsr205ed.ptd, pdt3737.bin  
RJ-2140:  
bsr214ed.txt, bsr214ed.ptd, pdt3837.bin  
RJ-2150:  
bsr215ed.txt, bsr215ed.ptd, pdt3937.bin
- 2 Save bsr203ed.txt, bsr205ed.txt, bsr214ed.txt, or bsr215ed.txt in any location on the recipient's computer.
- 3 At the recipient's computer, click [Import].  
The paper formats are replaced with the imported ones.

## Changing Settings When Printing from a Mobile Device

If using a mobile device, change the settings as necessary using the application before printing. The settings that can be changed vary according to the application.



### Note

Before connecting a mobile device, you can specify detailed settings by connecting the printer to a computer and using the Printer Setting Tool (see *Changing the Printer Settings* on page 34).

---

## Printing the Printer Information

You can use the  (Feed) button to print a report that lists the following printer information:

- Program version
- Printer usage history
- Missing dot test pattern
- Printer settings information
- List of transferred data
- Network setting information



### Note

- You can use the Device settings to set in advance which items will be printed (see *Device Settings* on page 52).
- The node name appears in the Printer Settings. The default node name is “BRWxxxxxxxxxxxx”. (“xxxxxxxxxxxx” is based on your printer’s MAC Address/Ethernet Address.)
- This operation can also be performed using the Printer Setting Tool.

- 1 Make sure that a roll of receipt paper has been loaded and the media roll compartment cover is closed.
- 2 Turn on the printer.
- 3 Press and hold the  (Feed) button until [Printing] appears on the LCD. The printer information will be printed.



# Mass Storage Mode

## Description

---

The mass storage mode feature allows you to send a file via the USB interface without loading a printer driver.

This feature is useful for:

- Applying printer settings saved in a command file (.bin file format) or adding templates (.blf file format) distributed by the administrator, to your printer.
- Executing commands without installing the printer driver.
- Using a device with an operating system (including non-Windows operating systems) that has a USB host feature to print and transmit data.

## Using the Mass Storage Mode

---

- 1 Confirm that the printer is turned off.
- 2 While pressing the [Menu] button, press and hold the  (Power) button.  
The printer starts up in mass storage mode. The message [Mass Storage] appears on the LCD.
- 3 Connect the computer or device to the printer via USB.  
The printer's mass storage area is displayed on the computer or device's screen.



### Note

---

If the mass storage area is not displayed automatically, see the operating instructions for the computer or device's operating system for information about displaying the mass storage area.

---

- 4 Drag and drop the file you want to copy to the mass storage area.
- 5 Press the [Menu] button.  
The command file is executed. The message [Receiving] appears on the LCD.
- 6 After the file has been executed, the message [Mass Storage] appears on the LCD.
- 7 To turn mass storage mode off, turn the printer off.  
The printer will start up in its normal operating mode.

### Important

---

- When the printer is turned off, mass storage mode is deactivated and any files in the mass storage area are deleted.
  - This feature supports “.bin”, “.blf”, and “.jpg” files. Do not use other file formats with this feature.
  - Do not create folders in the mass storage area. If a folder is created, files in the folder will not be executed.
  - The capacity of the mass storage area is 2.5 MB. Use of files larger than 2 MB cannot be guaranteed.
  - If multiple files are copied, the order that the files will be executed in cannot be guaranteed.
  - Wi-Fi and Bluetooth features are not available while the printer is running in mass storage mode.
  - Do not access other files in the mass storage area when executing a copied file.
-

## JPEG Printing

Image data (JPEG) can be printed without using the printer driver.



### Note

- JPEG images can be printed using the mass storage feature.
- The Object Push Profile (OPP) is used for printing via a Bluetooth connection.
- This printer will convert a color JPEG image to a 'Black & White' image using a dithering process.
- When sending a JPEG image that is already 'Black & White' this dithering process may make your printed image fuzzy.
- To improve the image quality, try to turn off any preprocessing of the JPEG image.

- 
- Only JPEG images can be printed. (Limited to files with the .jpg extension.)
  - The maximum file size is 5 MB.  
(2.38 MB when the mass storage feature is used.)
  - The maximum resolution is as follows:  
Height × Width = 8000 × 432 dots  
If these limits are exceeded, the data received by the printer will be discarded and not printed.
  - Print is at 1 pixel = 1 dot.
  - This printer performs binary processing (simple binary) to print the image.
  - The image is printed with the height-to-width proportion of the received data.

## Remote Update

Remote Update is a printer feature that facilitates the semi-automatic update of the printer's settings with a simple connection to a network folder where the update files reside. For more information about Remote Update, see *Updating the Printer (RJ-2050/2140/2150 only)* on page 31.

# 5

## Maintaining the Printer

Maintenance of your printer may be carried out as required. However, some environments may require carrying maintenance out more frequently (for example, dusty environments).

### Print Head Maintenance

Wipe the print head with a dry, lint-free cloth moistened with isopropyl alcohol or ethanol\*. Carry out the maintenance frequently.

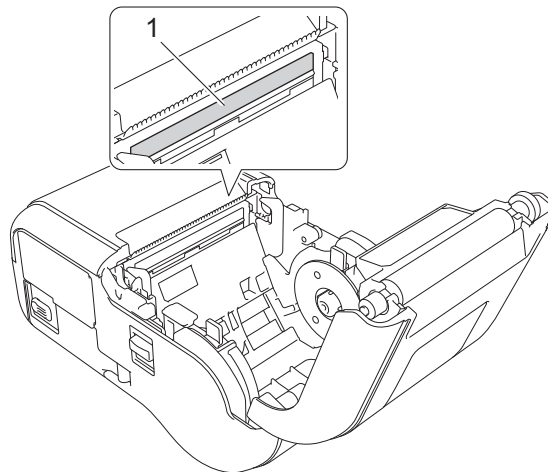

#### 1 Print head

\* Use according to the manufacturer's safety guideline, as applicable.

## Roller Maintenance

Wipe the roller with a dry, lint-free cloth moistened with isopropyl alcohol or ethanol\*. After cleaning the roller, make sure that no lint or other material remains on the roller.

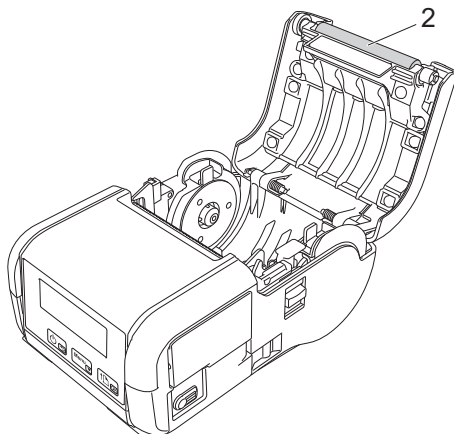

### 2 Roller

\* Use according to the manufacturer's safety guideline, as applicable.

## Paper Exit Slot Maintenance

If adhesive accumulates at the paper exit slot and media becomes jammed or if the paper exit slot becomes dirty, clean the paper exit slot with a cloth slightly moistened with isopropyl alcohol.

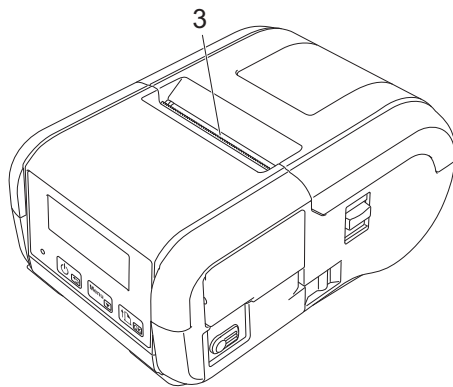

### 3 Paper exit slot



# Application

---

<b>How to Use P-touch Editor</b>	<b>78</b>
<b>How to Use P-touch Transfer Manager &amp; P-touch Library</b>	<b>87</b>
<b>Transferring Templates with P-touch Transfer Express</b>	<b>103</b>
<b>How to Update P-touch Software</b>	<b>111</b>

## Using P-touch Editor

You must install P-touch Editor and the printer driver to use your printer with your computer.

To download the latest driver and software, visit the Brother support website at: [install.brother](http://install.brother)

## Using P-touch Editor

### Starting P-touch Editor

- For Windows Vista / Windows 7 / Windows Server 2008 / Windows Server 2008 R2**  
 From the Start button, click **[All Programs] - [Brother P-touch] - [P-touch Editor]**.  
 When P-touch Editor starts, select whether you want to create a new layout or open an existing layout.

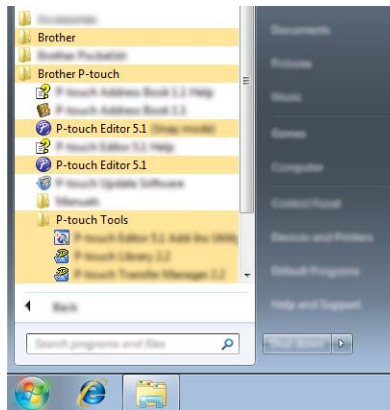

### For Windows 8 / Windows 8.1 / Windows Server 2012 / Windows Server 2012 R2

Click **[P-touch Editor]** on **[Apps]** screen or double-click **[P-touch Editor]** on the desktop.

When P-touch Editor starts, select whether you want to create a new layout or open an existing layout.

### For Windows 10

From the Start button, select **[All apps]** and click **[P-touch Editor]** under **[Brother P-touch]**, or double-click **[P-touch Editor]** on the desktop.

When P-touch Editor starts, select whether you want to create a new layout or open an existing layout.



### Note

- You can also start P-touch Editor using shortcuts, if you chose to create shortcuts during installation.
  - Shortcut icon on the desktop: double-click to start P-touch Editor
  - Shortcut icon in the Quick Launch bar: click to start P-touch Editor
- To change how P-touch Editor starts, click **[Tools] - [Options]** in the P-touch Editor menu bar to display the **[Options]** dialog box. On the left side, select the **[General]** heading and then the setting you want in the **[Operations]** list box under **[Startup Settings]**. The default setting is **[Display New View]**.

2 Select an option in the screen.

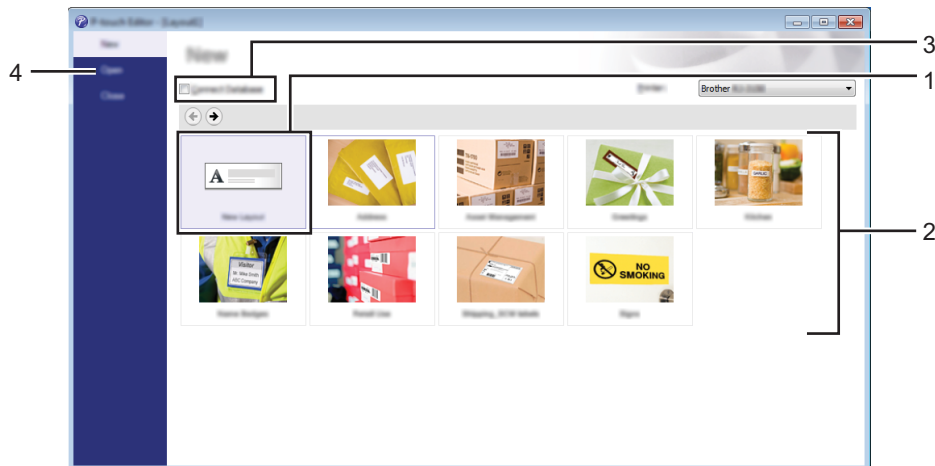

- 1 To create a new layout, double-click **[New Layout]**, or click **[New Layout]** and then click **[→]**.
- 2 To create a new layout using a preset layout, double-click a category button, or select a category button and then click **[→]**.
- 3 To connect a pre-set layout to a database, select the check box next to **[Connect Database]**.
- 4 To open an existing layout, click **[Open]**.



## Printing with P-touch Editor

### Express mode

This mode allows you to quickly create layouts that include text and images.

The **[Express]** mode screen is explained below:

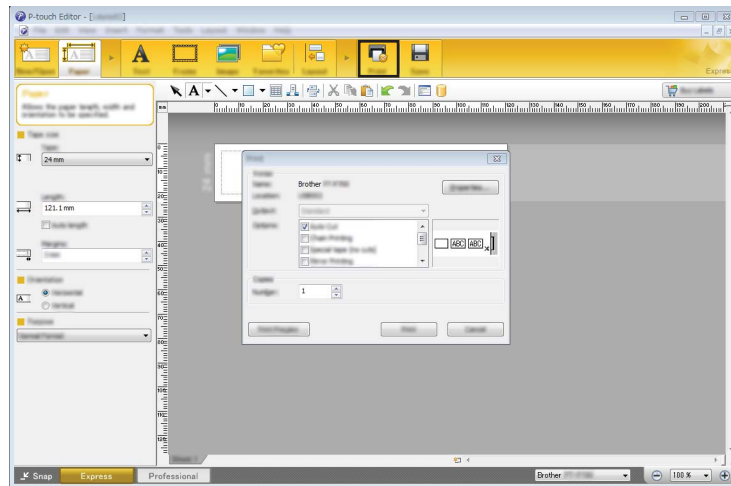

You can print by selecting **[Print]** from **[File]** in the menu bar or by clicking the **[Print]** icon. (Configure the print settings in the **[Print]** screen before printing.)

### Professional mode

This mode allows you to create layouts using a wide-range of advanced tools and options.

The **[Professional]** mode screen is explained below:

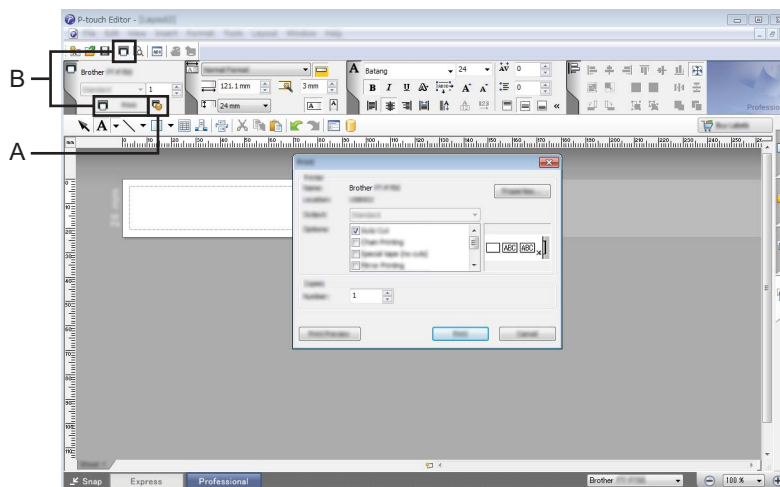

You can print by selecting **[Print]** from **[File]** in the menu bar or by clicking the **[Print]** icon (A). Configure the print settings in the **[Print]** screen before printing.

In addition, you can select "B" to start printing without selecting the print settings.

## Snap mode

This mode allows you to capture all or a portion of your computer screen content, print it as an image, and save it for future use.

- 1 Click the **[Snap]** mode selection button.  
The **[Description of Snap mode]** dialog box appears.

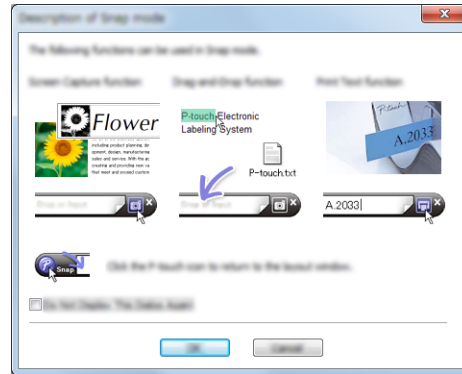

- 2 Click **[OK]**.  
The **[Snap]** mode palette appears.



## Tips for Creating Templates

From the computer, use P-touch Editor, which can be downloaded from the Brother support website at [install.brother](http://install.brother), to create a label layout. For more information about its use, see *How to Use P-touch Editor* on page 78.

### Creating a Template

#### ■ Label sample

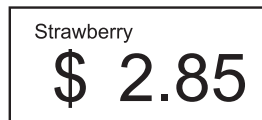

- 1 For Windows Vista / Windows 7 / Windows Server 2008 / Windows Server 2008 R2:  
From the Start menu, click **[All Programs]** - **[Brother P-touch]** - **[P-touch Editor]**.  
For Windows 8 / Windows 8.1 / Windows Server 2012 / Windows Server 2012 R2:  
Click **[P-touch Editor]** on **[Apps]** screen, or double-click **[P-touch Editor]** on the desktop.  
For Windows 10:  
From the Start button, (select **[All apps]**, and then) click **[P-touch Editor]** under **[Brother P-touch]**, or double-click **[P-touch Editor]** on the desktop.
- 2 When the **[New/Open]** dialog box appears, select whether you want to create a new layout or open an existing layout.
- 3 Click **[Paper]** (1), and then specify the media and length (2). (This window appears in **[Express]** mode.)

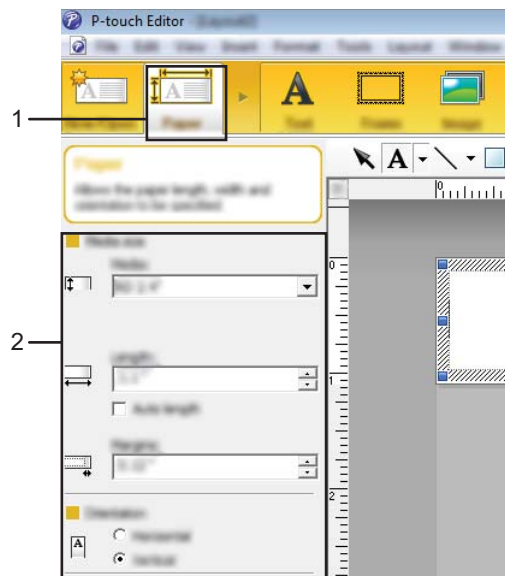

- 4 Click **[Text]** (1), and then specify the font and style (2).

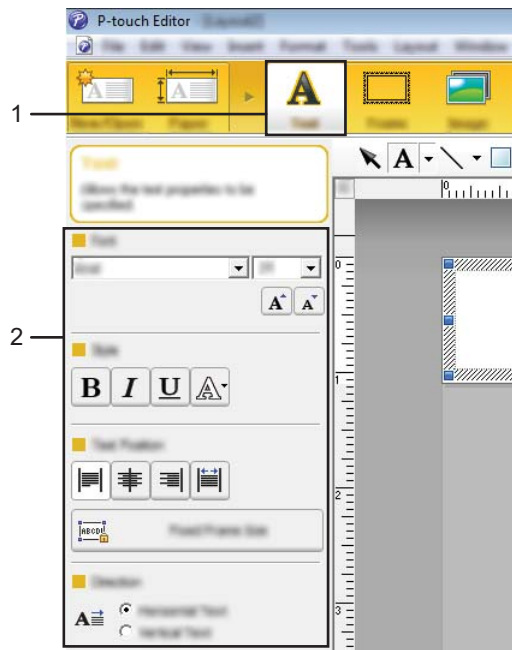

- 5 Clicking **A** displays the cursor so text can be typed in.

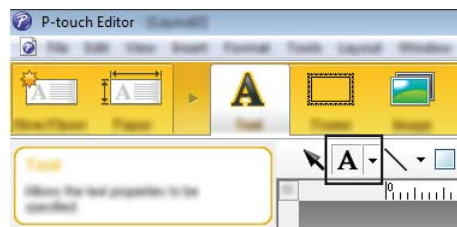

- 6 After inserting the text, click the text box to move it within the template.
- 7 Repeat steps 5 and 6 to enter text and arrange the layout. After entering text, click **[File]** - **[Save as]** on the menu bar, and then specify the file name for saving the data.

## Inserting the Date and Time in a Label

- 1 In P-touch Editor, open the label layout you want to edit.
- 2 On the menu bar, click **[Insert] - [Date/Time]** to display the **[Date and Time Properties]** dialog box. Select settings for the format of the text you want to insert.

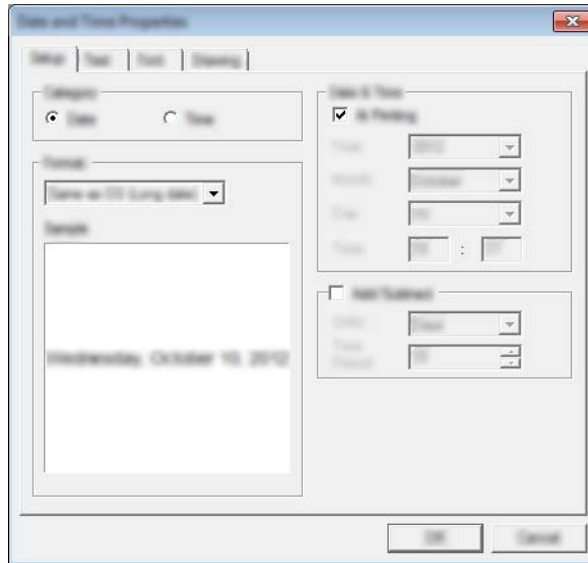

### ! Important

The date and time inserted into the label will be printed using the printer's default character size. Because the character size is determined by the size of the date and time object, adjust the object to the size you want in P-touch Editor before transferring the label layout to the printer.

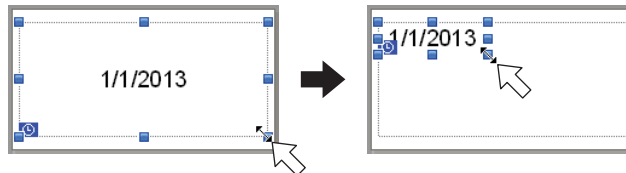

## Linking a Database to a Template

■ Label sample

Strawberry	Orange	Apple
\$ 2.85	\$ 1.55	\$ 2.15

A database can be linked to the template you created. Since the text in the template can be replaced with text from the database, multiple labels can be printed simply by creating a single template.

For more information about specifying database settings, see **[P-touch Editor Help]**.

- 1 Prepare a database file in advance.

 **Note**

- Files saved as XLS, XLSX, MDB, CSV, TXT and ACCDB formats can be used as databases.
- Only one database can be linked to a single template. A maximum of 65,000 records can be created in that database. (The total size of templates and databases is limited to 12 MB.)

- 2 In P-touch Editor, open the template to be linked to the database.
- 3 On the menu bar, click **[File]** - **[Database]** - **[Connect]** to display the **[Open Database]** dialog box. Select **[Connect Database File]**, click **[Browse]**, and then select the database you want to link.

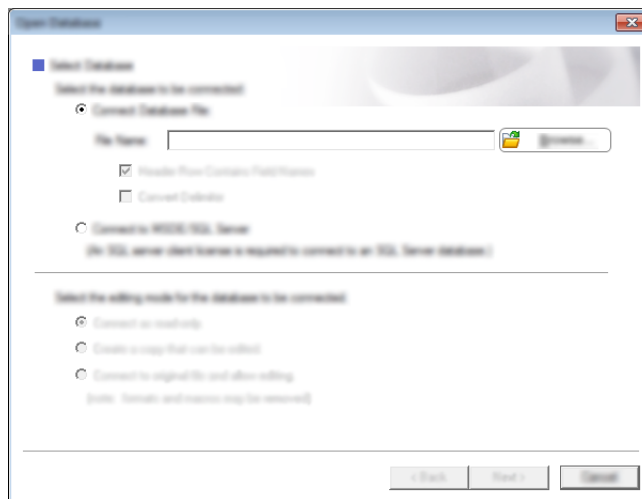

- 4 Click **[Next]** to display a settings dialog box. With **[Database Field]** under **[Merge Fields]**, specify which database column will be linked to which object, and then click **[OK]**.

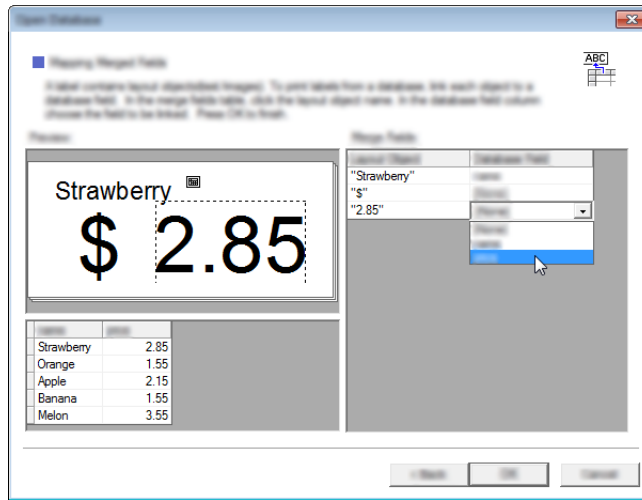

- 5 The template and database will be linked, and the main window appears. Click the database row to be selected to display the label with the text replaced.

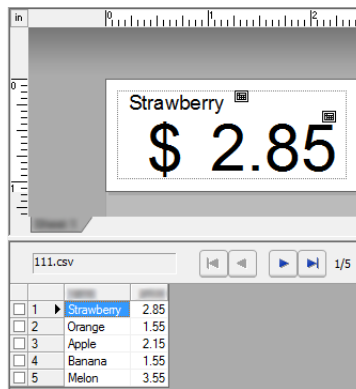

Finally, transfer the created template to the printer using P-touch Transfer Manager. For details, see *Using P-touch Transfer Manager* on page 88.

# How to Use P-touch Transfer Manager & P-touch Library

## P-touch Transfer Manager

This program allows you to transfer templates and other data to the printer and save backups of your data on the computer.

After P-touch Transfer Manager is used to transfer data to the printer, P-touch Template is used to send text data to the printer that will be inserted into the template and printed. For more information about P-touch Template, download the P-touch Template manual (English only) from the Brother support website:

[support.brother.com](http://support.brother.com)

[[Product Search](#)] - [[Manuals](#)]

You can transfer templates and other data by using one of the following methods:

- Via USB (For more information, see *Transferring Templates or Other Data from the Computer to the Printer* on page 91.)
- Via a network

To transfer the templates and other data via a network, use P-touch Transfer Manager or BRAdmin Professional. BRAdmin Professional can be downloaded from our website.

## P-touch Library

This program allows you to use your computer to manage P-touch Template and other data. You can use P-touch Library to print templates.

To transfer the templates via a network, use P-touch Transfer Manager or BRAdmin Professional. BRAdmin Professional can be downloaded from our website.



## Using P-touch Transfer Manager

To use P-touch Transfer Manager, the templates created in P-touch Editor must first be transferred to P-touch Transfer Manager.

### Transferring the Template to P-Touch Transfer Manager

---

- 1 In P-touch Editor, open the template to be transferred.
- 2 Click **[File]** - **[Transfer Template]** - **[Transfer]**.

When P-touch Transfer Manager starts, the main window appears.



#### Note

---

The following method can also be used to start the P-touch Transfer Manager.

**For Windows Vista / Windows 7 / Windows Server 2008 / Windows Server 2008 R2:**

From the Start button, click **[All Programs]** - **[Brother P-touch]** - **[P-touch Tools]** - **[P-touch Transfer Manager 2.2]**.

**For Windows 8 / Windows 8.1 / Windows Server 2012 / Windows Server 2012 R2:**

Click **[P-touch Transfer Manager 2.2]** on **[Apps]** screen.

**For Windows 10:**

From the Start button, (select **[All apps]**, and then) click **[P-touch Transfer Manager 2.2]** under **[Brother P-touch]**.

---

## Main window

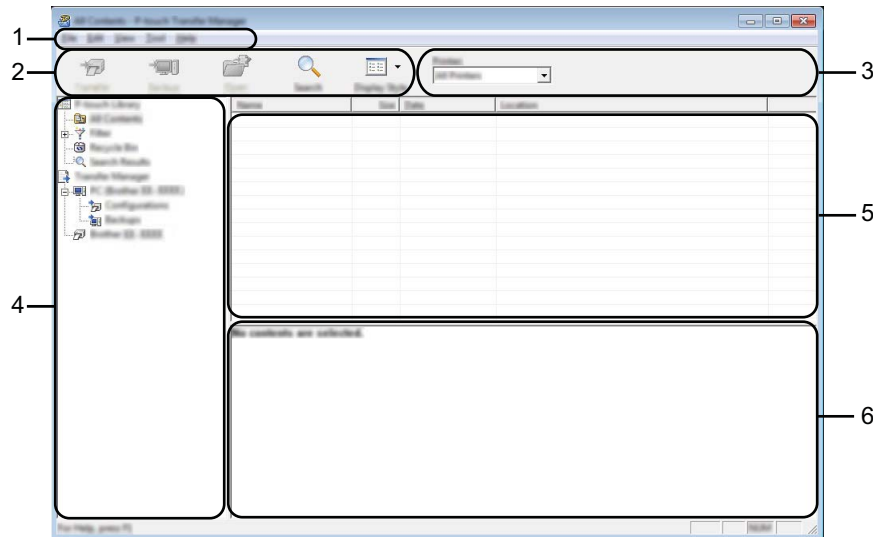

### 1 Menu bar

Provides access to various commands, which are grouped under each menu title ([File], [Edit], [View], [Tool], and [Help]) according to their functions.

### 2 Toolbar

Provides access to frequently used commands.

### 3 Printer selector

Allows you to select which printer the data will be transferred to. When you select a printer, only the data that can be sent to the selected printer is displayed in the data list.

### 4 Folder list

Displays a list of folders and printers. When you select a folder, the templates in the selected folder are displayed in the template list.

If you select a printer, the current templates and other data stored in the printer are displayed.





### 5 Template list

Displays a list of templates in the selected folder.

### 6 Preview

Displays a preview of the templates in the templates list.

## Explanations of the Toolbar Icons

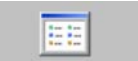
Icon	Button name	Function
	<b>Transfer</b> (Only for P-touch Transfer Manager)	Transfers templates and other data from the computer to the printer.
	<b>Save Transfer File</b> (When not connected to a printer)	Changes the file type of the data to be transferred to other applications. Select "BLF" for the filename extension when transferring the data using Wi-Fi. Select "PDZ" when transferring the data using USB. The available interfaces differ depending on your model.
	<b>Backup</b> (Only for P-touch Transfer Manager)	Retrieves the templates and other data saved in the printer and saves it on the computer.
	<b>Open</b>	Opens the selected template.
	<b>Print</b> (Only for P-touch Library)	Prints the selected template with the printer.
	<b>Search</b>	Allows you to search for templates or other data that are registered to P-touch Library.
	<b>Display Style</b>	Changes the file display style.

## Transferring Templates or Other Data from the Computer to the Printer

Use the following procedure to transfer templates, databases and images from the computer to the printer.

- 1 Connect the computer and the printer using a USB cable or a wireless connection and turn the printer on.
- 2 Start the P-touch Transfer Manager.  
The printer model name appears next to a printer icon in the folder view.  
If you select the printer in the folder view, the current templates and other data stored in the printer appear.



### Note

- If a printer is disconnected or offline, it is not listed in the folder view.
- Before transferring data, check that the computer and the printer are correctly connected using a USB cable or a wireless connection, and that the printer is on.

- 3 Select the printer that you want to transfer the template or other data to.

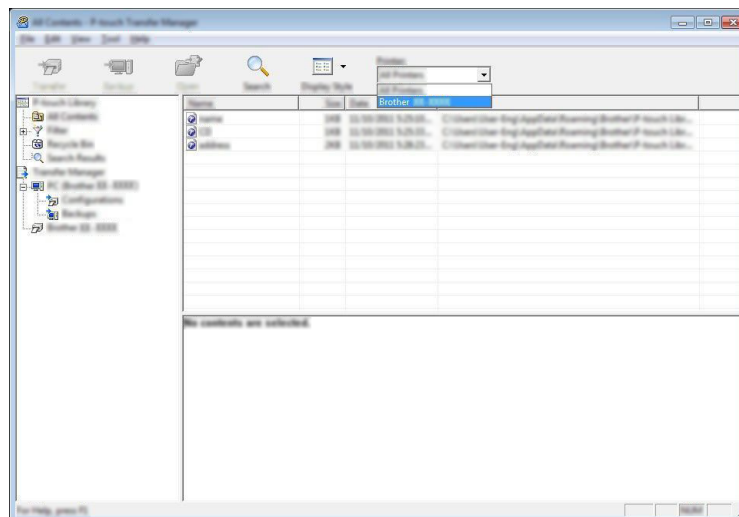

### Note

Before transferring data, check that the computer and the printer are correctly connected with a USB cable or a wireless connection and that the printer power is On.

- 4 Right-click the **[Configurations]** folder, select **[New]**, and then create a new folder.

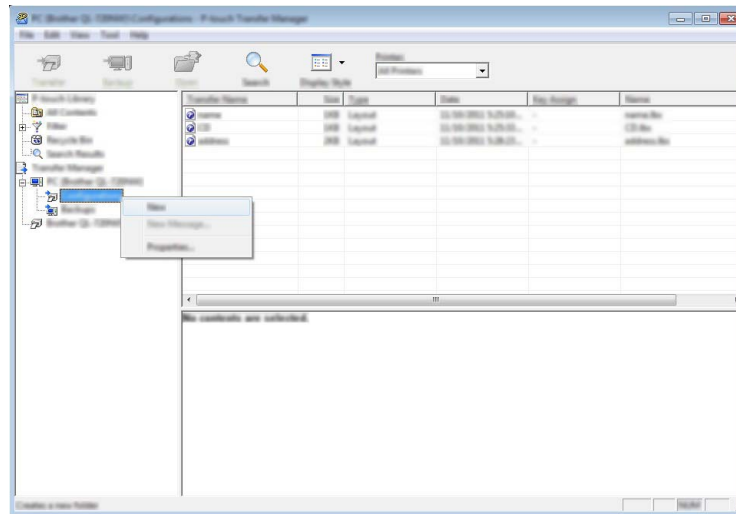

In the example above, the folder **[Transfer]** is created.

- 5 Drag the template or other data that you want to transfer and place it in the new folder.

### Transfer Function Specification

Data type	Maximum number of transferable items	Restriction details
Template	255	<ul style="list-style-type: none"> <li>Each template can contain a maximum of 255 objects.</li> </ul>
Database	255	<ul style="list-style-type: none"> <li>Only *.csv files can be transferred.</li> <li>Each *.csv file can contain a maximum of 65000 records.</li> </ul>
Image (User-defined character)	255	<ul style="list-style-type: none"> <li>Only *.bmp files can be transferred.</li> <li>Monochrome *.bmp files are recommended.</li> <li>The size limit is 432 × 432 pixels.</li> </ul>



**Note**

You can confirm the available space in the transfer file memory by printing out the printer information. Press and hold the  (Feed) button on your printer to print the printer information. See [RomFree] for the available space\*.

- \* The available space that is displayed in "Memory = \*\*\*\*\*byte" may be different from the actual available space.

You can view the templates and other data by selecting the folder in the [Configurations] folder, selecting [All Contents] or by selecting one of the categories under [Filter], such as [Layouts].

When transferring multiple templates or other data, drag all the files that you want to transfer and place them in the new folder.

When placed in the new folder, each file is assigned a key number (memory location in the printer).

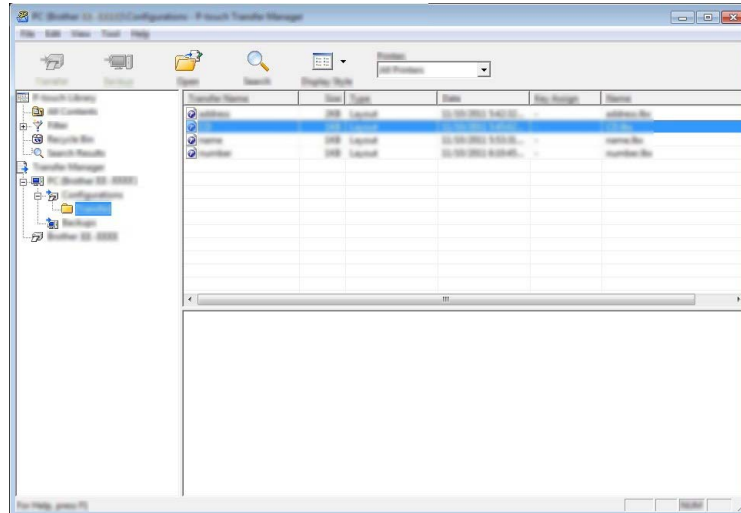

- To change the key number assigned to an item, right-click the item, select **[Key Assign]**, and then select the key number you want.

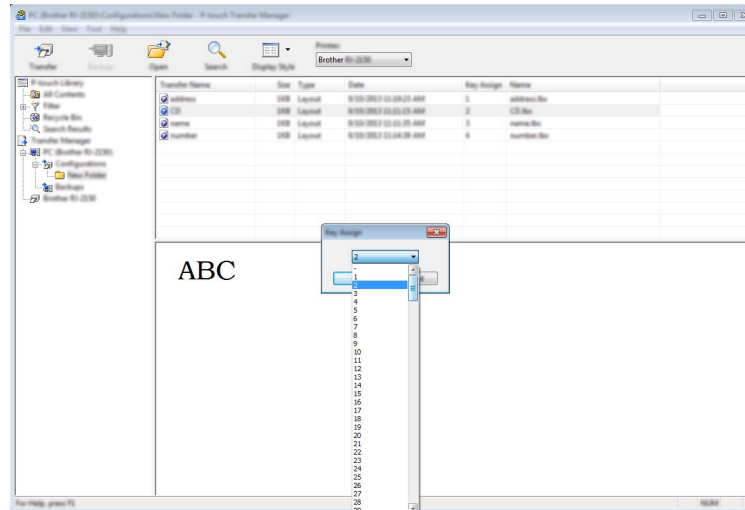

 **Note**

- Except for the data in databases, all data transferred to the printer is assigned a key number.
- If the template or other data transferred to the printer has the same key number as another template already saved in the printer, the new template will overwrite the old one. You can confirm the templates key number assignments saved in the printer by backing up the templates or other data (see *Backing up Templates or Other Data Saved in the Printer* on page 96).
- If the printer memory is full, remove one or more templates from the printer's storage memory (see *Backing up Templates or Other Data Saved in the Printer* on page 96).

- To change the names of templates or other data that will be transferred, click the item you want and enter the new name. The number of characters used for the template names may be limited depending on the printer model.

- 8 Select the folder containing the templates or other data that you want to transfer, and then click **[Transfer]**. A confirmation message appears.

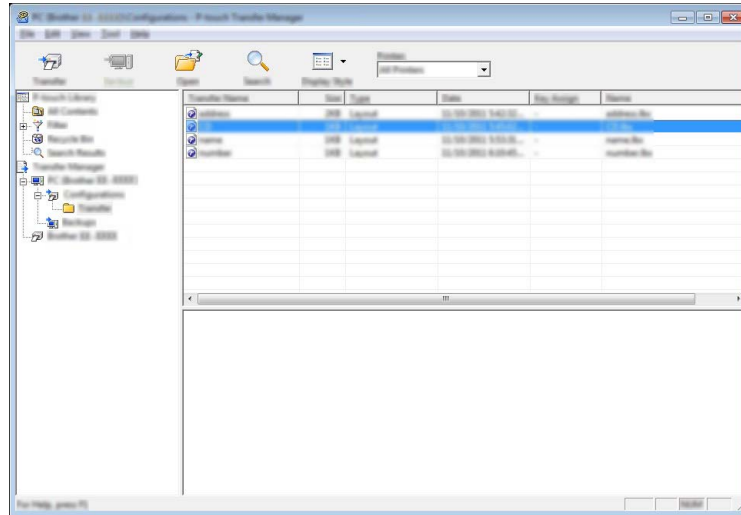

 **Note**

- You can also transfer individual items to the printer without adding them to a folder. Select the template or other data that you want to transfer, and then click **[Transfer]**.
- Multiple items and folders can be selected and transferred in one operation.

- 9 Click **[OK]**.

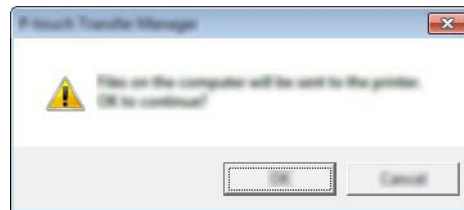

The selected templates, folders or other data are transferred to the printer.



## Backing up Templates or Other Data Saved in the Printer

Use the following procedure to retrieve the templates or other data saved in the printer and save it on the computer.

### ❗ Important

- Backed up templates or other data cannot be edited on the computer.
- Depending on the printer model, templates or other data backed up from one printer model may not be able to be transferred to another printer model.

- 1 Connect the computer and the printer and turn the printer on.  
The printer model name is displayed in the folder view.  
If you select a printer in the folder view, the current templates and other data stored in the printer are displayed.
- 2 Select the printer to back up from, and then click **[Backup]**.  
A confirmation message appears.

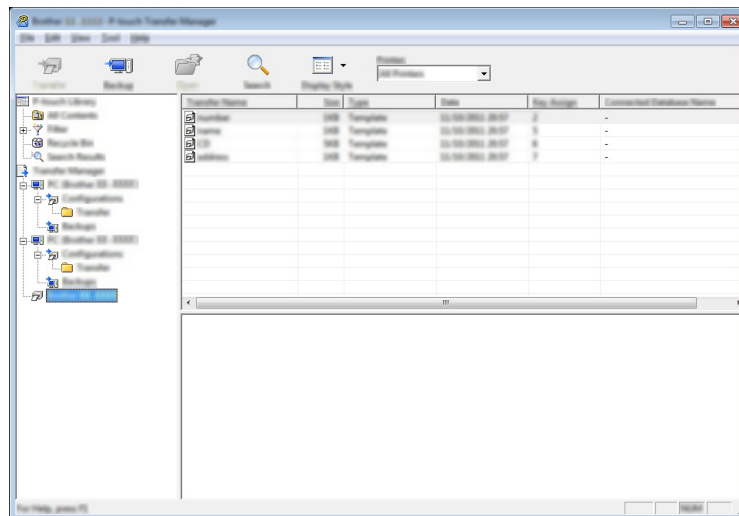

- 3 Click **[OK]**.  
A new folder is created under the printer in the folder view. The folder name is based on the date and time of the backup. All of the printer's templates and other data are transferred to the new folder and saved on the computer.



## Deleting All the Printer Data

Use the following procedure to delete all templates or other data that are saved in the printer.

### ❗ Important

This feature is only available when the computer and printer are connected via USB.

- 1 Connect the computer and the printer and switch the printer's power On.  
The printer model name is displayed in the folder view.
- 2 Right-click the printer, and then select [**Delete All**].

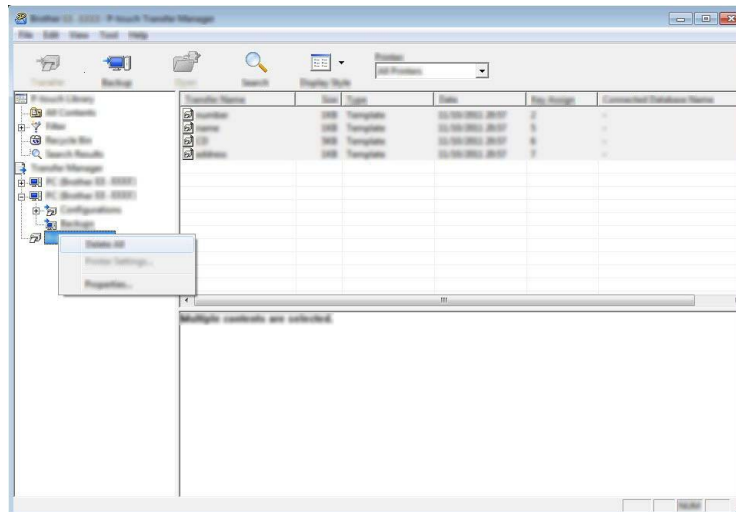

A confirmation message appears.

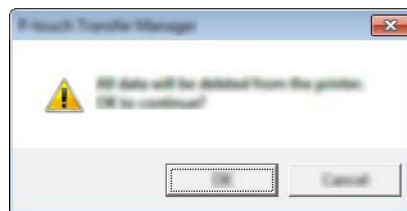

- 3 Click [**OK**].  
All templates and other data saved in the printer are deleted.

## Creating a BLF File or a PDZ File

You can use P-touch Transfer Manager to save template data, which was created using P-touch Editor, in the BLF or PDZ format. You can transfer these files in this format to a printer over a network, from a computer or mobile device. You can also print files in BLF format from mass storage mode.

- 1 Create the template using P-touch Editor, and then transfer it to P-touch Transfer Manager. For more information, see *Transferring the Template to P-Touch Transfer Manager* on page 88.
- 2 Without connecting the printer to the computer, select **[Configurations]** in the P-touch Transfer Manager window, and then select the template to save.



### Note

You can select multiple templates at the same time.

- 3 Click **[File]** - **[Save Transfer File]**.

### Important

The **[Save Transfer File]** button appears only if the printer is disconnected from the computer or offline.



### Note

- If you click **[Save Transfer File]** after selecting **[Configurations]**, all templates in the folder are saved as the Transfer file (.blf) or Transfer Package file (.pdz).
- You can combine multiple templates into a single Transfer file (.blf) or Transfer Package file (.pdz).

- 4 In **[Save as type]**, select the format in which to save the template, and then type in the name and save the template.  
Select the BLF format when printing using the mass storage mode or connecting your mobile device to the printer using Wireless Direct or Wi-Fi, and select the PDZ format when connecting using Bluetooth. The templates are saved as a Transfer file (.blf) or Transfer Package file (.pdz).

# Using P-touch Library

## Starting P-touch Library

### For Windows Vista / Windows 7 / Windows Server 2008 / Windows Server 2008 R2:

From the Start button, click [All Programs] - [Brother P-touch] - [P-touch Tools] - [P-touch Library 2.2].

### For Windows 8 / Windows 8.1 / Windows Server 2012 / Windows Server 2012 R2:

Click [P-touch Library 2.2] on [Apps] screen.

### For Windows 10:

From the Start button, (select [All apps], and then) click [P-touch Library 2.2] under [Brother P-touch].

When P-touch Library starts, the main window appears.

## Main window

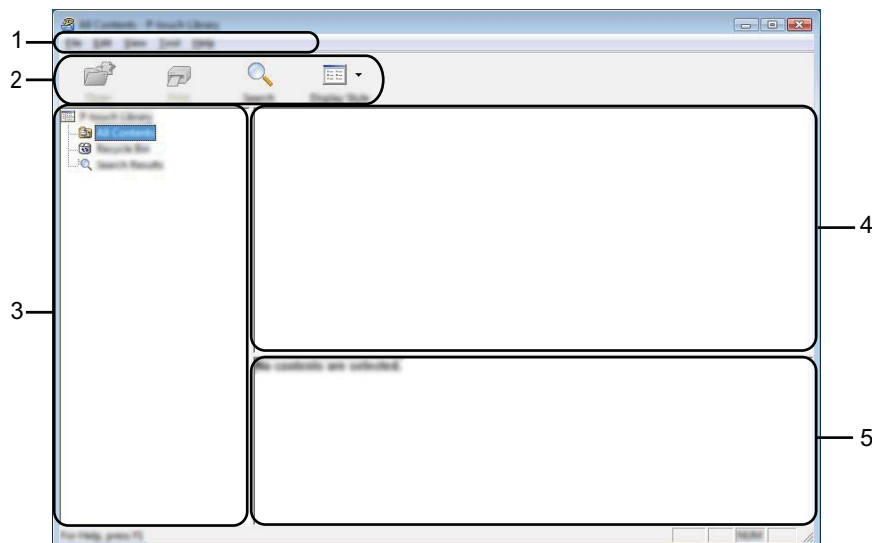

### 1 Menu bar

Provides access to all available commands, which are grouped under each menu title ([File], [Edit], [View], [Tool], and [Help]) according to their functions.

### 2 Toolbar

Provides access to frequently used commands.

### 3 Folder list

Displays a list of folders. When you select a folder, the templates or other data in the selected folder are displayed in the templates list.



### 4 Templates list

Displays a list of the templates or other data in the selected folder.

## 5 Preview

Displays a preview of the templates or other data selected in the templates list.

### Explanations of the Toolbar Icons

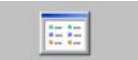
Icon	Button name	Function
	<b>Open</b>	Opens the selected template.
	<b>Print</b> (Only for P-touch Library)	Prints the selected template with the printer.
	<b>Search</b>	Allows you to search for templates or other data that are registered to P-touch Library.
	<b>Display Style</b>	Changes the file display style.

## Opening and Editing Templates

Select the template you want to open or edit, and then click **[Open]**.

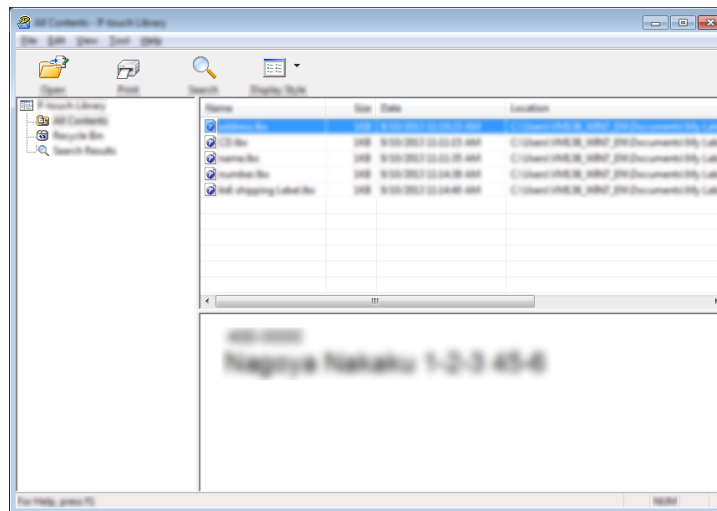

The program associated with the template starts, and lets you edit the template.



### Note

The program that starts depends on the type of file that is selected. For example, if you select a P-touch Template, P-touch Editor starts.

## Printing Templates

Select the template you want to print and then click **[Print]**.

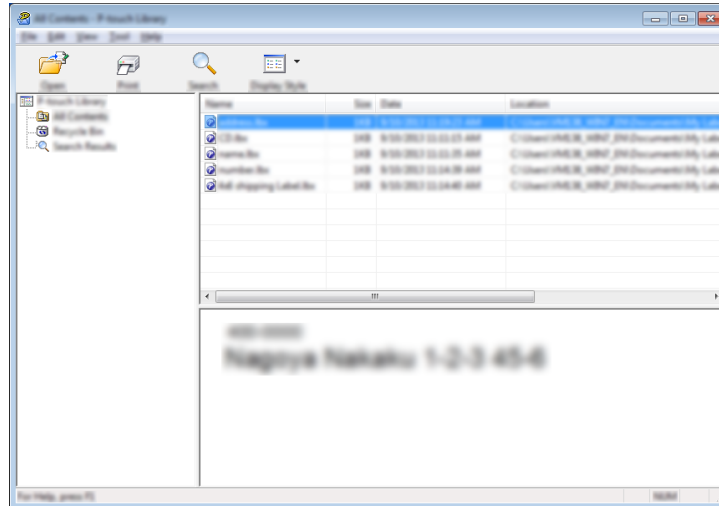

The template is printed using the connected printer.

## Searching for Templates or Other Data

You can search for templates or other data registered to P-touch Library.

- 1 Click **[Search]**.  
The **[Search]** dialog box appears.

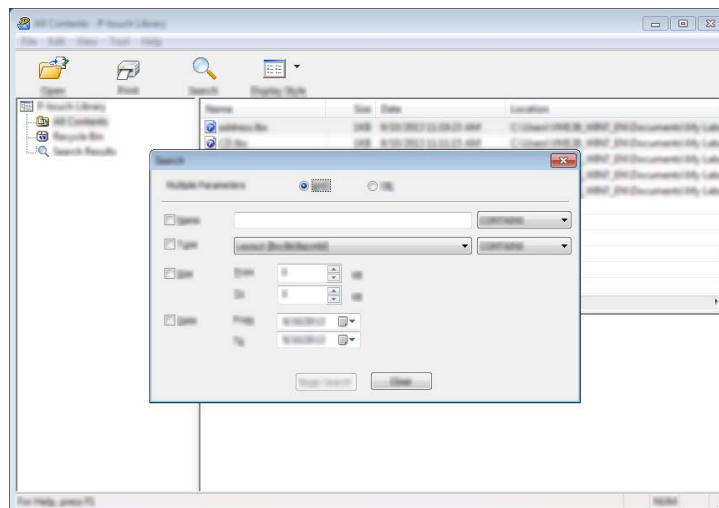

- Specify the search criteria.  
The following search criteria are available.

Settings	Details
<b>Multiple Parameters</b>	Determines how the program searches when multiple criteria are specified. If you select <b>[AND]</b> , the program searches for files that satisfy all of the criteria. If you select <b>[OR]</b> , the program searches for files that satisfy any of the criteria.
<b>Name</b>	Allows you to search for a template or other data by specifying the file name.
<b>Type</b>	Allows you to search for a template or other data by specifying the file type.
<b>Size</b>	Allows you to search for a template or other data by specifying the file size.
<b>Date</b>	Allows you to search for a template or other data by specifying the file date.

- Click **[Begin Search]**.  
The search begins.

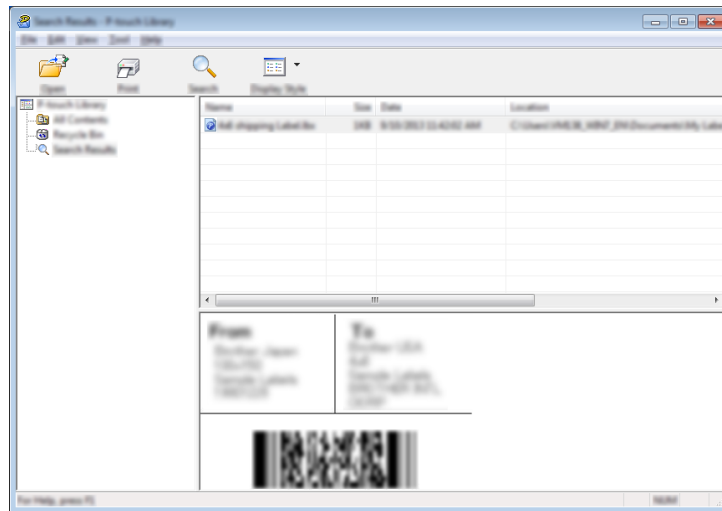

- Close the **[Search]** dialog box.  
The search results can be confirmed by clicking **[Search Results]** in the folder view.

 **Note**

You can register templates or other data to P-touch Library by dragging and dropping it into the **[All Contents]** folder or to the folder list. You can also configure P-touch Editor to register templates to P-touch Library automatically, using the following procedure.

- From the P-touch Editor menu, select **[Tools]** - **[Options]**.
- In the **[Options]** dialog box, click **[Registration Settings]** in the **[General]** tab.
- Select the timing for registering templates created with P-touch Editor, and then click **[OK]**.

## 8

# Transferring Templates with P-touch Transfer Express

By using P-touch Transfer Express, one or more templates and a database can be quickly transferred into a printer via a local USB. After a template has been created by an administrator, it can be distributed together with P-touch Transfer Express to many users and easily transferred into each printer locally.

## Important

- To transfer the file as a new template, specify a **[Key Assign]** number (in P-touch Transfer Manager) that is not currently used. If the specified **[Key Assign]** number is already being used, the existing template will be overwritten with the new one.
- Valid only when the printer is connected via USB.

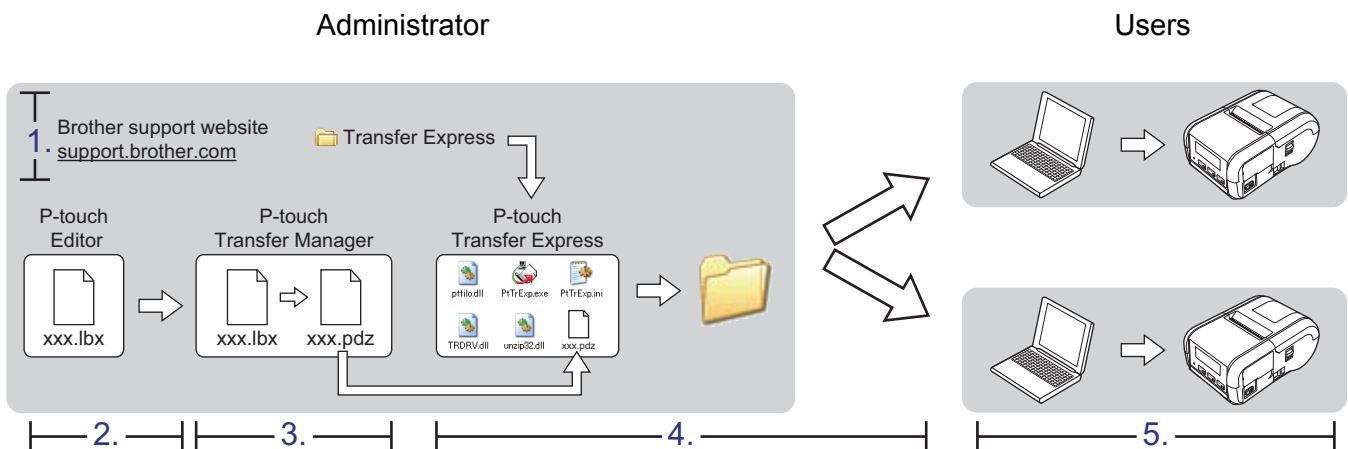

8

## Preparing P-touch Transfer Express

The user must prepare P-touch Transfer Express for transferring templates to the printer.

## Important

P-touch Transfer Express is developed in English.

- 1 The latest P-touch Transfer Express can be downloaded from the following website: [support.brother.com](http://support.brother.com) [Select your region/country.] - [Product Search] - [Downloads].
- 2 Download Transfer Express to any location on the computer.
- 3 Decompress the downloaded file (.zip).



## Transferring the Template to P-Touch Transfer Manager

- 1 In P-touch Editor, open the template to be transferred.
- 2 Click [File] - [Transfer Template] - [Transfer].

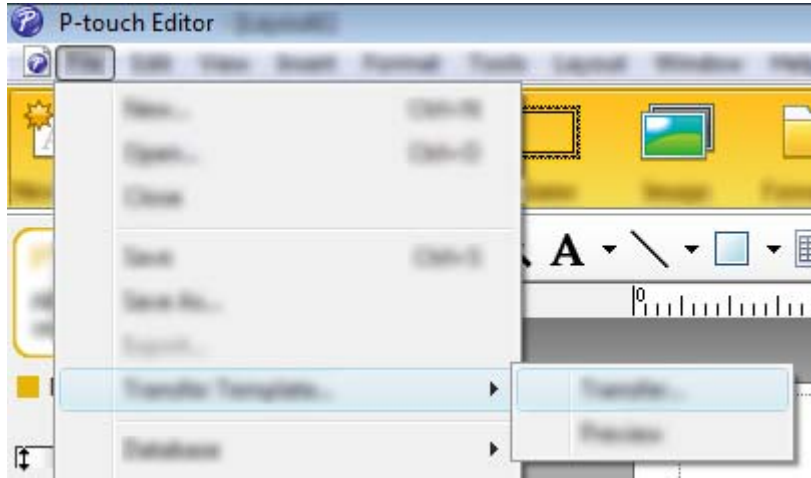

The template is transferred to P-touch Transfer Manager.  
P-touch Transfer Manager starts up automatically.



### Note

- **For Windows Vista / Windows 7 / Windows Server 2008 / Windows Server 2008 R2:**  
The template can also be transferred to P-touch Transfer Manager by clicking the Start button - [All Programs] - [Brother P-touch] - [P-touch Tools] - [P-touch Transfer Manager 2.2] to start P-touch Transfer Manager, then dragging the .lbx file to the P-touch Transfer Manager window.
- **For Windows 8 / Windows 8.1 / Windows Server 2012 / Windows Server 2012 R2:**  
The template can also be transferred to P-touch Transfer Manager by clicking [P-touch Transfer Manager 2.2] on [Apps] screen to start P-touch Transfer Manager, then dragging the .lbx file to the P-touch Transfer Manager window.
- **For Windows 10:**  
The template can also be transferred to P-touch Transfer Manager by clicking the Start button, (then selecting [All apps]) and clicking [Brother P-touch] - [P-touch Transfer Manager 2.2] to start P-touch Transfer Manager, and then dragging the .lbx file to the P-touch Transfer Manager window.

## Saving the Template as a Transfer Package File (.pdz)

To create a file in a format recognized by P-touch Transfer Express, save the template as a Transfer Package file (.pdz).

- 1 In the folder view, select [**Configurations**].

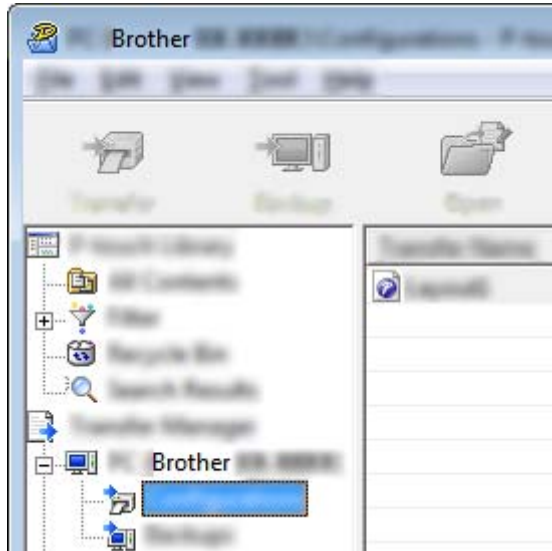

- 2 Select the template you want to distribute.

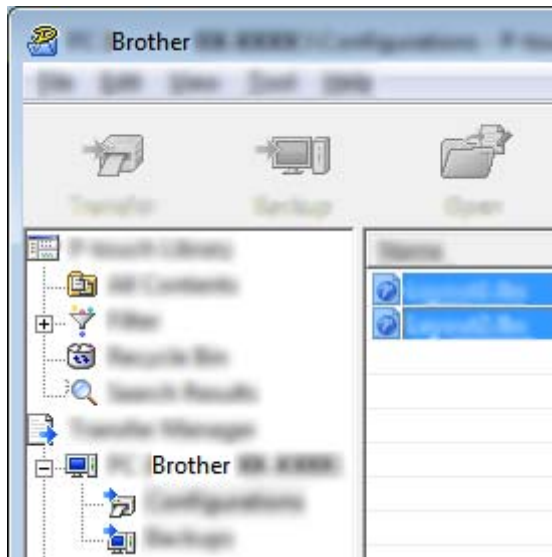

Multiple templates can be selected.

- 3 Click **[File]** - **[Save Transfer File]**.



**Note**

- If **[Save Transfer File]** was clicked while either **[Configurations]** or a created folder is selected, all templates in the folder are saved as the Transfer Package file (.pdz).
- Multiple templates can be combined into a single Transfer Package file (.pdz).

- 4 Type in the name, and then click **[Save]**.

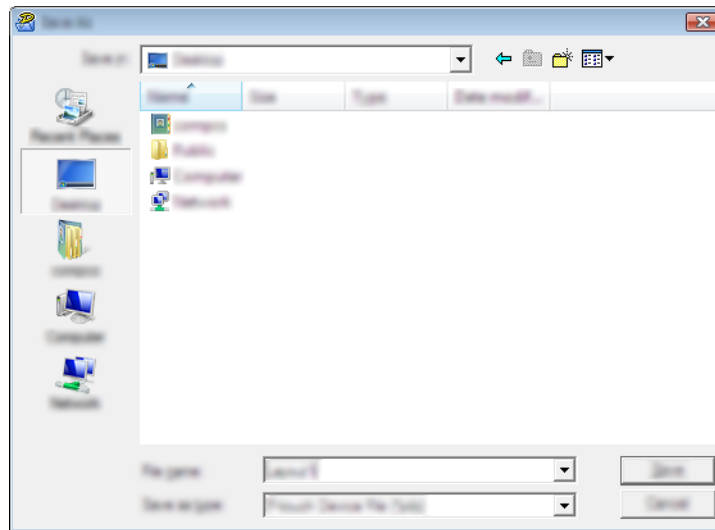

The template is saved as a Transfer Package file (.pdz).

## Distributing the Transfer Package File (.pdz) and P-Touch Transfer Express to the User



### Note

If the users already have P-touch Transfer Express downloaded, it is not necessary for the administrator to send the Transfer Express folder to the user. In this case, the user can simply move the distributed Transfer Package file to the downloaded folder and then double-click **[PtTrExp.exe]**.

- 1 Move the Transfer Package file (.pdz) to the downloaded folder.

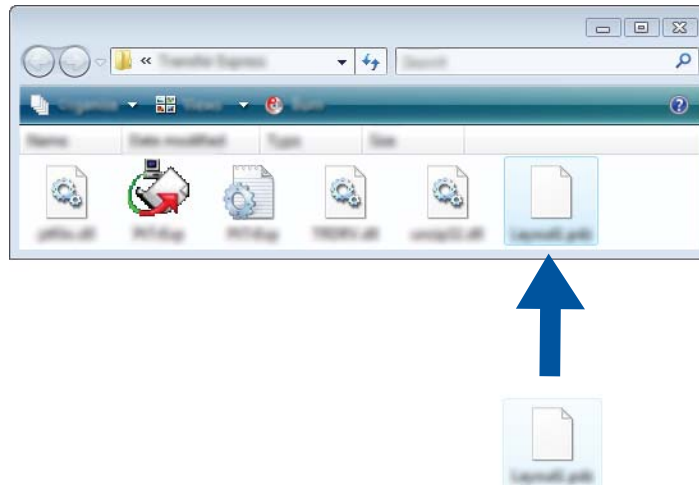

- 2 Distribute all files in the downloaded folder to the user.

## Transferring the Transfer Package File (.pdz) to Your Printer

Using the P-touch Transfer Express application received from the administrator, the user can transfer the Transfer Package file (.pdz) to the printer.

### ! Important

Do not turn off the power when transferring templates.

- 1 Turn on the printer.
- 2 Using a USB cable, connect the printer to the computer.
- 3 Double-click [**PtTrExp.exe**], which was received from the administrator.
- 4 When there is a single Transfer Package file (.pdz) within the folder containing [**PtTrExp.exe**], click [**Transfer**].

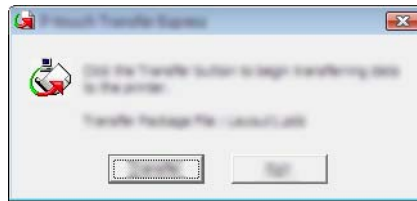

The transfer of the Transfer Package file begins.



When there are either multiple or no Transfer Package files (.pdz) within the folder containing [PtTrExp.exe], click [Browse].

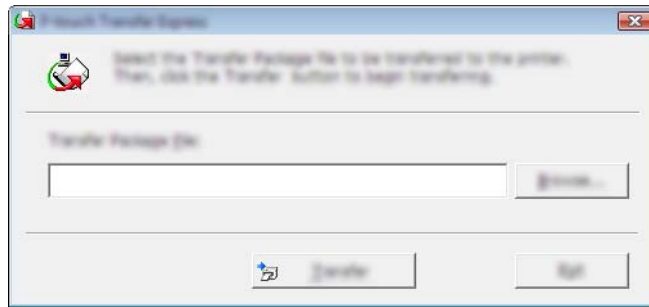

Select the Transfer Package file you want to transfer, and then click [Open].

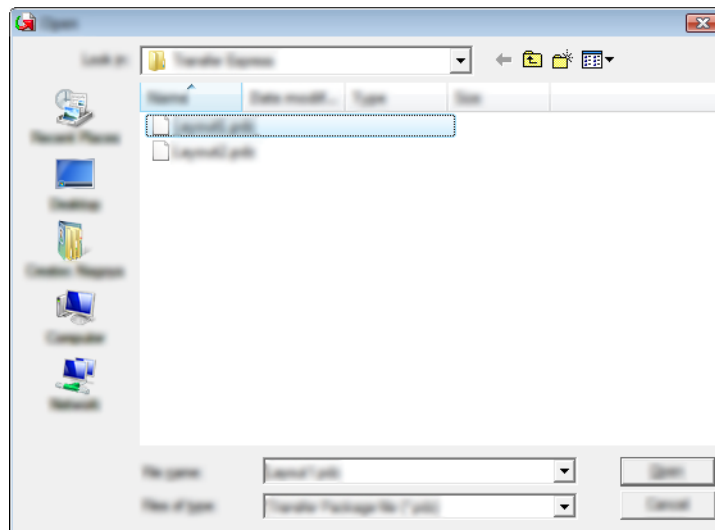

Click [Transfer].

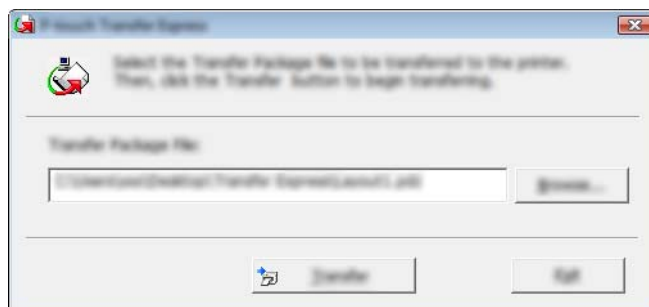

Click **[Yes]**.

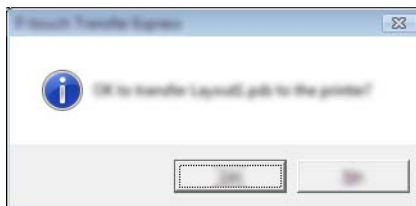

The transfer of the Transfer Package file begins.

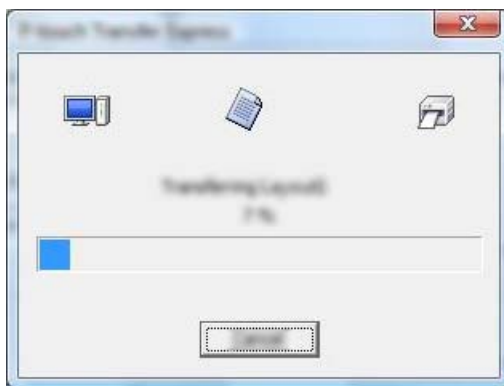

5 Click **[OK]**.

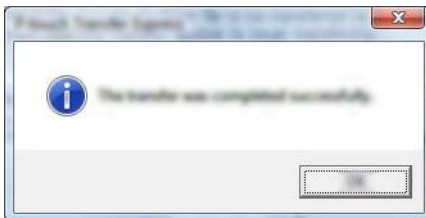

The transfer of the Transfer Package file is completed.

The software can be upgraded to the latest available version using this tool.

In the following steps, you will see XX-XXXX. Read "XX" as your printer name.



## Note

- To use the P-touch Update Software, download it from our website at [install.brother](http://install.brother) and install it. The installation instructions are available on the download page.
- You must be connected to the internet to launch the P-touch Update Software.
- You may find that the software and the contents in this manual are different.
- After you installed the P-touch Update Software, an icon appears on your desktop.
- Do not turn off the power when transferring data or updating firmware.

## Updating P-touch Editor



**1 For Windows Vista / Windows 7 / Windows Server 2008 / Windows Server 2008 R2**

Double-click the [P-touch Update Software] icon.



## Note

The following method can also be used to start the P-touch Update Software.

Click the Start button, and then select [All Programs] - [Brother P-touch] - [P-touch Update Software].

**For Windows 8 / Windows 8.1 / Windows Server 2012 / Windows Server 2012 R2**

Click [P-touch Update Software] on [Apps] screen or double-click [P-touch Update Software] on the desktop.

**For Windows 10**

From the Start button, (select [All apps], and then) click [Brother P-touch] - [P-touch Update Software], or double-click [P-touch Update Software] on the desktop.





- 2 Click the **[Computer software update]** icon.

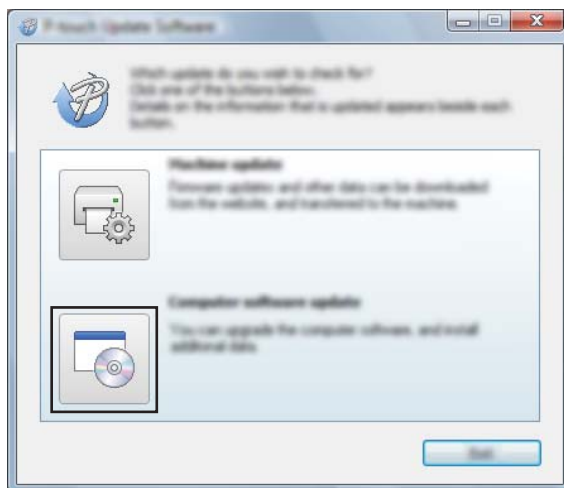

- 3 Select the **[Printer]** and **[Language]**, select the check box next to P-touch Editor, and then click **[Install]**.

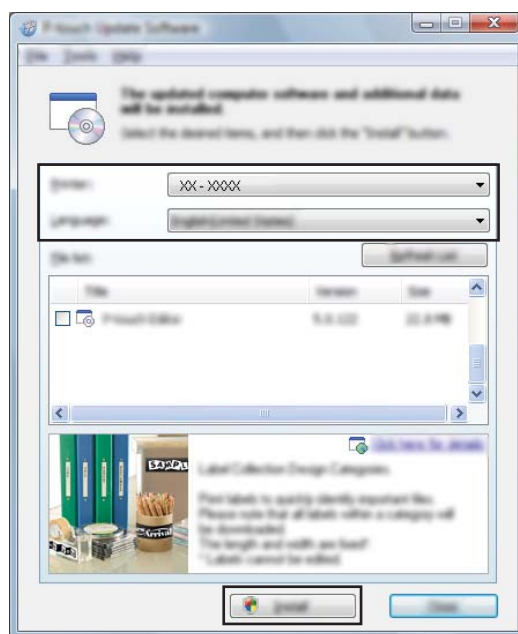

- 4 A message appears to indicate the installation has finished.

## Updating the Firmware

### ❗ Important

- The printer driver must be installed before updating the firmware.
- Do not turn off the power when transferring data or updating firmware.
- If another application is running, exit the application.

1 Turn the printer on and connect the USB cable.

2 **For Windows Vista / Windows 7 / Windows Server 2008 / Windows Server 2008 R2**  
Double-click the [P-touch Update Software] icon.

### 📝 Note

The following method can also be used to start the P-touch Update Software.  
Click the Start button, and then select [All Programs] - [Brother P-touch] - [P-touch Update Software].

### **For Windows 8 / Windows 8.1 / Windows Server 2012 / Windows Server 2012 R2**

Click [P-touch Update Software] on [Apps] screen or double-click [P-touch Update Software] on the desktop.

### **For Windows 10**

From the Start button, (select [All apps], and then) click [Brother P-touch] - [P-touch Update Software], or double-click [P-touch Update Software] on the desktop.



3 Click the [Machine update] icon.

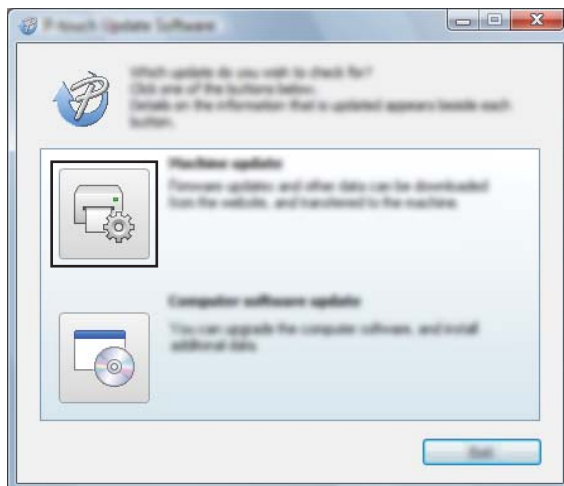

- 4 Select the **[Printer]**, ensure that **[The machine is connected correctly.]** is displayed, and then click **[OK]**.

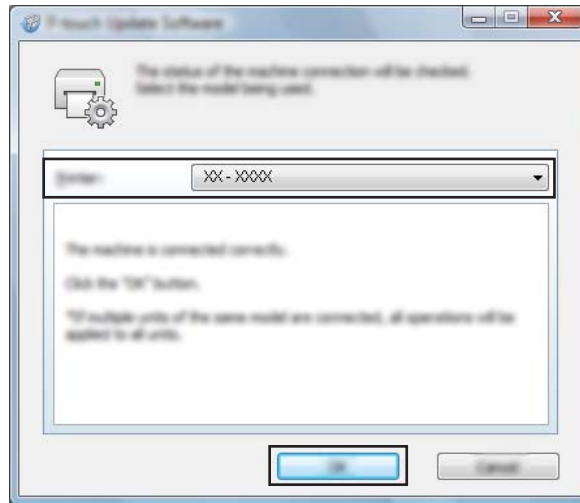

- 5 Select the **[Language]**, select the check box next to the firmware to be updated, and then click **[Transfer]**.

**! Important**

Do not turn off the printer or disconnect the cable while the data is being transferred.

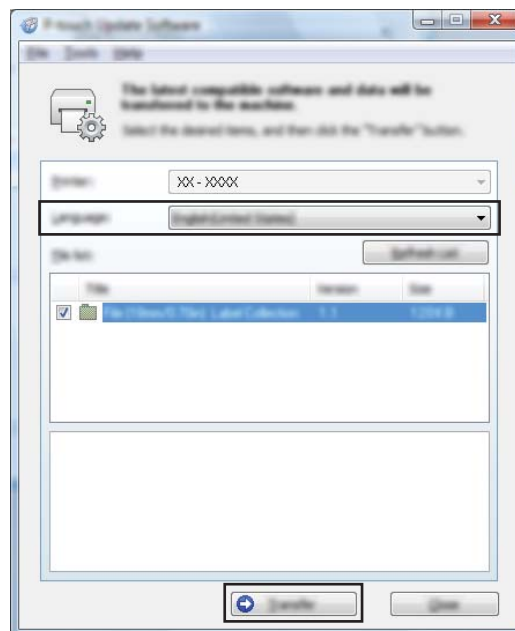

- 6 Check the content to be updated, and then click **[Start]** to begin the update. The download of the software starts.

**Note**

Do not turn off the printer during the update process.



# Wireless network (RJ-2050/2140/2150 Only)

---

Introduction	116
Changing Your Printer's Network Settings	117
Web Based Management	120

# 10 Introduction

## Network Features

Your printer can be shared on an IEEE 802.11b/g/n wireless network using the internal network print server. The print server supports various functions and methods of connection on a network supporting TCP/IP, depending on the operating system you are running.

## Changing Your Printer's Network Settings (IP Address, Subnet Mask and Gateway)

### Using the BRAdmin Light Utility

---

The BRAdmin Light utility is designed for the initial setup of Brother network connectable devices. It can also search for Brother products in a TCP/IP environment, show the status and configure basic network settings, such as the IP address.

### Installing BRAdmin Light

- 1 Visit our website ([install.brother](http://install.brother)) and download the installer for the software and manuals.
- 2 Double-click the downloaded .exe file and follow the on-screen instructions to proceed with the installation. In the dialog box for selecting which items to install, select BRAdmin Light.



#### Note

---

- If you require more advanced printer management, use the latest Brother BRAdmin Professional utility available as a download from the Brother support website at [support.brother.com](http://support.brother.com)
- If you are using firewall, anti-spyware, or antivirus software, temporarily disable them. When you are sure that you can print, re-enable them.
- The node name appears in the current BRAdmin Light window. The default node name of the print server in the printer is "BRWxxxxxxxxxxxx". ("xxxxxxxxxxxx" is based on your printer's MAC Address / Ethernet Address.)

### Setting the IP address, Subnet Mask and Gateway using BRAdmin Light

- 1 Start the BRAdmin Light utility.
  - Windows Vista / Windows 7 / Windows Server 2008 / Windows Server 2008 R2:  
Click **[Start]** - **[All Programs]** - **[Brother]** - **[BRAdmin Light]** - **[BRAdmin Light]**.
  - Windows 8 / Windows 8.1 / Windows Server 2012 / Windows Server 2012 R2:  
Click **[BRAdmin Light]** icon on **[Apps]** screen.
  - Windows 10:  
From the Start button, (select **[All apps]**, and then) click **[BRAdmin Light]** under **[Brother]**.
- 2 BRAdmin Light searches for new devices automatically.

- 3 Double-click the new, unconfigured device.

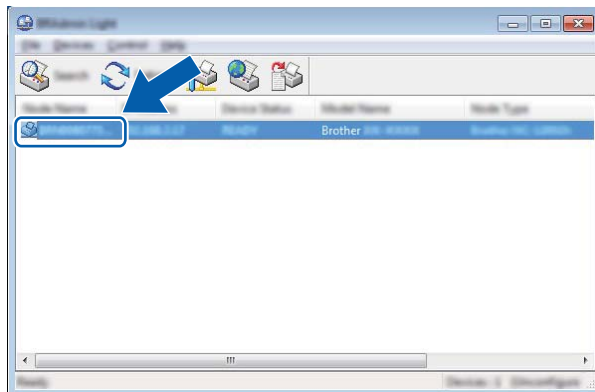

 **Note**

If you do not use a DHCP/BOOTP/RARP server, the device appears as [Unconfigured] in the BRAdmin Light utility screen.

- 4 Select [STATIC] for the [Boot Method]. Enter the [IP Address], [Subnet Mask] and [Gateway] (if needed) of your print server.

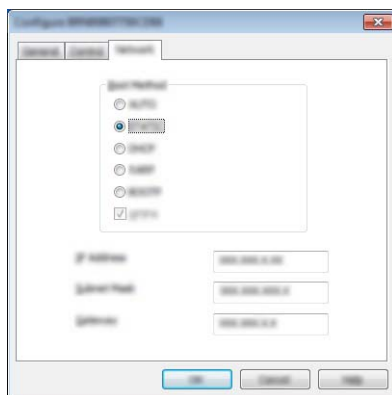

- 5 Click [OK].
- 6 With a correctly programmed IP address, the Brother print server appears in the device list.

## Other Management Utilities

Your printer can be used with the following management utilities in addition to the BRAdmin Light utility. You can change your network settings using these utilities.

### Using the Web Based Management (Web Browser)

---

A standard web browser can be used to change your print server settings using the HTTP (Hyper Text Transfer Protocol). (See *Configuring the Printer Settings Using Web Based Management (Web Browser)* on page 121.)

### Using the BRAdmin Professional Utility

---

BRAdmin Professional is a utility for more advanced management of network connected Brother devices. This utility can search for Brother products on your network, and show the device status from an easy to read Explorer style window that changes color to represent the status of each device.



#### Note

- Please use the latest version of the BRAdmin Professional utility available as a download from the Brother support website at [support.brother.com](http://support.brother.com)
  - The node name appears in the current BRAdmin Professional window. The default node name is "BRWxxxxxxxxxxxx". ("xxxxxxxxxxxx" is based on your printer's MAC Address / Ethernet Address.)
  - If you are using firewall, anti-spyware, or antivirus software, temporarily disable them. When you are sure that you can print, re-enable them.
-



## Overview

You can use a standard web browser to manage a printer on your network using HTTP. When using Web Based Management, you can do the following:

- Display your printer status information
- Change network settings such as TCP/IP information
- Display software version information of the printer and print server
- Change network and printer configuration details



---

**Note**

We recommend Microsoft® Internet Explorer® 7.0 or later or Firefox® 25.0.1 or later.

Please make sure that JavaScript and cookies are always enabled in whichever browser you use.

---

To use Web Based Management, your network must use TCP/IP, and the printer and computer must have a valid IP address.

## Configuring the Printer Settings Using Web Based Management (Web Browser)

A standard web browser can be used to change your print server settings using the HTTP (Hyper Text Transfer Protocol).

- 1 Type `http://printer_ip_address/` into your browser. (Where `printer_ip_address` is the IP address or the print server name.)

- For example (if the printer's IP address is 192.168.1.2):

`http://192.168.1.2/`



### Note

If you have edited the hosts file on your computer or are using a Domain Name System, you can also enter the DNS name of the print server. As the print server supports TCP/IP and NetBIOS, you can also enter the NetBIOS name of the print server. You can find the NetBIOS name on the printer settings page. The NetBIOS name assigned is the first 15 characters of the node name and by default it appears as "BRWxxxxxxxxxxx" where "xxxxxxxxxxx" is the Ethernet address.



- 2 You can now change the print server settings.



### Note

#### Setting a password

We recommend setting a login password to prevent unauthorized access to the Web Based Management.

- 1 Click [**Administrator**].
  - 2 Enter the password you want to use (up to 32 characters).
  - 3 Re-enter the password in [**Confirm new password**] box.
  - 4 Click [**Submit**].  
The next time you access Web Based Management, enter a password in the [**Login**] box, and then click .
- After configuring the settings, logout by clicking .

You can also set a password by clicking [**Please configure the password**] on the printer's web page if you are not setting a login password.



# Appendix

---

<b>Product Specifications</b>	123
<b>Troubleshooting</b>	125
<b>Supported Protocols and Security Features</b>	134
<b>Network Terms and Information</b>	135

# 13

## Product Specifications

Model Name	RJ-2030	RJ-2050	RJ-2140	RJ-2150
<b>Printing</b>				
Printing technology	Direct Thermal			
Print resolution	203 dpi			
Print speed (Depends on the media used.)	Maximum 6 ips (152 mm/sec) (Under Brother standard environment)			
Maximum print width	Receipt: 2" (51 mm) Label: 1.89" (48 mm)	2.12" (54 mm)		
Maximum print length	39.37" (1 m)			
Minimum print length	0.5" (12.7 mm)			
<b>Size</b>				
Weight (including battery)	Approximately 1.03 lb./465 g		Approximately 1.20 lb./545 g	
Dimensions	Approximately 3.9 (D) × 4.8 (W) × 2.2 (H) in. / 100 (D) × 122 (W) × 57 (H) mm		Approximately 3.9 (D) × 5.9 (W) × 2.9 (H) in. / 100 (D) × 151 (W) × 73 (H) mm	
<b>Interface</b>				
USB	USB Ver. 2.0 (Full Speed) (mini-B)			
Bluetooth	Ver 2.1 + EDR Supported profiles: SPP, OPP, BIP, HCRP	Ver 2.1 + EDR Supported profiles: SPP, OPP, BIP, HCRP Supported protocol: iAP	-	Ver 2.1 + EDR Supported profiles: SPP, OPP, BIP, HCRP Supported protocol: iAP
Wireless LAN	-	IEEE 802.11g/n (Wireless Direct) IEEE 802.11b/g/n (Infrastructure Mode) IEEE 802.11b/g/n (Ad-hoc Mode) <sup>2</sup>		
<b>Environment</b>				
Operating temperature	Operate: 14°F to 122°F (-10°C to 50°C) Charge: 32°F to 104°F (0°C to 40°C)			
Operating humidity	10% to 90% (No condensation, Maximum wet bulb temperature: 80.6 °F / 27 °C)			
Storage temperature	-4°F to 140°F (-20°C to 60°C) Do not leave your printer inside a car where the temperature is over 140°F (60°C).			
Storage humidity	10% to 90% (No condensation, Maximum wet bulb temperature: 113°F / 45°C)			
<b>Power supply</b>				
Battery	Rechargeable Li-ion battery: 7.2 V			
Adapter (optional)	AC adapter (15 V)			
Car adapter (optional)	Cigarette lighter car adapter (12 V (DC))			

Model Name	RJ-2030	RJ-2050	RJ-2140	RJ-2150
Maximum number of labels	6,400 labels (for continuous printing when connected using USB and using a new, fully charged rechargeable Li-ion battery) Tested using Brother's print test data (13% coverage, 2" × 1" (51 × 25.4 mm)) at 73.4°F (23°C).			
Charging time	3 hours (when charging at 73.4°F (23°C) with the printer turned off, and using a new rechargeable Li-ion battery)			
<b>Media specification</b>				
Media type	Receipt, Label <sup>1</sup>		Receipt, Label	
Media width	2" (51mm)		1" ~ 2.28" (25.4mm ~ 58mm)	
Gap between labels	-		0.12" (3 mm) or more	
Thickness	Receipt: 2.3 mil to 3.5 mil (0.058 mm to 0.090 mm) Label: 3.2 mil to 6.7 mil (0.080 mm to 0.170 mm) <sup>1</sup>			
Roll outside diameter (max)	1.57" (40 mm)		2.36" (60 mm)	
Core diameter (min)	Receipt, Label <sup>1</sup> : 0.41" (10.2 mm)		Receipt, Label: 0.41" (10.2 mm)	
Media sensor	Reflective		Transmissive, Reflective	
<b>Compatible operating systems</b>				
See <a href="http://support.brother.com">support.brother.com</a> for a complete and updated list of software.				

<sup>1</sup> For RJ-2030/2050: Only when there are black marks on the back of the backing paper.

<sup>2</sup> Not all computers, mobile devices, and operating systems, may support Ad-hoc mode.

## Overview

This chapter explains how to resolve typical problems you may encounter when using the printer. If you have any problems with the printer, first make sure you have performed the following tasks correctly:

- Install the battery (see *Installing the Battery* on page 6).
- Remove all protective packaging from the printer.
- Install and select the correct printer driver (see *Installing the Printer Driver and Software (When Using a Computer)* on page 23).
- Connect the printer to a computer or mobile device (see *Connecting the Printer to a Computer or Mobile Device* on page 24).
- Close the media roll compartment cover completely.
- Insert the media roll correctly (see *Inserting the Paper or Label Roll* on page 12).

If you still have problems, read the troubleshooting tips in this chapter. If, after reading this chapter, you are unable to resolve your problem, visit the Brother support website at [support.brother.com](http://support.brother.com)

## Printing Problems

Problem	Solution
The printer does not print, or there is a printing error.	<ul style="list-style-type: none"> <li>■ Is the cable loose (when you are using a USB cable)? Check that the cable is connected securely.</li> <li>■ Is the media roll installed correctly? If not, remove the media roll and reinstall. (See <i>Inserting the Paper or Label Roll</i> on page 12.)</li> <li>■ Is there enough roll remaining? If not, install a new media roll.</li> <li>■ Is the media roll compartment cover open? Check that the media roll compartment cover is closed.</li> <li>■ Has a print error or transmission error occurred? Turn off the printer and on again. If the problem still occurs, contact Brother Customer Service at 1-800-255-0415.</li> <li>■ Are the roll guides not touching the sides of the media roll? (RJ-2140/2150 only) Move the roll guides against the sides of the media roll. (See <i>Inserting the Paper or Label Roll</i> on page 12.)</li> </ul>

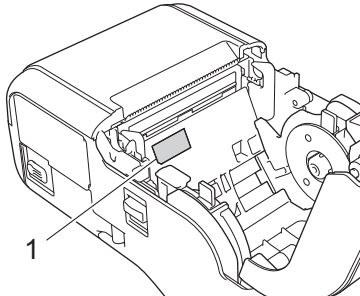
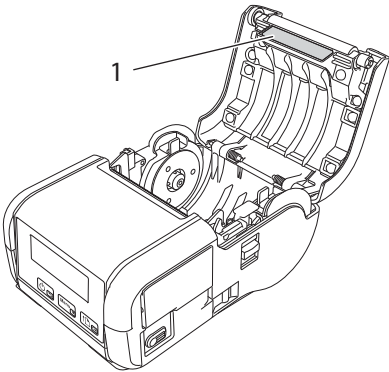
Problem	Solution
Your printer does not feed paper.	<ul style="list-style-type: none"> <li>■ Is there dirt or lint on the roller preventing it from rolling freely? Clean the roller. (See <i>Roller Maintenance</i> on page 75.)</li> <li>■ Check that the ejection path of the paper is not blocked.</li> <li>■ Check that the media roll is set correctly by removing the media roll and installing it again. (See <i>Inserting the Paper or Label Roll</i> on page 12.)</li> <li>■ Ensure that the media roll compartment cover is closed correctly.</li> </ul>
Your printer feeds paper continuously.	<ul style="list-style-type: none"> <li>■ Open the media roll compartment cover.</li> <li>■ Press the  (Power) button to cancel the print job.</li> <li>■ Turn your printer off.</li> </ul>
Does not stop in between labels.	<ul style="list-style-type: none"> <li>■ Check that you entered the media information correctly. You can set the media information using Paper Size Setup in the Printer Setting Tool.</li> <li>■ Check that the sensor is not dirty. If the sensor is dirty, wipe it with a dry cotton swab.</li> </ul> <div style="text-align: center; margin: 20px 0;">     </div> <p><b>1 Media sensor</b></p> <ul style="list-style-type: none"> <li>■ Check that there are no items blocking the sensor.</li> </ul>

Problem	Solution
<p>When printing via the USB cable, the printer repeatedly pauses and then continues printing.</p>	<p>Is the printer set for sequential printing?                      If so, set print mode to buffered printing.</p> <p>For Windows Vista / Windows Server 2008:                      Open printer properties from <b>[Control Panel] - [Hardware and Sound] - [Printers]</b>, click the printer you want, and select <b>[Select printing preferences]</b>. Click the <b>[Other]</b> tab and select the option <b>[After one page of data is received]</b>.</p> <p>For Windows 7 / Windows 8 / Windows 8.1 / Windows Server 2008 R2 / Windows Server 2012 / Windows Server 2012 R2:                      Open printer properties from <b>[Devices and Printers]</b>, right-click the printer you want, and select <b>[Printing Preference]</b>. Click the <b>[Other]</b> tab and select the option <b>[After one page of data is received]</b>.</p> <p>For Windows 10:                      Open printer properties from <b>[Control Panel] - [Hardware and Sound] - [Devices and Printers]</b>, right-click the printer you want, and select <b>[Printing Preference]</b>. Click the <b>[Other]</b> tab and select the option <b>[After one page of data is received]</b>.</p>
<p>An error occurs when the roll cannot be fed to the beginning of the printing.</p>	<p>If a feed error occurs, use the Paper Size Setup of the Printer Setting Tool to assign the correct paper settings to the printer.</p>

## Printed Image Problems





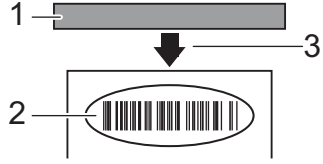



Problem	Solution
<p>Printed paper contains streaks or poor quality characters, or paper is not fed correctly.</p>	<p>Is the print head or roller dirty?                      Although the print head generally remains clean under normal use, lint or dirt from the roller may become stuck on the printer head. If this occurs, clean the roller (see <i>Roller Maintenance</i> on page 75).</p>
<p>The print quality is poor.</p>	<ul style="list-style-type: none"> <li>■ Is there dust or dirt on the print head or roller preventing it from turning freely?                      Clean the print head or roller (see <i>Print Head Maintenance</i> on page 74 and <i>Roller Maintenance</i> on page 75).</li> <li>■ Adjust the printing density. The print density can be specified in the Printer Setting Tool.</li> </ul>





Problem	Solution
Printed barcodes cannot be read.	<ul style="list-style-type: none"> <li>■ Print labels so that barcodes are aligned with the print head as shown below.</li> </ul> <div style="text-align: center; margin: 10px 0;">  </div> <ul style="list-style-type: none"> <li><b>1 Print head</b></li> <li><b>2 Barcode</b></li> <li><b>3 Printing orientation</b></li> </ul> <ul style="list-style-type: none"> <li>■ Try using another barcode reader.</li> <li>■ Set <b>[Print Speed]</b> to a slower option. The print speed can be specified in the Printer Setting Tool. (See <i>Device Settings</i> on page 52.)</li> <li>■ Adjust <b>[Print Density]</b>. The print density can be specified in the Printer Setting Tool. (See <i>Device Settings</i> on page 52.)</li> <li>■ This printer is not designed exclusively for creating bar code labels. Always check that bar code labels can be read by the bar code reader.</li> </ul>

## Printer Problems



Problem	Solution
The LED indicator or the LCD is not lit.	<ul style="list-style-type: none"> <li>■ Is the battery inserted correctly? Check that the battery is inserted correctly. If it is, check that the battery has sufficient charge remaining.</li> <li>■ If the LED indicator or the LCD still does not light up, contact Brother Customer Service at 1-800-255-0415.</li> </ul>
A data transmission error appears on your computer.	<ul style="list-style-type: none"> <li>■ Is the correct port selected? Check that the correct port is selected.</li> <li>■ Is the printer in cooling mode? The message <b>[Cooling]</b> is displayed on the LCD. Wait until the message disappears and then try printing again.</li> <li>■ Is someone printing via the network? If you try to print while other users are printing large amounts of data, the printer is unable to accept your print job until the current print jobs are completed. If this occurs, send the print job again after the other jobs are completed.</li> </ul>

Problem	Solution
<p>I want to reset the printer/delete the data transferred from the computer.</p>	<p>To reset the printer, perform the following procedure:</p> <ol style="list-style-type: none"> <li>1 Press and hold the  (Power) button to turn the printer off.</li> <li>2 Press and hold the  (Feed) button and the  (Power) button for about three seconds.</li> <li>3 While pressing the  (Power) button, press the  (Feed) button six times.</li> <li>4 Release the  (Power) button.</li> </ol> <p>All the transferred data from the computer will be deleted and the printer settings will be reset to the factory settings.</p>
<p>I want to cancel the current print job.</p>	<p>Make sure that the printer is On, and then press the  (Power) button.</p>
<p>Print head, motor, or battery is too hot.</p>	<p>The thermal head, motor, or battery is too hot.</p> <ul style="list-style-type: none"> <li>■ <b>Head:</b> If the thermal head becomes too hot, the thermal head may produce imaging on the paper in areas not intended to be printed. This condition is normal when printing documents with a lot of “black” content. The printer will stop and resume printing after the print head has cooled down. To avoid or delay this condition, print using a lighter density setting, reduce the amount of black space being printed (for example, remove background shading and colors in graphs and presentation documents), and make sure that the printer has adequate ventilation and is not located in an enclosed space.</li> <li>■ <b>Motor or battery:</b> Do not use the printer continuously. If the printer is used continuously, the motor or battery will become too hot. In this case, the printer will stop and resume printing after the motor or battery has cooled down.</li> </ul> <p> <b>Note</b> _____ This condition may occur more often when the printer is used at high altitude (more than about 10,000 feet) due to a lower air density available to cool the printer.</p>
<p>Printer is in boot mode.</p>	<p>If you remove the Li-ion battery from your printer while the firmware is being updated, your printer will restart in boot mode.</p>

## Network Setup Problems

Problem	Solution
You are using security software.	<ul style="list-style-type: none"> <li>■ Confirm your settings in the installer dialog box.</li> <li>■ Allow access when the security software alert message appears during the printer installation.</li> </ul>
Your security settings (SSID/Network Key) are incorrect.	<p>Recheck and choose the correct security settings.</p> <ul style="list-style-type: none"> <li>■ The manufacturer's name or model number of the WLAN access point/router may be used as the default security settings.</li> <li>■ See the instructions supplied with your WLAN access point/router for information on how to find the security settings.</li> <li>■ Ask the manufacturer of your WLAN access point/router or ask your Internet provider or network administrator.</li> </ul>
Your printer cannot connect to the host device using Wi-Fi or Bluetooth.	<ul style="list-style-type: none"> <li>■ Move your printer within about 3.3 feet (one meter) of the mobile device when you configure the Wi-Fi network settings.</li> <li>■ Move your printer to an obstruction-free area.</li> </ul>
Your printer cannot print using Wi-Fi or Bluetooth.	<ul style="list-style-type: none"> <li>■ If a wireless computer, Bluetooth-equipped device, microwave oven, digital cordless phone, or other device is near your printer or the wireless access point/router, move the device away from your printer or wireless access point/router.</li> </ul>
You are using MAC Address filtering.	<p>You can confirm the MAC address by printing out the printer information. Press and hold the  (Feed) button on your printer to print the printer information.</p> <p>Set the Wi-Fi access point/router so that the MAC address of the printer is allowed for connections.</p> <p>For more information, see the instructions supplied with your Wi-Fi access point/router.</p>
Your Wi-Fi access point/router is in stealth mode (not broadcasting the SSID).	<ul style="list-style-type: none"> <li>■ Enter the correct SSID name during the installation or when using <b>[Communication settings]</b> in the Printer Setting Tool.</li> <li>■ Check the SSID name in the instructions supplied with your WLAN access point/router and set up your wireless network again.</li> </ul>
Your printer is not connected correctly to the network.	<p>Check the WLAN icon on the LCD.</p> <p> : The network is connected correctly.</p> <p> : Your printer is searching for the network.</p> <p>No icon : The wireless network settings are disabled.</p>
I have checked and tried all of the above, but still cannot complete the wireless configuration.	<p>Turn your printer off and on again. Then try and configure the Wi-Fi settings again.</p>



## Cannot Print over the Network Printer Is Not Found on the Network Even after Successful Installation

Problem	Solution
You are using security software.	See <i>Security Software Problems</i> on page 131.
Your printer is not assigned with an available IP address.	<ul style="list-style-type: none"> <li>■ Confirm the IP address and the Subnet Mask. Verify that both the IP addresses and Subnet Masks of your computer and your printer are correct and located on the same network. For more information on how to verify the IP address and the Subnet Mask, ask the network administrator.</li> <li>■ Confirm your IP address, Subnet Mask and other network settings with <b>[Communication settings]</b> in the Printer Setting Tool. See <i>Changing the Printer Settings</i> on page 34.</li> </ul>
Your previous printing job failed.	<ul style="list-style-type: none"> <li>■ If the failed printing job is still in your computer's print queue, delete it. When using Windows 7: , <b>[Devices and Printers]</b> and select your printer from <b>[Printers and Faxes]</b>. Double-click your printer's icon, and then select <b>[Cancel All Documents]</b> in the <b>[Printer]</b> menu.</li> </ul>
Your printer is not connected correctly to the network.	<p>Check the WLAN icon on the LCD.</p> <p> : The network is connected correctly.</p> <p> : Your printer is searching for the network.</p> <p>No icon : The wireless network settings are disabled.</p>
I have checked and tried all the above, but my printer does not print.	Uninstall the printer driver and the software, and then reinstall them.

## Security Software Problems

Problem	Solution
You did not choose to allow access when the security alert dialog box appeared during either the standard installation, BRAdmin Light installation, or when printing.	If you did not choose to accept the security alert dialog box, the firewall function of your security software may be rejecting access. Some security software might block access without showing a security alert dialog box. To allow access, see the instructions of your security software or ask the manufacturer.
Incorrect port numbers are being used for the Brother network features.	<p>The following port numbers are used for Brother network features:</p> <ul style="list-style-type: none"> <li>■ BRAdmin Light → Port number 161 / Protocol UDP</li> </ul> <p>For more information about how to open the port, see the instructions for the security software or ask the manufacturer.</p>

## Checking the Operation of Network Devices

Problem	Solution
Your printer and Wi-Fi access point/router are not turned on.	Make sure you have confirmed all instructions in <i>Overview</i> on page 125.
I do not know my printer's network settings, such as the IP address.	Check <b>[Communication settings]</b> in the Printer Setting Tool. See <i>Changing the Printer Settings</i> on page 34.
Your printer is not connected correctly to the network.	Check the WLAN icon on the LCD.  : The network is connected correctly.  : Your printer is searching for the network. No icon : The wireless network settings are disabled.

## Error Messages from the Printer

Error Message	Cause/Remedy
No Template Selected	<ul style="list-style-type: none"> <li>■ There is no template with the specified number. Specify a correct number.</li> <li>■ When printing a template, an error is indicated if the specified template does not exist.</li> </ul>
Invalid Database Record	<ul style="list-style-type: none"> <li>■ There is no database with the specified number. Specify a correct number.</li> <li>■ An error is indicated if the search for a template with a linked database fails.</li> </ul>
Media Error! Check Loading	<ul style="list-style-type: none"> <li>■ Is the correct media roll installed? Check that the correct media, for example, type (die-cut label or continuous length tape) and die-cut label size, is installed.</li> <li>■ Is the media roll installed correctly? If not, remove the media roll, and then reinstall it. For details, see <i>Inserting the Paper or Label Roll</i> on page 12.</li> <li>■ Are the roll guides touching the sides of the media roll? (RJ-2140/2150 only) Move the roll guides against the side of the media roll. For details, see <i>Inserting the Paper or Label Roll</i> on page 12.</li> <li>■ Is enough of the roll remaining? If not, install a new media roll.</li> </ul>
Cover Open Close Cover	Is the media roll compartment cover open? Check that the media roll compartment cover is closed.

Error Message	Cause/Remedy
Communication Error	<ul style="list-style-type: none"> <li>■ Transfer of the data failed. When sending a template as a .blf file, an error is indicated if the model name in the file is different.</li> <li>■ Has the wireless LAN or Bluetooth connection been interrupted? The wireless LAN or Bluetooth connection was interrupted. Turn off the printer and on again.</li> </ul>
WPS did not connect Try to connect again?	<ul style="list-style-type: none"> <li>■ The access point could not be found.</li> <li>■ An access point for establishing a connection could not be specified.</li> </ul>
Mass Storage Operation error!	<p>Is the printer in mass storage mode?</p> <p>An error is indicated if the file system becomes corrupted or a file is copied while a mass storage file is being processed. Turn off the printer.</p>
Recharge Battery!	<p>Does the rechargeable battery have a low charge?</p> <p>Use the AC adapter and AC power cord to connect the printer to an AC power outlet, or use the car adapter to connect the printer to a DC power outlet to charge the battery.</p>
System Error! XX	<p>If the error message is displayed, contact Brother customer service.</p>
Memory Full!	<ul style="list-style-type: none"> <li>■ Print jobs exceeding 39.37" (1 m) or incompatible files, cannot be printed.</li> <li>■ Make sure the data you transfer does not exceed the capacity of the user storage area.</li> </ul>

<b>Interface</b>	Wireless	IEEE 802.11b/g/n (Infrastructure Mode)
	(RJ-2050/2140/2150 only)	IEEE 802.11b/g/n (Ad-Hoc Mode)
		IEEE 802.11g/n (Wireless Direct Mode)
<b>Network (common)</b>	Protocol (IPv4)	ARP, RARP, BOOTP, DHCP, APIPA (Auto IP), mDNS, WINS, NetBIOS name resolution, LPR/LPD, Custom Raw Port/Port9100, FTP Server, TFTP client and server, SNTP client, ICMP, LLMNR responder, SNMPv1/v2c
	Protocol (IPv6)	NDP, RA, LPR/LPD, mDNS, Custom Raw Port/Port9100, FTP Server, TFTP client and server, ICMP, LLMNR responder, SNMPv1/v2c
<b>Network (Security)</b>	Wireless	WEP 64/128 bit, WPA/WPA2-PSK, LEAP, EAP-FAST, PEAP, EAP-TTLS, EAP-TLS

## Types of Network Connections and Protocols

You will find basic information about the advanced network features of the printer, along with general networking and common terms.

The supported protocols and network features differ depending on the model you are using.

### Types of Network Connections

---

#### Peer-to-Peer printing using TCP/IP

In a Peer-to-Peer environment, each computer directly sends and receives data to each device. There is no central server controlling file access or printer sharing.

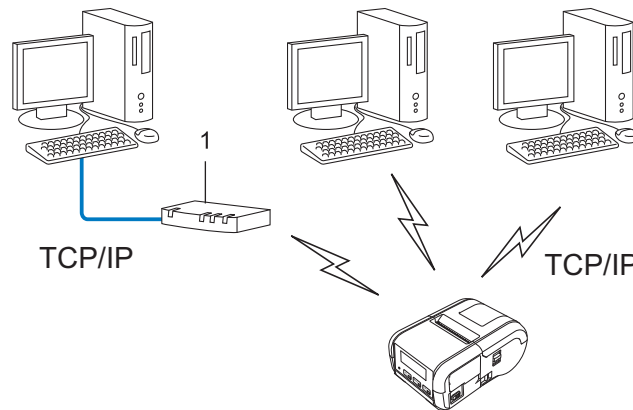

#### 1 Router

- In a smaller network of 2 or 3 computers, we recommend the Peer-to-Peer printing method as it is easier to configure than the Network Shared printing method. See *Network Shared printing* on page 136.
- Each computer must use the TCP/IP Protocol.
- Your printer needs an appropriate IP address configuration.
- If you are using a router, the Gateway address must be configured on the computers and your printer.



## Network Shared printing

In a Network Shared environment, each computer sends data via a centrally controlled computer. This type of computer is often called a “Server” or a “Print Server”. Its job is to control the printing of all print jobs.

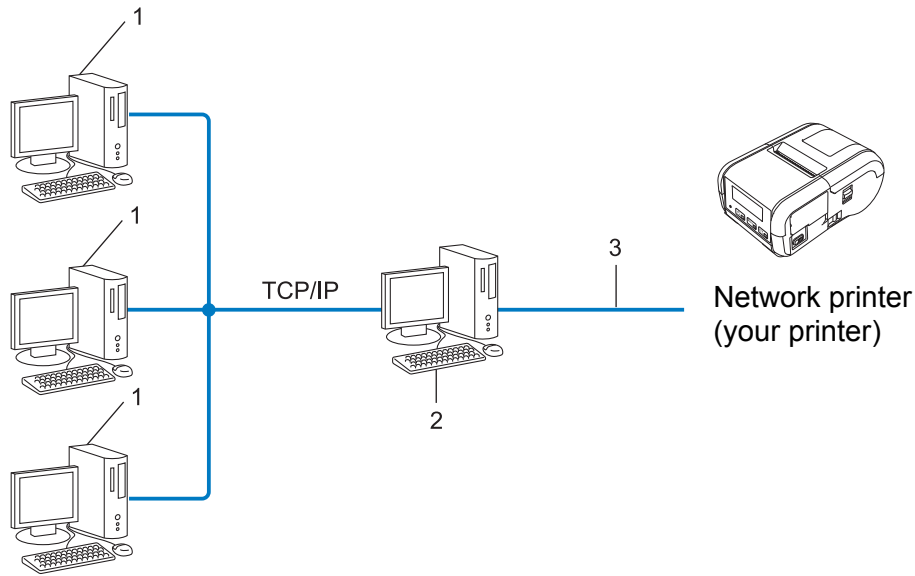

- 1 Client computer
- 2 Also known as “Server” or “Print server”
- 3 TCP/IP or USB

- In a larger network, we recommend a Network Shared printing environment.
- The “server” or the “print server” must use the TCP/IP print protocol.
- Your printer needs to have an appropriate IP address configuration, unless the printer is connected via the USB interface at the server.

# Configuring Your Printer for a Network

## IP Addresses, Subnet Masks and Gateways

---

To use the printer in a networked TCP/IP environment, you need to configure its IP address and subnet mask. The IP address you assign to the print server must be on the same logical network as your host computers. If it is not, you must correctly configure the subnet mask and the gateway address.

### IP address

An IP address is a series of numbers that identifies each device connected to a network. An IP address consists of four numbers separated by dots. Each number is between 0 and 254.

■ For example in a small network, you would normally change the final number:

- 192.168.1.1
- 192.168.1.2
- 192.168.1.3

### How the IP address is assigned to your print server:

If you have a DHCP/BOOTP/RARP server on your network, the print server will automatically obtain its IP address from that server.



#### Note

---

On smaller networks, the DHCP server may also be the router.

---

If you do not have a DHCP/BOOTP/RARP server, the Automatic Private IP Addressing (APIPA) protocol will automatically assign an IP address from the range 169.254.0.1 to 169.254.254.254. The subnet mask is automatically set to 255.255.0.0 and the gateway address is set to 0.0.0.0.

By default, the APIPA protocol is enabled. If you want to disable the APIPA protocol, use BRAdmin Light or Web Based Management (web browser).

## Subnet mask

Subnet masks restrict network communication.

■ For example, Computer 1 can talk to Computer 2

- Computer 1

IP Address: 192.168.1.2

Subnet Mask: 255.255.255.0

- Computer 2

IP Address: 192.168.1.3

Subnet Mask: 255.255.255.0

The 0 in the Subnet mask signifies that there is no limit to communication at this part of the address. In the above example, this means, we can communicate with any device with an IP address that begins with 192.168.1.x. (where x is a number between 0 and 254).

## Gateway (and router)

A gateway is a network point that acts as an entrance to another network and sends data transmitted via the network to an exact destination. The router knows where to direct data that arrives at the gateway. If a destination is located on an external network, the router transmits data to the external network. If your network communicates with other networks, you may need to configure the Gateway IP address. If you do not know the Gateway IP address contact your Network Administrator.

# Wireless Network Terms and Concepts

## Security Terms

---

### Authentication and encryption

Most wireless networks use some kind of security settings. These security settings define the authentication (how the device identifies itself to the network) and encryption (how the data is encrypted as it is sent on the network). **If you do not correctly specify these options when you are configuring your Brother wireless printer, it will not be able to connect to the wireless network.** Therefore, care must be taken when configuring these options.

### Authentication and Encryption methods for a personal wireless network

A personal wireless network is a small network, for example using your printer in a wireless network at home, without IEEE 802.1x support.

If you want to use your printer in an IEEE 802.1x supported wireless network, see *Authentication and Encryption methods for an enterprise wireless network* on page 141.

### Authentication methods

#### ■ Open system

Wireless devices are allowed to access the network without any authentication.

#### ■ Shared key

A secret pre-determined key is shared by all devices that will access the wireless network.

The Brother wireless printer uses a WEP key as the pre-determined key.

#### ■ WPA-PSK

Enables a Wi-Fi Protected Access Pre-shared key (WPA-PSK), which enables the Brother wireless printer to associate with access points using TKIP for WPA-PSK.

#### ■ WPA2-PSK

Enables a Wi-Fi Protected Access Pre-shared key (WPA2-PSK), which enables the Brother wireless printer to associate with access points using AES for WPA2-PSK (WPA-Personal).

#### ■ WPA/WPA2-PSK

Enables a Wireless Protected Access Pre-shared key (WPA-PSK/WPA2-PSK), which enables the Brother wireless printer to associate with access points using TKIP for WPA-PSK or AES for WPA-PSK and WPA2-PSK (WPA-Personal).

### Encryption methods

#### ■ None

No encryption method is used.

#### ■ WEP

When using WEP (Wired Equivalent Privacy), the data is transmitted and received with a secure key.

### ■ TKIP

TKIP (Temporal Key Integrity Protocol) provides per-packet key mixing, a message integrity check and rekeying mechanism.

### ■ AES

Advanced Encryption Standard (AES) provides stronger data protection by using a symmetric-key encryption.

#### When [Communication Mode] is set to [Ad-hoc]

Authentication Method	Encryption Mode
Open System	None
	WEP

#### When [Communication Mode] is set to [Infrastructure]

Authentication Method	Encryption Mode
Open System	None
	WEP
Public Key Authentication	WEP
WPA-PSK	TKIP
WPA2-PSK	AES
WPA/WPA2-PSK	TKIP
	AES

#### Network key

##### ■ Open system/Shared key with WEP

This key is a 64-bit or 128-bit value that must be entered in an ASCII or hexadecimal format.

- 64 (40) bit ASCII:  
Uses 5 text characters. e.g. "WSLAN" (this is case sensitive)
- 64 (40) bit hexadecimal:  
Uses 10 digits of hexadecimal data. e.g. "71f2234aba"
- 128 (104) bit ASCII:  
Uses 13 text characters. e.g. "Wirelesscomms" (this is case sensitive)
- 128 (104) bit hexadecimal:  
Uses 26 digits of hexadecimal data. e.g. "71f2234ab56cd709e5412aa2ba"

##### ■ WPA-PSK/WPA2-PSK and TKIP or AES, WPA2 with AES

Uses a Pre-Shared Key (PSK) that is 8 or more characters in length, up to a maximum of 63 characters.

## Authentication and Encryption methods for an enterprise wireless network

An enterprise wireless network is a large network with IEEE 802.1x support. If you configure your printer in an IEEE 802.1x supported wireless network, you can use the following authentication and encryption methods:

### Authentication methods

#### ■ LEAP (For wireless network)

Cisco LEAP (Light Extensible Authentication Protocol) has been developed by Cisco Systems, Inc. which uses a user ID and password for authentication.

#### ■ EAP-FAST

EAP-FAST (Extensible Authentication Protocol-Flexible Authentication via Secured Tunnel) has been developed by Cisco Systems, Inc. which uses a user ID and password for authentication, and symmetric key algorithms to achieve a tunnelled authentication process.

The printer supports the following inner authentication methods:

- EAP-FAST/NONE
- EAP-FAST/MS-CHAPv2
- EAP-FAST/GTC

#### ■ PEAP

PEAP (Protected Extensible Authentication Protocol) has been developed by Microsoft Corporation, Cisco Systems and RSA Security. PEAP creates an encrypted SSL (Secure Sockets Layer)/TLS (Transport Layer Security) tunnel between a client and an authentication server, for sending a user ID and password. PEAP provides mutual authentication between the server and the client.

The printer supports the following inner authentication methods:

- PEAP/MS-CHAPv2
- PEAP/GTC

#### ■ EAP-TTLS

EAP-TTLS (Extensible Authentication Protocol Tunnelled Transport Layer Security) has been developed by Funk Software and Certicom. EAP-TTLS creates a similar encrypt SSL tunnel to PEAP, between a client and an authentication server, for sending a user ID and password. EAP-TTLS provides mutual authentication between the server and the client.

The printer supports the following inner authentication methods:

- EAP-TTLS/CHAP
- EAP-TTLS/MS-CHAP
- EAP-TTLS/MS-CHAPv2
- EAP-TTLS/PAP

#### ■ EAP-TLS

EAP-TLS (Extensible Authentication Protocol Transport Layer Security) requires digital certificate authentication both at a client and an authentication server.

## Encryption methods

### ■ TKIP

TKIP (Temporal Key Integrity Protocol) provides a per-packet key mixing a message integrity check and rekeying mechanism.

### ■ AES

Advanced Encryption Standard (AES) provides stronger data protection by using a symmetric-key encryption.

### ■ CKIP

The original Key Integrity Protocol for LEAP by Cisco Systems, Inc.

## When [Communication Mode] is set to [Infrastructure]

Authentication Method	Encryption Mode
LEAP	CKIP
EAP-FAST/NONE	TKIP
	AES
EAP-FAST/MS-CHAPv2	TKIP
	AES
EAP-FAST/GTC	TKIP
	AES
PEAP/MS-CHAPv2	TKIP
	AES
PEAP/GTC	TKIP
	AES
EAP-TTLS/CHAP	TKIP
	AES
EAP-TTLS/MS-CHAP	TKIP
	AES
EAP-TTLS/MS-CHAPv2	TKIP
	AES
EAP-TTLS/PAP	TKIP
	AES
EAP-TLS	TKIP
	AES

### **User ID and password**

The following security methods support a user ID less than 64 characters and a password less than 32 characters in length.

- LEAP
- EAP-FAST
- PEAP
- EAP-TTLS
- EAP-TLS (For user ID)



**brother**