

eZ.HD

ELUX16x2

16CH, H.264, 1080p FHD Hybrid DVR

User's Manual



Copyright © EverFocus Electronics Corp.
Release Date: July, 2016

EVERFOCUS ELECTRONICS CORPORATION

ELUX16x2 FHD Hybrid DVR

User's Manual

© 1995-2016 EverFocus Electronics Corp.
www.everfocus.com.tw

Disclaimer

All the images including product pictures or screen shots in this document are for example only. The images may vary depending on the product and software version. Information contained in this document is subject to change without notice.

Copyright

All rights reserved. No part of the contents of this manual may be reproduced or transmitted in any form or by any means without written permission of the EverFocus Electronics Corporation.

QuickTime is a registered trademark of the Apple Computer, Inc.

Windows is a registered trademark of the Microsoft Corporation.

Linksys is a registered trademark of the Linksys Corporation.

D-Link is a registered trademark of the D-Link Corporation.

DynDNS is a registered trademark of the DynDNS.org Corporation.

Other product and company names mentioned herein may be the trademarks of their respective owners.

Safety Precautions

- Refer all work related to the installation of this product to qualified service personnel or system installers.
- Do not block the ventilation openings or slots on the cover.
- Do not drop metallic parts through slots. This could permanently damage the appliance. Turn the power off immediately and contact qualified service personnel for service.
- Do not attempt to disassemble the appliance. To prevent electric shock, do not remove screws or covers. There are no user-serviceable parts inside. Contact qualified service personnel for maintenance. Handle the appliance with care. Do not strike or shake, as this may damage the appliance.
- Do not expose the appliance to water or moisture, nor try to operate it in wet areas. Do take immediate action if the appliance becomes wet. Turn the power off and refer servicing to qualified service personnel. Moisture may damage the appliance and also may cause electric shock.
- Do not use strong or abrasive detergents when cleaning the appliance body. Use a dry cloth to clean the appliance when it is dirty. When the dirt is hard to remove, use a mild detergent and wipe gently.
- Do not overload outlets and extension cords as this may result in a risk of fire or electric shock.
- Do not operate the appliance beyond its specified temperature, humidity or power source ratings. Do not use the appliance in an extreme environment where high temperature or high humidity exists. Use the DVR at temperatures within 0°C~40°C / 32°F~104°F (Storage). The input power source is 12VDC 8A.
- **Read Instructions**
All the safety and operating instructions should be read before the unit is operated.
- **Retain Instructions**
The safety and operating instructions should be retained for future reference.
- **Heed Warnings**
All warnings on the unit and in the operating instructions should be adhered to.
- **Follow Instructions**
All operating and use instructions should be followed.

- **Cleaning**
Unplug the unit from the outlet before cleaning. Do not use liquid cleaners, abrasive or aerosol cleaners. Use a damp cloth for cleaning.
- **Attachments**
Do not use attachments not recommended by the product manufacturer as they may cause hazards.
- **Water and Moisture**
Do not use this unit near water—for example, near a bath tub, wash bowl, kitchen sink, or laundry tub, in a wet basement, near a swimming pool, in an unprotected outdoor installation, or any area which is classified as a wet location.
- **Servicing**
Do not attempt to service this unit by yourself as opening or removing covers may expose you to dangerous voltage or other hazards. Refer all servicing to qualified service personnel.
- **Power Cord Protection**
Power supply cords should be routed so that they are not likely to be walked on or pinched by items placed upon or against them, paying particular attention to cords and plugs, convenience receptacles, and the point where they exit from the appliance.
- **Object and Liquid Entry**
Never push objects of any kind into this unit through openings as they may touch dangerous voltage points or short-out parts that could result in a fire or electric shock. Never spill liquid of any kind on the unit.
- **Battery**
Risk of explosion if battery is replaced by an incorrect type. Dispose of used batteries according to the instructions.
 - a. Use only two AAA dry cell batteries.
 - b. Do not dispose of the batteries in a fire as it may explode.
- **RTC (Real Time Clock) Battery**
When encounter failure of time calibration of your DVR, the issue may be caused by running-out of RTC battery. Users will have to change the RTC battery on the main board of the DVR.
- **Uninterruptible Power Supply (UPS)**
Please use an uninterruptible power supply (UPS) to protect your equipment from sudden, transient increases and decreases in electrical power.



ATTENTION! This is a class A product which may cause radio interference in a domestic environment; in this case, the user may be urged to take adequate measures.



Federal Communication Commission Interference Statement

This equipment has been tested and found to comply with the limits for a Class B digital device, pursuant to Part 15 of the FCC Rules. These limits are designed to provide reasonable protection against harmful interference in a residential installation. This equipment generates, uses and can radiate radio frequency energy and, if not installed and used in accordance with the instructions, may cause harmful interference to radio communications. However, there is no guarantee that interference will not occur in a particular installation. If this equipment does cause harmful interference to radio or television reception, which can be determined by turning the equipment off and on, the user is encouraged to try to correct the interference by one of the following measures:

- Reorient or relocate the receiving antenna.
- Increase the separation between the equipment and receiver.
- Connect the equipment into an outlet on a circuit different from that to which the receiver is connected.
- Consult the dealer or an experienced radio/TV technician for help.

FCC Caution: Any changes or modifications not expressly approved by the party responsible for compliance could void the users' authority to operate this equipment.



This Product is RoHS compliant.

WEEE



Your EverFocus product is designed and manufactured with high quality materials and components which can be recycled and reused. This symbol means that electrical and electronic equipment, at their end-of-life, should be disposed of separately from your household waste. Please, dispose of this equipment at your local community waste collection/recycling centre. In the European Union there are separate collection systems for used electrical and electronic product.

Please, help us to conserve the environment we live in!



This product complies with the High-Definition Multimedia Interface (HDMI) Specification Adopter Agreement.

The information in this manual was current upon publication. The manufacturer reserves the right to revise and improve his products. Therefore, all specifications are subject to change without prior notice. Manufacturer is not responsible for misprints or typographical errors. Please read this manual carefully before installing and using this unit. Be sure to keep it handy for later reference.

TABLE OF CONTENTS

1. Introduction.....	1
1.1 Features.....	3
1.2 eZ. Controller Function Description	4
1.3 Packing List	6
1.4 Optional Accessories	7
1.5 Dimensions	7
1.6 Front Panel.....	8
1.7 Rear Panel.....	10
2. Installation.....	12
2.1 Hard Disk Installation.....	12
2.1.1 Hard Disk Compatibility List	14
2.2 Rack Mount.....	14
2.3 Basic Connection	15
2.3.1 Monitor Connection	16
2.3.2 Alarm I / O	17
2.3.3 RS-485 Port.....	18
2.4 Turning On / Off the Power	18
2.5 Checking the Dynamic IP Address	19
2.6 Connecting the DVR to the Network.....	24
2.6.1 Router or LAN Connection	24
2.6.2 Direct High-Speed Connection	27
2.6.3 One-to-One Connection	28
3. Mouse and Front Panel Button Operation	32
3.1 USB Mouse Operation	32
3.1.1 How to Select a Channel / Enable Audio.....	32
3.1.2 OSD Root Menu.....	33
3.1.3 Field Input Options.....	33
3.2 Front Panel Buttons Operation	34
3.2.1 Front Panel Review	34
3.2.2 How to Select a Channel / Enable Audio.....	34
3.2.3 OSD Root Menu.....	35
3.2.4 Field Input Options.....	35
3.3 General Operation	37
3.3.1 Login	37
3.3.2 Forget Your Password	38
3.3.3 Camera Selection	38
3.3.4 Audio Selection	38
4. OSD Root Menu	40
4.1 PTZ	42

4.1.1	Express Control of PTZ	44
4.2	Layout Switching.....	45
4.3	Channel Switching	45
4.4	Display.....	46
4.5	Sequence	47
4.6	Zoom.....	47
4.7	Archiving the Recordings or Log Data to the USB or DVD.....	49
4.8	Logout.....	53
4.8.1	Temporarily Logout.....	54
5.	Search and Playback.....	56
5.1	Quick Playback.....	56
5.2	Playback Bar.....	57
5.3	Searching the Recordings for Playing Back.....	59
5.3.1	Time Search	59
5.3.2	Event Search.....	60
5.3.3	Smart Search	61
5.3.4	Snapshot Search.....	63
5.3.5	POS Search	65
6.	System.....	67
6.1	Express.....	69
6.2	Camera.....	71
6.2.1	Basic Setting	71
6.2.1.1	Display Aspect Ratio.....	73
6.2.2	Adjust Setting	74
6.2.3	eZ Hopper.....	75
6.3	Record.....	78
6.4	Event.....	79
6.4.1	Alarm	79
6.4.1.1	Connect a Radio Clock to the DVR	81
6.4.2	Video Loss.....	82
6.4.3	Motion.....	84
6.4.4	Other	87
6.5	Hard Disk.....	93
6.5.1	Disk	93
6.5.2	Lock/Format	94
6.6	Display Setting	95
6.6.1	Monitor OSD.....	95
6.6.2	M/T SEQ	97
6.7	Network Settings	98
6.7.1	LAN	98
6.7.2	Email.....	101
6.7.3	DDNS	102

6.7.4	FTP	108
6.7.5	Alarm Server	109
6.7.6	Remote / Mobile	110
6.7.7	Network Test	111
6.8	Schedule Setting	112
6.8.1	Express Setup	112
6.8.2	Holidays	113
6.8.3	Schedule	114
6.9	System Setting	117
6.9.1	Date / Time.....	117
6.9.2	Daylight Saving	119
6.9.3	User Group	120
6.9.4	User Management.....	122
6.9.5	I/O Control.....	125
6.9.6	EKB200 Setting	126
6.9.7	Miscellaneous.....	128
6.10	Information	130
6.10.1	System	130
6.10.2	Log	131
7.	Remote Access to the DVR	132
7.1	Accessing the DVR on the Network.....	132
7.2	Remote Live View	136
7.3	Menu Bar	138
7.4	Remote Playback	139
8.	Specifications.....	140
9.	Troubleshooting.....	143
	Appendix A: Network Overview	144
	Appendix B: Linksys & D-Link Port Forwarding	148
	Appendix C: Timing of Alarm Modes	152
	Appendix D: Express Setup Recording Value Selection Rules	155
	Appendix E: IR Remote Control.....	157
	Appendix F: RTSP URL Syntax.....	158
	Appendix G: Auto HDD Retry Mechanism	161

1. Introduction

EverFocus ELUX16x2 is our new eZ.HD series DVR, which adopts the latest FHD technology, permitting it to deliver excellent 1080p full HD quality images that are far superior to traditional analog CCTV. The eZ.HD series is easy to install and can integrate with the existing CCTV systems without re-cabling, so this new eZ.HD 1080p full HD video surveillance system will definitely be your best cost-effective solution.

The ELUX16x2 DVR supports 16-channel analog hybrid video inputs (HD-CVI and HD-SDI are not supported) with resolution ranging from D1, 960H, 720p to 1080p full HD and also features triple streams for live view, playback and recording. It can record and play back up to 240 (NTSC) / 200 (PAL) frames per second at 1080p full HD resolution simultaneously; or 480 (NTSC) / 400 (PAL) frames per second at other resolutions. In addition, this new series DVR supports both standard coaxial and UTP (Unshielded Twisted Pair) cable, allowing for long-distance transmission of full HD images with zero video latency.

This model is designed with a high-performance hardware which has 3 video outputs (HDMI, VGA and BNC) for local monitoring, audio in/out, alarm in/out, RS-485 serial interface, 2 USB interfaces and 1 RJ45 (10/100/1000) Ethernet interface. Other than that, the ELUX16x2 can be expanded up to 5 SATA devices (4 SATA HDDs and 1 eSATA), ensuring large capacity of the eZ.HD full HD video recordings.

EverFocus also provides mobile apps for users to view the eZ.HD 1080p full HD camera streams via their mobile devices (iOS or Android platforms) and also supports web UI for users to remotely access the surveillance system. Moreover, it is integrated with our powerful CMS platform, Genie XMS, so it can be applied in more surveillance scenarios and easily scaled up in the future.

ELUX16x2 System Diagram

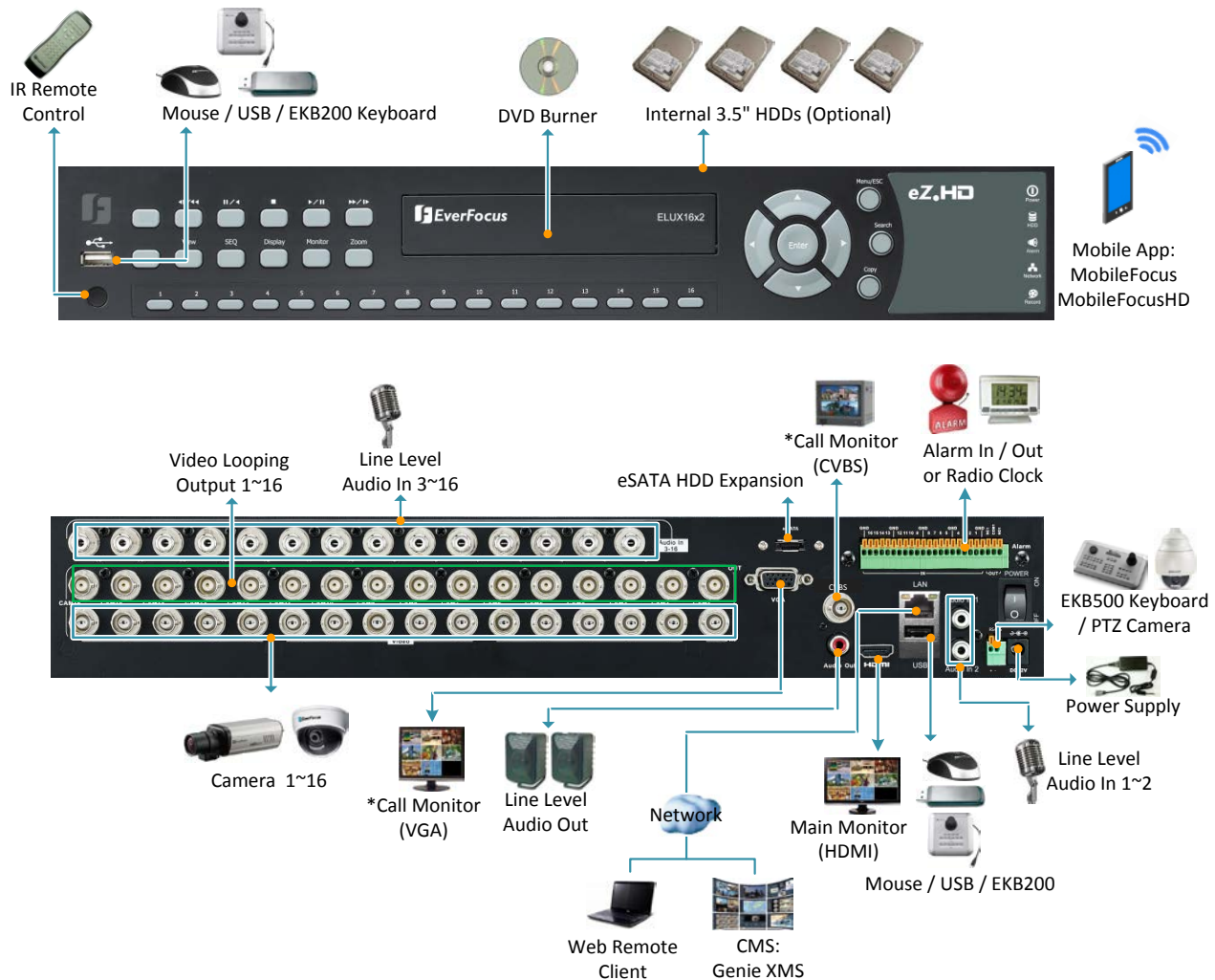

*Both of VGA and BNC ports can be used as Call monitor outputs and share the identical functionality.

1.1 Features

- Megapixel resolution over standard coaxial / UTP (Unshielded Twisted Pair) cable
- eZ upgrade to full HD resolution
- Supports hybrid cameras (HD-CVI and HD-SDI cameras are not supported)
- Supports 1080p, 720p, 960H or D1 simultaneous video inputs
- H.264 compression format for enhancing recording capacity and improving network image transmission speed
- eZ Controller function: Control camera OSD settings and PTZ operation directly from DVR end (please refer to *1.2 eZ.Controller Function Description* for more details)
- Multiple Monitors: Separately configure main and call monitor outputs
- High bandwidth full HD recording with recordable reduced bandwidth stream for mobile or multiplexed viewing applications.
- Provides MobileFocus (Plus) / MobileFocusHD (Plus) Apps for live monitoring and playback of videos through mobile devices (iOS / Android)
- Multiple Control Inputs: mouse / front panel / IR remote controller
- Remote configuration supports from built-in web interface
- Ethernet interface for remote network viewing and control
- eZ Hopper function: Only one mouse to control up to 16 connected EverFocus DVRs / NVRs
- Supports radio-controlled clock for time synchronization
- Integration with Genie XMS CMS
- Supports multi-language

1.2 eZ. Controller Function Description

◆ eZ.Controller: Easily control PTZ camera from DVR using only coaxial cable.

eZ.Controller allows users to control PTZ camera from DVR using only a coaxial cable without the need of a RS-485 cable between the PTZ camera and the DVR. Users can easily operate Zoom, Focus, Iris, Direction, Auto Pan, Preset, Tour and Pattern functions to the PTZ camera through DVR.



Note:

1. The eZ.Controller function for PTZ control is only supported for EverFocus AHD (1080p, 720p) PTZ cameras.
2. After connecting the PTZ camera to the DVR through the coaxial cable, you will have to go to the OSD Menu to turn the PTZ ID function off (System < Camera < Basic).

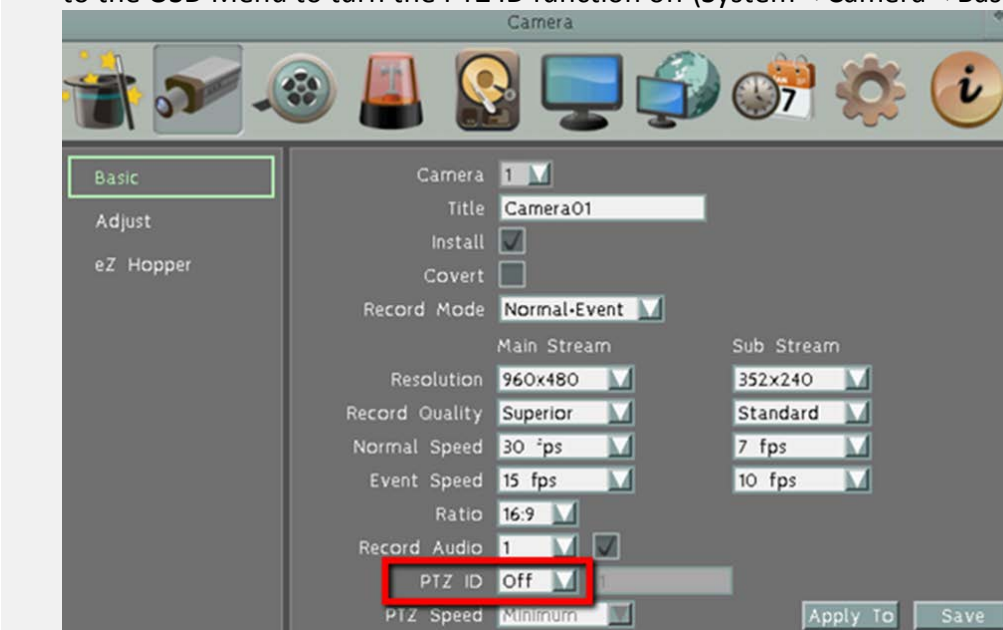

◆ **eZ.Controller: Easily control eZ.HD camera's OSD at the DVR end.**

Traditionally, the CCTV installer needs to take a portable monitor to connect to the camera for controlling the camera OSD at the camera installation site as the *Diagram A* below. It will take extra effort, time and people to adjust the camera.

Now, EverFocus' **eZ.Controller** allows users to control the camera OSD simply on the monitor at the DVR end as illustrated in *Diagram B*.









How to Control eZ.HD Camera's OSD at the DVR End?



1. On the DVR's OSD setting menu, go to **System > Camera > Adjust**. Select a camera you want to adjust.
2. Click the **Advanced** button, and the camera live view with the Coaxial Panel will be displayed.
3. To display the OSD menu, click the **Enter** button on the Coaxial Panel.
4. You can use the direction buttons on the Coaxial Panel to control the camera's OSD setting menu.
5. To exit the camera OSD setting, click **Exit** to return to the **Adjust** setting page.

1.3 Packing List

<ul style="list-style-type: none"> • DVR x 1 • 12VDC 8A Power Adaptor x 1 	<ul style="list-style-type: none"> • QIG x 1 • Mouse x 1 
<ul style="list-style-type: none"> • HDD Bracket x 4 	<ul style="list-style-type: none"> • SATA Cable x 4 
<ul style="list-style-type: none"> • IR Remote Control x 1 	<ul style="list-style-type: none"> • AAA Battery x 2 (Please see Note 4.) 
<ul style="list-style-type: none"> • Sliver Screw x 24, Washer Head Screw x 12, M3 (φ6.8) Screw x 4 	<ul style="list-style-type: none"> • Rack Ear x 2 
<ul style="list-style-type: none"> • CD x 1 (Please see Note 3.) 	

Note:

1. Equipment configurations and supplied accessories vary by country. Please consult your local EverFocus office or agents for more information. Please also keep the shipping carton for possible future use.
2. Contact the shipper if any items appear to have been damaged in the shipping process.
3. The CD contains the IP Utility software, EFPlayer, User Manual and Quick Installation Guide.
4. Risk of explosion if battery is replaced by an incorrect type. Dispose of used batteries according to the instructions.
 - a. Use only two AAA dry cell batteries.
 - b. Do not dispose of the batteries in a fire as it may explode.

1.4 Optional Accessories

- EKB200 (USB controller keyboard: connect to the PC or DVR to control the PTZ cameras connected to the DVR). Please refer to *6.9.6 EKB200 Setting* in the User Manual of the EKB200 Keyboard.



- EKB500 (RS-485 keyboard: connect to the RS-485 port to control the PTZ cameras connected to the DVR). Please refer to User Manual of the EKB500 Keyboard.



1.5 Dimensions

Front View

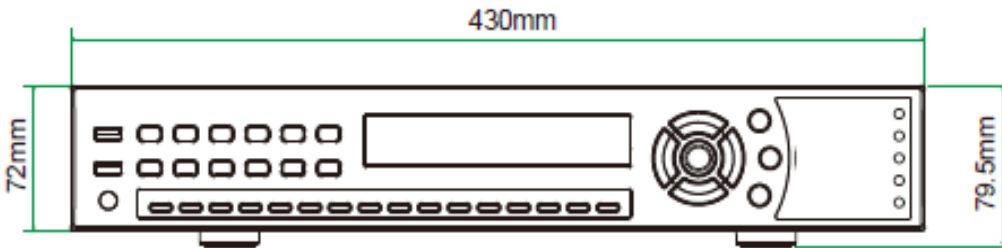

Side View

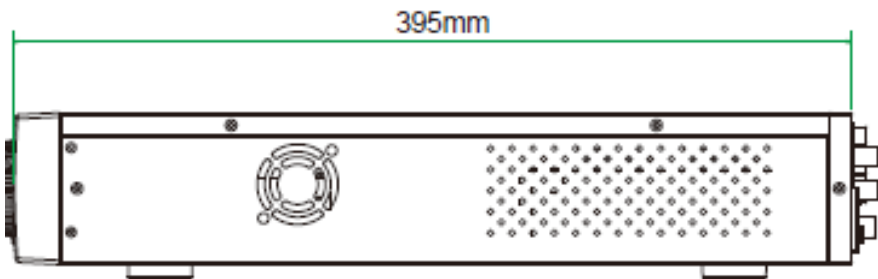

1.6 Front Panel

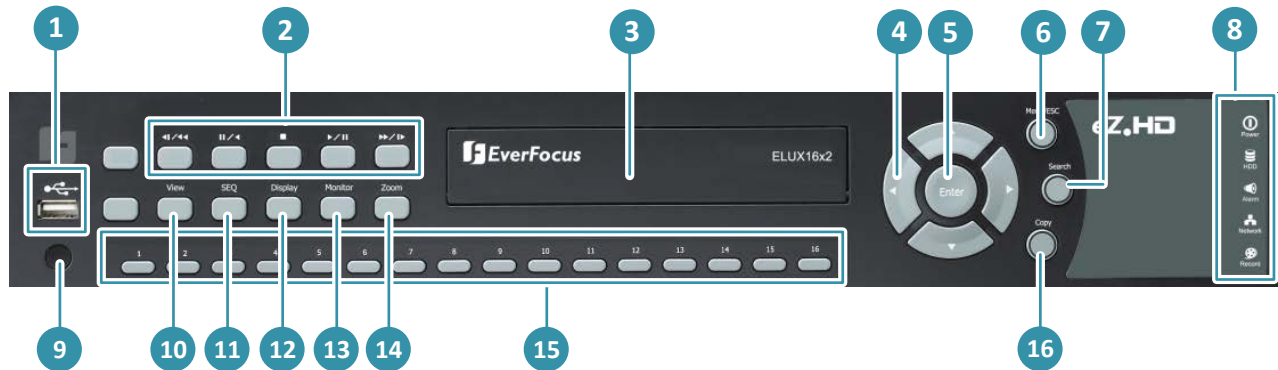

No.	Name	Description
1	USB2.0 Port	The USB2.0 port for connecting to a mouse, external storage device or EKB200 keyboard.
2	Control Buttons	◀/◀◀: In Playback mode, press to play in fast reverse. /◀: In Playback mode, press to pause / play in reverse. ■: In Playback mode, press to exit playback mode. ▶/ : Press to enter Playback mode. In Playback mode, press to pause / resume playback. ▶▶/▶: In Playback mode, press to play in fast forward.
3	DVD Burner (optional)	Use the DVD Burner for archiving the recordings from the DVR. It's highly recommended to use a DVD+R with 4x or higher speed disc for recording. To open the DVD tray, please refer to <i>4.7 Archiving the Recordings or Log Data to the USB or DVD</i> . To close the tray, just gently push it and it will be automatically closed.
4	Arrow Buttons	Use these arrow buttons to change the Menu settings.
5	Enter	Press to enter.
6	Menu / ESC	In Live mode, press to enter the Main OSD Setup Menu. In Setup mode, press to exit or return to the previous setup menu.
7	Search	Press to enter the Search Setup menu.
8	LED Indicator	Power: Indicates the power is on. HDD: Indicates the internal Hard Disk is activating. Alarm: Indicates an alarm input is triggered. Network: Indicates the network is connected. Record: Indicates the DVR is recording.
9	IR Receiver	Receive signals from IR remote control.

10	View	In Live mode, press to switch to the layout type for displaying the channel feeds.
11	SEQ	Press to enter the automatic sequence mode. This will show each channel feed in sequence. Press again to exit sequence mode.
12	Display	Press to cycle between the info display types (channel and status bar info).
13	Monitor	In Live mode, press to switch between Main and Call Monitor.
14	Zoom	In Live mode, press to zoom the display of a channel. Press the Menu/ESC button to exit Zoom mode.
15	Channel Buttons	Select the full screen channel in live mode. Select the full screen channel in playback.
16	Copy	Press to enter the Copy Menu.

1.7 Rear Panel

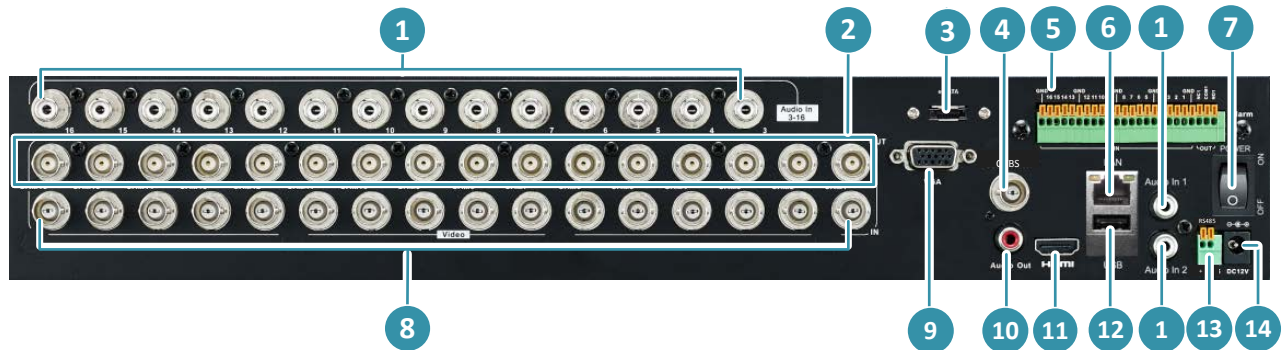

No.	Name	Description
1	Audio Input 1~16 (RCA)	Connects to the audio input devices such as microphones. Note that the microphone with a (built-in) amplifier and external power supply is required.
2	Loop Video Output 1~16	You can also optionally connect the monitors to each Loop Video Output to display the video of the corresponding channel. Please refer to <i>2.3.1 Monitor Connection</i> .
3	eSATA Port	Connects to an external eSATA storage device, please set up an RAID array of the eSATA device before using.
4	CVBS Port (BNC)	This can be used as a Call monitor output. Connects to the monitor using a BNC cable (see <i>2.3.1 Monitor Connection</i>).
5	Alarm Input /Out	Connects up to 16 alarm inputs and 1 alarm output devices. You can also connect to the radio-controlled clock for time synchronization. Please refer to <i>2.3.2 Alarm I/O</i> .
6	Ethernet (LAN)	Connects to the Network.
7	Power Switch	Press to turn on or off the power.
8	Video Input 1~16	Connects to analog HD / SD cameras using coaxial cables. Note: <ol style="list-style-type: none"> The DVR can automatically configure itself as NTSC or PAL. To do this, connect a camera to any channel of the DVR. The DVR will detect the first connected camera format (NTSC or PAL) and then automatically configure itself to the detected format from the first connected camera. For example, if the format of the first connected camera is NTSC, the DVR will configure itself to NTSC format. All video inputs are compatible with all resolution types of cameras, such as 1080p, 720p, 960H and D1 cameras (HD-CVI / HD-SDI cameras are not supported).

9	VGA Port	This can be used as a Call monitor output. Connects to the monitor using a VGA cable (see <i>2.3.1 Monitor Connection</i>).
10	Audio Output (RCA)	Connects to the audio output devices, such as speakers. Note that the speaker with a (built-in) amplifier and external power supply are required.
11	HDMI Port	This can be used as a Main monitor output. Connects to the monitor using a HDMI cable (see <i>2.3.1 Monitor Connection</i>).
12	USB2.0 Port	The USB2.0 port for connecting to a mouse, external storage device or EKB200 keyboard.
13	RS-485 Port	Connects to the RS-485 device (EKB500) or PTZ camera.
14	Power Port	Connects to the 12VDC 8A power using the supplied Power Adaptor.

2. Installation

2.1 Hard Disk Installation

You can optionally install four 3.5" HDDs inside the DVR for recording videos.

1. Make sure the DVR is power-off.
2. Unscrew the ten housing screws of the DVR and remove the housing cover.



3. Screw two HDD brackets on both sides of the HDDs using the Silver Screws.

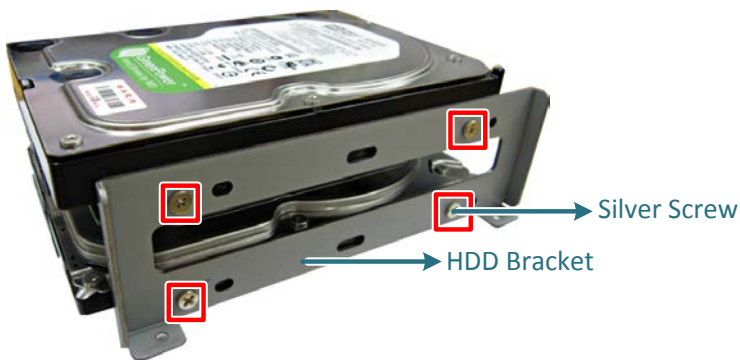

4. Use the SATA Cable, and connect one end to either one of the four SATA ports on the PCB inside the DVR, and the other end to the SATA port on the HDD.

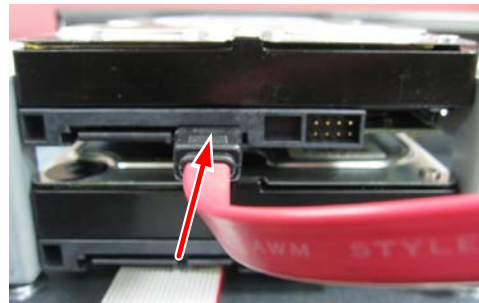
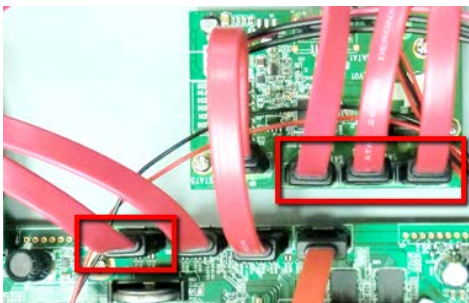

5. Connect the internal power cable to the HDD.

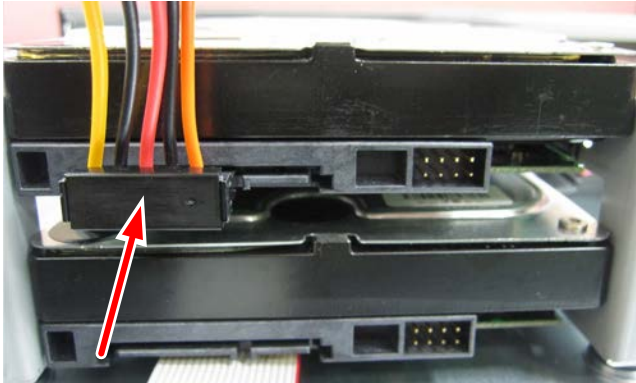

Note: The internal power cable is connected to the Main board inside the DVR. The power cable features two/three connectors, which can be used to connect to two/three HDDs.

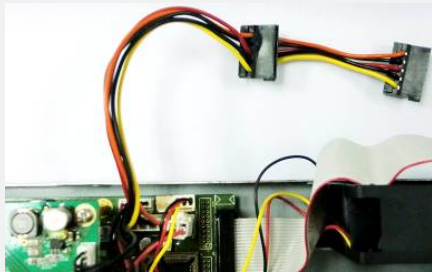

6. Screw the HDDs with the brackets inside the DVR using the Washer Head Screws.

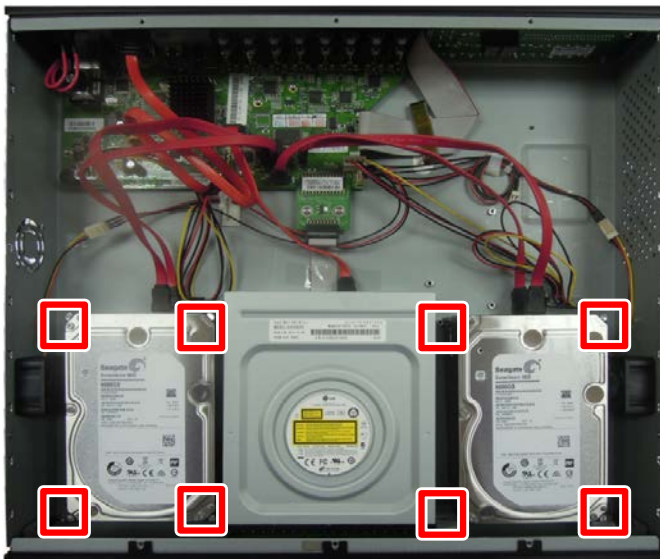

7. Screw back the housing cover to the DVR.

2.1.1 Hard Disk Compatibility List

Please go to the ELUX16x2 Web page on EverFocus' website <http://www.everfocus.com.tw> to see the latest Hard Disk Compatibility List.

Note: If using two or more hard disks, please choose the hard disks with the same capacity.

2.2 Rack Mount

To install rack ears on the DVR:

1. Unscrew the four M3 ($\phi 6.8$) screws on both sides of the DVR.
2. Use the supplied two rack ears and the above screws for rack mount installation on both sides.



2.3 Basic Connection

The instructions below the figure describe the basic connection for the ELUX16x2.

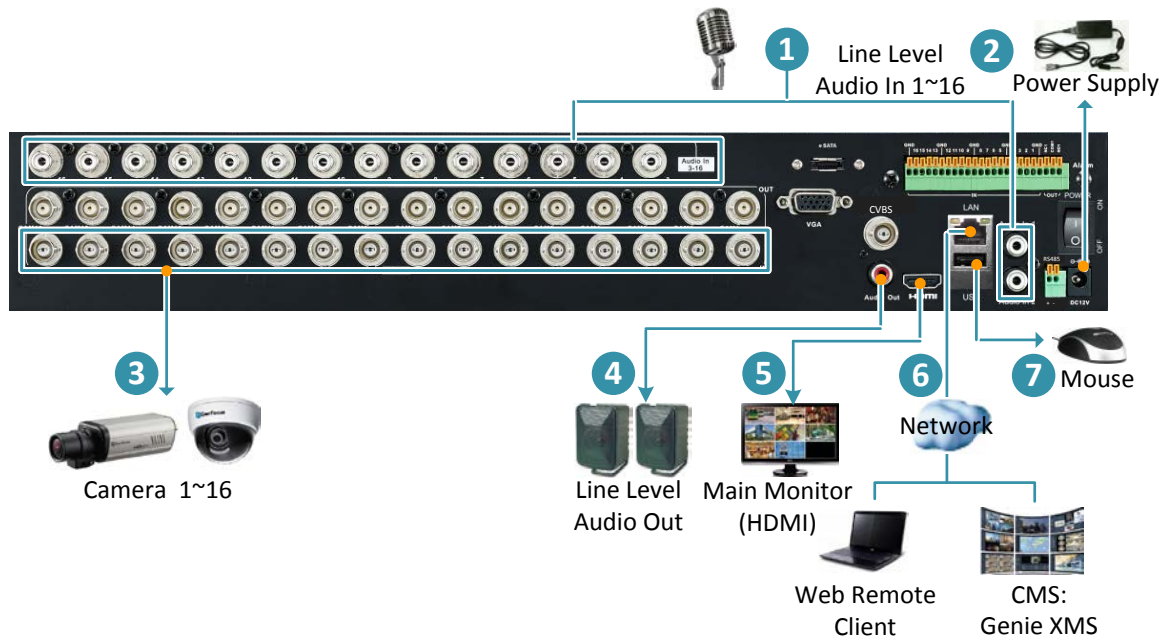

1. Connect the line level audio input devices to the DVR. Note that the audio input devices, such as microphones, are required to have a (built-in) amplifier and external power supply.
2. Using the supplied Power Adaptor, connect one end to the DC 12V port on the DVR and the other end to the power outlet.

Note: Please ensure to connect the internal power cables to the internal HDDs before powering on the DVR.

3. Connect the cameras to the DVR using the coaxial cables. EverFocus eZ.HD cameras are recommended. (HD-CVI / HD-SDI cameras are not supported)
4. To listen to audio of video source, connect speakers to the Audio Out port. Note that speaker with a (built-in) amplifier and external power are required.
5. To view videos, connect a monitor to the HDMI port using the HDMI cable supplied by the monitor manufacturer.
6. Use a standard RJ-45 cable to connect the DVR to the network for remote viewing or using EverFocus surveillance system (Genie XMS).
7. Optionally connect a mouse to the DVR to control the system. You can also control the system using the supplied IR Remote Control or the control buttons on the front panel.

2.3.1 Monitor Connection

Connect the monitor to the CVBS, HDMI or VGA port on the rear panel of the DVR. The ELUX16x2 DVR provides 1 main monitor output (HDMI); and 2 call monitor outputs (VGA and BNC) with identical functionality.

The main monitor output can deliver full HD output resolution (1920x1080, progressive, 60 Hz. vert., 68 KHz hor.). The 2 call monitors can display camera streams or perform sequence display mode. Both of the 2 call monitor outputs provide the identical functionality and can be operated simultaneously. Make sure that the connected monitor's specifications comply with the resolution requirements. To configure the monitor setting, please refer to *6.6 Display Setting*.

You can also optionally connect the monitors to each Loop Video Output to display the video of the corresponding channel.

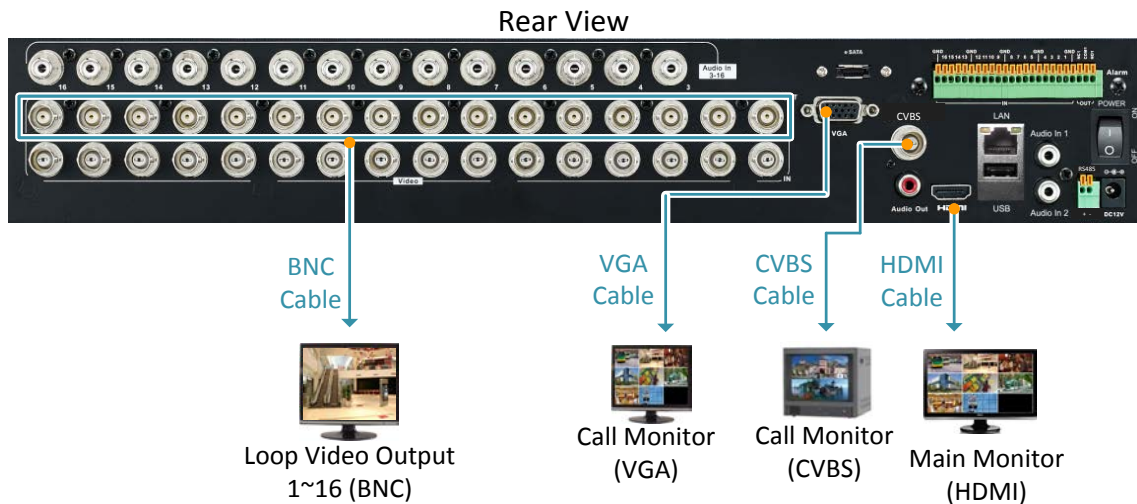

Note:

1. The connected monitors' specifications must comply with the resolution requirements.
2. Do not exceed the max. HDMI cable length of 15 meters. The standard HDMI cables can support cable length up to 3 meters. For longer distances, such as 15 meters, it is highly recommended to use high quality HDMI cables.

2.3.2 Alarm I / O

The DVR provides 16 alarm inputs and 1 alarm output. You can also connect the radio-controlled clock to the alarm input of the DVR for the time synchronization. The DVR supports the radio-controlled clock which will automatically synchronize to the time standard so that you won't need to reset the time manually. For radio-controlled clock connection, connect the positive (+) wire to either port of Alarm Input 1~16 and negative (-) wire to the GND port.

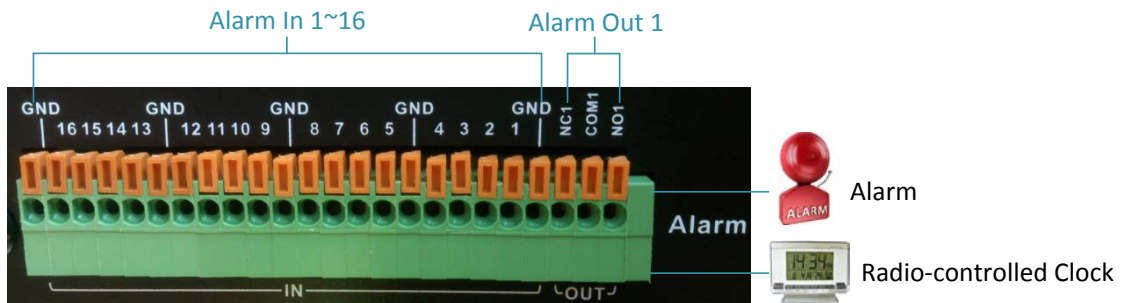

Alarm Input Contacts

This DVR provides one alarm input per camera. All inputs are N.O. (Normal Open) or N.C. (Normal Closed) programmable. All settings are programmed in the ALARM / Event menu.

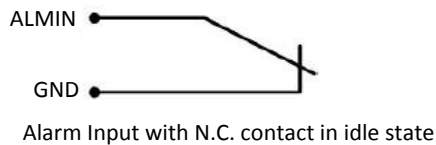
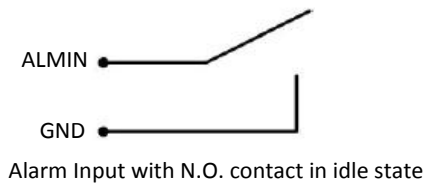

Alarm Output Contacts

The relay output provides either Normally Open or Normally Closed dry contacts.

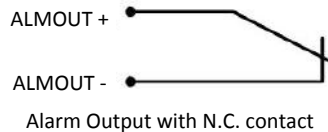
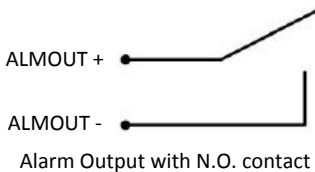

2.3.3 RS-485 Port

The RS-485 port, located on the rear panel of the DVR, can be used to connect to an RS-485 keyboard for controlling PTZ cameras or simply connect to a PTZ camera or connect to a POS device.

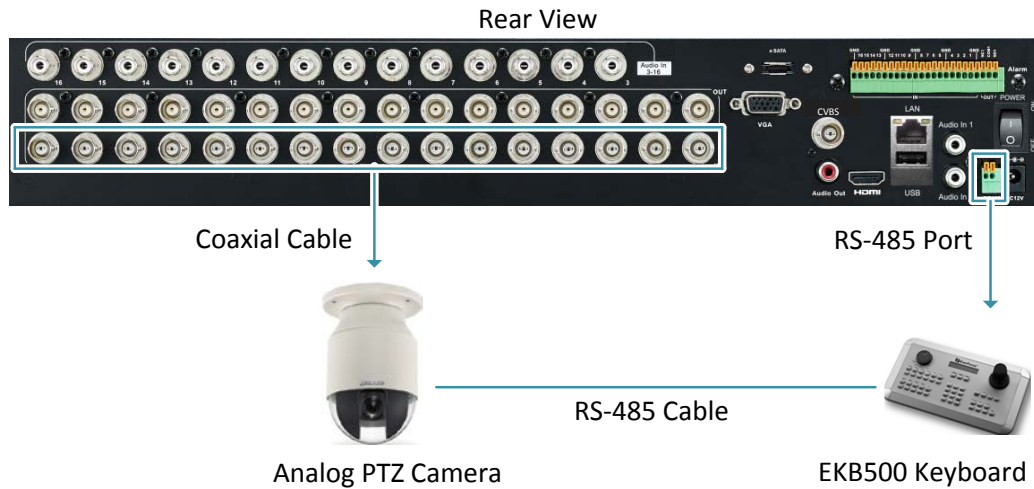

Note: EverFocus FHD series DVR supports the eZ.Controller function, which enables users to control PTZ camera from DVR using only a coaxial cable without the need of a RS-485 cable between the PTZ camera and the DVR (see 1.2 eZ.Controller Function Description).

2.4 Turning On / Off the Power

Before powering on the DVR, please make sure the internal HDDs have been installed properly. Once you have completed the basic cable connections, you are ready to turn on the DVR.

To turn on the power, connect the supplied Power Cord to the power outlet and turn on the Power Switch. All of the LED indicators on the front panel will light up. The DVR will automatically run an internal process, when the process is complete, the LED indicators will turn off, and the POWER LED will remain light up in green. And then you can start operating the DVR.

To turn off the power, please go to OSD Root Menu > System Setting > Miscellaneous setting page, and click **Shutdown** (refer to 6.9.7 Miscellaneous). After the message pops up as below, you can now turn the Power Switch to the "Off" position.

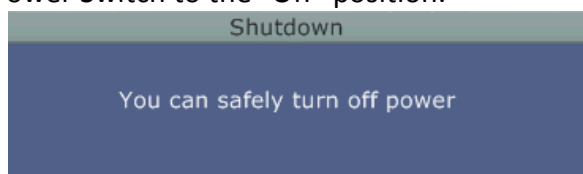

2.5 Checking the Dynamic IP Address

You can look up the IP address and access the Web interface of the DVR using the **IP Utility (IPU)** program, which is included in the CD. You can also download the IPU from EverFocus' Website: http://www.everfocus.com/HQ/Support/DownloadCenter_p1.aspx. Please connect the DVR on the same LAN of your computer.

1. Save **IP Utility Setup.exe**  in your computer. Double click the .exe file and follow the on-screen instructions to install the IP Utility.

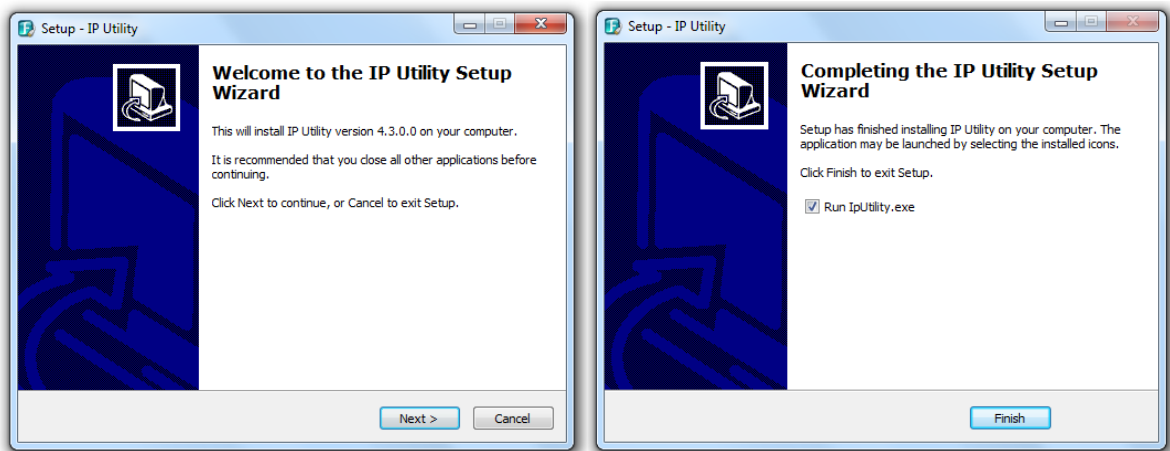

2. Click the **Finish** button, the IP Utility will be automatically launched to search the IP devices connected on the same LAN.

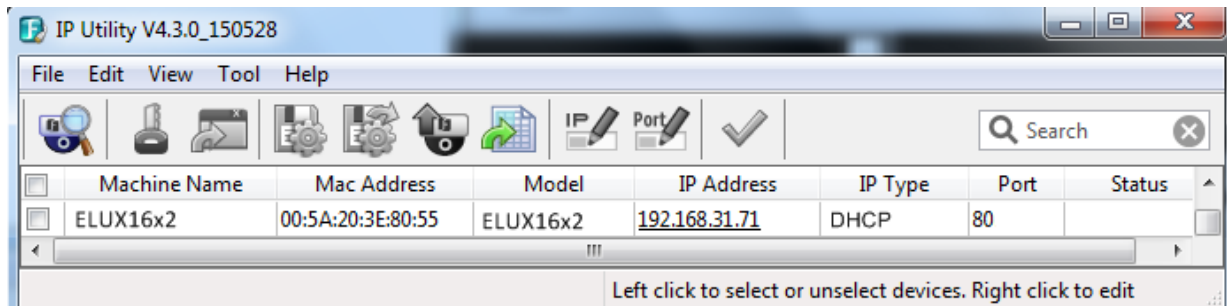

3. To optionally configure the Machine Name, IP Address, IP Type or Port Number using the IPU:
 - a. Log in the DVR by checking the desired model and then click the **Log in**  icon. The Log in dialog box appears.

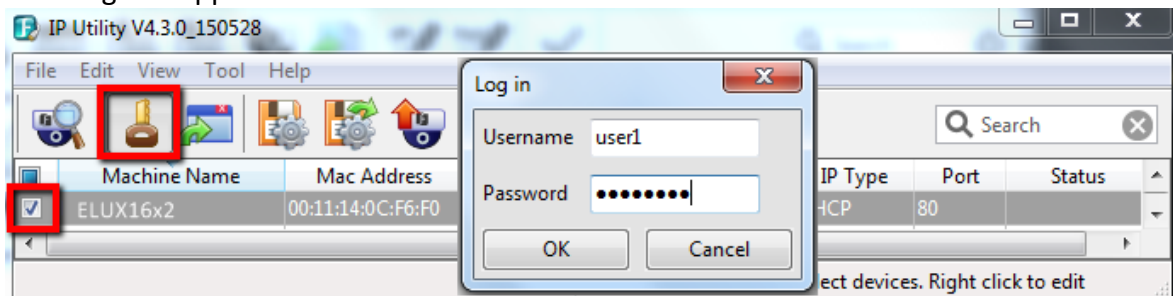

- b. Type the Username and Password. Click the **OK** button, the status of the selected camera will display **Login**.

<input type="checkbox"/>	Machine Name	Mac Address	Model	IP Address	IP Type	Port	Status
<input checked="" type="checkbox"/>	ELUX16x2	00:11:14:12:30:A4	ELUX16x2	192.168.31.67	DHCP	80	Login

Note:

1. The default user ID is **admin** and the default password is **11111111**.
2. If you select more than one DVRs that have the same user ID / password, you will be able to log in several DVRs at once.

- c. Right click the columns (such as Machine Name, IP Address, IP Type or Port) to configure the setting. Click **Apply Changes** button to apply and save the settings.

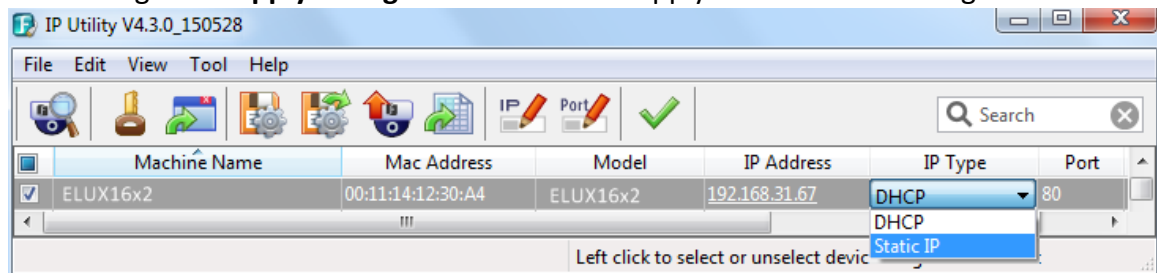

Note: Most networks uses DHCP to assign IP address, if you are unsure of your network settings, please consult your network administrators for configuration details.

4. To access the Live View window, double click the IP address of the desired device, the login window pops up. Type the user ID and password to log in. By default, the user ID is **admin** and the password is **11111111**.

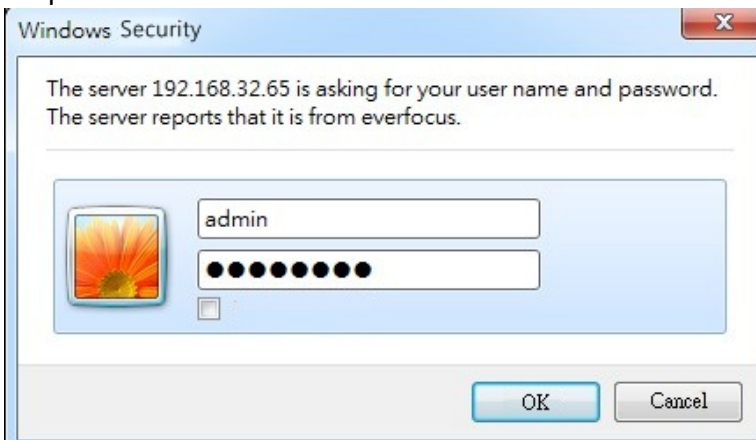

- If you log in for the first time, follow the instruction steps on the interface to update the latest Plugin version (ePlayer). After reloading the webpage, the login window pops up again. Type the user ID and password to log in again. By default, the user ID is **admin** and the password is **11111111**.

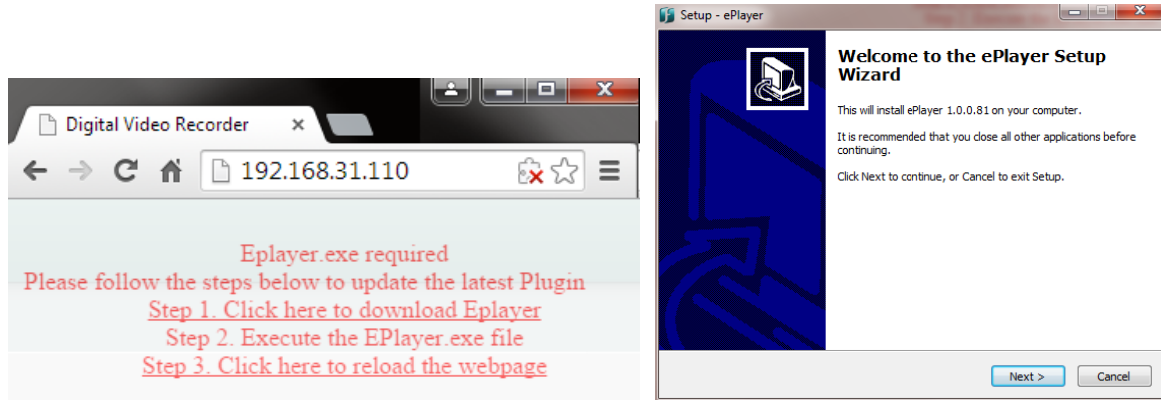

Note for the first time login:

The “Download ePlayer Instruction” page will only be prompted for the first time login in order to update the system to the latest plugin version.

When the Plug-in blocked appears on the browser, select **Always allow plug-ins on xxx**, click **Done** and then reload the webpage.

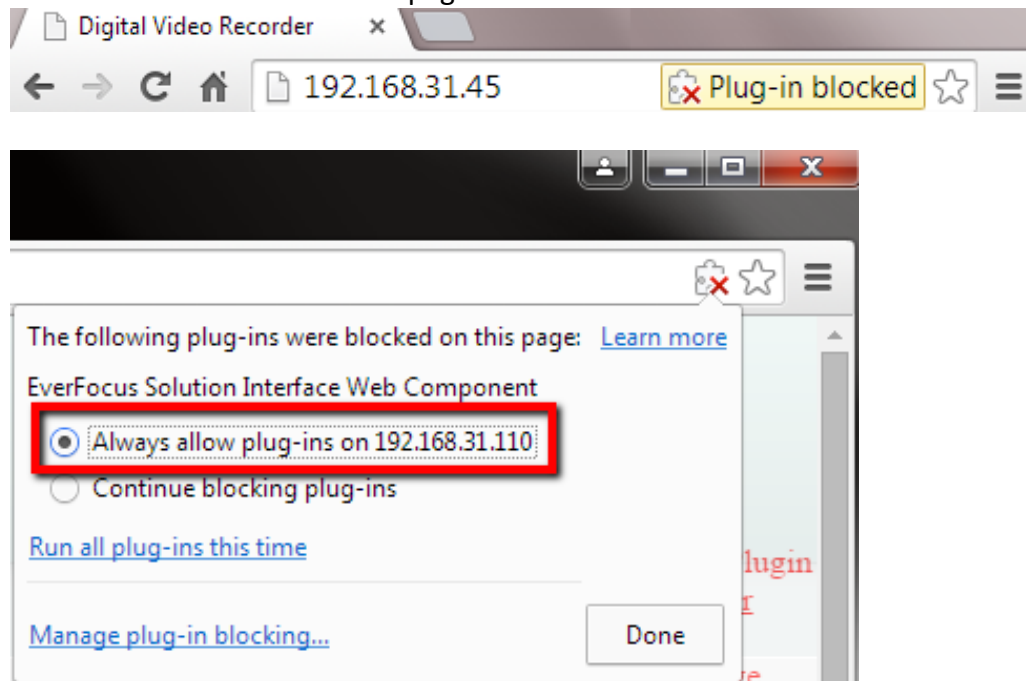

- Now you will be able to see the remote live page.

If you encounter the following problem or still can't access the remote Web interface, please see below:

- ◆ If the **Error** window appears, please be sure to **close ALL the Web browser windows first** and then click **Retry**. When the **Completing the ePlayer Setup Wizard** window shows up, click **Finish**. Then, you can open a new browser again to access the DVR's remote Web interface.

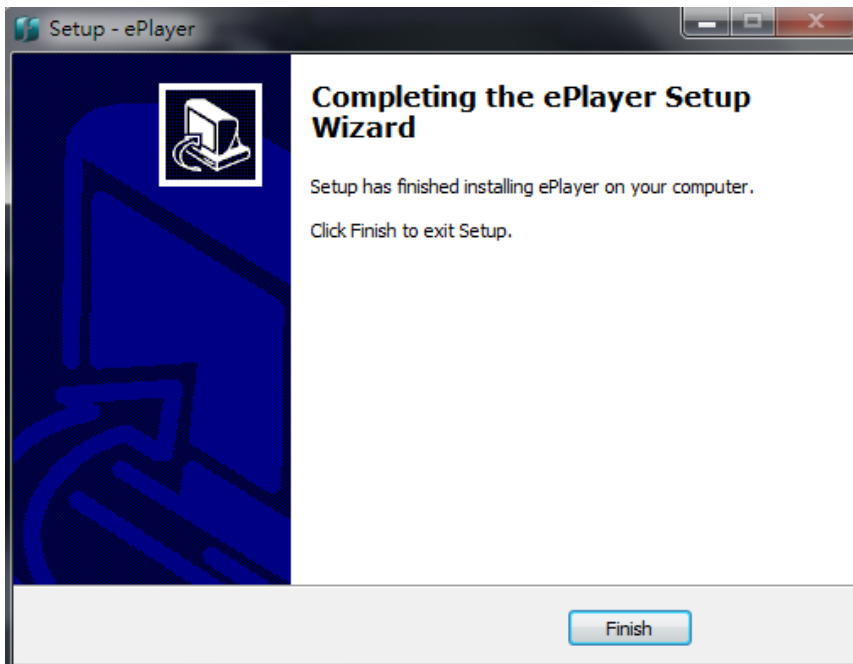
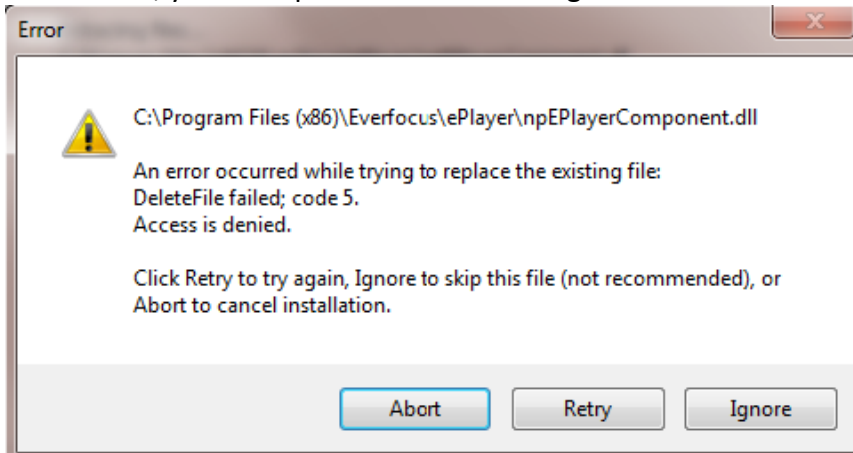

- ◆ If your PC or laptop is running with Windows, it's required to run the browser as administrator when first entering the remote web page of the device. Go to **C:\Program Files (x86)\Internet Explorer**, right-click the browser and then click **Run as administrator**.

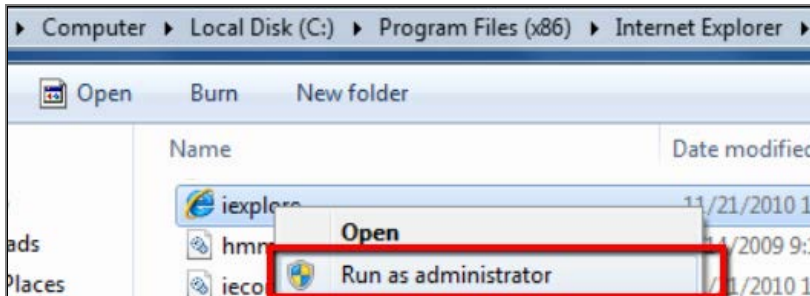

- ◆ You may need to turn **User Account Control** off if you still can't see the Remote Live View. On the computer, click **Start > Control Panel > System and Security > Action Center** (click Change User Account Control Settings), the **User Account Control Settings** window appears. Adjust the slide bar to **Never Notify** and then click **OK**. Restart your computer if requested.

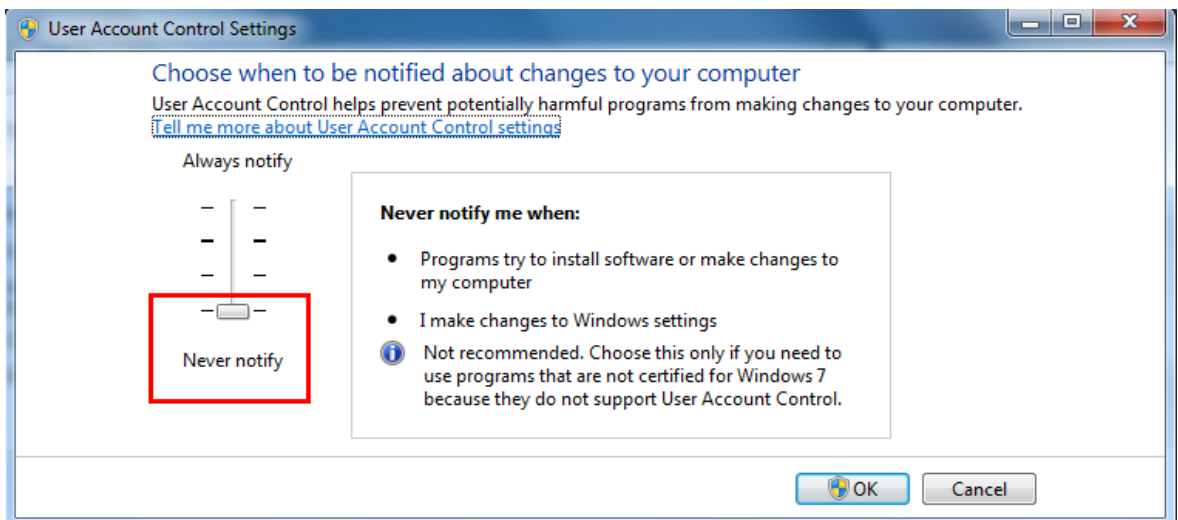

2.6 Connecting the DVR to the Network

There are three methods to connect the DVR to the network: **Router or LAN Connection**, **Direct High-Speed Connection** and **One-to-One Connection**. For more information of the network, please refer to *Appendix A. Network Overview*.

2.6.1 Router or LAN Connection

This is the most common connection in which the DVR is connected to a router and allows multiple users on and off site to see the DVR on a LAN/WAN (Internet). The DVR must be assigned an IP address that is compatible with its LAN. By setting up port forwarding on the router, you can remotely access the cameras from outside of the LAN via the Internet. To remotely access the Web interface, please refer to *7. Remote Access to the DVR*. To set up port forwarding, please consult the manual of the router or refer to *Appendix B: Linksys & D-Link Port Forwarding*.

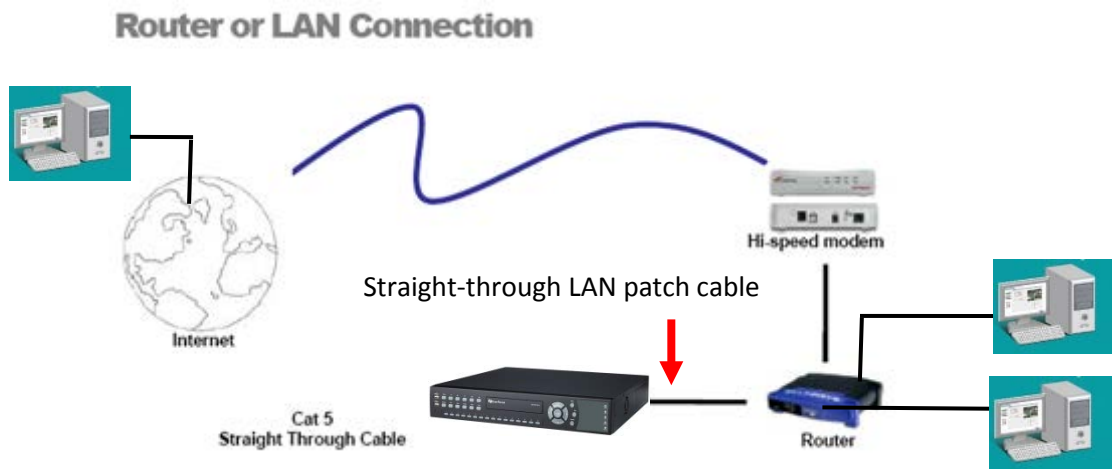

Right: Pinout of a straight-through cable.

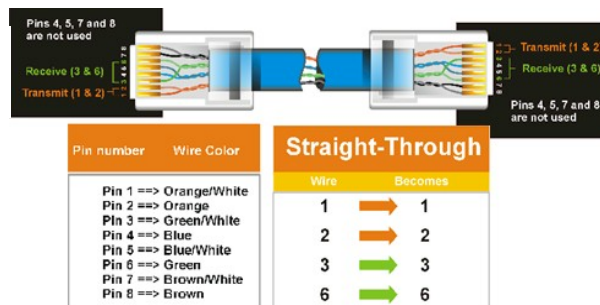

Connection Procedure:

- The First step is to purchase or make a straight through cable. We recommend purchasing one if you have never made a straight through cable. Please remember you can not use a cross-over network cable for this application.
- Once you have a straight through cable, plug one end into the LAN port on the back of the recorder and the other into the router.
- Log into the EverFocus DVR menu and go to the Network Setting Menu.
- To let the router automatically assign an address:
 - ◆ Set the Network Type to DHCP. Make sure to write down the IP address and the Gateway.
 - ◆ Exit from the Menu to save settings.

To manually assign an address:

- ◆ Go to a computer connected on the same network as the DVR.
- ◆ Click on the Start button and choose Run.
If using Windows Vista, choose Search instead.
- ◆ Type “command” and click on OK.
In Vista, you will need to double-click on the “Command Prompt” file to open it.
- ◆ In the DOS prompt, type “ipconfig” and press Enter.
- ◆ The network information will be displayed on a screen similar to the one below.
In Windows Vista, look for the information that says “IP v4”.

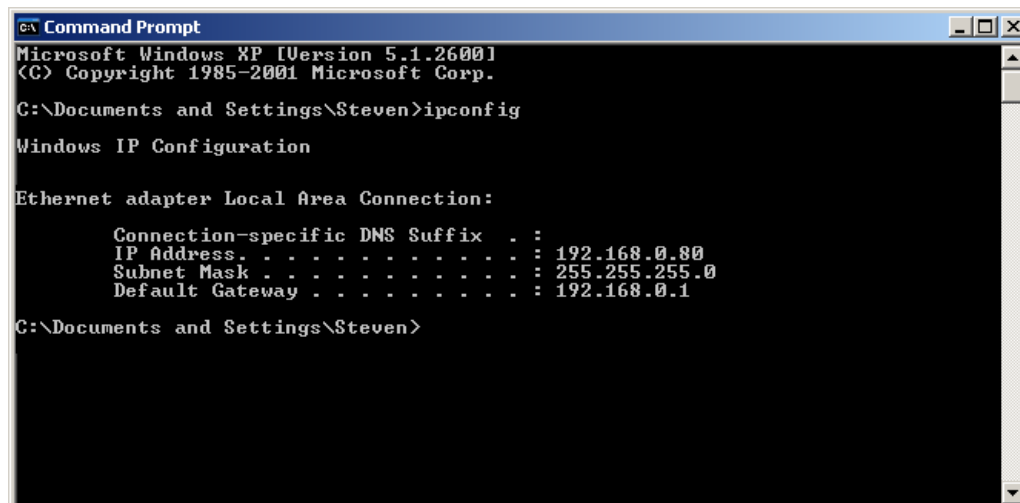

```

c:\ Command Prompt
Microsoft Windows XP [Version 5.1.2600]
(C) Copyright 1985-2001 Microsoft Corp.
C:\Documents and Settings\Steven>ipconfig

Windows IP Configuration

Ethernet adapter Local Area Connection:

    Connection-specific DNS Suffix  . : 
    IP Address. . . . .               : 192.168.0.80
    Subnet Mask . . . . .             : 255.255.255.0
    Default Gateway . . . . .         : 192.168.0.1

C:\Documents and Settings\Steven>
```

- ◆ Take the values for Subnet Mask and Default Gateway and input them into the DVR; these values should be exactly the same in both devices. However, you should change the last number of the IP address. For example, if the IP address of the computer is 192.168.2.101, the DVR's IP address should be 192.168.2.50.
- To access the DVR from a computer simply open Internet Explorer and in the address bar type:
http:// (IP address of the DVR)

Note: The DVR's IP address will only work at the location of the DVR. To connect from a different location over the Internet, see below.

To set the DVR for Internet Connection through router:

- The next step is to open ports within your router. Log into the router using a PC and open the following ports.
 - ◆ Ports to open: 80
 - ◆ If your Internet service provider blocks port 80, you can change it to a different port in the DVR's Network Menu Setup; open/forward that port instead.
 - ◆ If you are using a Linksys or D-Link router, see *Appendix A* for basic support on setting up ports. For any other router, you will need to contact the manufacturer for support.
- To access the DVR from a computer simply open Internet Explorer and in the address bar type:
http:// (the IP address given by your internet service provider)

Note: If you changed to a different port other than 80, you will need to include this at the end of the IP address:
http:// (the IP address given by your internet service provider):port number

- If you have a WAN Dynamic IP address and have opened the ports, go to *6.7.3 DDNS Setup* to configure the DDNS settings.

2.6.2 Direct High-Speed Connection

In a Direct High-Speed Connection, the DVR connects directly to a modem without the need for a router. You need to set the static or dynamic WAN IP address assigned by your ISP (Internet Service Provider) in the DVR's configuration web pages. To access the DVR, just type "http://xxx.xxx.xxx.xxx", where xxx.xxx.xxx.xxx is the IP address given by your ISP. If you have a dynamic IP address, this connection may require that you use DDNS for a reliable connection.

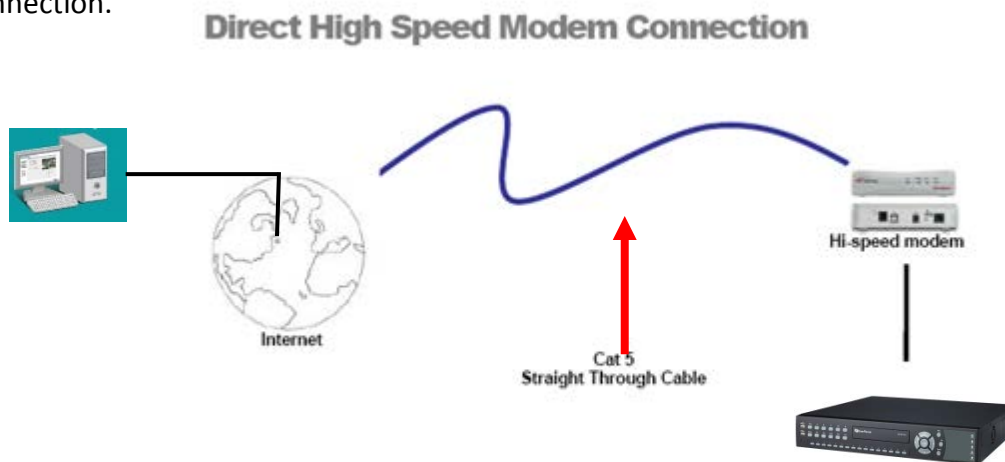

Connection Procedure:

- The first step is to purchase or make a straight through cable. We recommend purchasing one if you have never made a straight through cable. Please remember you can not use a cross-over network cable for this application
- Once you have a straight through cable plug one end into the LAN port on the back of the recorder and the other into the high speed modem.
- Log into the EverFocus DVR menu and go to the Network Setting Menu.
- Input the Static IP address, the Subnet Mask, and the Gateway that you obtained from the internet service provider.

Note: If you have a dynamic IP address, you can set the DVR to DHCP to automatically detect the network settings. Therefore, it can use a dynamic IP address.

- Exit from the DVR's Menu to save the settings.
- To access the DVR from a computer, open Internet Explorer and in the address bar type: http:// (IP address given by your internet service provider)

Note: When using this type of connection, only one device can be connected to the modem at a time. You will need to use a computer at a different location to test the connection s.

2.6.3 One-to-One Connection

You can connect directly without using a switch, router or modem. However, only the PC connected to the DVR will be able to view the DVR. You will also have to manually assign a compatible IP address to both the computer and the DVR. Unless the PC has another network connection, the DVR will be the only network device visible to the PC. See the diagram below:

Simple One to One Connection

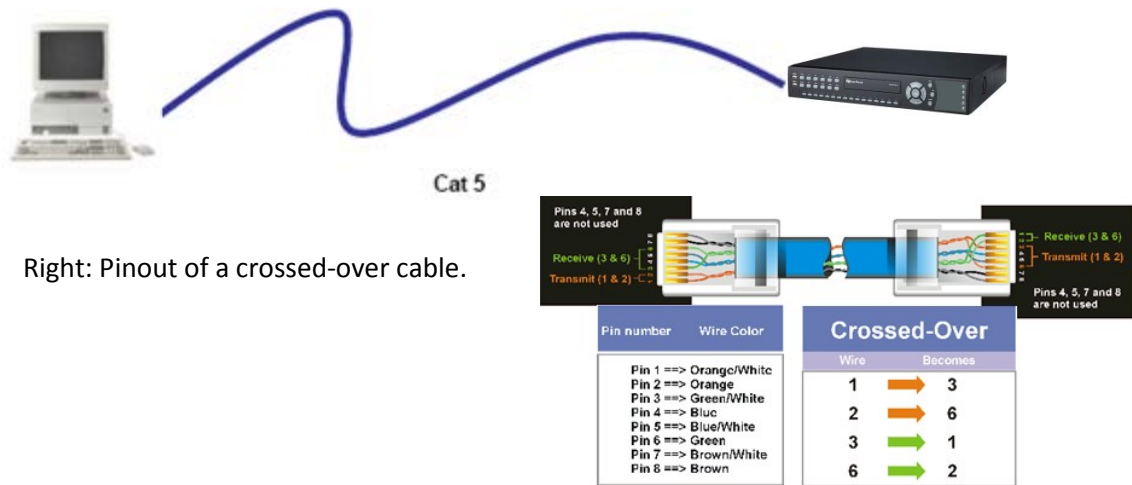

Connection Procedure:

- The First step is to purchase or make a cross-over cable. We recommend purchasing one if you have never made a cross-over cable. Please remember you can not use a straight through network cable for this application.
- Once you have a cross-over cable, plug one end into the LAN port on the back of the DVR and the other into the network card on the back of the computer.
- Log into the EverFocus DVR menu and go to the Network Setting Menu.
- You must use the Static IP option for this type of connection.
- Assign an IP of 192.168.001.003, a Subnet Mask of 255.255.255.000, and a Gateway of 192.168.001.001. You can ignore DNS Server.
- The next step is to set the computer's network settings to match those of the DVR. You will need Administrator privileges on your Windows machine to do this.
- To assign a fixed IP address in Windows 2000/XP, follow the instructions below:

- ◆ Go to **Start**. Double-click on **Control Panel**.

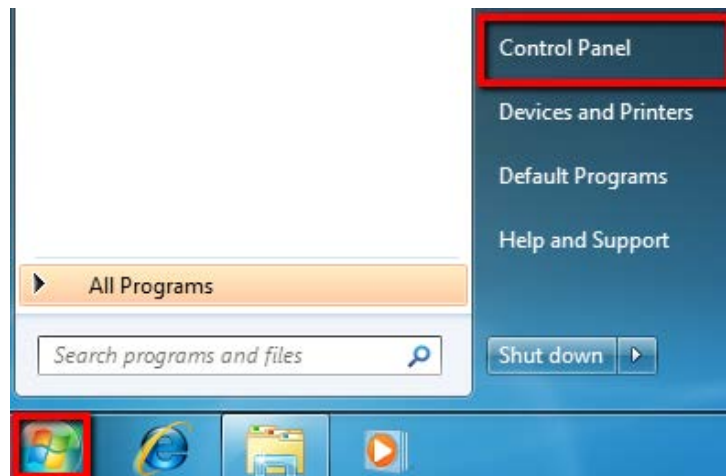

- ◆ Click **Network and Sharing Center**.

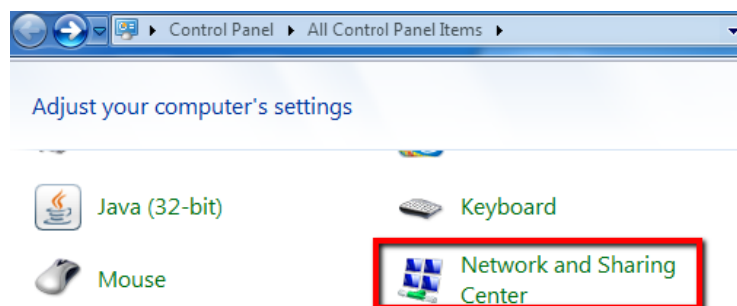

- ◆ Click **Local Area Connection**.

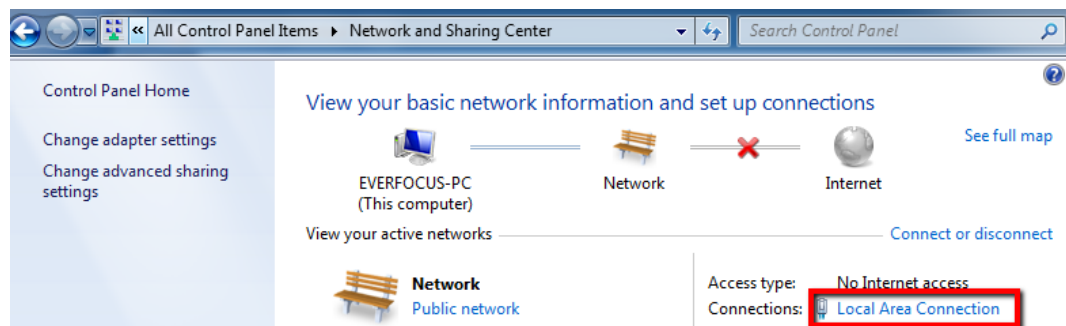

- ◆ Click **Properties**.

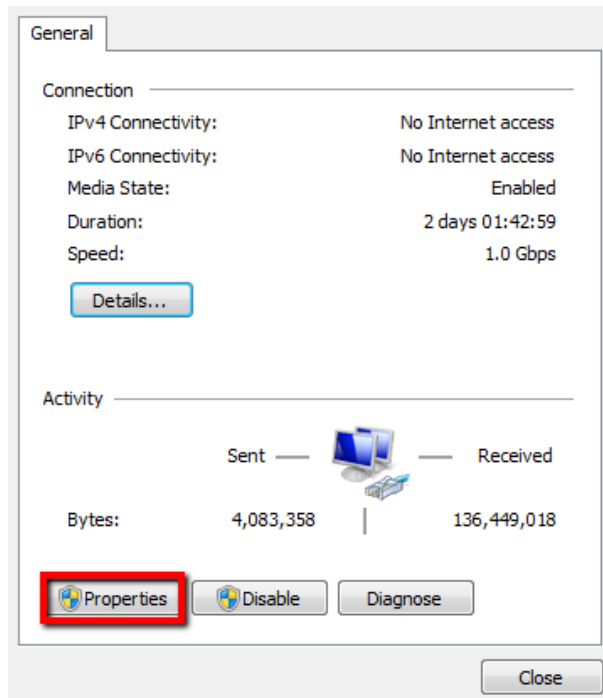

- ◆ Click on **Internet Protocol Version 4 (TCP/IPv4)** and then click **Properties**.

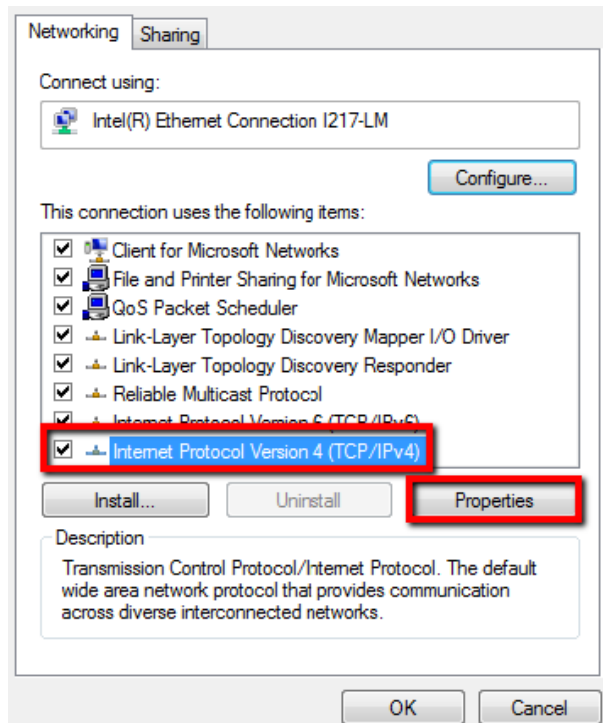

- ◆ Select **Use the following IP address**. Assign an IP address of 192.168.1.2, a Subnet Mask of 255.255.255.0, and a Default Gateway of 192.168.1.1 and then click **OK**.

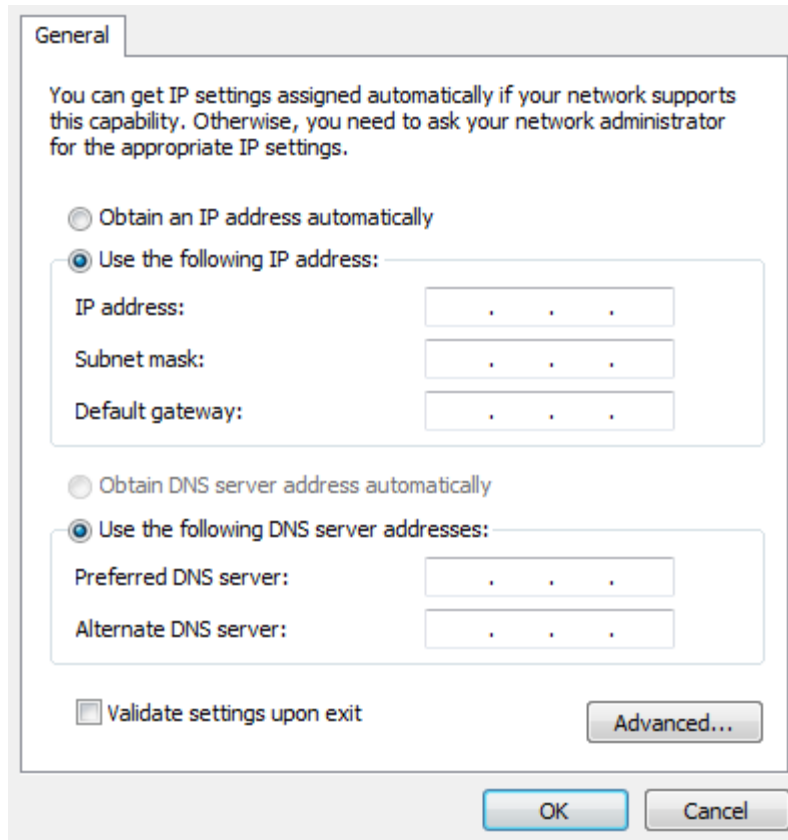

General

You can get IP settings assigned automatically if your network supports this capability. Otherwise, you need to ask your network administrator for the appropriate IP settings.

Obtain an IP address automatically
 Use the following IP address:

IP address: . . .
 Subnet mask: . . .
 Default gateway: . . .

Obtain DNS server address automatically
 Use the following DNS server addresses:

Preferred DNS server: . . .
 Alternate DNS server: . . .

Validate settings upon exit

Advanced...

OK Cancel

- ◆ Restart both of the computer and the DVR.
- ◆ To access the DVR from the computer, simply open Internet Explorer and in the address bar type: `http://192.168.1.3`

Chapter 3

3. Mouse and Front Panel Button Operation

There are four ways to control the OSD menu of the ELUX16x2 DVR: with a **Mouse**, the **Front Panel Buttons**, the supplied handheld **IR Remote Control** or the optional device **EKB500 keyboard** and **EKB200 keyboard**. For details on the IR remote control, please refer to *Appendix E, IR Remote Control*. This chapter will discuss the basic operations using the mouse and the front panel buttons.

3.1 USB Mouse Operation

3.1.1 How to Select a Channel / Enable Audio

- To select a channel, on the Live View window, single-click on the desired channel screen. The selected screen will be highlighted by a red frame.
- To toggle full screen of a channel, double-click on a desired channel.
- To switch the Audio Output channel, single-click on the desired channel screen, the highlighted channel will be automatically applied with the Audio Output function (an audio icon will be displayed on the upper-right corner of the channel). To turn on/off the Audio Output function, click the Audio Icon  at lower-left side of the monitor.

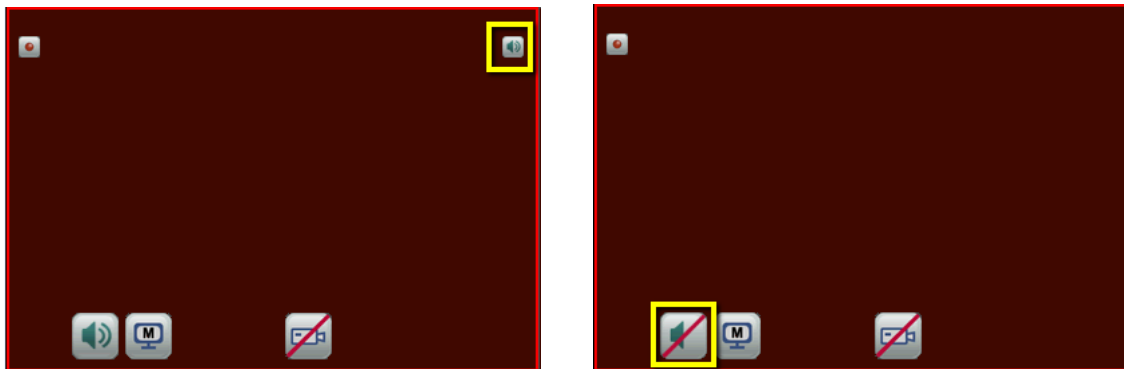

3.1.2 OSD Root Menu

1. Right-click the mouse, the OSD Root Menu appears.



2. Click on any icon to enter the setup menus.
3. Click the  button on the top-right corner or right-click to close the OSD Root Menu.

3.1.3 Field Input Options



You may find the following fields in the System menu. Follow the instructions below to configure the settings.

Text Box: Click on the box and an on-screen keyboard will appear.

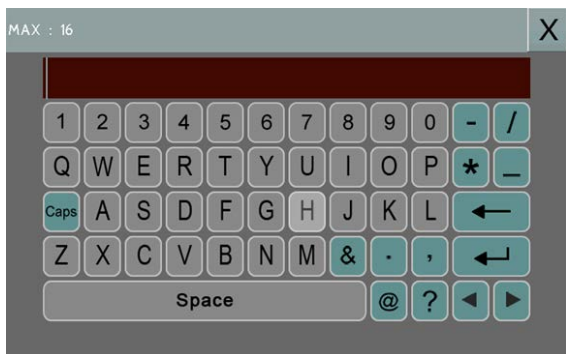

On-Screen Keyboard: Click on a button to input that character. The buttons on the right and bottom have the following functions:



Caps	Switch to capital letters
←	Delete the letter backwards
	Confirm the selection
	Move to left
	Move to right
Space	Enter a space

Drop-Down Box: Click on the down arrow to see all selections, then directly click on an option to select it.

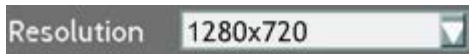

Check Box: Click on the box to enable it (checked) or disable it (unchecked).



Button: Click the button to execute the function.



Bar: Slide the bar to the left or right for adjusting the set point.



3.2 Front Panel Buttons Operation

3.2.1 Front Panel Review

The basic principle of front panel operation is to use the Arrow Keys (Up / Down / Right / Left) to navigate among the menu items. Press the **Enter** button to confirm a selection or enter the submenu. Press the **Menu** button to enter the OSD Root Menu or exit from the current menu.

3.2.2 How to Select a Channel / Enable Audio

1. In the Live View window, you can select a channel by using the arrow keys to scroll through each channel. The selected channel will be highlighted with a red frame.
2. After selecting a channel, press the **Enter** button to turn On / Off the Audio function. An Audio icon  will be displayed on the upper-right corner on the selected channel. To display function icons on the Live View window, please refer to *4.4 Display*.

3.2.3 OSD Root Menu

1. Press the **Menu** button, the OSD Root Menu Bar appears. Press the right and left arrows keys to move through each icon. The title of the icon will be displayed at the lower-left corner.



2. Press the **Enter** button to enter the setup menus.
3. Press the **Menu** button to close the OSD Root Menu Bar.

3.2.4 Field Input Options

You may find the following fields in the System menu. Follow the instructions below to configure the settings.

Text Box: Press the **Enter** button and an on-screen keyboard will appear.



Drop-Down Box: Press the **Enter** button to see all selections, press the up and down arrow keys to highlight the desired option, and then press the **Enter** button again to select it.

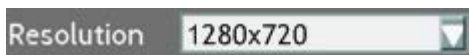

Check Box: Press the **Enter** button to enable it (checked) or disable it (unchecked).



Button: Press the **Enter** button to execute the function.





Bar: Press the **Enter** button to activate the slider, press the right and left arrow keys to adjust the setting, and then press the **Enter** button again to finalize the changes.



On-Screen Keyboard: Use the arrow keys to highlight each character and then press the **Enter** button to input the selected characters. After inputting the characters, highlight **Save** on the setup menu, and then press the **Enter** button to confirm.



Caps	Switch to capital letters
←	Delete the letter backwards
	Confirm the selection
	Move to left
	Move to right
Space	Enter a space

3.3 General Operation

3.3.1 Login

In order to access ELUX16x2 again after logging out, you may be prompted to log in for authority identification. To log in, follow the steps below.

1. Right-click on the screen, the Login window appears.

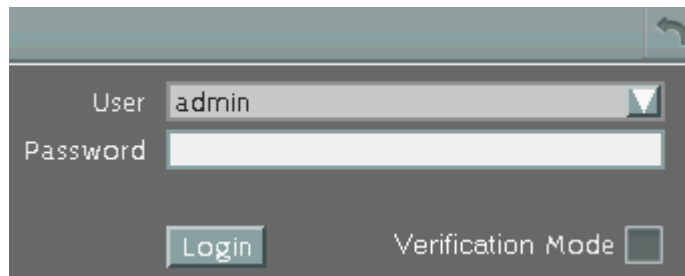

2. The default user name and password are:

User: admin

Password: 11111111

Note: For details on setting up multiple user accounts, please refer to [6.9.4 User Management](#).

To input the User Name and Password by:

Using a mouse: Select a user name from the drop-down list. Click the Password field to bring up the on-screen keyboard. Click the buttons and then click  to confirm the User Name / Password.

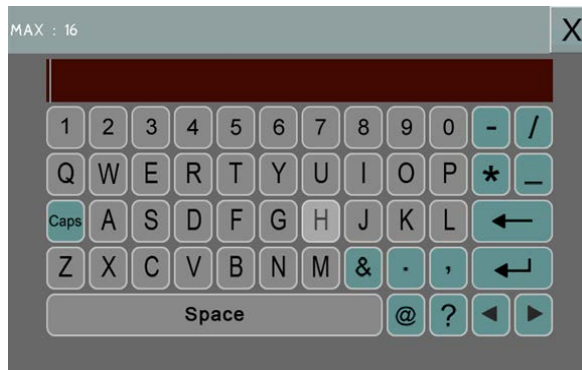

Using the front panel buttons: Use the arrow keys to select the password field and then press the **Enter** button to bring up the on-screen keyboard. Use the arrow keys to highlight each character and then press the **Enter** button to input the selected characters. When finished, highlight **Done** and press the **Enter** button to confirm the password.

3. Click **Login** to log in the DVR.

3.3.2 Forget Your Password

1. If you forget your password, please email the **Serial Number** of the DVR to ts@everfocus.com.tw, and then EverFocus will send you a verification code.
2. Input this verification code in the **Password** field of the Login window within 24 hours, and check the **Verification Mode** box.

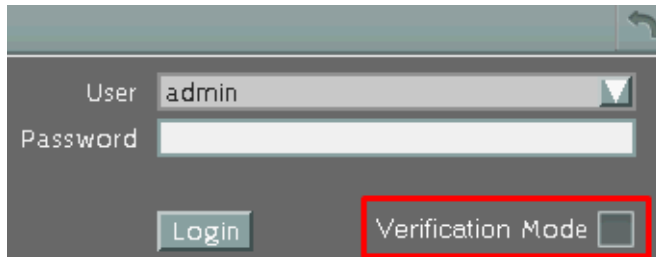

3. Click **Login** to log in the DVR.

Note: This verification code is effective within 24 hours only, so please set up a new password in the System Setting page (refer to 6.9.4 User Management).

3.3.3 Camera Selection

You can control each camera individually by selecting that camera. To select a camera, follow the instructions below.

Using a mouse: Click a camera on the screen, and the selected camera will be highlighted with a red frame. All cameras will be selected when you scrolling the mouse up / down between the first and the last channel. You can also click the same layout type in the layout menu to select all cameras. For example, if your screen is in 4-division, click the 4-division layout type to select all cameras.

Using the front panel buttons: Use the arrow keys to select through the camera. The selected camera will be highlighted with a red frame. All the cameras will be selected when pressing the right or left arrow keys to select between the first / last camera.

3.3.4 Audio Selection

In order to utilize the audio function, please follow the instructions below before switching on the audio function.

1. Connect the audio source and/or audio output amplifier to the DVR. Note that both of the audio input and output devices require a (built-in) amplifier and external power supply.
2. Go to Camera setting menu (OSD Root Menu > System > Camera > Basic).
3. Select a camera on the drop down list.

4. Enable the **Record Audio** option and select an audio input device. You can select multiple cameras to one single audio input device (there are 16 audio input devices).



Note that the DVR only provides one channel audio output. You can switch the Audio Output function to either one from the cameras. To switch the Audio Output function to the desired camera by:

Using a mouse: Single-click on the desired channel screen, the highlighted channel will be automatically applied with the Audio Output function (an audio icon will be displayed on the upper-right corner of the channel). To turn on/off the Audio Output function, click the Audio Icon  at the lower-left side of the monitor.

Using the front panel buttons:



1. Use the arrow keys to select Camera.
2. Press the **Enter** button. An Audio icon  will be displayed on the upper-right corner on the selected camera. To display function icons on the Live View window, please refer to 4.4 *Display*.
3. If you want to disable the Audio Output function on the selected camera, press the **Enter** button again, the Audio icon will disappear.

Chapter 4

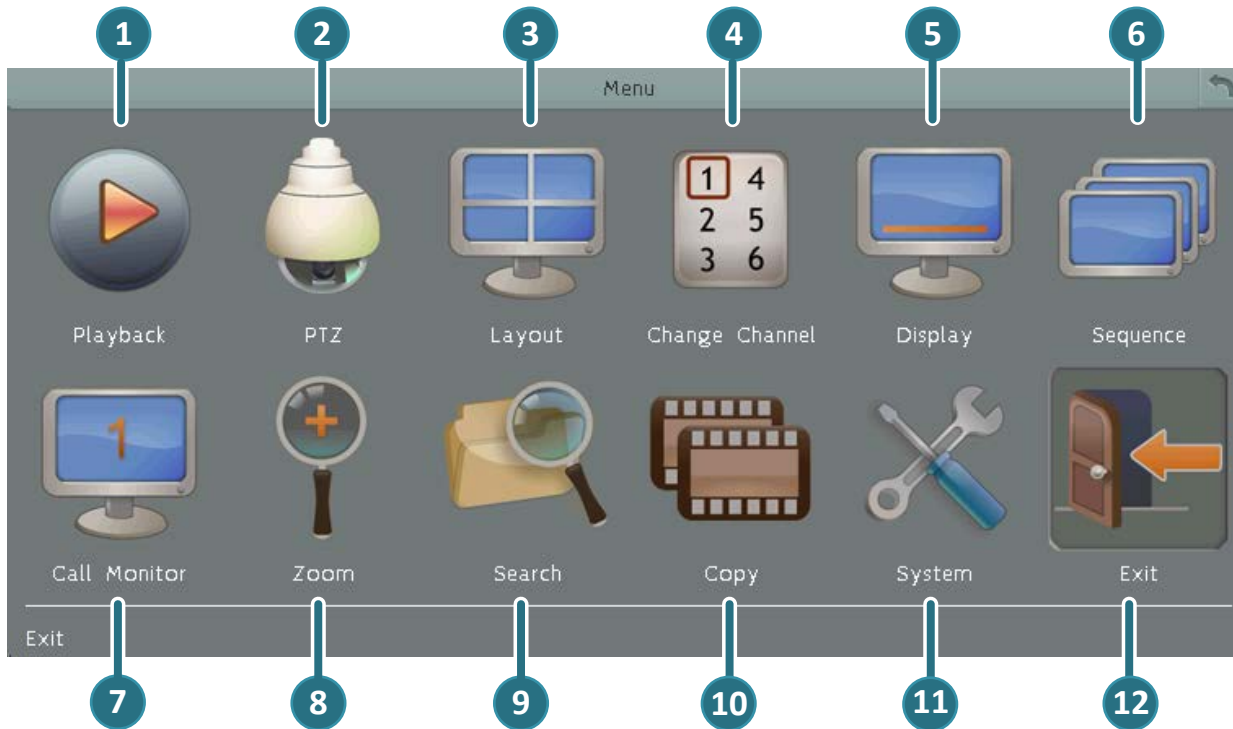
4. OSD Root Menu



No	Name	Description
1	Playback	Click to display the Playback Bar for viewing the recording videos. For details, please refer to 5. <i>Search and Playback</i> .
2	PTZ	Click to display the PTZ Control Panel for controlling the connected PTZ cameras. For details, please refer to 4.1 <i>PTZ</i> .
3	Layout	Click to display the Layout Bar as shown below. Select a layout type for the live view display on the Main Monitor. For details, please refer to 4.2 <i>Layout Switching</i> . 

4	Channel	<p>Click to display the Channel Changing Bar shown as below. To switch the selected camera to a specific channel, please refer to <i>4.3 Channel Switching</i>.</p> 
5	Display	<p>Click to display system information icons or status icons on the live view screen. For details, please refer to <i>4.4 Display</i>.</p>
6	Sequence	<p>Click to enter the auto sequential switching mode. Click again to disable. For setting up the sequencing order, please refer to <i>6.6.2 M/T SEQ</i>.</p>
7	Monitor	<p>Click to switch to the call monitor settings. On the OSD Root Menu, click the Monitor button  to switch to the Call monitor. On the OSD Root Menu, the Playback, PTZ, Zoom, Search, Copy, System and Exit icons will gray out. You can only configure the Layout, Channel, Display and Sequence settings for the Call Monitor. To switch to the Main Monitor, click the  button. Note that the Call Monitor can only be used to display camera views. Functions include the layout, channel switching, icon display, sequencing mode of the Call Monitor can only be configured on the Main Monitor.</p>
8	Zoom	<p>Click to enter the Zoom mode. You can zoom in the camera view up to x4 and navigate the camera view. For details, please refer to <i>4.6 Zoom</i>.</p>
9	Search	<p>Click to display the Search menu for setting up the Search mode for playing back. For details, please refer to <i>5.3 Searching the Recordings for Playback Back</i>.</p>
10	Copy	<p>Click to display the Copy menu for archiving the recordings or log data to the USB storage device or DVD. For details, please refer to <i>4.7 Archiving the Recordings or Log Data to the USB or DVD</i>.</p>
11	System	<p>Click to enter the System Setting menu. Please refer to <i>6. System</i>.</p>
12	Exit	<p>Click to bring up the Logout Confirmation window and then click Yes to log out the system (see <i>4.8 Logout</i>). To log in, please refer to <i>3.3.1 Login</i>.</p>

4.1 PTZ

You can use the PTZ Control Panel to control the connected PTZ cameras. To bring up the PTZ

control panel, on the OSD Root Menu, click the PTZ button .

The following actions can be performed using the PTZ Control Panel:

1. To bring up the PTZ OSD menu (only supported for EverFocus eZ.HD PTZ cameras):
 - a. Click the **Preset** button.
 - b. Click the Preset number 95.
 - c. Click the **Go** button.
2. To move the camera to the desired direction and angle, click the **Direction** buttons.
3. To zoom in / out the camera view, click the **Zoom** buttons.
4. To adjust the camera focus, click the Focus buttons.
5. To adjust the Iris open to increase / decrease the amount of light in, click the **Iris** buttons.
6. To program a Preset Position (if supported by the camera):
 - a. Move the PTZ camera to the desired position.
 - b. Click the **Preset** button.
 - c. Set up a preset number for the current position by clicking the number buttons. The number will be displayed in the number box.
 - d. Click the **Set** button to save the settings.
7. To jump to a Preset Position:
 - a. Click the **Preset** button.
 - b. Click the desired Preset number.
 - c. Click the **Go** button.
8. Shortcut for Preset 1 ~ 9:
 - a. Click digit 1 ~ 9 button without clicking any other buttons.
 - b. The camera will seek that Preset Position.



9. To delete a Preset Position (if supported by the camera):
 - a. Click the **Preset** button.
 - b. Click the desired Preset number.
 - c. Click the **Delete** button.
10. To operate the Auto Pan function, click the **Auto Pan** button.
11. To operate the Pattern function, click the **Pattern** button. The Pattern is the “0” Tour in Everfocus and Pelco PTZ cameras.
12. To operate the Tour function:
 - a. Click the **Tour** button.
 - b. Click the desired Tour number.
 - c. Click the **Go** button.
13. To remove a pre-configured Tour (if supported by the camera):
 - a. Click the **Tour** button.
 - b. Click the desired Tour number.
 - c. Click the **Delete** button.

Click **C** to clear the entered number in the Number Box.

Click  at the top-right corner to hide the PTZ Control Panel (see 4.1.1 Express Control of PTZ). To display the PTZ Control Panel, right-click on the screen.

Click **Exit PTZ** to close the PTZ Control Panel and exit the PTZ mode.



Note: Before start using the Auto Pan, Pattern and Tour functions, you have to configure the related settings for the connected PTZ cameras. Please refer to the User’s Manual of your PTZ cameras.

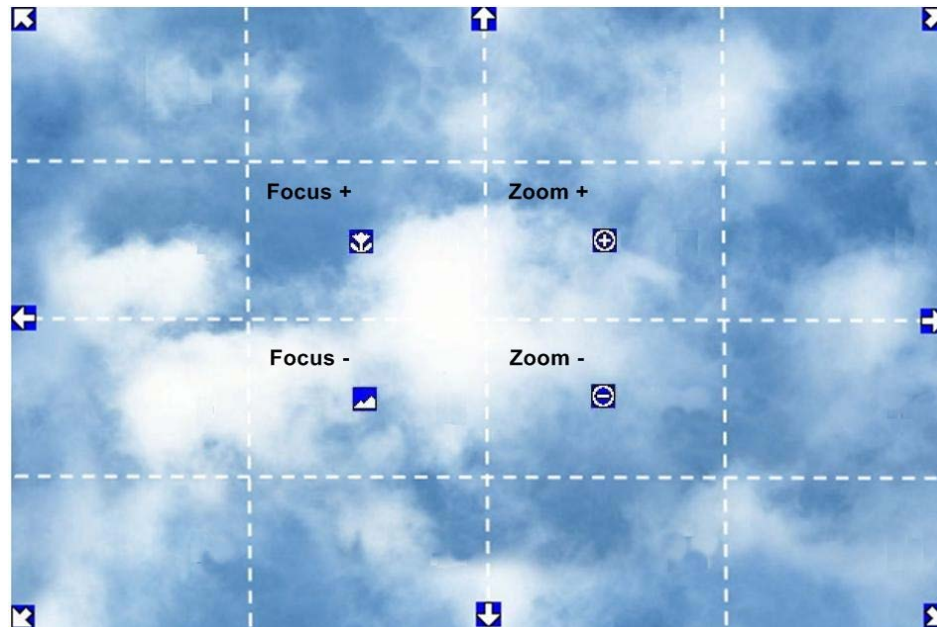

4.1.1 Express Control of PTZ

If the PTZ Control Panel has first been opened and then hidden, the mouse can be used to control basic PTZ functions. Move your mouse cursor on the screen, the mouse cursor will turn into a control icon (direction, focus or zoom) in different areas of the screen. You can control PTZ direction, focus and zoom by clicking directly on the screen.



Direction Controls: When your mouse cursor turns into a direction icon, click on the screen will force the camera to move toward that direction.

Focus Controls: When your mouse cursor turns into , click on the screen will focus closer the image. When your mouse cursor turns into , click on the screen will focus farther the image.

Zoom Controls: When your mouse cursor turns into , click on the screen will zoom in the image. When your mouse cursor turns into , click on the screen will zoom out the image.

4.2 Layout Switching

The DVR has several screen division types available, which are shown as below:



To change layout, follow the steps below:

By mouse: Right-click to bring up the OSD Root Menu and click the **Layout** icon. Click on the desired layout.

By front panel: Press the **View** button on the front panel of the DVR to switch to a desired layout. To display a channel in full-screen, press the channel buttons on the front panel.

4.3 Channel Switching

You can switch the selected camera to a specific channel. Follow the steps below:

1. On the live view screen, select a camera, the selected camera will be highlighted with a red frame.
2. Right-click to display the OSD Root Menu.

3. Click the **Channel** icon , the Channel Bar appears.

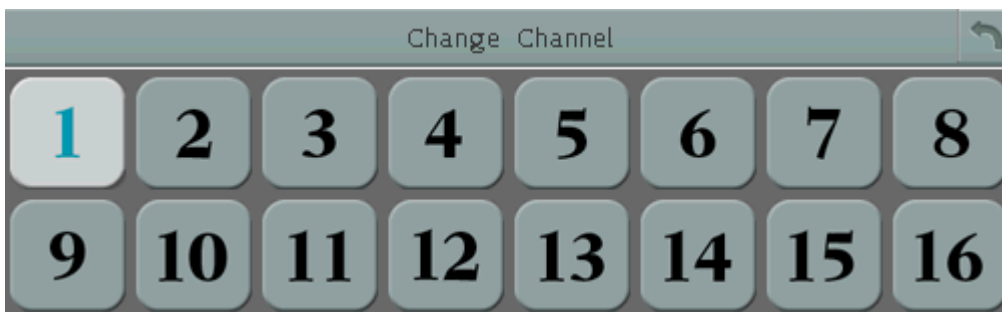











4. Select a channel, the selected camera will be switched to that channel.

4.4 Display











You can display system and camera status on the live view screen. Follow the steps below:

1. Click the Display button  on the OSD Root Menu to display the system and camera status. You can continue click on the button to switch among the display modes. There are four modes provided: (1) Display both the camera and system status icons. (2) Display only the camera status icons. (3) Display only the system status icons. (4) Hide both the camera and system status icons.

2. The following icons will be displayed at the upper side of each camera stream to show each camera's status.

 Recording	 Playback	 Fast forward	 Fast backward	 Back	 pause
 Alarm	 Motion	 Video loss	 Uninstall	 Audio On	

3. The following icons will be displayed at the bottom of the monitor to show the system status.

 Audio On	 Audio Off	 Alarm	 Motion	 Video loss
 No network 1	 Sequence	 HDD failure*	 HD temp. too high	 Event

* The DVR features Auto HDD Retry mechanism. Once the HDDs have been installed, when encounter HDD fail error (all installed HDDs failed simultaneously), the DVR will automatically reboot to detect the installed HDDs up to 3 times. Please refer to *Appendix G: Auto HDD Retry Mechanism* for more details.

4.5 Sequence

The sequence function is used to display each channel in sequence mode. To enable this function:



By Mouse: Click the Sequence button  to enter the sequential switching mode. The DVR will display one channel at a time in full screen. The channels will be displayed in the sequence and for the amount of time as configured in the System > Display Setting > M/T SEQ submenu. The default setting is channels 1~16 / 1~8 / 1~4 with a dwell time of 3 seconds each – repeated. Please refer to 6.6.2 M/T SEQ for detailed information.

By Front Panel: Press the “SEQ” button on the front panel to enter the sequential switching mode.

4.6 Zoom

You can zoom in the camera view up to 4X and navigate the camera view using the mouse.





To enter the Zoom mode:

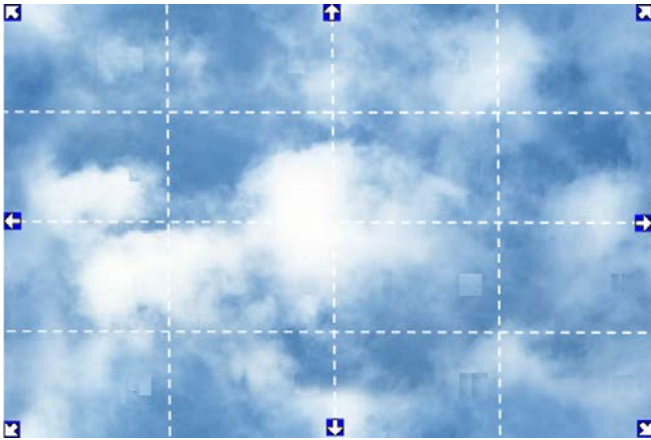

1. Select a camera and then click the **Zoom** button  on the OSD Root Menu to zoom in the camera view to 2X. The ZOOM 2X stamp will be displayed on the top screen.
2. Navigate the camera view to the desired position by moving your mouse cursor over the camera view. The mouse cursor will turn into a direction icon when you move your mouse cursor to different portion on the camera view. Click directly on the screen can move to that direction.



3. Right-click the screen, the Zoom Bar appears in the middle of the screen.
4. Click  to zoom in the camera view up to 4X.
5. Click the **Logout** button  to log out the Zoom mode.

4.7 Archiving the Recordings or Log Data to the USB or DVD

You can archive the recordings or log data (event and motion) to the USB storage device or the DVD. On the OSD Root Menu, click the **Copy** icon , the following menu appears.

Note:

1. To archive recordings to the USB, it's recommended to connect the USB memory stick to the USB port on the **REAR** panel.
2. It's highly recommended to use a DVD+R with 4x or higher speed disc for recording.

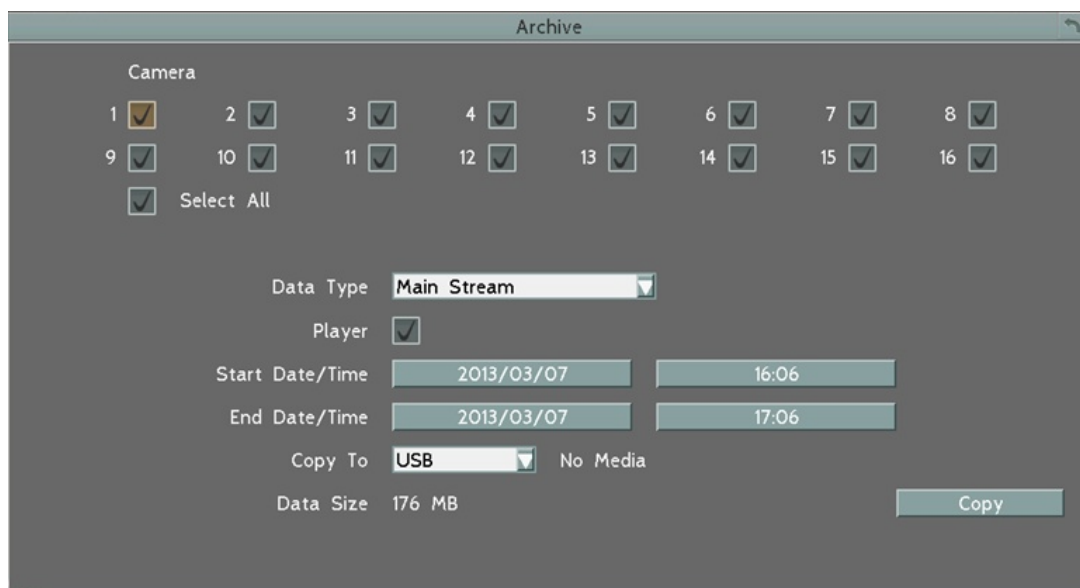

Camera: Select the desired cameras. If you archive the data to the DVD, all the cameras will be selected and the selection options will be grayed out.

Data Type: You can copy the recordings of selected cameras from main stream or sub stream.

Player: Check the box to include the **EFPlayer**  program in the copy. You can use the EFPlayer on a computer to play back the recordings.

Start Date / Time: Click to bring up the on-screen keyboard / clock to select the start date / time.

End Date / Time: Click to bring up the on-screen keyboard / clock to select the end date / time.

Copy To: Select whether you want to copy to USB or DVD. The log data can only be archived to the USB storage device. Note that the DVD burner is optional for Germany. To eject the DVD tray, please refer to the next page.

Copy: Click to start archiving.

How to eject DVD Tray:

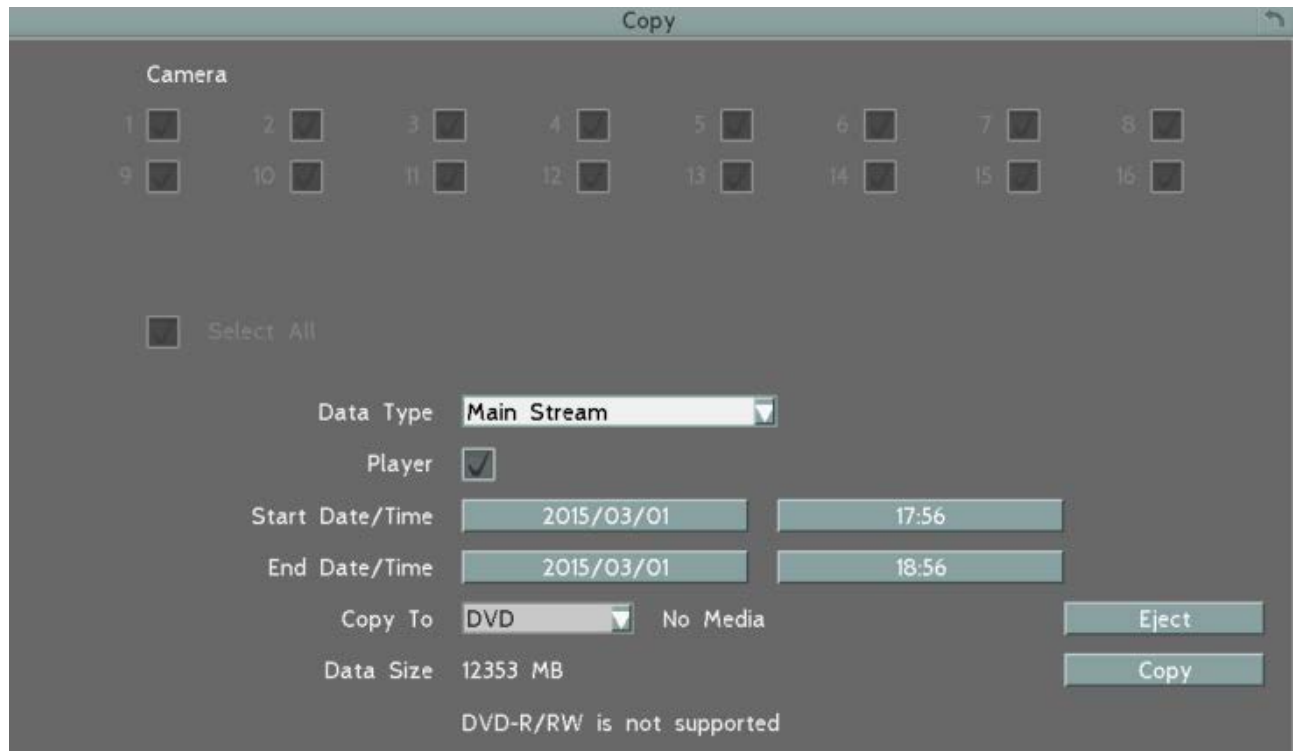







1. Select DVD from the **Copy to** drop-down list.
2. Click **Eject** to open the DVD tray.
3. To close the tray, simply push the tray and it will automatically close.

EFPlayer:

Unzip the EFPlayer file and double-click to open it as below. The EFPlayer can only display up to 16 channels at one time.



No.	Name	Function Description
1	Information	Shows the recording information of the device, including model of the recorder, recording start time / date, current playback time, recording end time / date.
2	Load	Click to select a recording file and open it.
3	Save as AVI	Click to archive the recording file of 1 channel and save as AVI format.
4	Time Search	Click to search a recording from a selected time.
5	Channel Switch	Click to switch channel bar between CH1~16 and CH17~32.
6	Time Bar	Move the time bar to a desired time to play back the recording from that time.
7	Playback Controls	 : Click to fast reverse / fast forward.

		  : Click to reverse play / forward play.  : Click to pause playing back.
8	Snapshot	Click to take a snapshot of the channels displayed on the UI. You can save the snapshot file to a desired location.
9	Mute	Click to mute; click again to turn off the mute function.
10	Volume	Drag to increase or lower the volume.
11	Scale Out / In	Click to adjust time scale.
12	Screen Division	 : Click to display the channels to fit the screen.  : Click to select a desired screen division display mode (1, 4, 9, 16 screen division display modes). If the channels are more than the screen divisions, you can select the same screen division display mode to change the channels on the screen.
13	Speed	Shows the fast reverse / forward speed (up to 64X).

4.8 Logout

You can log out the DVR by clicking the **Exit** icon  on the OSD Root Menu to bring up the Logout Confirmation window as below. Press “Yes” when you are ready to logout the system. You will need to login again before accessing the OSD Root Menu.



If you do not need the Login / Logout step before entering the Root Menu, please uncheck the **Login** box on the User Management setting page. For more details, please refer to [6.9.4 User Management](#).



4.8.1 Temporarily Logout

You can temporarily log out the DVR by clicking the **Exit** icon  on the OSD Root Menu. This function is designed for use in conjunction with the **Covert Camera** function. Once you click the **Exit** icon, the camera streams will be hidden on the Live View / Sequence Mode. However, the DVR will still record the videos and the recordings can be played back.

To enable the Temporarily Logout function, follow the steps below:

1. Ensure the User Login box is **Unchecked** (OSD Root Menu > System > System Setting > User Management).



2. Select the cameras to be hidden once enabling the Temporarily Logout function and then check the **Covert** box (Camera Setting > Basic Setting). Click the **Save** button.

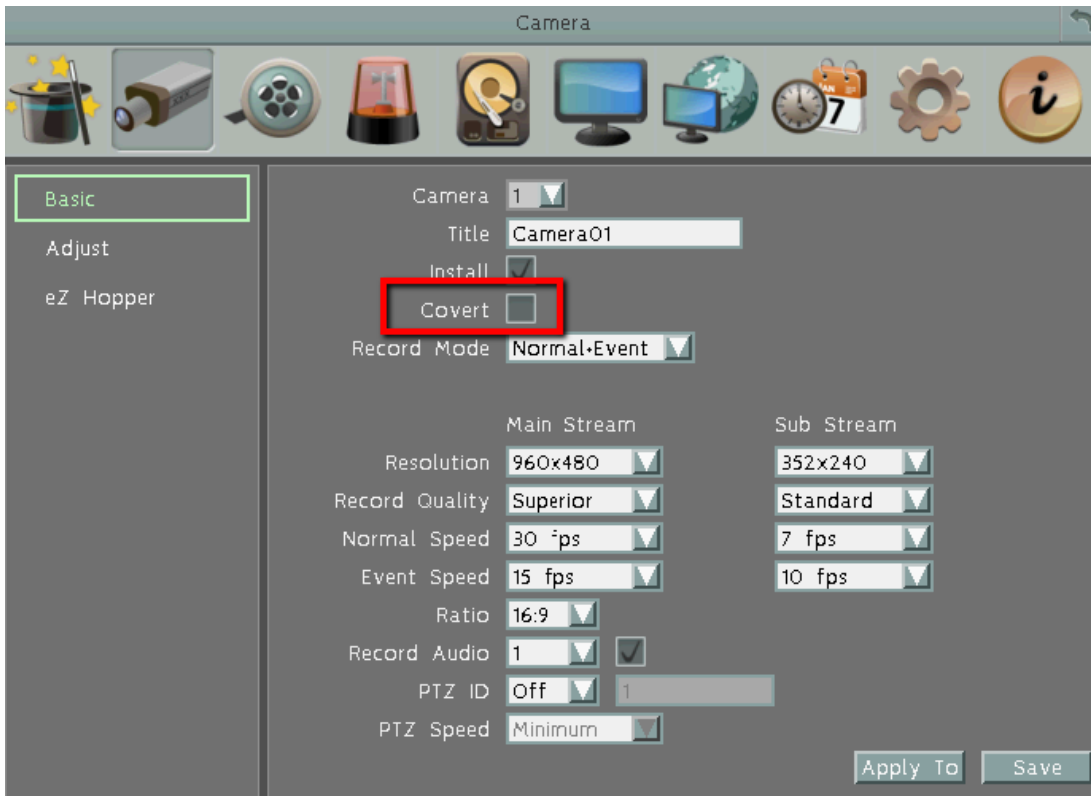

3. Click the **Exit** icon on the OSD Root Menu, the Logout window appears.



4. Click the **Yes** button and the selected camera streams will be hidden on the Live View / Sequence Mode.
5. To disable the Temporarily Logout function, simply right-click the screen to bring up the OSD Root Menu, and then you can start controlling the DVR.

Chapter 5

5. Search and Playback

You can use the Quick Playback function to play back the recordings start from the pre-configured time or use the Search functions to search for the desired recordings for playing back.

5.1 Quick Playback

To start using the Quick Playback function, follow the steps below:

1. To set up the start time of the playback recording, check the **Quick Playback** box on the **Express** setting page (OSD Root Menu > System > Express) to enable the configured time in the field below.
2. Enter the desired time for playing back the recording. Take 60 seconds for example, if the current system clock time is 17:35:00, the start time for the playback recording will start from 17:34:00 (60 seconds ago from 17:35:00).



3. On the Live View Window, select a desired camera, right-click to bring up the OSD Root Menu and then click the Playback button .
4. The recording should be played back and the Playback Bar appears on the bottom of the screen.

5.2 Playback Bar

The playback bar is the fastest way to show video from the exact time which users want to see. The playback bar allows users to see both a timeline and the current playback indicator. Users can then click the timeline to move the indicator to the desired position.

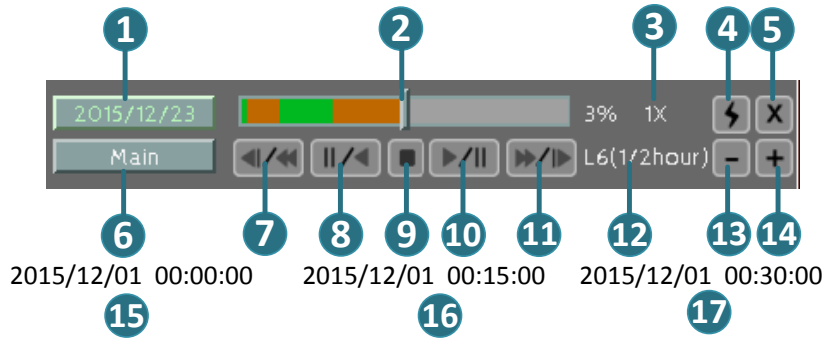

No.	Name	Description
1	Date/Time	Click to set up the start time of playback recording.
2	Time Bar	Move the slider to the left / right on the Time Bar to select the time for playing back. The status of each camera is presented by different colors on the Time Bar. Green→Normal, Orange→Motion, Blue→Video Loss, Red→Alarm Event.
3	Playback Speed	Indicates the current Playback Speed (up to 8X).
4	Express Copy	Click to bring up the Copy menu for archiving the recordings / log data to the USB storage device or DVD burner. For details, please refer to 4.7 Archiving the Recordings or Log Data to the USB or DVD .
5	Close	Click to hide the Playback Bar. To bring up the Playback Bar again, move your cursor to the lower side of the screen.
6	Main /Sub Stream	Click to select the recorded data from main or sub stream
7	Fast Reverse	Click to play the recorded data in fast reverse.
8	Reverse Play/Pause	Click to play the recorded data in reverse at normal speed. Click this button again to Pause the reverse playback. Click the Stop button to stop all playback actions and exit the playback area.
9	Stop	Click to stop all playback actions and exit the playback mode.
10	Play/Pause	Click to play the recorded data forward. Click this button again to Pause the playback.

No.	Name	Description
11	Fast Forward	Click to play the recorded data in fast forward.
12	Time Scale	L1: Entire Time Bar scale is 30 days. L2: Entire Time Bar scale is 2 weeks. L3: Entire Time Bar scale is 1 week. L4: Entire Time Bar scale is 1 day. L5: Entire Time Bar scale is 1 hour. L6: Entire Time Bar scale is 30 minutes.
13	Time Bar Scale	Use the + and - buttons to adjust the time scale range for the bar. The scale range includes 6 options (levels). When changing the level, the Start Time and End Time will change.
14		
15	Start Time	Indicates the playback start time.
16	Current Playback Time	Indicates the current playback time.
17	End time	Indicates the playback end time.

5.3 Searching the Recordings for Playing Back

You can search the recordings for playing back by using the **Search** menu. On the left side of the Search menu, select **Time Search**, **Event Search**, **Smart Search**, **Snapshot Search** or **POS Search** to enter to the setup menu.

To bring up the **Search** menu:

By Mouse: Right-click to bring up the OSD Root Menu, and then click the **Search** button .

By Front Panel: Press the **Search** button.



5.3.1 Time Search

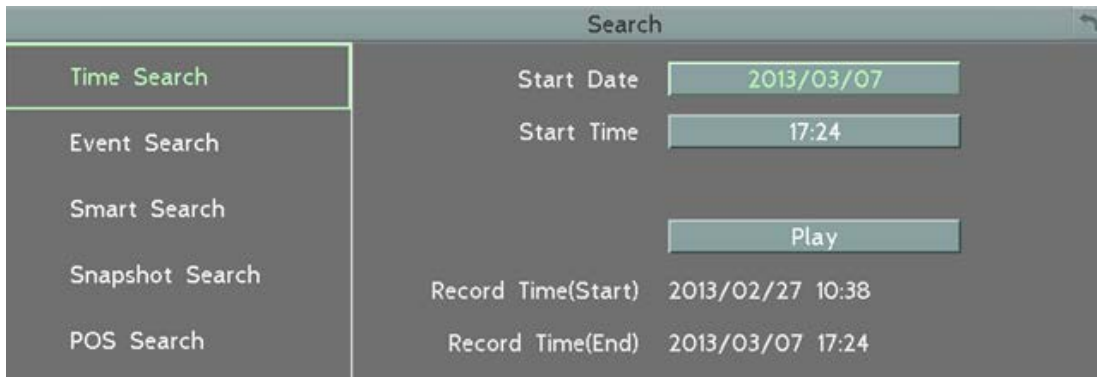

Start Date: Click to bring up the on-screen keyboard to select the date.

Start Time: Click to bring up the on-screen clock to select the time.

Play: Click to start playing back.

5.3.3 Smart Search

The Smart Search function allows users to search for the motion event recordings. You can set up the motion areas in this setup menu and then search for the motion events within the specified time.

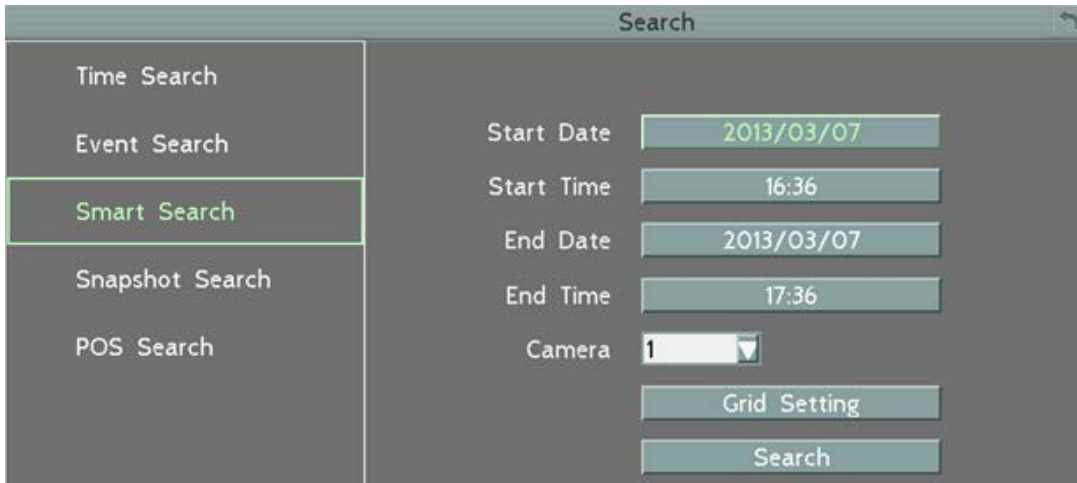

Start Date / End Date: Click to bring up the on-screen keyboard to select the start / end date.

Start Time / End Time: Click to bring up the on-screen clock to select the start / end time.

Camera: Select a desired camera to be searched.

Grid Setting: Click to set up the motion areas. The Motion Grid Setup menu appears.

Search: Click to start searching. The search results will be listed in the Event List menu.

To set up the Motion Grid:

1. Click on the image and the grid will be displayed.
2. To set up a motion area, drag a rectangle with your mouse (from top to bottom / upper-left to lower-right). The selected areas will be highlighted in green (see image below).
3. To delete a motion area, drag a rectangle with your mouse (from bottom to top / lower-right to upper-left).
4. Follow Step 2 to set up multiple motion areas if necessary.
5. Click the **Save & Back** button to save the settings and then return to the Smart Search menu.

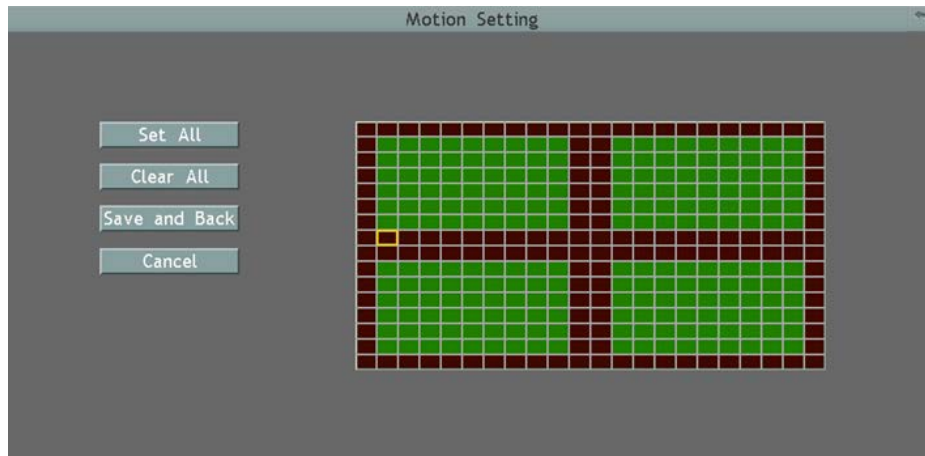

Set All: Click to select the entire area.

Clear All: Click to clear all the selected areas.

Save and Back: Click to save the configured motion areas and return to the Smart Search menu.

Cancel: Click to cancel all changes and return to the Smart Search menu.

5.3.4 Snapshot Search

You can display video frames in snapshot and resume a video from where the snapshot has been set up (Snapshot Search only supported by local site).

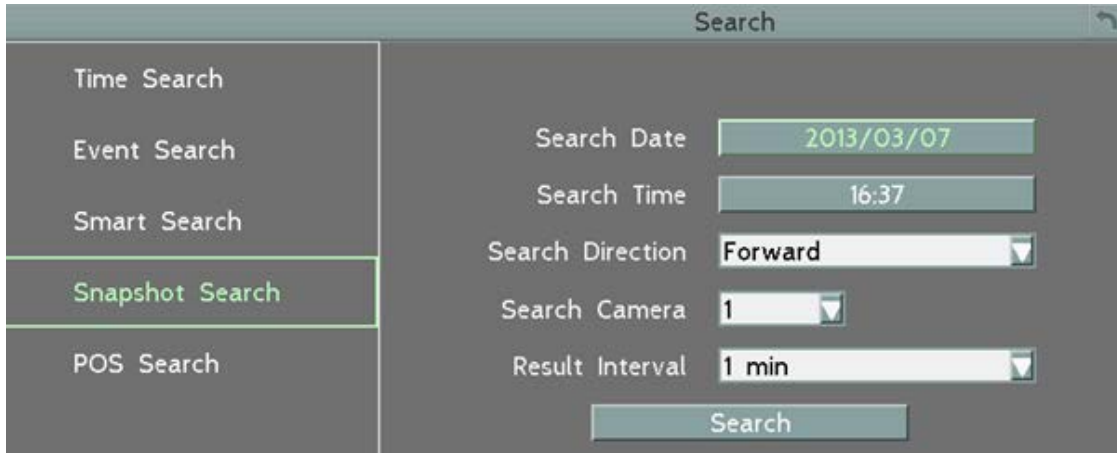

The screenshot shows a 'Search' window with a sidebar menu on the left and search parameters on the right. The sidebar menu includes 'Time Search', 'Event Search', 'Smart Search', 'Snapshot Search' (highlighted with a green border), and 'POS Search'. The search parameters are: 'Search Date' (2013/03/07), 'Search Time' (16:37), 'Search Direction' (Forward), 'Search Camera' (1), and 'Result Interval' (1 min). A 'Search' button is located at the bottom right of the parameter area.

Search Date: Click to bring up the on-screen keyboard to select the date.

Search Time: Click to bring up the on-screen clock to select time.

Search Direction: Click to search forward / backward based on the setup time above.

Search Camera: Select a desired camera to be searched.

Result Interval: Click to set up the interval for the snapshots of the video frame. For example, if you select 5 minutes, the video frame will be snapshotted with 5-minute interval (see image below).

Search: Click to start searching. The search results will be displayed in 16 screen division (see image below).

To resume the video:

1. Click the **Search** button, the search results are displayed in 16 screen division. In this picture, you can see the time layouts on the upper-left corner of each snapshot, which are set up with 5-minute interval.

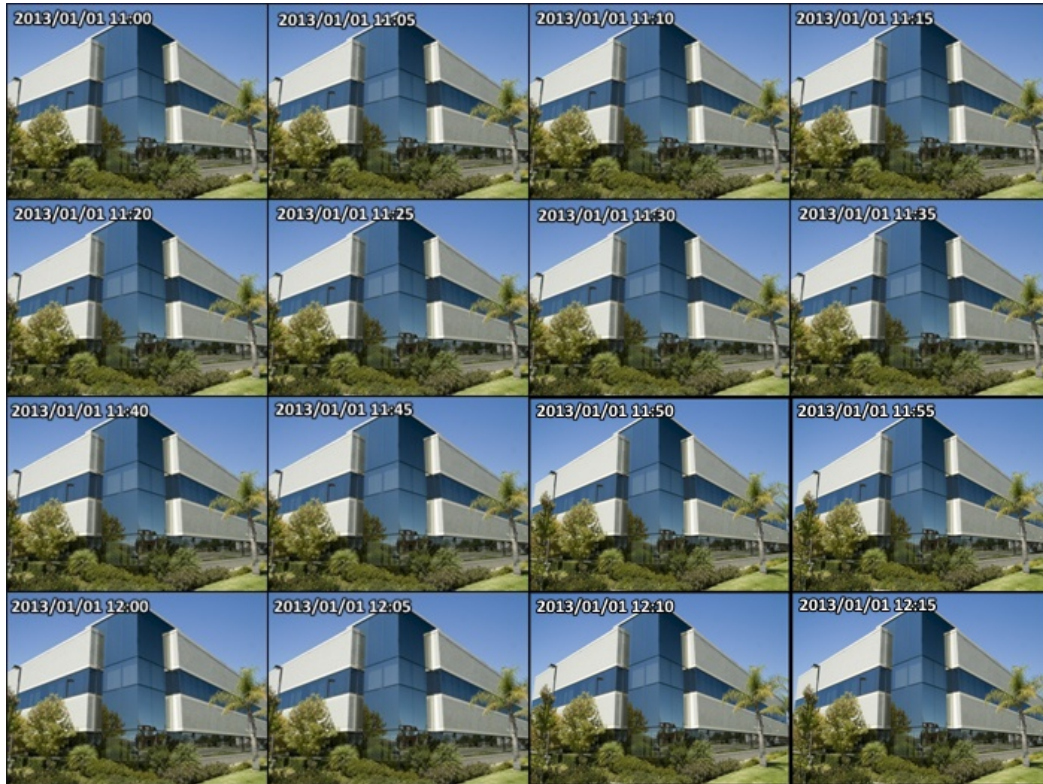

2. Right-click on the screen, the Resume Playback Bar appears in the middle of the screen.

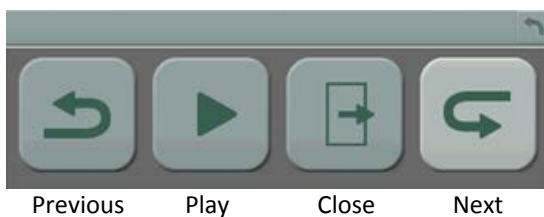

3. Click the **Previous** or **Next** buttons to display the previous / next snapshots.
4. Select a snapshot by clicking on the snapshot, the selected snapshot will be highlighted with a white frame.
5. Click the **Play** button to resume the video.
6. Click the **Close** button to close the Resume Playback Bar and then return to the Snapshot Search menu.

5.3.5 POS Search

The POS Search function allows users to search and play back the recordings with the POS transaction data within a specific time.

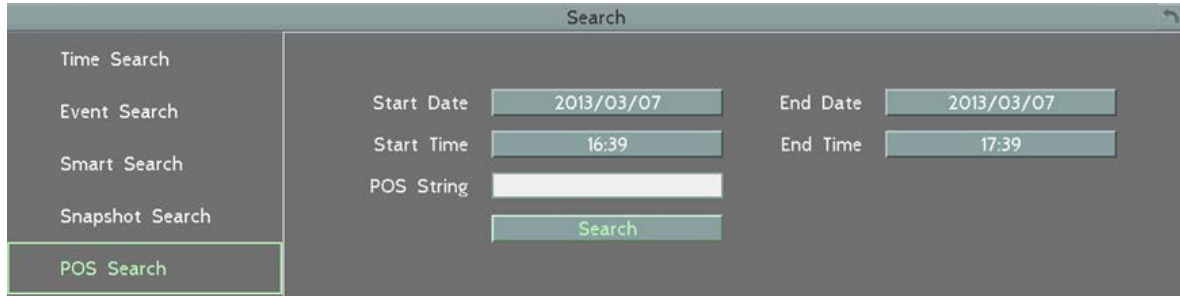

Start Date / End Date: Click to bring up the on-screen keyboard to select the start / end date.

Start Time / End Time: Click to bring up the on-screen clock to select the start / end time.

POS String: Click to bring up the on-screen keyboard. Type any desired keyword to search the specific transaction data.

Search: Click to start searching. The search results will be listed in the Event List menu as shown below.

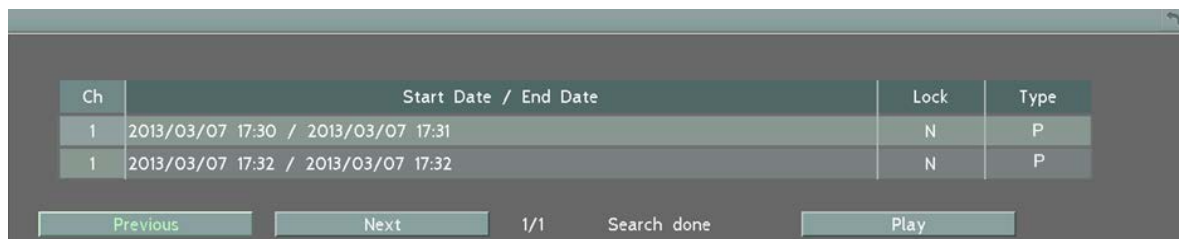

Ch	Start Date / End Date	Lock	Type
1	2013/03/07 17:30 / 2013/03/07 17:31	N	P
1	2013/03/07 17:32 / 2013/03/07 17:32	N	P

Previous / Next: Click to go to the previous / next page.

Play: Click to playback the selected items.

You need to set up the POS settings before searching the video with POS transaction data. Please follow the steps below:

1. Connect the POS system to the RS-485 port at the rear panel of the DVR.
2. Make sure the RS-485 settings of the DVR are the same as those of the POS system. Select the Text Insert in the **Type** drop-down list. (OSD Root Menu > System > System Setting > I/O control).

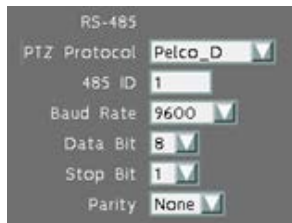

3. Check the **Text Insert** box in the Monitor OSD setting page to display the transaction data on the screen (OSD Root Menu > System > Display > Monitor OSD).



4. The transaction data, such as date, time, item, price and any customized information, synchronized with the surveillance video will be displayed on the screen, shown as the image below.

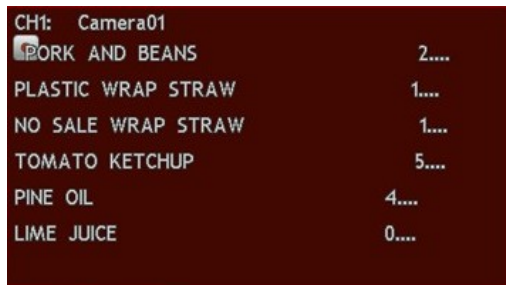

Chapter 6

6. System

The DVR can be configured through a series of menus on screen by using a **Mouse, front panel buttons**, the supplied **IR Remote Control**, or the optional device **EKB500 keyboard** and **EKB200 keyboard**. The following operations are examples of using a Mouse. This chapter describes the functions and options of the Configuration Setting in the on-screen display (OSD) menus.

Right-click the mouse, the OSD Root Menu appears. Click the **System** button , the following Configuration Menu displayed with 10 setup options appears.

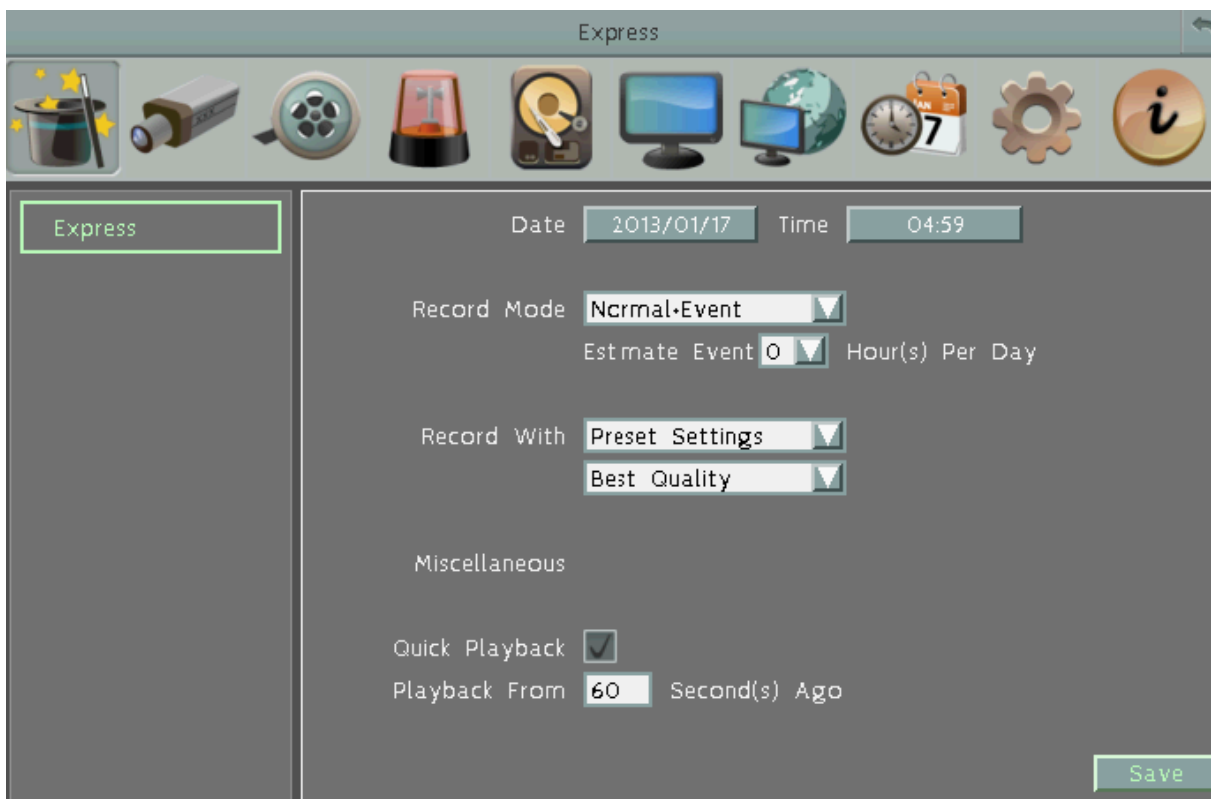

List of System Options:

Please find the topic of interest by referring to the section prefixed to each option.

6.1 Express	
6.2 Camera	6.2.1 Basic 6.2.2 Adjust 6.2.3 eZ Hopper
6.3 Record	
6.4 Event	6.4.1 Alarm 6.4.2 Video Loss 6.4.3 Motion 6.4.4 Other
6.5 Disk	6.5.1 Disk 6.5.2 Lock/Format
6.6 Display Setting	6.6.1 Monitor OSD 6.6.2 M/T SEQ
6.7 Network	6.7.1 LAN 6.7.2 Email 6.7.3 DDNS 6.7.4 FTP 6.7.5 Alarm Server 6.7.6 Remote/Mobile 6.7.7 Network Test
6.8 Schedule	6.8.1 Express Setup 6.8.2 Holidays 6.8.3 Schedule
6.9 System Setting	6.9.1 Date / Time 6.9.2 Daylight Saving Time 6.9.3 User Group 6.9.4 User Management 6.9.5 I/O Control 6.9.6 EKB200 Setting 6.9.7 Miscellaneous
6.10 System Information	6.10.1 System 6.10.2 Log

6.1 Express

This menu is used to configure global express settings for all cameras.



Date: Click to bring up the on-screen keyboard to set up the system date.

Time: Click to bring up the on-screen clock to set up the system clock.

Record Mode: Select a recording mode from the drop-down list.

Blank: Select this option for all cameras to keep the current individual record settings without any changes. Please refer to *6.8.1 Express Setup* for more details.

Normal+Event: Set all cameras to the Continuous and Event recording mode. Set up the estimated number of hours per day for event recording.

Event Only: Set all cameras to the Event only recording mode. Set up the estimated number of hours per day for event recording.

Schedule Record: Set all cameras to the Schedule recording mode.

Record With: Select a record method.

Blank: Select this option for all cameras to keep the current individual record method without any changes.

Preset Settings: Select this option and further set up the recording quality. For details, please refer to *Appendix D. Express Setup Recording Value Selection Rules*.

Recording Days: This option is not available for Schedule Record. Set up the maximum recording days. For details, please refer to *Appendix D. Express Setup Recording Value Selection Rules*.

Miscellaneous:

Quick Playback: Check the box to enable the Quick Playback function as described below.

Playback From X Seconds ago: When the DVR is put into playback mode, it will begin playing from the selected time. Choose from 60 to 3600 seconds prior to the present time.

Save: Click to save and apply the settings to the DVR. The system will automatically adjust the recording frame rate according to your settings.

6.2 Camera

You can configure the settings for individual camera. The setting options include **Basic**, **Adjust Settings** and **eZ Hopper**.

6.2.1 Basic Setting

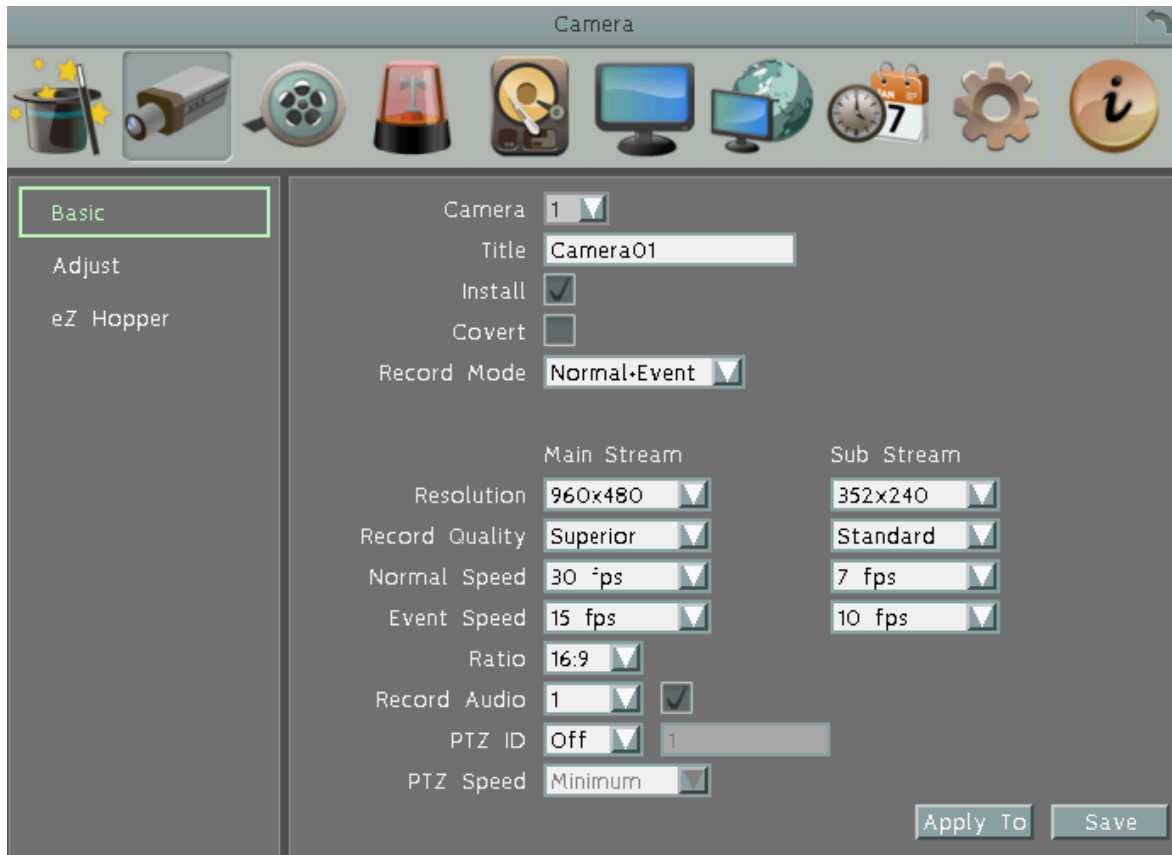

Camera: Select a camera to be configured.

Title: Click to bring up the on-screen keyboard for assigning a title for the selected camera. Each title supports up to 16 characters. The title will be displayed on each channel.

Install: Check the box to enable the selected camera.

Covert: Check the box to hide the camera stream on Live View and Sequence modes. However, the DVR will still record the videos and the recordings can be played back by users who have the privilege to playback. For details on enabling the Covert function, please refer to *4.8.1 Temporarily Logout*.

Record Mode: Select a record mode from the drop-down list.

Normal+Event: Continuous and Event recordings.

Event Only: Event recordings only.

Main / Sub Resolution: Select the most suitable resolution for the Main Stream and Sub Stream. If you connect cameras (1080p) to the DVR, the main stream resolution option will display 1920x1080 only. If you connect cameras (720p) to the DVR, the main stream resolution option will display 1280x720 only. The Sub Stream is designed for remote operation, such as remote live view and remote playback. Please refer to 7.2 *Remote Live View* for more details.

Main Stream	Sub Stream
Camera (1080p): 1920x1080 Camera (720p): 1280x720 WD1 or D1 Camera: 960x480 / 704x480 / 352x240	352x240 / 176x120

Record Quality: Select a recording quality for the Main Stream and Sub Stream. The options include Low, Basic, Standard, High and Superior. The higher the quality, the more the HDD space is used.

Normal Speed: Select a frame rate per second (FPS) for continuous recording. The speed is limited by the maximum total recording capacity of the DVR as allocated across all the installed cameras, with upper limit of 30 FPS (NTSC) / 25 FPS (PAL) per individual camera respectively (real time recording). For 1080p cameras, the upper limit is 15 FPS (NTSC) / 12.5 FPS (PAL) per individual camera.

Event Speed: Select a frame rate per second (FPS) for event recording.

Ratio: Select 4:3 or 16:9 display aspect ratio of a camera, and its video will be displayed in 4:3 or 16:9 format on that channel screen. Please refer to 6.2.1.1 *Display Aspect Ratio*.

Record Audio: Check the box to enable audio recording on the DVR, and then select an audio input device.

PTZ ID: Select ON or OFF.

- Select **ON** if the PTZ camera is connected to the DVR through RS-485. To allow the DVR to recognize and then control the connected PTZ camera, you have to set up an ID for the PTZ camera. Select On and then enter an ID for the camera. This ID must match the ID address set up on the PTZ camera. For setting up the ID address on the PTZ camera, please refer to the User’s Manual of your PTZ camera.
- Select **OFF** if the PTZ camera is connected to the DVR through coaxial cable (BNC Video Input), so users can then operate Zoom, Focus, Iris, Direction, Auto Pan, Preset, Tour and Pattern functions to the PTZ camera through DVR directly.

PTZ Speed: Select a PTZ speed from the PTZ Speed drop-down list for the camera to move to the directions when you use the direction buttons during the configuration period.

Apply To: Click the button to apply the same settings to the desired cameras.

Save: Click to save the settings.

6.2.1.1 Display Aspect Ratio

It is recommended to select the same ratio of the screen resolution and the camera live view display to avoid black bars displayed on the live view screen as the images below.

If you select 1920x1080 (16:9) screen resolution on the **Screen Mode** drop-down list (see 6.6.1 *Monitor OSD*), it is recommended to change the camera live view display to 16:9 aspect ratio on the **Ratio** drop-down list (see 6.2.1 *Basic Setting*).

Screen Mode: 1920x1080 (16:9)

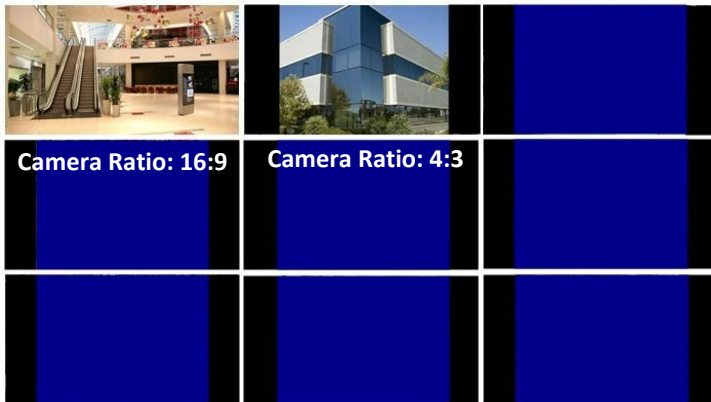

If you select 800x600, 1024x768 or 1280x1024 (4:3) screen resolution on the **Screen Mode** drop-down list (see 6.6.1 *Monitor OSD*), it is recommended to change the camera live view display to 4:3 aspect ratio on the **Ratio** drop-down list (see 6.2.1 *Basic Setting*).

Screen Mode: 800x600 / 1024x768 / 1280x1024 (4:3)

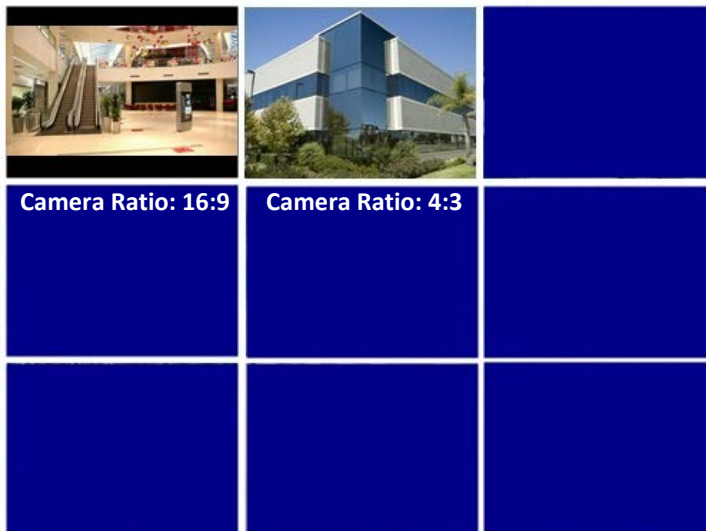

6.2.2 Adjust Setting

You can adjust the Brightness, Contrast and Color of the selected camera.

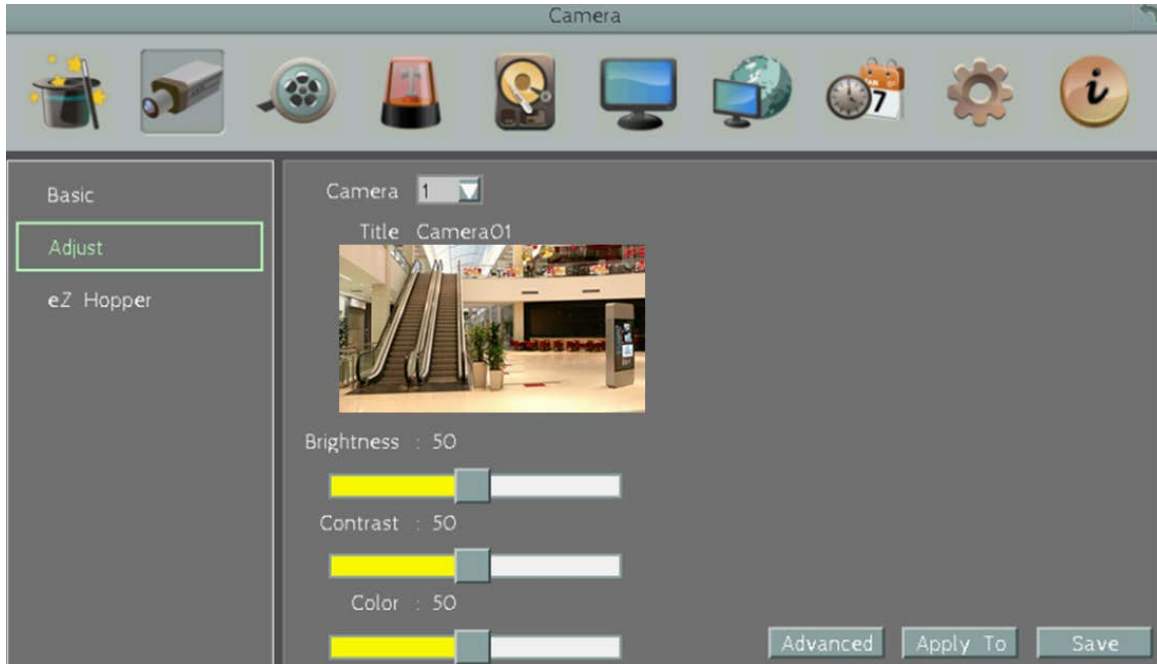

Camera: Select a camera to adjust the following settings.

Brightness: Move the bar to adjust the brightness.

Contrast: Move the bar to adjust the contrast.

Color: Move the bar to adjust the color.

Advanced: Click to bring up the **Coaxial Panel** and then click the **Enter** button  to enter the camera's OSD menu for controlling and adjusting the camera setting. All EverFocus' eZ.HD cameras and other brands' AHD cameras enabled with UTC function are supported. For more details about eZ.Controller function, please refer to *1.2 eZ.Controller Function Description*.



1. Use the direction buttons on the **Coaxial Panel** to control the camera's OSD setting menu.
2. To exit the camera OSD setting, click the **Exit** button to return to the **Adjust** setting page.

Apply To: Click the button to apply the same settings to the desired cameras.

Save: Click to save the settings.

6.2.3 eZ Hopper

You can just use one mouse to control up to 16 DVRs/NVRs on the same LAN network by enabling the eZ Hopper function.

Note: Before using this function, you need to set up all the monitors to be the same resolution, please refer to 6.6.1 Monitor OSD.



Set up one DVR or NVR to be the **Main Server**, and the rest to be the **Sub Servers**. Then, you just need to connect a mouse to the **Main Server**, and you will be able to move its cursor across all the connected monitors of the **Main** and **Sub Servers** and to control all the OSD menus of the connected devices respectively.

Follow the steps below to set up the eZ Hopper function:

For the Main Server:

1. Select **Main Server** from the **Mode** drop-down list, and check the **Enable** box.



- The position of each device on the OSD layout represents the physical positions of the monitors where you arrange and place in the monitoring site.

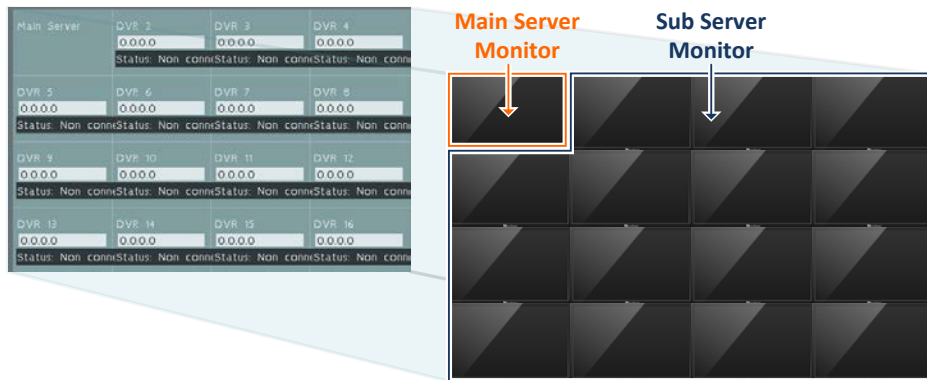

- Click an IP address field to enter the **IP address** of a Sub Server and the first Sub Server must be adjacent to the Main Server on the OSD layout (DVR 2 or DVR 5), or the eZ Hopper function will not work.

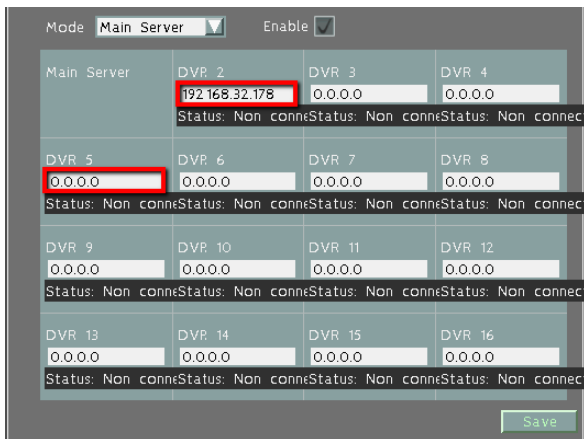

- Set up the rest of the Sub Servers by entering their IP addresses. Please note that the Sub Servers must be adjacent to one another on the layout, or the eZ Hopper function will not work.

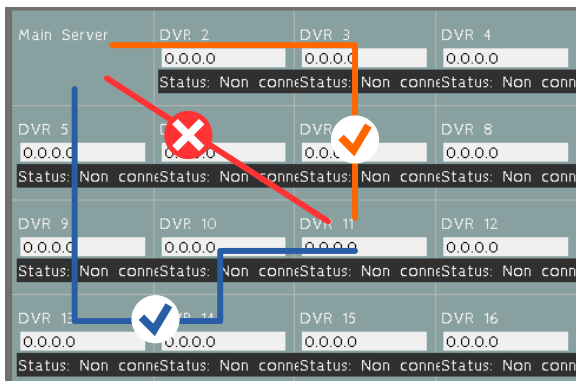

- Click **Save** to save the setting.

For the Sub Server:

1. Select Sub Server in the **Mode** drop-down list, and check the **Enable** box.

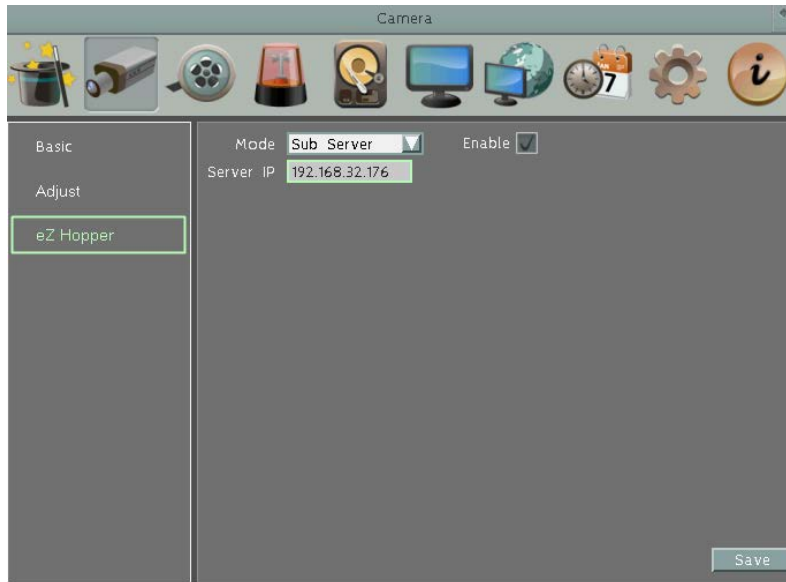

2. Enter the IP address of the Main Server, and click **Save**.
3. When the message pops up as below, the eZ Hopper function is enabled. So, you can now use the mouse connected to the Main Server to control this Sub Server's OSD.

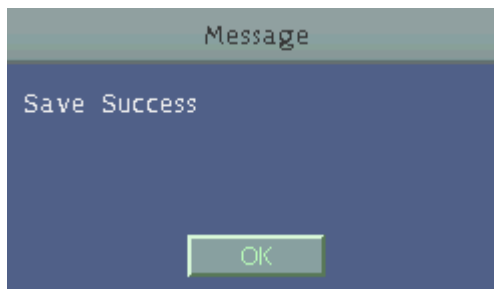

4. Follow the above 3 steps to set up the rest Sub Servers.

6.3 Record

You can configure the basic recording settings on the hard disk.



Record Overwrite: Check the box to overwrite the hard disk when it is full. Note that unless this box is checked, or the DVR will stop recording when the hard disk is full. The use of record overwrite is strongly recommended. If you do not use this feature, please be sure to enable the Event setting for Disk Full for notification (see 6.4.4 Other).

Schedule Record: Check the box to enable the Schedule Record function. To set up schedule record, please see 6.8 Schedule Setting for more details.

Time Stamp: Select Bottom or Top to record the system date and time on the bottom / top of the image. Select off will not overlay the system date and time in the recordings.

Record Status Relay Output: Select a number to monitor the recording status of the selected alarm relay. The recording status of the selected alarm relay will be transmitted to the alarm output device.

Auto Erase Video: The hard disk will automatically erase video after it has been on the hard drive for the selected number of days. To use the maximum hard drive space, choose "OFF". (See Record Overwrite and notes above.) This feature is useful if local rules and regulations require recorded video to be discarded after a specific number of days, or to limit the retention of older recorded video to clear space in anticipation of event recording.

Estimation Result: Shows the remaining storage space.

Save: Click to save the settings.

6.4 Event

You can configure the Alarm, Video Loss, Motion and Other settings in this menu.

6.4.1 Alarm



Alarm: Select an Alarm input number from 1 to 16.

Enable: Check the box to enable the Alarm trigger function for the selected alarm input.

Log: Check the box to record alarm events to log data.

Pre-alarm Record: Check the box to start copying the recordings to the hard disk from 5 seconds before the alarm event occurs. Note that the pre-alarm recording rate will follow the **Normal Speed** configured in the earlier section (see *6.2.1 Basic Setting*).

Buzzer: Check the box to enable the buzzer when an alarm event is triggered.

Email Notify: Check the box to send email notification with a snapshot file when an alarm event is triggered. Email operation requires valid email entered in the Email setup menu (see *6.7.2 Email*).

Network Alarm: Check the box to send out a network alarm to a client PC when an alarm event occurs. This feature works with EverFocus' CMS software. You will need to configure the Alarm Server for the DVR to send network alarms to the client PC (see 6.7.5 *Alarm Server*).

Auto Lock: Check the box and the events will be recorded in a write protected segment of the hard disk (will not be overwritten). The DVR will lock the space for a period of time when alarms occur. The length of the time depends on DVR setting (see 6.5.2 *Lock / Format*).

FTP Upload: Check the box to enable uploading recordings to the FTP server function. To setup the FTP server, please refer to 6.7.4 *FTP*.

FTP Upload File Type: Select MP4 file type to upload videos to FTP server; select JPEG file type to upload snapshots to the FTP server.

Alarm Output: Select an alarm output number. When an alarm is triggered, the signal will be transmitted through the selected alarm output relay.

Output Type: Select an output type when an alarm is triggered.

Timeout: Select this option and then set up the Timeout Duration in the field below, the alarm output will last for the setup duration time (10 ~ 150 seconds).

Permanent: Alarm will remain active until the user presses the "Enter" key on the IR Remote Control or resets the alarm remotely.

Transparent: Alarm output remains as long as the alarm input is active.

Trans + Timeout: Alarm output continues until event ends, then continues for the setup duration time (10 ~ 150 seconds).

Timeout Duration: This function only appears when you select **Timeout** or **Trans + Timeout** options in the Output Type drop-down list. Select a duration time for the events. The alarm output will last for the setup duration time between 1 and 150 seconds.

Main Monitor: Select **Full Screen** to force the camera associated with the selected alarm number to display full screen on the Main Monitor. The full screen camera view will last according to the Output Type selected in the field above.

Call Monitor: Select **Full Screen** to force the camera associated with the selected alarm number to display full screen on the Call Monitor. The full screen camera view will last according to the Output Type selected in the field above.

Record: Select a camera to start recording when the associated alarm number is triggered.

Input Type: Select an input type when the selected alarm number is triggered. The options include N.O. and N.C.

Active Camera: This function is for associating an alarm trigger with a specific camera. For example, if you set up an external motion detector near Camera 2, you can select Camera 2 in this field. The alarm will be associated with this camera for full screen display, event logging and PTZ actions.

PTZ: If the Active Camera selected above (in the Active Camera field) is a PTZ camera, you can further set up the PTZ actions (Preset, Tour or Pattern) in this field when an event occurs.

The following time synchronization function must work with the radio-controller clock.

Time Sync Enable: Check to enable the time synchronization with the connected radio-controlled clock.

Time Sync Interval: Select a time sync interval time (by hour) for the DVR to synchronize the time with the radio-controlled clock.

Time Sync Range: The time sync range means the allowed time difference between the DVR and the radio clock. If the time difference exceeds the entered time sync range (by second), the DVR cannot be synchronized unless you manually set up the exact same time as the clock or within the time sync range.

For example, if the radio-controlled clock time is 12:00:00 and you enter 30 seconds for the time sync range, the allowed time difference between the DVR and the clock should be within 30 seconds which means the DVR time can be 11:59:30 ~ 12:00:30.

Time Sync Range	30 Seconds	60 Seconds
Radio-controlled Clock time	12:00:00	12:00:00
DVR time	11:59:30~12:00:30	11:59:00~12:01:00

First Sync of: Enter a first sync start time.

Apply To: Click the button to apply the same settings to the desired cameras.

Save: Click to save the settings.

6.4.1.1 Connect a Radio Clock to the DVR

To use a Radio Clock, you need to connect it to the alarm inputs of the DVR.

Connection Diagram:

Connect the positive (+) wire to either pin of Alarm Input 1~16 and negative (-) wire to the GND pin.

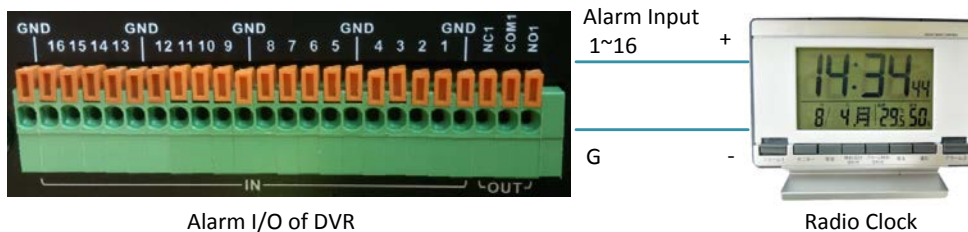

6.4.2 Video Loss

You can enable the Video Loss Event function and configured the video loss event notifications in this menu.



Camera: Select a camera to be configured.

Enable: Check the box to enable the Video Loss event settings for the selected camera.

Log: Check the box to record video loss events to log data.

Pre-alarm Record: Check the box to start copying the recordings to the hard disk from 5 seconds before the video loss event occurs. Note that the pre-alarm recording rate will follow the **Normal Speed** configured in the above section (see 6.2.1 Basic Setting).

Buzzer: Check the box to enable the buzzer when a video loss event is triggered.

Email Notify: Check the box to send email notification when a video loss event is detected. Email operation requires valid email entered in the Email setup menu (see 6.7.2 Email).

Network Alarm: Check the box to send out a network alarm to a client PC when video loss event occurs. This feature works with EverFocus' CMS software. You will need to configure the Alarm Server for the DVR to send network alarms to the client PC (see 6.7.5 Alarm Server).

Alarm Output: Select an alarm output number. When an alarm is triggered, the signal will be transmitted through the alarm output relay.

Output Type: Select an output type when an alarm is triggered.

Timeout: Select this option and then set up the Timeout Duration in the field below, the alarm output will last for the setup duration time (10 ~ 150 seconds).

Permanent: Alarm will remain active until the user presses the “Enter” key on the IR Remote Control or resets the alarm remotely.

Transparent: Alarm output remains as long as the alarm input is active.

Trans + Timeout: Alarm output continues until event ends, then continues for the setup duration time (10 ~ 150 seconds).

Timeout Duration: This function only appears when you select **Timeout** or **Trans + Timeout** options in the Output Type drop-down list. Select a duration time for the motion event. The alarm output will last for the setup duration time between 10 and 150 seconds.

Apply To: Click the button to apply the same settings to the desired cameras.

Save: Click to save the settings.

6.4.3 Motion

You can enable the Motion Event function and configured the related settings including motion event notifications and motion areas in this menu.



Camera: Select a camera to be configured.

Enable: Check the box to enable the Motion Event settings for the selected camera.

Log: Check the box to record motion events to log data.

Pre-alarm Record: Check the box to start copying the recordings to the hard disk from 5 seconds before the motion event occurs. Note that the pre-alarm recording rate will follow the **Normal Speed** configured in the above section (see 6.2.1 Basic Setting).

Buzzer: Check the box to enable the buzzer when a motion event is triggered.

Email Notify: Check the box to send email notification when a motion event is detected. Email operation requires valid email entered in the Email setup menu (see 6.7.2 Email).

Network Alarm: Check the box to send out a network alarm to a client PC when motion occurs. This feature works with EverFocus' CMS software. You will need to configure the Alarm Server for the DVR to send network alarms to the client PC (see 6.7.5 Alarm Server).

Auto Lock: Check the box and the events will be recorded in a write protected segment of the hard disk (will not be overwritten). The DVR will lock a period of time when the alarm occurs. The length of the time depends on DVR setting (see 6.5.2 Lock / Format).

FTP Upload: Check the box to enable uploading recordings to the FTP server function. To setup the FTP server, please refer to *6.7.4 FTP*.

FTP Upload File Type: Select MP4 file type to upload videos to FTP server; select JPEG file type to upload snapshots to the FTP server.

Alarm Output: Select an alarm output relay. When an alarm is triggered, the signal will be transmitted through the selected alarm output relay.

Output Type: Select an output type when an alarm is triggered.

Timeout: Select this option and then set up the Timeout Duration in the field below, the alarm output will last for the setup duration time (10 ~ 150 seconds).

Permanent: Alarm will remain active until the user presses the “Enter” key on the IR Remote Control or resets the alarm remotely.

Transparent: Alarm output remains as long as the alarm input is active.

Trans + Timeout: Alarm output continues until event ends, then continues for the setup duration time (10 ~ 150 seconds).

Timeout Duration: This function only appears when you select **Timeout** or **Trans + Timeout** options in the Output Type drop-down list. Select a duration time for the motion event. The alarm output will last for the setup duration time between 10 and 150 seconds.

Main Monitor: Select **Full Screen** to force the camera which detects motion to display full screen on the Main Monitor. The full screen camera view will last according to the Output Type selected in the field above.

Call Monitor: Select **Full Screen** to force the camera which detects motion to display full screen on the Call Monitor. The full screen camera view will last according to the Output Type selected in the field above.

Edit Motion Grid: Press the button to bring up the Motion Setting menu. To edit the motion grids, please refer to the instructions later in this section.

Apply To: Click the button to apply the same settings to the desired cameras.

Save: Click to save the settings.

To Edit the Motion Grids:

1. Click the **Edit Motion Grid** button, the Motion Setting menu appears. By default, all area is selected for motion detection (green color).

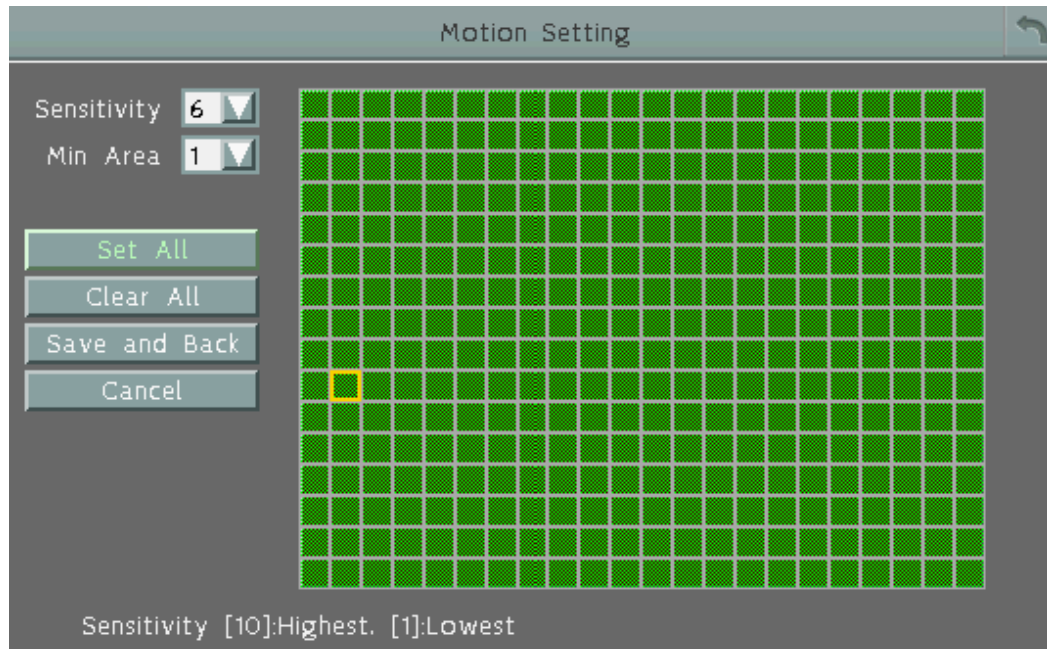

2. To set up a motion area, click the **Clear All** button to deselect all the motion grids. Drag a rectangle with your mouse (from top to bottom / left to right). The selected areas will be highlighted in green (see image below).

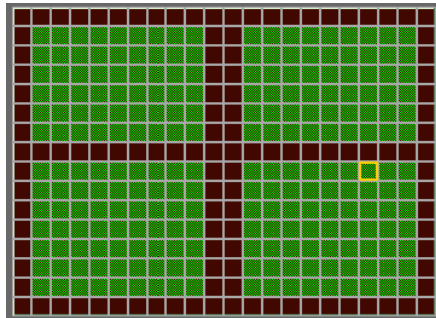

3. To delete a motion area, drag a rectangle with your mouse (from bottom to top / right to left).
4. Follow Step 2 to set up multiple motion areas if necessary.
5. Set up the Sensitivity and Min Area for the motion grids.

Sensitivity: Set up the motion sensitivity for the grids. The larger the number, the higher the sensitivity.

Min Area: This function is designed to prevent false detection caused by small objects. If you select 2, only the object size larger than 4-grid size can be detected.

6. Click the **Save and Back** button to save the settings and then return to the Motion menu.

6.4.4 Other

You can configure the system event settings and enable the Buzzer or Email alert for notifications. The event options include: **Disk Temperature**, **Disk Failure**, **Disk Full**, **Disk Off**, **Power Loss** and **Network Loss**.

6.4.4.1 Disk Temperature.



Log: Check the box to record alarm events to log data.

Buzzer: Check the box to enable buzzer when System / Hard Disk's (HD) temperature is over the "Temp. Warning Limit" set up in the below field.

Email Notify: Check the box to send email notification when system / Hard Disk's (HD) temperature is over the "Temp. Warning Limit" set up in the below field. Email operation requires valid email entered in the Email setup menu (see 6.7.2 Email).

Network Alarm: Check the box to send out a network alarm to a client PC. This feature works with EverFocus' CMS software. You will need to configure the Alarm Server for the DVR to send network alarms to the client PC (see 6.7.5 Alarm Server).

Stop Recording: Check box to stop recording when System / HD's temperature is over the "Temp. Warning Limit" set up in the below field.

Temp. Warning Limit: Sets the trigger temperature for System / HD Temperature event actions. Choose between 45°C /113°F and 70°C /158°F.

Alarm Output: Select an alarm output number. When an alarm is triggered, the signal will be transmitted through the selected alarm output relay.

Output Type: Output action will be Transparent and cannot be changed (alarm output remains as long as the alarm condition is active).

Save: Click to save the settings.

6.4.4.2 Disk Failure

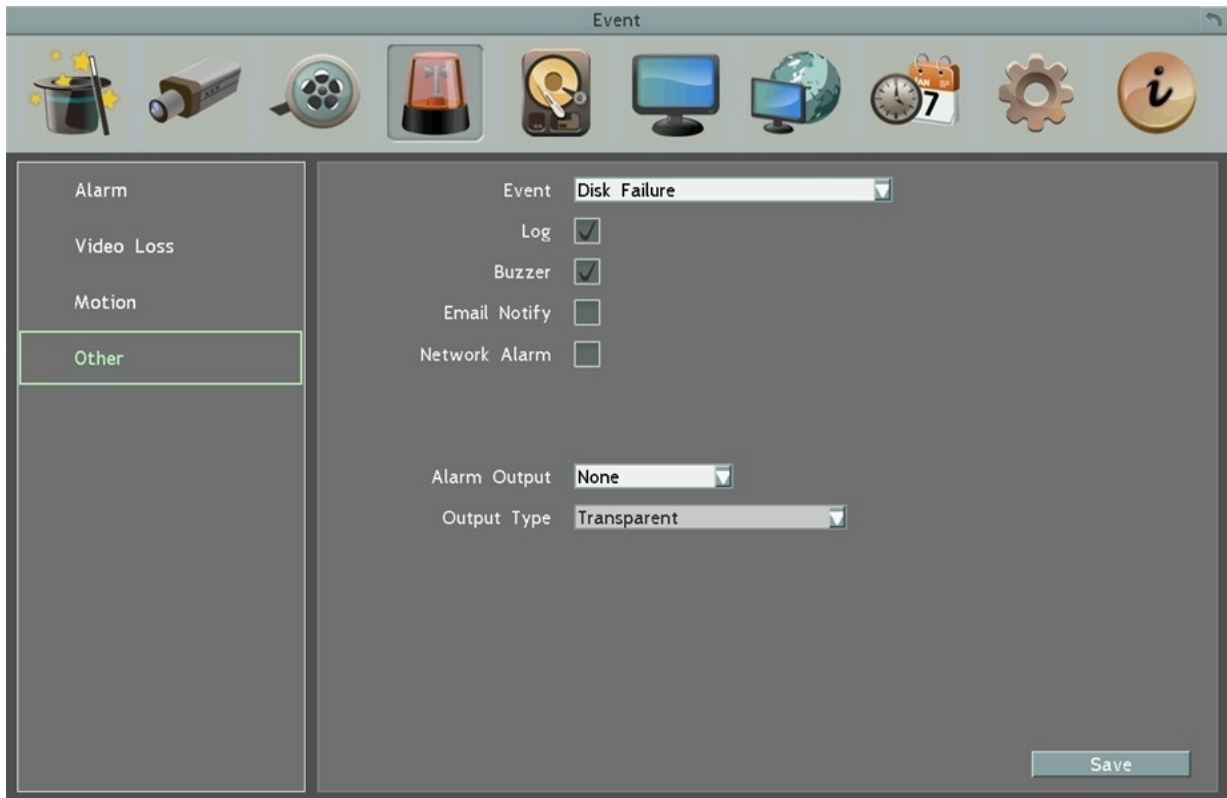

Log: Check the box to record alarm events to log data.

Buzzer: Check the box to enable buzzer when Hard Disk (HD) fails.

Email Notify: Check the box to send email notification when HD fails. Email operation requires valid email entered in the Email setup menu (see 6.7.2 Email).

Network Alarm: Check the box to send out a network alarm to a client PC when HD fails. This feature works with EverFocus' CMS software. You will need to configure the Alarm Server for the DVR to send network alarms to the client PC (see 6.7.5 Alarm Server).

Alarm Output: Select an alarm output number. When an alarm is triggered, the signal will be transmitted through the selected alarm output relay.

Output Type: Output action will be Transparent and cannot be changed (alarm output remains as long as the alarm condition is active).

Save: Click to save the settings.

6.4.4.3 Disk Full



Log: Check the box to record alarm events to log data.

Buzzer: Check the box to enable buzzer when HD is full.

Email Notify: Check the box to send email notification when HD is full. Email operation requires valid email entered in the Email setup menu (see 6.7.2 *Email*).

Network Alarm: Check the box to send out a network alarm to a client PC when HD is full. This feature works with EverFocus' CMS software. You will need to configure the Alarm Server for the DVR to send network alarms to the client PC (see 6.7.5 *Alarm Server*).

Alarm Output: Select an alarm output number. When an alarm is triggered, the signal will be transmitted through the selected alarm output relay.

Output Type: Select an output type when HD is full.

Timeout: Select this option and then set up the Timeout Duration in the field below, the alarm output will last for the setup duration time (10 ~ 150 seconds).

Permanent: Alarm will remain active until the user presses the "Enter" key on the IR Remote Control or resets the alarm remotely.

Transparent: Alarm output remains as long as the alarm input is active.

Trans + Timeout: Alarm output continues until event ends, then continues for the setup duration time (10 ~ 150 seconds).

Timeout Duration: This function only appears when you select **Timeout** or **Trans + Timeout** options in the Output Type drop-down list. Select a duration time for the event. The alarm output will last for the setup duration time between 10 and 150 seconds.

Save: Click to save the settings.

6.4.4.4 Disk Off



Buzzer: The buzzer will activate when fan is not working.

Email Notify: Check the box to send email notification when Hard Disk (HD) is off. Email operation requires valid email entered in the Email setup menu (see 6.7.2 Email).

Network Alarm: Check the box to send out a network alarm to a client PC when HD is off. This feature works with EverFocus' CMS software. You will need to configure the Alarm Server for the DVR to send network alarms to the client PC (see 6.7.5 Alarm Server).

Alarm Output: Select an alarm output number. When an alarm is triggered, the signal will be transmitted through the selected alarm output relay.

Output Type: Select an output type when HD is off.

Timeout: Select this option and then set up the Timeout Duration in the field below, the alarm output will last for the setup duration time (10 ~ 150 seconds).

Permanent: Alarm will remain active until the user presses the "Enter" key on the IR Remote Control or resets the alarm remotely.

Transparent: Alarm output remains as long as the alarm input is active.

Trans + Timeout: Alarm output continues until event ends, then continues for the setup duration time (10 ~ 150 seconds).

Timeout Duration: This function only appears when you select **Timeout** or **Trans + Timeout** options in the Output Type drop-down list. Select a duration time for the event. The alarm output will last for the setup duration time between 10 and 150 seconds.

Save: Click to save the settings.

6.4.4.5 Power Loss



Log: Check the box to record alarm events to log data.

Email Notify: Check the box to send email notification when power has been restored. Email operation requires valid email entered in the Email setup menu (see 6.7.2 *Email*).

Network Alarm: Check the box to send out a network alarm to a client PC when power has been restored. This feature works with EverFocus' CMS software. You will need to configure the Alarm Server for the DVR to send network alarms to the client PC (see 6.7.5 *Alarm Server*).

Save: Click to save the settings.

Note: As alarms and emails cannot be transmitted without power, the log entry is made when power is restored, and any notifications cannot be made until that time.

6.4.4.6 Network Loss



Log: Check the box to record alarm events to log data.

Buzzer: Check the box to enable buzzer when network is lost.

Alarm Output: Select an alarm output number. When an alarm is triggered, the signal will be transmitted through the selected alarm output relay.

Output Type: Select an output type when the network is lost.

Timeout: Select this option and then set up the Timeout Duration in the field below, the alarm output will last for the setup duration time (10 ~ 150 seconds).

Permanent: Alarm will remain active until the user presses the “Enter” key on the IR Remote Control or resets the alarm remotely.

Transparent: Alarm output remains as long as the alarm input is active.

Trans + Timeout: Alarm output continues until event ends, then continues for the setup duration time (10 ~ 150 seconds).

Timeout Duration: This function only appears when you select **Timeout** or **Trans + Timeout** options in the Output Type drop-down list. Select a duration time for the event. The alarm output will last for the setup duration time between 10 and 150 seconds.

Save: Click to save the settings.

Note: This function only checks the physical connection (link) to the network. Any network behavior that blocks data connectivity (blocked ports, IP addressing errors, etc.) is not detected by this function.

6.5 Hard Disk

The Disk menu is used to review the DVR's hard drive settings and status. No value in this menu can be configured by the operator.

6.5.1 Disk



Record Time (Start): Shows the earliest recording time of the DVR.

Record Time (End): Shows the latest or most current time on the DVR.

Disk: Select a disk number.

Health Status: Displays the current status of the selected disk.

Disk Temperature: Displays the current temperature of the selected disk.

Disk Size (Total): Shows the total space of the selected disk.

Disk Size (Usage): Shows the used space of the selected disk.

6.5.2 Lock/Format

You can control the percentage of the hard disk space reserved for Locked Event Recordings. You can also format the hard disk if necessary.



Maximum Lock (%): Sets the maximum percentage of the hard disk space reserved for Locked Event Recordings. To set up the Locked Event Recordings, please select the **Auto Lock** item in *6.4.3 Motion* or *6.4.1 Alarm*.

Current Lock (%): Displays the current percentage of the locked event recordings in the hard disk. If the amount of locked event recordings has reached the maximum lock percentage, the DVR will be unable to lock new event recordings.

Unlock All: Click this button to unlock the locked part of hard disk.

Delete All: Click this button to delete all the unlocked data in the hard disk. **WARNING:** This will effectively ERASE the hard disk's contents, except for the locked portion.

Format Disk: Click this button to format the whole HDD. **WARNING:** This will effectively ERASE the ENTIRE hard disk!!

Save: Click to save the settings.

6.6 Display Setting

You can configure the settings for displaying the camera / DVR information on the live view image. You can also set up the sequencing order for the Main / Call monitor.

6.6.1 Monitor OSD

Check the boxes under the Main / Call Monitor field. The selected items will be displayed on the live view image. Note that the DVR provides 2 call monitor outputs. The Call Monitor settings below can be applied to both of the 2 call monitors.



Main Monitor / Call Monitor

Title: Check the box to display camera titles.

Date/Time: Check the box to display current date/time.

Event Status: Check the box to display event status.

HDD Status: Check the box to display hard drive status (only for main monitor).

Playback Date/Time: Check the box to display playback date/time (only for main monitor).

Playback Status: Check the box to display playback status (only for main monitor).

Screen Mode: Select the suitable screen mode. Selections are: 1920x1080; 1280x1024; 1024x768; 800x600 (only for main monitor). Please see to *6.2.1.1 Display Aspect Ratio* for more details.

POS OSD

Use Codepage: Select the suitable encoding type that matches with your POS system.

Text Insert: Check to display the text data from POS on the screen.

Clean Text Time_Second(s): Enter a time for the text to display on the monitor.

REC Text: Check to record the text data from POS.

Save: Click to save the settings.

6.6.2 M/T SEQ

You can configure up to 20 steps of the sequencing order for the Main monitor. The Sequence will repeat continuously from step 1 to step 20 until interrupted. Note that the DVR provides 2 call monitor outputs. The Call Monitor settings below can be applied to both of the 2 call monitors.

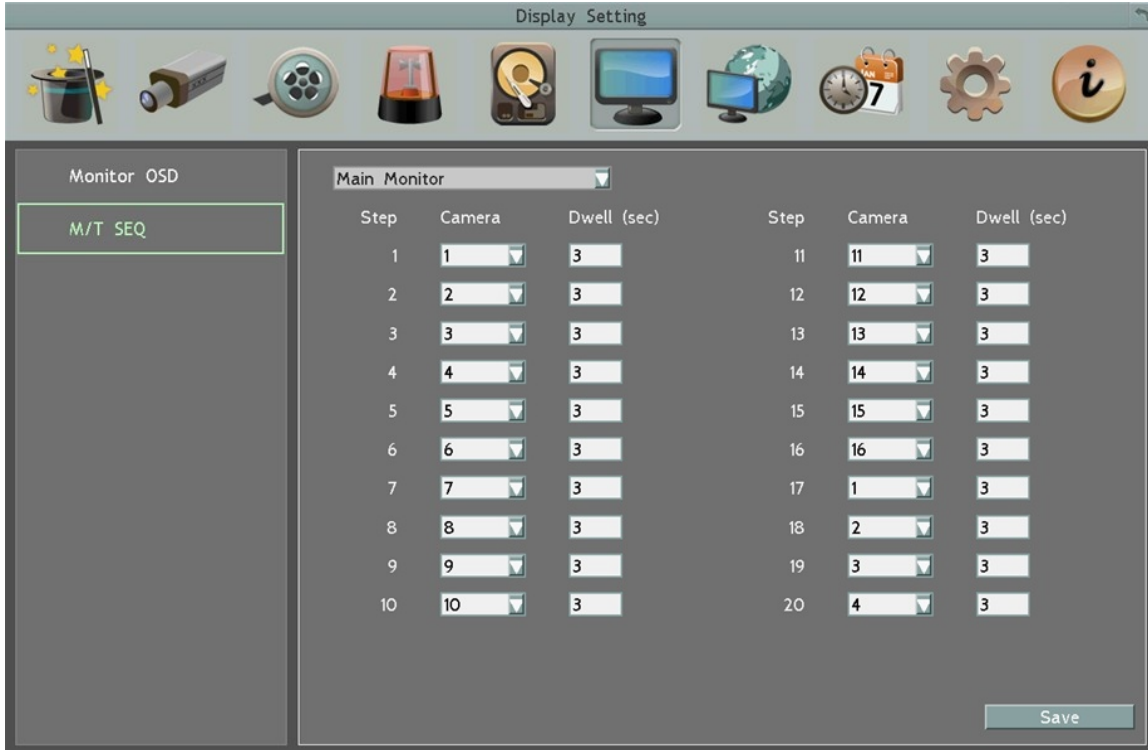

Step	Camera	Dwell (sec)	Step	Camera	Dwell (sec)
1	1	3	11	11	3
2	2	3	12	12	3
3	3	3	13	13	3
4	4	3	14	14	3
5	5	3	15	15	3
6	6	3	16	16	3
7	7	3	17	1	3
8	8	3	18	2	3
9	9	3	19	3	3
10	10	3	20	4	3

Main Monitor/ Call Monitor: Select Main or Call Monitor for the following settings.

Step: The sequencing order.

Camera: Select a camera for the specific step.

Dwell (sec): Sets up the dwell time between 0 and 60 seconds for each step.

Save: Click to save the settings.

6.7 Network Settings

The DVR allows you to use a Web browser to remotely view and manage the system. You can also receive live video streaming from the DVR using your smartphone.

Note: Since every Network Configuration is different, please check with your Network Administrator or ISP to see if your DVR should use specific IP addresses and/or port numbers.

6.7.1 LAN

According to your network environment, select **Static IP**, **DHCP** or **PPPoE** to configure an IP address to the DVR.



Network Type: Three options are selectable: **Static IP**, **DHCP** and **PPPoE**.

Static IP: User can set a fixed IP for network connection.

DHCP: DHCP server in LAN will automatically assign an IP configuration for the network connection.

PPPoE: For direct connection to the DSL only. Verify with your ISP if they use PPPoE.

IP address: Displays the DVR's current IP Address. A static IP address must be set manually. If DHCP is selected, this value will be assigned automatically.

Subnet Mask: Displays the subnet mask for your network so the DVR will be recognized within the network. If DHCP is selected, this value will be assigned automatically.

Gateway: Displays the gateway on your network for the DVR to use when communicating with any devices not on the local network. If DHCP is selected, this value will be assigned automatically.

DNS Server 1: Displays the primary DNS server for your network. If DHCP is selected and an internet connection is available, this value should be assigned automatically. This field must have a valid DNS address in order to use the DDNS feature (see 6.7.3 DDNS).

DNS Server 2: This field shows the secondary DNS server for your network.

HTTP Port: Port number for HTTP/WEB communication.

Bandwidth Limit (Kbps): Specify, disabled / 128 K / 256 K / 512 K / 768K / 1M / 3M bps. This is the maximum bandwidth that the DVR is allowed to use on the network. This is a useful function when connecting the DVR to busy or heavily loaded networks, or when accessing the DVR(s) over a WAN.

Network ID: The network ID is an identifier for the alarm transmitter (DVR sending the alarm). Type a network ID for network identification.

Save: Click to save the settings.

Additional information:

1. Set up the DVR Network Menu according to the instructions detailed in the Networking chapter of this DVR's manual.
 - a. If using DHCP, all settings will be detected automatically. While DHCP is a useful tool for determining the network settings, if you set up your DVR in this manner its IP address may change at different times for different reasons, particularly after a power failure. If the IP address of the DVR changes, you may have difficulties accessing your DVR locally and/or remotely. It is strongly recommended that you assign a fixed (static) IP address to your DVR, and that in order to avoid address conflicts the IP address assigned be outside of the DHCP range of addresses your router issues to DHCP clients. Please do not set the DHCP address issued to the DVR by the router as its static IP address unless you take specific steps that program your router to prevent such address conflicts.
 - b. If using a Fixed IP (recommended), you will need to input the information manually. In order for DDNS to work, you must enter valid data, compatible with your network, for all four of the network setting fields: IP address, subnet mask, default gateway and the DNS Address (depending on your network hardware and IP configuration this may be the IP address of your router/gateway, or it may be the actual IP address of the local DNS server). The DNS server IP is required because your DNS server provides critical information necessary for the DVR to communicate with the DDNS server.

You can obtain the actual DNS IP from your Internet Service Provider (ISP); or, from a PC located on the same LAN as the DVR, go to <http://www.dnsserverlist.org/> to obtain a list of the IP addresses of their recommendation of the best servers to use for your location.

2. If you are connecting through a router, make sure that you have 'opened up' all the required network ports in the port forwarding section of your router's setup options. That is, you have directed the router to send any incoming traffic using those IP ports to the LAN IP address of the DVR. Useful information about router port forwarding can be found at www.portforward.com. Different routers may use different terms for port forwarding function. For instance, D-Link calls it virtual server, Netopia calls it pinholes.

The default port for the DVR is: 80

Note: Port 80 is the default port used for Web browsing. Because of this, in order to prevent the average user from hosting a Web server, most ISPs BLOCK traffic using port 80 from reaching the average site. If you only plan to view your DVR on a LAN, you can use port 80, and don't have to concern yourself with DDNS or routers. However, if you desire **remote access** to your DVR, perhaps using DDNS (optional), you **MUST** select functional ports and set up the port forwarding in your router. Other ports, such as 8080 and 8000 are sometimes blocked by ISPs as well.

What port(s) should be used? There are 65,535 valid IP ports to choose from. These are broken down into three groups:

- Well Known Ports 0 thru 1023
- Registered Ports 1024 thru 49151
- Dynamic and/or Private Ports 49152 thru 65535

So, rather than encounter a port conflict by choosing a port commonly used for another purpose (like port 25 for SMTP mail or port 448 for secure sockets), choose an 'unusual' port number. For example, add 50,000 to your house number: 50,123 is less likely to lead to a port conflict. For a list of the known and registered ports, see <http://www.iana.org/assignments/port-numbers>

6.7.2 Email

You can configure the Email settings for DVR to send Email alert when an event occurs.



The screenshot shows the 'Network' configuration page with the 'Email' tab selected. The configuration fields are as follows:

- SMTP Server: smtp.gmail.com
- SMTP Port: 25
- Authentication:
- SSL:
- User Name: [Empty field]
- Password: [Empty field]
- Confirm: [Empty field]
- Sender Email: [Empty field]
- Receiver Email 1: [Empty field]
- Receiver Email 2: [Empty field]
- Receiver Email 3: [Empty field]
- Email Subject: [Empty field]

Buttons at the bottom right: 'E-Mail test' and 'Save'. A 'Pass' message is visible above the buttons.

SMTP Server: Assign the SMTP (e-mail) server's name. Note that for more reliable email service, use the server's IP address.

SMTP Port: Assign the port number used by the SMTP server.

Authentication: Check this box if the SMTP server requires authentication (user name / password).

SSL: Check the box if mail server needs communication to be encrypted by SSL.

User Name: Input the login user name if the SMTP server requires authentication.

Password: Input the password if the SMTP server requires authentication.

Confirm: Input the password again to confirm the password.

Sender Email: Input the e-mail address of the sender (the DVR). Sender's e-mail address has to match the user name and password above.

Receiver Email 1: Input the first e-mail address that event messages are sent to.

Receiver Email 2: Input the second e-mail address that event messages are sent to.

Receiver Email 3: Input the third e-mail address that event messages are sent to.

Email Subject: Input email subject.

E-Mail test: You can click the button to test the email function. If the function works fine, a Pass message will be displayed; otherwise, a Fail message will be displayed.

Save: Click to save the settings.

6.7.3 DDNS

DDNS (Dynamic Domain Name System) is a service used to map a domain name to the dynamic IP address of a network device. You can set up the DDNS service for remote access to the DVR.



DDNS assigns a domain name (URL) to the DVR, so that the user does not need to go through the trouble of checking if the IP address assigned by DHCP Server has changed. Once the IP is changed, the DVR will automatically update the information to the DDNS to ensure it is always available for remote access.

Before enabling the following DDNS function, user should have applied for a host name from the DDS service provider's website. We support four DDNS server providers: **www.everfocusddns.com** and **www.dyndns.com**.

Note: We highly recommend that you use **xxx.everfocusddns.com** for the simplicity of setting up your DVR.

6.7.3.1 EverFocus DDNS

Note that the **DNS Server 1 (6.7.1 LAN)** should be set up correctly or the DDNS will not work.



DDNS Service: Select **EverfocusDDNS** from the drop-down list.

DVR Name: Input the desired name for the DVR, and you can enter up to 32 letters. If the length of the name exceeds the text field size on the OSD, you can move your cursor onto the text field to display the entire name on the OSD.

Note that the name of the DVR cannot include a space, underline or any special characters particularly `_ ~ ! @ # $ % ^ & * () + < > " ; : . ,`

Save: Click to save the settings.

Note:

1. It is not necessary to append the HTTP port number to the DDNS name. The EverFocus DDNS server not only keeps track of your DVR's IP address, but also keeps track of the ports.
2. You can go to <http://www.everfocusddns.com> to check the DDNS name can be registered or not.

To set up DDNS function:

1. In order to allow remote access to the DVR from outside of the local network, enable either the **Port Forwarding** or **DMZ** function of your router. Please refer to the manual of your router for more details.

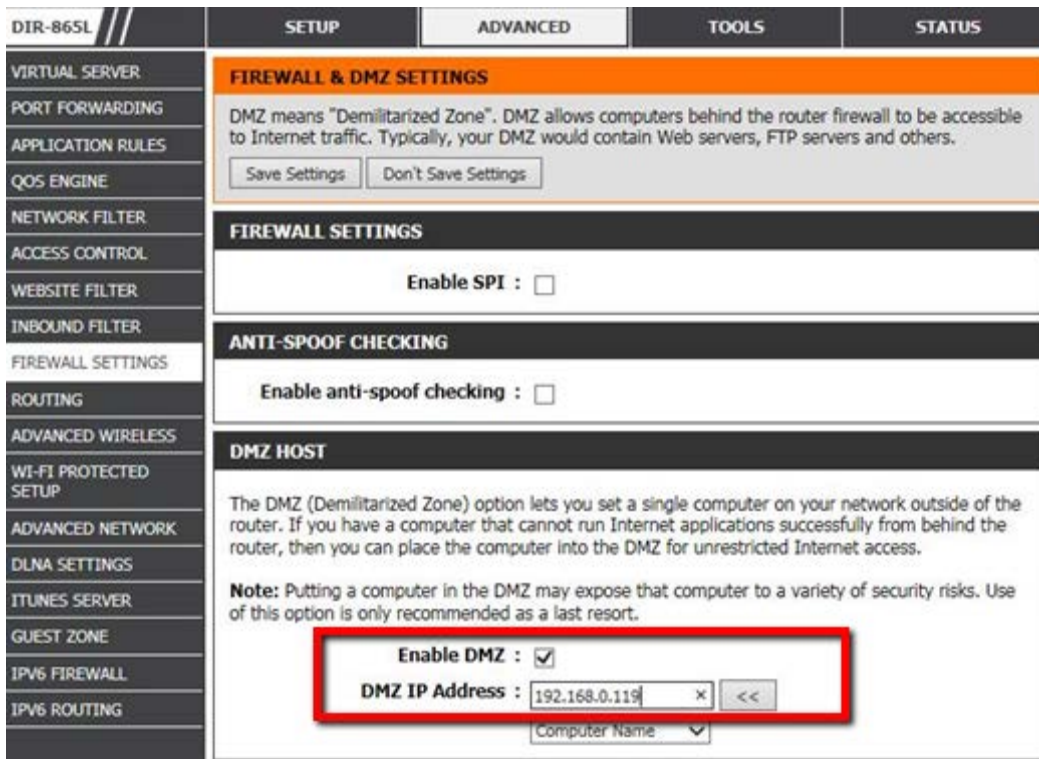

- On the Network Setting page of DVR (Network > LAN), configure the LAN settings, keep HTTP port “80” and then click the **Save** button.

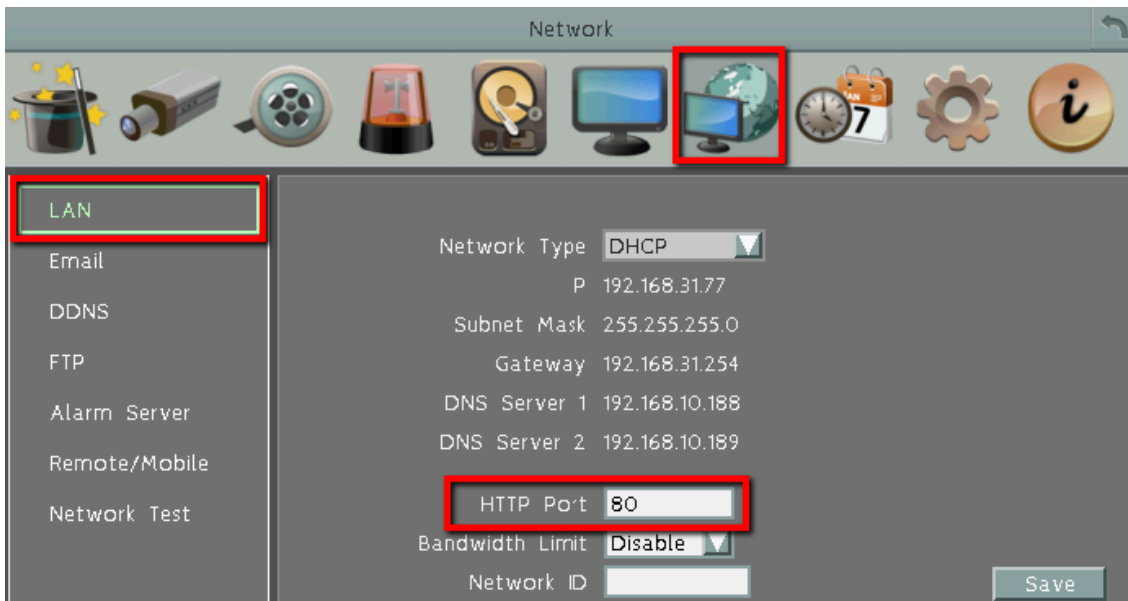

- If **Static IP** is selected: Enter the IP address, subnet mask, default gateway and the DNS Server 1. Please consult with your ISP service provider for the information of subnet mask, default gateway and the DNS Server 1.
- If **DHCP** is selected: The IP address, subnet mask, default gateway and the DNS Server 1 will be assigned automatically by DHCP server.
- If **PPPoE** is selected: Enter the User Name (e.g. xxxx@hinet.net) and Password provided by your ISP service provider.

- On the DDNS setting page, register a free host name from EverFocus DDNS and then click the **Save** button.



- Select **EverfocusDDNS** from the DDNS Service drop-down list.
- Enter a desired host name in the DVR Name field. If the host name is available, a “Success” window will appear. Click **OK**. If not, try another host name until the “Success” window appears.

Note: The host name should not include a space, underline or any special characters particularly _ ~ ! @ # \$ % ^ & * () + < > " ; : . ,

c. Click **Save**.

- The DDNS setup is now complete. Open a browser and enter the domain name ([http://\[host name\].everfocusddns.com](http://[host name].everfocusddns.com)) in the address field. The Web interface of the MDVR should be displayed.

For example, if you've obtained the host name "HQtest" from EverFocus DDNS server, enter <http://HQtest.everfocusddns.com> in the address field of the browser.

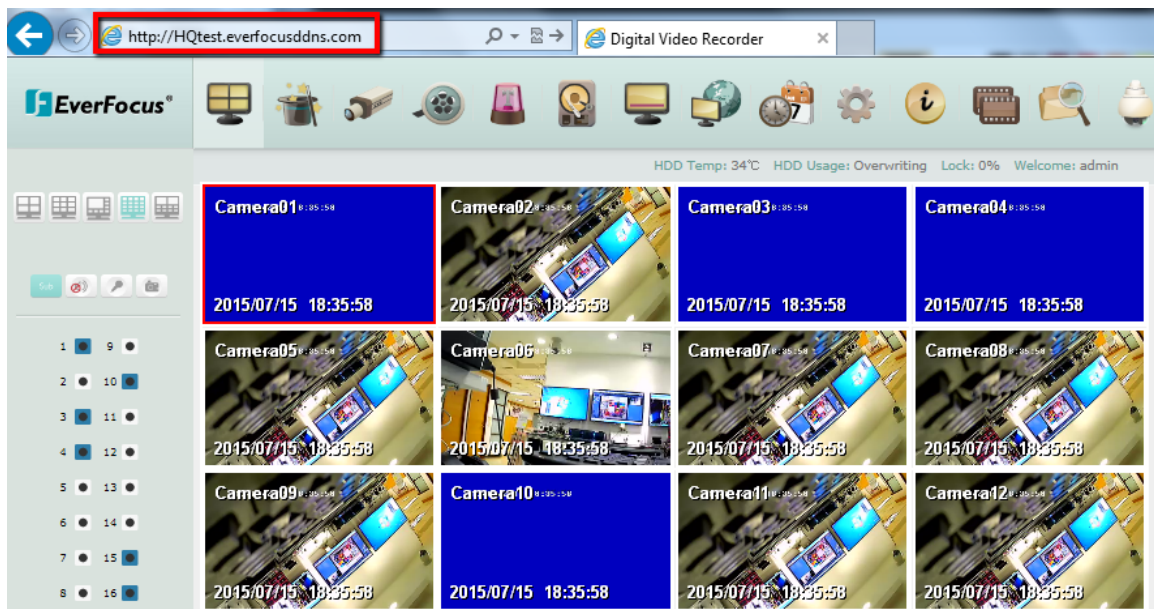

6.7.3.2 www.dyndns.org



DDNS Service: Select www.dyndns.org from the drop-down list.

Host name: Host name created through the dyndns account.

User name: User name of the dyndns account.

Password: Password of the dyndns account.

Confirm: Input the password again to confirm.

Save: Click to save the settings.

Setup Steps:

1. Apply for a host name from www.dyndns.org.
2. Make sure that the DNS Server 1 is set up correctly (see DNS Server 1 in 6.7.1 LAN) or the DDNS will not work.
3. Select www.dyndns.org from the DDNS Service drop-down list.
4. Enter the host name in the Host Name field. Note that the name of the DVR cannot include a space, underline or any special characters particularly `_ ~ ! @ # $ % ^ & * () + < > " ; : , , _`
5. Enter the User Name / Password of the dyndns account.
6. The setting is complete. And you should now be able to remotely connect the DVR by typing the name you created into the address bar. Example: `http://hostname.dyndns.com`

Note: If you are connecting through a router, make sure that you have opened up all the required network ports in the “Port Forwarding” section of your router’s setup options. The default port of the DVR is 80. To set up Port Forwarding, please consult the manual of the router.

6.7.4 FTP

Set up the FTP server settings to enable the FTP function. The function is for users to upload the alarm / motion recordings or snapshots from sub stream to the FTP server. You can choose to upload either the recordings or snapshots, please see [6.4.1 Alarm](#) and [6.4.3 Motion](#).



The screenshot shows the 'Network' settings window. The 'FTP' option is selected in the left sidebar. The main configuration area contains the following fields:

- FTP Server: 0.0.0.0
- Port: 21
- User Name: [Empty field]
- Password: [Empty field]
- Confirm: [Empty field]
- File Name: [Empty field]

A 'Save' button is located at the bottom right of the configuration area.

FTP Server: Enter the IP address or the host name of the FTP server.

Port: Enter the port number for the FTP server. Default is 21.

User Name: Set FTP User's name.

Password: Set FTP password.

Confirm: Input the FTP password again to confirm.

File Name: Enter the file name.

Save: Click to save the settings.

Note: If you want to upload recordings to the FTP, please go to the Remote / Mobile setting page to select H.264 codec.

6.7.5 Alarm Server

You can send out the alarm notifications to EverFocus’s CMS software. Please also consult the CMS’s user manual for network alarm settings.



Server IP1~3: IP address of client PC. The network alarm can be transmitted to up to 3 addresses.

Protocol: Select the protocol type for alarm transmission. Note the protocol selected here should match the protocol set up for the CMS alarm server.

UDP: User Datagram Protocol.

TCP: Transmission Control Protocol.

Port: Select the transmission port for network alarm messages. The port setup here should match the port set up for the CMS alarm server.

Save: Click to save the settings.

6.7.6 Remote / Mobile

You can configure the compression format for the sub-stream for mobile phone access. Select **H.264** or **MJPEG** codec to enable the mobile phone access function. Note that if you also want to use the FTP function for uploading the recordings (MP4 video format), please select the H.264 codec.



H.264: The H.264 codec is compatible with iOS and Android MobileFocus applications and IE Web browser viewing on iPhone, iPod touch, iPad, Android, and BlackBerry.

MJPEG: The MJPEG codec is compatible with iOS and Android MobileFocus applications and IE Web browser viewing on iPhone, iPod touch, iPad, Android, and BlackBerry.

Save: Click to save the settings.

6.7.7 Network Test

The Ping utility is useful in diagnosing connectivity problems by obtaining responses from nodes progressively farther along the network. DNS functionality can also be confirmed by entering a valid DNS name instead of an IP address.



To verify basic network connectivity between the DVR and other LAN or WAN nodes, click the **Ping** button.

6.8 Schedule Setting

You can set up the recording schedule with the desired time, event types or FPS.

6.8.1 Express Setup

You can set up a weekly recording schedule for the DVR to automatically record videos.



	Record Type	Normal	Event	Action
Weekend	Normal+Event	30 fps	1 fps	<input checked="" type="checkbox"/>
Weekday Daytime	Event Only	30 fps	1 fps	<input type="checkbox"/>
Weekday Nighttime	Normal+Event	30 fps	1 fps	<input checked="" type="checkbox"/>
Holidays	Normal+Event	30 fps	1 fps	<input checked="" type="checkbox"/>
Others	Normal+Event	30 fps	1 fps	<input checked="" type="checkbox"/>

Weekend Start: Select a start date and time for the weekend.

Weekend End: Select an end date and time for the weekend.

Daytime Start: Select a weekday start time (Nighttime schedule ends when Daytime begins).

Daytime End: Select a weekday end time (Nighttime schedule ends when Daytime ends).

Record Type: Select a recording type for each time period.

Disable: No recording during the scheduled time period.

Normal+Event: Continuous and Event recordings.

Event Only: Event recordings only.

Normal: Select a frame rate per second (FPS) for the Continuous Recording.

Event: Select a frame rate per second (FPS) for the Event Recording.

Action: Check the box to enable the Buzzer, Alarm Out, E-mail and Network actions selected in 6.4 Event when an event occurs during the selected time period.

Note: For **Holiday** and **Others**, you can set up the recording schedule in 6.8.2 Holidays.

Save: Click to save the settings.

6.8.2 Holidays

In addition to set up a weekly recording schedule, you can also set up a holiday recording schedule to automatically record videos on a specific day of the year.



Date Type: Select **Holiday** or **Others** if you have configured the settings in *6.8.1 Express Setup*. The Holiday and Others are two different groups designed for you to assign special days independently.

Recurrent Type: Select a date layout for the selected group above.

Disabled: Select to disable the Holiday / Others recording schedule.

One time: Select this option and then set up the specific date and year in the Details field. The DVR will start recording on this specific date.

Month/date: Select this option and then set up the specific date in the Details field. The DVR will start recording on this date yearly.

Month/Weekday: Select this option and then set up the specific date in the Details field. The DVR will start recording on this specific date.

Details: Click to specify the date for the selected group above.

Previous: Previous Page (30 Holidays Total)

Next: Next Page (30 Holidays Total)

Save: Click to save the settings.

6.8.3 Schedule

You can set up the camera recording mode by time of day on specific days of the week and/or holidays and other days. Please note that after the configuration, you have to check the **Schedule Record** box in the Record setting page to enable the schedule recording mode.



Camera: Select a camera number to change the schedule for the selected camera. Each camera can be controlled during a 24-hour time block for Holiday (Hol), Other (Oth), Sunday (Sun), Monday (Mon), Tuesday (Tue), Wednesday (Wed), Thursday (Thu), Friday (Fri), or Saturday (Sat).

Time (0~23): The numbers represent the 24 hours of a day.

Time Bar: The time bar uses three different colors to distinguish each recording mode.

Gray (No Rec): No recording during this time block.

Pink (E): Only events are recorded during this time block.

Blue-green (N+E): (Default) Normal and event recording during this time block.

There are 48 blocks on the time bar, and each block represents half hour respectively. When moving the cursor onto the time bar, the exact time will appear at the right side of the time bar (shown as the above figure).

Schedule setting using Mouse

1. Select a camera first and click on desired start time block (no number on it) on a time bar. At this time, the selected time block will be highlighted with a yellow frame and the entire time bar will be highlighted with a red frame.
2. Click the desired start time block again to confirm, and this block (shows a new sequence number on it) and all the following blocks will turn to gray. This means the grey time blocks has been set to No Recording mode.
3. To change the time blocks to different record mode (which shows a different color), users need to click again on the block (with number on it) of any section. Every time the user clicks the first block of a section, the color switches from gray->pink ->blue-green.
4. Repeat the above steps to configure the record modes. You can configure up to six record modes on each time bar.

Click the **“Edit Timezone”** button to edit the recording parameters for a time zone.

Editing:		Wednesday				
From	To	Record	Resolution	Normal	Event	Action
0:00	6:00	Normal+Event	960x480	30 fps	1 fps	<input checked="" type="checkbox"/>
6:00	18:00	Event Only	960x480	30 fps	1 fps	<input type="checkbox"/>
18:00	21:00	Normal+Event	960x480	30 fps	1 fps	<input checked="" type="checkbox"/>
21:00	24:00	No Record				

Apply Close

Editing Timezone:

From: Displays time zone start time.

To: Displays time zone end time.

Record: Displays Record mode.

Resolution: Recording resolution is displayed.

Normal: Frame rate in FPS for continuous recording. It is important to keep track of the normal recording resources being allocated at each hours of the day. Increasing the Normal recording resolution and/or rate can inadvertently request more recording resources than the DVR is capable of delivering, or allocate so much of the DVRs resources that there is no excess available for increased FPS rate and/or resolution in response to an Event.

The speed is limited by the maximum total recording capacity of the DVR as allocated across TV standard in global setting, all the installed cameras.

Since EverFocus DVRs have the capability to change the FPS rate in response to events, it may be advisable to reserve some recording capacity for event response.

Event: Maximum desired frame rate in frames per second (FPS) for event recording; if more than one camera requires simultaneous event recording, the total for all cameras cannot exceed the maximum available FPS for the DVR at the corresponding resolution setting, and *the available FPS may be divided across the cameras responding to an event.*

Action: Check this box to enable notifications enabled elsewhere (Buzzer, Alarm out, E-mail, and Network Alarm) when an event occurs.

Apply to Days: This button can be used to copy schedules to other days. Select which days you wish to copy to. "Select All" selects all days, "Clear All" deselects all days. Click "OK" to copy the settings or "Cancel" to exit without copying.

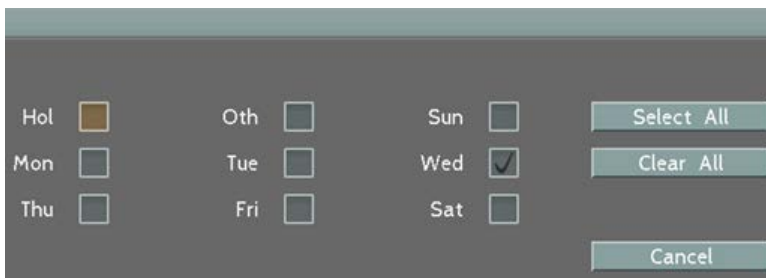

Hol	<input checked="" type="checkbox"/>	Oth	<input type="checkbox"/>	Sun	<input type="checkbox"/>	Select All
Mon	<input type="checkbox"/>	Tue	<input type="checkbox"/>	Wed	<input checked="" type="checkbox"/>	Clear All
Thu	<input type="checkbox"/>	Fri	<input type="checkbox"/>	Sat	<input type="checkbox"/>	Cancel

Apply to Cameras: This button can be used to copy schedules to other cameras. Select which cameras you wish to copy to. "Select All" selects all cameras, "Clear All" deselects all cameras. Click "OK" to copy the settings or "Cancel" to exit without copying.

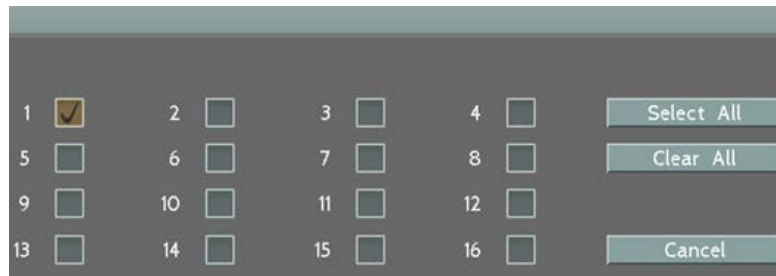

1	<input checked="" type="checkbox"/>	2	<input type="checkbox"/>	3	<input type="checkbox"/>	4	<input type="checkbox"/>	Select All
5	<input type="checkbox"/>	6	<input type="checkbox"/>	7	<input type="checkbox"/>	8	<input type="checkbox"/>	Clear All
9	<input type="checkbox"/>	10	<input type="checkbox"/>	11	<input type="checkbox"/>	12	<input type="checkbox"/>	Cancel
13	<input type="checkbox"/>	14	<input type="checkbox"/>	15	<input type="checkbox"/>	16	<input type="checkbox"/>	

Save: Click to save the settings.

6.9 System Setting

You can configure the general settings for the DVR in this menu.

6.9.1 Date / Time

You can set up the date and time for the DVR.

Note: Clicking **Save** on this page will disable the **Daylight Saving** function if this function has been enabled and a notice message will pop up as “Please enable the Daylight Saving Time again if the function is needed”. Therefore, after setting up the time on this page, you need to go to *Daylight Saving* page to reset and enable the daylight saving time if the function is needed. Please refer to *6.9.2 Daylight Saving* for detailed information.

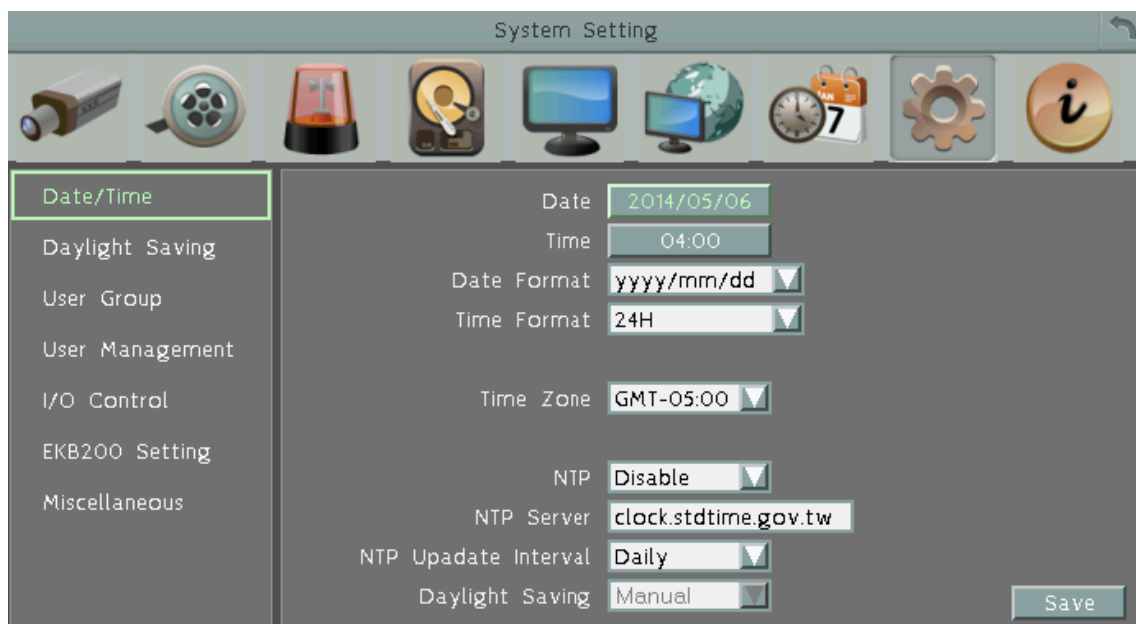

Date: Click to bring up the on-screen keyboard to set up the date.

Time: Click to bring up the on-screen clock to set up the time.

Date Format: Select a date format from the drop-down list.

Time Format: Select a time format from the drop-down list.

Time Zone: Select a time zone for the DVR to adjust to when updating from the time server.

NTP: Select Disable / Enable for NTP time synchronization.

NTP Server: Displays the time server address that the DVR uses for time synchronization. Requires operating network configuration and WAN or LAN access to a compatible NTP server. The default NTP address is the NTP server in Taiwan. To find a compatible NTP address of the DVR's physical location, follow the steps below:

- a. Use a computer connected to the Network.
- b. Click Start > Run > type “command” and then click OK.
- c. In the DOS Prompt, type “ping pool.ntp.org” to find out the IP address of an NTP Server.

NTP Update Interval: The frequency that the system automatically updates the time via the NTP server. Select Hourly, Daily, Weekly or Monthly.

Daylight Saving: This **Auto** daylight saving function is used for the system to automatically set up the daylight saving time but it is currently reserved for the users in the United States. So, if you want to set up the daylight saving time, please go to Daylight Saving setting page to manually set up the time (refer to *6.9.2 Daylight Saving*).

For the users in United States, if they want to use the **Auto** daylight saving functions, please follow the steps below:

1. Select a U.S Time zone (GMT -05:00 ~ GMT -08:00).
2. Enable the **NTP**.
3. Enter a NTP server IP address in United States.
4. Select **Auto** in the **Daylight Saving** drop-down list.
5. Click **Save** to save the settings.
6. The Daylight Saving setting page (refer to *6.9.2 Daylight Saving*) will be grayed out and automatically set to the correct daylight saving time.

Save: Click to save the settings.

6.9.2 Daylight Saving

You can configure the settings for DVR to automatically adjust to daylight saving time.

Note:

1. If this page is grayed out, it means that you have enabled the **Auto** daylight saving function, please refer to *6.9.1 Date/Time*.
2. If you need to use the **Daylight Saving** function, you must set up the **Date / Time** first in Date/Time setting page.



The screenshot shows the 'System Setting' window with the 'Daylight Saving' option selected in the sidebar. The main content area includes a 'Daylight Saving' checkbox that is checked. Below it are fields for 'Start Date' (Jan 1st Sunday), 'Start Time (hh:mm)' (0:00), 'Set To (hh:mm)' (0:00), 'End Date' (Jan 1st Sunday), and 'End Time (hh:mm)' (0:00). A 'Save' button is located at the bottom right of the settings area.

Daylight Saving: Check the box to enable automatic daylight saving time (DST).

Start Date: Set the start date for daylight saving time.

Start Time (hh:mm): Set the time when daylight saving time begins.

Set To (hh:mm): This is what the time will change to when daylight saving begins. For most regions, this will be one hour ahead of the “Start Time”.

End Date: Set the end date for daylight saving time.

End Time (hh:mm): Set the time when daylight saving time ends.

The time change difference on the End Date will be the same as the difference between the Start Time and End Time entered for the Start Date (typically 1 hour as in the example shown).

Save: Click to save the settings.

6.9.3 User Group

This setting page is used for configuring the privilege of the three access levels: Administrator, Manager and Operator. Check the boxes under an access level to enable the privileges of that access level. For example, if you check the **Clear Log** box under the Operator access level, only the Operator has the privilege to clear log.



Manage User at Own Level: Check this box for the user of an access level to be able to configure other users' settings of the same level at the User Management setting page (see 6.9.4 User Management). For example, if this box under the Operator level has been checked, any user with the Operator privilege can go to the User Management setting page to set up the settings of other Operators.

User Management: Check this box under an access level to enable the users of that level to access the User Management and User Group setting page.

Previous: Click to return to the previous page.

Next: Click to enter the next page.

Save: Click to save the settings.

Important Notes for Account Privilege Definition

Users with the Administrator account have full privileges, so the checkboxes under the Administrator access level will always be grayed out. The Administrator can grant privileges to both the Manager and Operator while the Manager and Operator can also give certain privileges to the lower level accounts based on the following rules.

- **Account Viewing:**

Administrator: The Administrator account has the privilege to view all the user accounts.

Manager: The Manager account can only view its own and the Operator accounts.

Operator: The Operator account can only view its own account.

- **Camera Access:**

Administrator: The Administrator account has the privilege to set up Camera Access right to all the user accounts.

Manager: The Manager account can set up Camera Access right (cameras enabled by the Administrator account) to itself and Operator accounts.

Operator: The Operator account can only set up its own Camera Access right.

- **Change Password:**

Administrator: The Administrator account has the privilege to change password to all the user accounts.

Manager: The Manager account can change password to itself and Operator accounts.

Operator: The Operator account can only change its own password.

- **Edit User Rights:**

Administrator: The Administrator account has the privilege to edit user rights to all the user accounts.

Manager: The Manager account can only edit user rights to Operator accounts.

Operator: The Operator account cannot edit user rights to any accounts.

6.9.4 User Management

You can create multiple user accounts (max: 20 user accounts) with different privileges. The DVR has default user accounts which you can choose to copy, edit, add or delete, and the default password is 11111111.



Copy: Click the  button to copy the settings of an existing user account to a new user account.

Edit: Click the  button to edit the settings of an existing user account.

Add: Click the  button to add a new user.

Delete: Click the  button to delete

Login: Check the box to enable the User Login function after logging out the DVR. For details on logging in the DVR, please refer to 3.3.1 *Login*.

Auto User Log Off: Check the box to automatically logoff the DVR after 3 minutes of inactivity.

Password renewal: The password will expire after the specified days. When it's expired, a password renewal reminder will show up as below for you to change your password. If you don't want to renew the password periodically, just enter "0".



The password for admin account is expired. Please change your password.

Old Password:

New Password:

Confirm New Password:

Old password is wrong.

Previous: Click to return to the previous page.

Next: Click to enter the next page.

Save: Click to apply all the settings.

You can further configure each user account and its settings individually, see the steps below:

1. Click on a user account.
2. Click the **Add**, **Copy** or **Edit** button, and the following page appears.

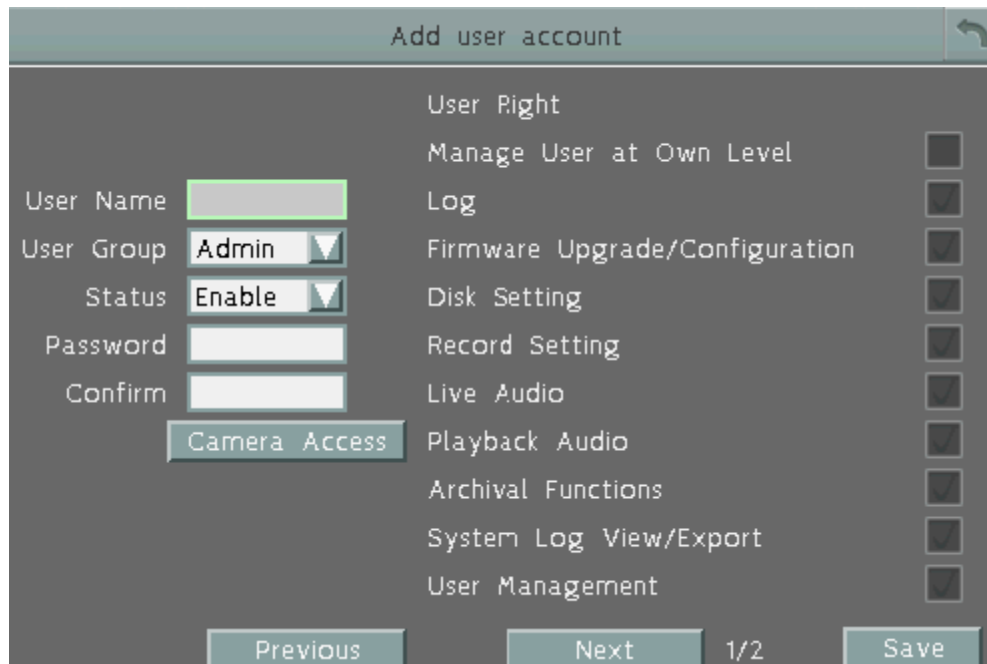

Add user account

User Name:

User Group:

Status:

Password:

Confirm:

User Right

Manage User at Own Level

Log

Firmware Upgrade/Configuration

Disk Setting

Record Setting

Live Audio

Playback Audio

Archival Functions

System Log View/Export

User Management

1/2

User Name: Click to bring up the keyboard and input the desired user name.

User Group: Select a user group (access level).

Status: Select to enable or disable the user account.

Password: Input the password.

Confirm: Enter the same password again to confirm.

Camera Access: Click to bring up a new setting page, and check the boxes to enable the live, playback or PTZ functions of the cameras for local or remote access.

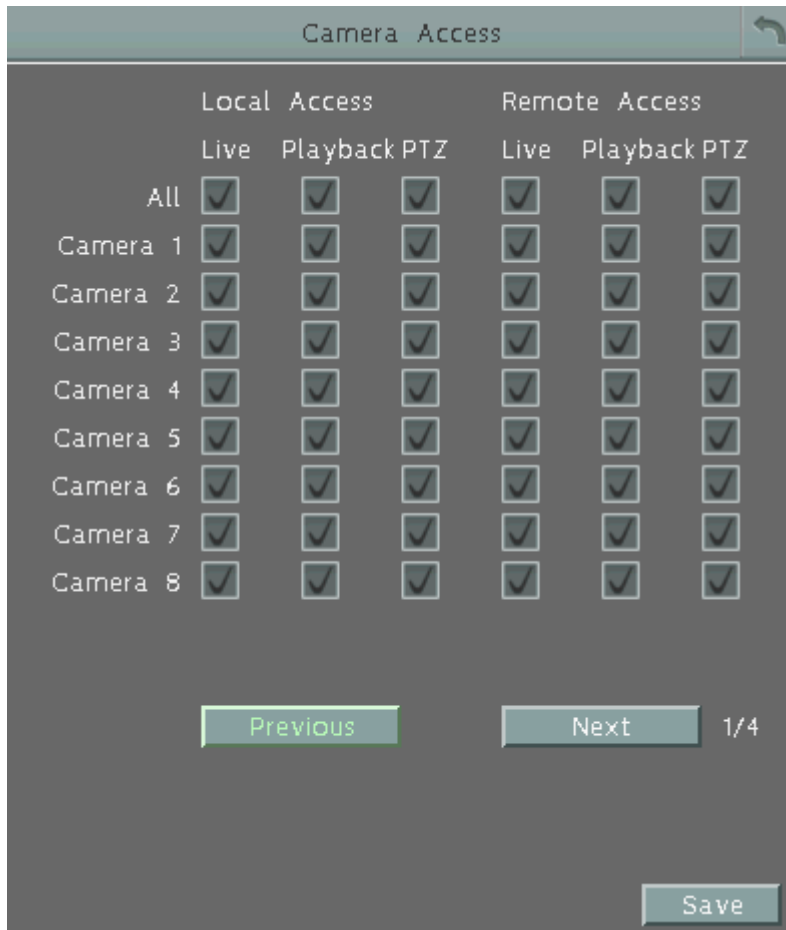

	Local Access			Remote Access		
	Live	Playback	PTZ	Live	Playback	PTZ
All	<input checked="" type="checkbox"/>	<input checked="" type="checkbox"/>	<input checked="" type="checkbox"/>	<input checked="" type="checkbox"/>	<input checked="" type="checkbox"/>	<input checked="" type="checkbox"/>
Camera 1	<input checked="" type="checkbox"/>	<input checked="" type="checkbox"/>	<input checked="" type="checkbox"/>	<input checked="" type="checkbox"/>	<input checked="" type="checkbox"/>	<input checked="" type="checkbox"/>
Camera 2	<input checked="" type="checkbox"/>	<input checked="" type="checkbox"/>	<input checked="" type="checkbox"/>	<input checked="" type="checkbox"/>	<input checked="" type="checkbox"/>	<input checked="" type="checkbox"/>
Camera 3	<input checked="" type="checkbox"/>	<input checked="" type="checkbox"/>	<input checked="" type="checkbox"/>	<input checked="" type="checkbox"/>	<input checked="" type="checkbox"/>	<input checked="" type="checkbox"/>
Camera 4	<input checked="" type="checkbox"/>	<input checked="" type="checkbox"/>	<input checked="" type="checkbox"/>	<input checked="" type="checkbox"/>	<input checked="" type="checkbox"/>	<input checked="" type="checkbox"/>
Camera 5	<input checked="" type="checkbox"/>	<input checked="" type="checkbox"/>	<input checked="" type="checkbox"/>	<input checked="" type="checkbox"/>	<input checked="" type="checkbox"/>	<input checked="" type="checkbox"/>
Camera 6	<input checked="" type="checkbox"/>	<input checked="" type="checkbox"/>	<input checked="" type="checkbox"/>	<input checked="" type="checkbox"/>	<input checked="" type="checkbox"/>	<input checked="" type="checkbox"/>
Camera 7	<input checked="" type="checkbox"/>	<input checked="" type="checkbox"/>	<input checked="" type="checkbox"/>	<input checked="" type="checkbox"/>	<input checked="" type="checkbox"/>	<input checked="" type="checkbox"/>
Camera 8	<input checked="" type="checkbox"/>	<input checked="" type="checkbox"/>	<input checked="" type="checkbox"/>	<input checked="" type="checkbox"/>	<input checked="" type="checkbox"/>	<input checked="" type="checkbox"/>

Previous Next 1/4

Save

User Right: Check the boxes to enable the functions for the user account.

Previous: Click to return to the previous page.

Next: Click to enter the next page.

Save: Click to save the settings.

6.9.5 I/O Control

The I/O Control setup menu is used to define the settings for controlling the DVR through RS-485 communication protocol and for DVR to control the connected PTZ cameras.



PTZ Protocol: Select PTZ protocol, choose from the following protocols: Transparent, Pelco_D, Pelco_P, Everfocus or Samsung. (Note: All cameras on the RS-485 bus must use the same protocol)

485 ID: This is the ID used by the EKB500 to send commands to the DVR. On an RS-485 connection, every device (PTZ, DVR and controller) must be assigned an unique ID number between 0 and 127.

Baud Rate: This field is to set the speed at which is used to transmit instruction or information through the RS-485 port on the DVR. There are eight different speeds: 1200 BPS, 2400 BPS, 4800 BPS, 9600 BPS, 19200 BPS, 38400 BPS, 57600 BPS and 115200 BPS.

Data Bit: This field is the data bit at which you will be transferring. There are two settings for this option: 8 or 7.

Stop Bit: This field is to set the stop bit for the RS232 connection. There are two different stop bits, 1 or 2.

Parity: This field is to select the parity level at which you will be connected. You can choose between None, Odd, or Even parity levels.

Control: One remote control can be used to operate four DVRs. The DVR to be addressed is selected by pressing the key corresponding to its ID number on the IR Remote control. Please refer to *Appendix E: IR Remote Control*.

Type: Select **Text Insert** for using POS system; select **Control** for using EKB500 keyboard and PTZ camera.

IR Controller ID: Set up an ID for the DVR and allow the IR remote control to control this DVR.

Save: Click to save the settings.

6.9.6 EKB200 Setting

You can connect an EKB200, which is EverFocus' USB keyboard, to the USB port on the DVR to control the Iris, focus or the pre-configured PTZ control functions of the connected cameras. For details on how to configure the PTZ control functions, including Preset Position, Auto Pan, Tour and Pattern, please refer to 4.1 PTZ.



The control keys on the EKB200



After connecting the EKB200 keyboard to the DVR and configuring the PTZ control functions, you need to configure the above setup page to define the function for each control key on the keyboard. Click the **Save** button to save the settings. Once you press the control key on the keyboard, the camera will do the action which you've defined for the key.

【Key No】 The control key number on the keyboard.

【Action】 Select an item from the drop-down list to define the function for each key on the keyboard.

- **Set Preset:** You can use the joystick on the keyboard to select a position and then press this key to save the position as the Preset Position.
- **Go to Preset:** Press this key to let the camera go to the Preset Position number specified in the Value column.
- **Go to Home:** Press this key and the camera will go to the Preset Position 1.
- **Clear Preset:** Press this key to clear the Preset Position number specified in the Value column.
- **Run Auto Pan:** Press this key to start the AutoPan number specified in the Value column.
- **Stop Auto Pan:** Press this key to stop the AutoPan number specified in the Value column.
- **Tour Run:** Press this key to start running the Tour number specified in the Value column.
- **Tour Stop:** Press this key to stop running the Tour number specified in the Value column.
- **Pattern Run:** Press this key to start running the Pattern number specified in the Value column.
- **Pattern Stop:** Press this key to stop running the Pattern number specified in the Value column.
- **Select Tracking Object:** Press the key to display the tracking crosshairs on the screen. Use the joystick on the keyboard to select the desired tracking object and press this key again to save the selection.
- **Toggle Full Screen:** Press this key to toggle between the full screen and current screen.

【Value】 Type in the number for the selected Action item. For example, selecting **Go to Preset** from the Action drop-down list and typing in 2 in the Value column represents the Preset Position 2.

Previous: Click to return to the previous page.

Next: Click to enter the next page.

Save: Click to save the settings.

To activate the EKB200 keyboard on the PTZ Live View window, click the PTZ  icon on the OSD Root Menu, and then you are able to control the PTZ camera over the EKB200 keyboard (please refer to *4.1 PTZ*).

6.9.7 Miscellaneous

You can upgrade the latest firmware, restore the factory default settings to the DVR, upload / save the DVR configuration settings from / to the USB or change the language in this setup menu.

Note: Whether you want to the USB memory stick to upgrade firmware or to save/load configurations, it's recommended to connect it to the USB port on the **REAR** panel of the DVR.



Firmware

Current Firmware Version: Shows the current firmware version of the DVR.

Upgrade: Click to upgrade the latest firmware. Note you will need to restore the firmware file to the USB memory stick and then please connect the USB memory stick to the USB port on the **REAR** panel of the DVR.

Configurations

Load Factory Default: Click to restore the DVR to factory default settings. The User Account, Network IP Settings, and Time settings will not be affected.

Load From USB: Click to upload the DVR configurations restored in the USB flash device.

Save To USB: Click to save the DVR configurations to the USB flash device.

Language: Choose which language the DVR uses.

Allowed Remote Reboot: Check the box to enable restarting the DVR via the Network.

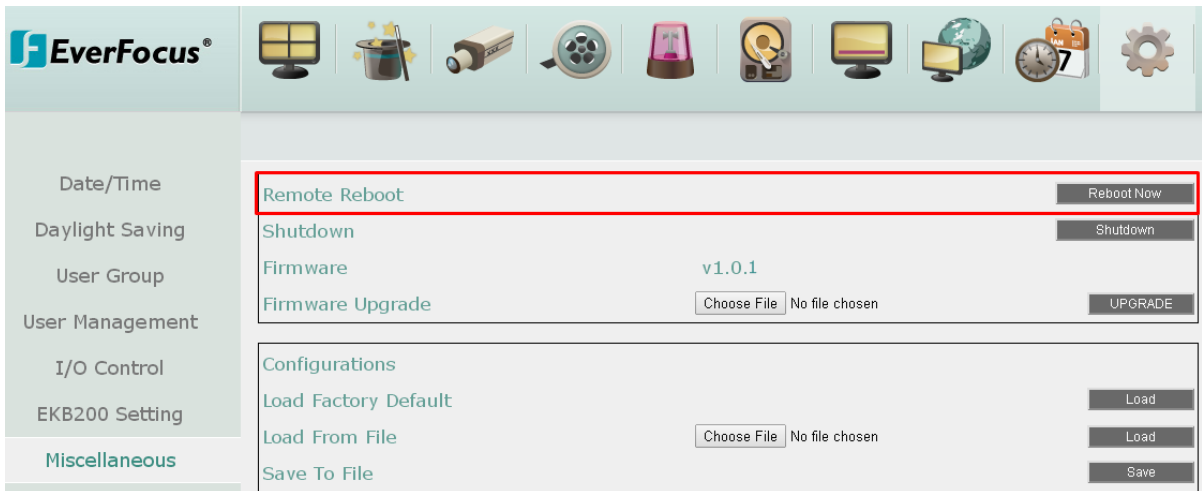

Shutdown: Press the **Shutdown** button if you need to turn off the DVR. When the message as below pops up on the screen, you can now turn off the DVR.



Save: Click to save the settings.

6.10 Information

You can see the DVR information and Log data in this menu. Or export the log data to the USB storage device.

6.10.1 System

In the System Menu, you can only see the information of the DVR, Network or HDD. No configuration can be done in this menu.



【System】

Version: Displays the firmware version.

Model: Displays the model name of the DVR.

NTSC / PAL: Displays the current video format automatically detected by the DVR.

S/N: Display the serial number of the DVR.

【Lan】

IP 1: Displays the IP address of LAN 1 set up in the Network or Express menu.

MAC 1: Displays the MAC address of LAN 1. This option cannot be changed.

DVR Name: Displays the DDNS name if configured.

Network ID: The ID number for EverFocus' CMS as set up in the Alarm Server menu.

【Status】

Disk: Displays the status of the internal hard disks. Normal hard disk operation is indicated by "OK".

Fans: Displays the status of the internal fan. Normal fan operation is indicated by "OK".

6.10.2 Log

You can choose, display or export log data using this menu.



Start Date / End Date: Click to bring up the on-screen keyboard to set up the start / end date.

Start Time / End Time: Click to bring up the on-screen clock to set up the start / end time.

Log Type: Select the desired log types.

View Log: Click to bring up the Log List shown as below.

The screenshot shows the 'Log List' window with a table of log entries. The table has columns for ID, Time, and Status. The status for all entries is '[R]Video lost on camera1'. Navigation buttons for 'Previous', 'Next', and 'Close' are at the bottom.

ID	Time	Status
1	2013/03/07 18:52:48	[R]Video lost on camera1
2	2013/03/07 18:52:32	[R]Video lost on camera1
3	2013/03/07 18:52:21	[R]Video lost on camera1
4	2013/03/07 18:52:10	[R]Video lost on camera1
5	2013/03/07 18:52:07	[R]Video lost on camera1
6	2013/03/07 18:51:54	[R]Video lost on camera1
7	2013/03/07 18:51:47	[R]Video lost on camera1
8	2013/03/07 18:51:30	[R]Video lost on camera1
9	2013/03/07 18:51:17	[R]Video lost on camera1
10	2013/03/07 18:51:10	[R]Video lost on camera1

Clear Log: Click to delete all the selected log data.

Export Log to USB: Click the Export button to export the log data to the USB storage device. It's recommended to connect the USB memory stick to the USB port on the **REAR** panel of the DVR.

7. Remote Access to the DVR

7.1 Accessing the DVR on the Network

Follow the steps below to access the DVR through Web browser.

1. Open an Internet Explorer window and in the address bar type the IP address.

Local connection:

http:// (IP address from the DVR's Network Menu): IP port used
e.g. http://192.168.1.163:2468

Internet connection:

http:// (IP address given by your Internet Service Provider): IP port used
e.g. http://57.182.67.204:2468

2. The Login window pops up. Type the User Name and Password. The default User Name is **admin**, while the password is **11111111**. Click **OK**.

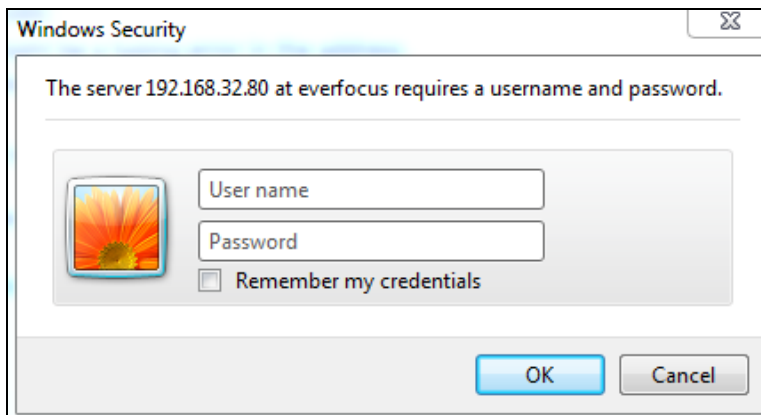

- If you log in for the first time, follow the instruction steps on the interface to update the latest Plugin version (ePlayer). After reloading the webpage, the login window pops up again. Type the user ID and password to log in again. By default, the user ID is **admin** and the password is **11111111**.

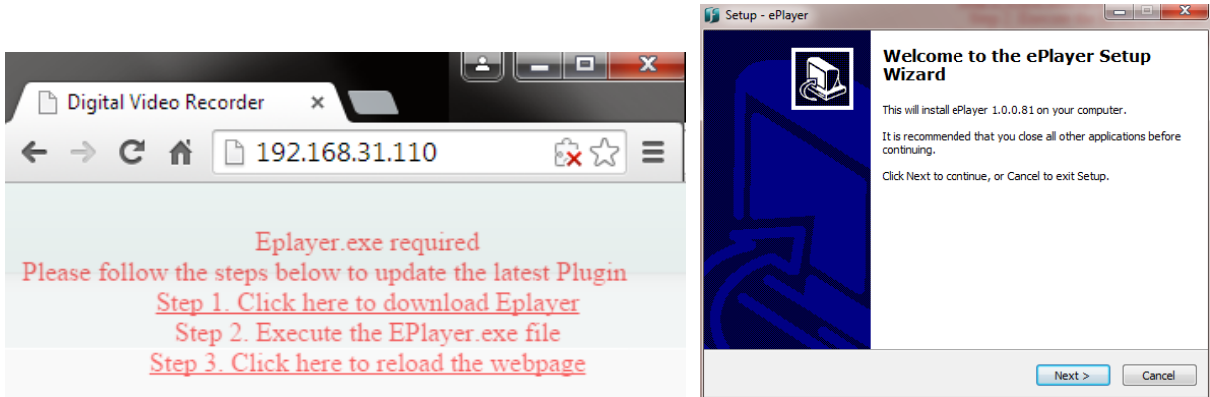

Note for the first time login:

- ◆ The “Download ePlayer Instruction” page will only be prompted for the first time login in order to update the system to the latest plugin version.
- ◆ When the Plug-in blocked appears on the browser, select **Always allow plug-ins on xxx**, click **Done** and then reload the webpage.

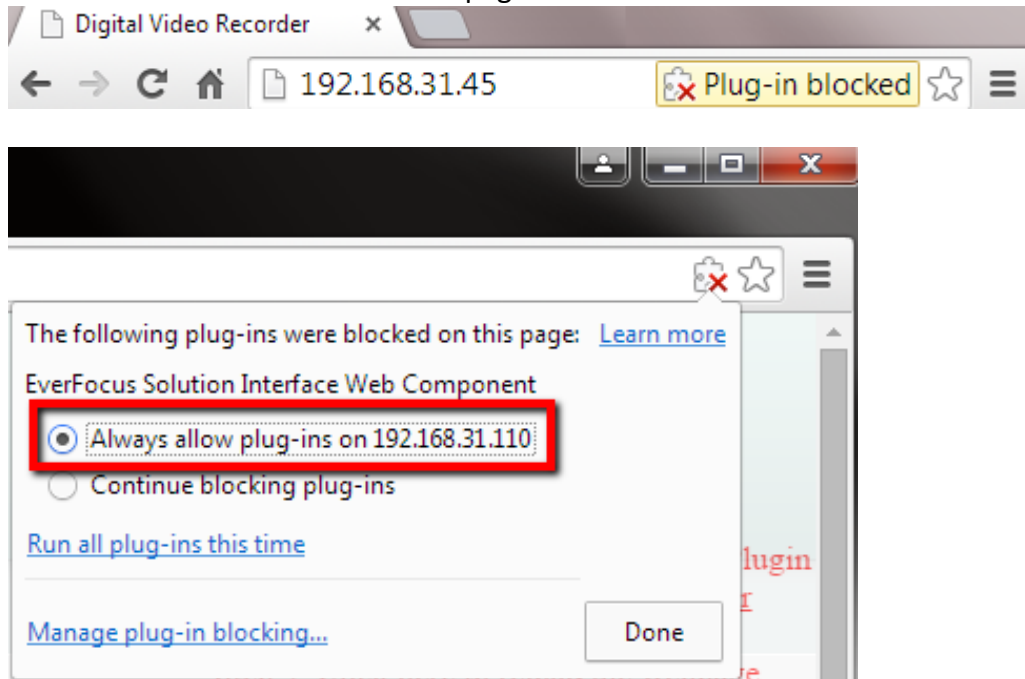

- Now you will be able to see the remote live page.

If you encounter the following problem or still can't access the remote Web interface, please see below:

- ◆ If the **Error** window appears, please be sure to **close ALL the Web browser windows first** and then click **Retry**. When the **Completing the ePlayer Setup Wizard** window shows up, click **Finish**. Then, you can open a new browser again to access the DVR's remote Web interface.

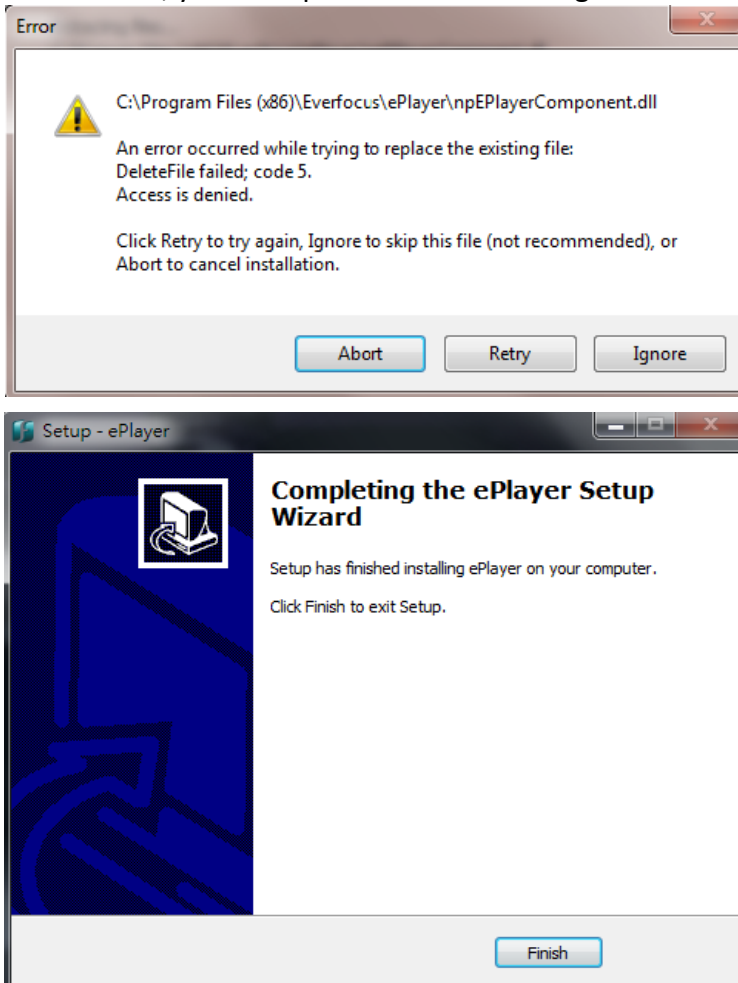

- ◆ If your PC or laptop is running with Windows, it's required to run the browser as administrator when first entering the remote web page of the device. Go to **C:\Program Files (x86)\Internet Explorer**, right-click the browser and then click **Run as administrator**.

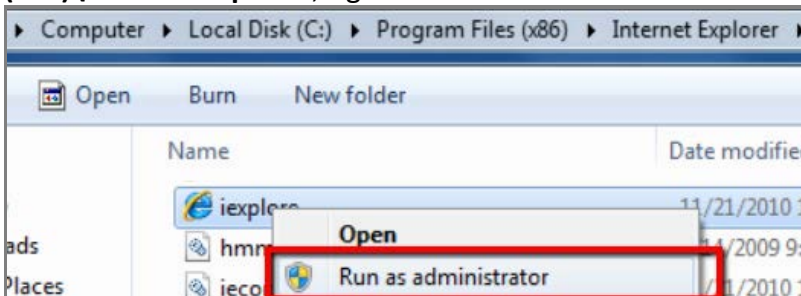

- ◆ You may need to turn **User Account Control** off if you still can't see the Remote Live View. On the computer, click **Start > Control Panel > System and Security > Action Center** (click Change User Account Control Settings), the **User Account Control Settings** window appears. Adjust the slide bar to **Never Notify** and then click **OK**. Restart your computer if requested.

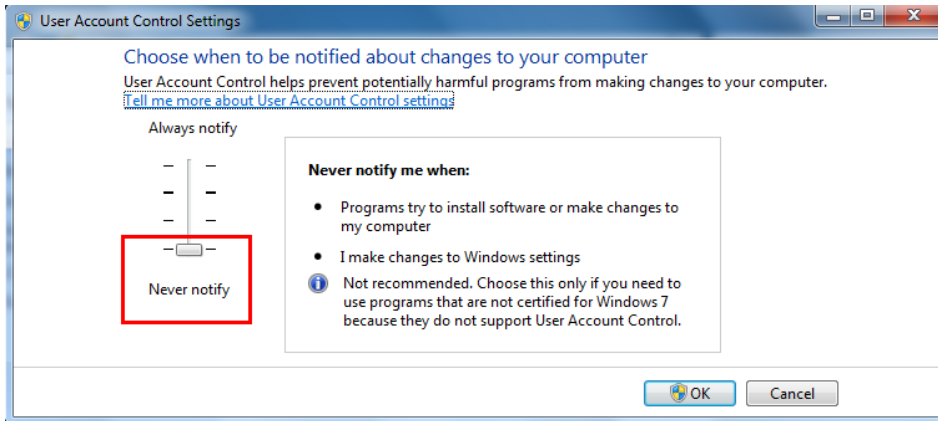

7.2 Remote Live View



No.	Name	Description
1	Menu Bar	For configuring the DVR. Please refer to 4. <i>OSD Root Menu</i> .
2	Layout	Click to select a desired layout.
3	Sub / Main	Click to switch between the Main stream and Sub stream.
4	Speaker / Microphone / Snapshot	Click the Speaker button to transfer audio to the client side from DVR if there is a speaker on the PC and a microphone and preamp attached to the DVR, and audio recording is enabled on the DVR. Click the Microphone button to transfer audio to DVR from client side if there is a microphone attached to the PC and an amplifier and speaker attached to the DVR. Click the Snapshot button to save a snapshot of the video image currently being displayed.
5	Channel Buttons	Click to display the channel in full screen.

6	Status Highlight	Black Circle: Indicates the DVR is recording in sub-stream. Red Circle: Indicates the DVR is recording in main-stream. White: Indicates the live view is in a normal status. Orange: Indicates a motion event is being detected. Blue: Indicates video loss. Red: Indicates an alarm / event is triggered. Grey: Indicates the live view is disabled.
7	Live View Window	Double-click on a camera image to enlarge the current display to full screen; double-click again to return to the normal view.

7.3 Menu Bar



No.	Name	Description
1	Live	Click to display the live view window.
2	Express	Click to configure the global express settings for all cameras. Please refer to <i>6.1 Express</i> .
3	Camera	Click to configure the camera settings. Please refer to <i>6.2 Camera</i> .
4	Record	Click to configure the record settings. Please refer to <i>6.3 Record</i> .
5	Event	Click to configure the alarm / event settings. Please refer to <i>6.4 Event</i> .
6	Disk	Click to display the HDD information. Please refer to <i>6.5 Hard Disk</i> .
7	Display Setting	Click to configure the display settings for displaying the camera information on the camera live view. Please refer to <i>6.6 Display Settings</i> .
8	Network	Click to configure the network settings. Please refer to <i>6.7 Network Settings</i> .
9	Schedule	Click to configure the recording schedule. Please refer to <i>6.8 Schedule Setting</i> .
10	System Setting	Click to configure the DVR time / user privilege / IO control / UI language or upgrading firmware and etc. Please refer to <i>6.9 System Setting</i> .
11	System Information	Displays the system information. Please refer to <i>6.10 Information</i> .
12	Copy	Click to archive the recordings from the DVR to the client PC. Please refer to <i>4.7 Archiving the Recordings or Log Data to the USB or DVD</i> .
13	Search	Search the recordings for remote playback. Please refer to <i>7.4 Remote Playback</i> .
14	PTZ	Click to control the connected PTZ cameras. Please refer to <i>4.1 PTZ</i> .

7.4 Remote Playback

To playback the recordings remotely, click the **Search** button on the Menu Bar. Click **Time Search**, **Event Search**, **Smart Search** or **POS Search** and then set up the settings. For more details about Search setting, please refer to *5.3 Searching the Recordings for Playing Back*.

Double-click on a recording, the following Remote Playback Window appears.

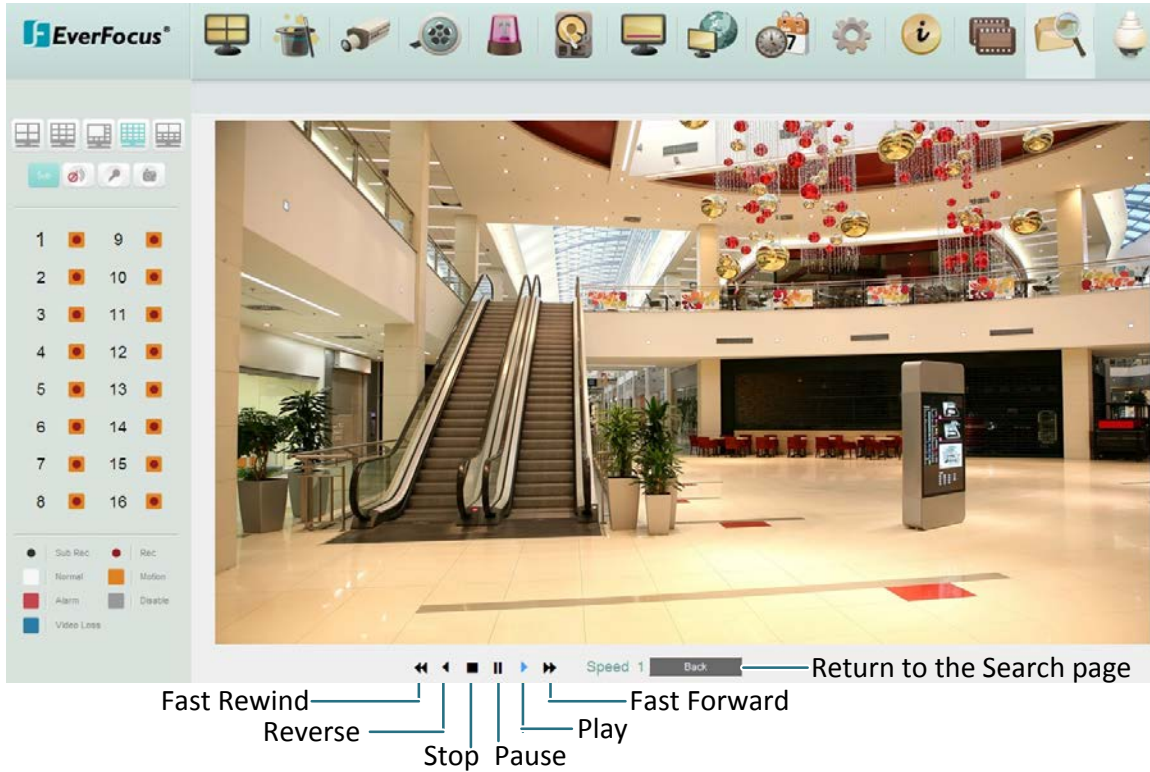

Chapter 8

8. Specifications

Model Name		ELUX16x2
System		
Operating System	Embedded Linux	
Number of Channels	16CH	
RAM	2GB	
Watchdog	Yes	
Dual Stream	Yes	
OSD Menu	Yes	
System Control	Front Panel Buttons, Mouse, IR Remote Control	
Pentaplex Operation	Simultaneous Live/Recording/Playback/Archive/ & Remote Viewing	
PTZ Protocol Supported	EverFocus, Pelco D, Pelco P, Samsung, Transparent	
Video		
Compression Format	H.264	
Video Format	NTSC / PAL	
Video Inputs	16 x BNC	
Video Looping Outputs	16 x BNC	
Video outputs	Main	HDMI
	Call	VGA and BNC
Recording		
Recording Rate / Resolution	NTSC	240fps @ 1080p; 480fps @ other resolution
	PAL	200fps @ 1080p; 400fps @ other resolution
Recording Modes	Manual, Schedule and Event	
Playback		
Playback Rate / Resolution	NTSC	240fps @1080p; 480fps @ other resolution
	PAL	200fps @1080p 400fps @ other resolution
Search Modes	Date / Time, Event, Motion in Recorded Video, Snapshot by Interval	

Audio	
Audio Input	16 inputs
Audio Output	1 output
Alarm	
Alarm Inputs	16 inputs
Alarm Outputs	1 x relay output
Storage Device	
Internal 3.5" HDD	4 x SATA HDD (Optional)
External HDD	1 x eSATA
Storage Capacity	16 TB
DVD Burner	Yes (Optional)
Network	
Ethernet	10/100/1000 Ethernet
Protocol	TCP-IP / DHCP / PPPoE / DDNS / SMTP / NTP
Interface	
USB 2.0	2 x USB 2.0 port (1 on Front Panel, 1 on Back Panel)
RS-485	2 pin terminal connector
Ethernet	1 x RJ-45
General	
Power Input	12VDC / 8A
Power Consumption	96W max.
Operating Temperature	0°C ~ 40°C / 32°F ~ 104°F (20 ~ 80% humidity)
Dimensions (W x D x H)	395 x 430 x 79.5mm / 15.6" x 16.9" x 3.2"
Weight (without HDDs)	6kg / 13.23lb
Language	English, Japanese, Traditional Chinese, Spanish, Deutsch, French, Russian, Portuguese (Brazil), Dutch, Simplified Chinese
Regulatory	CE, FCC, UL, BSMI
Functions	
Video Pause	Yes
Video Loss Detection	Yes
Motion Detection	Yes
Event Log	Yes
User Interface	GUI (Graphical User Interface)
Control PTZ via OSD	Yes (via both local and remote interfaces)
Schedule Setting	Supports Express and Advanced Schedule Setting
User Access	3 Levels of User Access Defined

Remote Client System Minimum Requirement	
Operating System	Windows XP (32-bit) / Win7 (32 and 64-bit)
CPU	Intel Core I3-2100
RAM	2GB
VGA	Intel HD 2000
LAN Speed	10 / 100 / 1000 Mbps (RJ45)
Web Browser	IE9 and later, Firefox, Chrome (Windows version 44 and earlier)
Other Remote Application	<ol style="list-style-type: none">1. EverFocus' CMS: Genie XMS2. EverFocus' mobile app: MobileFocus (iOS / Android); MobileFocusHD (iPad).

Chapter 9

9. Troubleshooting

If you have problems with the system, run through the following checklist to see if you can solve the problem.

- ❑ **The DVR will not go into record mode.**
 - Bring up the DVR's Menu and check under the Camera Menu. Verify that all connected cameras are checked as "Installed" and that Record Mode is set to "Continuous".
 - Check the Disk or Information Menus and verify that the internal hard drive is being detected.

- ❑ **The DVR displays nothing on the main monitor.**
 - Make sure the monitor is connected to either HDMI port, the VGA port or BNC port. If the monitor has multiple inputs, make sure it is on the correct input source and display setting.
 - Check that the monitor cables are good and power is on.
 - Verify the recorder is getting the correct supply power.

- ❑ **There is no display coming from one of the channels on the DVR.**
 - In the DVR's Camera Menu, make sure that all cameras are checked as "Installed" and unchecked for "Covert".
 - If there is still no picture, switch ports or connect a working camera to the port that has no picture. If you get an image, the problem is coming from the camera or cable.

- ❑ **I cannot connect to the recorder via the internet.**
 - Check that you can connect to the DVR on the LAN.
 - Check that the DVR has a static IP address and the port used by the DVR is forwarded correctly to that IP address in the router.
 - Verify that your Internet Service Provider does not block the IP port being used
 - Make sure you are using the correct WAN IP address given by the ISP, or, if you have a Dynamic IP, check if the IP address has changed; use DDNS to avoid problems caused by changing ISP addresses.

Appendix

A

Appendix A: Network Overview

This chapter will give you a basic instruction on how to set up the DVR for network connection. It is highly recommended that you have a working knowledge of what a network is and how it works. This will be helpful in completing the networking process.

Introduction to TCP / IP

TCP/IP is the group of protocols used by the Internet and most Local Area Networks (LANs) throughout the world. In TCP/IP, every computer or other communications device that is connected to the network has a unique IP address. By doing this you are giving your device a unique address similar to the address of your house. An IP address is composed of four octets (numbers in the range of 0 to 255) separated by decimal points. The IP address is used to uniquely identify a host or computer on the LAN. For example, one computer on a network could have an IP address of 192.168.1.127.

You should never give two or more devices the same exact IP address, but the first three octets of an IP address is often the same for all computers in the local area network. For example, if a total of 253 computers exist in a single LAN, the IP addresses could be assigned starting with 192.168.1.x, where x represents a number in the range of 2 to 254. In IPP address could be compared with a telephone number.

Subnet Masks

Each host in a LAN has a subnet mask. The subnet mask is a set of octets that is used to determine which LAN or class it belongs to. The number 255 is usually used to represent the network address portion of the IP address and a zero is placed at the end to identify the host portion of the address. Basically the subnet mask tells the devices how the network addresses are organized, and helps to determine which addresses are local and which are remote (on the other side of the router).

Gateway Address

Addressees are either local or remote. A gateway address is composed of four octets separated by decimal points. The gateway address is used to uniquely identify the device on the LAN that has access to the communications links connecting to other LANs, WANs and/or the Internet (access to the 'remote' addresses).

Virtual Ports

A **port number** represents a "channel" or entryway for network communications. Port numbers allow different computers to utilize network resources without interfering with each other. Port numbers most commonly appear in network programming, particularly socket programming. Sometimes, though, port numbers are made visible to the casual user. For example, some websites on the Internet use a URL like the following:

`http://www.sitename.com:8100/`

In this example, the number 8100 refers to the port number used by the browser to connect to the web server. The standard port number used by web sites is 80, so this number does not need to be included with the URL (although it can be). In IP networking, port numbers can theoretically range from 0 to 65535. Most popular network applications, though, use port numbers at the lower end of the range (such as 80 for HTTP). Ports are similar to doors and windows of your house, with port 80 acting as the front door. If these are not open you could not enter the house. This is the same case with ports on a network. If the ports for a specific IP address are not open then you could not gain access to that IP address.

Note: The term port also refers to several other aspects of network technology. A port can refer to Ethernet connection points, such as those on a hub, switch, or router. The term port is also used to refer to a physical connection point for peripheral devices such as serial, parallel, and USB ports.

Another analogy would be: if a WAN IP address is similar to the phone number identify a site, IP ports are similar to telephone extensions, in that they allow communication with specific devices within a site that all share the same external (WAN) IP address. A router is a device which allows multiple computers and other IP enabled equipment to share that single WAN IP address. It functions like a "switchboard operator" – opening ports creates an association between those port numbers and the LAN IP address of specific equipment on the LAN behind the router. When the router sees a 'call' for a specific 'extension' (port), it directs that data stream to the (LAN IP address of the) equipment associated with that 'extension' (port).

Pre-Installation

Before beginning the installation, please answer the following questions:

- Do you have Hi-speed Internet? _____

There are many types of high speed Internet available. The most common ones are T1, Cable, and DSL (in order of speed). The DVR is not compatible with a dial-up connection.

Note: EverFocus suggests having a minimum upload speed of 256KBps. This can be addressed by your Internet Service Provider.

- What type of modem/router do you have? _____
Modem/router model name/ #

The modem/router was either installed by your Internet service provider or purchased by you to establish a connection to the Internet. A router assigns different internal IP addresses to local computers; this allows multiple computers to access the Internet through the same external IP address.

- Do you have a static IP address? _____

A Static IP address means you use the same IP address every time you connect to the Internet. With a static IP address, other Internet users always know the address of your location and can easily connect with it. This makes it much simpler to host a website, email server, or other type of server connection. Everfocus suggests using a static IP address. If this is not available, you will need to use a dynamic IP address. This is explained below.

- Do you have a dynamic IP address? _____

A Dynamic IP address means your IP address changes each time you connect to the Internet. We recommend asking your Internet service provider for a Static IP address. If this is not a possibility, you may use the DDNS feature of the DVR. DDNS stands for Dynamic Domain Name Server, a service that provides a central database where IP information can be stored and retrieved. It allows those using a dynamic IP address to be registered centrally so users can connect to it by name. See Chapter 4 for details on using EverFocus DDNS.

- What type of DVR are you installing? _____

The default ports are

ECOR264: 80

Paragon: 80

ECOR: 80, 1600

EDR/EDVR: 80, 1600, and 37260 – 37263

EMV: 80

TUTIS: 80

ELUX: 80

If the ports were changed in the Network Setup, use those port numbers.

Pre-Installation

Everfocus' DVR can operate using one of three types of networking connections.

Simple One to One Connection: A simple one to one connection is the simplest type of network connection. It uses a cross-over cable to make a direct connection from one computer to another (or in this case a computer to a DVR).

Direct High Speed Modem Connection: A direct modem connection uses a standard network cable to connect the modem directly to a computer (or in this case a modem to the DVR). This type of connection only covers single-port modems. For a combination modem/router, use the setup described below.

Router or LAN Connection – A local area network connection requires either a router or a pre-existing LAN connection. This is the most common type of connection. A router allows multiple computers and DVR's to access each other as well as the Internet. It assigns different internal IP addresses to the computers.

Appendix B

Appendix B: Linksys & D-Link Port Forwarding

Typical Linksys Port Forwarding

This section will cover a few simple configurations for the Linksys router. This chapter is only to offer some help to the installer and end user. Please understand we **DO NOT** support this product and will not give tech support on it. If you need additional technical support on this router you must call Linksys.

To access the Web-based Utility, launch a web browser and type the Router's IP address, typically **192.168.1.1**, in the address bar. Then press Enter. A password request page will appear. (Non-Windows XP users will see a similar screen.) Leave the User Name field blank. The first time you access the router, use the default password **admin**. Click the **OK** button to continue.



The first screen that appears displays the Setup tab. This allows you to change the Router's general settings. Change these settings as described here and click the **Save Settings** button to apply your changes or **Cancel Changes** to cancel your changes.

Click on the “Applications & Gaming” tab.

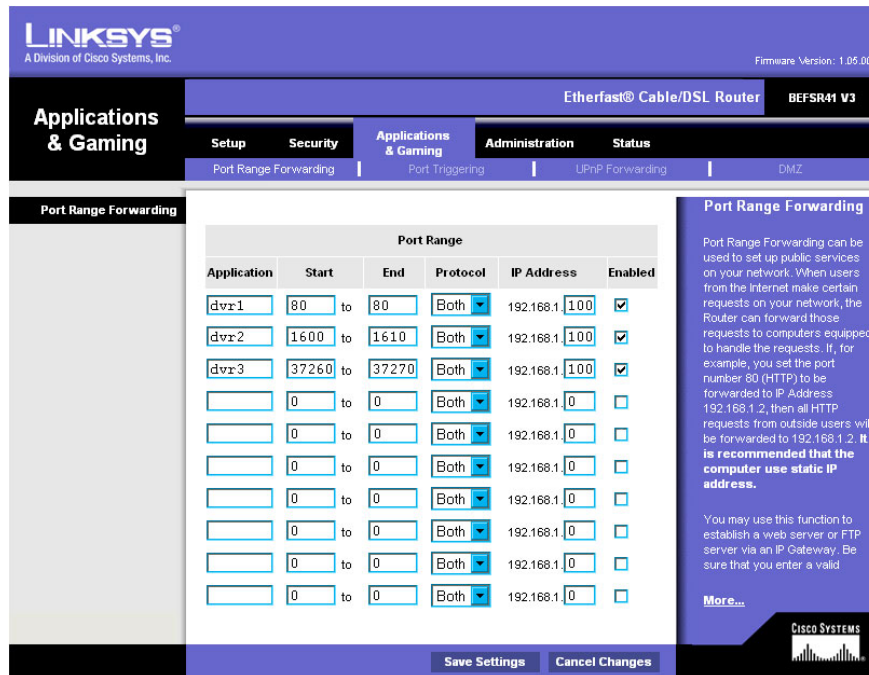

Applications and Gaming allows you to set up public services on your network, such as web servers, ftp servers, e-mail servers, or other specialized Internet applications. (Some Internet applications may not require any forwarding) To forward a port, enter the information on each line for the criteria required. Descriptions of each criterion are described here.

- Application** - In this field, enter the name you wish to give the application.
 - Start/End** - Enter the starting number of the range under **Start** and the ending number under **End**.
 - Protocol** - Enter the protocol used for this application, either **TCP** or **UDP**, or **Both**.
 - IP Address** - For each application, enter the IP Address of the PC running the specific application.
 - Enable** - Click the **Enable** checkbox to enable port forwarding for the relevant application.
- When finished making changes, click the **Save Settings** button to apply your changes or **Cancel Changes** to cancel them.

Here is an example for how the port information might look:

HTTP 80 to 80 Both 192.168.1.50 Enable

Where 192.168.1.50 is the IP address of the DVR on the LAN, and the default port 80 is in use.

Note: If you changed port 80 in the DVR’s Network Menu, open that port instead of 80.

Typical D-Link Port Forwarding

This section will cover a few simple configurations for the D-Link router. This chapter is only to offer some help to the installer and end user. Please understand we **DO NOT** support this product and will not give tech support on it. If you need additional technical support on this router you must call D-Link.

Whenever you want to configure your network or the DI-624, you can access the Configuration Menu by opening a web-browser and typing in the IP Address of the DI-264.

The DI-264 default IP Address is 192.168.0.1.

- Type “admin” in the **User Name** field
- Leave the **Password** blank
- Click **OK**

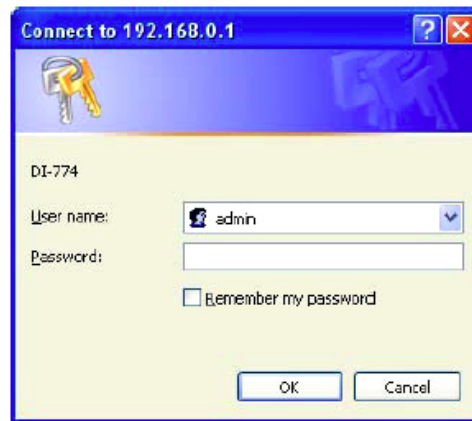

The first screen that shows up is the Home Tab. This is the starting point for all the router’s settings and functions.

Click Virtual Servers on the left to bring up the following screen.



Virtual Servers allows users who are connecting remotely to access services on the router's Local Network. The functions of each field are described below.

Virtual Server - Select **Enabled** or **Disabled**

Name - Enter the name referencing the virtual service

Private IP - The IP address of the device running the local services.

Protocol Type - The protocol used for the virtual service.

Private Port - The port number that the service uses on the LAN (Local Area Network).

Public Port - The port number that the services uses on the WAN (Wide Area Network).

Schedule - The time period the virtual server will be active.

When you have input all the information for a virtual server, click on **Apply** to add it to the list at the bottom or **Cancel** to clear all fields.

Here is an example of the information for each service:

<u>Name</u>	<u>Private IP</u>	<u>Protocol</u>	<u>Private Port</u>	<u>Public Port</u>	<u>Schedule</u>
HTTP	192.168.1.50	Both	80	80	Enable

Where 192.168.1.50 is the IP address of the DVR on the LAN, and the default port 80 is in use.

Note: *If you changed port 80 in the DVR's Network Menu, open that port instead of 80.*

Appendix C: Timing of Alarm Modes

Transparent Mode

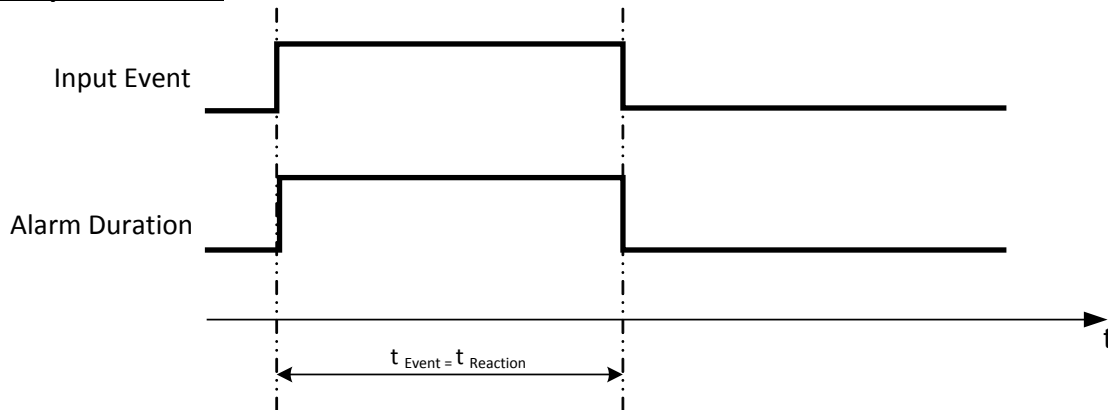

t_{Event}: Duration of alarm input source (motion, contact, system events...)

t_{reaction}: Resulting duration for this alarm mode, related to event record, alarm outputs, OSD message, buzzer

Timeout + Transparent Mode

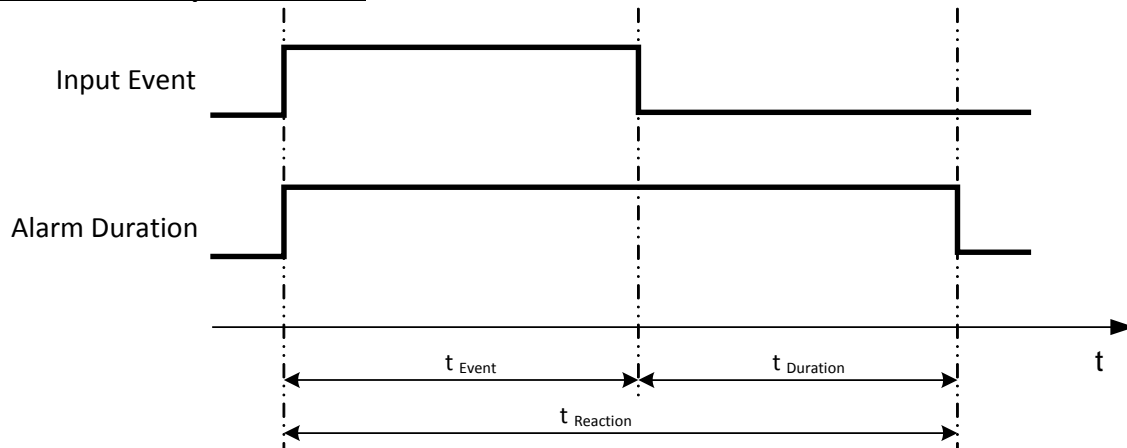

t_{Event}: Duration of alarm input source (motion, contact, system events...)

t_{Duration}: Alarm duration for timeout, defined in the event setup menus

t_{reaction}: Resulting duration for this alarm mode, related to event record, alarm outputs, OSD message, buzzer

Timeout Mode

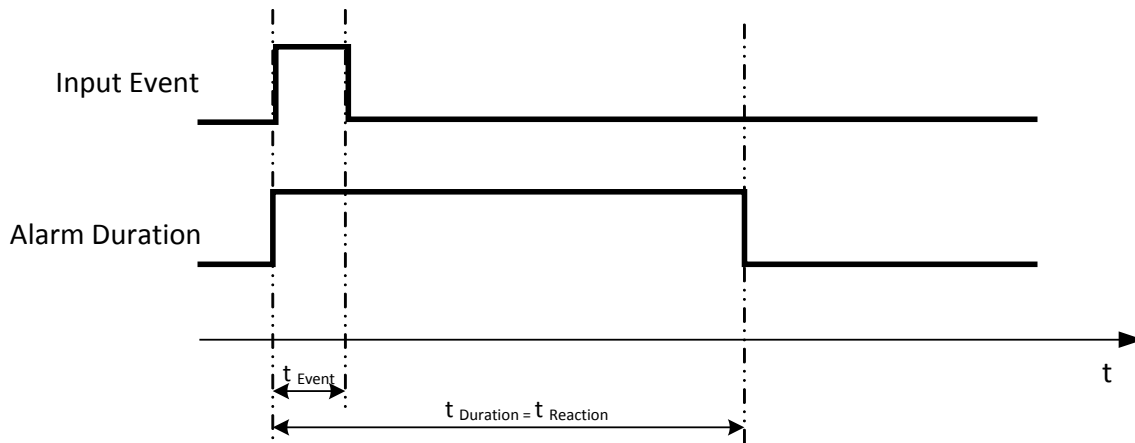

t_{Event} : Duration of alarm input source (motion, contact, system events...)

t_{Duration} : Alarm duration for timeout, defined in the event setup menus

t_{reaction} : Resulting duration for this alarm mode, related to event record, alarm outputs, OSD message, buzzer

Permanent Mode

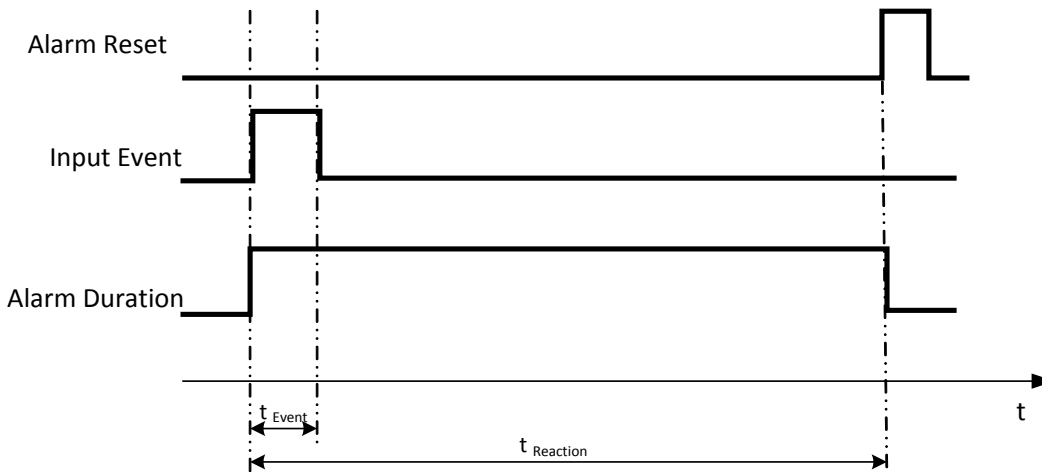

t_{Event} : Duration of alarm input source (motion, contact, system events...)

t_{Duration} : Alarm duration for timeout, defined in the event setup menus

t_{reaction} : Resulting duration for this alarm mode, related to event record, alarm outputs, OSD message, buzzer

Timeout Mode: Retrigger of Alarms

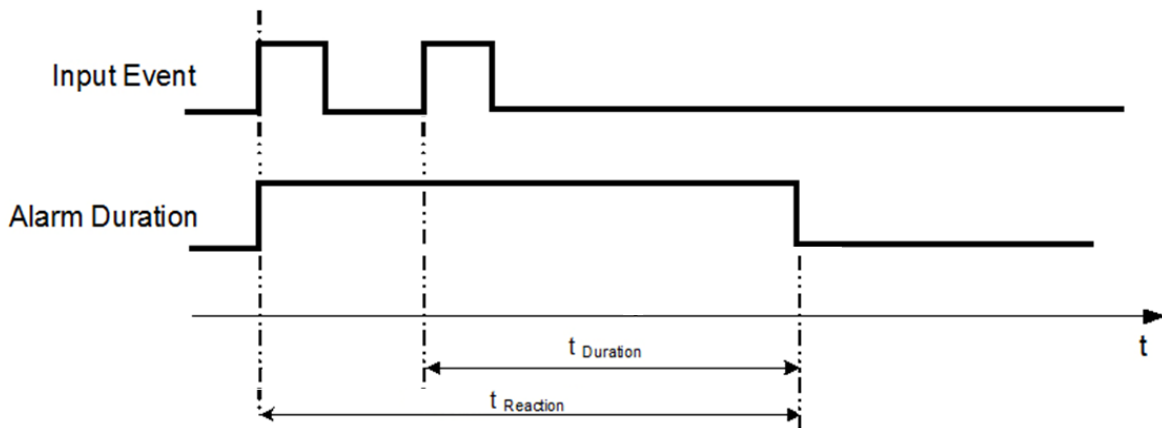

- t_{Event}**: Duration of alarm input source (motion, contact, system events...)
- t_{Duration}**: Alarm duration for timeout, defined in the event setup menus
- t_{reaction}**: Resulting duration for this alarm mode, related to event record, alarm outputs, OSD message, buzzer

Timeout+Transparent Mode: Retrigger of Alarms

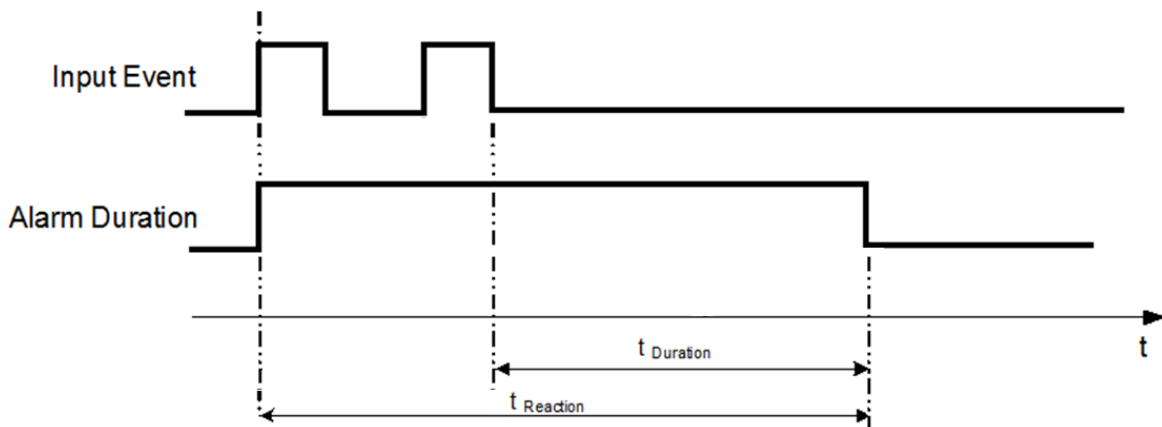

- t_{Event}**: Duration of alarm input source (motion, contact, system events...)
- t_{Duration}**: Alarm duration for timeout, defined in the event setup menus
- t_{reaction}**: Resulting duration for this alarm mode, related to event record, alarm outputs, OSD message, buzzer

Appendix D

Appendix D: Express Setup Recording Value Selection Rules

Case 1:

Record Mode: Normal + Event

Record With: Recording days

The DVR will Auto adjust image Quality and Event frame rate to match the number of Recording days which user selected:

According to resolution, event hours and other assumptions above, the DVR will attempt to select one set of suitable quality and event frame rate by checking if set 1 meets the requirements, and proceed in order unit the requirements are met. If the DVR can't match the required record days from one of the 8 sets, it will use set 8.

Checking Order	1	2	3	4	5	6	7	8
Normal Frame Rate	1	1	1	1	1	1	1	1
Quality	Superior	Standard	Low	Low	Low	Low	Low	Low
Event Frame Rate	30	30	30	15	10	7.5	5	1

Case 2:

Record Mode: Event Only

Record With: Recording days

DVR will Auto adjust Quality and Event frame rate to match the Recording days which user need:

According to resolution, event hours and other assumptions above, the DVR will attempt to select one set of suitable quality and event frame rate by checking if set 1 meets the requirements, and proceed in order unit the requirements are met. If the DVR can't match the required record days from one of the 8 sets, it will use set 8.

Checking Order	1	2	3	4	5	6	7	8
Quality	Superior	Standard	Low	Low	Low	Low	Low	Low
Event Frame Rate	30	30	30	15	10	7.5	5	1

Case 3:

Record Mode: Normal + Event or Event Only

Record With: Preset Setting

DVR will apply the settings in the table below to all cameras according to the Preset Settings.

Preset Setting Option	Camera Item	Apply value
Best Quality	Quality	Superior
	Normal Frame Rate	Max recording frame rate of DVR
	Event Frame Rate	30
Standard Quality	Quality	Standard
	Normal Frame Rate	Half of max recording frame rate of DVR
	Event Frame Rate	30
Extended Quality	Quality	Basic
	Normal Frame Rate	1
	Event Frame Rate	10

Appendix

E

Appendix E: IR Remote Control

The IR remote control is an accessory to enhance the convenient operation of the DVR. You can perform all the settings and operations from the remote control. The effective distance is up to 33 feet line of sight.

When there is more than one DVR installed in the same environment, you need to select a correct DVR ID, preventing the DVR from responding to commands from the Remote Control.

To select the DVR ID,

1. Aim at the IR receiver of your DVR.
2. Select the DVR ID number by pressing the **DVR Device ID Button** first.

The DVR ID number here must correspond to the "IR Remote ID" set up in the "I/O Control Menu", and remember to click **Save** on that setting page (refer to 6.9.5 I/O Control).

For example, if you set up "2" in the OSD setting page, you need to press "2" on the controller.

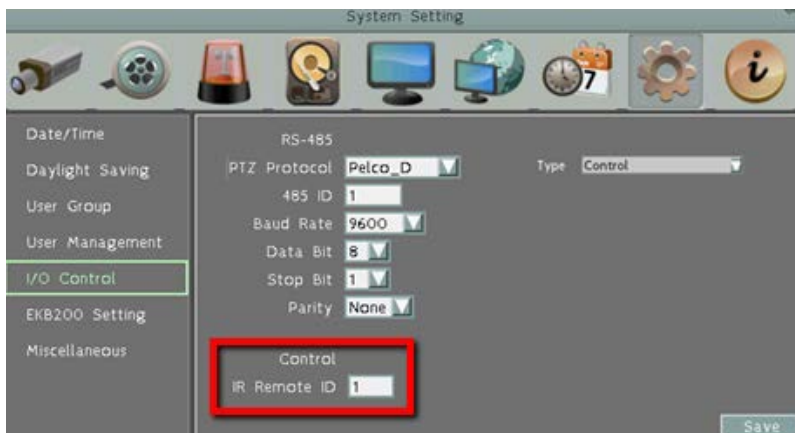

3. Now you can control the DVR.

Appendix

F

Appendix F: RTSP URL Syntax

EverFocus provides 2 / 4 / 8 / 12 / 16 / 32 channels DVR, NVR and Mobile DVRs. The RTSP URL Syntax of EverFocus' DVR, NVR and Mobile DVR are listed as below:

2CH MDVR:

Main Stream	rtsp://[device-ip-address]/3GPP/[channel-number 0~1] * [device-ip-address] is the IP address of the MDVR * [channel-number 0~1] is the channel number of the MDVR. 0 for channel 1, 1 for channel 2.
Sub Stream	rtsp://[device-ip-address]/3GPP/[channel-number 2~3] * [device-ip-address] is the IP address of the MDVR * [channel-number 2~3] is the channel number of the MDVR. 2 for channel 1, 3 for channel 2.

4CH DVR / NVR / MDVR:

Main Stream	rtsp://[device-ip-address]/3GPP/[channel-number 0~3] * [device-ip-address] is the IP address of the DVR/NVR/MDVR * [channel-number 0~3] is the channel number of the DVR/NVR/MDVR. 0 for channel 1, 1 for channel 2, and so on.
Sub Stream	rtsp://[device-ip-address]/3GPP/[channel-number 4~7] * [device-ip-address] is the IP address of the DVR/NVR/MDVR * [channel-number 4~7] is the channel number of the DVR/NVR/MDVR. 4 for channel 1, 5 for channel 2, and so on.

8CH DVR / NVR / MDVR:

Main Stream	rtsp://[device-ip-address]/3GPP/[channel-number 0~7] * [device-ip-address] is the IP address of the DVR/NVR/MDVR * [channel-number 0~7] is the channel number of the DVR/NVR/MDVR. 0 for channel 1, 1 for channel 2, and so on.
Sub Stream	rtsp://[device-ip-address]/3GPP/[channel-number 8~15] * [device-ip-address] is the IP address of the DVR/NVR/MDVR * [channel-number 8~15] is the channel number of the DVR/NVR/MDVR. 8 for channel 1, 9 for channel 2, and so on.

12CH MDVR:

Main Stream	rtsp://[device-ip-address]/3GPP/[channel-number 0~11] * [device-ip-address] is the IP address of the MDVR * [channel-number 0~11] is the channel number of the MDVR. 0 for channel 1, 1 for channel 2, and so on.
Sub Stream	rtsp://[device-ip-address]/3GPP/[channel-number 12~23] * [device-ip-address] is the IP address of the MDVR * [channel-number 12~23] is the channel number of the MDVR. 12 for channel 1, 13 for channel 2, and so on.

16CH DVR / NVR / MDVR:

Main Stream	rtsp://[device-ip-address]/3GPP/[channel-number 0~15] * [device-ip-address] is the IP address of the DVR/NVR/MDVR * [channel-number 0~15] is the channel number of the DVR/NVR/MDVR. 0 for channel 1, 1 for channel 2, and so on.
Sub Stream	rtsp://[device-ip-address]/3GPP/[channel-number 16~31] * [device-ip-address] is the IP address of the DVR/NVR/MDVR * [channel-number 16~31] is the channel number of the DVR/NVR/MDVR. 16 for channel 1, 17 for channel 2, and so on.

32CH DVR / NVR:

Main Stream	rtsp://[device-ip-address]/3GPP/[channel-number 0~31] * [device-ip-address] is the IP address of the DVR/NVR * [channel-number 0~31] is the channel number of the DVR/NVR. 0 for channel 1, 1 for channel 2, and so on.
Sub Stream	rtsp://[device-ip-address]/3GPP/[channel-number 32~63] * [device-ip-address] is the IP address of the DVR/NVR * [channel-number 32~63] is the channel number of the DVR/NVR. 32 for channel 1, 33 for channel 2, and so on.

Appendix G: Auto HDD Retry Mechanism

The DVR features Auto HDD Retry mechanism, which is designed to automatically reboot to detect the installed HDDs when encounter HDD fail error.

Note: The Auto HDD Retry mechanism will only activate when all of the HDDs installed in the DVR are failed simultaneously. For example, if your DVR installed one HDD, when one HDD fails, the Auto HDD Retry mechanism activates; if your DVR installed three HDDs, when all of the 3 HDDs fail simultaneously, the Auto HDD Retry mechanism activates.

When a HDD fail error occurs, a HDD Failure icon  will be displayed at the bottom of the monitor and a “HDD Failed. Please check HDD(s) and SATA/power cables.” message will pop-up. Owing to the Auto HDD Retry Mechanism, the DVR will then automatically reboot to detect the installed HDDs. If there is no HDD detected, the DVR will start rebooting to detect the HDDs again and again up to 3 times. During the rebooting process, a “HDD Failed. Rebooting...” message will be displayed. Once the HDDs have been detected, the recording function will automatically resume.

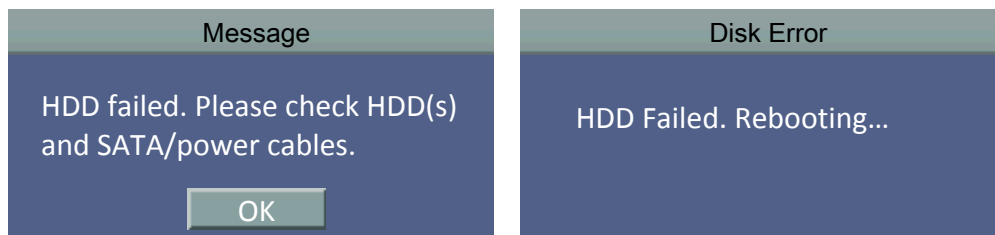

Note that the DVR will automatically reboot to detect HDDs up to 3 times. If the Auto HDD Retry process exceeds 3 times and the DVR still cannot detect HDDs, an “Auto HDD Retry exceeds 3 times.” message will pop-up and a continuous beep sound will be played for notification. It’s recommended to check the SATA and power cables connected to the HDDs; or replace new HDDs if necessary.

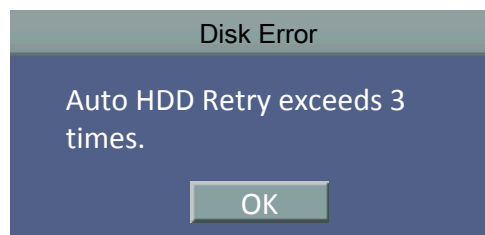

EverFocus Electronics Corp.

EverFocus Taiwan:

12F-1, No.79, Sec. 1, Shin-Tai Wu Road,
Hsi-Chih, New Taipei City, Taiwan
TEL: +886 2 2698 2334
FAX: +886 2 2698 3943
www.everfocus.com.tw
marketing@everfocus.com.tw

EverFocus China - Beijing:

Room 609, Technology Trade Building,
Shangdi Information Industry Base,
Haidian District, Beijing 100085, China
TEL: +86 10 6297 3336~39
FAX: +86 10 6297 1423
www.everfocus.com.cn
marketing@everfocus.com.cn

EverFocus USA - California:

1801 Highland Avenue, Unit A, Duarte, CA 91010, USA
TEL: +1 626 844 8888
FAX: +1 626 844 8838
www.everfocus.com
sales@everfocus.com

EverFocus Europe - Germany:

Albert-Einstein-Strasse 1, D-46446
Emmerich, Germany
TEL: +49 2822 93940
FAX: +49 2822 939495
www.everfocus.de
sales@everfocus.de

EverFocus China - Shenzhen:

4F, No. 2, D4 Building, Wan Yelong
Industrial Park, Tangtou Road, Shiyan,
Baoan, Shenzhen, Guangdong 518101, China
TEL: +86 755 2765 1313
FAX: +86 755 2765 0337
www.everfocus.com.cn
marketing@everfocus.com.cn

EverFocus Japan:

3F, Kuramochi, Building II, 2-2-3
Koto-Bashi, Sumida-Ku, Tokyo, 130-0022, Japan
TEL: +81 3 5625 8188
FAX: +81 3 5625 8189
www.everfocus.co.jp
info@everfocus.co.jp

	<p>Your EverFocus product is designed and manufactured with high quality materials and components which can be recycled and reused.</p> <p>This symbol means that electrical and electronic equipment, at their end-of-life, should be disposed of separately from your household waste.</p> <p>Please, dispose of this equipment at your local community waste collection/recycling centre.</p> <p>In the European Union there are separate collection systems for used electrical and electronic product.</p> <p>Please, help us to conserve the environment we live in!</p>	<p>Ihr EverFocus Produkt wurde entwickelt und hergestellt mit qualitativ hochwertigen Materialien und Komponenten, die recycelt und wieder verwendet werden können.</p> <p>Dieses Symbol bedeutet, dass elektrische und elektronische Geräte am Ende ihrer Nutzungsdauer vom Hausmüll getrennt entsorgt werden sollen.</p> <p>Bitte entsorgen Sie dieses Gerät bei Ihrer örtlichen kommunalen Sammelstelle oder im Recycling Centre.</p> <p>Helfen Sie uns bitte, die Umwelt zu erhalten, in der wir leben!</p>
---	--	---



EverFocus

PN: 4605ELA1603001A-Ver.A