

OPERATING INSTRUCTIONS

Basic Guide

Tablet Computer

Model No. **FZ-A2** series

Contents

Getting Started

Introduction.....	2
Description of Parts	4
First-time Operation.....	7
Turning On/Off and Sleeping/Waking Up	10
Input Operation.....	11

Useful Information

Handling and Maintenance.....	14
-------------------------------	----

Troubleshooting

Troubleshooting (Basic).....	20
------------------------------	----

Appendix

Specifications	23
LIMITED WARRANTY	25
Standard Limited Warranty.....	35

Getting Started

Useful Information

Troubleshooting

Appendix

Introduction

Thank you for purchasing this Panasonic product. For optimum performance and safety, please read these instructions carefully.

■ Terms and illustrations in these instructions

CAUTION :	Conditions that may result in minor or moderate injury.
NOTE :	Useful and helpful information.
→ :	Page in these Operating Instructions - Reference Manual.
 :	Reference to the on-screen manuals.

- Some illustrations are simplified to help your understanding and may look different from the actual unit.
- If you do not log on as an owner, you cannot use some functions or cannot display some screens.
- Refer for the latest information about optional products to the catalogs, etc.
- Screen messages are explained in [English (United States)].
(Depending on the language preference, some screen messages in these instructions are different from the actual screen messages. For example, [Aeroplane mode] may be displayed instead of [Airplane mode] in some language preference.)

■ Disclaimer

Computer specifications and manuals are subject to change without notice. Panasonic Corporation assumes no liability for damage incurred directly or indirectly from errors, omissions or discrepancies between the computer and the manuals.

■ Trademarks

Intel is a registered trademark or trademark of Intel Corporation.

microSDHC Logo is a trademark of SD-3C, LLC.



Adobe, the Adobe logo and Adobe Reader are either registered trademarks or trademarks of Adobe Systems Incorporated in the United States and/or other countries. Bluetooth® is a registered trademark owned by Bluetooth SIG, Inc., U.S.A. and licensed to Panasonic Corporation.

HDMI, the HDMI Logo and High-Definition Multimedia Interface are trademarks or registered trademarks of HDMI Licensing LLC in the United States and other countries.

Names of products, brands, etc., appearing in this manual are trademarks or registered trademarks of their respective own companies.

This product is licensed under the AVC Patent Portfolio License, VC-1 Patent Portfolio License and MPEG-4 Visual Patent Portfolio License for the personal use of a consumer or other uses in which it does not receive remuneration to

- (i) encode video in compliance with the AVC Standard, VC-1 Standard and MPEG-4 Visual Standard ("AVC/VC-1/MPEG-4 Video") and/or
- (ii) decode AVC/VC-1/MPEG-4 Video that was encoded by a consumer engaged in a personal activity and/or was obtained from a video provider licensed to provide AVC/VC-1/MPEG-4 Video. No license is granted or shall be implied for any other use. Additional information may be obtained from MPEG LA, LLC. See <http://www.mpegla.com>.

■ On-screen Manual

For further information about the computer, you can refer to the on-screen manual by performing the following steps.

- ① Touch  - [ OnlineManual].

When more than one on-screen manuals are prepared, name of those manuals are listed in above step. Touch a manual to access from the list.

■ For U.S.A.

This computer contains:

Model : WL15B

FCC ID : ACJ9TGWL15B

Description of Parts

Front side

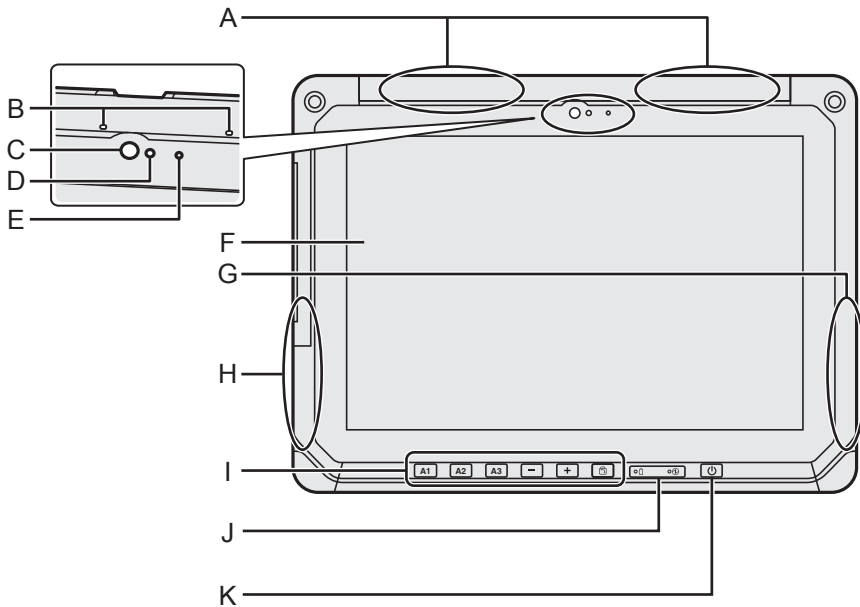

A: Wireless WAN Antenna

<Only for model with wireless WAN>

→ *Operating Instructions - Reference Manual* “Wireless WAN”, “GPS”

B: Microphone

C: Front Camera / Lens

→ *Operating Instructions - Reference Manual* “Camera”

D: Ambient Sensor

The ambient light sensor is equipped with an automatic brightness adjustment function that adjusts the display screen.
(→ page 15)

E: Camera Indicator

F: LCD

G: Wi-Fi / Bluetooth Antenna

→ *Operating Instructions - Reference Manual* “Wi-Fi”, “Bluetooth”

H: Wi-Fi Antenna

→ *Operating Instructions - Reference Manual* “Wi-Fi”

I: Tablet Buttons

→ *Operating Instructions - Reference Manual* “Tablet Buttons”

J: LED Indicators

: Battery status

: Power Indicator

Off: Power off, Green: Power on,
Blinking green: Sleep (Depending on the running state of software, the indicator may be green (not blinking)).

K: Power Switch

Right side

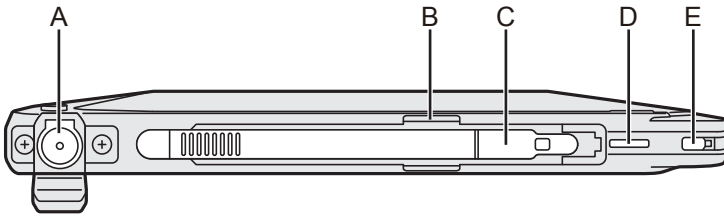

Left side

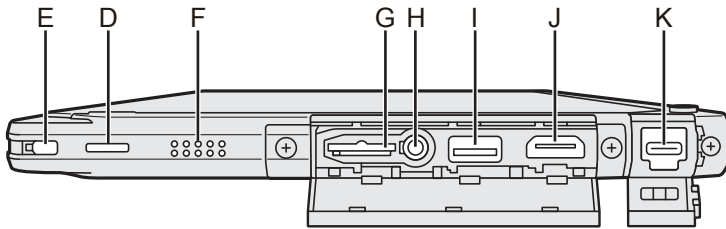

A: DC-IN Jack

Only the main unit can be charged.

B: Pen Holder

C: Pen

D: Tether Hole

E: Security Lock

F: Speaker

The speaker contains a magnet and magnetic products. Avoid leaving metallic object or magnetic media in contact with these areas.

G: microSD Memory Card Slot

Keep microSD Memory Cards away from infants and small children.

→  *Operating Instructions - Reference Manual* "MicroSD Memory Card"

H: Headset Jack

A headset or headphone can be connected.

I: Type-A USB 3.0 Port

Do not insert any foreign object in the USB port.

→  *Operating Instructions - Reference Manual* "USB Devices"

J: HDMI Output Port

→  *Operating Instructions - Reference Manual* "External display"

K: Type-C USB 3.1 Port

→  *Operating Instructions - Reference Manual* "USB Devices"

Description of Parts

Rear side

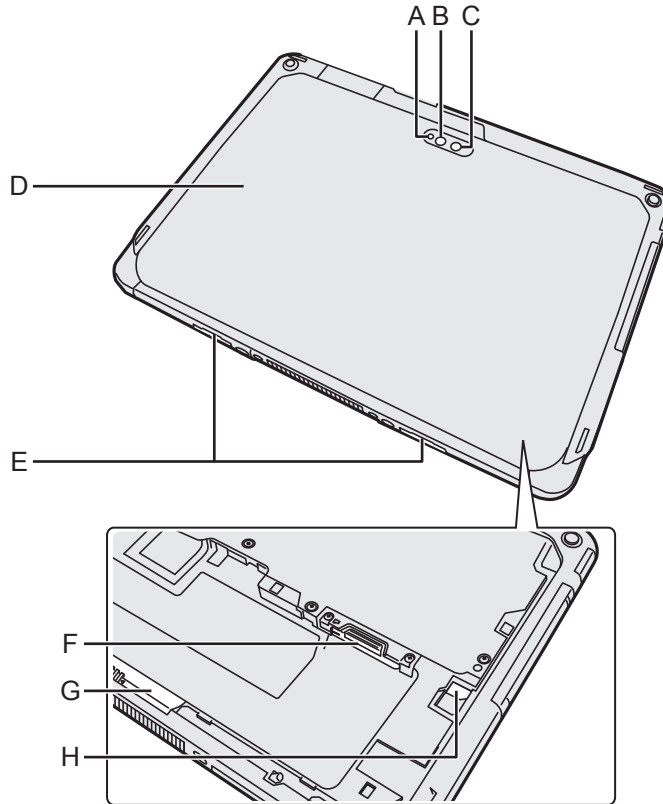

Rear Camera

<Only for model with Rear Camera>

A: Camera Indicator

B: Camera Light

C: Camera Lens

→ *Operating Instructions - Reference Manual "Camera"*

D: Back Cover

The shape of this may vary depending on the model.

E: Release Latch

F: microSIM Card Slot

<Only for model with wireless WAN>

→ *Operating Instructions - Reference Manual "Wireless WAN"*

G: Battery Pack Latch

→ *Operating Instructions - Reference Manual "Battery Power"*

H: LED Indicator

<Only for model with built-in bridge battery>

: Battery Status

→ *Operating Instructions - Reference Manual "Battery Power"*

First-time Operation

■ Preparation

① Check and identify the supplied accessories.

If you do not find the described accessories, contact Panasonic Technical Support.

• AC Adaptor 1

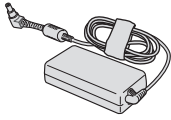

Model No: CF-AA6413C

• Stylus 1



• AC Cord 1



• Tether 1



• Battery Pack 1^{*1}

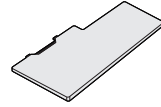

Model No: CF-VZSU0QW

• Soft Cloth 1



→  *Operating Instructions*
- *Reference Manual* "Input
Operation"

• OPERATING INSTRUCTIONS - Read Me First 1

^{*1} Stored in the main unit at the time of packing.

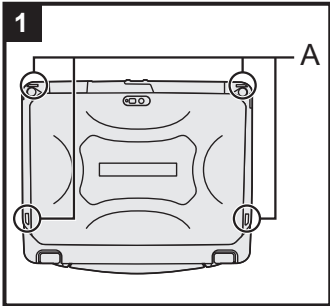

1 Attaching the stylus to the computer.

Use the tether to attach the stylus to the computer so you will not lose it. There are holes (A) to attach it.

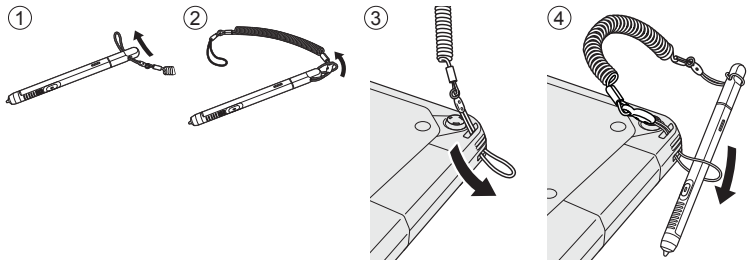

CAUTION

- Do not pull the tether with excessive force. The stylus may hit the computer, person's body or other objects when released.

First-time Operation

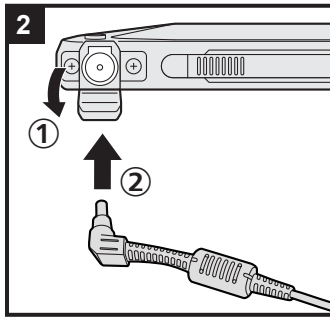

2 Connect your computer to a power outlet.

- ① Open the cover.
- ② Connect your computer to a power outlet.
The battery charging starts automatically.

CAUTION

- Do not disconnect the AC adaptor until the first-time operation procedure is completed.
- When using the computer for the first time, do not connect any peripheral device except the battery pack and AC adaptor.

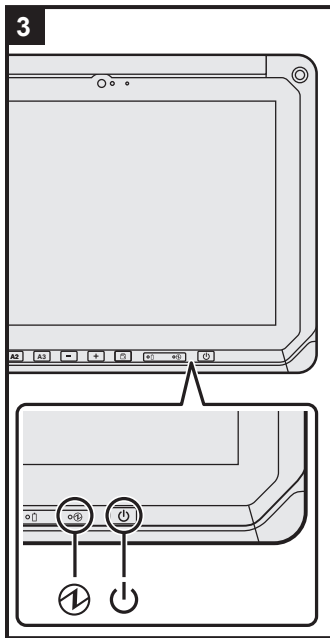

3 Turn on the computer.

Press the power switch (1) until the power indicator (2) lights. When turning on the computer for the first time after purchase, it may take about 5 minutes for the “Welcome” screen described in step 4 to appear.





CAUTION

- Do not press the power switch repeatedly or do not hold the power switch for 10 seconds or longer.
- The default settings of the Setup Utility cannot be changed until the first-time operation settings are configured.

4 Initializing the computer.

- ① When “Welcome” is displayed, touch the language name and scroll the language list, then touch the language you use and touch .
- ② <Only for model with wireless WAN>
When “Insert SIM card” screen is displayed, touch [SKIP].
- ③ When “Select Wi-Fi network” screen is displayed, perform one of the following operations.
 - If you want to set up wi-fi, set up wi-fi by following the on-screen instructions.
You will proceed to step ⑤ after the settings are complete.
 - If you do not want to set up wi-fi, touch [SKIP], then when the confirmation message is displayed touch [SKIP ANYWAY].
- ④ When “Date & time” screen is displayed, confirm the settings and touch [NEXT].
- ⑤ When “Name” screen is displayed, input your name, then touch [NEXT].

- ⑥ When “Protect your phone” screen is displayed, touch the item to select setting, then touch [NEXT].
 - If add the check mark to “Protect this device and ...”, “Choose screen lock” screen will be displayed. Set the screen lock method by following the on-screen instructions and touch [NEXT].
 - If remove the check mark from “Protect this device and ...”, touch [SKIP] and [SKIP ANYWAY].
- ⑦ When “Google™ services” screen is displayed, confirm the message and touch the items to select settings, then touch [NEXT].
- ⑧ When “Welcome” screen is displayed, touch [GOT IT].
- ⑨ If you did not set up Wi-Fi in step ③, connect to the internet via Wi-Fi or wireless WAN. (→  *Operating Instructions - Reference Manual* “Wireless Communication”)

To connect to internet via wireless WAN, inserting the micro-SIM card is necessary. (→  *Operating Instructions - Reference Manual* “Wireless WAN”)
- ⑩ Touch  - [ Settings] - [ About tablet] - [System updates] - [Download].

Follow the on-screen instructions.



CAUTION

- If the location info setup confirmation screen appears, follow the instructions on the screen to perform setup.
 - <Only for model with wireless WAN>

Do not affix labels on microSIM cards as doing so may result in malfunction.
-

Turning On/Off and Sleeping/Waking Up

Turning On

- ① Press  (power switch) until  (power indicator) lights.
- ② Release the lock using the method configured in the “Protect your phone” screen (→ page 9).



CAUTION

- Do not press the power switch repeatedly.
- Once you turn off the computer, wait for ten seconds or more before you turn on the computer again.
- Do not perform the following operation until the drive indicator  turns off.
 - Connecting or disconnecting the AC adaptor
 - Pressing the power switch
 - Touching buttons, screen or external mouse

NOTE

- Lock type can be changed by touching  - [ Settings] - [ Security] - [Screen lock].

Turning Off



- ① Press and hold  (Power switch) until “Power off” screen is displayed.
- ② Touch [ Power off].

Sleeping



At the time of purchase, the screen turns off automatically after 1 minute with no operation. To turn off the screen manually, perform the following operation.

- ① Press  (Power switch).
The screen turns off.

NOTE

- The screen turns off automatically after 1 minute. You can change time to turn the screen off by touching  - [ Settings] - [ Display] - [Sleep].

Waking Up







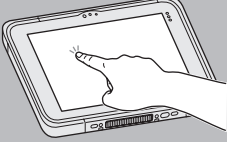
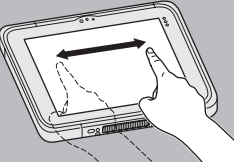
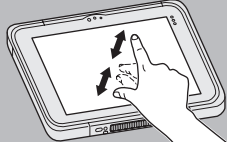

- ① Press  (power switch) until  (power indicator) lights.
- ② Release the lock using the method configured in the “Protect your phone” screen (→ page 9).

Input Operation

Screen Input Operation

Touch 	Select items or options.
Touch and hold	Open special options.
Swipe	Scroll the screen.
Flick 	Scroll the screen quickly.
Drag and drop	Move an item.
Pinch 	Zoom in or out the screen. Depending on the applications, you can also zoom in or out by double-touching the screen.

Tablet Buttons

	A1 button Starts the dashboard (under factory default conditions). When [Concealed Mode] is set to [Enabled], this enables/disables concealed mode.
	A2 button <Only for models with barcode readers> Scans barcodes (under factory default conditions). You can change the function assigned to this button using User Button Manager.  <i>Operating Instructions - Reference Manual</i> "Tablet Buttons"
	A3 button Enables security mode (under factory default conditions). You can change the function assigned to this button using User Button Manager.  <i>Operating Instructions - Reference Manual</i> "Tablet Buttons"
	Down button Decreases the volume. While using the BIOS Setup Utility, this button functions identically to the ↓ key on a keyboard. You can also change the function assignment of the button to increasing/decreasing the brightness or disable the button.
	Up button Increases the volume. While using the BIOS Setup Utility, this button functions identically to the → key on a keyboard. You can also change the function assignment of the button to increasing/decreasing the brightness or disable the button.
	Rotation lock button Enables/disables automatic screen rotation. Automatic screen rotation is enabled under factory default conditions.

Home Screen

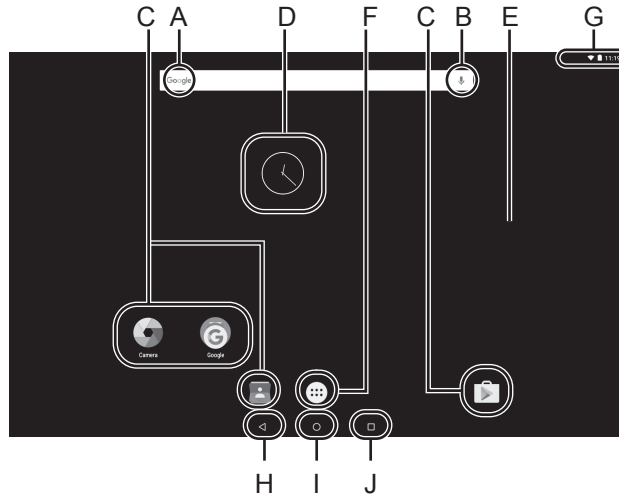

A: Search

Search the internet and this computer using Google search. You can input the search terms by using on-screen keyboard.

B: Voice search

Search the internet and this computer using Google search. You can input the search terms by speaking.

C: Application shortcuts

Open an application. You can add/remove applications shortcuts to/from the home screen.

→ *Operating Instructions - Reference Manual* “Customizing the Home Screen”

D: Widgets

The small applications on the home screen. Some widgets display the latest information (clock, calendar, weather, email, etc.) on the home screen.

→ *Operating Instructions - Reference Manual* “Customizing the Home Screen”

E: Home screen

The starting point for this computer. You can place shortcuts, widgets and other items to the home screen.

You can add, delete, and sort items on the home screen.

F: Apps

Display all applications and widgets. Touch an application/widget to open from the list.

G: Status detail

The status detail (remaining battery charge, network status, etc.) and clock are displayed. Swipe down from the top edge of the screen, and touch the header in the notification shade to display the quick settings. The quick settings display network status, remaining battery charge and other details.

When you touch [Settings], Settings application is opened.

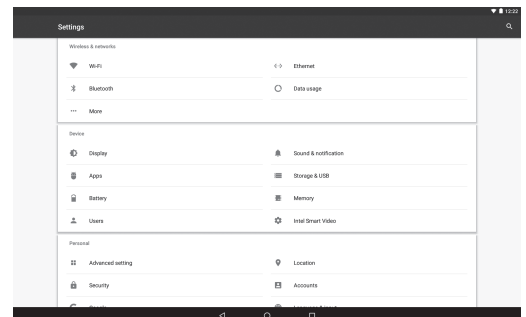

H: Back

Return to the previous screen.

I: Home

Return to the home screen.

J: Recent apps

Display the recent applications. Touch an application to open from the application list.

To remove an application from the list, flick the application left or right, or touch the [×] icon at the top right of the application window.

Handling and Maintenance

Operation environment

- Place the computer on a flat stable surface not subject to shock, vibration, and danger of dropping. Do not place the computer upright or turn it over. If the computer is exposed to an extremely strong impact, it may become damaged.
 - Operating environment
 - Temperature: Operation : -10 °C to 50 °C {14 °F to 122 °F} (IEC60068-2-1, 2)^{*1}
Storage : -20 °C to 60 °C {-4 °F to 140 °F}
 - Humidity: Operation : 30% to 80% RH (No condensation)
Storage : 30% to 90% RH (No condensation)
- Even within the above temperature/humidity ranges, operation for a long time in extreme environments, smoking nearby, or operation in places where oil is used or where there is a lot of dust will result in the product deterioration and will shorten the product life.
- ^{*1} Do not expose the skin to this product when using the product in a hot or cold environment. If the computer is wet in temperatures of 0 °C {32 °F} or below, freeze damage may occur. Make sure to dry off the computer in such temperatures.
- Do not place the computer in the following areas, otherwise the computer may be damaged.
 - Near electronic equipment. Image distortion or noise may occur.
 - In extremely high or low temperature.
 - As the computer can become hot during operation, keep it away from items that are sensitive to heat.

Handling cautions

This computer is designed to minimize shock to parts such as the LCD and the flash memory drive, but no warranty is provided against any trouble caused by shock. Be extremely careful when handling the computer.

- When carrying the computer:
 - Turn off the computer.
 - Remove all external devices, cables, Smart Cards and other protruding objects.
 - Do not drop or hit the computer against solid objects.
 - Do not grip the display part.
- When you board an airplane, take the computer with you and never put it in your checked luggage. When using the computer on airplane, follow the airline's instructions.
- When carrying a spare battery, put it in a plastic bag to protect its terminals.
- The touchscreen is designed to be used by a finger tip. Do not place any object on its surface and do not press down strongly with sharp-pointed or hard objects that may leave marks (e.g., nails, pencils and ball point pens).
- Avoid any harmful substances such as oil from getting into the touchscreen. The pointer may not work correctly.
- Be careful not to get injured by dropping or getting hit when carrying the computer.
- Use only the dedicated stylus to touch the screen. Do not place any object on its surface and do not press down strongly with sharp-pointed or hard objects that may leave marks (e.g., nails, pencils and ball point pens).
- Do not use the screen when dust or dirt (e.g., oil) is on the screen. Otherwise foreign particles on the screen/dedicated stylus can scratch the screen surface or obstruct the dedicated stylus operation.
- Use the dedicated stylus only for touching the screen. Using it for any other purpose may damage the dedicated stylus and result in scratches on the screen.

■ When the battery indicator does not light on

The battery indicator may not light on even if the AC adaptor and the battery pack are correctly connected to the computer, due to the following reasons.

- The AC adaptor's protection function may be working. In this case, pull out the AC cord and wait for more than 1 minute before reconnecting the AC cord.

■ When using peripheral devices

Follow these instructions and the *Operating Instructions - Reference Manual* to avoid any damage to the devices. Carefully read the instruction manuals of the peripheral devices.

- Use the peripheral devices conforming to the computer's specifications.
- Connect to the connectors in the correct direction.
- If it is hard to insert, do not try forcibly but check the connector's shape, direction, alignment of pins, etc.
- If screws are included, fasten them securely.
- Remove the cables when you carry the computer. Do not pull the cables forcibly.

■ Preventing your computer from unauthorized use via Wi-Fi/Bluetooth/Wireless WAN

- Before using Wi-Fi/Bluetooth/Wireless WAN, make the appropriate security settings such as data encryption.

■ Sensors





This computer is equipped with four sensors (acceleration sensor, gyro sensor, magnetic sensor, ambient light sensor), and you can use these sensors with any software that is compatible.

As the accuracy of each sensor output is dependent on the operating environment and other conditions, the results should only be used as a reference.

The acceleration sensor, gyro sensor, and magnetic sensor are located at the bottom center of the LCD. The detection results of each sensor may vary depending on the display mode, how you are holding the computer, the application software you are using, and other factors.

● Automatic brightness adjustment

The computer is equipped with an automatic brightness adjustment function that adjusts the display screen based on the ambient light sensor. You can configure the automatic adjustment function as follows.

- ① Touch  - [ Settings] - [ Display].
- ② Touch [] for [Brightness level] and turn it on.

The ambient light sensor is located at the top of the LCD and to the left of the camera.

(→ page 4 "Description of Parts")

The ambient light cannot be detected properly if this area is obstructed or dirty.

Handling and Maintenance

● Magnetic sensor

The magnetic sensor on the computer operates by detecting geomagnetism. Therefore, the magnetic sensor may not function properly and its readings may be inaccurate, especially in the following environments.

- Inside or near steel structures such as buildings or bridges
- Inside or near automobiles, or near train power lines
- Near metallic furniture or appliances
- When the AC adaptor or other peripheral devices are brought closer to the computer
- Near magnets, speakers, or other objects with strong magnetic fields

The magnetic directions indicated by the magnetic sensor may not be accurate immediately after purchase or in environments with poor magnetic fields.

In such cases, turn on the computer and move it as follows.

- ① Hold the computer so that its display side is facing the ground and level.
- ② While keeping the computer level, rotate it 90 degrees or more clockwise.
- ③ Return the computer to position ①, and rotate it 90 degrees or more counterclockwise.
- ④ Return the computer to position ①.
- ⑤ Tilt the computer 90 degrees or more to the left so that the left side of the computer tilts down.
- ⑥ Return the computer to position ①, and tilt it 90 degrees or more to the right so that the right side of the computer tilts down.

CAUTION

- Hold the computer firmly when moving it. Strong shocks from dropping the computer may result in damage.
-

Maintenance

If drops of water or other stains get on the surface of the LCD panel, wipe them off immediately. Failure to do so may result in staining.

To clean the LCD panel

Use the soft cloth. (For further information, refer to “Suggestions About Cleaning the LCD Surface” →  *Operating Instructions - Reference Manual* “Maintaining the performance of the screen”.)

To clean areas other than the LCD panel

Wipe with a soft dry cloth such as gauze. When using detergent, dip a soft cloth in water-diluted detergent and wring it thoroughly.

CAUTION

- Do not use benzene, thinner, or rubbing alcohol since it may adversely affect the surface causing discoloration, etc. Do not use commercially-available household cleaners and cosmetics, as they may contain components harmful to the surface.
- Do not apply water or detergent directly to the computer, since liquid may enter inside of the computer and cause malfunction or damage.
- Use a soft, dry cloth to wipe droplets of water from the surface of the unit. Do not use a microwave to dry the unit. Doing so will result in malfunction or damage.

Power-Saving Function

When the computer is not operated or accessed for a specified period, the power-saving function activates and the computer enters sleep mode. This function allows you to reduce power consumption when the computer is not being used while it is turned on.

The power-saving function is enabled under factory default settings. (→  *Operating Instructions - Reference Manual* “Important Battery Tips”)

- To exit sleep mode, press the  (power switch).

Dispose of Computer

■ Preparation

- Remove all peripherals (microSD memory card, etc.).
- Perform “Factory data reset” to erase the stored data.

<Only for model with Built-in Bridge Battery>

<For Europe and U.S.A./Canada>

Attention Customers

Don't remove the battery by yourself. The battery must be removed by qualified professionals. When disposing of this product, be sure to contact qualified professionals to remove the battery.

Handling and Maintenance

Attention Qualified professionals to remove the battery

Dispose of this product correctly in accordance with the local regulations after removing the battery as shown in the following procedure.

CAUTION

- Never disassemble the computer except before disposal.
- Refer to “Safety Precautions” in *OPERATING INSTRUCTIONS - Read Me First* for precautions when disposing of the computer.

- ① Turn off the computer, and disconnect the AC adaptor.
- ② Slide both latches (A) to the arrow direction, and then remove the cover.

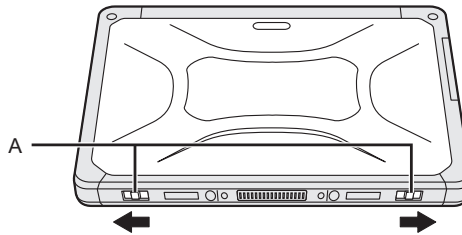

- ③ Slide both latches (B) to the arrow direction, and then remove the battery pack, and wait for about 3 minutes.

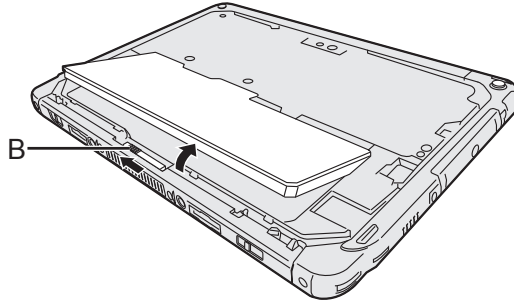

- ④ Remove the screws (10) and lift the cover.

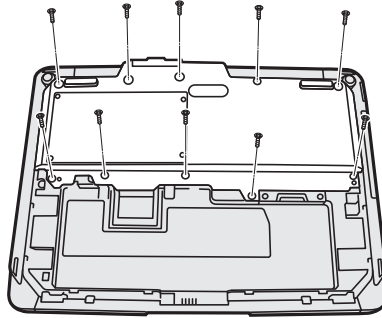

- ⑤ Pull out the built-in bridge battery in the sheet cover, and then remove the connector of the built-in bridge battery.

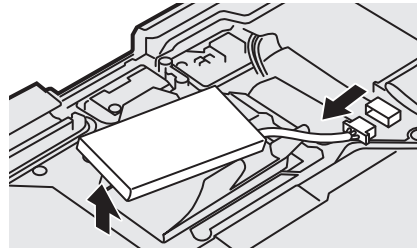
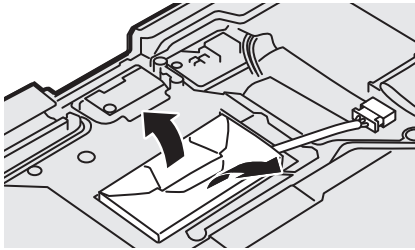



- ⑥ Insulate the connectors of the built-in bridge battery by covering them with plastic tape, for example.
- ⑦ Dispose of the battery with the cover attached correctly in accordance with the local regulation.

Troubleshooting (Basic)

Follow the instructions below when a problem has occurred. There is also an advanced troubleshooting guide in the “Reference Manual”. For a software problem, refer to the software’s instruction manual. If the problem persists, contact Panasonic Technical Support (→ page 25). You can also use the “Hardware Diagnostic” to determine whether or not there is a problem (→  *Operating Instructions - Reference Manual* “Hardware Diagnostics”).

■ Starting Up

Cannot start up. The power indicator or battery indicator is not lit.	<ul style="list-style-type: none"> ● Connect the AC adaptor. ● Insert a fully charged battery. ● Remove the battery pack and the AC adaptor, then connect them again. ● If a device is connected to the USB port, disconnect the device.
Cannot turn on the computer. The computer does not wake up from sleep.	<ul style="list-style-type: none"> ● Turn off the computer and leave it in an environment of 5 °C {41 °F} or higher temperature for about an hour, then turn on the power again.
Starting up and operation is slow.	<ul style="list-style-type: none"> ● The ambient temperature may be higher. Move this computer to the cooler place.
The date and time are incorrect.	<ul style="list-style-type: none"> ● Make the correct settings. ① Touch  - [ Settings] - [ Date & time], and set date and time. ● If the problem persists, the internal clock battery may need to be replaced. Contact Panasonic Technical Support (→ page 25). ● When the computer is connected to network, check the date and time of the server. ● The 2038 A.D. or later year will not be correctly recognized on this computer.
Cannot wake up from sleep.	<ul style="list-style-type: none"> ● In sleep mode, the AC adaptor may be disconnected. If the AC adaptor was disconnected and the battery pack was discharged in sleep mode, data not saved will be lost and the computer will not wake up.
Unknown password required at startup.	<ul style="list-style-type: none"> ● When a password is configured for DeviceManagement, the same password is configured as the BIOS supervisor password. Contact the system administrator that configured the DeviceManagement password. ● If you forgot the password, contact the system administrator or Panasonic Technical Support.
Other startup problems.	<ul style="list-style-type: none"> ● Remove all peripheral devices.



■ Shutting down

Computer does not shut down.	<ul style="list-style-type: none"> ● Remove the peripheral devices. ● Wait one or two minutes. It is not a malfunction. ● Press and hold  (Power switch) for 10 seconds or longer to turn the computer off forcibly.
------------------------------	--

■ Display

No display.	<ul style="list-style-type: none"> ● The computer entered sleep mode by the power-saving function. To resume, press the power switch.
The screen is dark.	<ul style="list-style-type: none"> ● If the brightness setting of this computer is set to automatic brightness mode, the screen brightness automatically changes depending on the ambient brightness. ● Disable automatic brightness mode and change the brightness of the screen.
There are red, green, or blue dots on the screen, or there is unevenness in colors and brightness on the screen.	<p>The following are not malfunctions.</p> <ul style="list-style-type: none"> ● Although advanced high-precision technologies are used in the production of color LCD screens, 0.002% or less of the picture elements may be dark or remain constantly lit (more than 99.998% of elements function properly). ● Due to the natural characteristics of LCD screens, you may notice unevenness in colors and brightness depending on your angle of view. Hues may also vary by product.





■ Screen Input Operation

The pointer does not work.	<ul style="list-style-type: none"> ● When using the external mouse, connect it correctly.
Cannot operate the touchscreen.	<ul style="list-style-type: none"> ● Press  (Power switch) to enter to sleep mode, then press  (Power switch) to wake up.

■ Battery Status Indicator

Blinking orange.	<ul style="list-style-type: none"> ● The battery cannot be charged temporarily. Remove the AC adaptor, then connect it again.
Lighting red.	<ul style="list-style-type: none"> ● The remaining battery charge is approximately 9 % or less. Charge the battery pack.

■ Others

No response.	<ul style="list-style-type: none"> ● Press and hold  (Power switch) until "Power off" screen is displayed and touch [OK], then press  (Power switch) to turn it on. ● If the application does not work normally, uninstall and reinstall the application. To uninstall : <ol style="list-style-type: none"> ① Touch  - [ Settings] - [ Apps]. ② Touch the application you want to uninstall, and touch [Uninstall]. ③ Uninstall the application by following the on-screen instructions.
--------------	---



Troubleshooting (Basic)

Factory Data Reset

If you need to reset the storage to the default condition, perform “Factory data reset”.

CAUTION

- Factory data reset function will return this computer to the default condition. When you reset this computer, the stored data will be erased.
Back up important data to other media before reset.

- ① Touch  - [ Settings] - [ Backup & reset] - [Factory data reset].
All the data in /mnt/sdcard folder will be erased. The data in microSD memory card inserted into microSD memory card slot will not be erased.
- ② Touch [Reset tablet].
- ③ Follow the on-screen instructions.

Specifications

This page provides the specifications for the basic model.
The specification is different according to the model number.

■ Main Specifications

CPU			Intel® Atom™ x5-Z8550 Processor (2 MB ^{*1} Cache, up to 2.4 GHz)
Video controller			SoC embedded
Memory			4 GB ^{*1}
Storage			Flash memory drive (eMMC) : 32 GB ^{*2}
Display Method			10.1 WUXGA type
Touchscreen			10 Finger touch (Capacitive)
Wi-Fi			Intel® Dual Band Wireless-AC 8260
Bluetooth ^{*3}			Version 4.2
Card Slot	microSD Memory Card Slot ^{*4}		microSDHC compatible
Interface			Type-A USB port 3.0 × 1 ^{*5} , Type-C USB port 3.1 × 1 ^{*5} , HDMI output port × 1 ^{*6} , Expansion Bus Connector, Headset Jack (Miniature jack M3, CTIA standard / Audio output: 32 Ω, Output Power 4 mW × 2, Stereo / Microphone: Monaural Input) × 1, Expansion bus connector (24 pin) × 1
Camera	Front	1920 × 1080 dots, 30 fps (Video) / 1920 × 1080 dots (Still), Array Microphone	
	Rear	1920 × 1080 dots, 30 fps (Video) / 3264 × 2448 dots (Still), With camera light	
Sensor			Ambient light sensor, Magnetic sensor, Gyro sensor, Acceleration sensor
Power Supply			AC adaptor or Battery pack
AC Adaptor ^{*7}			Input: 100 V to 240 V AC, 50 Hz/60 Hz, Output: 16 V DC, 4.06 A
Battery Pack			Li-ion 11.4 V, Minimum 2600 mAh (with CF-VZSU0QW)
Operating Time ^{*8}			Approx. 9 hours (models without wireless WAN), approx.. 7.5 hours (models with wireless WAN)
Charging Time ^{*9}			Approx. 2.5 hours
Physical Dimensions (W × D × H) (excluding projecting parts)			272 mm × 196 mm × 16.4 mm {10.71" × 7.72" × 0.65"}
Weight			Approx. 880 g {Approx. 1.95 lb.} (with CF-VZSU0QW, excluding the optional devices)
Environment	Operating	Temperature	-10 °C to 50 °C {14 °F to 122 °F} (IEC60068-2-1, 2) ^{*10}
		Humidity	30% to 80% RH (No condensation)
	Storage	Temperature	-20 °C to 60 °C {-4 °F to 140 °F}
		Humidity	30% to 90% RH (No condensation)
OS ^{*11}			Android 6.0

Specifications

■ Main Specifications

Pre-installed Software	Adobe Acrobat DC - PDF Reader, Dashboard, DeviceManagement, User Button Manager, Hardware Diagnostics, Google applications ^{*12}
------------------------	---

■ Optional Devices

Wireless WAN	LTE compatible
GPS	GPS, Glonass, SBAS ^{*13}
Type-A USB 2.0 Part	x 1
Magnetic Stripe Card Reader	x 1
Smart Card Slot	x 1
MicroSIM Card Slot	x 1
Barcode Reader	x 1
Built-in bridge battery (not replaceable)	For hot swap

- Approx. 0.5 W when the battery pack is fully charged (or not being charged) and the computer is OFF.
<When using with 115 V AC>
Even when the AC adaptor is not connected to the computer, power is consumed (Max. 0.3 W) simply by having the AC adaptor plugged into an AC outlet.

^{*1} 1 MB = 1,048,576 bytes / 1 GB = 1,073,741,824 bytes

^{*2} 1 MB = 1,000,000 bytes / 1 GB = 1,000,000,000 bytes. Your operating system or some application software will report as fewer GB.

^{*3} Does not guarantee operation of all Bluetooth peripherals.

^{*4} Operation has been tested and confirmed using Panasonic microSD Memory Card with a capacity of up to 2 GB and Panasonic microSDHC Memory Card with a capacity of up to 32 GB. Operation on other microSD equipment is not guaranteed.

^{*5} Does not guarantee operation of all USB-compatible peripherals.

^{*6} Compatibility with all external displays that support HDMI is not guaranteed.

^{*7} <Only for North America>

The AC adaptor is compatible with power sources up to 240 V AC adaptor. This computer is supplied with a 125 V AC compatible AC cord.

20-M-1-1

^{*8} Measurement results are based on Panasonic testing methods. Measured at LCD brightness: 150 cd/m², browsing web site via wi-fi every 20 seconds.

Varies depending on the usage conditions, or when an optional device is attached.

^{*9} Varies depending on the usage conditions. When charging completely discharged battery pack, it may take a long time.

^{*10} Do not expose the skin to this product when using the product in a hot or cold environment.

(→ OPERATING INSTRUCTIONS - Read Me First)

When using in hot or cold environment, some peripherals and battery pack may fail to work properly.

Check the operation environment of the peripherals.

Using this product continuously in a hot environment will shorten the product life. Avoid use in these types of environments.

^{*11} An OS that has been installed at the time of purchase can be supported.

^{*12} Depending on the model, some Google applications may be installed.

^{*13} Only for model with GPS.

LIMITED WARRANTY

For U.S.A.

Panasonic System Communications Company of North America (PSCNA)
Computer Products - Worldwide Warranties

Section 1: Limited Warranty - Hardware

PSCNA, referred hereafter as “Panasonic” will repair the products listed below with new or rebuilt parts, free of charge in a Global Panasonic designated service location for the period specified below from the date of original purchase in the event of a defect in materials or workmanship. These warranties are extended solely to the original purchaser. A purchase receipt or other proof of date of original purchase will be required before warranty performance is rendered.

- Laptop PC (CF-##) – 3 Years
- Tablet PC (FZ-##) – 3 Years
- Ultra-Mobile (CF-U#/CF-H# Series) – 3 Years
- PDRC - LCD & Keyboard Assembly – 3 Years

Battery Warranty

Batteries supplied with the product are covered under the warranty for one (1) year from date of purchase, except as excluded in Section 3. Batteries purchased separately are covered under the warranty for one (1) year from the date of purchase. A replacement battery furnished under the product warranty is covered for the remaining period of the one year warranty on the original or purchased battery.

Optional: Panasonic “Protection Plus” Warranty

Any unit for which the Panasonic “Protection Plus” warranty has been purchased will receive additional coverage for any failure that occurs due to accidental damage. All other terms and conditions of the standard warranty apply and this additional coverage will exist for the duration of the standard warranty period of the unit. If an extended Protection Plus warranty program is purchased, coverage is extended to the end of the last year of extended coverage purchased.

This warranty does not cover failures or defects that are caused by fire, intentional acts, loss, theft, improper maintenance, modification or service by anyone other than the Panasonic National Service Center or a Panasonic Authorized Service Provider, or damage that is attributable to acts of God. Cosmetic damage that does not affect functionality is not covered. Cosmetic damage on units with hardware failures will be repaired in accordance with the warranty terms. This warranty is extended solely to the original purchaser on the unit serial number for which it was purchased. Complete unit replacement fulfills the full obligation and is at the discretion of Panasonic and is limited to once during the coverage term. Maximum benefit is limited to one replacement per coverage year of the Motherboard, LCD, Storage Drive, and Keyboard.

LIMITED WARRANTY

Wireless Module Warranty

Panasonic approved wireless modems installed in Panasonic brand computers and integrated by Panasonic or an Authorized Panasonic Wireless Integrator are covered under the warranty for the remaining warranty period of the device in which the modem is installed. For devices with less than three (3) months remaining on the unit warranty, the wireless modem will be covered for a period of three (3) months from the date of installation of the modem, covering only modem replacement or modem installation related issues.

All modems must be approved by the wireless carrier prior to use. Any use or attempted use of a wireless modem not approved and activated by the carrier for use on their network is strictly prohibited and is not sanctioned or warranted by Panasonic and may result in legal action. In addition, all modems must be approved by Panasonic as compatible with the device hardware before installation or use.

Panasonic's sole responsibility for the warranty or technical support of the software required to install or operate the modem is defined in Section 2 (Limited Software Warranty). Any attempted software installation by anyone other than a Panasonic Authorized Wireless Integrator is not covered under warranty and may result in service charges to re-image or replace the hard drive.

Installation or attempted installation by any party other than Panasonic or an Authorized Panasonic Wireless Integrator is strictly not covered under the warranty and may void the computer warranty if damage results.

Options and Accessories Warranties

The below listed Panasonic brand or supplied options and accessories are covered under this limited warranty for the period specified from the date of purchase or as specifically stated:

- AC Adaptor / Power Cord – 3 Years
- Memory Expansion Card (Panasonic Brand) – 3 Years
- Car Mount - Docking Station PCB or Vehicle Docking Station – 3 Years
- Desktop Port Replicator, I-O Box, Docking Cradle (like CF-U1) – 3 Years
- Antenna Pass-through Cable – 3 Years
- Backlit or Full-sized keyboard – 3 Years or assumes warranty of the unit in which it is installed
- Integrated Panasonic supplied options and kits including, but not limited to Wireless Modems, Media Bay Drives (Floppy, CD, DVD, Combo), Camera, GPS, Bluetooth, Smartcard Reader, Magnetic Card Reader, Barcode Scanner, and Fingerprint Reader - 3 Years or assumes warranty period of the unit in which it is installed provided the integration was performed by Panasonic or an Authorized Integrator.
- Hard Drive / Solid State Drive (Internal) – 3 Years
- Separately purchased 2nd Hard Drive – 1 Year
- External USB Drives (CD / DVD / Floppy / Hard Drive) – 1 Year
- Optional Battery – 1 Year
- Battery Charger / Multi-Bay Battery Charger – 1 Year
- Stylus Pens, Digitizer & Standard – 90 Days (physical damage excluded)

Section 2 - Limited Warranty - Software

Panasonic warrants to you only that the disk(s) or other media on which the Programs are furnished will be free from defects in material and workmanship under normal use for a period of sixty (60) days from the date of delivery thereof to you, as evidenced by your purchase receipt.

This is the only warranty Panasonic makes to you. Panasonic does not warrant that the functions contained in the Programs will meet your requirements or that the operation of the Programs will be uninterrupted or error free. Panasonic shall have no obligation for any defects in the disk(s) or other media on which the Programs are furnished resulting from your storage thereof, or for defects that have been caused by operation of the disk(s) or other media

Panasonic's entire liability and your exclusive remedy under this warranty shall be limited to the replacement, in the United States or other Panasonic designated location, of any defective disk or other media which is returned to Panasonic's Authorized Service Center, together with a copy of the purchase receipt, within the aforesaid warranty period.

Section 3 - Limited Warranty Exclusions - Specifically excluded from the warranty are:

- All consumable items; such as screen protection films, logo badges, labels, cleaning cloths, carry cases, manuals, cables, straps, belts, holsters, tethers, and harnesses and any other options and accessories not listed above or covered under a separate warranty.
- Failures related to the product operating system, hard drive or solid state drive image, software setup, software program, virus, other program(s) or file(s) on any drive or in any computer memory location.
- Failures due to BIOS settings or changes, as well as any cosmetic or physical damage to the unit.
- Any unit or device with a missing or altered model number or serial number label
- Cosmetic damage or any damage which occurs in shipment
- Failures which are caused by products not supplied by Panasonic
- Failures which result from alteration, accident, misuse, introduction of liquid or other foreign matter into the unit, abuse, neglect, installation, maladjustment of consumer controls, improper maintenance or modification, use not in accordance with product use instructions
- Failures due to service by anyone other than a Panasonic Authorized Service Provider
- Failures caused by improper installation of options or accessories or due to integration by any company other than Panasonic or a Panasonic Authorized Integrator
- Damage, failure, or loss due to the unit being stolen, lost, misplaced, or used by anyone other than the original purchaser
- Damage that is attributable to acts of God

LIMITED WARRANTY

This limited warranty only covers failures due to defects in materials or workmanship which occur during normal use. If a unit is sent to a Panasonic Authorized Service Center and no hardware failure is found, the customer will be billed for labor to correct a software issue or reimage the hard drive plus shipping and applicable administrative fees at the current rates set by the service provider.

THIS PRODUCT IS NOT INTENDED FOR USE AS OR PART OF NUCLEAR EQUIPMENT/SYSTEMS, AIR TRAFFIC CONTROL EQUIPMENT/SYSTEMS, OR AIRCRAFT COCKPIT EQUIPMENT/SYSTEMS^{*1}. PANASONIC WILL NOT BE RESPONSIBLE FOR ANY LIABILITY RESULTING FROM THE USE OF THIS PRODUCT ARISING OUT OF THE FOREGOING USES.

^{*1} AIRCRAFT COCKPIT EQUIPMENT/SYSTEMS include class 2 Electronic Flight Bag (EFB) Systems and Class 1 EFB Systems when used during critical phases of flight (e.g., during take-off and landing) and/or mounted onto the aircraft. Class 1 EFB Systems and 2 EFB Systems are defined by FAA: AC (Advisory Circular) 120-76A or JAA: JAA TGL (Temporary Guidance Leaflets) No. 36.

Other Limits and Exclusions: There are no other express warranties except as listed above.

PANASONIC SHALL NOT BE LIABLE FOR LOSS OF DATA OR OTHER INCIDENTAL OR CONSEQUENTIAL DAMAGES RESULTING FROM THE USE OF THIS PRODUCT, OR ARISING OUT OF ANY BREACH OF THIS WARRANTY. ALL EXPRESS AND IMPLIED WARRANTIES, INCLUDING THE WARRANTIES OF MERCHANTABILITY AND FITNESS FOR A PARTICULAR PURPOSE ARE LIMITED TO THE APPLICABLE WARRANTY PERIOD SET FORTH ABOVE. Some states do not allow the exclusion or limitation of incidental or consequential damages, or limitations on how long an implied warranty lasts, so the above limitations or exclusions may not apply to you.

This limited warranty gives you specific legal rights, and you may also have other rights which vary from state to state.

For technical support or to arrange for service on your Panasonic computer product, call our toll-free hotline at 1-855-PSC-TECH (855-772-8324).

DIAL TOLL FREE: 1-855-PSC-TECH (855-772-8324)
Web Site : www.panasonic.com/toughbook

For Canada

PANASONIC COMPUTER AND PERIPHERALS LIMITED WARRANTY

Coverage – Panasonic Canada Inc. ("PCI") warrants to you, the first end user customer, this computer product (excluding software media), when purchased from PCI or from a PCI authorized reseller, to be free from defects in materials and workmanship under normal use, subject to the terms set forth below, during the period of warranty coverage specified.

Scope of Coverage	Period of Coverage	Type of Failure Coverage
<ul style="list-style-type: none"> • Laptop Computers (except Battery) and AC Adaptor • Factory/PCI installed options including Wireless WAN, GPS, Bluetooth, Finger print reader, Backlit keyboard, Memory Card and Media Bay Drives (Floppy, CD/DVD) • Mobile Wireless Display • PDRC – LCD and Keyboard Assemblies • Port Replicator 	Three (3) Years from Date of Original End User Customer Purchase	Defective Materials or Workmanship
<ul style="list-style-type: none"> • Hand-held Computers • Battery • Battery charger • Auto Adaptor • External USB Drives 	One (1) Year from Date of Original End User Customer Purchase	Defective Materials or Workmanship
<ul style="list-style-type: none"> • Digitizer pen or stylus 	Ninety (90) Days from Date of Original End User Customer Purchase	Defective Materials or Workmanship
<ul style="list-style-type: none"> • All consumable items including protection film, cleaning cloth, carry case, tether and harness 	No Coverage	

Remedy – In the event of a warranty claim, contact PCI's representatives within the applicable warranty period, identifying the nature of the defect claimed, at 1-800-668-8386 between 9:00 A.M. and 5:00 P.M., Eastern Time Zone, Mon. – Fri. (excluding holidays) for instructions on how to obtain service. A purchase receipt or other proof of date of original purchase is required before warranty service is performed. Defective parts covered by this Limited Warranty will be repaired or replaced with new or comparable rebuilt parts on an exchange basis. Warranty replacement or repair is subject to the terms of this Limited Warranty for the balance of the original period of warranty coverage.

No Coverage – This Limited Warranty does not cover products purchased outside Canada. Neither does it cover damage to, failure of, or defects in a product or accessory through mishandling, improper installation, abnormal use, misuse, neglect, accident, introduction of liquid or other foreign matter into the product, alteration or servicing by anyone not authorized by PCI, or act of God. THIS PRODUCT IS NOT INTENDED FOR USE AS, OR AS PART OF, NUCLEAR EQUIPMENT/SYSTEMS, AIR TRAFFIC CONTROL EQUIPMENT/SYSTEMS, OR AIRCRAFT COCKPIT EQUIPMENT/SYSTEMS². PANASONIC WILL NOT BE RESPONSIBLE FOR ANY LIABILITY RESULTING FROM THE USE OF THIS PRODUCT ARISING OUT OF THE FOREGOING USES.

² AIRCRAFT COCKPIT EQUIPMENT/SYSTEMS include Class2 Electrical Flight Bag (EFB) Systems and Class1 EFB Systems when used during critical phases of flight (e.g., during take-off and landing) and/or mounted on to the aircraft. Class1 EFB Systems and 2 EFB Systems are defined by FAA: AC (Advisory Circular) 120-76A or JAA: JAA TGL (Temporary Guidance Leaflets) No.36

IF YOU SHIP THE PRODUCT FOR WARRANTY SERVICE

Carefully pack the product, preferably in the original carton. Include details of defect claimed and proof of date of original purchase. No liability is assumed for loss or damage to the product while in transit, if you chose your own transportation carrier.

LIMITED WARRANTY

SOFTWARE MEDIA LIMITED WARRANTY

Coverage – PCI warrants to you, the first end user customer, that the disk(s) or other media on which software program(s) is/are supplied will be free from defects in materials and workmanship under normal use in Canada for a period of sixty (60) days from date of receipt as evidenced by your purchase receipt for your Panasonic Computer product.

THIS IS THE ONLY WARRANTY THAT PCI MAKES RESPECTING THE SOFTWARE MEDIA. PCI does not warrant the software. Please refer to the software licensor's written warranty (accompanying the copy of the software) for any software warranty claim.

Claim Procedure – In the event of a defect in material or workmanship in the media during the sixty (60) day warranty period, and you return it, transportation costs prepaid, to Panasonic Canada Inc., Computer Products Marketing, 5770 Ambler Drive, Mississauga, Ontario L4W 2T3, within the warranty period, together with a copy of your purchase receipt, and an explanation of the suspected defect, PCI will replace in Canada the defective disk(s) or other media.

Remedy – PCI's entire liability, and your only remedy for any breach of this software media warranty is limited to replacement of the media only. It does not cover any other damages, including, but not limited to, loss of use or profit loss, or special, indirect or consequential damages, or other claims, whether or not of similar character.

No Coverage – This limited warranty does not apply if the disk(s) or other media has been used in other than a Panasonic product, or in environmental conditions other than those specified by PCI or the manufacturer, or if subjected to misuse, neglect, mishandling, modification or attempted modification of the program, or if damaged by accident or act of God. PCI is not responsible for damage to or loss of any program, data or removable storage media.

GENERAL

NO OTHER WARRANTIES – PCI DISCLAIMS ALL OTHER WARRANTIES, EITHER EXPRESS OR IMPLIED, INCLUDING, BUT NOT LIMITED TO, IMPLIED WARRANTIES OF MERCHANTABILITY AND FITNESS FOR A PARTICULAR PURPOSE, WITH RESPECT TO THE SOFTWARE, SOFTWARE MEDIA, COMPUTER PRODUCT, OPTIONS AND ACCESSORIES.

NO LIABILITY FOR CONSEQUENTIAL DAMAGES – IN NO EVENT SHALL PCI BE LIABLE FOR ANY SPECIAL, INDIRECT OR CONSEQUENTIAL DAMAGES ARISING FROM ANY BREACH OF THE LIMITED WARRANTIES SET OUT IN THIS DOCUMENT, OR FROM THE USE OF THE COMPUTER PRODUCT, INCLUDING, WITHOUT LIMITATION, LOSS OF DATA, BUSINESS, PROFIT OR GOODWILL.

IN ANY EVENT, PCI'S MAXIMUM LIABILITY FOR ANY BREACH SHALL NOT EXCEED THE AMOUNT ACTUALLY PAID BY YOU FOR THE COMPUTER PRODUCT.

NO ACTION, REGARDLESS OF ITS BASIS, MAY BE BEGUN AGAINST PCI MORE THAN TWO (2) YEARS AFTER THE CAUSE OF ACTION AROSE.

Statutory Warranties – Some jurisdictions do not allow these limitations or exclusions, so they may not apply to you.

LIMITED WARRANTY (GARANTIE LIMITÉE)

Pour le Canada

GARANTIE LIMITÉE – ORDINATEURS ET PÉRIPHÉRIQUES PANASONIC

Couverture – Panasonic Canada Inc. (« PCI ») garantit à l'acheteur original que ce produit informatique (à l'exclusion des supports des logiciels) est, au moment de sa vente par PCI ou d'un revendeur agréé par PCI, exempt de défauts de pièces et de fabrication dans les conditions normales d'utilisation, et ce, pendant la période de couverture de la garantie, sous réserve des modalités décrites ci-dessous.

Éléments couverts	Durée de couverture	Type de couverture
<ul style="list-style-type: none">• Ordinateurs blocs-notes (sauf batteries) et adaptateur secteur• Options installées en usine/par PCI incluant : WAN sans fil, GPS, Bluetooth, lecteur d'empreintes digitales, clavier rétroéclairé, carte mémoire et lecteurs (disquettes, CD/DVD)• Écran mobile sans fil• Ensembles PDRC – ACL et clavier• Duplicateur de port	Trois (3) ans à partir de la date d'achat original.	Défauts de pièces et de fabrication
<ul style="list-style-type: none">• Ordinateurs de poche• Batterie• Chargeur de batterie• Adaptateur pour voiture• Périphériques USB	Un (1) an à partir de la date d'achat original.	Défauts de pièces et de fabrication
<ul style="list-style-type: none">• Stylo pointeur standard ou pour numériseur graphique	Quatre-vingt-dix (90) jours à partir de la date d'achat original.	Défauts de pièces et de fabrication
<ul style="list-style-type: none">• Tous les articles consommables incluant les pellicules protectrices, chiffons de nettoyage, étuis de transport, longues et sangles	Aucune couverture	

Recours – Pour obtenir des informations sur la marche à suivre dans le cas où une réclamation en vertu de la garantie deviendrait nécessaire, communiquez par téléphone avec un représentant de PCI au 1-800-668-8386, entre 9h00 et 17h00 (heure de l'Est) du lundi au vendredi (sauf les jours fériés), avant l'échéance de la garantie applicable, en prenant soin d'identifier la nature de la défaillance.

Un reçu ou toute autre pièce justificative de la date d'achat original sera exigé avant toute réparation. Toute pièce défectueuse couverte par la présente garantie limitée sera réparée ou remplacée par une pièce neuve ou remise à neuf. Le remplacement ou la réparation sera fait conformément aux modalités de la présente garantie limitée pendant la durée restante de la période originale de la garantie.

Produits non couverts – La présente garantie limitée ne couvre pas les produits achetés à l'extérieur du Canada. Elle ne couvre pas non plus les dommages, la défaillance ou les défauts attribuables à une manutention inadéquate, une mauvaise installation, une utilisation anormale ou abusive, de la négligence, un accident, un déversement ou la pénétration d'un objet étranger, une modification, un cas fortuit ou une réparation effectuée par une personne non agréée par PCI.

CÉ PRODUIT N'EST PAS DESTINÉ À ÊTRE UTILISÉ, EN TOUT OU EN PARTIE, COMME SYSTÈME/ÉQUIPEMENT NUCLÉAIRE, SYSTÈME/ÉQUIPEMENT DE CONTRÔLE DU TRAFFIC AÉRIEN OU SYSTÈME/ÉQUIPEMENT DE POSTE DE PILOTAGE D'AVION³. PANASONIC DÉCLINE TOUTE RESPONSABILITÉ CONCERNANT L'UTILISATION DE CE PRODUIT DANS LES CAS SUSMENTIONNÉS.

³ Les SYSTÈMES/ÉQUIPEMENTS DE POSTE DE PILOTAGE D'AVION sont dotés de systèmes OEPP (organiseur électronique de poste de pilotage) de classe 2 et de classe 1 utilisés pendant des phases critiques de vol (par exemple, pendant le décollage et l'atterrissage) et/ou montés sur l'avion. Les systèmes OEPP de classe 1 et de classe 2 sont définis par le circulaire d'information FAA: AC (Advisory Circular) 120-76A ou le feuillet n° 36 JAA: JAA TGL (Temporary Guidance Leaflets) No 36.

EXPÉDITION DU PRODUIT POUR SERVICE SOUS GARANTIE

Emballer soigneusement le produit, de préférence dans son emballage d'origine. Joignez une description de la défaillance de même qu'une pièce justificative de la date d'achat. Panasonic Canada Inc. ne peut être tenue responsable pour tout dommage ou perte subi pendant le transport si vous avez choisi le transporteur.

LIMITED WARRANTY (GARANTIE LIMITÉE)

GARANTIE LIMITÉE – SUPPORTS DES LOGICIELS

Couverture – Panasonic Canada Inc. (« PCI ») garantit à l'acheteur original que la ou les disquettes ou tout autre support sur lequel le ou les programmes sont fournis sont exempts de défauts de pièces et de fabrication dans des conditions normales d'utilisation au Canada, et ce, pour une période de soixante (60) jours suivant la date de réception indiquée sur la preuve d'achat.

LA PRÉSENTE GARANTIE EST LA SEULE OFFERTE PAR PCI COUVRANT LES SUPPORTS DE LOGICIELS. PCI ne garantit pas les logiciels. Reportez-vous à la garantie écrite du concédant de licence d'utilisation du logiciel (qui accompagne la copie du logiciel) pour toute réclamation en vertu de la garantie.

Réclamation – marche à suivre – Panasonic Canada Inc. remplacera toute disquette ou support défectueux si l'article en question est retourné, port payé, à son service de Marketing – produits informatiques, 5770 Ambler Drive, Mississauga (Ontario) L4W 2T3, dans les soixante (60) jours suivant la date d'achat original. Joignez à votre envoi une pièce justificative de votre achat et une description du problème.

Recours – La responsabilité de PCI - et votre seul recours - dans le cas de toute défaillance couverte par la garantie sur ce support de logiciel est limitée au seul remplacement du support. Elle ne couvre aucun autre dommage, y compris, mais non exclusivement, la perte d'usage ou de profits, ni aucun dommage spécial, indirect ou consécutif, ni aucune autre réclamation de nature similaire ou autre.

Produits non couverts – La présente garantie limitée ne s'applique pas si la ou les disquettes ou autre support ont été utilisés dans un produit d'une marque autre que Panasonic ou dans des conditions environnementales autres que celles spécifiées par PCI ou le fabricant, ou soumis à une mauvaise utilisation, à la négligence, à une manutention inadéquate ou encore si le programme a été modifié ou subi une tentative de modification ou des dommages attribuables à un accident ou à un cas fortuit. De plus, PCI n'assume aucune responsabilité pour toute perte de, ou tout dommage à, un programme, des données ou un support de sauvegarde amovible.

GÉNÉRALITÉS

PCI NE RECONNAÎT AUCUNE AUTRE GARANTIE, EXPLICITE OU IMPLICITE, Y COMPRIS, MAIS NON EXCLUSIVEMENT, LES GARANTIES IMPLICITES DE VALEUR COMMERCIALE ET D'UTILITÉ À UNE FIN QUELCONQUE, À L'ÉGARD DU LOGICIEL, SUPPORTS DE LOGICIELS, PRODUITS INFORMATIQUES, PÉRIPHÉRIQUES ET ACCESSOIRES.

SOUS AUCUNE CIRCONSTANCE PCI NE POURRA ÊTRE TENUE RESPONSABLE DES DOMMAGES SPÉCIAUX, INDIRECTS OU CONSÉCUTIFS ATTRIBUABLES À UN MANQUEMENT AUX GARANTIES LIMITÉES DÉCRITES DANS LE PRÉSENT DOCUMENT OU À L'UTILISATION DU PRODUIT INFORMATIQUE, Y COMPRIS, SANS RESTRICTION, LA PERTE DE DONNÉES, D'AFFAIRES, D'ACHALANDAGE OU DE PROFIT.

DANS TOUS LES CAS, LA RESPONSABILITÉ MAXIMALE DE PCI POUR TOUT MANQUEMENT NE POURRA EXCÉDER LE PRIX DE VENTE DU PRODUIT INFORMATIQUE.

AUCUNE RÉCLAMATION, SANS ÉGARD À SES MOTIFS, NE POURRA ÊTRE FAITE AUPRÈS DE PCI PLUS DE DEUX (2) ANS APRÈS LES FAITS INVOQUÉS À LA BASE D'UNE TELLE RÉCLAMATION.

Garantie statutaires – Certaines juridictions interdisent de telles limitations ou exclusions; aussi, pourraient-elles ne pas s'appliquer.

For Australia

Personal / Notebook Computers - 36 Month Warranty from Date of Purchase

1. Subject to the conditions of this warranty Panasonic or its Authorised Service Centre will perform necessary service on the product without charge for parts or labour, if in the opinion of Panasonic, the product is found to be faulty within the warranty period.
2. This warranty only applies to Panasonic products purchased in Australia and sold by Panasonic Australia or its Authorised Distributors or Dealers and only where the products are used and serviced within Australia or its territories. Warranty cover only applies to service carried out by a Panasonic Authorised Service Centre and only if valid proof of purchase is presented when warranty service is requested.
3. This warranty only applies if the product has been installed and used in accordance with the manufacturer's recommendations (as noted in the operating instructions) under normal use and reasonable care (in the opinion of Panasonic). The warranty covers normal use only.
4. Toughbook/Toughpad accessories as packed in the original box such as (stylus, pens, AC charger, combo drive, etc) are covered in warranty for 12 months from the date of purchase.
5. Batteries as packed in the original box are covered in warranty for 6 months from the date of purchase. A battery is considered good if it maintains 50% of its charge capacity during the warranty period.
6. Additional Accessories sold separate to the main Toughbook/Toughpad box are covered in warranty for 12 months.
7. Consumables sold separate to the main Toughbook/Toughpad box are covered in warranty for 6 months.
8. This warranty does not cover any of the following:
 - **No Fault Found (NFF)**; any costs incurred where it is found that the Toughbook/Toughpad is functioning normally ("No Fault Found"). Panasonic reserves the right to charge the logistics cost and inspection fee for every NFF case directly to the customer.
 - **Negligence, abuse, misuse**; Abuse or misuse in respect of the Toughbook/Toughpad including but not limited to: damage, malfunction or failure resulting from use of incorrect voltages, incorrect installation, accident, misuse, neglect, buildup of dirt or dust, abuse, maladjustment of customer controls, mains supply problems, thunderstorm activity, infestation by insects or vermin, tampering or repair by unauthorised persons (including unauthorised alterations), exposure to abnormally corrosive conditions or any foreign object or matter having entered the product.
 - **Tolerance on LCD defect**; The Warranty excludes 3 or less faulty pixels on screen.
 - **Wear and Tear**; The cost of remedying or making good solely due to:
 - Wear and Tear, gradual deterioration or oxidisation, gradually developing defects, cracks, flaws or fractures;
 - Scratching or chipping of any surfaces.
 - **Data**:
 - Loss of or damage to Internal Data. It is the customer's responsibility to backup all data from the hard disk drive before sending equipment for repair. If a problem is related to the HDD or SSD, or the HDD or SSD has to be replaced, Panasonic will only reload the factory pre-installed software for the product onto the replacement drive.
 - Loss of or damage to External Data carrying material and the value to you of data stored on your Toughbook or Toughpad device. External data carrying materials and any computer program or data information recorded thereon unless stated above.
 - Software and Settings; the costs of rectifying programming errors or design defects in software. The maladjustment of consumer controls such as function settings.
9. This warranty does not cover the following items unless the fault or defect existed at the time of purchase: Software.
10. To claim warranty service, when required, you should: Check the Panasonic web site for latest warranty contact. Prepare purchase receipt as proof of purchase date and system serial number which will be required by the Authorised Service Centre.
11. The Warranty includes the repair or exchange of faulty parts within the product with items that are functionally equivalent to that as originally supplied or better – including new or refurbished parts or units – solely at Panasonic's discretion.
12. Panasonic will arrange free pick up and return for approved warranty repairs within 50km of capital city locations. Please ensure your unit is properly packed for return to the service location.

LIMITED WARRANTY (GARANTIE LIMITÉE)

13. The warranties hereby conferred do not extend to, and exclude, any costs associated with the installation, de-installation or re-installation of a product, including costs related to the mounting, de-mounting or remounting of any screen, (and any other ancillary activities), delivery, handling, freighting, transportation or insurance of the product or any part thereof or replacement of and do not extend to, and exclude, any damage or loss occurring by reason of, during, associated with, or related to such installation, de-installation, re-installation or transit.

In addition to your rights under this warranty, Panasonic products come with consumer guarantees that cannot be excluded under the Australian Consumer Law. If there is a major failure with the product, you can reject the product and elect to have a refund or to have the product replaced or if you wish you may elect to keep the goods and be compensated for the drop in value of the goods. You are also entitled to have the product repaired or replaced if the product fails to be of acceptable quality and the failure does not amount to a major failure.

If there is a major failure in regard to the product which cannot be remedied then you must notify us within a reasonable period by contacting the Panasonic Customer Care Centre. If the failure in the product is not a major failure then Panasonic may choose to repair or replace the product and will do so in a reasonable period of time from receiving notice from you.

THIS PRODUCT IS NOT INTENDED FOR USE AS, OR AS PART OF, NUCLEAR EQUIPMENT/SYSTEMS, AIR TRAFFIC CONTROL EQUIPMENT/SYSTEMS, OR AIRCRAFT COCKPIT EQUIPMENT/SYSTEMS⁴. PANASONIC WILL NOT BE RESPONSIBLE FOR ANY LIABILITY RESULTING FROM THE USE OF THIS PRODUCT ARISING OUT OF THE FOREGOING USES.

⁴ AIRCRAFT COCKPIT EQUIPMENT/SYSTEMS include class 2 Electronic Flight Bag (EFB) Systems and Class 1 EFB Systems when used during critical phases of flight (e.g., during take-off and landing) and/or mounted onto the aircraft. Class 1 EFB Systems and 2 EFB Systems are defined by FAA: AC (Advisory Circular) 120-76A or JAA: JAA TGL (Temporary Guidance Leaflets) No. 36.

THIS WARRANTY CARD AND THE PURCHASE DOCKET
(OR SIMILAR PROOF OF PURCHASE)
SHOULD BE RETAINED BY THE CUSTOMER AT ALL TIMES

If you require assistance regarding warranty conditions or any other enquiries, please visit the **Panasonic Australia** website <http://www.panasonic.com/au/support.html> or contact by phone on **1300 132 463**

Panasonic Australia Pty. Limited

ACN 001 592 187 ABN 83 001 592 187
Innovation Road, Macquarie Park NSW 2113
www.panasonic.com.au

PRO-031-F37 Issue: 4.0

01-06-2015

Standard Limited Warranty

For Europe

Panasonic System Communications Company Europe

Panasonic System Communications Company Europe (referred to as “Panasonic”) will repair this product (other than software, which is treated in a different section of this warranty) with new or refurbished parts, from the date of original purchase in the event of a defect in materials or workmanship. This warranty only applies to new Panasonic Toughbooks purchased in the EEA and Switzerland and Turkey.

Panasonic (or its authorised Service Provider) target to repair your equipment within 48 hours from its receipt in our service centre.

Additional charges may apply for shipment to countries outside of the European Union. Panasonic will use all reasonable endeavours to ensure this service.

This warranty only covers failures due to defects in materials or workmanship which occur during normal use for the applicable Service Agreement Period listed below. In the event that any product (or part thereof) is replaced, Panasonic shall transfer ownership of the replacement product (or part) to the customer and the customer shall transfer ownership of the replaced product (or part) to Panasonic.

Service Agreement Period - from original date of purchase

- Toughbooks (and every accessory included in the original packaging except the battery) - 3 years
- Toughpads (and every accessory included in the original packaging except the battery) - 3 years
- Accessories included in the original package - 3 years
- Additional peripherals manufactured by Panasonic (including media bay devices such as CD-Rom drives) - 1 year
- Batteries - 6 months. Panasonic Warranty covers the battery for six months. A battery is considered good if it maintains 50 % of its charge capacity during the warranty period. If a battery is returned under this contract and testing determines that it has charge capacity greater than 50 %, the battery will be returned with an invoice for the retail purchase price of a new battery.

This warranty is extended solely to the original purchaser. A purchase receipt or other proof of date of original purchase will be required before warranty performance is rendered.

Standard Limited Warranty

Limits and Exclusions:

This warranty does not cover and shall be void for:

- Broken or cracked LCD screen.
- Defective pixel in notebook displays and LCD screens within 0.002 %
- Damage that is attributable to fire, theft or acts of God.
- Damage caused by environmental influences (electrical storms, magnetic fields etc.).
- Damage which has not been caused during normal operation
- Repair of damage that is cosmetic only or does not affect product functionality such as wear and tear, scratches and dents.
- Failures caused by products not supplied by Panasonic.
- Failures resulting from alteration, accidental damage, casualty, misuse, abuse or neglect.
- Introduction of liquid or other foreign matter into the unit.
- Improper installation, operation or maintenance.
- Improper connections with peripherals.
- Maladjustment of consumer controls such as function settings.
- Modification or service by anyone other than Panasonic or its approved Service Providers.
- Products used as short term rental or leased equipment.
- Products whose serial number has been removed making the unit warranty condition impossible to clearly determine.

THIS PRODUCT IS NOT INTENDED FOR USE AS, OR AS PART OF, NUCLEAR EQUIPMENT/SYSTEMS, AIR TRAFFIC CONTROL EQUIPMENT/SYSTEMS, OR AIRCRAFT COCKPIT EQUIPMENT/SYSTEMS. PANASONIC WILL NOT BE RESPONSIBLE FOR ANY LIABILITY RESULTING FROM THE USE OF THIS PRODUCT ARISING OUT OF THE FOREGOING USES.

There are no other express warranties except as listed above.

We strongly recommend that customers backup their data before sending back their unit to an Authorised Service Provider.

Panasonic shall not be liable for loss of data or other incidental or consequential damages resulting from the use of this product, or arising out of any breach of this warranty. All express and implied warranties, including the warranties of satisfactory quality and fitness for a particular purpose are limited to the applicable warranty period set forth above. Panasonic shall not be liable for any indirect, special or consequential loss or damage (including without limitation any loss of profits) arising from the use of this product or for any breach of this warranty.

This limited warranty gives you specific legal rights, and you may have other rights that vary from country to country. You must consult the applicable country laws for a full determination of your rights. This limited warranty is in addition to, and does not affect any rights arising out of any contract of sale or by statute.

Panasonic System Communications Company Europe

Data Storage Media

Data Storage Media is the media on which the Operating System, drivers and programs originally installed by Panasonic on the main unit are stored. This media is originally provided with the unit.

Panasonic warrants to you only that the disc(s) or other media on which the Programs are furnished will be free from defects in material and workmanship under normal use for a period of sixty (60) days from the date of delivery thereof to you, as evidenced by your purchase receipt.

This is the only warranty Panasonic makes to you. Panasonic does not warrant that the functions contained in the Programs will meet your requirements or that the operation of the Programs will be uninterrupted or error free.

Panasonic's entire liability and your exclusive remedy under this warranty shall be limited to the replacement of any defective disk or other media which is returned to Panasonic's authorized Service Centre, together with a copy of the purchase receipt, within the aforesaid warranty period.

Panasonic shall have no obligation for any defects in the disk(s) or other media on which the Programs are furnished resulting from your storage thereof, or for defects that have been caused by operation of the disk(s) or other media otherwise than on the Product or in the environment conditions other than those specified by Panasonic by alteration, accident, misuse, abuse, neglect, mishandling, misapplication, installation, maladjustment of consumer controls, improper maintenance, modification or damage that is attributable to acts of God. In addition, Panasonic shall have no obligation for any defects in the disk(s) or other media if you have modified, or attempted to modify any Program.

Duration of implied warranties, if any is limited to sixty (60) days.

Pre-installed software

Pre-installed software means the software shipped pre-loaded by Panasonic, not that loaded by any third party or selling agent.

Panasonic and its suppliers makes no warranty, either express, implied or statutory, with respect to software provided with the Product and licensed to Purchaser, its quality, performance, merchantability, or fitness for a particular purpose.

Panasonic does not warrant that the functions contained in the software will be uninterrupted or error free. Panasonic assumes no risk of and shall not in any case be liable for any damages, including, without limitation, any special, incidental, consequential, or punitive damages arising from breach of warranty or contract, negligence or any other legal theory, including, without limitation loss of goodwill, profits or revenue, loss of use of the Programs or Products or any associated equipment, cost of capital, cost of any substitute equipment, facilities, or services, downtime costs, or claims of any party dealing with such damages.

Some countries do not allow the exclusion or limitation of incidental or consequential damages, or limitations on how long an implied warranty lasts, so the above limitations or exclusions may not apply to you.

This limited warranty gives you specific legal rights and you may also have other rights that vary from country to country. You must consult applicable country laws for a full determination of your rights.

Standard Limited Warranty

Contacts

Address

Panasonic System Communications Company Europe
Panasonic Manufacturing U.K. Ltd.
Service Centre Building B4,
Wharfedale Road, Pentwyn Industrial Estate, Cardiff,
United Kingdom
CF23 7XB

Web page

<http://business.panasonic.co.uk/computer-product/>

Helpdesk

English speaking service

+44 (0) 800 0884324

French speaking service

+33 (0) 80 5636449

German speaking service

+49 (0) 800 7235211

Italian speaking service

+39 800 986915

Spanish speaking service

+34 (0) 901 101 157

Austria

+43 (0) 800 006493

Switzerland (German)

+41 (0) 800 002429

Switzerland (French)

+41 (0) 800 588017

E-mail address

toughbooksupport@eu.panasonic.com

Czech speaking service

+420 (0) 800 143234

Hungarian speaking service

+36 (0) 6800 163 67

Polish speaking service

+48 (0) 800 4911558

Romanian speaking service

+40 (0) 800 894 743

Slovakian speaking service

+421 (0) 800 42672627

E-mail address

toughbooksupport@csg.de

Payments

toughbookservicepayments.cardiff@eu.panasonic.com

Panasonic Corporation

Osaka, Japan

Panasonic System Communications Company of North America

Two Riverfront Plaza,
Newark NJ 07102

Panasonic Canada Inc.

5770 Ambler Drive, Mississauga,
Ontario L4W 2T3

Panasonic Australia Pty. Limited

ACN 001 592 187 ABN 83 001 592 187
1 Innovation Road, Macquarie Park NSW 2113

Importer's name & address pursuant to the EU legislation

Panasonic System Communications Company Europe, Panasonic Marketing Europe GmbH

Hagenauer Straße 43
65203 Wiesbaden
Germany

Web Site : <http://panasonic.net/avc/pc/>