

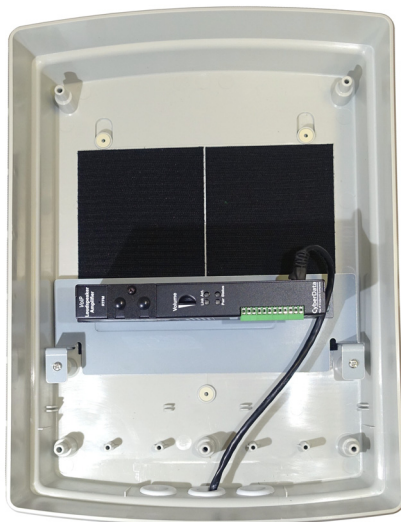

Singlewire InformaCast Loudspeaker Amplifier (PoE) Operations Guide



Part #011407
Document Part #931277B
for Firmware Version 11.6.3

CyberData Corporation
3 Justin Court
Monterey, CA 93940
(831) 373-2601

Operations Guide 931277B
Part # 011407

COPYRIGHT NOTICE:

© 2016, CyberData Corporation, ALL RIGHTS RESERVED.

This manual and related materials are the copyrighted property of CyberData Corporation. No part of this manual or related materials may be reproduced or transmitted, in any form or by any means (except for internal use by licensed customers), without prior express written permission of CyberData Corporation. This manual, and the products, software, firmware, and/or hardware described in this manual are the property of CyberData Corporation, provided under the terms of an agreement between CyberData Corporation and recipient of this manual, and their use is subject to that agreement and its terms.

DISCLAIMER: Except as expressly and specifically stated in a written agreement executed by CyberData Corporation, CyberData Corporation makes no representation or warranty, express or implied, including any warranty or merchantability or fitness for any purpose, with respect to this manual or the products, software, firmware, and/or hardware described herein, and CyberData Corporation assumes no liability for damages or claims resulting from any use of this manual or such products, software, firmware, and/or hardware. CyberData Corporation reserves the right to make changes, without notice, to this manual and to any such product, software, firmware, and/or hardware.

OPEN SOURCE STATEMENT: Certain software components included in CyberData products are subject to the GNU General Public License (GPL) and Lesser GNU General Public License (LGPL) “open source” or “free software” licenses. Some of this Open Source Software may be owned by third parties. Open Source Software is not subject to the terms and conditions of the CyberData COPYRIGHT NOTICE or software licenses. Your right to copy, modify, and distribute any Open Source Software is determined by the terms of the GPL, LGPL, or third party, according to who licenses that software.

Software or firmware developed by CyberData that is unrelated to Open Source Software is copyrighted by CyberData, subject to the terms of CyberData licenses, and may not be copied, modified, reverse-engineered, or otherwise altered without explicit written permission from CyberData Corporation.

TRADEMARK NOTICE: CyberData Corporation and the CyberData Corporation logos are trademarks of CyberData Corporation. Other product names, trademarks, and service marks may be the trademarks or registered trademarks of their respective owners.



Technical Support

The fastest way to get technical support for your VoIP product is to submit a VoIP Technical Support form at the following website:

<http://support.cyberdata.net/>

Phone: (831) 373-2601, Ext. 333

Email: support@cyberdata.net

Fax: (831) 373-4193

Company and product information is at www.cyberdata.net.

Revision Information

Revision 931277B, which corresponds to firmware version 11.6.3, was released on September 8, 2016 and has the following changes:



- Adds [Section 2.2.6, "Connecting the Strobe"](#)
- Updates [Table 2-3, "Connections Behind the Port Cover"](#)

Browsers Supported

The following browsers have been tested against firmware version 6.5.0:

- Internet Explorer (version: 10)
- Firefox (also called Mozilla Firefox) (version: 23.0.1 and 25.0)
- Chrome (version: 29.0.1547.66 m)
- Safari (version: 5.1.7)

Pictorial Alert Icons

	<p>General Alert <i>This pictorial alert indicates a potentially hazardous situation. This alert will be followed by a hazard level heading and more specific information about the hazard.</i></p>
	<p>Ground <i>This pictorial alert indicates the Earth grounding connection point.</i></p>

Hazard Levels

Danger: Indicates an imminently hazardous situation which, if not avoided, will result in death or serious injury. This is limited to the most extreme situations.

Warning: Indicates a potentially hazardous situation which, if not avoided, could result in death or serious injury.



Caution: Indicates a potentially hazardous situation which, if not avoided, could result in minor or moderate injury. It may also alert users against unsafe practices.

Notice: Indicates a statement of company policy (that is, a safety policy or protection of property).

- The safety guidelines for the equipment in this manual do not purport to address all the safety issues of the equipment. It is the responsibility of the user to establish appropriate safety, ergonomic, and health practices and determine the applicability of regulatory limitations prior to use. Potential safety hazards are identified in this manual through the use of words Danger, Warning, and Caution, the specific hazard type, and pictorial alert icons.

Important Safety Instructions

1. Read these instructions.
2. Keep these instructions.
3. Heed all warnings.
4. Follow all instructions.
5. Do not use this apparatus near water.
6. Clean only with dry cloth.
7. Do not block any ventilation openings. Install in accordance with the manufacturer's instructions.
8. Do not install near any heat sources such as radiators, heat registers, stoves, or other apparatus (including amplifiers) that produce heat.
9. Do not defeat the safety purpose of the polarized or grounding-type plug. A polarized plug has two blades with one wider than the other. A grounding type plug has two blades and a third grounding prong. The wide blade or the third prong are provided for your safety. If the provided plug does not fit into your outlet, consult an electrician for replacement of the obsolete outlet.
10. Protect the power cord from being walked on or pinched particularly at plugs, convenience receptacles, and the point where they exit from the apparatus.
11. Only use attachments/accessories specified by the manufacturer.
12. Refer all servicing to qualified service personnel. Servicing is required when the apparatus has been damaged in any way, such as power-supply cord or plug is damaged, liquid has been spilled or objects have fallen into the apparatus, the apparatus has been exposed to rain or moisture, does not operate normally, or has been dropped.
13. Prior to installation, consult local building and electrical code requirements.
- 14. WARNING: The Singlewire InformaCast Loudspeaker Amplifier (PoE) enclosure is not rated for any AC voltages!**

 <p>GENERAL ALERT</p>	<p>Warning</p> <p><i>Electrical Hazard:</i> This product should be installed by a licensed electrician according to all local electrical and building codes.</p>
 <p>GENERAL ALERT</p>	<p>Warning</p> <p><i>Electrical Hazard:</i> To prevent injury, this apparatus must be securely attached to the floor/wall in accordance with the installation instructions.</p>
 <p>GENERAL ALERT</p>	<p>Warning</p> <p>The PoE connector is intended for intra-building connections only and does not route to the outside plant.</p>

Abbreviations and Terms

Abbreviation or Term	Definition
A-law	A standard companding algorithm, used in European digital communications systems to optimize, i.e., modify, the dynamic range of an analog signal for digitizing.
AVP	Audio Video Profile
Cat 5	TIA/EIA-568-B Category 5
DHCP	Dynamic Host Configuration Protocol
LAN	Local Area Network
LED	Light Emitting Diode
Mbps	Megabits per Second.
NTP	Network Time Protocol
PBX	Private Branch Exchange
PoE	Power over Ethernet (as per IEEE 802.3af standard)
RTFM	Reset Test Function Management
SIP	Session Initiated Protocol
u-law	A companding algorithm, primarily used in the digital telecommunication
UC	Unified Communications
VoIP	Voice over Internet Protocol

Chapter 1 Product Overview	1
1.1 How to Identify This Product	1
1.2 Typical System Installation	2
1.3 Product Features	3
1.4 Supported Protocols	4
1.5 Supported SIP Servers	4
1.6 Specifications	5
1.7 Typical Coverage	5
1.8 Typical Warehouse Paging Setup	6
Chapter 2 Installing the Singlewire InformaCast Loudspeaker Amplifier (PoE)	7
2.1 Parts List	7
2.2 Singlewire InformaCast Loudspeaker Amplifier (PoE) Setup	8
2.2.1 Singlewire InformaCast Loudspeaker Amplifier (PoE) Components	9
2.2.2 NEMA Box Components of the Singlewire InformaCast Loudspeaker Amplifier (PoE)	10
2.2.3 Connecting the Singlewire InformaCast Loudspeaker Amplifier (PoE)	11
2.2.4 Singlewire InformaCast Loudspeaker Amplifier (PoE) System Installation and Connection Options	14
2.2.5 Connections Behind the Port Cover	16
2.2.6 Connecting the Strobe	17
2.2.7 Singlewire InformaCast Loudspeaker Amplifier (PoE) Jumpers	19
2.2.8 Ethernet Connection	19
2.2.9 Loudspeaker Type	20
2.2.10 Cabling/Wiring	20
2.2.11 Confirm Operation	21
2.2.12 Confirm the IP Address and Test the Audio	22
2.2.13 Adjust the Volume	23
2.3.1 Factory Default Settings	25
2.3.2 Singlewire InformaCast Loudspeaker Amplifier (PoE) Web Page Navigation	26
2.3.3 Using the Toggle Help Button	27
2.3.4 Log in to the Configuration Home Page	29
2.3.5 Configure the Device	33
2.3.6 Configure the Network Parameters	41
2.3.7 Configure the SIP (Session Initiation Protocol) Parameters	44
2.3.8 Configure the Multicast Parameters	54
2.3.9 Configure the Sensor Configuration Parameters	58
2.3.10 Configure the Audio Configuration Parameters	62
2.3.11 Configure the Events Parameters	67
2.3.12 Configure the Autoprovisioning Parameters	73
2.4.1 Downloading the Firmware	85
2.4.2 Reboot the Device	87
2.5.1 Command Interface Post Commands	88
Appendix A Mounting the Amplifier	92
A.1 Mount the Amplifier	92
Appendix B Setting up a TFTP Server	94
B.1 Set up a TFTP Server	94
B.1.1 In a LINUX Environment	94
B.1.2 In a Windows Environment	94
Appendix C Troubleshooting/Technical Support	95
C.1 Frequently Asked Questions (FAQ)	95
C.2 Documentation	95
C.3 Contact Information	96
C.4 Warranty and RMA Information	96
Index	97

1 Product Overview

The CyberData SIP-enabled Singlewire InformaCast Loudspeaker Amplifier (PoE) (AC-Powered) provides an easy method for implementing an IP-based overhead paging system for both new and legacy installations.

With up to 25 watts of driving power (802.3at), the Amplifier provides direct drive of a standard Horn speaker and supports a line-out connector for connection to an external amplifier. The interface is compatible with most SIP-based IP PBX servers that comply with the SIP RFC 3261. For non-SIP environments, the Singlewire InformaCast Loudspeaker Amplifier (PoE) can be configured to listen to multicast address and port number combinations to form paging zones.

1.1 How to Identify This Product

To identify the Singlewire InformaCast Loudspeaker Amplifier (PoE), look for a model number label similar to the one shown in [Figure 1-1](#). Confirm the following:

- The model number on the label should be **011407**.

Figure 1-1. Model Number Label

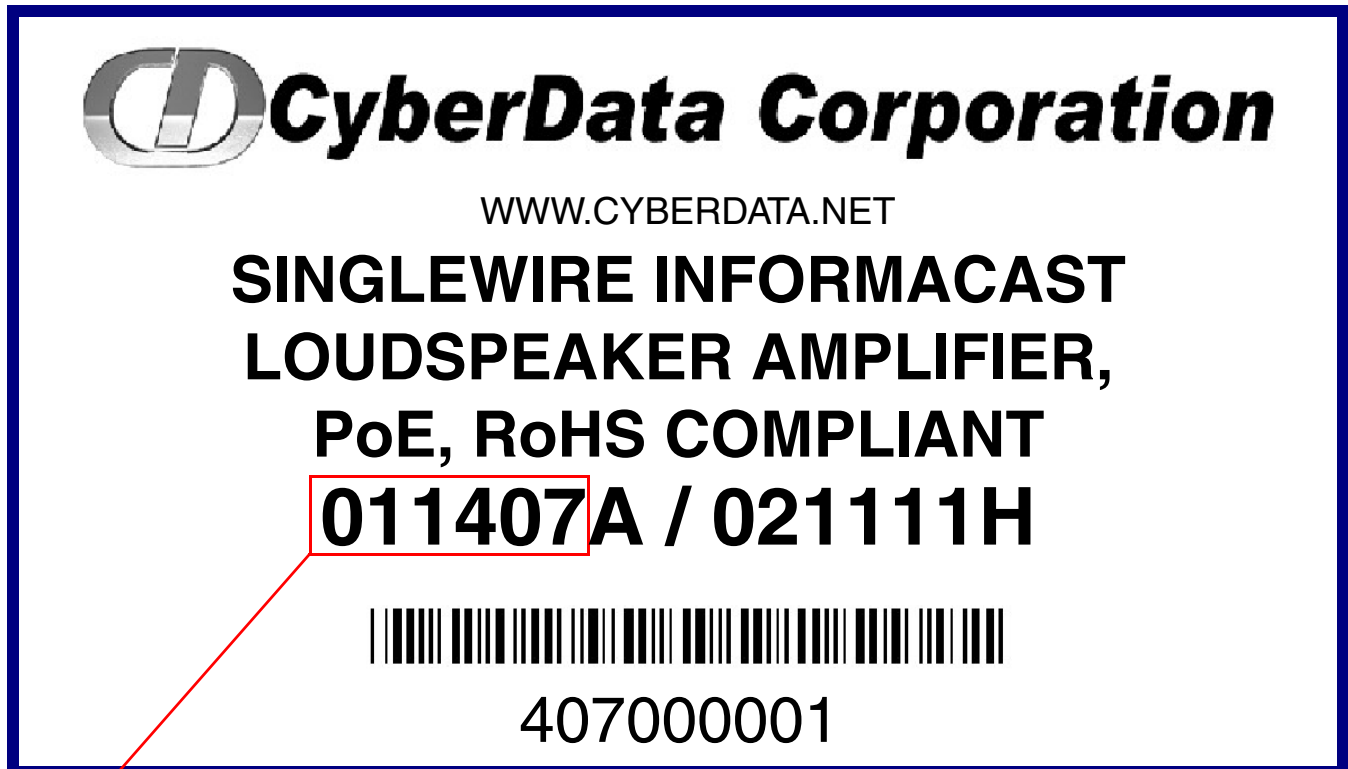

Model number

1.2 Typical System Installation

Figure 1-2 illustrates how the Singlewire InformaCast Loudspeaker Amplifier (PoE) is normally installed as part of a public address system.

Figure 1-2. Typical Installation

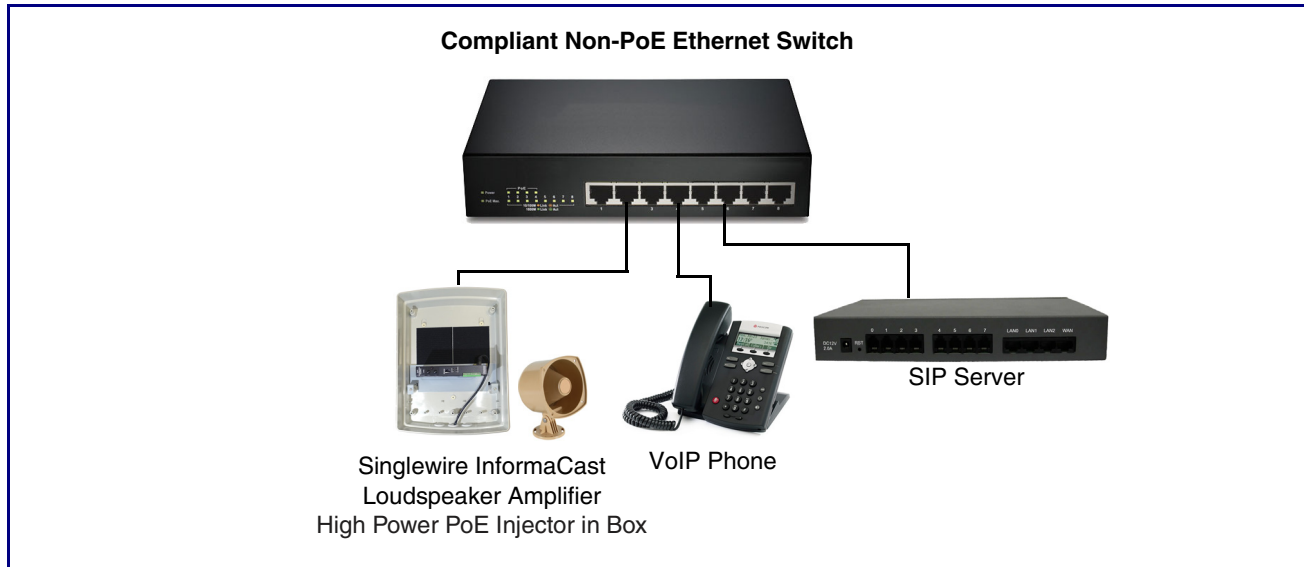

GENERAL ALERT

Warning

Electrical Hazard: The Singlewire InformaCast Loudspeaker Amplifier (PoE) enclosure is not rated for any AC voltages.



GENERAL ALERT

Warning

Electrical Hazard: This product should be installed by a licensed electrician according to all local electrical and building codes.



GENERAL ALERT

Warning

Electrical Hazard: To prevent injury, this apparatus must be securely attached to the floor/wall in accordance with the installation instructions.



GENERAL ALERT

Warning

The PoE connector is intended for intra-building connections only and does not route to the outside plant.

1.3 Product Features

Singlewire InformaCast Features

- Dual registration for Singlewire and SIP
- Singlewire Informacast compatibility available. Includes support for Informacast resiliency
- Support both SIP and Singlewire InformaCast
- InformaCast compliant
- InformaCast CK compliant

SIP Features

- SIP-enhanced interoperability for hosted environments
- 9 user-uploadable page messages
- Support for security code access for SIP paging
- Autoprovisioning via HTTPS
- HTTPS web based configuration
- Higher Power PoE 802.3AT
- 802.11q VLAN tagging
- Configurable sense input for use with fault detection
- Configurable event generation for device health and status monitoring
- Optional direct connect RGB strobe kit connection
- Support for G.711 u-law, G.711 a-law, and G.722 codecs
- HTTP Command Interface
- 10 channel prioritized Multicast ports
- Built-in diagnostics
- Delayed page support
- Cisco SRST
- Packaged in a NEMA 3R/IP42-rated enclosure
- SIP and Simultaneous Multicast
- Dual-speed ethernet 10/100 Mbps
- Web-based configuration
- PoE 802.3at and 802.3af-enabled
- Line-in for background music
- Line-out connector
- DTMF controlled relay
- Direct 8 Ohm speaker drive
- User-uploadable tones and messages
- Digital and manual volume control
- Second SIP endpoint "Night Ringer"
- Autoprovisioning
- Auto-call voice message from input port sense

- Can support two horns

1.4 Supported Protocols

The Singlewire InformaCast Loudspeaker Amplifier (PoE) supports:

- SIP
- InformaCast Version 4.0 and greater
- Multicast
- HTTP and HTTPS web-based configuration

Provides an intuitive user interface for easy system configuration and verification of Singlewire InformaCast Loudspeaker Amplifier (PoE) operations.

- DHCP Client
Dynamically assigns IP addresses in addition to the option to use static addressing.
- TFTP Client
Facilitates hosting for the configuration file for Autoprovisioning.

- RTP
- RTP/AVP - Audio Video Profile
- SPEEX
- Audio Encodings
PCMU (G.711 mu-law)
PCMA (G.711 A-law)
G.722
Packet Time 20 ms

1.5 Supported SIP Servers

The following link contains information on how to configure the Singlewire InformaCast Loudspeaker Amplifier (PoE) for the supported SIP servers:

<http://www.cyberdata.net/connecting-to-ip-pbx-servers/>

1.6 Specifications

Table 1. Specifications

Specifications	
Ethernet I/F	10/100 Mbps
Protocol	InformaCast and/or SIP (RFC 3261)
Power Input	PoE 802.3at or 802.3af
Audio Output	802.3af - SPL 114 dB @ 1 meter ^a 802.3at - SPL 117 dB @ 1 meter ^a
Line In:	
Input Signal Amplitudes	2.0 VPP maximum
Input Impedance	10k Ohm
Line Out:	
Output Signal Amplitudes	2.0 VPP maximum
Output Level	+2dBm nominal
Total Harmonic Distortion	0.5% maximum
Output Impedance	10k Ohm
Operating Temperature	-10° C to 50° C (14° F to 122° F)
Payload Types	G.711 a-law, G.711 u-law, G.722
Dimensions ^b	1.042 in. [26.5 mm] Length 3.295 in. [83.7 mm] Width 7.795 in. [198.0 mm] Height
Weight	1.4 lbs. [0.63 kg]
Boxed Weight	2.0 lbs. [0.90 kg]
Part Number	011407
Loudspeaker Part Number	011068

a. When used with the 011068 Mini Horn.

b. Dimensions are measured from the perspective of the product being upright with the front of the product facing you.

1.7 Typical Coverage

With one horn attached to Paging Amplifier under standard 802.3af PoE power, coverage is up to 5,000 square feet. With two horns attached to the Paging Amplifier under 802.3at PoE (high power), coverage is up to 10,000 square feet depending on ambient background noise levels.

1.8 Typical Warehouse Paging Setup

Figure 1-3. Typical Warehouse Paging Setup

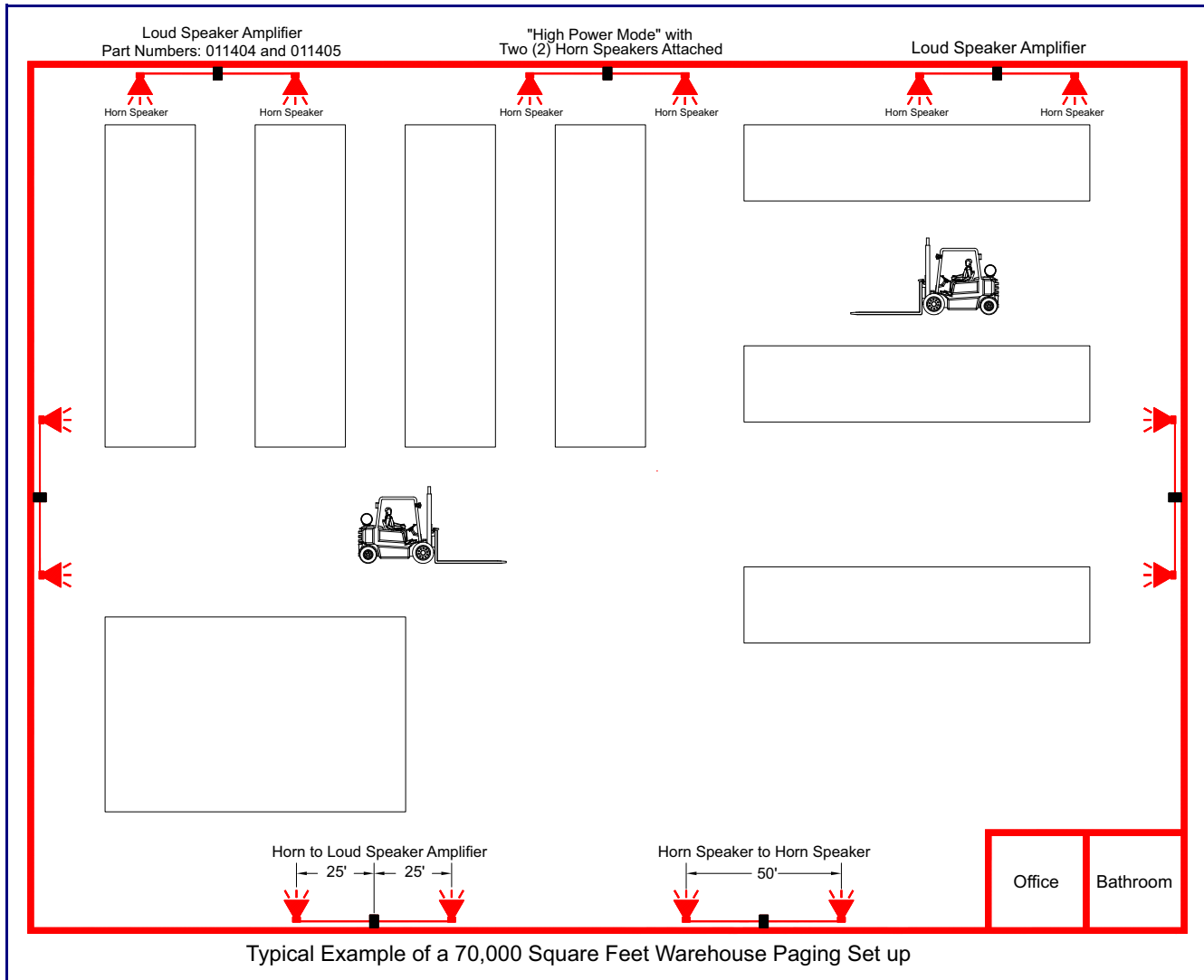



2 Installing the Singlewire InformaCast Loudspeaker Amplifier (PoE)

2.1 Parts List

Table 2-1 illustrates the parts for each Singlewire InformaCast Loudspeaker Amplifier (PoE) and includes a kit for mounting.

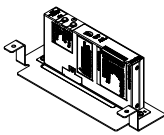
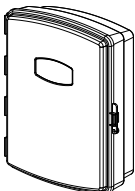
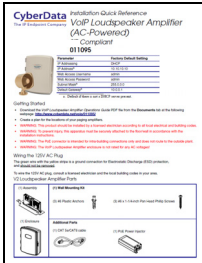
Table 2-1. Parts List

Quantity	Part Name	Illustration
1	Singlewire InformaCast Loudspeaker Amplifier (PoE) Assembly	
1	Enclosure	
1	Installation Quick Reference Guide	
1	Singlewire InformaCast Loudspeaker Amplifier (PoE) Mounting Accessory Kit, RoHS (part #071057A) which includes: (3) Plastic Ribbed Anchors (3) #6 Sheet Metal Screws	

2.2 Singlewire InformaCast Loudspeaker Amplifier (PoE) Setup

Set up and configure each Singlewire InformaCast Loudspeaker Amplifier (PoE) *before* you mount it.

CyberData delivers each Singlewire InformaCast Loudspeaker Amplifier (PoE) with the factory default values indicated in

[Table 2-2:](#)

Table 2-2. Factory Default Settings—Default of Network

Parameter	Factory Default Setting
IP Addressing	DHCP
IP Address ^a	10.10.10.10
Web Access Username	admin
Web Access Password	admin
Subnet Mask ^a	255.0.0.0
Default Gateway ^a	10.0.0.1

a. Default if there is not a DHCP server present.

2.2.1 Singlewire InformaCast Loudspeaker Amplifier (PoE) Components

Figure 2-4 shows the components of the Singlewire InformaCast Loudspeaker Amplifier (PoE).

Figure 2-4. Singlewire InformaCast Loudspeaker Amplifier (PoE) Components

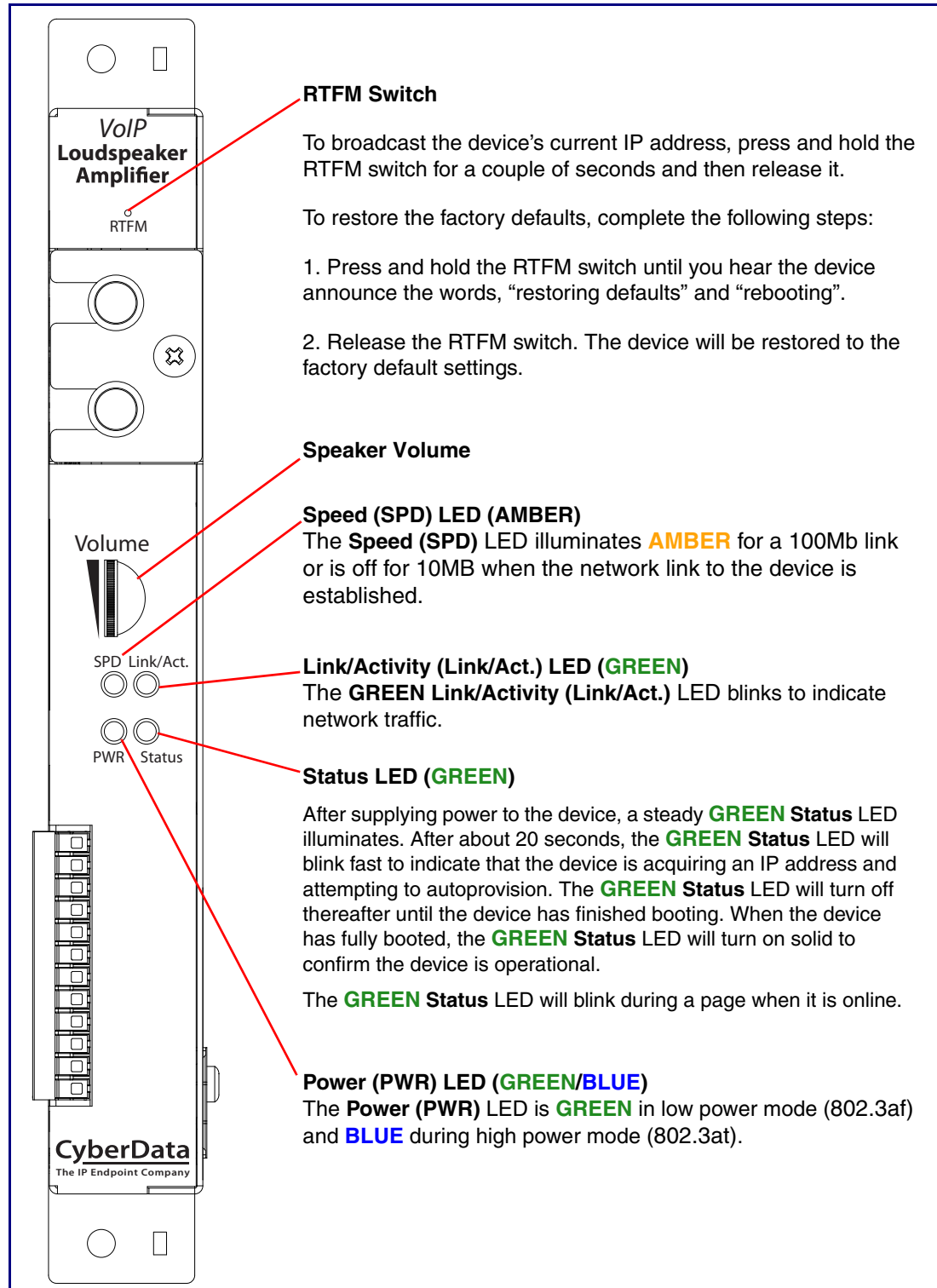

2.2.2 NEMA Box Components of the Singlewire InformaCast Loudspeaker Amplifier (PoE)

Figure 2-5 shows all of the NEMA box components of the Singlewire InformaCast Loudspeaker Amplifier (PoE).

Figure 2-5. Loudspeaker Amplifier Components—PoE

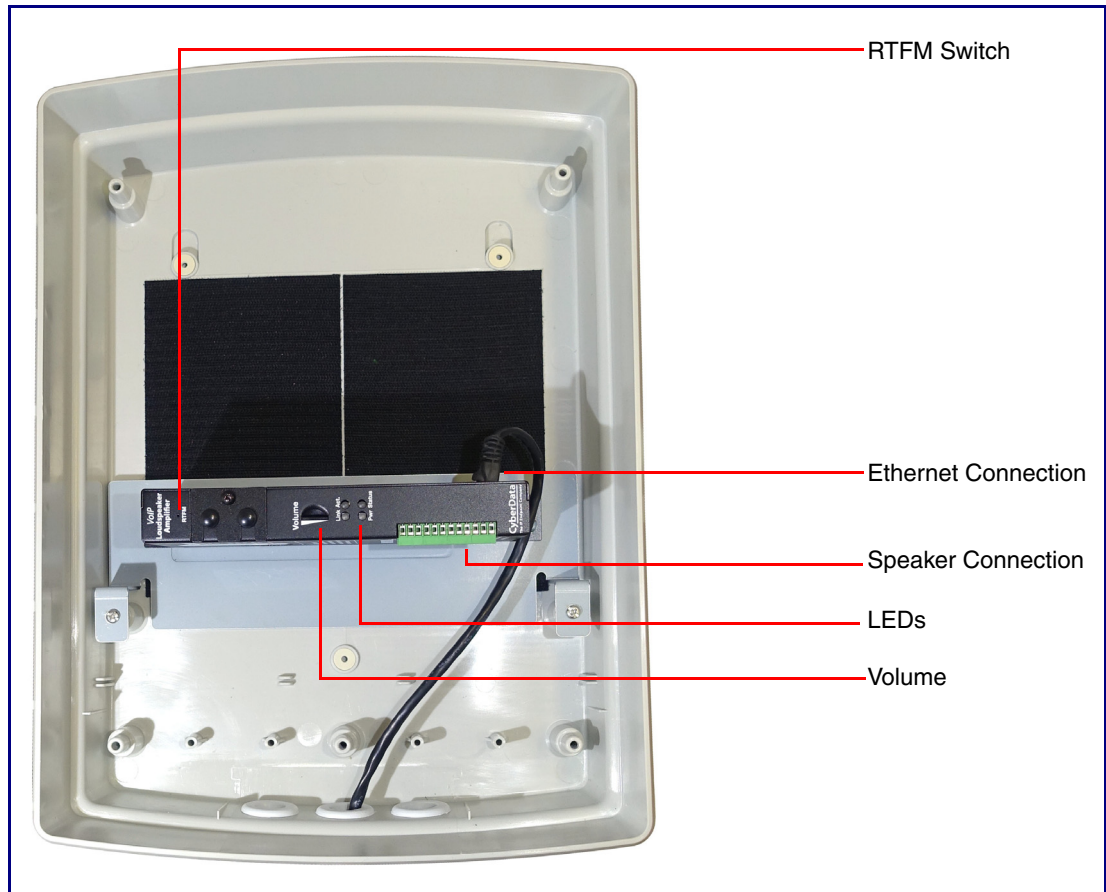

2.2.3 Connecting the Singlewire InformaCast Loudspeaker Amplifier (PoE)

2.2.3.1 Using the Amplified Outputs

Low Power Mode (One Speaker) The following figure illustrate how to connect the Singlewire InformaCast Loudspeaker Amplifier (PoE) and use the amplified outputs in low power mode to one speaker or horn.

Figure 2-6. Using the Amplified Outputs—Low Power Mode with One Speaker

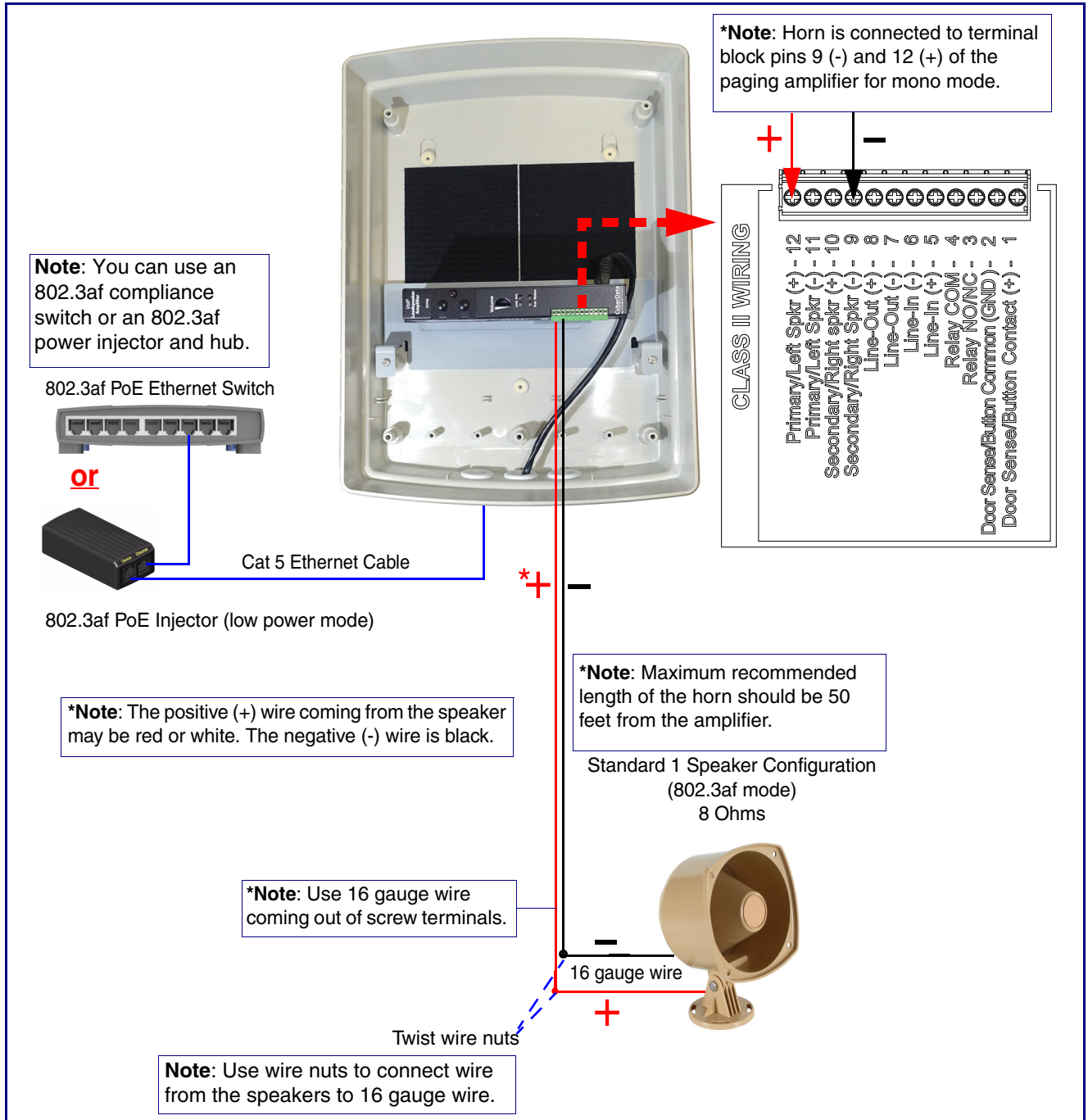

High Power Mode (One Speaker) The following figure illustrate how to connect the Singlewire InformaCast Loudspeaker Amplifier (PoE) and use the amplified outputs in high power mode to one speaker or horn.

Figure 2-7. Using the Amplified Outputs—High Power Mode with One Speaker

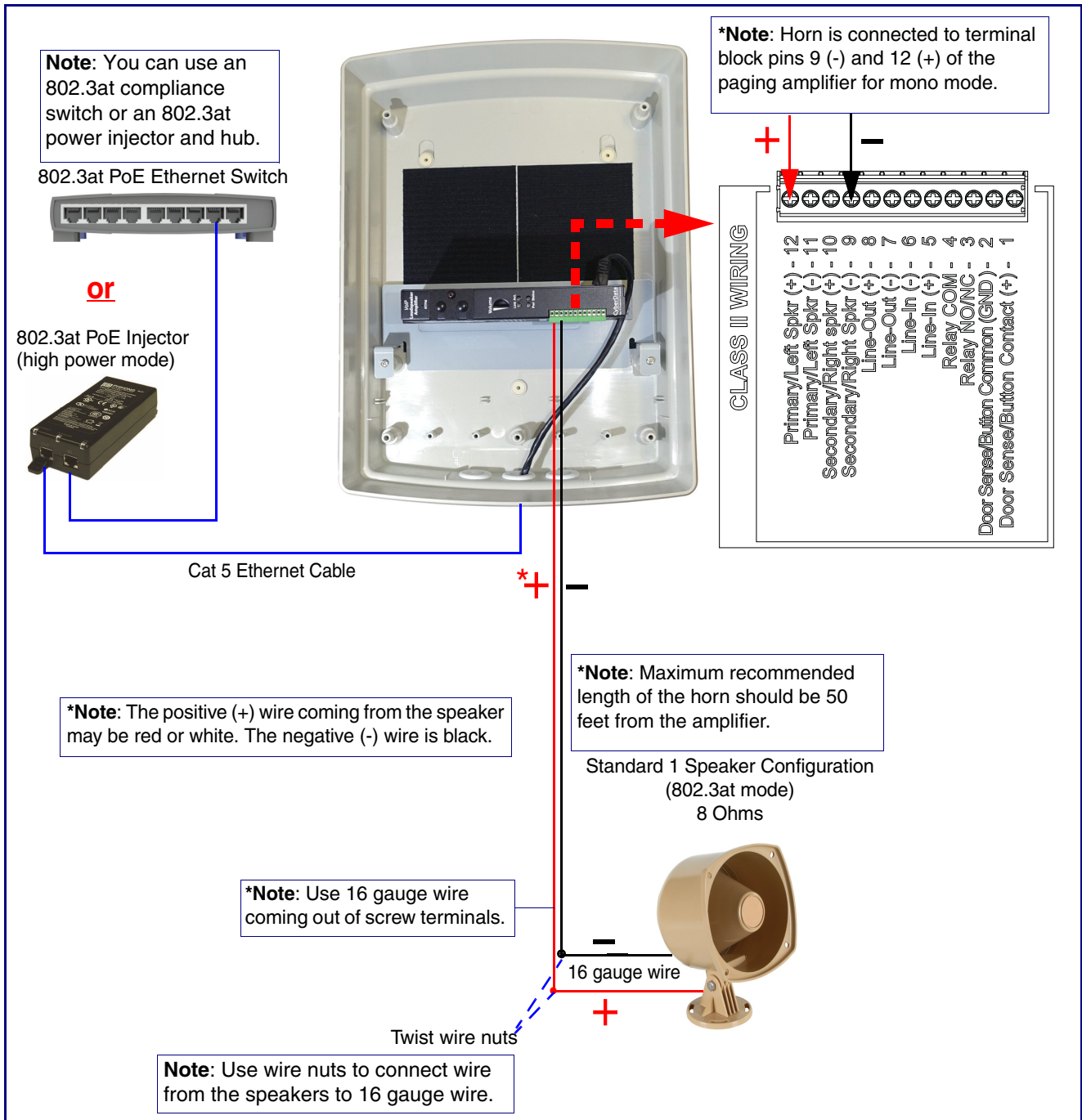

High Power Mode (Two Speakers) The following figure illustrate how to connect the Singlewire InformaCast Loudspeaker Amplifier (PoE) and use the amplified outputs in high power mode to two speakers or horns.

Figure 2-8. Using the Amplified Outputs—High Power Mode with Two Speakers

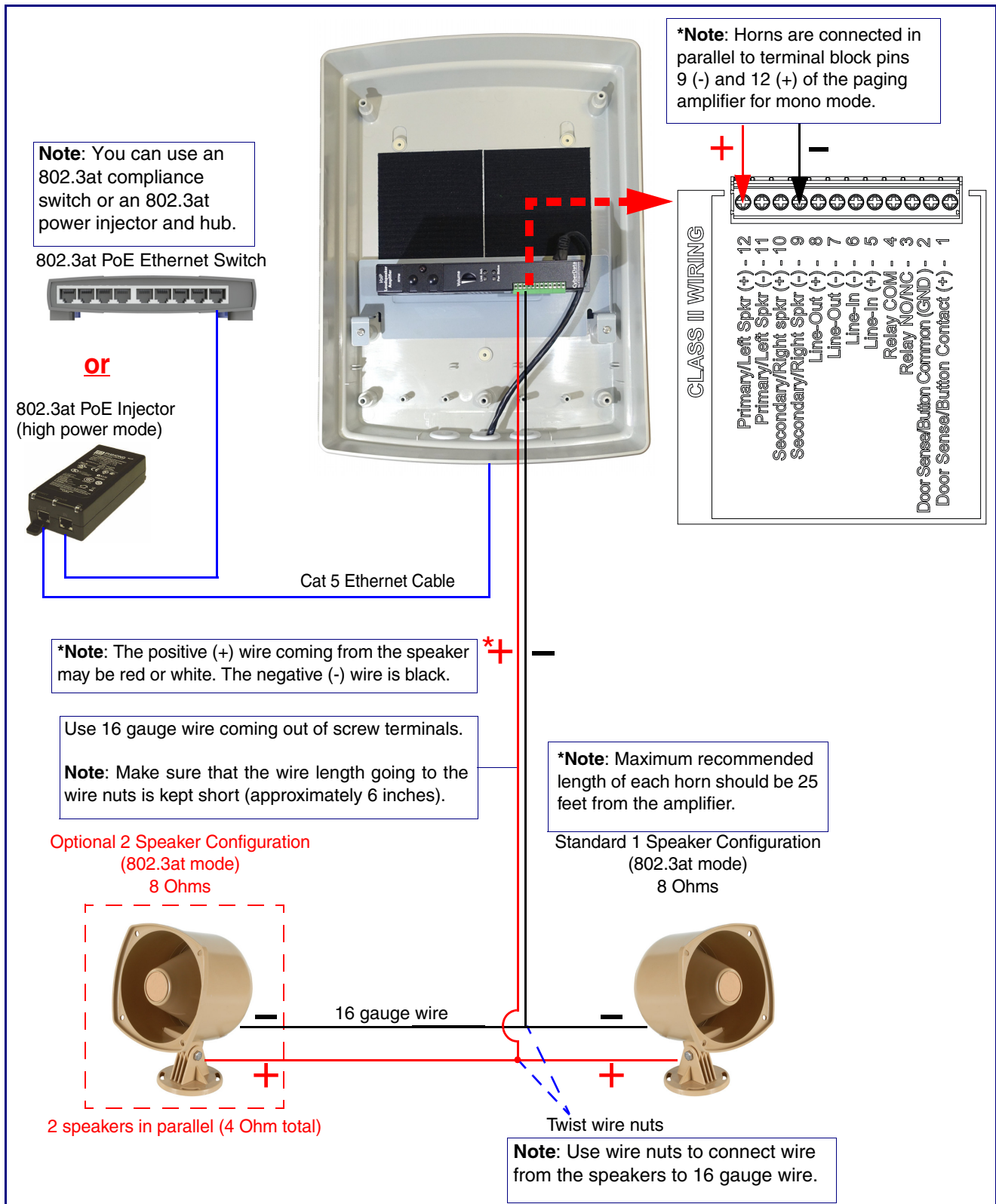

2.2.4 Singlewire InformaCast Loudspeaker Amplifier (PoE) System Installation and Connection Options

The following figures show the connection options for the Singlewire InformaCast Loudspeaker Amplifier (PoE).

Figure 2-9. Singlewire InformaCast Loudspeaker Amplifier (PoE) Connections

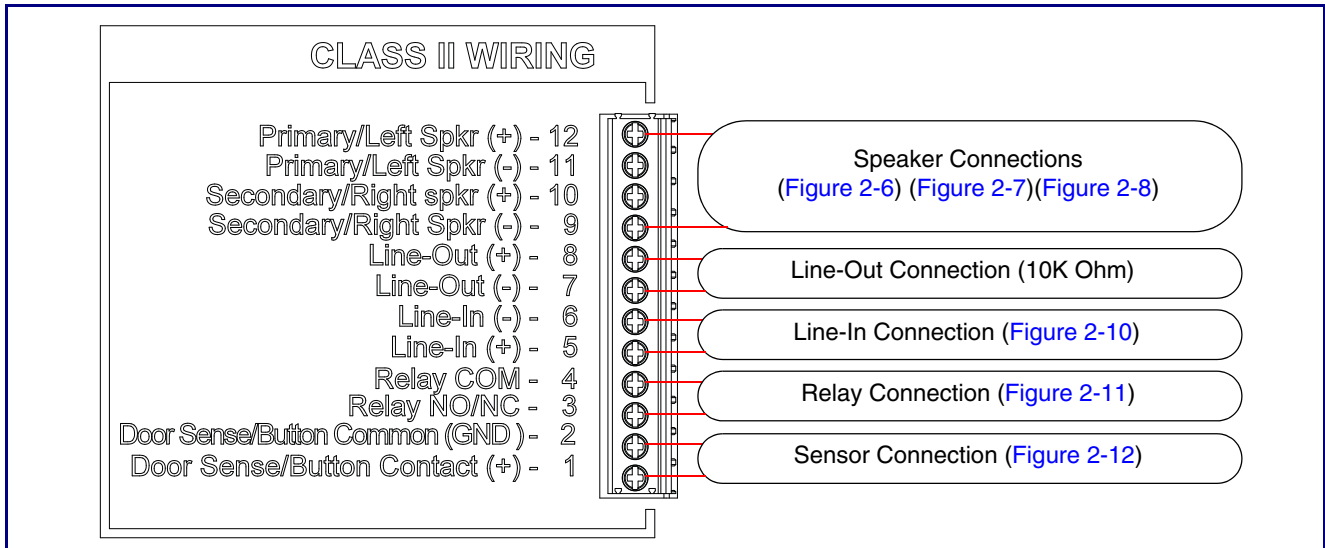

Figure 2-10. Line-In Connection

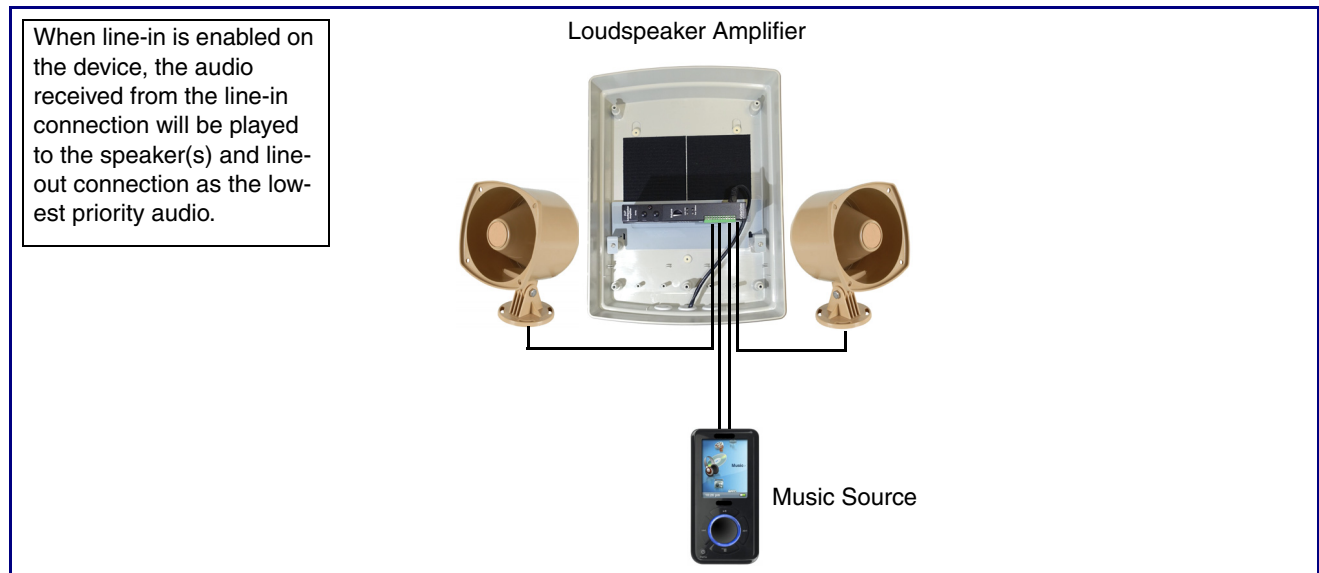

Figure 2-11. Relay or LED Strobe Connection

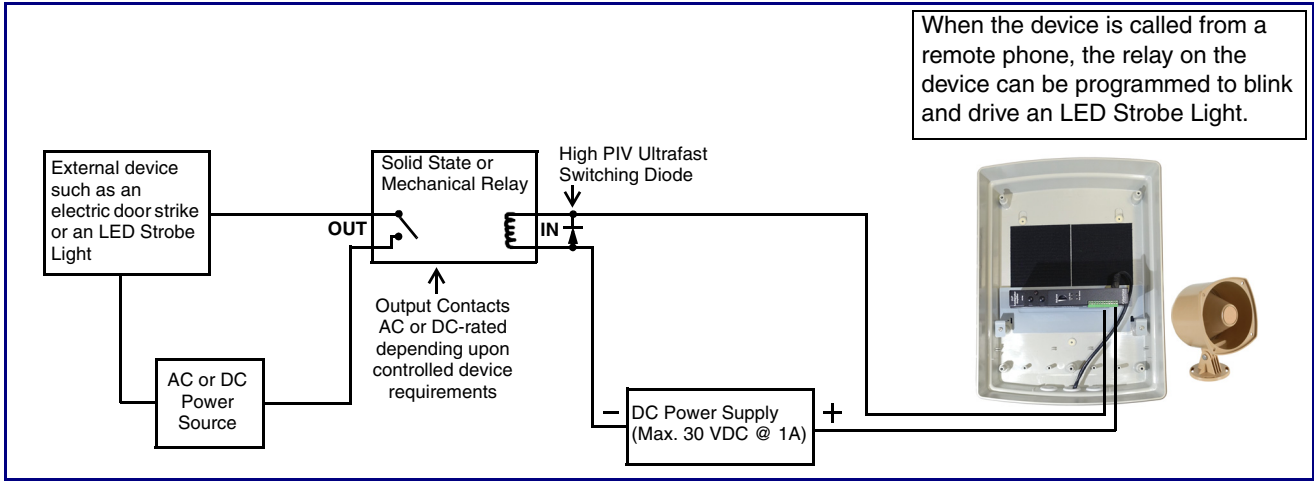

Figure 2-12. Sensor Connection



2.2.5 Connections Behind the Port Cover

See [Figure 2-13](#) for the additional connection options for the Singlewire InformaCast Loudspeaker Amplifier (PoE).

Figure 2-13. Connections Behind the Port Cover

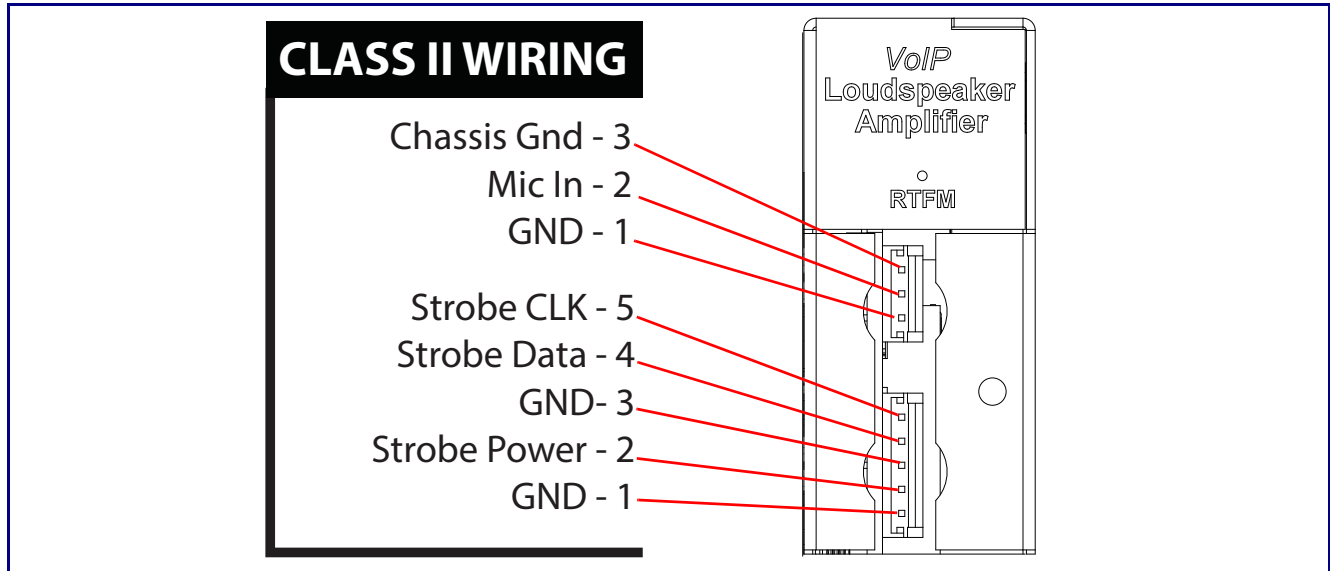

See [Table 2-3](#) for the descriptions of the connections behind the port cover.

Table 2-3. Connections Behind the Port Cover

Name	Connection	Description
Chassis Gnd	J6-1	Microphone chassis ground connections
Mic In	J6-2	Microphone positive input
GND	J6-3	Microphone negative input
Strobe Connections		
Name	Connection	Description
GND	J9-1	Ground
Strobe Power	J9-2	Strobe positive power (+24V)
GND	J9-3	Ground
Strobe Data	J9-4	I2C data
Strobe CLK	J9-5	I2C clock

2.2.6 Connecting the Strobe

1. Insert the network cable through any available rubber grommet at the bottom of the enclosure. See [Figure 2-14](#).
2. Connect the Network Cable to the Paging Amplifier. See [Figure 2-14](#).

Figure 2-14. Connecting the Strobe

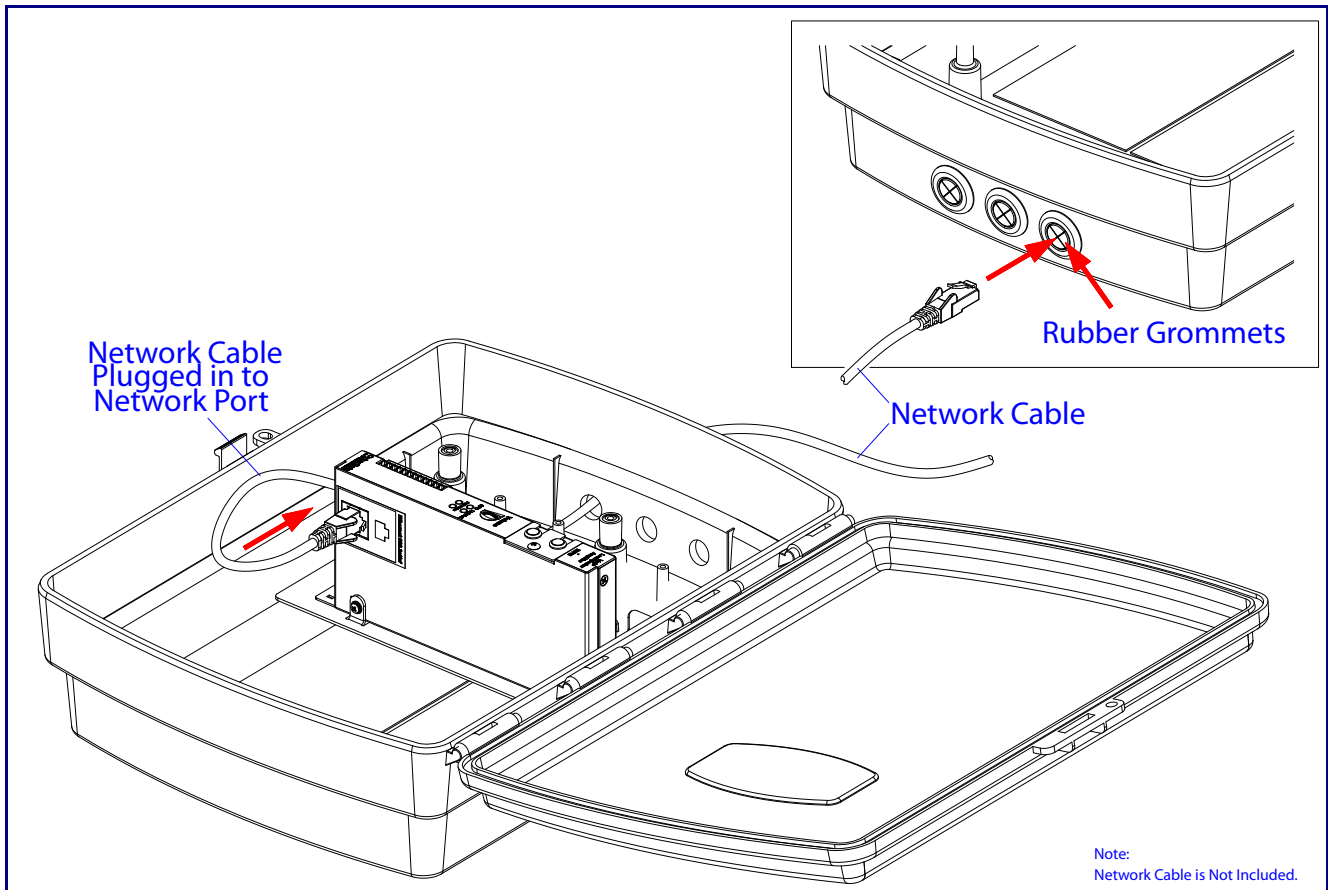

3. Remove the mounting screw to remove the cover plate. See [Figure 2-15](#).
4. Remove the hole plug and grommet. See [Figure 2-15](#).
5. Slide the cover plate through the slot on the cable grommet. See [Figure 2-15](#).
6. Install the mounting screw to secure the cover plate. See [Figure 2-15](#).

Figure 2-15. Connecting the Strobe

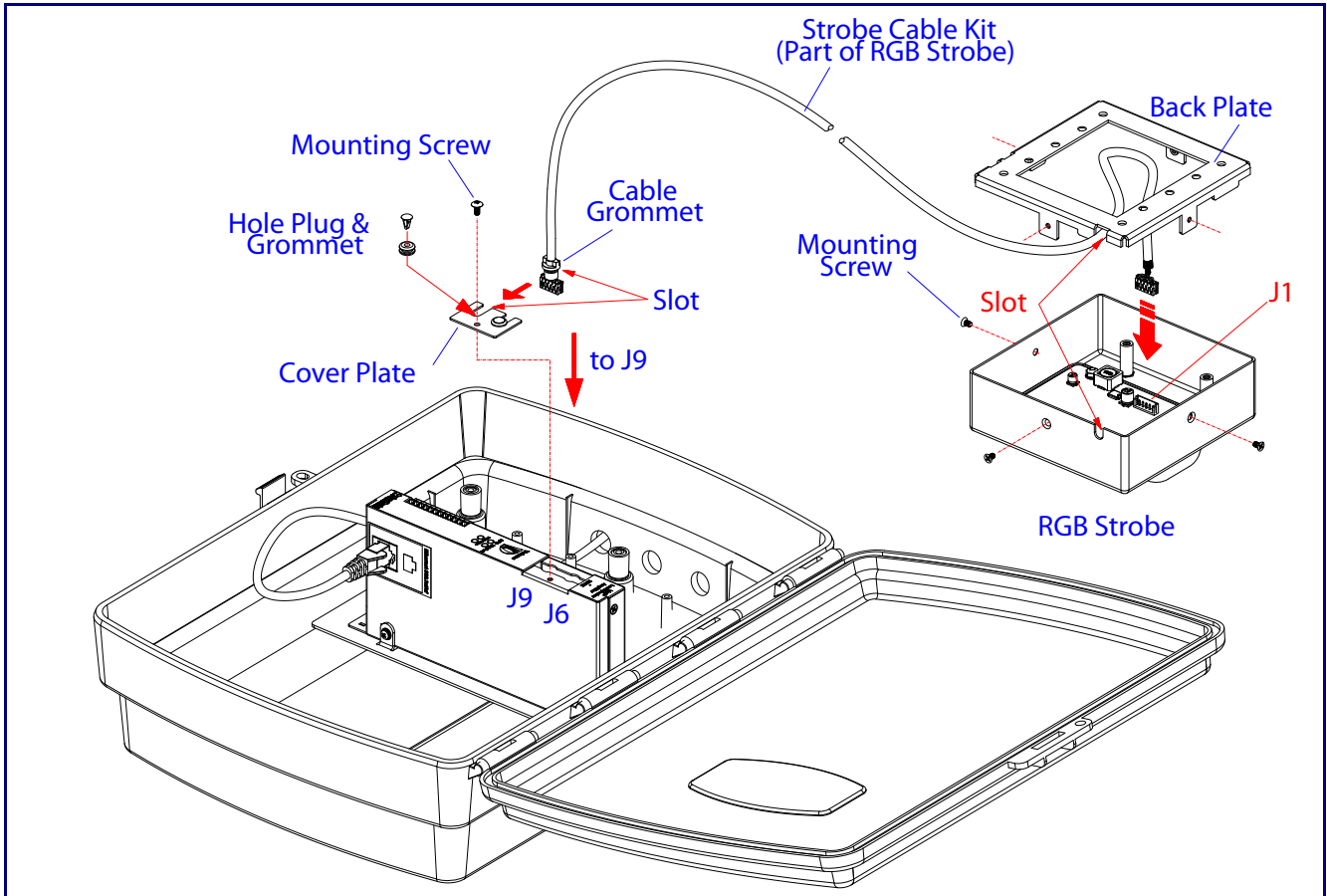

2.2.7 Singlewire InformaCast Loudspeaker Amplifier (PoE) Jumpers

See [Figure 2-16](#) for the jumper locations.

Figure 2-16. Jumper Locations

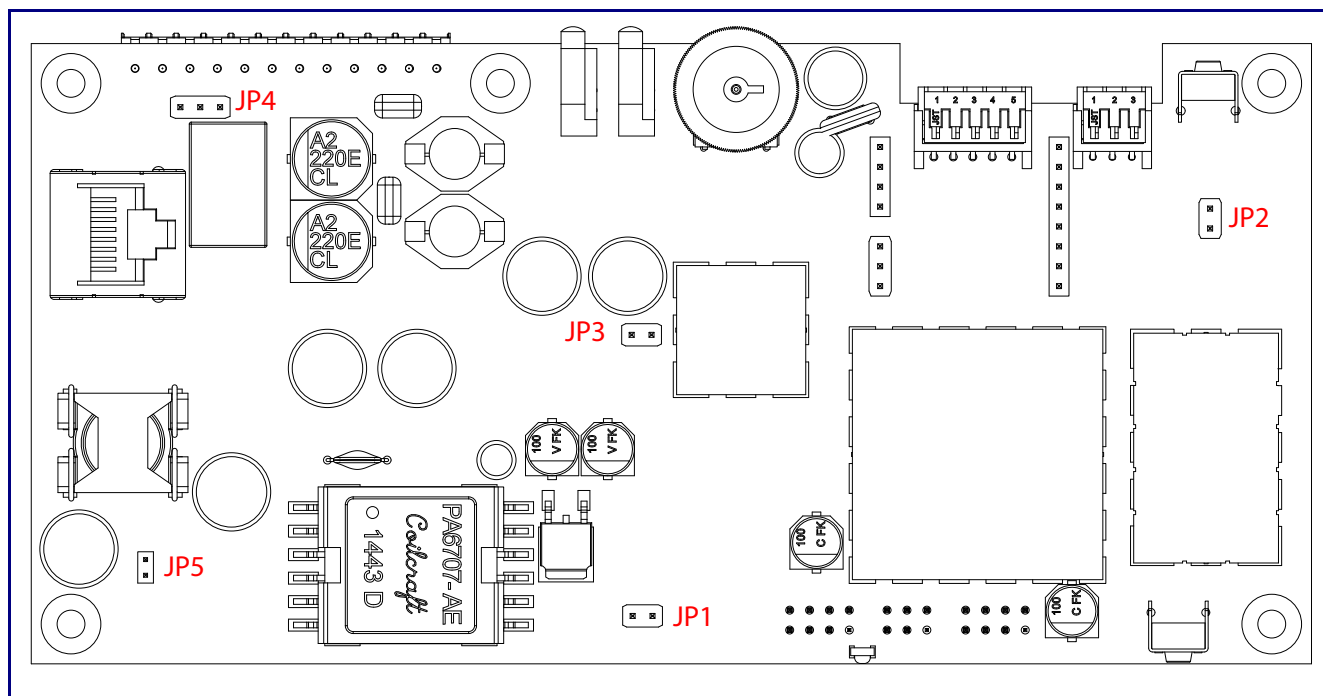

See [Table 2-4](#) for the jumper descriptions.

Table 2-4. Jumper Descriptions

Jumper	Description
JP1	Reset—Factory Only
JP2	RTFM (not installed)
JP3	Audio Enable Jumper—Factory Only
JP4	Relay NO/NC (default to NO)—Factory Only
JP5	PoE IEEE 802.3at—Factory Only

2.2.8 Ethernet Connection

See [Table 2-5](#) for details about the Singlewire InformaCast Loudspeaker Amplifier (PoE) connection.

Table 2-5. Singlewire InformaCast Loudspeaker Amplifier (PoE) Connection

Connection	Connection Details	Location
Ethernet	Use a RJ 45 cable.	Singlewire InformaCast Loudspeaker Amplifier (PoE)

2.2.9 Loudspeaker Type

Using the amplified output, the CyberData Singlewire InformaCast Loudspeaker Amplifier (PoE) supports the 011068 Loudspeaker or equivalent unamplified loudspeaker.

Figure 2-17. 011068 Loudspeaker



2.2.10 Cabling/Wiring

Using the amplified output, you may connect a 011068 loudspeaker or equivalent unamplified speaker to a SIP Loudspeaker Amplifier (PoE-powered) with good quality speaker wire that is 16 gauge and limited to 25 feet in length with two loudspeakers or 50 feet in length with one loudspeaker.

2.2.11 Confirm Operation

After connecting the device to the 802.3af compliant ethernet hub, use the LEDs on the device to confirm that the device is operational and linked to the network.

Table 2-6. Singlewire InformaCast Loudspeaker Amplifier (PoE) LEDs

LED	Color	Function
Power (PWR)	BLUE/GREEN	The 802.3at power injector that is provided with the device should cause the Power (PWR) LED to illuminate BLUE to indicate that high power is available. The Power (PWR) LED may illuminate GREEN if a low power mode (802.3af) power source is used (not included and sold separately).
Status	GREEN	After supplying power to the device, a steady GREEN Status LED illuminates. After about 20 seconds, the GREEN Status LED will blink fast to indicate that the device is acquiring an IP address and attempting to autoprovision. The GREEN Status LED will turn off thereafter until the device has finished booting. When the device has fully booted, the GREEN Status LED will turn on solid to confirm the device is operational. The GREEN Status LED will blink during a page when it is online.
Speed (SPD)	AMBER	The Speed (SPD) LED illuminates AMBER for a 100Mb link or is off for 10MB when the network link to the device is established.
Link/Activity (Link/Act.)	GREEN	The Link/Activity (Link/Act.) GREEN LED blinks to indicate network traffic.

Figure 2-18. Singlewire InformaCast Loudspeaker Amplifier (PoE) LEDs

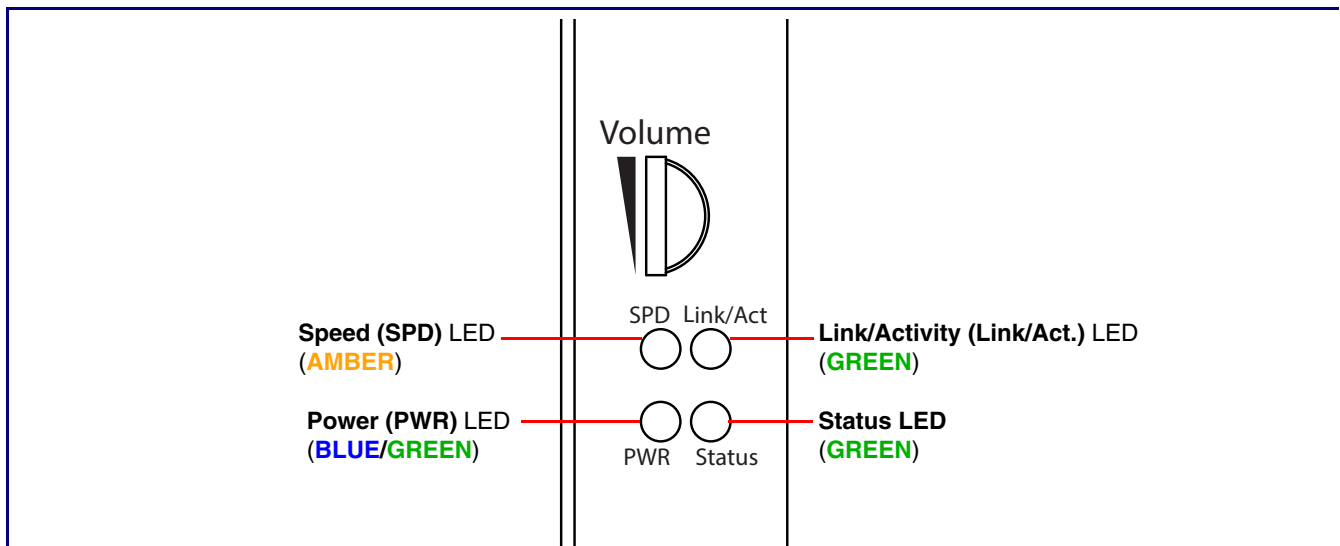

2.2.12 Confirm the IP Address and Test the Audio

2.2.12.1 RTFM Switch

When the Singlewire InformaCast Loudspeaker Amplifier (PoE) is operational and linked to the network, use the Reset Test Function Management (**RTFM**) switch (Figure 2-19) on the Singlewire InformaCast Loudspeaker Amplifier (PoE) face to announce and confirm the Singlewire InformaCast Loudspeaker Amplifier (PoE)'s IP Address and test the audio to verify that it is working.

Figure 2-19. RTFM Switch

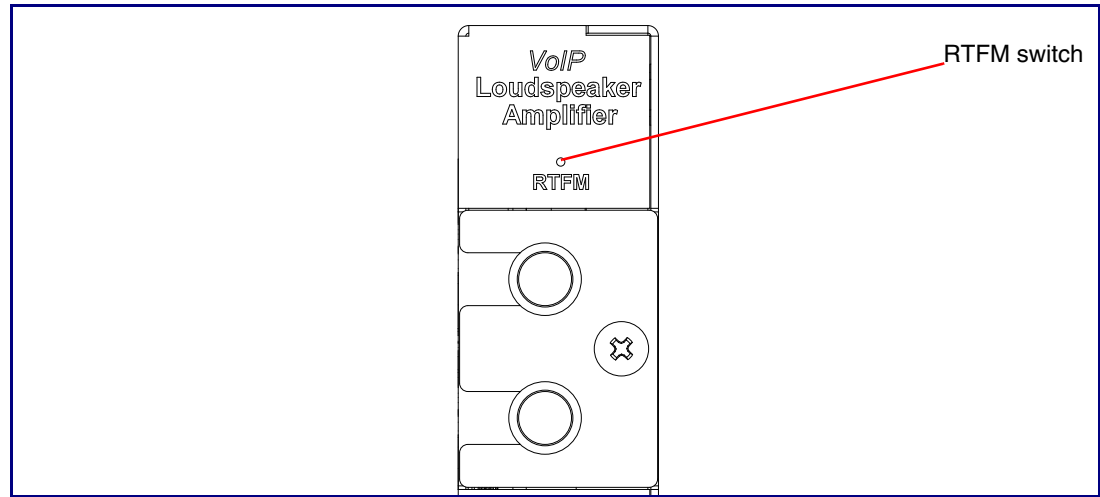

Announcing the IP Address To announce a Singlewire InformaCast Loudspeaker Amplifier (PoE)'s current IP address:

- Press and hold the RTFM switch for a couple of seconds and then release it.



Caution

Equipment Caution: Pressing and holding the RTFM switch for more than five seconds will restore the device to the factory default settings. See the [“Restoring the Factory Default Settings”](#) section.

Restoring the Factory Default Settings

To restore the factory default settings, complete the following steps:

1. Press and hold the RTFM switch until you hear the device announce the words, “restoring defaults” and “rebooting”.
2. Release the RTFM switch. The device will be restored to the factory default settings.

2.2.13 Adjust the Volume

There are two ways to adjust the volume for the Singlewire InformaCast Loudspeaker Amplifier (PoE):

- The **SIP Volume** setting on the **Device Configuration Page**
- The external **Volume** dial (**Figure 2-21**) on the Singlewire InformaCast Loudspeaker Amplifier (PoE) face

Figure 2-20. External Volume Dial

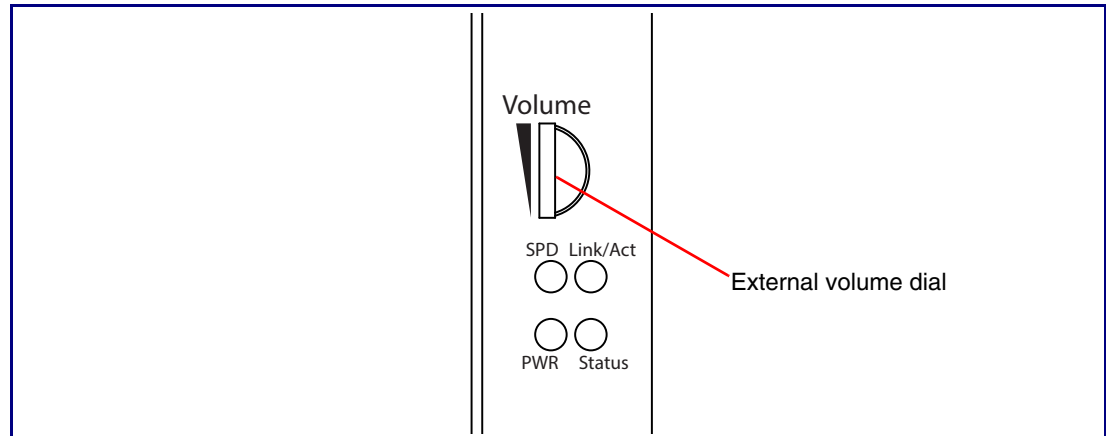

2.2.13.1 The SIP Volume Setting

To adjust the volume of the device with the **SIP Volume** setting on the **Device Configuration Page**, complete the following steps:

1. Go to the **Home Page**.
2. Select the **Device Configuration Page** page.
3. In the **SIP Volume** box, type a number between **0** (lowest) and **9** (highest).
4. Select **Save**.

2.2.13.2 The Multicast Volume Setting

To adjust the **Multicast Volume** volume with the **Multicast Volume** setting on the **Device Configuration Page**, complete the following steps:

1. Go to the **Home Page**.
2. Select the **Device Configuration Page**.
3. In the **Multicast Volume** box, type a number between **0** (lowest) and **9** (highest).
4. Select **Save**.

2.2.13.3 The Ring Volume Setting

To adjust the **Ring Volume** volume with the **Ring Volume** setting on the **Device Configuration Page**, complete the following steps:

1. Go to the **Home Page**.
2. Select the **Device Configuration Page**.
3. In the **Multicast Volume** box, type a number between **0** (lowest) and **9** (highest).
4. Select **Save**.

2.2.13.4 The Sensor Volume Setting

To adjust the **Sensor Volume** volume with the **Sensor Volume** setting on the **Device Configuration Page**, complete the following steps:

1. Go to the **Home Page**.
2. Select the **Device Configuration Page**.
3. In the **Sensor Volume** box, type a number between **0** (lowest) and **9** (highest).
4. Select **Save**.

2.2.13.5 External Volume Dial

To adjust the Singlewire InformaCast Loudspeaker Amplifier (PoE) volume with the external volume dial, complete the following steps:

1. Turn the external **Volume** dial (**Figure 2-20**) on the Singlewire InformaCast Loudspeaker Amplifier (PoE) face.

Note For the lineout volume, the volume is fixed and the volume control is adjusted through an external amplifier.

Figure 2-21. External Volume Dial

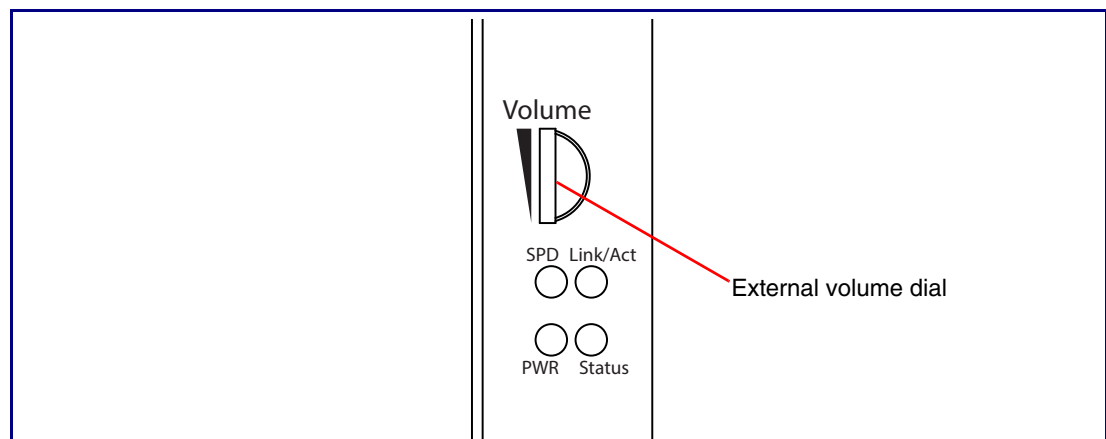

2.3 Configure the Singlewire InformaCast Loudspeaker Amplifier (PoE) Parameters

To configure the Singlewire InformaCast Loudspeaker Amplifier (PoE) online, use a standard web browser.

Configure each Singlewire InformaCast Loudspeaker Amplifier (PoE) and verify its operation *before* you mount it. When you are ready to mount an Singlewire InformaCast Loudspeaker Amplifier (PoE), refer to [Appendix A, "Mounting the Intercom"](#) for instructions.

2.3.1 Factory Default Settings

All Singlewire InformaCast Loudspeaker Amplifier (PoE)s are initially configured with the following default IP settings:

When configuring more than one Singlewire InformaCast Loudspeaker Amplifier (PoE), attach the Singlewire InformaCast Loudspeaker Amplifier (PoE)s to the network and configure one at a time to avoid IP address conflicts.

Table 2-7. Factory Default Settings



Parameter	Factory Default Setting
IP Addressing	DHCP
IP Address ^a	10.10.10.10
Web Access Username	admin
Web Access Password	admin
Subnet Mask ^a	255.0.0.0
Default Gateway ^a	10.0.0.1

a. Default if there is not a DHCP server present.

2.3.2 Singlewire InformaCast Loudspeaker Amplifier (PoE) Web Page Navigation

[Table 2-8](#) shows the navigation buttons that you will see on every Singlewire InformaCast Loudspeaker Amplifier (PoE) web page.

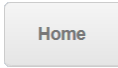
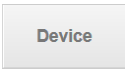
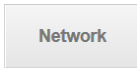
Table 2-8. Web Page Navigation

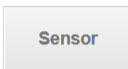
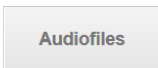
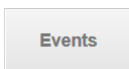
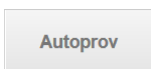
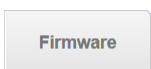
Web Page Item	Description
	Link to the Home page.
	Link to the Device page.
	Link to the Network page.
	Link to go to the SIP page.
	Link to the Multicast page.
	Link to the Sensor page.
	Link to the Audiofiles page.
	Link to the Events page.
	Link to the Autoprovisioning page.
	Link to the Firmware page.

2.3.3 Using the Toggle Help Button

The **Toggle Help** button allows you to see a short description of some of the settings on the webpage. To use the **Toggle Help** button, do the following:

1. Click on the **Toggle Help** button that is on the UI webpage. See [Figure 2-22](#) and [Figure 2-23](#).

Figure 2-22. Toggle/Help Button



2. You will see a question mark (?) appear next to each web page item that has been provided with a short description by the Help feature. See [Figure 2-23](#).

Figure 2-23. Toggle Help Button and Question Marks

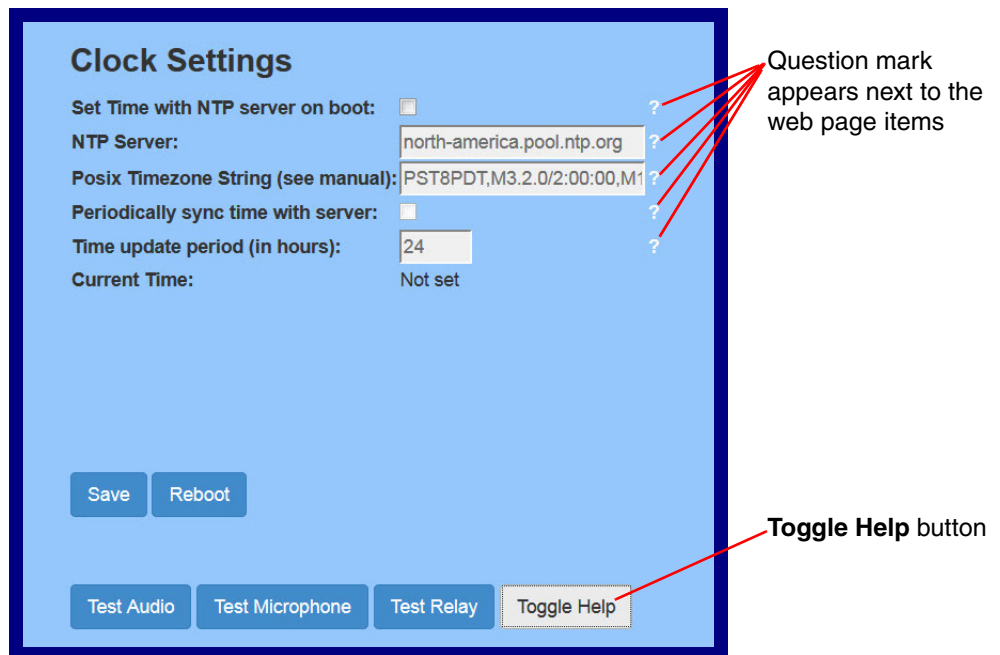

3. Move the mouse pointer to hover over the question mark (?), and a short description of the web page item will appear. See Figure 2-24.

Figure 2-24. Short Description Provided by the Help Feature

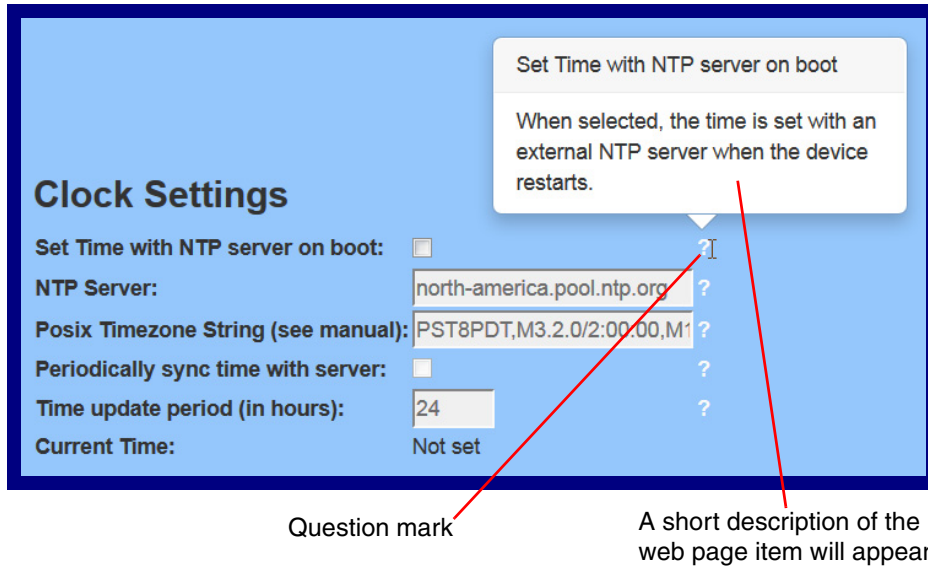

2.3.4 Log in to the Configuration Home Page

1. Open your browser to the Singlewire InformaCast Loudspeaker Amplifier (PoE) IP address.

Note If the network does not have access to a DHCP server, the device will default to an IP address of 10.10.10.10.

Note Make sure that the PC is on the same IP network as the Singlewire InformaCast Loudspeaker Amplifier (PoE).

Note You may also download CyberData's VoIP Discovery Utility program which allows you to easily find and configure the default web address of the CyberData VoIP products.

CyberData's VoIP Discovery Utility program is available at the following website address:

<http://www.cyberdata.net/assets/common/discovery.zip>

Note The device ships in DHCP mode. To get to the **Home** page, use the discovery utility to scan for the device on the network and open your browser from there.

2. When prompted, use the following default **Web Access Username** and **Web Access Password** to access the **Home Page** (Figure 2-25):

Web Access Username: **admin**

Web Access Password: **admin**

Figure 2-25. Home Page

Home Device Network SIP Multicast Sensor Audiofiles Events Autoprov Firmware

Singlewire V3.1 Paging Amplifier

Current Status

Serial Number: 407100001
Mac Address: 00:20:f7:03:6d:9a
Firmware Version: v11.6.3

IP Addressing: DHCP
IP Address: 10.10.0.77
Subnet Mask: 255.0.0.0
Default Gateway: 10.0.0.1
DNS Server 1: 10.0.1.56
DNS Server 2:

SIP Mode: Enabled
Multicast Mode: Disabled
Event Reporting: Disabled
Nightringer: Disabled

Primary SIP Server: **Not registered**
Backup Server 1: Not registered
Backup Server 2: Not registered
Nightringer Server: Not registered

Admin Settings

Username:
Password:
Confirm Password:

Singlewire Status

Boot Time: 2016/08/09 10:27:44
Current Time: 2016/08/09 10:28:53
IC Servers: 10.0.1.195
10.0.1.196
Configuration File: InformaCastSpeaker.cfg
B'casts Accepted: 0
B'casts Rejected: 0
B'casts Active: 0

Import Settings

No file chosen

Export Settings





3. On the **Home** page, review the setup details and navigation buttons described in [Table 2-9](#).

Note The question mark icon (?) in the following table shows which web page items will be defined after the **Toggle Help** button is pressed.

Table 2-9. Home Page Overview

Web Page Item	Description
Admin Settings	
Username ?	The username to access the web interface. Enter up to 25 characters.
Password ?	The password to access the web interface. Enter up to 25 characters.
Confirm Password ?	Confirm the web interface password.
Current Status	
Serial Number	Shows the device serial number.
Mac Address	Shows the device Mac address.
Firmware Version	Shows the current firmware version.
IP Addressing	Shows the current IP addressing setting (DHCP or static).
IP Address	Shows the current IP address.
Subnet Mask	Shows the current subnet mask address.
Default Gateway	Shows the current default gateway address.
DNS Server 1	Shows the current DNS Server 1 address.
DNS Server 2	Shows the current DNS Server 2 address.
SIP Mode	Shows the current status of the SIP mode.
Multicast Mode	Shows the current status of the Multicast mode.
Event Reporting	Shows the current status of the Event Reporting mode.
Nightringer	Shows the current status of the Nightringer mode.
Primary SIP Server	Shows the current status of the Primary SIP Server.
Backup Server 1	Shows the current status of Backup Server 1.
Backup Server 2	Shows the current status of Backup Server 2.
Nightringer Server	Shows the current status of Nightringer Server.
Singlewire Settings	
Boot Time	Shows the boot time.
Current Time	Shows the current time.
IC Servers	Shows the InformaCast server IP addresses.
Configuration File	Shows the configuration file.
B'casts Accepted	Shows the number of B'casts accepted.
B'casts Rejected	Shows the number of B'casts rejected.
B'casts Active	Shows the number of active B'casts.
Import Settings	
<input type="button" value="Browse..."/>	Use this button to select a configuration file to import.

Table 2-9. Home Page Overview (continued)

Web Page Item	Description
	After selecting a configuration file, click Import to import the configuration from the selected file. Then, click Save and Reboot to store changes.
Export Settings	
	Click Export to export the current configuration to a file.
	Click the Save button to save your configuration settings. Note: You need to reboot for changes to take effect.
	Click on the Reboot button to reboot the system.
	Click on the Toggle Help button to see a short description of some of the web page items. First click on the Toggle Help button, and you will see a question mark (?) appear next to some of the web page items. Move the mouse pointer to hover over a question mark to see a short description of a specific web page item.

2.3.5 Configure the Device

1. Click the **Device** menu button to open the **Device** page. See [Figure 2-26](#).

Figure 2-26. Device Configuration Page

The screenshot displays the configuration interface for a Singlewire V3.1 Paging Amplifier. The top navigation bar includes tabs for Home, Device, Network, SIP, Multicast, Sensor, Audiofiles, Events, Autopro, and Firmware. The main heading is 'Singlewire V3.1 Paging Amplifier'. The configuration is divided into several sections:

- Volume Settings (0-9):** Includes sliders for SIP Volume, Multicast Volume, Ring Volume, and Sensor Volume, all set to 4. A 'Volume Boost' dropdown is set to 'No Volume Boost'.
- Line-in Settings:** Features a checkbox for 'Enable Line-in to Line-out Loopback' which is checked.
- DTMF Settings:** Includes a 'Require Security Code' checkbox (checked) and a 'Security Code' input field.
- Clock Settings:** Includes a 'Set Time with NTP server on boot' checkbox (checked), an 'NTP Server' field with 'north-america.pool.ntp.org', a 'Posix Timezone String' field with 'PST8PDT,M3.2.0/2:00:00,M11', and a 'Time update period' set to 24 hours.
- Relay Settings:** Includes a checked 'Activate Relay with DTMF code' checkbox, and input fields for 'Relay Pulse Code' (123), 'Relay Pulse Duration' (2), 'Relay Activation Code' (456), and 'Relay Deactivation Code' (654). Other options like 'Activate Relay During Ring' are unchecked.
- Power Settings:** Shows '802.3AT Mode' as 'Detected and enabled', 'Force 802.3AT Mode' as unchecked, and 'Auxiliary Power Supply' as unchecked.
- Misc Settings:** Includes 'Device Name' (Singlewire V3.1 Paging Am), 'Auto-Answer Incoming Calls' (checked), 'Beep on Init' (unchecked), 'Beep on Page' (unchecked), 'Disable HTTPS' (unchecked), 'Two Speakers Connected' (checked), and 'RGB Strobe' (Installed).
- Singlewire Broadcast Strobe Settings:** A table with 10 rows for different scenes, each with a 'Priority', 'Scene', 'Color', 'Brightness', and RGB values (Red, Green, Blue), and a 'Preview' button.

At the bottom of the page, there are buttons for 'Test Audio', 'Test Relay', 'Save', 'Reboot', and 'Toggle Help'.

2. On the **Device** page, you may enter values for the parameters indicated in [Table 2-10](#).

Note The question mark icon (?) in the following table shows which web page items will be defined after the **Toggle Help** button is pressed.

Table 2-10. Device Configuration Parameters

Web Page Item	Description
Volume Settings (0-9)	
Disable Volume Control Dial ?	Select this option to disable the volume control dial and enable digital volume control settings.
SIP Volume ?	Set the speaker volume for a SIP call. A value of 0 will mute the speaker during SIP calls.
Multicast Volume ?	Set the speaker volume for multicast audio streams. A value of 0 will mute the speaker during multicasts.
Ring Volume ?	Set the ring volume for incoming calls. A value of 0 will mute the speaker instead of playing the ring tone when Auto-Answer Incoming Calls is disabled.
Sensor Volume ?	Set the speaker volume for playing sensor activated audio. A value of 0 will mute the speaker during sensor activated audio.
Volume Boost: ? No Volume Boost Volume Boost 1 Volume Boost 2 Volume Boost 3	<p>Set the Boost level to increase the volume output of the speaker. Using Volume Boost may introduce audio clips or lessen the effectiveness of the echo canceler. Boost is only recommended for use with volumes set to level 9.</p> <p>Normal operation of the product can be met with volume levels 0 through 9. 0 being mute and 9 being the loudest volume that in a normal arm's length and average background noise, will enable full duplex operation and give the best quality of sound output.</p> <p>The volume boost options increase the output of the speaker by:</p> <ul style="list-style-type: none"> 3db for Boost level 1 6db for Boost level 2 9db for Boost level 3 <p>If the user would like a higher output from the speaker, the Boost settings are available. However, operation in Boost Mode may overdrive or clip the audio if, for example, the phone that is connected has a high microphone gain or if the person has a loud voice talking too close to the microphone.</p> <p>The acoustic echo canceller also has a harder time maintaining full duplex operation when in the Boost Mode. The product may drop from full duplex operation into half/duplex mode while in Boost Mode.</p> <p>Contact CyberData support for additional information if needed.</p>
Clock Settings	
Set Time with NTP Server on boot ?	When selected, the time is set with an external NTP server when the device restarts.
NTP Server ?	Use this field to set the address (in IPv4 dotted decimal notation or as a canonical name) for the NTP Server. This field can accept canonical names of up to 64 characters in length.

Table 2-10. Device Configuration Parameters (continued)

Web Page Item	Description
Posix Timezone String ?	See Section 2.3.5.1, "Time Zone Strings" for information about how to use the Posix Timezone String to specify time zone and daylight savings time where applicable. Enter up to 63 characters.
Periodically sync time with server ?	When selected, the time is periodically updated with the NTP server at the configured interval below.
Time update period (in hours) ?	The time interval after which the device will contact the NTP server to update the time. Enter up to 4 digits.
Current Time ?	Allows you to input the current time. (6 character limit)
Power Settings	
802.3AT Mode ?	This device automatically detects if it is plugged into an 802.3AT (also known as PoE Plus) power source. 802.3AT provides more power than older 802.3AT power sources and allows this speaker to play audio at higher volumes. If you are sure this speaker is connected to an 802.3AT power source, but it is not being detected correctly, you can override the automatic settings below.
Force 802.3AT Mode (NOT recommended) ?	Enable this option if you are sure this speaker is connected to an 802.3AT power source, but it is not being detected correctly (not recommended).
Auxiliary Power Supply ?	This device can be connected to a +24VDC auxiliary power supply. Check this box if this is how this speaker is being powered.
Singlewire Broadcast Strobe Settings	
	For up to 10 Singlewire pages, when a priority is specified for the page, a corresponding strobe scene will be activated. The color may be selected from the drop down menu, or customized by the user with the 0-255 scale. Brightness is specified with a value between 0 and 100.
Priority ?	Indicates the priority of the Singlewire broadcast, with 1 the highest priority and 10 the lowest.
Scene ?	Use this section to select the strobe flashing behavior for the Singlewire Broadcast.
ADA Compliant ?	Strobe will blink ON at the specified brightness for 150ms then OFF for 350ms during the duration of the event.
Slow Fade ?	Strobe will increase in brightness from 0 to the specified brightness and back to 0 over the course of about 3.5 seconds during the duration of the event.
Fast Fade ?	Strobe will increase in brightness from 0 to the specified brightness and back to 0 over the course of about 1.5 seconds during the duration of the event.
Slow Blink ?	Strobe will blink ON at the specified brightness for one second then OFF for one second during the duration of the event.
Fast Blink ?	Strobe will blink ON at the specified brightness then OFF five times per second during the duration of the event.
Color ?	Select the desired color (only one may be chosen).
Brightness ?	How bright the strobe will blink when there is a Singlewire Broadcast. This is the maximum brightness for "fade" type scenes.
Red ?	The red LED value for the Singlewire Broadcast.
Green ?	The green LED value for the Singlewire Broadcast.
Blue ?	The blue LED value for the Singlewire Broadcast.

Table 2-10. Device Configuration Parameters (continued)





















Web Page Item	Description
	Use this button to preview the strobe flashing behavior for the Singlewire Broadcast Strobe Settings .
Line-In Settings	
Enable Line-in to Line-out Loopback 	Line-in audio will play back out the device's audio output ports. This is the lowest priority audio and will be preempted by any other audio stream.
DTMF Settings	
Require Security Code 	When selected, the user will be prompted to enter a Security Code (entered on this page) before being able to execute a page when calling the device.
Security Code 	Type the Security Code in this field. The Security Code must only use characters '0-9', '*' and '#'. Enter up to 25 characters.
Relay Settings	
Activate Relay with DTMF Code 	Activates the relay when the DTMF Activation Code is entered on the phone during a SIP call with the device. RFC2833 DTMF payload types are supported.
Relay Pulse Code 	DTMF code used to pulse the relay when entered on a phone during a SIP call with the device. Relay will activate for Relay Pulse Duration seconds then deactivate. Activate Relay with DTMF Code must be enabled. Enter up to 25 digits (* and # are supported).
Relay Pulse Duration (in seconds) 	The length of time (in seconds) during which the relay will be activated when the DTMF Relay Activation Code is detected. Enter up to 5 digits.
Relay Activation Code 	Activation code used to activate the relay when entered on a phone during a SIP call with the device. Relay will be active indefinitely, or until the DTMF Relay Deactivation code is entered. Activate Relay with DTMF Code must be enabled. Enter up to 25 digits (* and # are supported).
Relay Deactivation Code 	Code used to deactivate the relay when entered on a phone during a SIP call with the device. Activate Relay with DTMF Code must be enabled. Enter up to 25 digits (* and # are supported).
Activate Relay During Ring 	When selected, the relay will be activated for as long as the device is ringing. When Auto-Answer Incoming Calls is enabled, the device will not ring and this option does nothing.
Activate Relay During Night Ring 	When selected, the relay will be activated as long as the Nightringer extension is ringing.
Activate Relay While Call Active 	When selected, the relay will be activated as long as the SIP call is active.
Misc Settings	
Device Name 	Type the device name. Enter up to 25 characters.
Auto-Answer Incoming Calls 	When selected, the device will automatically answer incoming calls. When Auto-Answer Incoming Calls is disabled, the device will play a ring tone (corresponds to Ring Tone on the Audiofiles page) out of the speaker.
Beep on Init 	Device will play the user-defined "pagetone" audio file when it boots.
Beep on Page 	Device will play the user defined "pagetone" audio file before playing a SIP page.

Table 2-10. Device Configuration Parameters (continued)

Web Page Item	Description
Disable HTTPS (NOT recommended) ?	Disables the encrypted connection to the webpage. We do not recommend disabling HTTPS for security reasons.
Two Speakers Connected ?	Specify if one or two speakers are connected to the paging amplifier. If only one is connected, ensure that it is wired to the first set of terminal blocks.
RGB Strobe ?	Status of optional RGB Strobe.
	Click on the Test Audio button to do an audio test. When the Test Audio button is pressed, you will hear a voice message for testing the device audio quality and volume.
	Click on the Test Relay button to do a relay test.
	Click the Save button to save your configuration settings. Note: You need to reboot for changes to take effect.
	Click on the Reboot button to reboot the system.
	Click on the Toggle Help button to see a short description of some of the web page items. First click on the Toggle Help button, and you will see a question mark (?) appear next to some of the web page items. Move the mouse pointer to hover over a question mark to see a short description of a specific web page item.

Note You can change the **SIP Volume**, **Multicast Volume**, **Ring Volume**, and **Sensor Volume** without rebooting the device. You must save and reboot the device for other changes to take effect.

2.3.5.1 Time Zone Strings

The posix time zone string tells the internal date and time utilities how to handle daylight savings time for different time zones. [Table 2-23](#) shows some common strings.

Table 2-11. Common Time Zone Strings

Time Zone	Time Zone String
US Pacific time	PST8PDT,M3.2.0/2:00:00,M11.1.0/2:00:00
US Mountain time	MST7MDT,M3.2.0/2:00:00,M11.1.0/2:00:00
US Eastern Time	EST5EDT,M3.2.0/2:00:00,M11.1.0/2:00:00
Phoenix Arizona ^a	MST7
US Central Time	CST6DST,M3.2.0/2:00:00,M11.1.0/2:00:00

a. Phoenix, Arizona does not use daylight savings time.

[Table 2-24](#) shows a breakdown of the parts that constitute the following time zone string:

- ***CST6DST,M3.2.0/2:00:00,M11.1.0/2:00:00***

Table 2-12. Time Zone String Parts

Time Zone String Part	Meaning
CST6CDT	The time zone offset from GMT and three character identifiers for the time zone.
CST	Central Standard Time
6	The (hour) offset from GMT/UTC
CDT	Central Daylight Time
M3.2.0/2:00:00	The date and time when daylight savings begins.
M3	The third month (March)
.2	The 2nd occurrence of the day (next item) in the month
.0	Sunday
/2:00:00	Time of day to change
M11.1.0/2:00:00	The date and time when daylight savings ends.
M11	The eleventh month (November)
.1	The 1st occurrence of the day (next item) in the month
.0	Sunday
/2:00:00	Time of day to change

Time Zone String Examples

[Table 2-25](#) has some more examples of time zone strings.

Table 2-13. Time Zone String Examples

Time Zone	Time Zone String
Tokyo ^a	IST-9
Berlin ^b	CET-1MET,M3.5.0/1:00,M10.5.0/1:00

a. Tokyo does not use daylight savings time.

b. For Berlin, daylight savings time starts on the last Sunday in March at 01:00 UTC, and ends on the last Sunday in October at 01:00 UTC, and is one hour ahead of UTC.

Time Zone Identifier A user-definable three or four character time zone identifier (such as PST, EDT, IST, MUT, etc) is needed at the beginning of the posix time zone string to properly set the time. However, the specific letters or numbers used for the time zone identifier are not important and can be any three or four letter or number combination that is chosen by the user. However, the time zone identifier cannot be blank.

Figure 2-27. Three or Four Character Time Zone Identifier

You can also use the following URL when a certain time zone applies daylight savings time:

<http://www.timeanddate.com/time/dst/2011.html>

World GMT Table

[Table 2-26](#) has information about the GMT time in various time zones.

Table 2-14. World GMT Table

Time Zone	City or Area Zone Crosses
GMT-12	Eniwetok
GMT-11	Samoa
GMT-10	Hawaii
GMT-9	Alaska
GMT-8	PST, Pacific US
GMT-7	MST, Mountain US
GMT-6	CST, Central US
GMT-5	EST, Eastern US
GMT-4	Atlantic, Canada
GMT-3	Brazilia, Buenos Aries
GMT-2	Mid-Atlantic
GMT-1	Cape Verdes
GMT	Greenwich Mean Time, Dublin
GMT+1	Berlin, Rome
GMT+2	Israel, Cairo
GMT+3	Moscow, Kuwait
GMT+4	Abu Dhabi, Muscat

Table 2-14. World GMT Table (continued)

Time Zone	City or Area Zone Crosses
GMT+5	Islamabad, Karachi
GMT+6	Almaty, Dhaka
GMT+7	Bangkok, Jakarta
GMT+8	Hong Kong, Beijing
GMT+9	Tokyo, Osaka
GMT+10	Sydney, Melbourne, Guam
GMT+11	Magadan, Soloman Is.
GMT+12	Fiji, Wellington, Auckland

2.3.6 Configure the Network Parameters

1. Click the **Network** menu button to open the **Network** page (Figure 2-28).

Figure 2-28. Network Configuration Page

Home Device **Network** SIP Multicast Sensor Audiofiles Events Autoprov Firmware

Singlewire V3.1 Paging Amplifier

Stored Network Settings

Addressing Mode: Static DHCP

Hostname:

IP Address:

Subnet Mask:

Default Gateway:

DNS Server 1:

DNS Server 2:

DHCP Timeout in seconds*:

* A value of -1 will retry forever

VLAN Settings

VLAN ID (0-4095):

VLAN Priority (0-7):

Save Reboot Toggle Help

Current Network Settings

IP Address: 10.10.0.77
Subnet Mask: 255.0.0.0
Default Gateway: 10.0.0.1
DNS Server 1: 10.0.1.56
DNS Server 2:



2. On the **Network** page, enter values for the parameters indicated in [Table 2-15](#).

Note The question mark icon (?) in the following table shows which web page items will be defined after the **Toggle Help** button is pressed.

Table 2-15. Network Configuration Parameters

Web Page Item	Description
Stored Network Settings	
Addressing Mode ?	Select either DHCP IP Addressing or Static Addressing by marking the appropriate radio button. DHCP Addressing mode is enabled on default and the device will attempt to resolve network addressing with the local DHCP server upon boot. If DHCP Addressing fails, the device will revert to the last known IP address or the factory default address if no prior DHCP lease was established. See Section 2.3.1, "Factory Default Settings" for factory default settings. Be sure to click Save and Reboot to store changes when configuring a Static address.
Hostname ?	This is the hostname provided by the DHCP server. See the DHCP/DNS server documentation for more information. Enter up to 64 characters.
IP Address ?	Enter the Static IPv4 network address in dotted decimal notation.
Subnet Mask ?	Enter the Subnet Mask in dotted decimal notation.
Default Gateway ?	Enter the Default Gateway IPv4 address in dotted decimal notation.
DNS Server 1 ?	Enter the primary DNS Server IPv4 address in dotted decimal notation.
DNS Server 2 ?	Enter the secondary DNS Server IPv4 address in dotted decimal notation.
DHCP Timeout in seconds ?	Specify the desired time-out duration (in seconds) that the device will wait for a response from the DHCP server before reverting back to the stored static IP address. The stored static IP address may be the last known IP address or the factory default address if no prior DHCP lease was established. Enter up to 8 characters. A value of -1 will retry forever.
Current Network Settings	
IP Address	Shows the current Static IP address.
Subnet Mask	Shows the current Subnet Mask address.
Default Gateway	Shows the current Default Gateway address.
DNS Server 1	Shows the current DNS Server 1 address.
DNS Server 2	Shows the current DNS Server 2 address.
VLAN Settings	
VLAN ID (0-4095) ?	Specify the IEEE 802.1Q VLAN ID number. Enter up to 4 digits. Note: The device supports 802.1Q VLAN tagging support. The switch port connected to the device will need to be in "trunking mode" for the VLAN tags to propagate.
VLAN Priority (0-7) ?	Specify the IEEE 802.1p VLAN priority level. Enter 1 digit. A value of 0 may cause the VLAN ID tag to be ignored.

Table 2-15. Network Configuration Parameters (continued)

Web Page Item	Description
	Click the Save button to save your configuration settings. Note: You need to reboot for changes to take effect.
	Click on the Reboot button to reboot the system.
	Click on the Toggle Help button to see a short description of some of the web page items. First click on the Toggle Help button, and you will see a question mark (?) appear next to some of the web page items. Move the mouse pointer to hover over a question mark to see a short description of a specific web page item.

Note You must click on the **Save** button and then the **Reboot** button for the changes to take effect.

2.3.7 Configure the SIP (Session Initiation Protocol) Parameters

1. Click on the **SIP** menu button to open the **SIP** page (Figure 2-29).

Figure 2-29. SIP Configuration Page

The screenshot displays the SIP Configuration Page for a Singlewire V3.1 Paging Amplifier. The page is divided into several sections:

- SIP Settings:** Includes checkboxes for 'Enable SIP operation' and 'Register with a SIP Server'. Below these are text input fields for 'Use Cisco SRST', 'Primary SIP Server' (10.0.0.253), 'Primary SIP User ID' (199), 'Primary SIP Auth ID' (199), and 'Primary SIP Auth Password' (masked with asterisks). There are also fields for 'Backup SIP Server 1', 'Backup SIP User ID 1', 'Backup SIP Auth ID 1', 'Backup SIP Auth Password 1', 'Backup SIP Server 2', 'Backup SIP User ID 2', 'Backup SIP Auth ID 2', and 'Backup SIP Auth Password 2'. At the bottom of this section are 'Remote SIP Port' (5060), 'Local SIP Port' (5060), 'Outbound Proxy', 'Outbound Proxy Port' (0), 'Disable rport Discovery', 'Buffer SIP Calls', 'Re-registration Interval (in seconds)' (360), 'Unregister on Boot', and 'Keep Alive Period' (10000).
- Nightringer Settings:** Includes a checkbox for 'Enable Nightringer'. Below are text input fields for 'SIP Server' (10.0.0.253), 'Remote SIP Port' (5060), 'Local SIP Port' (5061), 'Outbound Proxy', 'Outbound Proxy Port' (0), 'User ID' (241), 'Authenticate ID' (241), 'Authenticate Password' (masked with asterisks), and 'Re-registration Interval (in seconds)' (360).
- Nightringer Strobe Settings:** Includes a checkbox for 'Blink Strobe on Nightringer', a text input for 'Nightringer Strobe Brightness' (100), and radio buttons for 'ADA Compliant', 'Slow Fade', 'Fast Fade', 'Slow Blink', and 'Fast Blink'. There is a 'Color' dropdown menu set to 'Blue' and input fields for 'Red' (0), 'Green' (0), and 'Blue' (255). A 'Preview' button is located at the bottom of this section.

Figure 2-30. SIP Configuration Page

The screenshot displays the SIP Configuration Page with the following sections and settings:

- SIP Strobe Settings**
 - Blink Strobe on Ring:
 - SIP Call Strobe Brightness: 100
 - ADA Compliant:
 - Slow Fade:
 - Fast Fade:
 - Slow Blink:
 - Fast Blink:
 - SIP Call Color: Green
 - Red: 0
 - Green: 255
 - Blue: 0
 - Preview button
- MWI Strobe Settings**
 - Blink Strobe on MWI:
 - MWI Strobe Brightness: 100
 - ADA Compliant:
 - Slow Fade:
 - Fast Fade:
 - Slow Blink:
 - Fast Blink:
 - MWI Color: Yellow
 - Red: 255
 - Green: 255
 - Blue: 0
 - Preview button
- RTP Settings**
 - RTP Port (even): 10500
 - Jitter Buffer: 50
- Call Disconnection**
 - Terminate Call after delay: 0
- Codec Selection**
 - Force Selected Codec:
 - Codec: PCMU (G.711, u-law)

At the bottom of the page, there are three buttons: Save, Reboot, and Toggle Help.

2. On the **SIP** page, enter values for the parameters indicated in [Table 2-16](#).

Note The question mark icon (?) in the following table shows which web page items will be defined after the **Toggle Help** button is pressed.

Table 2-16. SIP Configuration Parameters

Web Page Item	Description
SIP Settings	
Enable SIP Operation ?	When enabled, the device will transmit, receive, and process SIP messages according to the configured SIP settings below.
Register with a SIP Server ?	When enabled, the device will attempt to register to the configured SIP Server(s) on this page. To configure the device to send and receive point-to-point SIP calls, enable SIP Operation and disable Register with a SIP Server (see Section 2.3.7.2, "Point-to-Point Configuration").
Use Cisco SRST ?	When enabled, the backup servers are handled according to Cisco SRST (Survivable Remote Site Telephony). It is required for use in clustered Cisco Unified Communications Manager topologies.
Primary SIP Server ?	Enter the SIP server address as an IPv4 address in dotted decimal notation or a fully qualified domain name. This parameter also becomes the host portion of the SIP-URI for the device's extension on the primary SIP server. This field can accept entries of up to 255 characters in length.
Primary SIP User ID ?	Specify the SIP User ID for the Primary SIP Server. This parameter becomes the user portion of the SIP-URI for the device's extension on the primary SIP server. Enter up to 64 alphanumeric characters.
Primary SIP Auth ID ?	Specify the Authenticate ID for the Primary SIP Server. This parameter is required for SIP registration authentication. Enter up to 64 alphanumeric characters.
Primary SIP Auth Password ?	Specify the Authenticate Password for the Primary SIP Server. This parameter is required for SIP registration authentication. Enter up to 64 alphanumeric characters.
Backup SIP Server 1 ?	Enter the backup SIP server address as an IPv4 address in dotted decimal notation or a fully qualified domain name. This parameter also becomes the host portion of the SIP-URI for the device's extension on the backup SIP server. This field can accept entries of up to 255 characters in length.
Backup SIP User ID 1 ?	Specify the SIP User ID for the first backup SIP Server. This parameter becomes the user portion of the SIP-URI for the device's extension on the first backup SIP server. Enter up to 64 alphanumeric characters.
Backup SIP Auth ID 1 ?	Specify the Authenticate ID for the first backup SIP server. This parameter is required for SIP registration authentication. Enter up to 64 alphanumeric characters.
Backup SIP Auth Password 1 ?	Specify the Authenticate Password for the first backup SIP server. This parameter is required for SIP registration authentication. Enter up to 64 alphanumeric characters.
Backup SIP Server 2 ?	Enter a second backup SIP server address as an IPv4 address in dotted decimal notation or a fully qualified domain name. This parameter also becomes the host portion of the SIP-URI for the device's extension on the second backup SIP server. This field can accept entries of up to 255 characters in length.

Table 2-16. SIP Configuration Parameters (continued)

Web Page Item	Description
Backup SIP User ID 2 ?	Specify the SIP User ID for the second backup SIP Server. This parameter becomes the user portion of the SIP-URI for the device's extension on the second backup SIP server. Enter up to 64 alphanumeric characters.
Backup SIP Auth ID 2 ?	Specify the Authenticate ID for the second backup SIP server. This parameter is required for SIP registration authentication. Enter up to 64 alphanumeric characters.
Backup SIP Auth Password 2 ?	Specify the Authenticate Password for the second backup SIP server. This parameter is required for SIP registration authentication. Enter up to 64 alphanumeric characters.
Remote SIP Port ?	The Remote SIP Port is the port number the device will use as the destination port when sending SIP messages. The default Remote SIP Port is 5060. The supported range is 0-65536. Enter up to 5 digits.
Local SIP Port ?	The Local SIP Port is the port number the device will use to receive SIP messages. The default Local SIP Port is 5060. The supported range is 0-65536. Enter up to 5 digits.
Outbound Proxy ?	Enter the Outbound Proxy address as an IPv4 address in dotted decimal notation or a fully qualified domain name (FQDN). When an IP address is configured, the device will send all SIP messages to this IP address. When an FQDN is configured, the device will run DNS NAPTR, SRV, and A queries on the FQDN to resolve an IP address to which it will send all SIP messages. This field can accept entries of up to 255 characters in length.
Outbound Proxy Port ?	The Outbound Proxy Port is port number used as the destination port when sending SIP messages to the outbound proxy. A value of 0 will default to 5060. The supported range is 0-65536. Enter up to 5 digits.
Disable rport Discovery ?	Disabling rport Discovery will prevent the device from including the public WAN IP address and port number in the contact information that is sent to the remote SIP servers. This will generally only need to be enabled when using an SBC or SIP ALG in conjunction with a remote SIP server.
Buffer SIP Calls ?	Also referred to as delayed paging. Device will buffer up to 4 minutes of audio then play back the recording after hang up.
Re-registration Interval (in seconds) ?	The SIP Re-registration interval (in seconds) is the SIP Registration lease time, also known as the expiry. The supported range is 30-3600 seconds. Enter up to 4 digits.
Unregister on Boot ?	When enabled, the device will send one registration with an expiry of 0 on boot.
Keep Alive Period ?	The minimum time in milliseconds between keep-alive packets sent for nat traversal. A value of 0 will disable keep alive packets.
SIP Strobe Settings	
Blink Strobe on Ring ?	When selected, the Strobe will blink a scene when ringing.
SIP Call Strobe Brightness ?	How bright the strobe will blink when there is a SIP Call. This is the maximum brightness for "fade" type scenes.
ADA Compliant ?	Strobe will blink ON at the specified brightness for 150ms then OFF for 350ms during the duration of the event.
Slow Fade ?	Strobe will increase in brightness from 0 to the specified brightness and back to 0 over the course of about 3.5 seconds during the duration of the event.

Table 2-16. SIP Configuration Parameters (continued)



















Web Page Item	Description
Fast Fade ?	Strobe will increase in brightness from 0 to the specified brightness and back to 0 over the course of about 1.5 seconds during the duration of the event.
Slow Blink ?	Strobe will blink ON at the specified brightness for one second then OFF for one second during the duration of the event.
Fast Blink ?	Strobe will blink ON at the specified brightness then OFF five times per second during the duration of the event.
SIP Call Color ?	Select desired color (only one may be chosen).
Red ?	The red LED value for SIP Call.
Green ?	The green LED value for SIP Call.
Blue ?	The blue LED value for SIP Call.
	Use this button to preview the strobe flashing behavior for the MWI Strobe Settings .
MWI Strobe Settings	
Blink Strobe on MWI ?	When selected, the strobe will blink a scene when a voicemail is waiting for its extension.
MWI Strobe Brightness ?	How bright the strobe will blink when there is a message waiting. This is the maximum brightness for “fade” type scenes.
ADA Compliant ?	Strobe will blink ON at the specified brightness for 150ms then OFF for 350ms during the duration of the event.
Slow Fade ?	Strobe will increase in brightness from 0 to the specified brightness and back to 0 over the course of about 3.5 seconds during the duration of the event.
Fast Fade ?	Strobe will increase in brightness from 0 to the specified brightness and back to 0 over the course of about 1.5 seconds during the duration of the event.
Slow Blink ?	Strobe will blink ON at the specified brightness for one second then OFF for one second during the duration of the event.
Fast Blink ?	Strobe will blink ON at the specified brightness then OFF five times per second during the duration of the event.
MWI Call Color ?	Select desired color (only one may be chosen).
Red ?	The red LED value for MWI.
Green ?	The green LED value for MWI.
Blue ?	The blue LED value for MWI.
	Use this button to preview the strobe flashing behavior for the MWI Strobe Settings .
Nightringer Settings	
Enable Nightringer ?	When Nightringer is enabled, the device will attempt to register a second extension with the SIP server. Any calls made to this extension will play a ringtone (corresponds to Night Ring on the Audiofiles page). By design, it is not possible to answer a call to the Nightringer extension.

Table 2-16. SIP Configuration Parameters (continued)

Web Page Item	Description
SIP Server ?	Enter the SIP server address as an IPv4 address in dotted decimal notation or a fully qualified domain name. This parameter also becomes the host portion of the SIP-URI for the device's Nightringer extension on the SIP server. This field can accept entries of up to 255 characters in length.
Remote SIP Port ?	The Remote SIP Port is the port number the device will use as the destination port when sending SIP messages for the Nightringer extension. The default Remote SIP Port is 5060. The supported range is 0-65536. Enter up to 5 digits.
Local SIP Port ?	The Local SIP Port is the port number the device will use to receive SIP messages for the Nightringer extension. This value cannot be the same as the Local SIP Port for the primary extension. The default Local SIP Port is 5061. The supported range is 0-65536. Enter up to 5 digits.
Outbound Proxy ?	Enter the Outbound Proxy address as an IPv4 address in dotted decimal notation or a fully qualified domain name (FQDN). When an IP address is configured, the device will send all SIP messages to this IP address for the Nightringer extension. When an FQDN is configured, the device will run DNS NAPTR, SRV, and A queries on the FQDN to resolve an IP address to which it will send all SIP messages for the Nightringer extension. This field can accept entries of up to 255 characters in length.
Outbound Proxy Port ?	The Outbound Proxy Port is port number used as the destination port when sending SIP messages to the outbound proxy for the Nightringer extension. A value of 0 will default to 5060. The supported range is 0-65536. Enter up to 5 digits.
User ID ?	Specify the SIP User ID for the SIP server. This parameter becomes the user portion of the SIP-URI for the device's Nightringer extension. Enter up to 64 alphanumeric characters.
Authenticate ID ?	Specify the Authenticate ID for the SIP Server. This parameter is required for SIP registration authentication. Enter up to 64 alphanumeric characters.
Authenticate Password ?	Specify the Authenticate Password for the SIP Server. This parameter is required for SIP registration authentication. Enter up to 64 alphanumeric characters.
Re-registration Interval (in seconds) ?	The SIP Re-registration Interval (in seconds) is the SIP Registration lease time, also known as the expiry. The supported range is 30-3600 seconds. Enter up to 4 digits.
Nightringer Strobe Settings	
Blink Strobe on Nightring ?	When selected, the Strobe will blink a scene when the Nightringer is ringing.
Nightringer Strobe Brightness ?	How bright the strobe will blink when the Nightringer is ringing. This is the maximum brightness for "fade" type scenes.
ADA Compliant ?	Strobe will blink ON at the specified brightness for 150ms then OFF for 350ms during the duration of the event.
Slow Fade ?	Strobe will increase in brightness from 0 to the specified brightness and back to 0 over the course of about 3.5 seconds during the duration of the event.

Table 2-16. SIP Configuration Parameters (continued)

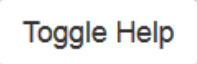
Web Page Item	Description
Fast Fade 	Strobe will increase in brightness from 0 to the specified brightness and back to 0 over the course of about 1.5 seconds during the duration of the event.
Slow Blink 	Strobe will blink ON at the specified brightness for one second then OFF for one second during the duration of the event.
Fast Blink 	Strobe will blink ON at the specified brightness then OFF five times per second during the duration of the event.
Nightringer Call Color 	Select desired color (only one may be chosen).
Red 	The red LED value for Nightringer.
Green 	The green LED value for Nightringer.
Blue 	The blue LED value for Nightringer.
	Use this button to preview the strobe flashing behavior for the Nightringer Strobe Settings .
RTP Settings	
RTP Port (even) 	Specify the port number used for the RTP stream after establishing a SIP call. This port number must be an even number and defaults to 10500. The supported range is 0-65536. Enter up to 5 digits.
Jitter Buffer 	Specify the size of the jitter buffer (in milliseconds) used for SIP calls. Valid values are 50-1000.
Call Disconnection	
Terminate Call After Delay 	Automatically terminate an active call after a given delay in seconds. A value of 0 will disable this function. Enter up to 8 digits.
Codec Selection	
Force Selected Codec 	When configured, this option will allow you to force the device to negotiate for the selected codec. Otherwise, the device will perform codec negotiation using the default list of supported codecs.
Codec 	Select the desired codec (only one may be chosen).
	Click the Save button to save your configuration settings. Note: You need to reboot for changes to take effect.
	Click on the Reboot button to reboot the system.
	Click on the Toggle Help button to see a short description of some of the web page items. First click on the Toggle Help button, and you will see a question mark () appear next to some of the web page items. Move the mouse pointer to hover over a question mark to see a short description of a specific web page item.

Note You must click on the **Save** button and then the **Reboot** button for the changes to take effect.

Note For specific server configurations, go to the following website address:

<http://www.cyberdata.net/connecting-to-ip-pbx-servers/>

2.3.7.1 Dial Out Extension Strings and DTMF Tones (using rfc2833)

On the [SIP Configuration Page](#), dial out extensions support the addition of comma delimited pauses and sending additional DTMF tones (using rfc2833). The first comma will pause three seconds after a call is first established with a remote device. Subsequent commas will pause for 2 seconds. A pause of one second will be sent after each numerical digit.

Table 2-17. Examples of Dial-Out Extension Strings

Extension String	Resulting Action
302	Dial out extension 302 and establish a call
302,2	Dial out extension 302 and establish a call, wait 3 seconds then send the DTMF tone '2'
302,25,,,4,,1	Dial out extension 302 and establish a call, wait 3 seconds then send the DTMF tone '2', send out DTMF tone 5, wait 6 seconds, send out DTMF tone 4, wait 4 seconds, send out DTMF tone 1

Note The maximum number of total characters in the dial-out field is 64.

2.3.7.2 Point-to-Point Configuration

When the device is set to not register with a SIP server (see [Figure 2-31](#)), it is possible to set the device to dial out to a single endpoint.

In this case, the dial-out extension should be the IP address of the remote device. The device can also receive Point-to-Point calls. The delayed DTMF functionality is available in the Point-to-Point Mode.

Note Receiving point-to-point SIP calls may not work with all phones.

Figure 2-31. SIP Page Set to Point-to-Point Mode

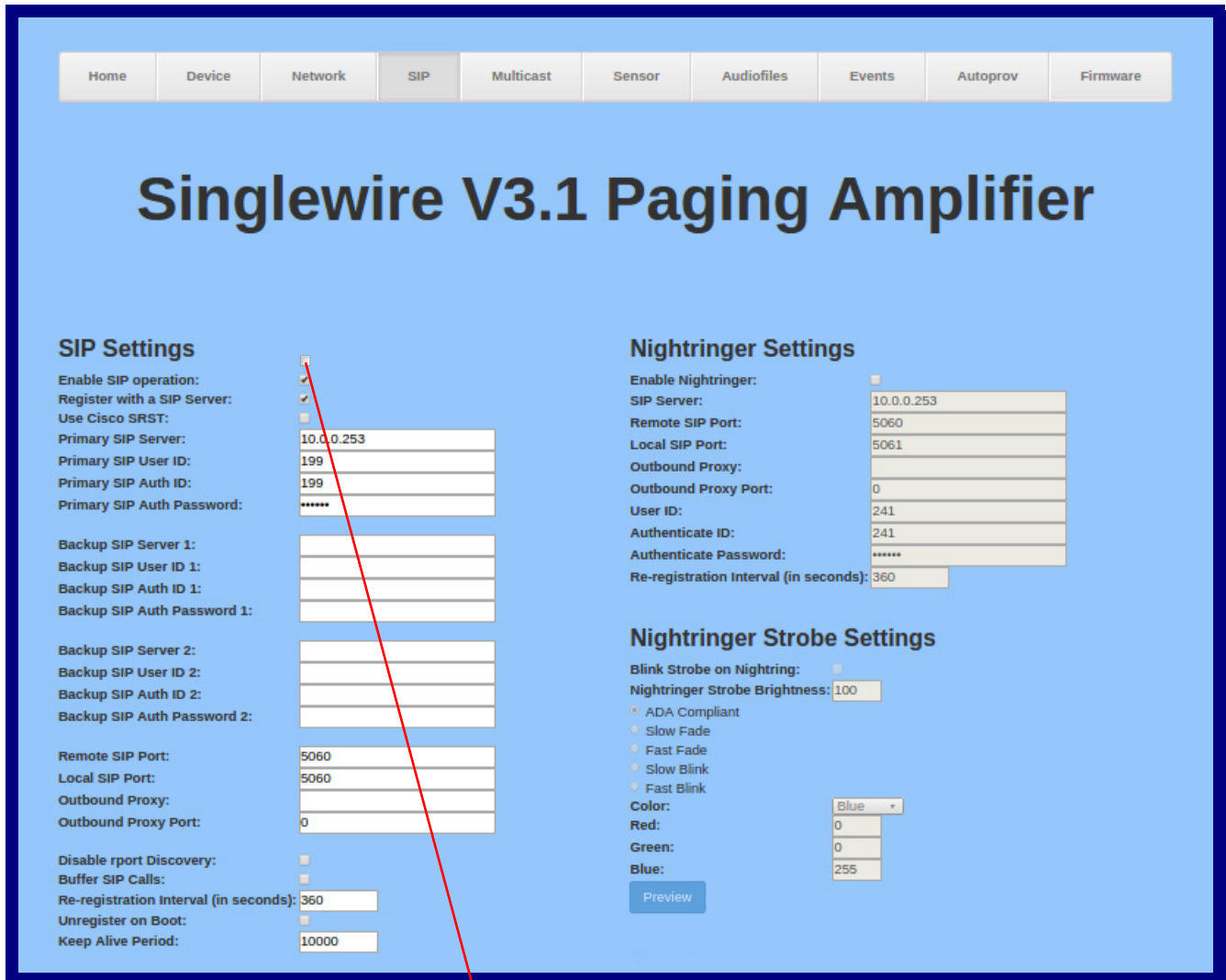

Device is set to NOT register with a SIP server

2.3.7.3 Delayed DTMF

On the **SIP Configuration** page the dial out extension supports the addition of comma delimited pauses and sending additional DTMF tones (using rfc2833). The first comma will pause three seconds after a call is first established with a remote device. Subsequent commas will pause for 2 seconds. A pause of one second will be sent after each numerical digit.

Table 2-18. Examples of Dial-Out Extension Strings

Extension String	Resulting Action
302	Dial out extension 302 and establish a call
302,2	Dial out extension 302 and establish a call, wait 3 seconds then send the DTMF tone '2'
302,25,,,4,,1	Dial out extension 302 and establish a call, wait 3 seconds then send the DTMF tone '2', send out DTMF tone 5, wait 6 seconds, send out DTMF tone 4, wait 4 seconds, send out DTMF tone 1

Note The maximum number of total characters in the dial-out field is 25.

2.3.8 Configure the Multicast Parameters

The Multicast Configuration page allows the device to join up to ten paging zones for receiving ulaw/alaw encoded RTP audio streams.

A paging zone can consist of one or many CyberData multicast group-enabled products. There is no limit to how many speakers can be in a given paging zone. Each multicast group is defined by a multicast address and port number.

Each multicast group is assigned a priority, allowing simultaneously arriving pages to be serviced based on importance. Multicast groups are compatible with IGMP through version 3. The device supports simultaneous SIP and Multicast.

1. Click on the **Multicast** menu button to open the **Multicast** page. See [Figure 2-32](#).

Figure 2-32. Multicast Configuration Page

Multicast Settings

Enable Multicast Operation:

Priority	Address	Port	Name	Buffer	Beep	Relay
9	239.168.3.10	11000	Emergency	<input type="checkbox"/>	<input type="checkbox"/>	<input type="checkbox"/>
8	239.168.3.9	10000	MG8	<input type="checkbox"/>	<input type="checkbox"/>	<input type="checkbox"/>
7	239.168.3.8	9000	MG7	<input type="checkbox"/>	<input type="checkbox"/>	<input type="checkbox"/>
6	239.168.3.7	8000	MG6	<input type="checkbox"/>	<input type="checkbox"/>	<input type="checkbox"/>
5	239.168.3.6	7000	MG5	<input type="checkbox"/>	<input type="checkbox"/>	<input type="checkbox"/>
4	239.168.3.5	6000	MG4	<input type="checkbox"/>	<input type="checkbox"/>	<input type="checkbox"/>
3	239.168.3.4	5000	MG3	<input type="checkbox"/>	<input type="checkbox"/>	<input type="checkbox"/>
2	239.168.3.3	4000	MG2	<input type="checkbox"/>	<input type="checkbox"/>	<input type="checkbox"/>
1	239.168.3.2	3000	MG1	<input type="checkbox"/>	<input type="checkbox"/>	<input type="checkbox"/>
0	239.168.3.1	2000	Background Music	<input type="checkbox"/>	<input type="checkbox"/>	<input type="checkbox"/>

Polycom Default Channel: 1
 Polycom Priority Channel: 24
 Polycom Emergency Channel: 25

Multicast Strobe Settings

Blink Strobe on Multicast:

Brightness: 100

- ADA Compliant
- Slow Fade
- Fast Fade
- Slow Blink
- Fast Blink

Color: Violet

Red: 255
 Green: 0
 Blue: 255

SIP calls are considered priority 4.5
Port range can be from 2000-65535
Priority 9 is the highest and 0 is the lowest
A higher priority audio stream will always supersede a lower one

* You need to reboot for changes to take effect













2. On the **Multicast** page, enter values for the parameters indicated in [Table 2-19](#).

Note The question mark icon (?) in the following table shows which web page items will be defined after the **Toggle Help** button is pressed.

Table 2-19. Multicast Configuration Parameters

Web Page Item	Description
Enable Multicast Operation	Enables or disables multicast operation.
Priority	Indicates the priority for the multicast group. Priority 9 is the highest (emergency streams). 0 is the lowest (background music). SIP calls are considered priority 4.5 . See Section 2.3.8.1, "Assigning Priority" for more details.
Address	Enter the multicast IP Address for this multicast group (15 character limit).
Port	Enter the port number for this multicast group (5 character limit [range can be from 2000 to 65535]). Note: The multicast ports have to be even values. The webpage will enforce this restriction.
Name	Assign a descriptive name for this multicast group (25 character limit).
Buffer	Device will buffer up to four minutes of audio and then play back the recording after the multicast stream finishes or after the buffer is full.
Beep	When selected, the device will play a beep before multicast audio is sent.
Relay	When selected, the device will activate a relay before multicast audio is sent.
Polycom Default Channel	When a default Polycom channel/group number is selected, the device will subscribe to the default channel for one-way group pages. Group Numbers 1-25 are supported. Or, select Disabled to disable this channel.
Polycom Priority Channel	When a priority Polycom channel/group number is selected, the device will subscribe to the priority channel for one-way group pages. Group Numbers 1-25 are supported. Or, select Disabled to disable this channel.
Polycom Emergency Channel	When an emergency Polycom channel/group number is selected, the device will subscribe to the default channel for one-way group pages. Group Numbers 1-25 are supported. Or, select Disabled to disable this channel.
Multicast Strobe Settings	
Blink Strobe on Multicast ?	When selected, the Strobe will blink a scene when a multicast is received.
Multicast Strobe Brightness ?	How bright the strobe will blink on a multicast page. This is the maximum brightness for "fade" type scenes.
ADA Compliant ?	Strobe will blink ON at the specified brightness for 150ms then OFF for 350ms during the duration of the event.
Slow Fade ?	Strobe will increase in brightness from 0 to the specified brightness and back to 0 over the course of about 3.5 seconds during the duration of the event.

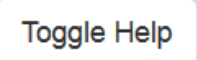
Table 2-19. Multicast Configuration Parameters (continued)

Web Page Item	Description
Fast Fade 	Strobe will increase in brightness from 0 to the specified brightness and back to 0 over the course of about 1.5 seconds during the duration of the event.
Slow Blink 	Strobe will blink ON at the specified brightness for one second then OFF for one second during the duration of the event.
Fast Blink 	Strobe will blink ON at the specified brightness then OFF five times per second during the duration of the event.
Multicast Call Color 	Select desired color (only one may be chosen).
Red 	The red LED value for Multicast.
Green 	The green LED value for Multicast.
Blue 	The blue LED value for Multicast.
	Use this button to preview the strobe flashing behavior for the Multicast Strobe Settings .
	Click the Save button to save your configuration settings. Note: You need to reboot for changes to take effect.
	Click on the Reboot button to reboot the system.
	Click on the Toggle Help button to see a short description of some of the web page items. First click on the Toggle Help button, and you will see a question mark () appear next to some of the web page items. Move the mouse pointer to hover over a question mark to see a short description of a specific web page item.

Note You must click on the **Save** button and then the **Reboot** button for the changes to take effect.

2.3.8.1 Assigning Priority

The device will prioritize simultaneous audio streams according to their priority in the list.

If both SIP and Multicast is enabled, SIP audio streams are considered priority **4.5**. SIP audio will interrupt multicast streams with priority **0** through **4** and will be interrupted by multicast streams with priority **5** through **9**.

During priority **9** multicast streams, the volume is set to maximum.

Note SIP calls, multicast streams, ring tones, ringback tones, and nightring tones are all prioritized.

Ringtones and Nightringtones Ringtones all play at the same priority level. This means that it is possible to have a nightring tone and a normal ringtone playing at the same time.

2.3.9 Configure the Sensor Configuration Parameters

The door sensor (pins 1 and 2) on the terminal block can be used to monitor a door's open or closed state. There is an option on the [Sensor Configuration Page](#) to trigger on an open or short condition on these pins. The door sensor alarm will be activated when the [Sensor Timeout \(in seconds\)](#) parameter has been met.

Each sensor can trigger up to five different actions:

- Flash the LED until the sensor is deactivated (roughly 10 times/second)
- Activate the relay until the sensor is deactivated
- Loop an audio file out of the speaker until the sensor is deactivated
- Call an extension and establish two way audio
- Call an extension and play a pre-recorded audio file

Note Calling a preset extension can be set up as a point-to-point call, but currently can't send delayed DTMF tones.

1. Click **Sensor** menu button to open the [Sensor Configuration Page](#) (Figure 2-33).

Figure 2-33. Sensor Configuration Page

Home Device Network SIP Multicast **Sensor** Audiofiles Events Autoprovisioning Firmware

Singlewire V3.1 Paging Amplifier

Sensor Settings

Sensor Normally Closed: Yes No
Sensor Timeout (in seconds):
Activate Relay:
Play Audio Locally:
Make call to extension:
Dial Out Extension:
Dial Out ID:
Play recorded audio:
Repeat Sensor Message:

Sensor Strobe Settings

Blink Strobe on Sensor:
Sensor Strobe Brightness:
 ADA Compliant
 Slow Fade
 Fast Fade
 Slow Blink
 Fast Blink
Sensor Color:
Red:
Green:
Blue:

2. On the **Sensor** page, enter values for the parameters indicated in [Table 2-20](#).

Note The question mark icon (?) in the following table shows which web page items will be defined after the **Toggle Help** button is pressed.

Table 2-20. Sensor Configuration Parameters













Web Page Item	Description
Sensor Settings	
Sensor Normally Closed ?	Select the inactive state of the sensor. The sensor is also known as the Sense Input on the device's terminal block.
Sensor Timeout (in seconds) ?	The time (in seconds) the device will wait before it performs an action when the on-board door sensor is activated. The action(s) performed are based on the configured Sensor Settings below. Enter up to 5 digits.
Activate Relay ?	When selected, the device's on-board relay will be activated until the on-board sensor is deactivated.
Play Audio Locally ?	When selected, the device will loop an audio file out of the speaker until the sensor is deactivated.
Make call to extension ?	When selected, the device will call an extension when the on-board door sensor is activated. Use the Dial Out Extension field below to specify the extension the device will call.
Dial Out Extension ?	Specify the extension the device will call when the on-board sensor is activated. Enter up to 64 alphanumeric characters.
Dial Out ID ?	An additional Caller identification string added to outbound calls. Enter up to 64 alphanumeric characters.
Play recorded audio ?	When selected, the device will call the Dial Out Extension and play an audio file to the phone answering the SIP call (corresponds to Sensor Triggered on the Audiofiles Page page).
Repeat Sensor Message ?	The number of times to repeat the audio message through the local speaker or to the remote endpoint. A value of 0 will repeat the message while the sensor is active. Enter a value from 0-65536.
	Click the Test Sensor button to test the sensor.
Sensor Strobe Settings	
Blink Strobe on Sensor ?	When selected, the Strobe will blink a scene when the sensor is triggered.
Sensor Strobe Brightness ?	How bright the strobe will blink when the sensor is triggered. This is the maximum brightness for "fade" type scenes.
ADA Compliant ?	Strobe will blink ON at the specified brightness for 150ms then OFF for 350ms during the duration of the event.
Slow Fade ?	Strobe will increase in brightness from 0 to the specified brightness and back to 0 over the course of about 3.5 seconds during the duration of the event.

Table 2-20. Sensor Configuration Parameters (continued)

Web Page Item	Description
Fast Fade 	Strobe will increase in brightness from 0 to the specified brightness and back to 0 over the course of about 1.5 seconds during the duration of the event.
Slow Blink 	Strobe will blink ON at the specified brightness for one second then OFF for one second during the duration of the event.
Fast Blink 	Strobe will blink ON at the specified brightness then OFF five times per second during the duration of the event.
Sensor Color 	Select desired color (only one may be chosen).
Red 	The red LED value for Sensor.
Green 	The green LED value for Sensor.
Blue 	The blue LED value for Sensor.
	Use this button to preview the strobe flashing behavior for the Sensor Strobe Settings .
	Click the Save button to save your configuration settings. Note: You need to reboot for changes to take effect.
	Click on the Reboot button to reboot the system.
	Click on the Toggle Help button to see a short description of some of the web page items. First click on the Toggle Help button, and you will see a question mark () appear next to some of the web page items. Move the mouse pointer to hover over a question mark to see a short description of a specific web page item.

Note You must click on the **Save** button for the changes to take effect.

2.3.10 Configure the Audio Configuration Parameters

The **Audiofiles** page is used to add custom audio to the board. User uploaded audio will take precedence over the audio files shipped with the device.

1. Click on the **Audiofiles** menu button to open the **Audiofiles** page (Figure 2-34).

Figure 2-34. Audiofiles Page

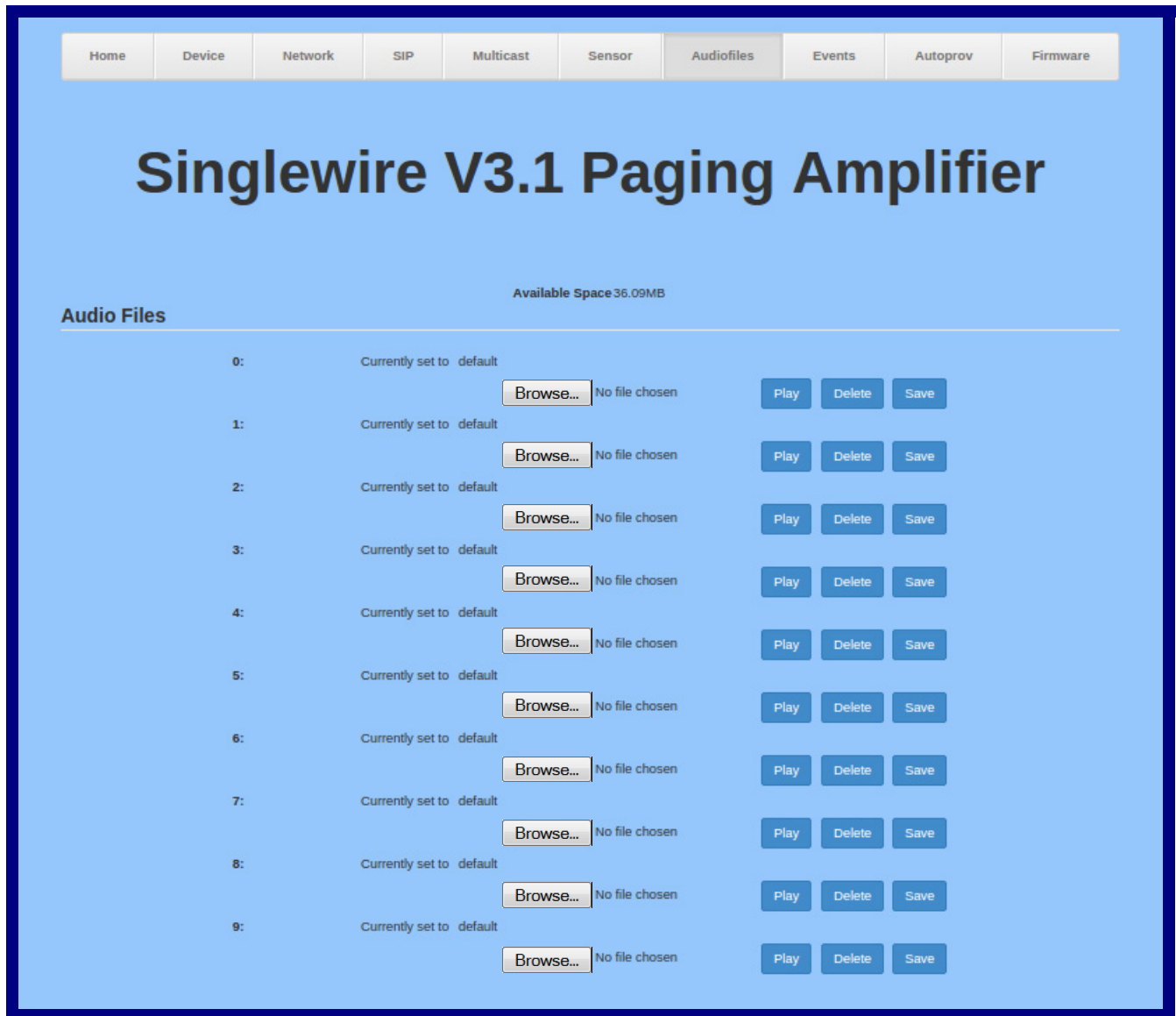

Figure 2-35. Audiofiles Page







2. On the **Audiofiles** page, enter values for the parameters indicated in [Table 2-21](#).

Note The question mark icon (?) in the following table shows which web page items will be defined after the **Toggle Help** button is pressed.

Table 2-21. Audiofiles Configuration Parameters

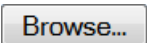
Web Page Item	Description
Available Space	Shows the space available for the user to save custom audio files if they want to change the message when the door or sensor is triggered.
0-4	<p>The name of the audio configuration option is the same as the spoken audio that plays on the board (24 character limit).</p> <p>'0' corresponds to the spoken word "zero." '1' corresponds to the spoken word "one." '2' corresponds to the spoken word "two." '3' corresponds to the spoken word "three." '4' corresponds to the spoken word "four."</p>

Table 2-21. Audiofiles Configuration Parameters (continued)

Web Page Item	Description
5-9	The name of the audio configuration option is the same as the spoken audio that plays on the board (24 character limit). '5' corresponds to the spoken word "five." '6' corresponds to the spoken word "six." '7' corresponds to the spoken word "seven." '8' corresponds to the spoken word "eight." '9' corresponds to the spoken word "nine."
Dot	Corresponds to the spoken word "dot." (24 character limit)
Audio Test	Corresponds to the message " <i>This is the CyberData IP speaker test message...</i> " (24 character limit)
Enter Code	Corresponds to the message "Enter Code" (24 character limit).
Invalid Code	Corresponds to the message "Invalid Code" (24 character limit).
Page Tone	Corresponds to a simple tone used for beep on initialization and beep on page (24 character limit).
Your IP Address is	Corresponds to the message "Your IP address is..." (24 character limit).
Rebooting	Corresponds to the spoken word "Rebooting" (24 character limit).
Restoring Default	Corresponds to the message "Restoring default" (24 character limit).
Ring Tone	This is the tone that plays when set to ring when receiving a call (24 character limit).
Sensor Triggered	Corresponds to the message "Sensor Triggered" (24 character limit).
Night Ring	Specifies the ringtone for nightring. By default this parameter uses the same audio file that is selected for the Ring Tone parameter.
	Click on the Browse button to navigate to and select an audio file.
	The Play button will play that audio file.
	The Delete button will delete any user uploaded audio and restore the stock audio file.
	The Save button will download a new user audio file to the board once you've selected the file by using the Browse button. The Save button will delete any pre-existing user-uploaded audio files.

2.3.10.1 User-created Audio Files

User created audio files should be saved in the following format:

RIFF (little-endian) data, WAVE audio, Microsoft PCM, 16 bit, mono 8000 Hz

You can use the free utility *Audacity* to convert audio files into this format. See [Figure 2-36](#) through [Figure 2-38](#).

Figure 2-36. Audacity 1

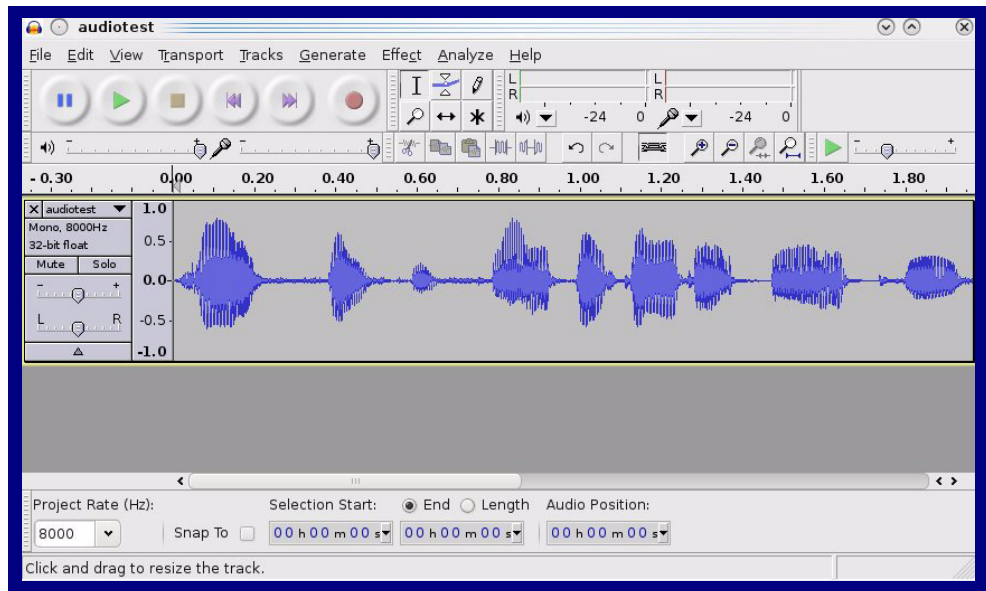
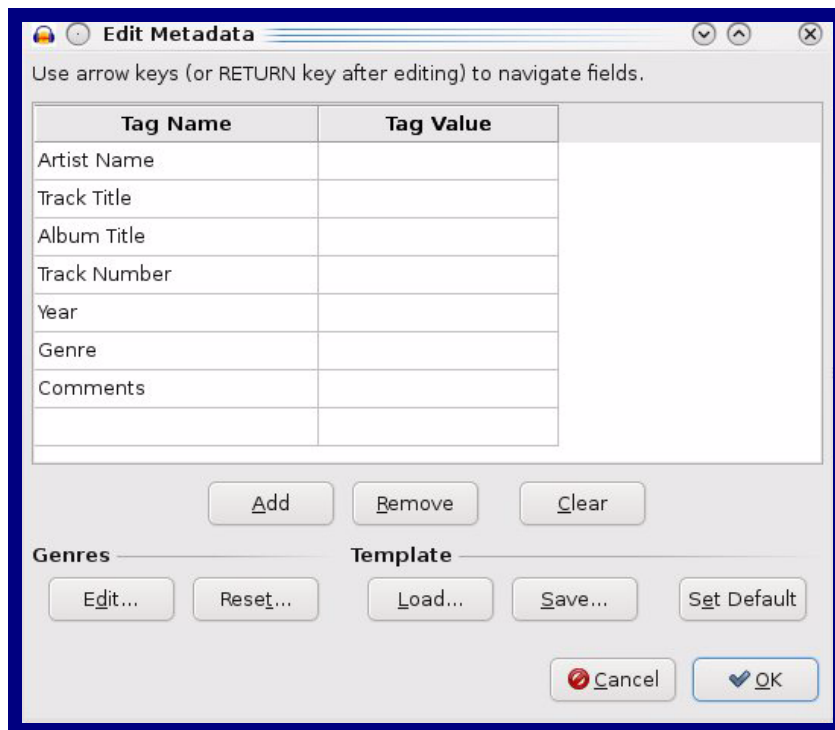

Figure 2-37. Audacity 2



When you export an audio file with Audacity, save the output as:

- **WAV (Microsoft) signed 16 bit PCM.**

Figure 2-38. WAV (Microsoft) signed 16 bit PCM

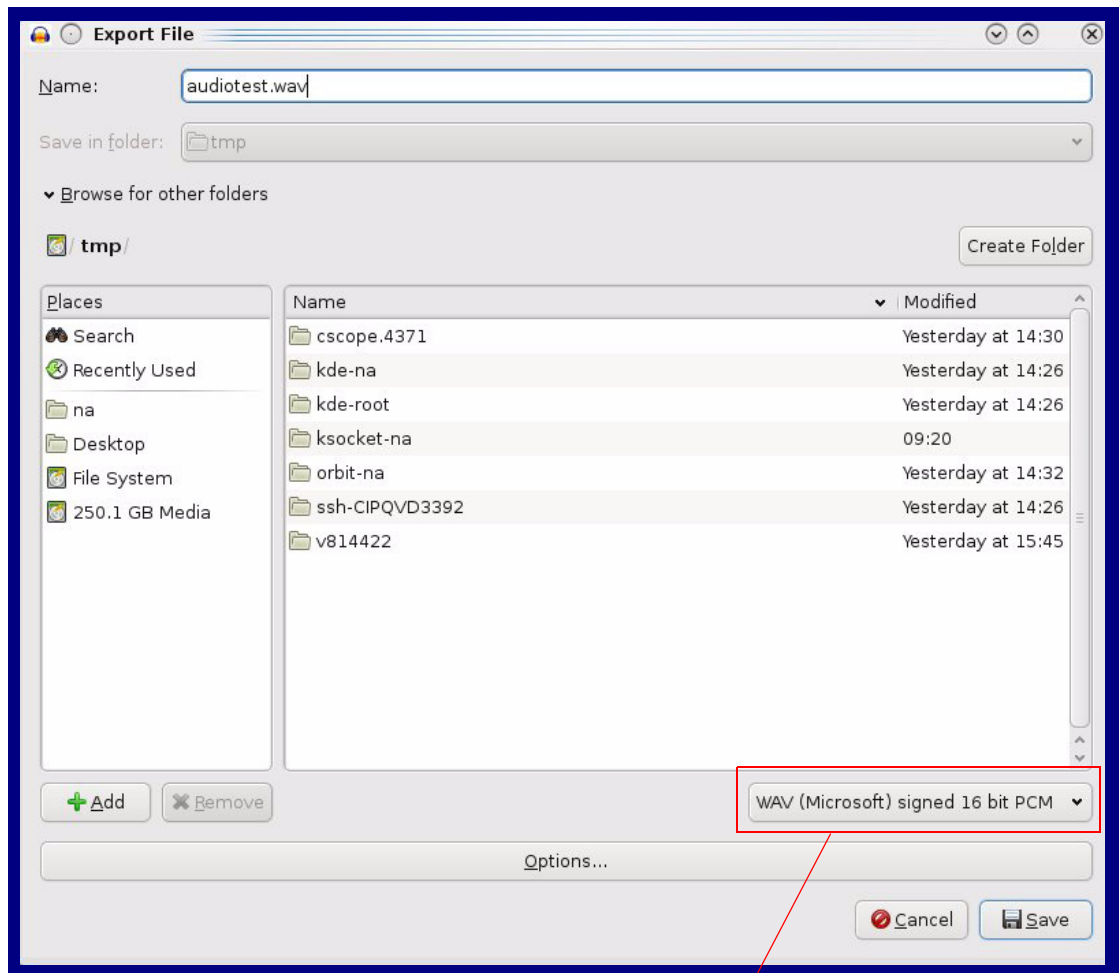

WAV (Microsoft) signed 16 bit PCM

2.3.11 Configure the Events Parameters

The **Events** page specifies a remote server that can be used to receive HTTP POST events when actions take place on the board.

1. Click on the **Events** menu button to open the **Events** page (Figure 2-39).

Figure 2-39. Event Configuration Page

Home Device Network SIP Multicast Sensor Audiofiles **Events** Autoprovisioning Firmware

Singlewire V3.1 Paging Amplifier

Enable Event Generation:

Events

- Enable Call Start Events:
- Enable Call Terminated Events:
- Enable Relay Activated Events:
- Enable Relay Deactivated Events:
- Enable Night Ring Events:
- Enable Power On Events:
- Enable Multicast Start Events:
- Enable Multicast Stop Events:
- Enable Sensor Events:
- Enable 60 Second Heartbeat:

[Check All](#) [Uncheck All](#)

Event Server

Server IP Address:

Server Port:

Server URL:

2. On the **Events** page, enter values for the parameters indicated in [Table 2-22](#).

Note The question mark icon (?) in the following table shows which web page items will be defined after the **Toggle Help** button is pressed.

Table 2-22. Events Configuration Parameters



Web Page Item	Description
Enable Event Generation ?	The device will send HTTP POST events to the specified remote server and port number whenever a certain action takes place. Select an event type below to generate an HTTP POST event.
Events	
Enable Call Start Events ?	When selected, the device will report the start of a SIP call.
Enable Call Terminated Events ?	When selected, the device will report the end of a SIP call.
Enable Relay Activated Events ?	When selected, the device will report relay activation.
Enable Relay Deactivated Events ?	When selected, the device will report relay deactivation.
Enable Night Ring Events ?	When selected, the device will report when it starts ringing upon an incoming SIP call to the Nightringer extension. As a reminder, the Nightringer extension always rings upon an incoming SIP call and it is not possible to alter this behavior.
Enable Power On Events ?	When selected, the device will report when it boots.
Enable Multicast Start Events ?	When selected, the device will report when the device starts playing a multicast audio stream.
Enable Multicast Stop Events ?	When selected, the device will report when the device stops playing a multicast audio stream.
Enable Sensor Events ?	When selected, the device will report when the on-board sensor is activated.
Enable 60 Second Heartbeat Events ?	When enabled, the device will report a Heartbeat event every 60 seconds. SIP registration is not required to generate Heartbeat events.
Check All	Click on Check All to select all of the events on the page.
Uncheck All	Click on Uncheck All to de-select all of the events on the page.
Event Server	
Server IP Address ?	The IPv4 address of the event server in dotted decimal notation.
Server Port ?	Specify the event server port number. The supported range is 0-65536. Enter up to 5 digits.
Server URL ?	Generally, the destination URL is the name of the application that receives the events and the string in the HTTP POST command. It can be a script used to parse and process the HTTP POST events. Enter up to 127 characters.
	Click the Save button to save your configuration settings. Note: You need to reboot for changes to take effect.
	Click on the Reboot button to reboot the system.

Table 2-22. Events Configuration Parameters(continued)

Web Page Item	Description
	Click on the Toggle Help button to see a short description of some of the web page items. First click on the Toggle Help button, and you will see a question mark (?) appear next to some of the web page items. Move the mouse pointer to hover over a question mark to see a short description of a specific web page item.

Note You must click on the **Save** button and then the **Reboot** button for the changes to take effect.

2.3.11.1 Example Packets for Events

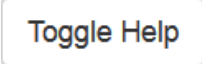
The server and port are used to point to the listening server and the 'Remote Event Server URL' is the destination URL (typically the script running on the remote server that's used to parse and process the POST events).

Note The XML is URL-encoded before transmission so the following examples are not completely accurate.

Here are example packets for every event:

```
POST xmlparse_engine HTTP/1.1
Host: 10.0.3.79
User-Agent: CyberData/1.0.0
Content-Length: 197
Content-Type: application/x-www-form-urlencoded

<?xml version="1.0" encoding="ISO-8859-1"?>
<cyberdata NAME='CyberData Device' MAC='0020f70015b6'>
<event>POWERON</event>
</cyberdata>
```

```
POST xmlparse_engine HTTP/1.1
Host: 10.0.3.79
User-Agent: CyberData/1.0.0
Content-Length: 199
Content-Type: application/x-www-form-urlencoded

<?xml version="1.0" encoding="ISO-8859-1"?>
<cyberdata NAME='CyberData Device' MAC='0020f70015b6'>
<event>HEARTBEAT</event>
</cyberdata>
```

```
POST xmlparse_engine HTTP/1.1
Host: 10.0.3.79
User-Agent: CyberData/1.0.0
Content-Length: 196
Content-Type: application/x-www-form-urlencoded

<?xml version="1.0" encoding="ISO-8859-1"?>
<cyberdata NAME='CyberData Device' MAC='0020f70015b6'>
<event>BUTTON</event>
</cyberdata>
```

```
POST xmlparse_engine HTTP/1.1
Host: 10.0.3.79
User-Agent: CyberData/1.0.0
Content-Length: 201
Content-Type: application/x-www-form-urlencoded

<?xml version="1.0" encoding="ISO-8859-1"?>
<cyberdata NAME='CyberData Device' MAC='0020f70015b6'>
<event>CALL_ACTIVE</event>
</cyberdata>
POST xmlparse_engine HTTP/1.1
Host: 10.0.3.79
```

```
User-Agent: CyberData/1.0.0
Content-Length: 205
Content-Type: application/x-www-form-urlencoded

<?xml version="1.0" encoding="ISO-8859-1"?>
<cyberdata NAME='CyberData Device' MAC='0020f70015b6'>
<event>CALL_TERMINATED</event>
</cyberdata>

POST xmlparse_engine HTTP/1.1
Host: 10.0.3.79
User-Agent: CyberData/1.0.0
Content-Length: 197
Content-Type: application/x-www-form-urlencoded

<?xml version="1.0" encoding="ISO-8859-1"?>
<cyberdata NAME='CyberData Device' MAC='0020f70015b6'>
<event>RINGING</event>
</cyberdata>

POST xmlparse_engine HTTP/1.1
Host: 10.0.3.79
User-Agent: CyberData/1.0.0
Content-Length: 234
Content-Type: application/x-www-form-urlencoded

<?xml version="1.0" encoding="ISO-8859-1"?>
<cyberdata NAME='CyberData Device' MAC='0020f70015b6'>
<event>MULTICAST_START</event>
<index>8</index>
</cyberdata>

POST xmlparse_engine HTTP/1.1
Host: 10.0.3.79
User-Agent: CyberData/1.0.0
Content-Length: 233
Content-Type: application/x-www-form-urlencoded

<?xml version="1.0" encoding="ISO-8859-1"?>
<cyberdata NAME='CyberData Device' MAC='0020f70015b6'>
<event>MULTICAST_STOP</event>
<index>8</index>
</cyberdata>

POST xmlparse_engine HTTP/1.1
Host: 10.0.3.79
User-Agent: CyberData/1.0.0
Content-Length: 234
Content-Type: application/x-www-form-urlencoded
<?xml version="1.0" encoding="ISO-8859-1"?>
<cyberdata NAME='CyberData Device' MAC='0020f70015b6'>
<event>RELAY_ACTIVATED</event>
</cyberdata>
POST xmlparse_engine HTTP/1.1
Host: 10.0.3.79
```

```
User-Agent: CyberData/1.0.0
Content-Length: 234
Content-Type: application/x-www-form-urlencoded
<?xml version="1.0" encoding="ISO-8859-1"?>
<cyberdata NAME='CyberData Device' MAC='0020f70015b6'>
<event>RELAY_DEACTIVATED</event>
</cyberdata>
```

```
POST xmlparse_engine HTTP/1.1
Host: 10.0.3.79
User-Agent: CyberData/1.0.0
Content-Length: 234
Content-Type: application/x-www-form-urlencoded
<?xml version="1.0" encoding="ISO-8859-1"?>
<cyberdata NAME='CyberData Device' MAC='0020f70015b6'>
<event>NIGHTRINGING</event>
</cyberdata>
```

2.3.12 Configure the Autoprovisioning Parameters

Autoprovisioning can be used to automatically configure your device. The autoprovisioning file is an xml file with the device configuration. Values found in this file will override values stored in on-board memory.

Note By default, the device will try to set up its configuration with autoprovisioning.

1. Click the **Autoprov** menu button to open the **Autoprovisioning** page. See [Figure 2-40](#).

Figure 2-40. Autoprovisioning Page

The screenshot shows the 'Autoprov' configuration page for a Singlewire V3.1 Paging Amplifier. At the top, there is a navigation menu with buttons for Home, Device, Network, SIP, Multicast, Sensor, Audiofiles, Events, Autoprov (selected), and Firmware. The main heading is 'Singlewire V3.1 Paging Amplifier'. Below this, there are several configuration fields: 'Disable Autoprovisioning:' with a checked checkbox; 'Autoprovisioning Server:' with a text input field; 'Autoprovisioning Filename:' with a text input field; 'Use tftp:' with a checked checkbox; 'Username:' with a text input field; 'Password:' with a text input field; 'Autoprovisioning autoupdate (in minutes):' with a numeric input field set to 0; 'Autoprovision at time (HHMMSS):' with a text input field; and 'Autoprovision when idle (in minutes > 10):' with a numeric input field set to 0. Below the fields, there is explanatory text: 'See the manual to learn how to use autoprovisioning to configure your device.', 'Autoprovisioning happens on boot.', 'The device will first look for a configured server address and filename.', and 'If these haven't been configured, it will look for an autoprovisioning server in your list of DHCP options and try to download '0020f7036d9a.xml' and if this fails, '000000cd.xml'.' At the bottom of the configuration section, there are three buttons: 'Save', 'Reboot', and 'Toggle Help'. Below this is a 'Download Template' button. At the very bottom, there is an 'Autoprovisioning log' section with a scrollable text area containing the following log entries: '00:00 Autoprovisioning Device...', '00:00 Autoprov found option 43 in DHCP server="http://chalmers.cyberdata.net"', '00:00 Autoprov looking for 0020f7036d9a.xml at http://chalmers.cyberdata.net', '00:00 Autoprov looking for 000000cd.xml at http://chalmers.cyberdata.net', '00:00 Failed to fetch autoprov file', '00:00 Autoprov found option 72 in DHCP server="10.0.1.118"', '00:00 Autoprov looking for 0020f7036d9a.xml at 10.0.1.118', '00:00 Autoprov looking for 000000cd.xml at 10.0.1.118', '00:00 Failed to fetch autoprov file', and '00:00 Autoprov found option 150 in DHCP server="10.0.5.120"'. The log area has a scrollbar on the right side.

- On the **Autoprovisioning** page, you may enter values for the parameters indicated in [Table 2-23](#).

Note The question mark icon (?) in the following table shows which web page items will be defined after the **Toggle Help** button is pressed.

Table 2-23. Autoprovisioning Configuration Parameters





Web Page Item	Description
Disable Autoprovisioning ?	Prevent the device from automatically trying to download a configuration file. See Section 2.3.12.1, "Autoprovisioning" for more information.
Autoprovisioning Server ?	Enter the IPv4 address of the provisioning server in dotted decimal notation.
Autoprovisioning Filename ?	<p>The autoprovisioning filename is the configuration filename. The default autoprovisioning filename is in the format of <mac address>.xml.</p> <p>Supported filename extensions are .txt, and .xml. The current filename is denoted by an asterisk at the bottom of the Autoprovisioning Page. Enter up to 256 characters.</p> <p>A file may have any name with an xml extension. If a file name is entered, the device will look for the specified file name, and only that file.</p>
Use tftp ?	The device will use TFTP (instead of http) to download autoprovisioning files.
Username ?	The username used to authenticate with an autoprovisioning server. Leave this field blank to disable authentication.
Password ?	The password used to authenticate with an autoprovisioning server. Leave this field blank to disable authentication.
Autoprovisioning Autoupdate (in minutes) ?	<p>The reoccurring time (in minutes) the device will wait before checking for new autoprovisioning files. Enter up to 6 digits. A value of 0 will disable this option.</p> <p>Note: To use the auto update options, enable the Set Time with NTP Server on boot setting on the Device Configuration Page page (see Table 2-10).</p>
Autoprovision at time (HHMMSS) ?	<p>The time of day the device will check for a new autoprovisioning file. The time must be 6 characters in length and in HHMMSS format. An empty value will disable this option.</p> <p>Note: To use the auto update options, enable the Set Time with NTP Server on boot setting on the Device Configuration Page page (see Table 2-10).</p>
Autoprovision when idle (in minutes > 10) ?	<p>The idle time (in minutes greater than 10) after which the device will check for a new autoprovisioning file. Enter up to 6 digits. A value of 0 will disable this option.</p> <p>Note: To use the auto update options, enable the Set Time with NTP Server on boot setting on the Device Configuration Page page (see Table 2-10).</p>
	<p>Click the Save button to save your configuration settings.</p> <p>Note: You need to reboot for changes to take effect.</p>

Table 2-23. Autoprovisioning Configuration Parameters (continued)

Web Page Item	Description
	Click on the Reboot button to reboot the system.
	Click on the Toggle Help button to see a short description of some of the web page items. First click on the Toggle Help button, and you will see a question mark (?) appear next to some of the web page items. Move the mouse pointer to hover over a question mark to see a short description of a specific web page item.
	Press the Download Template button to create an autoprovisioning file for the device. See Section 2.3.12.3, "Download Template Button"
Autoprovisioning log	The autoprovisioning log provides information about the latest autoprovisioning attempt (i.e. dhcp options and server accessed and files parsed or not found).

Note You must click on the **Save** button and then the **Reboot** button for the changes to take effect.

2.3.12.1 Autoprovisioning

On boot, the device will look for an autoprovisioning server configured on the [Autoprovisioning Page](#) or specified as a DHCP option. When it finds a server, it will try to download the following (in order of preference):

1. The file configured on the autoprovisioning page.
2. A file named according to it's mac address (for example: 0020f7350058.xml).
3. The file 000000cd.xml

The file can be hosted using a standard web server (like apache, IIS, or nginx), and the device can download over SSL. The file server can be an ipv4 address in dotted decimal notation or a fully qualified domain name.

By default, the device will get its autoprovisioning server from the DHCP options. See [Section 2.3.12.2, "Sample dhcpd.conf"](#) for an example of how to configure dhcpd to offer autoprovisioning server addresses. If multiple options are set, the device will attempt to download autoprovisioning files from every server.

The DHCP option determines the protocol used to download the autoprovisioning file. The device looks for DHCP options in the following order:

1. Option 43 - a FQDN or an IP address to an http server
2. Option 72 - an IP address to an http server
3. Option 150 - an IP address to a tftp server
4. Option 66 - an IP address to a tftp server or if the entry starts with 'http', a FQDN to a http server.

You can download an autoprovisioning template file from the [Autoprovisioning Page](#) using the **Download Template** button (see [Table 2-23](#)). This file contains every configuration option that can be set on the board.

Autoprovisioning files can contain the whole configuration or a subset of this file. The first autoprovisioning file can also contain links to other autoprovisioning files.

The <MiscSettings> section contains some examples of additional autoprovisioning files:

```
<MiscSettings>
  <DeviceName>CyberData Device</DeviceName>
<!-- <AutoprovFile>common.xml</AutoprovFile>-->
<!-- <AutoprovFile>sip_reg [macaddress] .xml</AutoprovFile>-->
<!-- <AutoprovFile>audio [macaddress] </AutoprovFile>-->
<!-- <AutoprovFile>device [macaddress] .xml</AutoprovFile>-->
</MiscSettings>
```

After downloading the first autoprovisioning file, the device will step through up to twenty additional <AutoprovFile> entries and try to download these files from the same server.

When the device finds a filename with the string **[macaddress]**, it will replace this string with the mac address.

As an example, the user has configured option 43 on their DHCP server to “http://example.com,” and on their server, they have a file named **0020f7123456.xml** (the same as the mac address of the device).

The file 0020f7123456.xml contains:

```
<?xml version="1.0" encoding="utf-8" ?>
<specific>
  <MiscSettings>
    <DeviceName>Newname</DeviceName>
    <AutoprovFile>common.xml</AutoprovFile>
    <AutoprovFile>sip_reg[macaddress].xml</AutoprovFile>
    <AutoprovFile>audio[macaddress]</AutoprovFile>
    <AutoprovFile>device.xml</AutoprovFile>
  </MiscSettings>
</specific>
```

1. The device will first set its name to 'Newname'.
2. It will try to download <http://example.com/common.xml>.
3. It will try to download http://example.com/sip_reg0020f7123456.xml.
4. It will try to download <http://example.com/audio0020f7123456>.
5. It will try to download <http://example.com/device.xml>.

The device is reconfigured every time it downloads a new file so if two files configure the same option the last one will be the one that is saved.

It is possible to autoprovision autoprovisioning values (for example, to disable autoprovisioning or to configure a time to check for new files).

Checking for New
Autoprovisioning
Files after Boot

The device will always check for an autoprovisioning files on boot but it can be configured to also check after a periodic delay, when idle, or at a specified time. When one of these options is set, the device will download its autoprovisioning files again, and if it finds any differences from the files it downloaded on boot, it will force a reboot and reconfigure.

The
Autoprovisioning
Filename

The autoprovisioning filename can contain a file, a file path, or a directory.

Table 2-24. Autoprovisioning File Name

Autoprovisioning Filename	Autoprovisioning Server	File Downloaded
config.xml	10.0.1.3	10.0.1.3/config.xml
/path/to/config.xml	10.0.1.3	10.0.1.3/path/to/config.xml
subdirectory/path/	10.0.1.3	10.0.1.3/subdirectory/path/0020f7020002.xml

TFTP options may not support subdirectories. If a directory is set in the filename field, firmware and audio files will also be downloaded from this subdirectory.

If the filename ends with a forward slash “/,” the device will treat it as a subdirectory.

For example:

The autoprovisioning server is set to “https://www.example.com”

The autoprovisioning filename is set to “cyberdata/”

On boot, the device will try to download:

https://www.example.com/cyberdata/0020f7123456.xml

...and if this fails:

https://www.example.com/cyberdata/000000cd.xml

Audio files and firmware files will also add “cyberdata” to the URL before downloading.

```

Autoprovisioning <FirmwareSettings>
Firmware Updates <FirmwareFile>505-uImage-ceiling-speaker</FirmwareFile>
                  <FirmwareServer>10.0.1.3</FirmwareServer>
                  <OutdoorIntercom30>firmware_file_v9.3.0</OutdoorIntercom30>
                  <OutdoorIntercom31>firmware_file_v10.3.0</OutdoorIntercom31>
                  <CallButton31>firmware_file_v10.3.0</CallButton31>
                  </FirmwareSettings>

```

In the <FirmwareSettings> section, the <FirmwareServer> element can be used to specify a different server for hosting firmware files. When this element is not available, the device will try to download the file from the autoprovisioning server.

The device will use the filename to determine when to autoprovision firmware updates. The default configuration is blank, so the first time you set a value in your autoprovisioning file, it may force a firmware update even if the firmware version has not changed.

The <FirmwareFile> name can contain path elements (i.e. /path/to/firmware/10.3.0-ulmage-[device_file_name]).

The device also supports product strings for downloading firmware. If the <FirmwareFile> option is not set, the device will look for its particular product string for a firmware filename. In this way, a generic autoprovisioning file can specify unique firmware for a range of products.

The list of valid product strings:

```

<ProductString>CallButton31</ProductString>
<ProductString>EmergencyIntercom31</ProductString>
<ProductString>EmergencyIntercom31SW</ProductString>
<ProductString>IndoorIntercom31</ProductString>
<ProductString>IndoorIntercom31SW</ProductString>
<ProductString>IndoorKeypad31</ProductString>
<ProductString>IndoorKeypad31SW</ProductString>
<ProductString>OfficeRinger31</ProductString>
<ProductString>OfficeRinger31SW</ProductString>
<ProductString>OutdoorIntercom31</ProductString>
<ProductString>OutdoorIntercom31SW</ProductString>
<ProductString>OutdoorKeypad31</ProductString>
<ProductString>OutdoorKeypad31SW</ProductString>
<ProductString>Strobe31</ProductString>
<ProductString>Strobe31SW</ProductString>

```

Autoprovisioning
Example 1

Here's a simple example using four autoprovisioning files to configure two devices:

We boot up two devices with mac addresses **00:20:f7:02:00:01** and **00:20:f7:02:00:02** (Device1 and Device2).

The devices are set to use DHCP and that server provides an autoprovisioning server address with option 43. The address is "https://autoprovtest.server.net." The files on this server are as follows:

000000cd.xml

```
<MiscSettings>
<DeviceName>CyberData Autoprovisioned</DeviceName>
<AutoprovFile>sip_common.xml</AutoprovFile>
<AutoprovFile>sip_[macaddress].xml</AutoprovFile>
</MiscSettings>
```

sip_common.xml

```
<SIPSettings>
<SIPServer>10.0.0.253</SIPServer>
<RemoteSIPPort>5060</RemoteSIPPort>
</SIPSettings>
```

sip_0020f7020001.xml

```
<SIPSettings>
<SIPUserID>198</SIPUserID>
<SIPAuthPassword>ext198</SIPAuthPassword>
<DialoutExtension0>204</DialoutExtension0>
</SIPSettings>
```

sip_0020f7020002.xml

```
<SIPSettings>
<SIPUserID>500</SIPUserID>
<SIPAuthPassword>ext500</SIPAuthPassword>
<DialoutExtension0>555</DialoutExtension0>
</SIPSettings>
```

On boot, Device1 tries to fetch the file **0020f7023614.xml** from "https://autoprovtest.server.net". This file is not available, so device1 then tries to fetch the file **000000cd.xml**. This file exists, and Device1 parses the three elements.

1. Device1 changes its device name to **CyberData Autoprovisioned**.
2. Device1 finds an AutoprovFile element containing the filename **sip_common.xml**. The device downloads **sip_common.xml** from "https://autoprovtest.server.net," and imports this configuration, setting the sip server to **10.0.0.253** and the remote port to **5060.3**.
3. Device1 finds another AutoprovFile element containing the filename **sip_[macaddress].xml**. The device replaces the **[macaddress]** with its own mac address value creating **sip_0020f7020001.xml**, downloads this file from "https://autoprovtest.server.net," and imports this configuration. This sets the user ID to **198**, the password to **ext198**, and the dialout extension to **204**. Device1 is now finished with autoprovisioning.

Device2 goes through the same steps by setting its device name to **CyberData Autoprovisioned**, its SIP server to **10.0.0.253**, and its port to **5060**. When Device2 “sees” **sip_[macaddress].xml**, Device2 replaces it with its own mac address and downloads **sip_0020f7020002.xml** from “https://autoprovtest.server.net.” Device2 sets the SIP User ID to **500**, the password to **ext500**, and the dialout extension to **555**.

Autoprovisioning Example 2

Here is another example of setting up your autoprovisioning files:

We boot up two devices with mac addresses **00:20:f7:02:00:01** and **00:20:f7:02:00:02** (Device1 and Device2) and boot them on a network with a DHCP server configured with an autoprovisioning server at **10.0.1.3** on option **150**. Our TFTP server has three files:

0020f7020001.xml

```
<MiscSettings>
<AutoprovFile>common_settings.xml</AutoprovFile>
</MiscSettings>
<SIPSettings>
<SIPUserID>198</SIPUserID>
<SIPAuthPassword>ext198</SIPAuthPassword>
<DialoutExtension0>204</DialoutExtension0>
</SIPSettings>
```

0020f7020002.xml

```
<MiscSettings>
<AutoprovFile>common_settings.xml</AutoprovFile>
</MiscSettings>
<SIPSettings>
<SIPUserID>500</SIPUserID>
<SIPAuthPassword>ext500</SIPAuthPassword>
<DialoutExtension0>555</DialoutExtension0>
</SIPSettings>
```

common_settings.xml

```
<MiscSettings>
<DeviceName>CyberData Autoprovisioned</DeviceName>
</MiscSettings>
<SIPSettings> <SIPServer>10.0.0.253</SIPServer>
<RemoteSIPPort>5060</RemoteSIPPort>
</SIPSettings>
```

1. On boot, Device1 downloads **0020f7020001.xml** from **10.0.1.3** and imports these values. The SIP User ID is **198**, the password is **ext198**, and the dialout extension is **204**.

2. Device1 then gets the filename **common_settings.xml** from the AutoprovFile element and downloads this file from the TFTP server at **10.0.1.3**. and imports these settings. The device name is set to **CyberData Autoprovisioned**, the SIP server is set to **10.0.0.253**, and the port is set to **5060**.

Device2 does the same except it downloads **0020f7020002.xml** on boot and imports these values instead. The Sip User ID is **500**, password is **ext500**, and dialout extension is **555**. Device2 then downloads the **common_settings.xml** file and imports those values. The device name is set to **CyberData Autoprovisioned**, the SIP server is set to **10.0.0.253**, and the port is set to **5060**.

XML Files

XML files can contain <AutoprovFile> elements. If multiple DHCP options are specified, the device will try to download autoprovisioning files from each in turn. The device will only look for <AutoprovFile> elements in the first file downloaded from each server. You can specify up to 20 <AutoprovFile> elements in the first autoprovisioning file.

There are numerous ways to change an element of the **configuration(xml)** file. Using **sip ext** as an example, the extension can be changed:

Within the device-specific xml, i.e. **[macaddress].xml**, via the AutoprovFile element:<SIPSettings>/<SIPExt>

From the device specific xml, a pointer to a sip_common file

From the device specific xml, a pointer to the device specific sip_[macaddress].xml

From the common file, a pointer to sip_common.xml

From the common file, a pointer to the device specific (sip_[macaddress].xml)

Autoprovisioned Audio Files

Audio files are stored in non-volatile memory and an autoprovisioned audio file will only have to be downloaded once for each device. Loading many audio files to the device from the web page could cause it to appear unresponsive. If this happens, wait until the transfer is complete and then refresh the page.

The device uses the file name to determine when to download a new audio file. This means that if you used autoprovisioning to upload a file and then changed the contents of this file at the TFTP server, the device will not recognize that the file has changed (because the file name is the same).

Since audio files are stored in non-volatile memory, if autoprovisioning is disabled after they have been loaded to the board, the audio file settings will not change. You can force a change to the audio files on the board by clicking **Restore Default** on the **Audio Configuration** page or by changing the autoprovisioning file with “**default**” set as the file name.

2.3.12.2 Sample dhcpd.conf

```
#
# Sample configuration file for ISC dhcpd for Debian
#

ddns-update-style none;

option domain-name "voiplab";
option domain-name-servers 10.0.0.252;
option option-150 code 150 = ip-address;
option ntp-servers north-america.pool.ntp.org;
option space VendorInfo;
option VendorInfo.text code 10 = { text };
authoritative;
log-facility local7;

subnet 10.0.0.0 netmask 255.0.0.0 {
    max-lease-time 3600;
    default-lease-time 3600;

    option routers                10.0.0.1;
    option subnet-mask            255.0.0.0;

    option domain-name            "voiplab";
    option domain-name-servers    10.0.0.252;

    option time-offset            -8;                # Pacific Standard Time

#   option www-server              99.99.99.99;        # OPTION 72

#   option tftp-server-name        "10.0.1.52";        # OPTION 66
#   option tftp-server-name        "http://test.cyberdata.net"; # OPTION 66

#   option option-150              10.0.0.252;        # OPTION 150

# These two lines are needed for option 43
#   vendor-option-space VendorInfo;                # OPTION 43
#   option VendorInfo.text "http://test.cyberdata.net"; # OPTION 43

    range 10.10.0.1 10.10.2.1; }

```

2.3.12.3 Download Template Button

The **Download Template** button allows the user to generate, download, edit, and then store an autoprovisioning template on the server that serves the autoprovisioning files for devices.

To generate an autoprovisioning template directly from the device, complete the following steps:

1. On the **Autoprovisioning** page, click on the **Download Template** button.
2. You will see a window prompting you to save a configuration file (**.xml**) to a location on your computer (Figure 2-41). The configuration file is the basis for the default configuration settings for your unit).
3. Choose a location to save the configuration file and click on **OK**. See Figure 2-41.

Figure 2-41. Configuration File

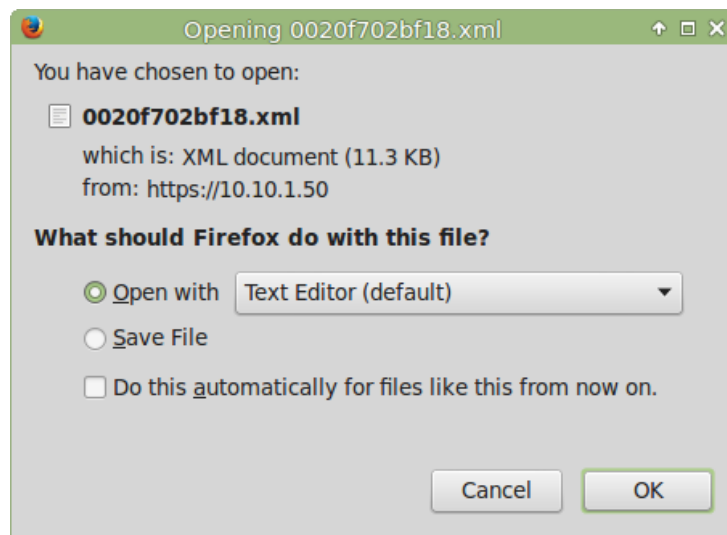

4. At this point, you can open and edit the autoprovisioning template to change the configuration settings in the template for the unit.
5. You can then upload the autoprovisioning file to a TFTP or HTTP server where the file can be loaded onto other devices.

2.4 Upgrade the Firmware and Reboot the Singlewire InformaCast Loudspeaker Amplifier (PoE)

2.4.1 Downloading the Firmware

To download the firmware to your computer:

1. Download the latest firmware file from the **Downloads** tab at the following webpage:
<http://www.cyberdata.net/voip/011407/>
2. Unzip the firmware version file. This file may contain the following:
 - Firmware file
 - Release notes
3. Log in to the home page as instructed in [Section 2.3.4, "Log in to the Configuration Home Page"](#).
4. Click on the **Firmware** menu button to open the **Firmware** page. See [Figure 2-42](#).

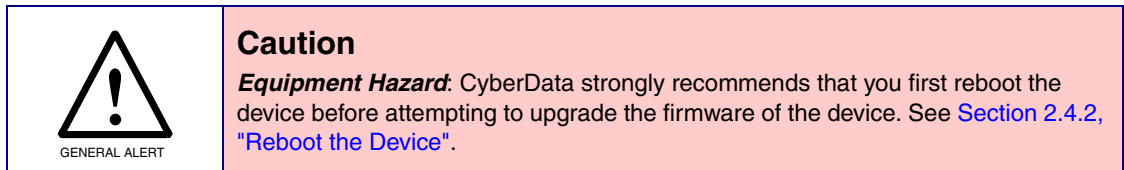

Figure 2-42. Firmware Page





5. Click on the **Browse** button, and then navigate to the location of the firmware file.
6. Select the firmware file.
7. Click on the **Upload** button.

Note Do not reboot the device after clicking on the **Upload** button.

Note This starts the upgrade process. Once the Singlewire InformaCast Loudspeaker Amplifier (PoE) has uploaded the file, the **Uploading Firmware** countdown page appears, indicating that the firmware is being written to flash. The Singlewire InformaCast Loudspeaker Amplifier (PoE) will automatically reboot when the upload is complete. When the countdown finishes, the **Firmware** page will refresh. The uploaded firmware filename should be displayed in the system configuration (indicating a successful upload and reboot).

8. [Table 2-25](#) shows the web page items on the **Firmware** page.

Table 2-25. Firmware Parameters

Web Page Item	Description
Current Firmware Version	Shows the current firmware version.
	Use the Browse button to navigate to the location of the firmware file that you want to upload.
	Click on the Upload button to automatically upload the selected firmware and reboot the system.

2.4.2 Reboot the Device

To reboot a Singlewire InformaCast Loudspeaker Amplifier (PoE), log in to the web page as instructed in [Section 2.3.4, "Log in to the Configuration Home Page"](#).

1. Click on the **Reboot** button on the **Home** page ([Figure 2-43](#)). A normal restart will occur.

Figure 2-43. Home Page

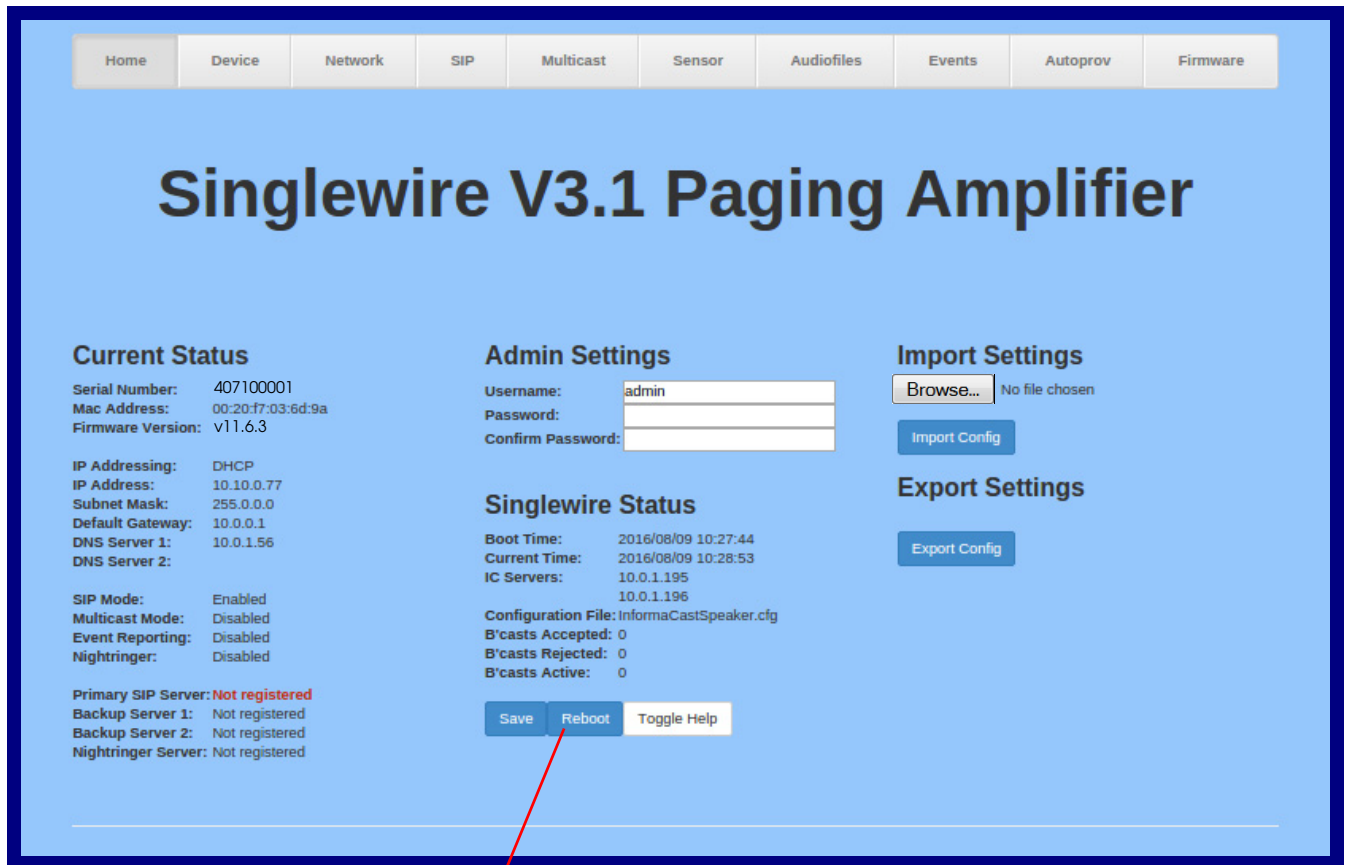

Reboot

2.5 Command Interface

Some functions on the device can be activated using simple POST commands to the web interface. The examples in [Table 2-26](#) use the free unix utility, **wget**, but any program that can send http POST commands to the device should work.

2.5.1 Command Interface Post Commands

Note These commands require an authenticated session (a valid username and password to work).

Table 2-26. Command Interface Post Commands

Device Action	HTTP Post Command ^a
Trigger relay (for configured delay)	wget --user admin --password admin --auth-no-challenge --no-check-certificate --quiet -O /dev/null "https://10.0.3.71/cgi-bin/command.cgi" --post-data "test_relay=yes"
Place call to extension (example: extension 130)	wget --user admin --password admin --auth-no-challenge --no-check-certificate --quiet -O /dev/null "https://10.0.3.71/cgi-bin/command.cgi" --post-data "call=130"
Terminate active call	wget --user admin --password admin --auth-no-challenge --no-check-certificate --quiet -O /dev/null "https://10.0.3.71/cgi-bin/command.cgi" --post-data "terminate=yes"
Force reboot	wget --user admin --password admin --auth-no-challenge --no-check-certificate --quiet -O /dev/null "https://10.0.3.71/cgi-bin/command.cgi" --post-data "reboot=yes"
Test Audio button	wget --user admin --password admin --auth-no-challenge --no-check-certificate --quiet -O /dev/null "https://10.0.3.71/cgi-bin/command.cgi" --post-data "test_audio=yes"
Announce IP address	wget --user admin --password admin --auth-no-challenge --no-check-certificate --quiet -O /dev/null "https://10.0.3.71/cgi-bin/command.cgi" --post-data "speak_ip_address=yes"
Play the "0" audio file	wget --user admin --password admin --auth-no-challenge --no-check-certificate --quiet -O /dev/null "https://10.0.3.71/cgi-bin/audiofiles.cgi" --post-data "play_0=yes"
Play the "1" audio file	wget --user admin --password admin --auth-no-challenge --no-check-certificate --quiet -O /dev/null "https://10.0.3.71/cgi-bin/audiofiles.cgi" --post-data "play_1=yes"
Play the "2" audio file	wget --user admin --password admin --auth-no-challenge --no-check-certificate --quiet -O /dev/null "https://10.0.3.71/cgi-bin/audiofiles.cgi" --post-data "play_2=yes"
Play the "3" audio file	wget --user admin --password admin --auth-no-challenge --no-check-certificate --quiet -O /dev/null "https://10.0.3.71/cgi-bin/audiofiles.cgi" --post-data "play_3=yes"
Play the "4" audio file	wget --user admin --password admin --auth-no-challenge --no-check-certificate --quiet -O /dev/null "https://10.0.3.71/cgi-bin/audiofiles.cgi" --post-data "play_4=yes"

Table 2-26. Command Interface Post Commands (continued)

Device Action	HTTP Post Command^a
Play the "5" audio file	wget --user admin --password admin --auth-no-challenge --no-check-certificate --quiet -O /dev/null "https://10.0.3.71/cgi-bin/audiofiles.cgi" --post-data "play_5=yes"
Play the "6" audio file	wget --user admin --password admin --auth-no-challenge --no-check-certificate --quiet -O /dev/null "https://10.0.3.71/cgi-bin/audiofiles.cgi" --post-data "play_6=yes"
Play the "7" audio file	wget --user admin --password admin --auth-no-challenge --no-check-certificate --quiet -O /dev/null "https://10.0.3.71/cgi-bin/audiofiles.cgi" --post-data "play_7=yes"
Play the "8" audio file	wget --user admin --password admin --auth-no-challenge --no-check-certificate --quiet -O /dev/null "https://10.0.3.71/cgi-bin/audiofiles.cgi" --post-data "play_8=yes"
Play the "9" audio file	wget --user admin --password admin --auth-no-challenge --no-check-certificate --quiet -O /dev/null "https://10.0.3.71/cgi-bin/audiofiles.cgi" --post-data "play_9=yes"
Play the "Dot" audio file	wget --user admin --password admin --auth-no-challenge --no-check-certificate --quiet -O /dev/null "https://10.0.3.71/cgi-bin/audiofiles.cgi" --post-data "play_d=yes"
Play the "Audio Test" audio file (from Audio Config)	wget --user admin --password admin --auth-no-challenge --no-check-certificate --quiet -O /dev/null "https://10.0.3.71/cgi-bin/audiofiles.cgi" --post-data "play_audiotest=yes"
Play the "Page Tone" audio file	wget --user admin --password admin --auth-no-challenge --no-check-certificate --quiet -O /dev/null "https://10.0.3.71/cgi-bin/audiofiles.cgi" --post-data "play_pagetone=yes"
Play the "Your IP Address Is" audio file	wget --user admin --password admin --auth-no-challenge --no-check-certificate --quiet -O /dev/null "https://10.0.3.71/cgi-bin/audiofiles.cgi" --post-data "play_youripaddressis=yes"
Play the "Rebooting" audio file	wget --user admin --password admin --auth-no-challenge --no-check-certificate --quiet -O /dev/null "https://10.0.3.71/cgi-bin/audiofiles.cgi" --post-data "play_rebooting=yes"
Play the "Restoring Default" audio file	wget --user admin --password admin --auth-no-challenge --no-check-certificate --quiet -O /dev/null "https://10.0.3.71/cgi-bin/audiofiles.cgi" --post-data "play_restoringdefault=yes"
Play the "Ringback tone" audio file	wget --user admin --password admin --auth-no-challenge --no-check-certificate --quiet -O /dev/null "https://10.0.3.71/cgi-bin/audiofiles.cgi" --post-data "play_ringback=yes"
Play the "Ring tone" audio file	wget --user admin --password admin --auth-no-challenge --no-check-certificate --quiet -O /dev/null "https://10.0.3.71/cgi-bin/audiofiles.cgi" --post-data "play_ringtones=yes"
Play the "Night Ring" audio file	wget --user admin --password admin --auth-no-challenge --no-check-certificate --quiet -O /dev/null "https://10.0.3.71/cgi-bin/audiofiles.cgi" --post-data "play_nightring=yes"
Delete the "0" audio file	wget --user admin --password admin --auth-no-challenge --no-check-certificate --quiet -O /dev/null "https://10.0.3.71/cgi-bin/audiofiles.cgi" --post-data "delete_0=yes"
Delete the "1" audio file	wget --user admin --password admin --auth-no-challenge --no-check-certificate --quiet -O /dev/null "https://10.0.3.71/cgi-bin/audiofiles.cgi" --post-data "delete_1=yes"

Table 2-26. Command Interface Post Commands (continued)

Device Action	HTTP Post Command^a
Delete the "2" audio file	<code>wget --user admin --password admin --auth-no-challenge --no-check-certificate --quiet -O /dev/null "https://10.0.3.71/cgi-bin/audiofiles.cgi" --post-data "delete_2=yes"</code>
Delete the "3" audio file	<code>wget --user admin --password admin --auth-no-challenge --no-check-certificate --quiet -O /dev/null "https://10.0.3.71/cgi-bin/audiofiles.cgi" --post-data "delete_3=yes"</code>
Delete the "4" audio file	<code>wget --user admin --password admin --auth-no-challenge --no-check-certificate --quiet -O /dev/null "https://10.0.3.71/cgi-bin/audiofiles.cgi" --post-data "delete_4=yes"</code>
Delete the "5" audio file	<code>wget --user admin --password admin --auth-no-challenge --no-check-certificate --quiet -O /dev/null "https://10.0.3.71/cgi-bin/audiofiles.cgi" --post-data "delete_5=yes"</code>
Delete the "6" audio file	<code>wget --user admin --password admin --auth-no-challenge --no-check-certificate --quiet -O /dev/null "https://10.0.3.71/cgi-bin/audiofiles.cgi" --post-data "delete_6=yes"</code>
Delete the "7" audio file	<code>wget --user admin --password admin --auth-no-challenge --no-check-certificate --quiet -O /dev/null "https://10.0.3.71/cgi-bin/audiofiles.cgi" --post-data "delete_7=yes"</code>
Delete the "8" audio file	<code>wget --user admin --password admin --auth-no-challenge --no-check-certificate --quiet -O /dev/null "https://10.0.3.71/cgi-bin/audiofiles.cgi" --post-data "delete_8=yes"</code>
Delete the "9" audio file	<code>wget --user admin --password admin --auth-no-challenge --no-check-certificate --quiet -O /dev/null "https://10.0.3.71/cgi-bin/audiofiles.cgi" --post-data "delete_9=yes"</code>
Delete the "Audio Test" audio file	<code>wget --user admin --password admin --auth-no-challenge --no-check-certificate --quiet -O /dev/null "https://10.0.3.71/cgi-bin/audiofiles.cgi" --post-data "delete_audiotest=yes"</code>
Delete the "Page Tone" audio file	<code>wget --user admin --password admin --auth-no-challenge --no-check-certificate --quiet -O /dev/null "https://10.0.3.71/cgi-bin/audiofiles.cgi" --post-data "delete_pagetone=yes"</code>
Delete the "Your IP Address Is" audio file	<code>wget --user admin --password admin --auth-no-challenge --no-check-certificate --quiet -O /dev/null "https://10.0.3.71/cgi-bin/audiofiles.cgi" --post-data "delete_youripaddressis=yes"</code>
Delete the "Rebooting" audio file	<code>wget --user admin --password admin --auth-no-challenge --no-check-certificate --quiet -O /dev/null "https://10.0.3.71/cgi-bin/audiofiles.cgi" --post-data "delete_rebooting=yes"</code>
Delete the "Restoring Default" audio file	<code>wget --user admin --password admin --auth-no-challenge --no-check-certificate --quiet -O /dev/null "https://10.0.3.71/cgi-bin/audiofiles.cgi" --post-data "delete_restoringdefault=yes"</code>
Delete the "Ringback tone" audio file	<code>wget --user admin --password admin --auth-no-challenge --no-check-certificate --quiet -O /dev/null "https://10.0.3.71/cgi-bin/audiofiles.cgi" --post-data "delete_ringback=yes"</code>
Delete the "Ring tone" audio file	<code>wget --user admin --password admin --auth-no-challenge --no-check-certificate --quiet -O /dev/null "https://10.0.3.71/cgi-bin/audiofiles.cgi" --post-data "delete_ringtone=yes"</code>
Delete the "Night Ring" audio file	<code>wget --user admin --password admin --auth-no-challenge --no-check-certificate --quiet -O /dev/null "https://10.0.3.71/cgi-bin/audiofiles.cgi" --post-data "delete_nightring=yes"</code>

Table 2-26. Command Interface Post Commands (continued)

Device Action	HTTP Post Command ^a
Trigger the Sensor Test (Sensor Config page)	wget --user admin --password admin --auth-no-challenge --no-check-certificate --quiet -O /dev/null "https://10.0.3.71/cgi-bin/sensor.cgi" --post-data "test=yes"

a. Type and enter all of each http POST command on one line.

Appendix A: Mounting the Amplifier

A.1 Mount the Amplifier

Before you mount the enclosure, make sure that you have received all of the parts for each enclosure. Refer to [Table A-1](#).

Table A-1. Wall Mounting Components (Part of the Accessory Kit)

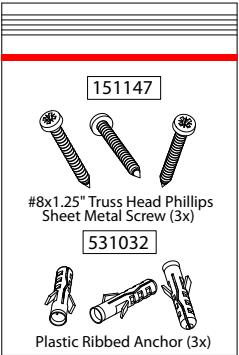
Quantity	Part Name	Illustration
1	Mounting Accessory Kit which includes: (3) Plastic Ribbed Anchors (3) #8 Sheet Metal Screws	 <p>The illustration shows a clear plastic bag with a red top edge. Inside the bag, there are three screws and three anchors. The screws are labeled with the part number 151147 and are identified as #8x1.25" Truss Head Phillips Sheet Metal Screw (3x). The anchors are labeled with the part number 531032 and are identified as Plastic Ribbed Anchor (3x).</p>

Note The Singlewire InformaCast Loudspeaker Amplifier (PoE) was designed for indoor use. Mounting it on the external part of a building will require additional hardware for weatherproofing, cabling access, and lightning suppression. Consult a certified electrician for details.

Note For mounting, use the three **#8 SHEET METAL SCREWS** to secure the enclosure.

A.1.1 Mounting the Enclosure

To mount the enclosure:

1. Prepare holes for the screws.
2. Plug in the power adapter and use the **Power (PWR)** LED to verify that the power is on.
3. Plug the ethernet cable into the device. The **Link/Activity (Link/Act.)** LED verifies the network connection.
4. For wall mounting, use the three #8 x 1-1/4-inch Truss Head Phillip screws to secure the speaker. See [Figure A-1](#).

Figure A-1. Mounting the Enclosure

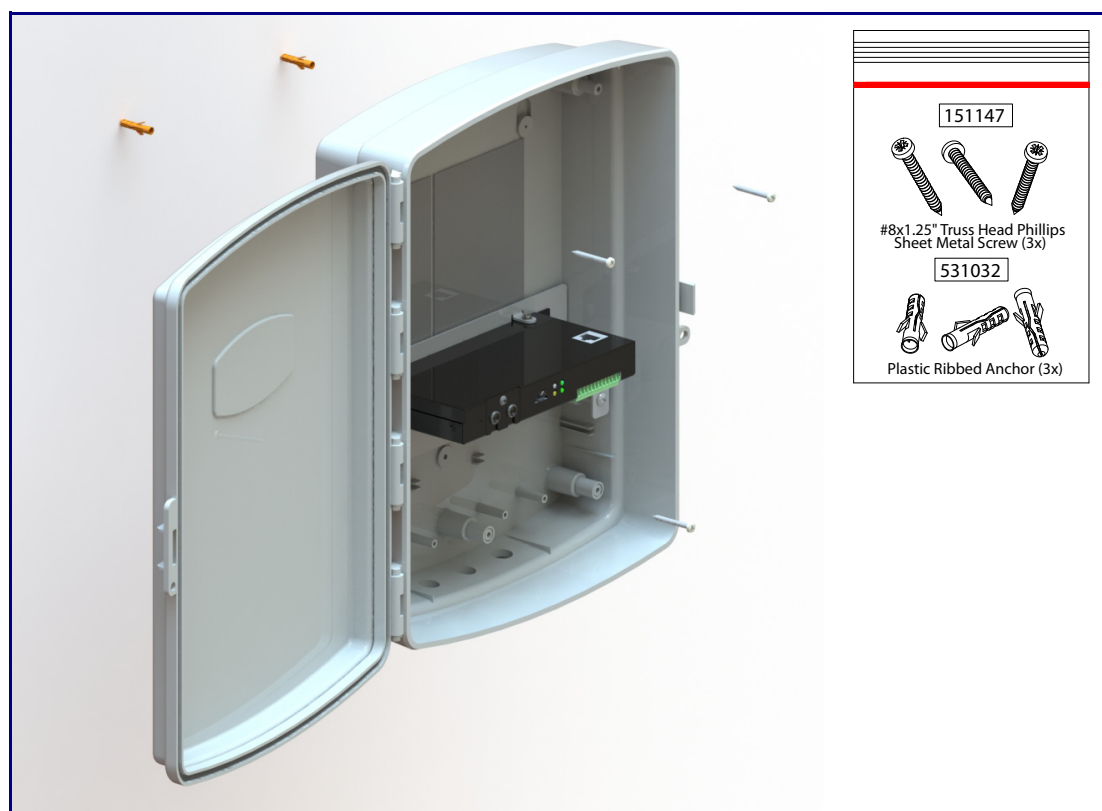

Appendix B: Setting up a TFTP Server

B.1 Set up a TFTP Server

Autoprovisioning requires a TFTP server for hosting the configuration file.

B.1.1 In a LINUX Environment

To set up a TFTP server on LINUX:

1. Create a directory dedicated to the TFTP server, and move the files to be uploaded to that directory.
2. Run the following command where `/tftpboot/` is the path to the directory you created in [Step 1](#): the directory that contains the files to be uploaded. For example:

```
in.tftpd -l -s /tftpboot/your_directory_name
```

B.1.2 In a Windows Environment

You can find several options online for setting up a Windows TFTP server. This example explains how to use the Solarwinds freeware TFTP server, which you can download at:

<http://www.cyberdata.net/support/voip/solarwinds.html>

To set up a TFTP server on Windows:

1. Install and start the software.
2. Select **File/Configure/Security** tab/**Transmit Only**.
3. Make a note of the default directory name, and then move the firmware files to be uploaded to that directory.

Appendix C: Troubleshooting/Technical Support

C.1 Frequently Asked Questions (FAQ)

To see a list of frequently asked questions for your product, click on the **FAQs** tab at the following webpage:

<http://www.cyberdata.net/voip/011407/>

C.2 Documentation

The documentation for this product is released in an English language version only.

To download PDF copies of CyberData product documentation, click on the **Downloads** tab at the following webpage:

<http://www.cyberdata.net/voip/011407/>

C.3 Contact Information

Contact CyberData Corporation
 3 Justin Court
 Monterey, CA 93940 USA
 www.CyberData.net
 Phone: 800-CYBERDATA (800-292-3732)
 Fax: 831-373-4193

Sales Sales 831-373-2601, Extension 334

Technical The fastest way to get technical support for your VoIP product is to submit a VoIP Technical
Support Support form at the following website:

<http://support.cyberdata.net/>

The Support Form initiates a ticket which CyberData uses for tracking customer requests. Most importantly, the Support Form tells us which PBX system and software version that you are using, the make and model of the switch, and other important information. This information is essential for troubleshooting. Please also include as much detail as possible in the **Comments** section of the Support Form.

Phone: (831) 373-2601, Extension 333

C.4 Warranty and RMA Information

The most recent warranty and RMA information is available at the following website address:

<http://support.cyberdata.net/>

Index

Symbols

#6 sheet metal screws 92

Numerics

1 speaker configuration 11, 12, 13
 16 gauge wire 11, 12, 13
 2 speaker configuration 13
 802.3af mode 11, 12, 13
 802.3at compliance switch 11, 12, 13
 802.3at mode 13
 802.3at power injector (high power mode) 11, 12, 13

A

AC voltages 2
 accessory kit 7, 92
 activate relay (door sensor) 60
 activity LED 21
 address, configuration login 29
 amplified outputs 11, 12, 13
 high power mode 13
 how to use and connect 11
 low power mode 11, 12
 announcing an IP address 22
 audio configuration 62
 night ring tone parameter 64
 audio configuration page 62
 audio encodings 4
 audio files, user-created 65
 audio test 22
 autoprovision at time (HHMMSS) 74
 autoprovision when idle (in minutes > 10) 74
 autoprovisioning 75
 download template button 75
 autoprovisioning autoupdate (in minutes) 74
 autoprovisioning configuration 73, 74
 autoprovisioning filename 74
 autoprovisioning server (IP Address) 74

B

backup SIP server 1 46
 backup SIP server 2 46
 backup SIP servers, SIP server

backups 46
 boost (volume) 34

C

cabling 20
 changing
 the web access password 33
 Cisco SRST 46
 command interface 88
 commands 88
 components 10
 configurable parameters 34, 42, 46
 configuration
 audio 62
 default IP settings 25
 door sensor 58
 intrusion sensor 58
 network 41
 SIP 44
 configuration home page 29
 configuration page
 configurable parameters 34, 42
 connecting the amplified outputs 11
 connection options 14
 connections 10, 14
 connections inside of the NEMA box 10
 contact information 96
 contact information for CyberData 96
 current network settings 42
 CyberData contact information 96

D

default
 gateway 8, 25
 IP address 8, 25
 subnet mask 8, 25
 username and password 8, 25
 web login username and password 29
 default gateway 8, 25, 42
 default IP settings 25
 default login address 29
 device configuration 33
 device configuration parameters 74
 the device configuration page 73
 device configuration page 33
 device configuration parameters 34

device configuration password
 changing for web configuration access 33
 DHCP Client 4
 dial out extension (door sensor) 60
 dial out extension strings 51
 dial-out extension strings 53
 dimensions 5
 disable volume control dial 34
 discovery utility program 29
 distortion, total harmonic 5
 DNS server 42
 door sensor 58
 activate relay 60
 dial out extension 60
 door sensor normally closed 60
 play audio locally 60
 download autoprovisioning template button 75
 DTMF tones 51, 53
 DTMF tones (using rfc2833) 51

E

enable night ring events 68
 enclosure, mounting 92
 ethernet I/F 5
 event configuration
 enable night ring events 68
 expiration time for SIP server lease 47, 49
 export settings 31, 32

F

factory defaults 9, 22
 firmware
 where to get the latest firmware 85

G

get autoprovisioning template 75
 GMT table 39
 GMT time 39

H

harmonic distortion 5
 hazard levels 4
 high power mode (amplified outputs) 13
 home page 29
 http POST command 88

http web-based configuration 4

I

identifier names (PST, EDT, IST, MUT) 39
 identifying your product 1
 illustration of amplifier mounting process 92
 import settings 31, 32
 import/export settings 31, 32
 input specifications 5
 installation 2
 IP address 8, 25, 42
 IP address announcement 22
 IP address confirmation 22
 IP addressing
 default
 IP addressing setting 8, 25

J

jumper descriptions 19
 jumper locations 19

L

lease, SIP server expiration time 47, 49
 LEDs 21
 lengthy pages 57
 line input specifications 5
 line output specifications 5
 Linux, setting up a TFTP server on 94
 local SIP port 47
 log in address 29
 loudspeaker type 20
 loudspeaker, cabling/wiring 20
 low power mode (amplified outputs) 11, 12

M

maximum wire length for two speaker configuration 13
 MGROUP
 MGROUP Name 56
 mounting an amplifier 92
 multicast configuration 54, 62
 Multicast IP Address 56

N

- navigation (web page) 26
- navigation table 26
- NEMA box components 10
- network configuration 41
- network link activity, verifying 21
- nightring tones 57
- Nightringer 84
- nightringer settings 48
- NTP server 34

O

- one speaker configuration 11, 12, 13
- operating temperature 5
- optional two speaker configuration 13
- output impedance 5
- output level 5
- output signal amplitudes 5
- output specifications 5

P

- packet time 4
- pages (lengthy) 57
- parts list 7
- password
 - for SIP server login 46
 - login 29
 - restoring the default 8, 25
- payload types 5
- play audio locally (door sensor) 60
- point-to-point configuration 52
- polycom default channel 56
- polycom emergency channel 56
- polycom priority channel 56
- port
 - local SIP 47
 - remote SIP 47
- posix timezone string
 - timezone string 35
- POST command 88
- power input 5
- power LED 9, 21
- power, connecting to paging amplifier 11
- priority
 - assigning 57
- product
 - mounting 92
 - parts list 7
- product features 3

- product overview
 - product features 3
 - product specifications 5
 - supported protocols 4
 - supported SIP servers 4
 - typical system installation 2
- product specifications 5
- protocols supported 4

R

- reboot 86, 87
- remote SIP port 47
- reset test function management switch 22
- resetting the IP address to the default 92
- restoring the factory defaults 9, 22
- ringtones 57
 - lengthy pages 57
- rport discovery setting, disabling 47
- RTFM switch 9, 22
- RTP/AVP 4

S

- safety instructions 5
- sales 96
- sensor
 - sensor normally closed 60
 - sensor timeout 60
- sensor connection 15
- sensor setup page 59
- sensor setup parameters 58
- sensors 60
- server address, SIP 46
- service 96
- set time with external NTP server on boot 34
- SIP
 - enable SIP operation 46
 - local SIP port 47
 - user ID 46
- SIP (session initiation protocol) 4
- SIP configuration 44
- SIP configuration parameters
 - outbound proxy 47, 49
 - registration and expiration, SIP server lease 47, 49
 - unregister on reboot 47
 - user ID, SIP 46
- SIP registration 46
- SIP remote SIP port 47
- SIP server 46
 - password for login 46
 - SIP servers supported 4

- unregister from 47
- user ID for login 46
- SIP server configuration 46
- SIP volume 34
- speaker cable 20
- speaker configuration 11, 12, 13
- speaker configuration for two speakers 13
- speaker wire 20
- SRST 46
- standard 1 speaker configuration 11, 12, 13
- status LED 9, 21
- subnet mask 8, 25, 42
- supported protocols 4

T

- tech support 96
- technical support, contact information 96
- test audio 22
- TFTP server 4, 94
- time zone string examples 39
- two speaker configuration 13

U

- user ID
 - for SIP server login 46
- username
 - changing for web configuration access 33
 - default for web configuration access 29
 - restoring the default 8, 25
- using the amplified outputs 11

V

- verifying
 - network link and activity 21
 - power on 21
- VLAN ID 42
- VLAN Priority 42
- VLAN tagging support 42
- VLAN tags 42
- volume 24
 - multicast volume 34
 - ring volume 34
 - sensor volume 34
 - SIP volume 34
- volume adjustment 23
- volume boost 34
- volume control dial
 - disable 34

- volume dial 24

W

- warranty policy at CyberData 96
- web access password 8, 25
- web access username 8, 25
- web configuration log in address 29
- web page
 - navigation 26
- web page navigation 26
- wget, free unix utility 88
- Windows, setting up a TFTP server on 94
- wire gauge 11, 12, 13
- wire length going to wire nuts for two speaker configuration 13
- wire nuts to connect wire 11, 12, 13
- wiring 20