



# PX2-3000/4000/5000 Series

User Guide  
Release 3.1

---

Copyright © 2015 Raritan, Inc.

DPX2-00-v3.1-E

May 2015

255-80-6101-00

---

## Safety Guidelines

**WARNING!** Read and understand all sections in this guide before installing or operating this product.

**WARNING!** Connect this product to an AC power source whose voltage is within the range specified on the product's nameplate. Operating this product outside the nameplate voltage range may result in electric shock, fire, personal injury and death.

**WARNING!** Connect this product to an AC power source that is current limited by a suitably rated fuse or circuit breaker in accordance with national and local electrical codes. Operating this product without proper current limiting may result in electric shock, fire, personal injury and death.

**WARNING!** Connect this product to a protective earth ground. Never use a "ground lift adaptor" between the product's plug and the wall receptacle. Failure to connect to a protective earth ground may result in electric shock, fire, personal injury and death.

**WARNING!** This product contains no user serviceable parts. Do not open, alter or disassemble this product. All servicing must be performed by qualified personnel. Disconnect power before servicing this product. Failure to comply with this warning may result in electric shock, personal injury and death.

**WARNING!** Use this product in a dry location. Failure to use this product in a dry location may result in electric shock, personal injury and death.

**WARNING!** Do not rely on this product's receptacle lamps, receptacle relay switches or any other receptacle power on/off indicator to determine whether power is being supplied to a receptacle. Unplug a device connected to this product before performing repair, maintenance or service on the device. Failure to unplug a device before servicing it may result in electric shock, fire, personal injury and death.

**WARNING!** Only use this product to power information technology equipment that has a UL/IEC 60950-1 or equivalent rating. Attempting to power non-rated devices may result in electric shock, fire, personal injury and death.

**WARNING!** Do not use a Raritan product containing outlet relays to power large inductive loads such as motors or compressors. Attempting to power a large inductive load may result in damage to the relay.

**WARNING!** Do not use this product to power critical patient care equipment, fire or smoke alarm systems. Use of this product to power such equipment may result in personal injury and death.

**WARNING!** If this product is a model that requires assembly of its line cord or plug, all such assembly must be performed by a licensed electrician and the line cord or plugs used must be suitably rated based on the product's nameplate ratings and national and local electrical codes. Assembly by unlicensed electricians or failure to use suitably rated line cords or plugs may result in electric shock, fire, personal injury or death.

**WARNING!** This product contains a chemical known to the State of California to cause cancer, birth defects, or other reproductive harm.

## Safety Instructions

1. Installation of this product should only be performed by a person who has knowledge and experience with electric power.
2. Make sure the line cord is disconnected from power before physically mounting or moving the location of this product.
3. This product is designed to be used within an electronic equipment rack. The metal case of this product is electrically bonded to the line cord ground wire. A threaded grounding point on the case may be used as an additional means of protectively grounding this product and the rack.
4. Examine the branch circuit receptacle that will supply electric power to this product. Make sure the receptacle's power lines, neutral and protective earth ground pins are wired correctly and are the correct voltage and phase. Make sure the branch circuit receptacle is protected by a suitably rated fuse or circuit breaker.
5. If the product is a model that contains receptacles that can be switched on/off, electric power may still be present at a receptacle even when it is switched off.

This document contains proprietary information that is protected by copyright. All rights reserved. No part of this document may be photocopied, reproduced, or translated into another language without express prior written consent of Raritan, Inc.

© Copyright 2015 Raritan, Inc. All third-party software and hardware mentioned in this document are registered trademarks or trademarks of and are the property of their respective holders.

#### FCC Information

This equipment has been tested and found to comply with the limits for a Class A digital device, pursuant to Part 15 of the FCC Rules. These limits are designed to provide reasonable protection against harmful interference in a commercial installation. This equipment generates, uses, and can radiate radio frequency energy and if not installed and used in accordance with the instructions, may cause harmful interference to radio communications. Operation of this equipment in a residential environment may cause harmful interference.

#### VCCI Information (Japan)

この装置は、クラスA情報技術装置です。この装置を家庭環境で使用すると電波妨害を引き起こすことがあります。この場合には使用者が適切な対策を講ずるよう要求されることがあります。 VCCI-A

Raritan is not responsible for damage to this product resulting from accident, disaster, misuse, abuse, non-Raritan modification of the product, or other events outside of Raritan's reasonable control or not arising under normal operating conditions.

If a power cable is included with this product, it must be used exclusively for this product.



### Warning

This is a class A product. In a domestic environment this product may cause radio interference in which case the user may be required to take adequate measures.

### CAUTION:



To reduce the risk of shock – Use indoors only in a dry location. No user serviceable parts inside. Refer servicing to qualified personnel. For use with IT equipment only. Disconnect power before servicing.



SecureLock™

# Contents

<b>Safety Guidelines</b>	<b>ii</b>
<hr/>	
<b>Safety Instructions</b>	<b>iii</b>
<hr/>	
<b>Applicable Models</b>	<b>xvi</b>
<hr/>	
<b>What's New in the PX User Guide</b>	<b>xviii</b>
<hr/>	
<b>Chapter 1 Introduction</b>	<b>1</b>
<hr/>	
Product Models .....	1
Package Contents.....	1
Zero U Products.....	1
1U Products .....	2
2U Products .....	2
<hr/>	
<b>Chapter 2 Rack-Mounting the PDU</b>	<b>3</b>
<hr/>	
Rackmount Safety Guidelines .....	3
Circuit Breaker Orientation Limitation .....	3
Mounting Zero U Models Using L-Brackets .....	4
Mounting Zero U Models Using Button Mount.....	5
Mounting Zero U Models Using Claw-Foot Brackets.....	7
Mounting Zero U Models Using Two Rear Buttons .....	8
Mounting 1U or 2U Models .....	9
<hr/>	
<b>Chapter 3 Installation and Configuration</b>	<b>11</b>
<hr/>	
Before You Begin.....	11
Unpacking the Product and Components.....	11
Preparing the Installation Site.....	11
Checking the Branch Circuit Rating.....	12

Filling Out the Equipment Setup Worksheet .....	12
Installing Cable Retention Clips on the Inlet (Optional).....	12
Connecting the PDU to a Power Source .....	13
Configuring the PX.....	14
Connecting the PX to a Computer.....	15
Installing the USB-to-Serial Driver (Optional).....	16
Connecting the PX to Your Network.....	17
Initial Network Configuration via CLI .....	19
Cascading the PX via USB .....	25
Installing Cable Retention Clips on Outlets (Optional) .....	28

**Chapter 4 Connecting External Equipment (Optional) 30**

---

Connecting Environmental Sensor Packages .....	30
DPX Sensor Packages .....	30
DPX2 Sensor Packages .....	35
DX Sensor Packages .....	37
Guidelines for PX with Two Sensor Ports .....	39
Connecting the Asset Management Sensor.....	40
Combining Asset Sensors .....	40
Connecting Asset Sensors to the PX .....	42
Connecting Blade Extension Strips .....	44
Connecting Composite Asset Sensors (AMS-Mx-Z) .....	47
Using an X Cable.....	49
Connecting a Logitech Webcam.....	52
Connecting a GSM Modem .....	53
Connecting an Analog Modem .....	53
Connecting an External Beeper.....	54
Connecting a Schroff LHX/SHX Heat Exchanger.....	54

**Chapter 5 Using the PDU 55**

---

Panel Components .....	55
Power Cord.....	55
Outlets .....	55
Connection Ports .....	57
LED Display .....	59
Reset Button .....	65
Circuit Breakers .....	65
Resetting the Button-Type Circuit Breaker .....	66
Resetting the Handle-Type Circuit Breaker .....	66
Fuse .....	67
Fuse Replacement on Zero U Models.....	67
Fuse Replacement on 1U Models .....	69

Beeper ..... 70

**Chapter 6 Using the Web Interface 71**

---

Supported Web Browsers ..... 71

Logging in to the Web Interface ..... 72

    Login ..... 72

    Changing Your Password ..... 74

    Remembering User Names and Passwords ..... 74

Logout ..... 75

Introduction to the Web Interface ..... 76

    Menus ..... 77

    PX Explorer Pane ..... 77

    Setup Button ..... 80

    Status Bar ..... 80

    Add Page Icon ..... 81

    Logout Button ..... 82

    Data Pane ..... 82

    More Information ..... 82

Viewing the Dashboard ..... 87

    Alerted Sensors ..... 87

    Alarms List ..... 88

Device Management ..... 89

    Displaying PDU Information ..... 90

    Naming the PDU ..... 95

    Modifying the Network Configuration ..... 95

    Modifying Network Service Settings ..... 105

    Setting the Date and Time ..... 112

    Setting Default Measurement Units ..... 116

    Configuring the Feature Port ..... 117

    Configuring the Serial Port ..... 118

    Setting the Cascading Mode ..... 119

    Setting Data Logging ..... 125

    Configuring SMTP Settings ..... 126

    Configuring Data Push Settings ..... 127

    Specifying the Device Altitude ..... 128

    Rebooting the PX Device ..... 129

    Resetting All Active Energy Readings ..... 129

    Monitoring Total Active Energy or Power ..... 130

    Checking the Internal Beeper State ..... 131

    Setting the EnergyWise Configuration ..... 131

User Management ..... 132

    Creating a User Profile ..... 132

    Modifying a User Profile ..... 136

    Deleting a User Profile ..... 136

    Changing the User List View ..... 137

    Setting Up Your Preferred Measurement Units ..... 137

Setting Up Roles ..... 138

    Creating a Role ..... 138

    Modifying a Role ..... 139



Deleting a Role .....	140
Changing the Role List View .....	141
Access Security Control.....	141
Forcing HTTPS Encryption.....	141
Configuring the Firewall.....	141
Setting Up User Login Controls.....	148
Setting Up Role-Based Access Control Rules .....	152
Setting Up a TLS Certificate .....	156
Certificate Signing Request .....	157
Creating a Self-Signed Certificate .....	159
Installing Existing Key and Certificate Files.....	161
Downloading Key and Certificate Files.....	161
Setting Up External Authentication .....	162
Gathering the External Authentication Information.....	162
Adding Authentication Servers .....	164
Sorting the Access Order .....	168
Testing the Server Connection.....	168
Editing Authentication Server Settings .....	169
Deleting Authentication Server Settings.....	169
Disabling External Authentication.....	169
Enabling External and Local Authentication Services.....	170
Outlet Management .....	170
Naming Outlets .....	170
Outlet Monitoring .....	171
Outlet Switching.....	173
Setting the Default Outlet State.....	176
Changing the Cycling Power-Off Period.....	177
Setting the Initialization Delay .....	180
Setting the Inrush Guard Delay .....	181
Setting the Outlet Power-On Sequence .....	181
Setting the Outlet-Specific Power-On Delay .....	182
Setting Non-Critical Outlets and Load Shedding Mode.....	183
Resetting Outlet Active Energy Readings .....	186
Enabling Front Panel Outlet Switching.....	187
Inlet and Overcurrent Protector Management .....	187
Naming the Inlet .....	187
Naming Overcurrent Protectors.....	188
Monitoring the Inlet .....	188
Monitoring Overcurrent Protectors .....	189
Resetting Inlet Active Energy Readings .....	190
Disabling an Inlet (for Multi-Inlet PDUs) .....	191
Setting Power Thresholds.....	192
Setting an Outlet's Thresholds .....	192
Bulk Configuration for Outlet Thresholds .....	193
Setting Inlet Thresholds.....	194
Setting an Overcurrent Protector's Thresholds .....	195
Bulk Configuration for Overcurrent Protector Thresholds .....	196
Setting Thresholds for Total Active Energy or Power.....	197
Event Rules and Actions.....	199
Components of an Event Rule.....	199
Creating an Event Rule .....	199
Sample Event Rules .....	239

A Note about Infinite Loop .....	242
Modifying an Event Rule.....	243
Modifying an Action .....	245
Deleting an Event Rule or Action.....	245
A Note about Untriggered Rules.....	246
Managing Event Logging .....	246
Viewing the Local Event Log .....	246
Viewing the Wireless LAN Diagnostic Log .....	247
Viewing Connected Users .....	248
Monitoring Server Accessibility.....	249
Adding IT Devices for Ping Monitoring .....	250
Editing Ping Monitoring Settings.....	252
Deleting Ping Monitoring Settings .....	253
Checking Server Monitoring States .....	253
Environmental Sensors and Actuators .....	254
Identifying Environmental Sensors and Actuators.....	255
Managing Environmental Sensors or Actuators .....	258
Configuring Environmental Sensors or Actuators .....	259
Viewing Sensor or Actuator Data .....	265
Unmanaging Environmental Sensors or Actuators .....	269
Disabling the Automatic Management Function.....	270
Controlling Actuators .....	270
Asset Management.....	271
Configuring the Asset Sensor.....	271
Setting Asset Sensor LED Colors.....	272
Configuring a Specific Rack Unit.....	273
Expanding a Blade Extension Strip .....	274
Displaying the Asset Sensor Information .....	275
Bulk Configuration.....	276
Saving the PX Configuration .....	277
Copying the PX Configuration .....	278
Backup and Restore of PX Device Settings .....	279
Webcam Management.....	280
Configuring Webcams .....	280
Adjusting Image Properties .....	281
Viewing Webcam Snapshots or Videos .....	282
Sending Snapshots or Videos in an Email or Instant Message .....	284
Snapshot Storage.....	286
Network Diagnostics .....	289
Pinging a Host .....	289
Tracing the Network Route.....	289
Listing TCP Connections .....	290
Downloading Diagnostic Information .....	290
Managing the Schroff LHX/SHX Heat Exchanger .....	291
Enabling and Disabling Schroff LHX/SHX Heat Exchanger Support .....	292
Configuring the LHX/SHX Device.....	292
Monitoring the LHX/SHX Device .....	295
Turning the LHX/SHX On or Off .....	298
Requesting Maximum Cooling for an SHX-30.....	299
Firmware Upgrade .....	299
Updating the PX Firmware .....	300
Viewing Firmware Update History .....	302

Full Disaster Recovery .....	303
Updating the Asset Sensor Firmware.....	303
Accessing the Help .....	303
Retrieving Software Packages Information .....	303
Browsing through the Online Help.....	304

## **Chapter 7 Using SNMP 306**

---

Enabling SNMP.....	306
Configuring Users for Encrypted SNMP v3 .....	307
Configuring SNMP Notifications .....	308
SNMPv2c Notifications .....	309
SNMPv3 Notifications.....	310
SNMP Gets and Sets.....	312
The PX MIB .....	313
Retrieving Energy Usage.....	315
A Note about Enabling Thresholds.....	316

## **Chapter 8 Using the Command Line Interface 317**

---

About the Interface.....	317
Logging in to CLI.....	318
With HyperTerminal .....	318
With SSH or Telnet.....	319
With an Analog Modem .....	320
Different CLI Modes and Prompts .....	321
Closing a Local Connection.....	321
Help Command .....	322
Querying Available Parameters for a Command .....	323
Showing Information .....	323
Network Configuration .....	324
PDU Configuration.....	326
Outlet Information .....	327
Inlet Information .....	328
Overcurrent Protector Information.....	329
Date and Time Settings .....	330
Default Measurement Units .....	330
Environmental Sensor Information .....	331
Environmental Sensor Package Information .....	333
Actuator Information .....	334
Outlet Sensor Threshold Information .....	335
Outlet Pole Sensor Threshold Information .....	336
Inlet Sensor Threshold Information .....	337
Inlet Pole Sensor Threshold Information .....	338
Overcurrent Protector Sensor Threshold Information .....	339
Environmental Sensor Threshold Information .....	340
Environmental Sensor Default Thresholds.....	341
Security Settings.....	342
Existing User Profiles .....	343

Existing Roles .....	344
Load Shedding Settings .....	344
Serial Port Settings .....	345
EnergyWise Settings .....	345
USB-Cascading Configuration Information .....	345
Asset Sensor Settings .....	345
Rack Unit Settings of an Asset Sensor .....	346
Blade Extension Strip Settings .....	347
Event Log .....	348
Wireless LAN Diagnostic Log .....	349
Server Reachability Information .....	349
Command History .....	351
History Buffer Length .....	351
Reliability Data .....	351
Reliability Error Log .....	351
Examples .....	352
Clearing Information.....	354
Clearing Event Log .....	354
Configuring the PX Device and Network .....	355
Entering Configuration Mode .....	355
Quitting Configuration Mode .....	355
PDU Configuration Commands .....	356
Network Configuration Commands.....	364
Time Configuration Commands.....	388
Security Configuration Commands.....	391
Outlet Configuration Commands .....	411
Inlet Configuration Commands .....	412
Overcurrent Protector Configuration Commands .....	414
User Configuration Commands .....	414
Role Configuration Commands .....	427
Environmental Sensor Configuration Commands .....	432
Configuring Environmental Sensors' Default Thresholds .....	437
Sensor Threshold Configuration Commands .....	439
Actuator Configuration Commands .....	449
Server Reachability Configuration Commands .....	450
EnergyWise Configuration Commands .....	454
USB-Cascading Configuration Commands .....	456
Asset Management Commands .....	456
Serial Port Configuration Commands .....	463
Setting the History Buffer Length.....	464
Multi-Command Syntax .....	465
Load Shedding Configuration Commands.....	466
Enabling or Disabling Load Shedding .....	467
Power Control Operations .....	468
Turning On the Outlet(s).....	468
Turning Off the Outlet(s).....	469
Power Cycling the Outlet(s).....	470
Canceling the Power-On Process .....	471
Example - Power Cycling Specific Outlets .....	471
Checking the Accessibility of NTP Servers .....	472
Actuator Control Operations .....	472
Switching On an Actuator .....	473

Switching Off an Actuator .....	473
Example - Turning On a Specific Actuator .....	474
Unblocking a User.....	474
Resetting the PX .....	474
Restarting the PDU.....	475
Resetting Active Energy Readings .....	475
Resetting to Factory Defaults .....	476
Network Troubleshooting .....	476
Entering Diagnostic Mode .....	476
Quitting Diagnostic Mode .....	477
Diagnostic Commands .....	477
Retrieving Previous Commands .....	479
Automatically Completing a Command.....	479
Logging out of CLI.....	480

---

**Chapter 9 In-Line Monitors 481**

Overview .....	481
Safety Instructions .....	481
Flexible Cord Installation Instructions .....	482
Flexible Cord Selection.....	482
Plug Selection.....	483
Receptacle Selection .....	483
Derating a Raritan Product.....	483
Wiring of 3-Phase In-Line Monitors .....	484
In-Line Monitor Unused Channels .....	484
Step by Step Flexible Cord Installation .....	484
In-Line Monitor's LED Display.....	490
Automatic Mode.....	490
Manual Mode.....	490
In-Line Monitor's Web Interface.....	491
Dashboard Page.....	492
Outlet Page.....	492

<b>Appendix A</b>	<b>Specifications</b>	<b>494</b>
<hr/>		
	Maximum Ambient Operating Temperature .....	494
	Serial RS-232 Port Pinouts .....	494
	Sensor RJ-12 Port Pinouts .....	494
	Feature RJ-45 Port Pinouts .....	495
<b>Appendix B</b>	<b>Equipment Setup Worksheet</b>	<b>496</b>
<hr/>		
<b>Appendix C</b>	<b>Bulk Configuration or Firmware Upgrade via DHCP/TFTP</b>	<b>500</b>
<hr/>		
	Bulk Configuration/Upgrade Procedure .....	500
	TFTP Requirements.....	501
	DHCP IPv4 Configuration in Windows.....	502
	DHCP IPv6 Configuration in Windows.....	512
	DHCP IPv4 Configuration in Linux.....	519
	DHCP IPv6 Configuration in Linux.....	521
<b>Appendix D</b>	<b>Resetting to Factory Defaults</b>	<b>523</b>
<hr/>		
	Using the Reset Button .....	523
	Using the CLI Command .....	524
<b>Appendix E</b>	<b>Available SCP Commands</b>	<b>526</b>
<hr/>		
	Firmware Update via SCP .....	526
	Bulk Configuration via SCP .....	527
	Backup and Restore via SCP .....	528
<b>Appendix F</b>	<b>LDAP Configuration Illustration</b>	<b>530</b>
<hr/>		
	Step A. Determine User Accounts and Groups .....	530
	Step B. Configure User Groups on the AD Server .....	531
	Step C. Configure LDAP Authentication on the PX Device .....	532
	Step D. Configure User Groups on the PX Device .....	534
<b>Appendix G</b>	<b>RADIUS Configuration Illustration</b>	<b>538</b>
<hr/>		
	Microsoft Network Policy Server .....	538
	Step A: Add Your PX as a RADIUS Client .....	539
	Step B: Configure Connection Request Policies .....	542

Step C: Configure a Vendor-Specific Attribute .....	557
AD-Related Configuration.....	559
Non-Windows RADIUS Server .....	562
Dictionary File.....	562
Format of the "string" .....	563

**Appendix H Integration 565**

---

Power IQ Configuration .....	565
Adding PDUs to Power IQ Management.....	566
Dominion KX II Configuration .....	568
Configuring Rack PDU (Power Strip) Targets .....	568
Dominion KSX II or SX Configuration .....	573
Dominion KSX II .....	573
Dominion SX.....	578
dcTrack .....	581
dcTrack Overview.....	582
Adding the PX to dcTrack Management.....	582

**Appendix I Additional PX Information 584**

---

MAC Address.....	584
Locking Outlets and Cords .....	584
SecureLock™ Outlets and Cords.....	585
Button-Type Locking Outlets .....	586
Unbalanced Current Calculation.....	587
Altitude Correction Factors .....	588
Data for BTU Calculation .....	589
Raritan Training Website .....	589
Truncated Data in the Web Interface.....	590
Reserving IP Addresses in Windows DHCP Servers .....	590
Sensor Threshold Settings .....	591
Thresholds and Sensor States .....	592
"To Assert" and Assertion Timeout.....	594
"To De-assert" and Deassertion Hysteresis .....	596
Ways to Probe Existing User Profiles .....	598

**Index 599**

---

## Applicable Models

This online help is applicable to the following PDUs (*n* indicated below represents a number).

- PX2-3nnn series
- PX2-4nnn series
- PX2-5nnn series

In this Online Help, PX2-3nnn is called PX2-3000, PX2-4nnn is called PX2-4000, and PX2-5nnn is called PX2-5000 for convenience.

---

*Note: For information on other PX2 or PX3 models, see their respective online help on the Raritan website's **Support page** (<http://www.raritan.com/support/>).*

---

► **PX models comparison in brief:**

Features	Inlet power measurement	Outlet power measurement	Outlet switching	Load shedding
PX2-1000 PX3-1000	✓			
PX2-2000 PX3-2000	✓		✓	✓
PX2-3000 PX3-3000		✓		
PX2-4000 PX3-4000	✓	✓		
PX2-5000 PX3-5000	✓	✓	✓	✓



► Comparison between PX2 and PX3 series:

Features	Front panel display	Outlet latching relays	Number of USB-A ports	SENSOR port type	Replaceable controller
<b>PX2 series</b>	LED display		1	RJ-12	
<b>PX3 phase I series</b>	Character LCD display	✔ *	2	RJ-4 5	***
<b>PX3 phase II series</b>	Dot-matrix LCD display	✔ *	2	RJ-45	✔ **

\* Only PX3 models with outlet switching (phase I and phase II models) have outlet latching relays.

\*\* Only PX3 "Zero U" phase II models have the replaceable controller.

\*\*\* PX3 phase I models do NOT support a replaceable controller.

# What's New in the PX User Guide

Important: Raritan disables SSL 3.0 and uses TLS for releases 3.0.4, 3.0.20 and later releases due to published security vulnerabilities in SSL 3.0. Make sure your network infrastructure, such as LDAP and mail services, uses TLS rather than SSL 3.0.

The following sections have changed or information has been added to the PX Online Help based on enhancements and changes to the equipment and/or user documentation.

**USB Wireless LAN Adapters** (on page 18)

**Cascading the PX via USB** (on page 25)

**DPX2 Sensor Packages** (on page 35)

**DX Sensor Packages** (on page 37)

**Connecting a DPX2 Sensor Package to DX** (on page 38)

**Guidelines for PX with Two Sensor Ports** (on page 39)

**Connecting Blade Extension Strips** (on page 44)

**Connecting Composite Asset Sensors (AMS-Mx-Z)** (on page 47)

**Daisy-Chain Limitations of Composite Asset Sensors** (on page 48)

**Connecting a Logitech Webcam** (on page 52)

**Alarms List** (on page 88)

**Wireless Network Settings** (on page 97)

**Configuring SMTP Settings** (on page 126)

**Configuring Data Push Settings** (on page 127)

**Monitoring Total Active Energy or Power** (on page 130)

**Setting Up a TLS Certificate** (on page 156)

**Setting Up External Authentication** (on page 162)

**Adding LDAP Server Settings** (on page 164)

**Marking All Outlets** (on page 183)

**Activating or Deactivating the Load Shedding Mode** (on page 185)

**Setting Thresholds for Total Active Energy or Power** (on page 197)

**Creating Actions** (on page 200)

**Alarm** (on page 203)

- Push Out Sensor Readings*** (on page 206)
- Send EMail*** (on page 208)
- Syslog Message*** (on page 211)
- Change Load Shedding State*** (on page 214)
- Internal Beeper*** (on page 216)
- Creating Rules*** (on page 220)
- Scheduling an Action*** (on page 225)
- Default Log Messages*** (on page 227)
- Email and SMS Message Placeholders*** (on page 236)
- Viewing the Local Event Log*** (on page 246)
- Viewing the Wireless LAN Diagnostic Log*** (on page 247)
- Environmental Sensors and Actuators*** (on page 254)
- Managing Environmental Sensors or Actuators*** (on page 258)
- Configuring Environmental Sensors or Actuators*** (on page 259)
- Changing Default Thresholds*** (on page 263)
- Saving the PX Configuration*** (on page 277)
- Configuring Webcams*** (on page 280)
- Adjusting Image Properties*** (on page 281)
- Viewing Webcam Snapshots or Videos*** (on page 282)
- Sending Snapshots or Videos in an Email or Instant Message*** (on page 284)
- Managing the Snapshots Saved to PX*** (on page 287)
- Using the Command Line Interface*** (on page 317)
- Bulk Configuration or Firmware Upgrade via DHCP/TFTP*** (on page 500)
- Available SCP Commands*** (on page 526)
- RADIUS Configuration Illustration*** (on page 538)
- Adding the PX to dcTrack Management*** (on page 582)
- Ways to Probe Existing User Profiles*** (on page 598)

Chapter 1: What's New in the PX User Guide

Please see the Release Notes for a more detailed explanation of the changes applied to this version of PX.

# Chapter 1 Introduction

Raritan PX is an intelligent power distribution unit (PDU) that allows you to reboot remote servers and other network devices and/or to monitor power in the data center.

The intended use of the Raritan PX is distribution of power to information technology equipment such as computers and communication equipment where such equipment is typically mounted in an equipment rack located in an information technology equipment room.

Raritan offers different types of PX units -- some are outlet-switching capable, and some are not. With the outlet-switching function, you can recover systems remotely in the event of system failure and/or system lockup, eliminate the need to perform manual intervention or dispatch field personnel, reduce downtime and mean time to repair, and increase productivity.

## In This Chapter

Product Models.....	1
Package Contents .....	1

---

## Product Models

The PX comes in several models that are built to stock and can be obtained almost immediately. Raritan also offers custom models that are built to order and can only be obtained on request.

Download the PX Data Sheet from Raritan's website, visit the **Product Selector page** (<http://www.findmypdu.com/>) on Raritan's website, or contact your local reseller for a list of available models.

---

## Package Contents

The following sub-topics describe the equipment and other material included in the product package.

---

### Zero U Products

- The PX device
- Screws, brackets and/or buttons for Zero U
- A null-modem cable with DB9 connectors on both ends (Raritan number: 254-01-0006-00) (optional)
- Cable retention clips for the inlet (for some models only)
- Cable retention clips for outlets (for some models only)

---

**1U Products**

- The PX device
- 1U bracket pack and screws
- A null-modem cable with DB9 connectors on both ends (Raritan number: 254-01-0006-00) (optional)
- Cable retention clips for the inlet (for some models only)

---

**2U Products**

- The PX device
- 2U bracket pack and screws
- A null-modem cable with DB9 connectors on both ends (Raritan number: 254-01-0006-00) (optional)
- Cable retention clips for the inlet (for some models only)

## Chapter 2 Rack-Mounting the PDU

This chapter describes how to rack mount a PX device. Only the most common rackmount method is displayed. Follow the procedure suitable for your model.

### In This Chapter

Rackmount Safety Guidelines .....	3
Circuit Breaker Orientation Limitation.....	3
Mounting Zero U Models Using L-Brackets.....	4
Mounting Zero U Models Using Button Mount .....	5
Mounting Zero U Models Using Claw-Foot Brackets .....	7
Mounting Zero U Models Using Two Rear Buttons .....	8
Mounting 1U or 2U Models.....	9

---

### Rackmount Safety Guidelines

In Raritan products which require rack mounting, follow these precautions:

- Operation temperature in a closed rack environment may be greater than room temperature. Do not exceed the rated maximum ambient temperature of the Power Distribution Units. See **Specifications** (on page 494) in the Online Help.
- Ensure sufficient airflow through the rack environment.
- Mount equipment in the rack carefully to avoid uneven mechanical loading.
- Connect equipment to the supply circuit carefully to avoid overloading circuits.
- Ground all equipment properly, especially supply connections, to the branch circuit.

---

### Circuit Breaker Orientation Limitation

Usually a PDU can be mounted in any orientation. However, when mounting a PDU with circuit breakers, you must obey these rules:

- Circuit breakers CANNOT face down. For example, do not horizontally mount a Zero U PDU with circuit breakers on the ceiling.
- If a rack is subject to shock in environments such as boats or airplanes, the PDU CANNOT be mounted upside down. If installed upside down, shock stress reduces the trip point by 10%.

---

*Note: If normally the line cord is down, upside down means the line cord is up.*

---

---

## Mounting Zero U Models Using L-Brackets

If your PDU has circuit breakers implemented, read **Circuit Breaker Orientation Limitation** (on page 3) before mounting it.

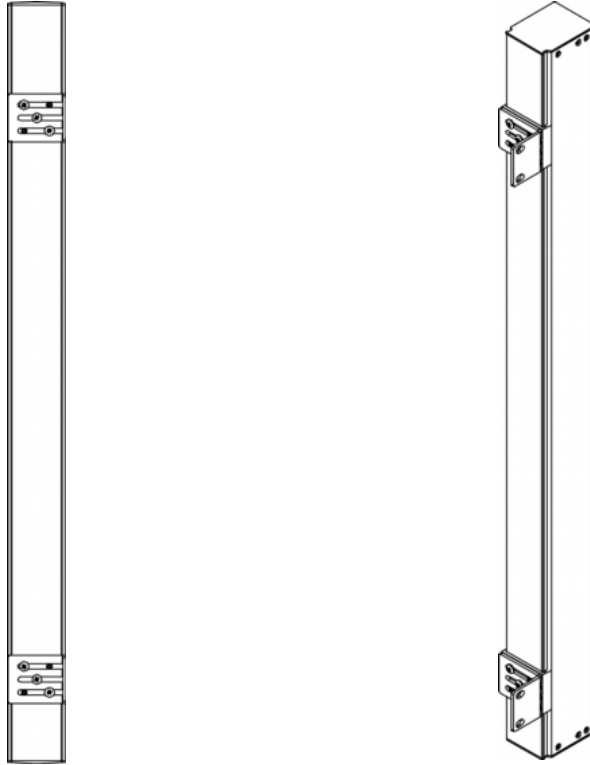

► **To mount Zero U models using L-brackets:**

1. Align the baseplates on the rear of the PX device.
2. Secure the baseplates in place. Use the included L-shaped hex key to loosen the hex socket screws until the baseplate is "slightly" fastened.

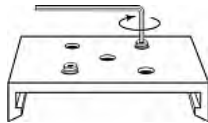

3. Align the L-brackets with the baseplates so that the five screw-holes on the baseplates line up through the L-bracket's slots. The rackmount side of brackets should face either the left or right side of the PX device.
4. Fasten the brackets in place with at least three screws (one through each slot). Use additional screws as desired.



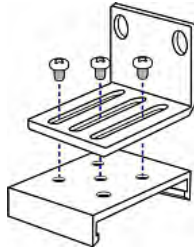

5. Using rack screws, fasten the PX device to the rack through the L-brackets.

---

## Mounting Zero U Models Using Button Mount

If your PDU has circuit breakers implemented, read **Circuit Breaker Orientation Limitation** (on page 3) before mounting it.

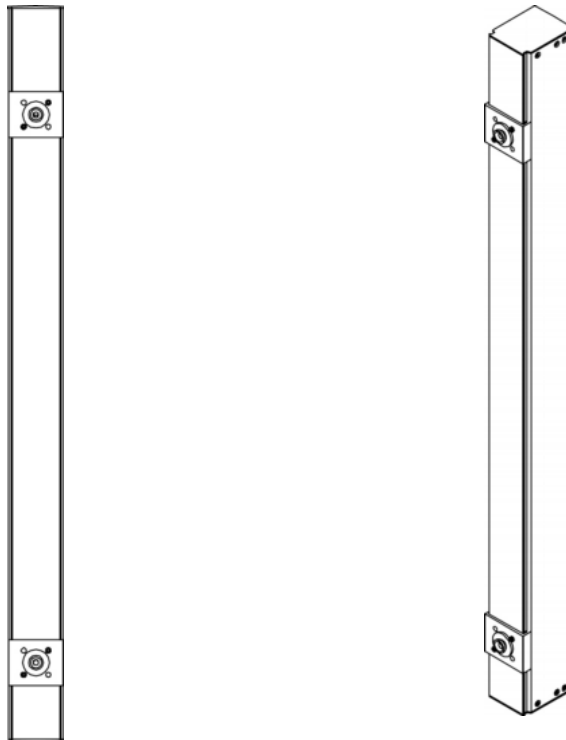

► **To mount Zero-U models using button mount:**

1. Align the baseplates on the rear of the PX device. Leave at least 24 inches between the baseplates for stability.
2. Make the baseplates grasp the PX device lightly. Use the included L-shaped hex key to loosen the hex socket screws until the baseplate is "slightly" fastened.

3. Screw each mounting button in the center of each baseplate. The recommended torque for the button is 1.96 N·m (20 kgf·cm).

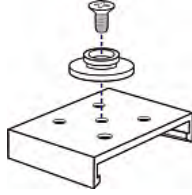

4. Align the large mounting buttons with the mounting holes in the cabinet, fixing one in place and adjusting the other.
5. Loosen the hex socket screws until the mounting buttons are secured in their position.
6. Ensure that both buttons can engage their mounting holes simultaneously.
7. Press the PX device forward, pushing the mounting buttons through the mounting holes, then letting the device drop about 5/8". This secures the PX device in place and completes the installation.

---

## Mounting Zero U Models Using Claw-Foot Brackets

If your PDU has circuit breakers implemented, read **Circuit Breaker Orientation Limitation** (on page 3) before mounting it.

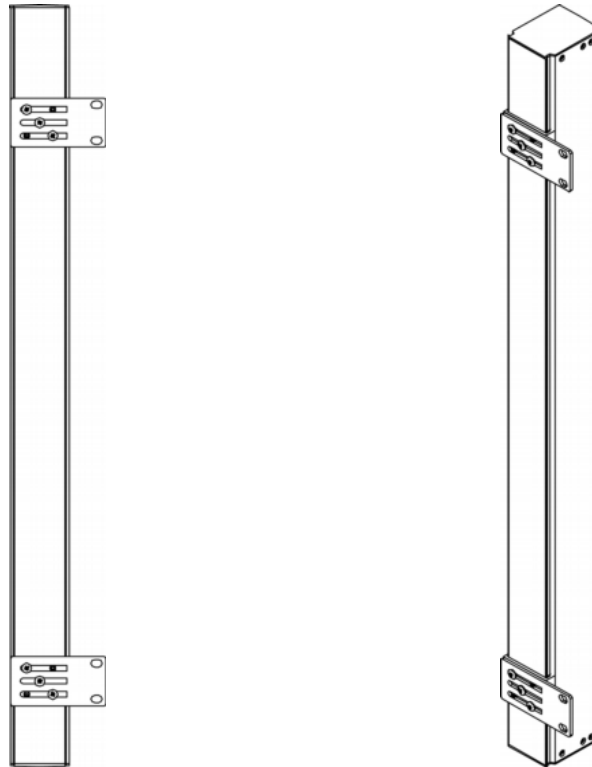

► **To mount Zero U models using claw-foot brackets:**

1. Align the baseplates on the rear of the PX device.
2. Secure the baseplates in place. Use the included L-shaped hex key to loosen the hex socket screws until the baseplate is "slightly" fastened.
3. Align the claw-foot brackets with the baseplates so that the five screw-holes on the baseplates line up through the bracket's slots. The rackmount side of brackets should face either the left or right side of the PX device.
4. Fasten the brackets in place with at least three screws (one through each slot). Use additional screws as desired.

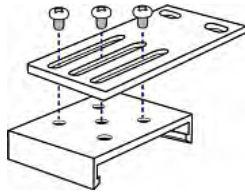

5. Using rack screws, fasten the PX device to the rack through the claw-foot brackets.

---

## Mounting Zero U Models Using Two Rear Buttons

The following describes how to mount a PDU using two buttons only. If your PDU has circuit breakers implemented, read **Circuit Breaker Orientation Limitation** (on page 3) before mounting it.

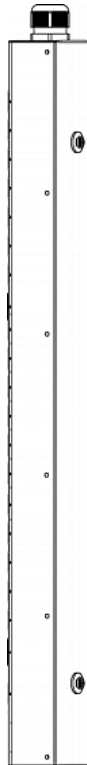

► **To mount Zero U models using two buttons:**

1. Turn to the rear of the PDU.
2. Locate two screw holes on the rear panel: one near the bottom and the other near the top (the side of cable gland).

3. Screw a button in the screw hole near the bottom. The recommended torque for the button is 1.96 N·m (20 kgf·cm).

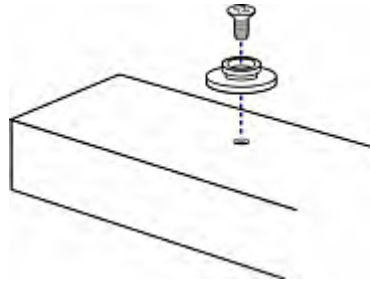

4. Screw a button in the screw hole near the top. The recommended torque for the button is 1.96 N·m (20 kgf·cm).
5. Ensure that the two buttons can engage their mounting holes in the rack or cabinet simultaneously.
6. Press the PX device forward, pushing the mounting buttons through the mounting holes, then letting the device drop slightly. This secures the PX device in place and completes the installation.

---

## Mounting 1U or 2U Models

Using the appropriate brackets and tools, fasten the 1U or 2U PX device to the rack or cabinet.

► **To mount the PX device:**

1. Attach a rackmount bracket to both sides of the PX with the provided screws.

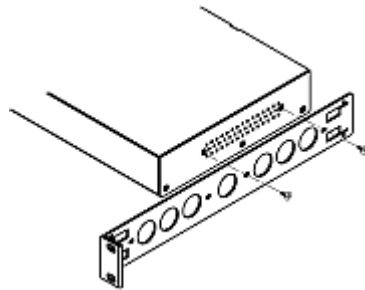

2. Insert the cable-support bar into rackmount brackets.

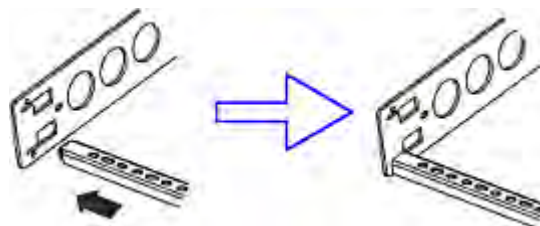

3. Secure with the provided end cap screws.

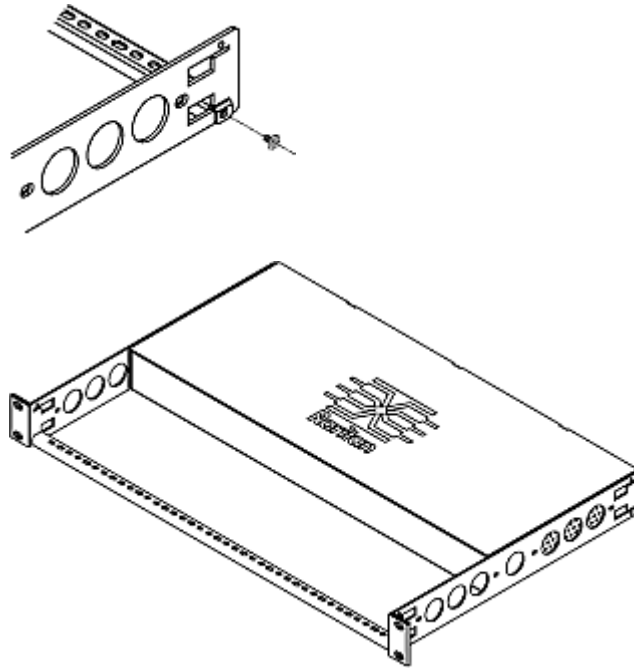

4. Fasten the rackmount brackets' ears to the rack using your own fasteners.

# Chapter 3 Installation and Configuration

This chapter explains how to install a PX device and configure it for network connectivity.

## In This Chapter

Before You Begin .....	11
Installing Cable Retention Clips on the Inlet (Optional).....	12
Connecting the PDU to a Power Source .....	13
Configuring the PX .....	14
Cascading the PX via USB.....	25
Installing Cable Retention Clips on Outlets (Optional).....	28

---

## Before You Begin

Before beginning the installation, perform the following activities:

- Unpack the product and components
- Prepare the installation site
- Check the branch circuit rating
- Fill out the equipment setup worksheet

---

## Unpacking the Product and Components

1. Remove the PX device and other equipment from the box in which they were shipped. See **Package Contents** (on page 1) for a complete list of the contents of the box.
2. Compare the serial number of the equipment with the number on the packing slip located on the outside of the box and make sure they match.
3. Inspect the equipment carefully. If any of the equipment is damaged or missing, contact Raritan's Technical Support Department for assistance.
4. Verify that all circuit breakers on the PX device are set to ON. If not, turn them ON.

Or make sure that all fuses are inserted and seated properly. If there are any fuse covers, ensure that they are closed.

---

*Note: Not all PX devices have overcurrent protection mechanisms.*

---

---

## Preparing the Installation Site

1. Make sure the installation area is clean and free of extreme temperatures and humidity.

---

*Note: If necessary, contact Raritan Technical Support for the maximum operating temperature for your model. See **Maximum Ambient Operating Temperature** (on page 494).*

---

2. Allow sufficient space around the PX device for cabling and outlet connections.
3. Review **Safety Instructions** (on page iii) listed in this online help.

---

### Checking the Branch Circuit Rating

The rating of the branch circuit supplying power to the PDU shall be in accordance with national and local electrical codes.

---

### Filling Out the Equipment Setup Worksheet

An Equipment Setup Worksheet is provided in this online help. See **Equipment Setup Worksheet** (on page 496). Use this worksheet to record the model, serial number, and use of each IT device connected to the PDU.

As you add and remove devices, keep the worksheet up-to-date.

---

## Installing Cable Retention Clips on the Inlet (Optional)

If your PX device is designed to use a cable retention clip, install the clip before connecting a power cord. A cable retention clip prevents the connected power cord from coming loose or falling off.

The use of cable retention clips is highly recommended for regions with high seismic activities, and environments where shocks and vibrations are expected.



► **To install and use a cable retention clip on the inlet:**

1. Locate two tiny holes adjacent to the inlet.
2. Install the cable retention clip by inserting two ends of the clip into the tiny holes.



Zero U models

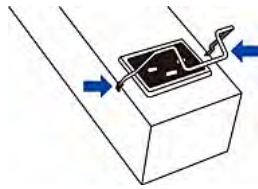

1U/2U models

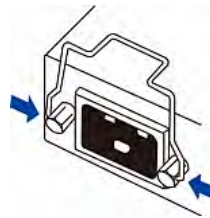

3. Connect the power cord to the inlet, and press the clip toward the power cord until it holds the cord firmly.

Zero U models

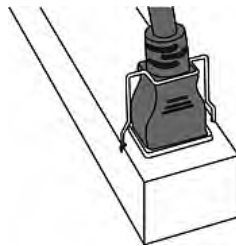

1U/2U models

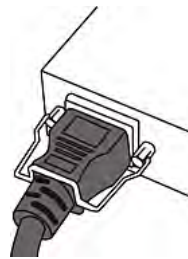

---

## Connecting the PDU to a Power Source

1. Verify that all circuit breakers on the PX device are set to ON. If not, turn them ON.

Or make sure that all fuses are inserted and seated properly. If there are any fuse covers, ensure that they are closed.

---

*Note: Not all PX devices have overcurrent protection mechanisms.*

---

2. Connect each PX to an appropriately rated branch circuit. See the label or nameplate affixed to your PX for appropriate input ratings or range of ratings.

---

*Note: When a PX device powers up, it proceeds with the power-on self test and software loading for a few moments. At this time, the outlet LEDs cycle through different colors. Note that outlet LEDs are only available on some PDU models.*

---

3. When the software has completed loading, the outlet LEDs show a steady color and the front panel display illuminates.

---

## Configuring the PX

There are two ways to initially configure a PX device:

- Connect the PX device to a computer to configure it, using a serial RS-232 or USB connection between the PX and the computer.

The computer must have a communications program such as HyperTerminal or PuTTY.

For an RS-232 connection, you need a null-modem cable with DB9 connectors on both ends (Raritan part number: 254-01-0006-00).

- Connect the PX device to a TCP/IP network that supports DHCP, and use the IPv4 address and web browser to configure the PX.

The DHCP-assigned IP address can be retrieved through the PX device's MAC address. You can contact your LAN administrator for assistance. See **MAC Address** (on page 584).

A Category 5e/6 UTP cable is required for a wired network connection.

---

*Tip: An additional way to initially configure multiple PX devices is to use the TFTP server over a DHCP network. This method helps you save a lot of time when there are a large number of PX devices to configure. For details, see **Bulk Configuration or Firmware Upgrade via DHCP/TFTP** (on page 500).*

---

---

### Connecting the PX to a Computer

To configure the PX using a computer, it must be connected to the computer with an RS-232 serial interface.

#### Zero U models:



If your computer does not have a serial RS-232 port, use a regular USB cable to connect the PX to the computer for initial configuration. The PX device can emulate a serial port after the USB-to-serial driver is properly installed in the Windows® operating system.

---

*Note: Not all serial-to-USB converters work properly with the PX device so this section does not introduce the use of such converters.*

---

Connect the PX to a computer for initial configuration by following either of the procedures below.

► **To make a serial RS-232 connection:**

- Connect one end of the null-modem cable to the male RS-232 port labeled CONSOLE / MODEM on the PX, and the other end to the serial port (COM) on a computer.

► **To make a USB connection:**

1. A USB-to-serial driver is required in Windows®. Install this driver before connecting the USB cable. See ***Installing the USB-to-Serial Driver (Optional)*** (on page 16).
- Connect a USB cable between the PX appliance's USB-B port and the computer's USB-A port.

---

*Note: If you plan to use this cable connection to log in to the command line interface, leave the cable connected after the configuration is complete.*

---

---

### Installing the USB-to-Serial Driver (Optional)

The PX can emulate a USB-to-serial converter over a USB connection. A USB-to-serial driver named "Dominion PX Serial Console" is required for Microsoft® Windows® operating systems.

Download the USB Driver file, which contains the `dominion-serial.inf`, `dominion-serial.cat` and `dominion-serial-setup-<n>.exe` files.

---

*Note: <n> in the filename of "dominion-serial-setup-<n>.exe" represents the file's version number.*

---

There are two ways to install this driver: automatic and manual installation. Automatic driver installation is highly recommended.

Note: This file is downloaded from the Raritan **PX2 Support Files page** (<https://www.raritan.com/support/product/px2/px2-support-files>).

▶ **Automatic driver installation in Windows®:**

1. Make sure the PX is NOT connected to the computer via a USB cable.
2. Run `dominion-serial-setup-<n>.exe` on the computer and follow online instructions to install the driver.

---

*Note: If any Windows security warning appears, accept it to continue the installation.*

---

3. Connect the PX to the computer via a USB cable. The driver is automatically installed.

▶ **Manual driver installation in Windows®:**

1. Make sure the PX has been connected to the computer via a USB cable.
2. The computer detects the new device and the "Found New Hardware Wizard" dialog appears. If this dialog does not appear, choose Control Panel > System > Hardware > Device Manager, right-click the *Serial Console*, and choose Update Driver.
3. Select the option of driver installation from a specific location, and then specify the location where both `dominion-serial.inf` and `dominion-serial.cat` are stored.

---

*Note: If any Windows security warning appears, accept it to continue the installation.*

---

4. Wait until the installation is complete.

---

*Note: If the PX enters the disaster recovery mode when the USB serial driver is not installed yet, it may be shown as a 'GPS camera' in the Device Manager on the computer connected to it.*

---

► **In Linux:**

No additional drivers are required, but you must provide the name of the tty device, which can be found in the output of the "dmesg" after connecting the PX to the computer. Usually the tty device is "/dev/ttyACM#" or "/dev/ttyUSB#," where # is an integer number.

For example, if you are using the kermit terminal program, and the tty device is "/dev/ttyACM0," perform the following commands:

```
> set line /dev/ttyACM0  
> Connect
```

---

**Connecting the PX to Your Network**

To use the web interface to administer the PX, you must connect the PX to your local area network (LAN). The PX can be connected to a wired or wireless network.

---

*Note: If your PDU will be used as a master device in the USB-cascading configuration where the bridging mode applies, make a wired connection. See **Cascading the PX via USB** (on page 25).*

---

► **To make a wired connection:**

1. Connect a standard network patch cable to the ETHERNET port on the PX.
2. Connect the other end of the cable to your LAN.

Below indicates the ETHERNET port on PX2 Zero U models:

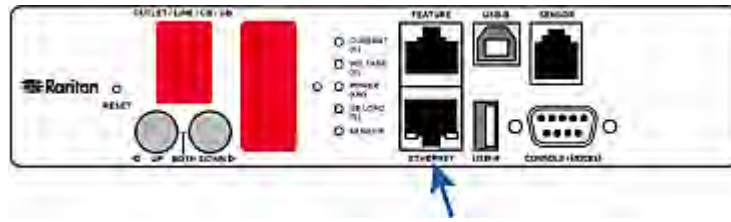

For 1U/2U models, the ETHERNET port is usually located on the back except for a few models. This diagram shows the port on the back.



Warning: Accidentally plugging an RS-232 RJ-45 connector into the ETHERNET port can cause permanent damages to the Ethernet hardware.

► **To make a wireless connection:**

Do one of the following:

- Plug a supported USB wireless LAN adapter into the USB-A port on your PX.
- Connect a USB docking station to the USB-A port on the PX and plug the supported USB wireless LAN adapter into the appropriate USB port on the docking station.

See **USB Wireless LAN Adapters** (on page 18) for a list of supported wireless LAN adapters.

**USB Wireless LAN Adapters**

The following table lists USB wireless LAN adapters that the PX supports.

Wi-Fi LAN adapter	Supported 802.11 protocols
Proxim Orinoco 8494	A/B/G
Zyxel NWD271N	B/G
Edimax EW-7722UnD	A/B/G/N
TP-Link TL-WDN3200 v1	A/B/G/N
Raritan USB WIFI	A/B/G/N

---

*Note: To use the Edimax EW-7722UnD or Raritan USB WIFI wireless LAN adapter to connect to an 802.11n wireless network, the handshake timeout setting must be changed to 500 or greater, or the wireless connection will fail.*

---

### Supported Wireless LAN Configuration

If wireless networking is preferred, ensure that the wireless LAN configuration of your PX matches the access point. The following is the wireless LAN configuration that the PX supports.

- Network type: 802.11 A/B/G/N
- Protocol: WPA2 (RSN)
- Key management: WPA-PSK, or WPA-EAP with PEAP and MSCHAPv2 authentication
- Encryption: CCMP (AES)

---

**Important: Raritan only supports specific wireless LAN adapters. Supported 802.11 network protocols vary according to the wireless LAN adapter being used with the PX. See *USB Wireless LAN Adapters* (on page 18).**

---

### Initial Network Configuration via CLI

After the PX is connected to your network, you must provide it with an IP address and some additional networking information.

This section describes the initial configuration via a serial RS-232 or USB connection.

#### ► To configure the PX device:

1. On the computer connected to the PX, open a communications program such as HyperTerminal or PuTTY.
2. Select the appropriate COM port, and set the following port settings:
  - Bits per second = 115200 (115.2Kbps)
  - Data bits = 8
  - Stop bits = 1
  - Parity = None
  - Flow control = None

---

*Tip: For a USB connection, you can determine the COM port by choosing Control Panel > System > Hardware > Device Manager, and locating the "Dominion PX2 Serial Console" under the Ports group.*

---

3. In the communications program, press Enter to send a carriage return to the PX.
4. The PX prompts you to log in. Both user name and password are case sensitive.
  - a. Username: `admin`
  - b. Password: `raritan` (or a new password if you have changed it).
5. If prompted to change the default password, follow onscreen instructions to type your new password.
6. The # prompt appears.
7. Type `config` and press Enter.
8. To configure network settings, type appropriate commands and press Enter. All commands are case sensitive.
  - a. To set the networking mode, type this command:  
`network mode <mode>`  
 where `<mode>` is *wired* (default) or *wireless*.
  - b. For the wired network mode, you may configure the LAN interface settings. In most scenarios, the default setting (`auto`) works well and should not be changed unless required.

To set	Use this command
LAN interface speed	<code>network interface LANInterfaceSpeed &lt;option&gt;</code> <code>&lt;option&gt; = auto, 10Mbps, or 100Mbps.</code>
LAN interface duplex mode	<code>network interface LANInterfaceDuplexMode &lt;mode&gt;</code> <code>&lt;mode&gt; = half, full or auto.</code>

---

*Tip: You can combine multiple commands to configure multiple parameters at a time. For example,*  
`network interface LANInterfaceSpeed <option>`  
`LANInterfaceDuplexMode <mode>`

---

- c. For the wireless network mode, you must configure the Service Set Identifier (SSID) parameter.

To set	Use this command
SSID	<code>network wireless SSID &lt;ssid&gt;</code> <code>&lt;ssid&gt; = SSID string</code>



If necessary, configure more wireless parameters shown in the following table.

To set	Use this command
BSSID	network wireless BSSID <bssid> <bssid> = AP MAC address or <i>none</i>
Authentication method	network wireless authMethod <method> <method> = <i>psk</i> or <i>eap</i>
PSK	network wireless PSK <psk> <psk> = PSK string
EAP outer authentication	network wireless eapOuterAuthentication <outer_auth> <outer_auth> = <i>PEAP</i>
EAP inner authentication	network wireless eapInnerAuthentication <inner_auth> <inner_auth> = <i>MSCHAPv2</i>
EAP identity	network wireless eapIdentity <identity> <identity> = your user name for EAP authentication
EAP password	network wireless eapPassword When prompted to enter the password for EAP authentication, type the password.
EAP CA certificate	network wireless eapCACertificate When prompted to enter the CA certificate, open the certificate with a text editor, copy and paste the content into the communications program.

The content to be copied from the CA certificate does NOT include the first line containing "BEGIN CERTIFICATE" and the final line containing "END CERTIFICATE." If a certificate is installed, configure the following:

Whether to	Use this command
Verify the certificate	<pre>network wireless enableCertVerification &lt;option1&gt;</pre> <p>&lt;option1&gt; = <i>true</i> or <i>false</i></p>
Accept an expired or not valid certificate	<pre>network wireless allowOffTimeRangeCerts &lt;option2&gt;</pre> <p>&lt;option2&gt; = <i>true</i> or <i>false</i></p>
Make the connection successful by ignoring the "incorrect" system time	<pre>network wireless allowConnectionWithIncorrectC lock &lt;option3&gt;</pre> <p>&lt;option3&gt; = <i>true</i> or <i>false</i></p>

- d. To determine which IP protocol (IPv4 or IPv6) is enabled and which IP address (IPv4 or IPv6) returned by the DNS server is used, configure the following parameters.

To set	Use this command
IP protocol	<pre>network ip proto &lt;protocol&gt;</pre> <p>&lt;protocol&gt; = <i>v4Only</i>, <i>v6Only</i> or <i>both</i></p>
IP address returned by the DNS server	<pre>network ip dnsResolverPreference &lt;resolver&gt;</pre> <p>&lt;resolver&gt; = <i>preferV4</i> or <i>preferV6</i></p>

- e. After enabling the IPv4 or IPv6 protocol in the earlier step, configure the IPv4 or IPv6 network parameters.

To set	Use this command
IPv4 configuration method	<pre>network ipv4 ipConfigurationMode &lt;mode&gt;</pre> <p>&lt;mode&gt; = <i>dhcp</i> (default) or <i>static</i></p>

To set	Use this command
IPv6 configuration method	network ipv6 ipConfigurationMode <mode>  <mode> = <i>automatic</i> (default) or <i>static</i>

- Configure the preferred host name for the IPv4 DHCP or IPv6 automatic configuration.

---

*Note: The <version> variable in all of the following commands is either ipv4 or ipv6, depending on the type of the IP protocol you have enabled.*

---

To set	Use this command
Preferred host name (optional)	network <version> preferredHostName <name>  <name> = preferred host name

---

*Tip: To override the DHCP-assigned DNS servers with those you specify manually, type this command:*

*network <version> overrideDNS <option>*

*where <option> is enable or disable. See the table below for the commands for manually specifying DNS servers.*

---

- For static IP configuration, configure these parameters.

To set	Use this command
Static IPv4 or IPv6 address	network <version> ipAddress <ip address>  <ip address> = static IP address
IPv4 subnet mask	network ipv4 subnetMask <netmask>  <netmask> = subnet mask
IPv4 or IPv6 gateway	network <version> gateway <ip address>  <ip address> = gateway's IP address

To set	Use this command
IPv4 or IPv6 primary DNS server	<pre>network &lt;version&gt; primaryDNSServer &lt;ip address&gt;</pre> <p>&lt;ip address&gt; = IP address of the primary DNS server</p>
IPv4 or IPv6 secondary DNS server (optional)	<pre>network &lt;version&gt; secondaryDNSServer &lt;ip address&gt;</pre> <p>&lt;ip address&gt; = IP address of the secondary DNS server</p>

- To quit the configuration mode, type either of the following commands, and press Enter.

Command	Description
<code>apply</code>	Save all configuration changes and exit.
<code>cancel</code>	Abort all configuration changes and exit.

The # prompt appears, indicating that you have quit the configuration mode.

- To verify whether all settings are correct, type the following commands one by one.

Command	Description
<code>show network</code>	Show network parameters.
<code>show network ip all</code>	Show all IP configuration parameters.
<code>show network wireless details</code>	Show all wireless parameters.

---

*Tip: You can type "show network wireless" to display a shortened version of wireless settings.*

---

- If all are correct, type `exit` to log out of the PX. If any are incorrect, repeat Steps 7 to 10 to change network settings.

The IP address configured may take seconds to take effect.

---

## Cascading the PX via USB

Up to eight (8) Raritan devices are supported as part of a daisy chain. This daisy chain feature permits multiple PX devices to be cascaded using USB cables, sharing the Ethernet connectivity accordingly. Different models can be cascaded as long as they are running a supported firmware.

The first device in the chain is the master device and all the other are slave devices. All devices in the chain are accessible over the network, with the bridging or port forwarding cascading mode activated on the master device. See **Setting the Cascading Mode** (on page 119).

Only the master device is connected to the LAN. The LAN connection method varies based on the cascading mode.

- The bridging mode supports the *wired* networking only.
- The port forwarding mode supports both the *wired* and *wireless* networking.

For more information on the USB-cascading configuration, see the *USB-Cascading Solution Guide*, which is available from Raritan website's **PX2 Support Files page** (<https://www.raritan.com/support/product/px2/px2-support-files>).

### ► To cascade the PX devices via USB:

1. Verify that the PDUs to be cascaded are running the following firmware versions by choosing Maintenance > Device Information in the web interface or using the "show pdu" command in the command line interface. If not, upgrade these devices. See **Updating the PX Firmware** (on page 300).
  - PX2 series: version 2.3.1 or later
  - PX3 series: version 2.5.10 or later

---

*Note: Port forwarding mode over wireless LAN is supported as of release 3.1.0. You must upgrade all devices in the chain to version 3.1.0 or later if wireless networking is preferred.*

---

2. Select one of the devices as the master device.
  - When the port forwarding mode over wireless LAN is intended, a Raritan product with two USB-A ports must be the master device, such as PX3 or PX3TS.
3. Connect the master device to the LAN via:
  - A standard network patch cable (CAT5e or higher) if the bridging mode is intended.
  - A standard network patch cable or a Raritan USB WIFI wireless LAN adapter if the port forwarding mode is intended.

For information on the Raritan USB WIFI adapter, see **USB Wireless LAN Adapters** (on page 18).

4. Connect the USB-A port of the master device to the USB-B port of an additional PX via a USB cable. This additional device is Slave 1.
5. Connect Slave 1's USB-A port to the USB-B port of an additional PX via a USB cable. The second additional device is Slave 2.
6. Repeat the above step to connect more slave devices. You may connect up to 7 slave devices.

Do not connect any slave device to the LAN, that is, no connection of any standard network patch cable or USB wireless LAN adapter to the slave devices.

7. Log in to the master device to configure the cascading mode for this USB-cascading configuration. See **Setting the Cascading Mode** (on page 119) or **Configuring the Cascading Mode** (on page 456).
8. Configure the master and/or each slave device's networking settings.
  - Bridging mode: Configure each cascaded device's network settings respectively.
  - Port forwarding mode: Only the mater device's network settings must be configured.

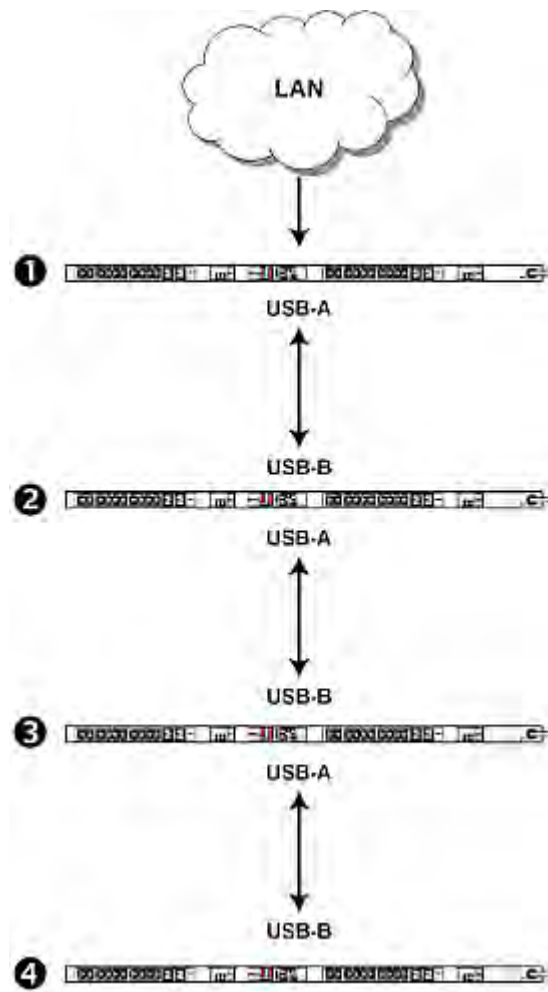

Number	Device role
①	Master device
②	Slave 1
③	Slave 2
④	Slave 3

*Note: To remotely identify the master and slave devices and their positions in the USB-cascading configuration, see **Identifying Cascaded Devices** (on page 91).*

---

*Tip: The USB-cascading configuration can be a combination of diverse Raritan products that support the USB-cascading feature, including PX2, PX3, PX3TS, EMX and BCM. For details, see the USB-Cascading Solution Guide, which is available on the **PX2 web page** (<http://www.raritan.com/support/product/px2/>).*

---

## Installing Cable Retention Clips on Outlets (Optional)

If your PX device is designed to use a cable retention clip, install the clip before connecting a power cord. A cable retention clip prevents the connected power cord from coming loose or falling off.

The use of cable retention clips is highly recommended for regions with high seismic activities, and environments where shocks and vibrations are expected.

These optional clips come in various sizes to accommodate diverse power cords used on IT equipment, which are connected to C13 or C19 outlets. You can request a cable retention kit containing different sizes of clips from your reseller. Make sure you use a clip that fits the power cord snugly to facilitate the installation or removal operation (for servicing).



---

*Note: Some NEMA sockets on PSE-certified PDUs for Japan have integral locking capability and do not need cable retention clips. See **Locking Outlets and Cords** (on page 584).*

---

### ► To install and use a cable retention clip on the outlet:

1. Locate two tiny holes at two sides of an outlet.
2. Install the cable retention clip by inserting two ends of the clip into the tiny holes.

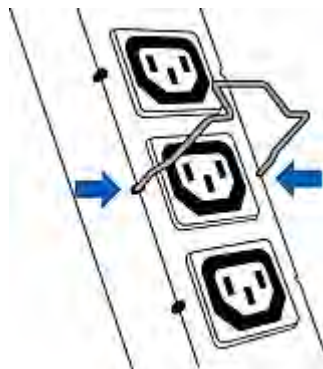



3. Plug the power cord into the outlet, and press the clip toward the power cord until it holds the cord firmly. The clip's central part holding the plug should face downwards toward the ground, like an inverted "U". This allows gravity to keep the clip in place.



4. Repeat the same steps to install clips and power cords on the other outlets.

# Chapter 4 Connecting External Equipment (Optional)

More features are available in addition to remotely monitoring and managing the PX if you connect Raritan's or third-party external equipment to your PX.

## In This Chapter

Connecting Environmental Sensor Packages .....	30
Connecting the Asset Management Sensor .....	40
Connecting a Logitech Webcam .....	52
Connecting a GSM Modem .....	53
Connecting an Analog Modem .....	53
Connecting an External Beeper .....	54
Connecting a Schroff LHX/SHX Heat Exchanger .....	54

---

## Connecting Environmental Sensor Packages

The PX supports all types of Raritan environmental sensor packages, including DPX, DPX2 and DX series. For detailed information on each sensor package, refer to the Environmental Sensors Guide or Online Help on Raritan website's **PX2 Support Files page** (<https://www.raritan.com/support/product/px2/px2-support-files>).

The PX supports a maximum of 32 managed sensors or actuators.

For information on connecting DPX packages, see **DPX Sensor Packages** (on page 30).

For information on connecting DPX2 packages, see **DPX2 Sensor Packages** (on page 35).

For information on connecting DX packages, see **DX Sensor Packages** (on page 37).

---

### DPX Sensor Packages

Most DPX sensor packages come with a factory-installed sensor cable, whose sensor connector is RJ-12.

The supported maximum distance is 98 feet (30 m). See **Supported Maximum DPX Sensor Distances** (on page 34) for further illustrations.

► **To connect a DPX sensor package with a factory-installed sensor cable:**

Plug the RJ-12 connector of the DPX sensor cable into the RJ-12 SENSOR port on the PX.

► **To connect a DPX differential air pressure sensor:**

1. Plug one end of a Raritan-provided phone cable into the IN port of a differential air pressure sensor.
2. Plug the other end of this phone cable into the RJ-12 SENSOR port on the PX.

---

*Note: You can cascade multiple differential air pressure sensors using Raritan-provided phone cables. For details, refer to the Environmental Sensors Guide or Online Help on Raritan website's **PX2 Support Files page** (<https://www.raritan.com/support/product/px2/px2-support-files>). When cascading air pressure sensors, remember that a SENSOR port supports a maximum of 32 sensors.*

---

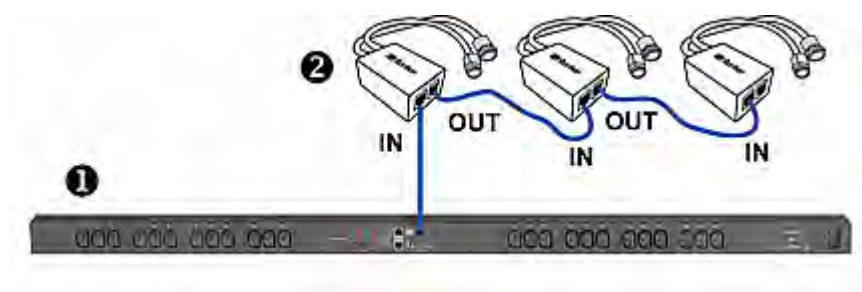

<b>1</b>	The PX device
<b>2</b>	Raritan differential air pressure sensors

**Using an Optional Sensor Hub**

A Raritan sensor hub increases the number of connected DPX environmental sensors per SENSOR port. Make sure the total number of sensors connected to a SENSOR port does not exceed 32.

This hub supports DPX sensor packages only. Do NOT connect DPX2 or DX sensor packages to the hub.

► **To connect DPX sensor packages via an optional sensor hub:**

1. Connect a Raritan sensor hub to the PX device.
  - a. Plug one end of the Raritan-provided phone cable (4-wire, 6-pin, RJ-12) into the IN port (Port 1) of the hub.
  - b. Plug the other end of the phone cable into the PDU's RJ-12 SENSOR port.
2. Connect DPX sensor packages to any of the four OUT ports on the hub.

Raritan sensor hubs CANNOT be cascaded so at most one sensor hub can be connected to each SENSOR port on the PX device. This diagram illustrates a configuration with a sensor hub connected.



①	The PX device
②	Raritan-provided phone cable
③	Raritan sensor hub
④	DPX sensor packages

### Using a Raritan Y cable

A Raritan Y cable doubles the number of connected environmental sensors per SENSOR port.

It supports DPX sensor packages only. Do NOT connect DPX2 or DX sensor packages.

► **To connect DPX sensor packages via a Raritan Y cable:**

1. Plug the connector of the Y cable directly into the PDU's RJ-12 SENSOR port.

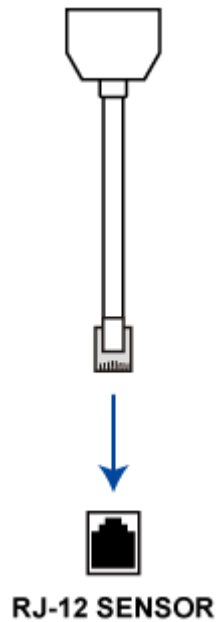

2. A Y cable has two RJ-12 sensor ports. Connect DPX sensor packages to the Y cable's sensor ports.

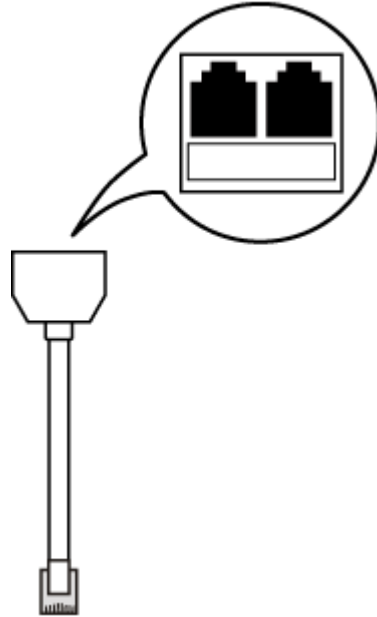

3. Repeat the above steps if there are additional SENSOR ports on your PX.

#### Supported Maximum DPX Sensor Distances

A maximum connection distance of 98' (30 m) is supported when connecting the following DPX sensor packages to the PX. This maximum includes the 16' (5 m) sensor cable length:

- DPX-CC2-TR
- DPX-T1
- DPX-T3H1
- DPX-AF1
- DPX-T1DP1

The following configurations were tested when connecting DPX sensor packages to a PX via a sensor hub:

PX → 16' (5 m) cable → 1 sensor hub → 16' (5 m) cable → Up to 4 DPX-T3H1 sensors

- PX → 50' (15 m) cable → 1 sensor hub → 16' (5 m) cable → Up to 4 DPX-T3H1 sensors
- PX → 82' (25 m) cable → 1 sensor hub → 16' (5 m) cable → Up to 4 DPX-T3H1 sensors

**DPX2 Sensor Packages**

A DPX2 sensor cable is shipped with a DPX2 sensor package. This cable is made up of one RJ-12 connector and one to three head connectors. You need to manually connect DPX2 sensors to the sensor cable.

For more information on DPX2 sensor packages, access the Environmental Sensors Guide or Online Help on Raritan website's **PX2 Support Files page** (<https://www.raritan.com/support/product/px2/px2-support-files>).

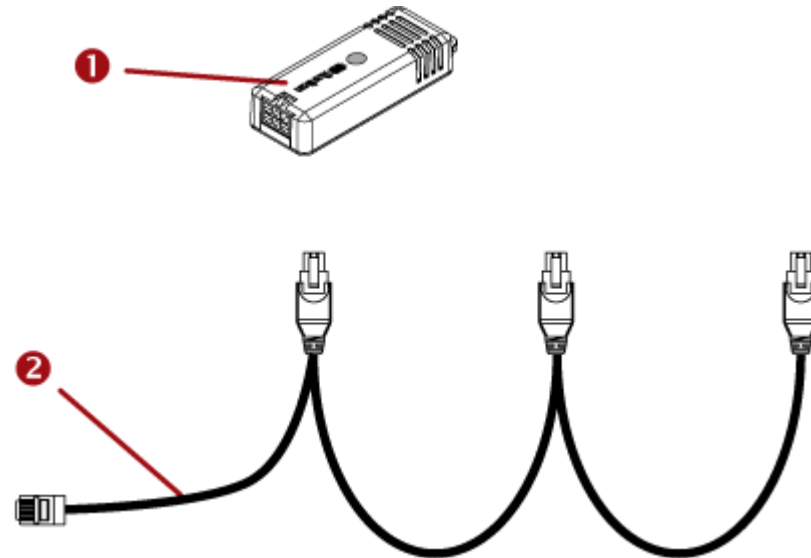

Item	
①	DPX2 sensor
②	DPX2 sensor cable with one RJ-12 connector and three head connectors

The following procedure illustrates a DPX2 sensor cable with three head connectors. Your sensor cable may have fewer head connectors.

Warning: If there are free head connectors between a DPX2 sensor cable's RJ-12 connector and the final attached DPX2 sensor, the sensors following the free head connector(s) on the same cable do NOT work properly. Therefore, always occupy all head connectors prior to the final sensor with a DPX2 sensor.

► **To connect a DPX2 sensor package to the PX:**

1. Connect a DPX2 sensor to the first head connector of the DPX2 sensor cable.

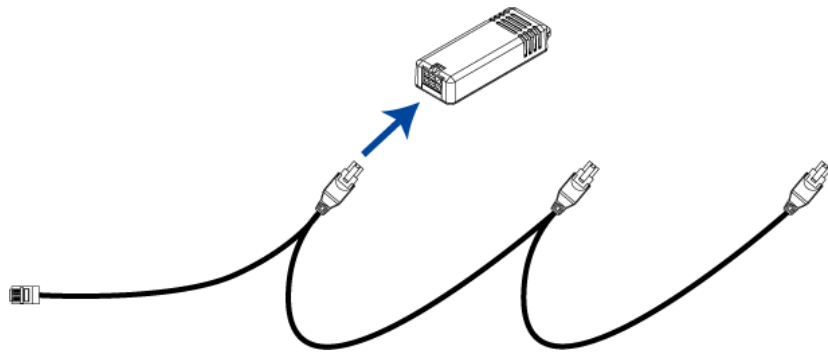

2. Connect remaining DPX2 sensors to the second and then the third head connector.

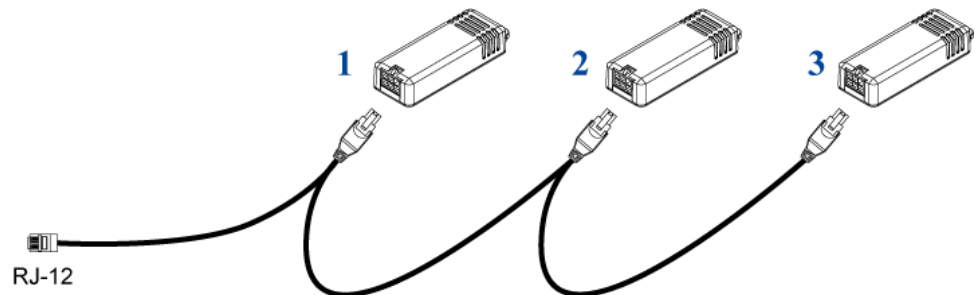

---

*Tip: If the number of sensors you are connecting is less than the number of head connectors on your sensor cable, connect them to the first one or first two head connectors to ensure that there are NO free head connectors prior to the final DPX2 sensor attached.*

---

3. Plug the RJ-12 connector of the DPX2 sensor cable into a RJ-12 SENSOR port on the PX.

---

*Note: If your PX has "two" RJ-12 SENSOR ports, see **Guidelines for PX with Two Sensor Ports** (on page 39) for sensor connection restrictions.*

---



## DX Sensor Packages

Most DX sensor packages contain terminals for connecting detectors or actuators. For information on connecting actuators or detectors to DX terminals, access the Environmental Sensors Guide or Online Help on Raritan website's **PX2 Support Files page** (<https://www.raritan.com/support/product/px2/px2-support-files>).

You can cascade up to 12 DX sensor packages.

When cascading DX, remember that the PX only supports a maximum of 32 sensors or actuators.

If there are more than 32 sensors and/or actuators connected, every sensor and/or actuator after the 32nd one is ignored by PX.

For example, if you cascade 12 DX packages, and each package contains 3 functions (a function is a sensor or actuator), PX ignores the last 4 functions because the total 36 ( $12 \times 3 = 36$ ) exceeds 32 by 4.

*Tip: To manage the last 4 functions, you can release 4 sensors or actuators that have been under management, and then manually bring the last 4 functions into management. See **Unmanaging Environmental Sensors or Actuators** (on page 269) and **Managing Environmental Sensors or Actuators** (on page 258).*

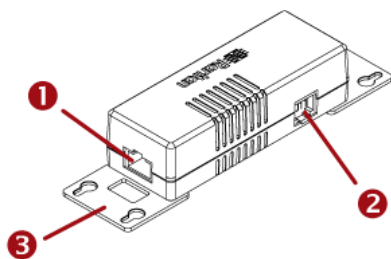

Numbers	Components
①	RJ-45 ports, each of which is located on either end of a DX sensor package.
②	RJ-12 port, which is reserved for future use and is now hidden.
③	Removable rackmount brackets.

### ► Connect DX to the PX:

1. Connect an RJ-12 to RJ-45 adapter cable which is shipped with a DX sensor package to the DX.
  - Connect the adapter's RJ-45 connector to either RJ-45 port of the DX sensor package.

2. If you want to cascade DX packages, get an additional standard network patch cable (CAT5e or higher) and then:
  - a. Plug one end of the cable into the remaining RJ-45 port on the prior DX package.
  - b. Plug the other end into either RJ-45 port on an additional DX package.

Repeat the same steps to cascade more DX packages.

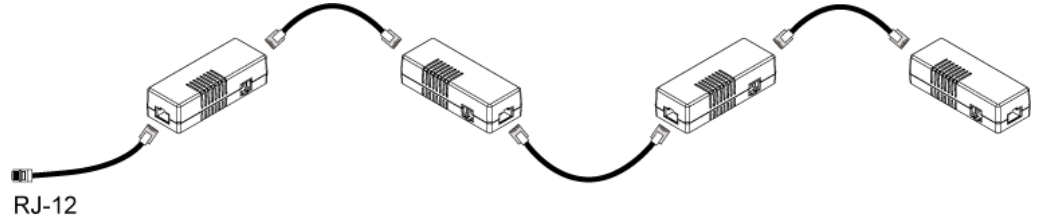

3. Connect the first DX sensor package to the PX.
  - Plug the adapter cable's RJ-12 connector into the RJ-12 SENSOR port of the PDU.
4. If needed, connect a DPX2 sensor package to the end of the DX chain. See **Connecting a DPX2 Sensor Package to DX** (on page 38).

---

*Note: If your PX has "two" RJ-12 SENSOR ports, see **Guidelines for PX with Two Sensor Ports** (on page 39) for sensor connection restrictions.*

---

### Connecting a DPX2 Sensor Package to DX

You can connect only one DPX2 sensor package to the "end" of a DX sensor chain. Simply plug the RJ-12 connector of the DPX2 sensor cable into the RJ-45 port of the final DX in the chain.

The maximum number of DX sensor packages in the chain must be less than 12 when a DPX2 sensor package is involved.

► **When connecting a DPX2 sensor package containing three DPX2 sensors:**

A maximum of nine (9) DX sensor packages can be cascaded because  $12-3=9$ .

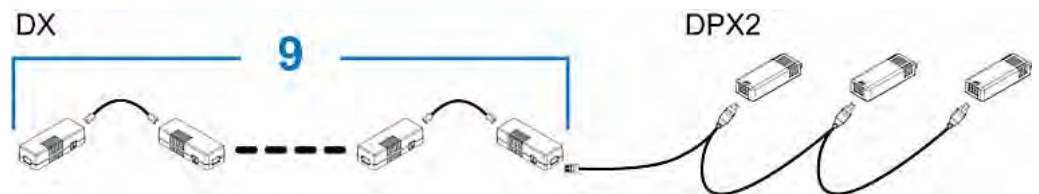

▶ **When connecting a DPX2 sensor package containing two DPX2 sensors:**

A maximum of ten (10) DX sensor packages can be cascaded because  $12-2=10$ .

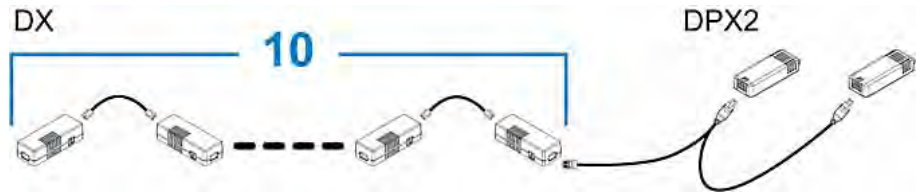

▶ **When connecting a DPX2 sensor package containing one DPX2 sensor:**

A maximum of eleven (11) DX sensor packages can be cascaded because  $12-1=11$ .

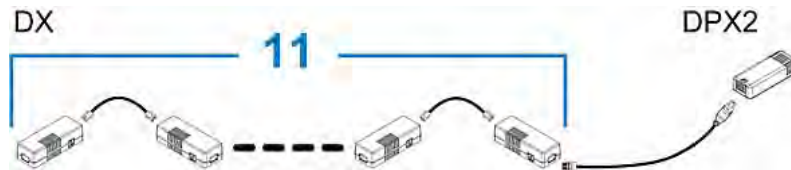

**Guidelines for PX with Two Sensor Ports**

Depending on the sensor type, the sensor connection guidelines for PX models with "two" SENSOR ports vary.

▶ **Connection of DPX sensor packages:**

- You can connect DPX sensor packages to either or both SENSOR ports.

▶ **Connection of DPX2 or DX sensor packages:**

- Connect the DPX2 sensor package to only one of the SENSOR ports. DO NOT connect them to both SENSOR ports.
- Connect the DX sensor package(s) to only one of the SENSOR ports. DO NOT connect them to both SENSOR ports.
- DO NOT connect a DPX2 sensor package to one SENSOR port and DX sensor package(s) to the other port.

---

## Connecting the Asset Management Sensor

You can remotely track the locations of up to 64 IT devices in the rack by connecting an asset management sensor (asset sensor) to the PX after IT devices are tagged electronically.

To use the asset management feature, you need the following items:

- Raritan asset sensors: An asset sensor transmits the asset management tag's ID and positioning information to the PX.
- Raritan asset tags: An asset tag is adhered to an IT device. The asset tag uses an electronic ID to identify and locate the device.

---

### Combining Asset Sensors

Each tag port on the asset sensor corresponds to a rack unit and can be used to locate IT devices on a specific rack (or cabinet).

For each rack, you can attach asset sensors up to 64U long, consisting of one MASTER and multiple SLAVE asset sensors.

The difference between the master and slave asset sensors is that the master asset sensor has an RJ-45 connector while the slave does not.

The following diagram illustrates some asset sensors. Note that Raritan provides more types of asset sensors than the diagram.

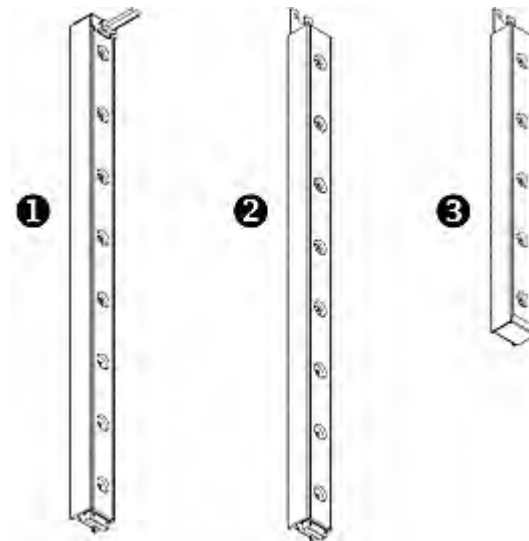

①	8U MASTER asset sensor with 8 tag ports
②	8U SLAVE asset sensor with 8 tag ports
③	5U "ending" SLAVE asset sensor with 5 tag ports

---

*Note: Unlike regular slave asset sensors, which have one DIN connector respectively on either end, the ending slave asset sensor has one DIN connector on only one end. An ending asset sensor is installed at the end of the asset sensor assembly.*

---

► **To assemble asset sensors:**

1. Connect a MASTER asset sensor to an 8U SLAVE asset sensor.
  - Plug the white male DIN connector of the slave asset sensor into the white female DIN connector of the master asset sensor.
  - Make sure that the U-shaped sheet metal adjacent to the male DIN connector is inserted into the rear slot of the master asset sensor. Screw up the U-shaped sheet metal to reinforce the connection.

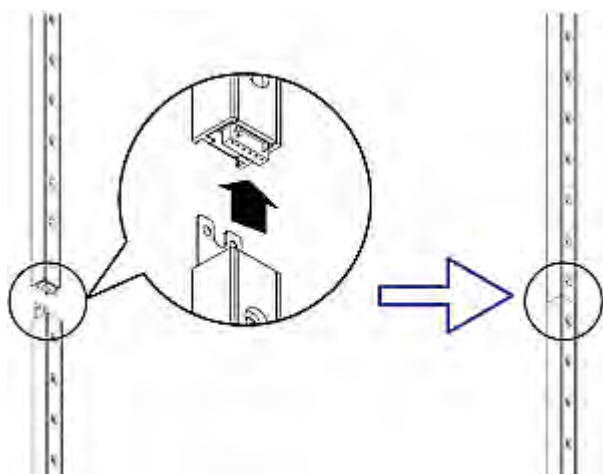

2. Connect another 8U slave asset sensor to the one being attached to the master asset sensor in the same manner as Step 1.
3. Repeat the above step to connect more slave asset sensors. The length of the asset sensor assembly can be up to 64U.
  - The final asset sensor can be 8U or 5U, depending on the actual height of your rack.
  - Connect the "ending" asset sensor as the final one in the assembly.
4. Vertically attach the asset sensor assembly to the rack, next to the IT equipment, making each tag port horizontally align with a rack unit. The asset sensors are automatically attracted to the rack because of magnetic stripes on the back.

---

*Note: The asset sensor is implemented with a tilt sensor so it can be mounted upside down.*

---

### Connecting Asset Sensors to the PX

You need both asset sensors and asset tags for tracking IT devices.

Asset tags provide an ID number for each IT device. The asset tags are adhered to an IT device at one end and plugged in to an asset management sensor at the other.

The asset sensor is connected to a PX, and the asset tag transmits the ID and positioning information to the asset sensor.

The following diagram illustrates an asset tag.

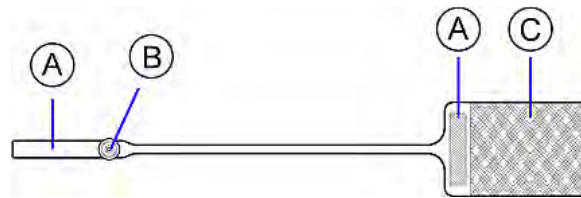

A	Barcode (ID number), which is available on either end of the asset tag
B	Tag connector
C	Adhesive area with the tape

*Note: The barcode of each asset tag is unique and is displayed in the PX device's web interface so it can easily be identified.*

#### ► To connect asset sensors to the PX device:

1. Affix the adhesive end of an asset tag to each IT device through the tag's tape.
2. Plug the connector on the other end of each asset tag into the corresponding tag port on the asset sensor.
3. Connect the asset sensor assembly on the rack to the PX device, using a standard network patch cable (CAT5e/6).
  - a. Connect one end of the cable to the RJ-45 connector on the MASTER asset sensor.
  - b. Connect the other end of the cable to the FEATURE port on the PX device.

The PX device supplies power to the asset sensor assembly through the network cable. All LEDs on the asset sensor assembly may cycle through different colors during the power-on process if the asset sensor's firmware is being upgraded by the PX device. After the power-on or firmware upgrade process completes, the LEDs show solid colors. Note that the LED color of the tag ports with asset tags connected will be different from the LED color of the tag ports without asset tags connected.

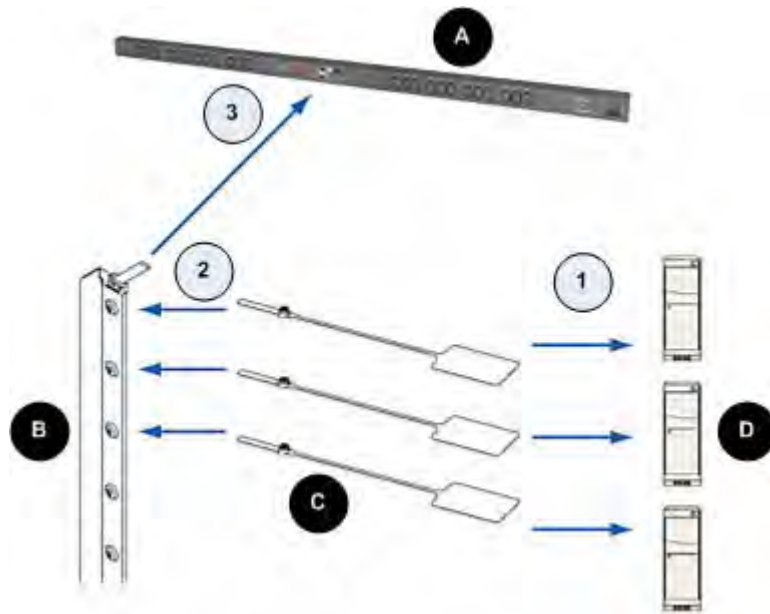

Letter	Item
A	The PX device
B	Asset sensors
C	Asset tags
D	IT devices, such as servers

*Note: The PX cannot detect how many rack units the connected asset sensor(s) has. You must provide the information to it manually. See **Configuring the Asset Sensor in PX2** (see "**Configuring the Asset Sensor**" on page 271).*

### Connecting Blade Extension Strips

For blade servers, which are contained in a single chassis, you can use a blade extension strip to track individual blade servers.

Raritan's blade extension strip functions similar to a Raritan asset sensor but requires a tag connector cable for connecting to a tag port on the regular or composite asset sensor. The blade extension strip contains 4 to 16 tag ports, depending on which model you purchased.

The following diagrams illustrate a tag connector cable and a blade extension strip with 16 tag ports.

#### Tag connector cable

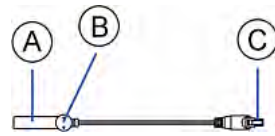

A	Barcode (ID number) for the tag connector cable
B	Tag connector
C	Cable connector for connecting the blade extension strip

*Note: A tag connector cable has a unique barcode, which is displayed in the PX device's web interface for identifying each blade extension strip where it is connected.*

#### Blade extension strip

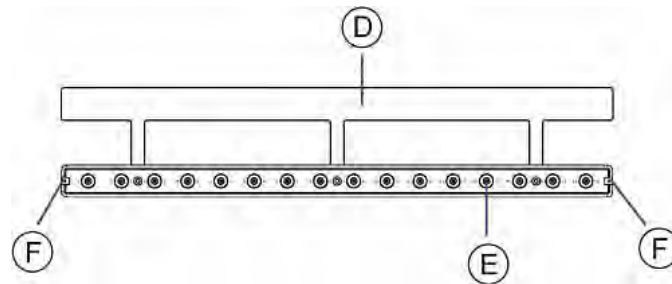

D	Mylar section with the adhesive tape
---	--------------------------------------



E	Tag ports
F	Cable socket(s) for connecting the tag connector cable

*Note: Each tag port on the blade extension strip is labeled a number, which is displayed as the slot number in the PX device's web interface.*

► **To install a blade extension strip:**

1. Connect the tag connector cable to the blade extension strip.
  - Plug the cable's connector into the socket at either end of the blade extension strip.

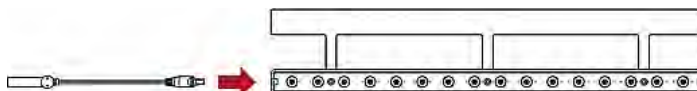

2. Move the blade extension strip toward the bottom of the blade chassis until its mylar section is fully under the chassis, and verify that the blade extension strip does not fall off easily. If necessary, you may use the adhesive tape in the back of the mylar section to help fix the strip in place.

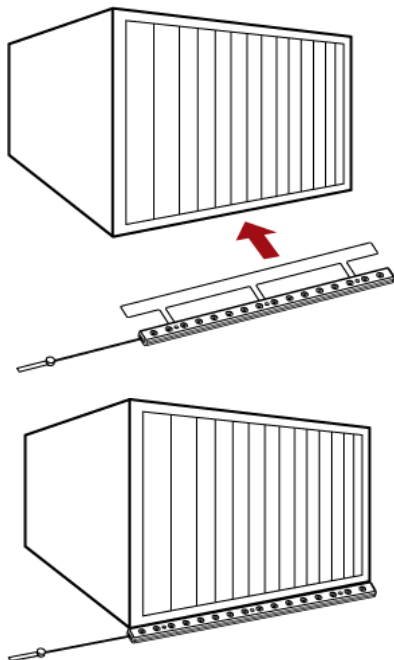

3. Connect one end of an asset tag to a blade server and connect the other end to the blade extension strip.

- a. Affix the adhesive part of the asset tag to one side of a blade server through the tag's tape.
- b. Plug the tag connector of the asset tag into the tag port on the blade extension strip.

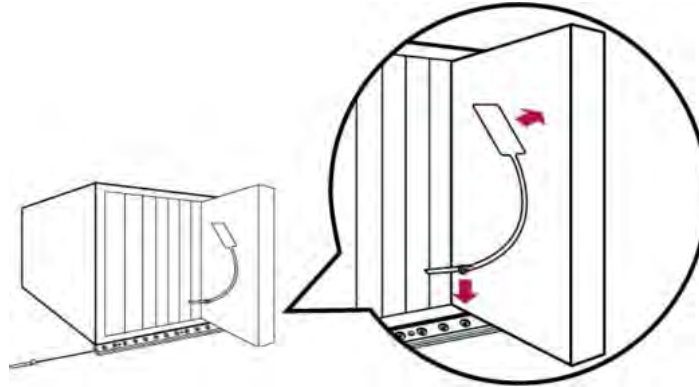

4. Repeat the above step until all blade servers in the chassis are connected to the blade extension strip via asset tags.
5. Plug the tag connector of the blade extension strip into the closest tag port of the regular or composite asset sensor on the rack.

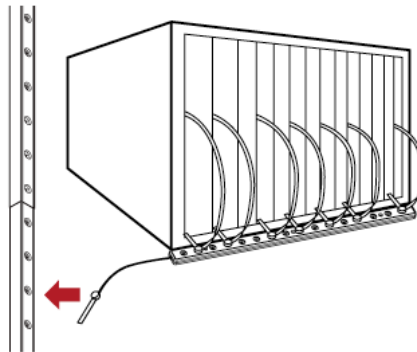

6. Repeat the above steps to connect additional blade extension strips and asset tags. Up to 128 asset tags on blade extension strips are supported per FEATURE port.

---

*Note: If you need to temporarily disconnect the blade extension strip from the asset sensor, wait at least 1 second before re-connecting it back, or the PX device may not detect it.*

---

### Connecting Composite Asset Sensors (AMS-Mx-Z)

A composite asset sensor is named AMS-Mx-Z, where x is a number, such as AMS-M2-Z or AMS-M3-Z. It is a type of asset sensor that functions the same as regular MASTER asset sensors except for the following differences:

- It has two RJ-45 connectors.
- Multiple composite asset sensors can be daisy chained.
- A composite asset sensor contains less tag ports than regular asset sensors.

For example, AMS-M2-Z contains two tag ports and AMS-M3-Z contains three tag ports only.

The composite asset sensor is especially useful for tracking large devices such as SAN boxes in the cabinet.

The following diagram illustrates AMS-M3-Z.

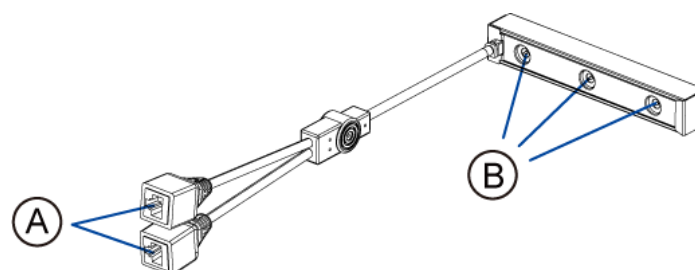

A	Two RJ-45 connectors
B	Tag ports

► **To connect composite asset sensors to the PX device:**

1. Connect a composite asset sensor to the PX device via a standard network patch cable (CAT5e or higher).
  - a. Connect one end of the cable to the RJ-45 port labeled "Input" on the composite asset sensor.
  - b. Connect the other end of the cable to the FEATURE port on the PX device.
2. Affix an asset tag to the IT device. Then connect this asset tag to the composite asset sensor by plugging the tag connector into the tag port on the composite asset sensor. See **Connecting Asset Sensors to the PX** (on page 42) for details.

3. If necessary, daisy chain *the same* type of composite asset sensors to track more IT devices.
  - a. Get a standard network patch cable that is within 2 meters.
  - b. Connect one end of the network cable to the RJ-45 connector labeled "Output" on the previous composite asset sensor.
  - c. Connect the other end of the cable to the RJ-45 connector labeled "Input" on the subsequent composite asset sensor.
  - d. Repeat the above steps to connect more composite asset sensors. See **Daisy-Chain Limitations of Composite Asset Sensors** (on page 48) for the maximum number of composite asset sensors supported per chain.
  - e. It is highly recommended using the cable ties to help hold the weight of all connecting cables.

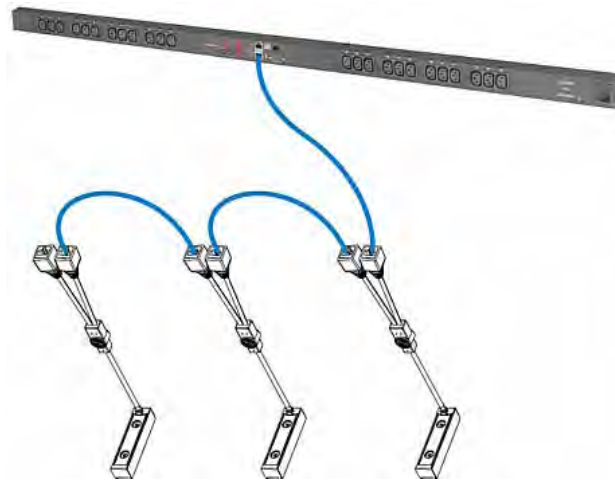

4. Repeat Step 2 to connect IT devices to the other composite asset sensors in the chain.

---

**Important: Do NOT mix AMS-M2-Z and AMS-M3-Z in a chain.**

---

#### Daisy-Chain Limitations of Composite Asset Sensors

There are some limitations when daisy chaining composite asset sensors -- AMS-Mx-Z, where x is a number.

- The maximum cable length between composite asset sensors is 2 meters.
- The maximum number of composite asset sensors that can be daisy chained vary according to the Raritan device.

Raritan devices	Maximum sensors per chain
EMX2-111,	Up to 4 composite asset sensors

Raritan devices	Maximum sensors per chain
PX2 PDUs BCM	are supported.
EMX2-888, PX3 PDUs, PX3TS transfer switches	Up to 6 composite asset sensors are supported.

*Tip: To increase the maximum number of composite asset sensors attached to a Raritan PX2 PDU or EMX2-111, you can use Raritan's X adapter cable to strengthen the asset sensor signals in the chain. See **Using an X Cable** (on page 49).*

Important: Do NOT mix different types of composite asset sensors in a chain. For example, all in the chain are AMS-M2-Z or all are AMS-M3-Z.

### Using an X Cable

Raritan's PX2 products support a maximum of four composite asset sensors in a chain. For details, see **Daisy-Chain Limitations of Composite Asset Sensors** (on page 48).

If you need to exceed the daisy-chain limitation, use Raritan's X cable to connect composite asset sensors. This allows you to expand the maximum number of composite asset sensors from four units per chain to six units per chain.

An X cable is a combination of two RJ-45 connectors, one Raritan-defined phone connector, and one RJ-12 sensor port.

The X cable supplies 12V voltage from the SENSOR port of the PX2 to the connected composite asset sensors, enhancing the asset sensor signals accordingly.

*Note: An X cable does not help enhance the asset sensor signals for Raritan's PX3 or PX3TS devices, so do not use this cable with them.*

#### ► To connect composite asset sensors via an X cable:

1. Plug the RJ-45 connector at the shorter end of the X cable into the FEATURE port of the PX device.

2. Plug the phone connector of the X cable into the RJ-12 SENSOR port of the PX device. **This step is required for improving the asset sensor signal strength.**



3. Plug the RJ-45 connector at the longer end of the X cable into the RJ-45 port labeled "Input" on the composite asset sensors.

---

*Note: Though the X cable can also connect to a regular asset sensor, usually it is not necessary to make such a connection.*

---

- A maximum of 5 additional composite asset sensors can be connected to the first composite asset sensor being attached to the X cable. See **Connecting Composite Asset Sensors (AMS-Mx-Z)** (on page 47) for step-by-step instructions.

4. Connect any Raritan environmental sensor package or hub to the RJ-12 sensor port of the X cable if environmental sensor packages are needed. Note that a DX sensor requires an RJ-12 to RJ-45 adapter to connect the X cable. See **Connecting Environmental Sensor Packages** (on page 30) for more information.

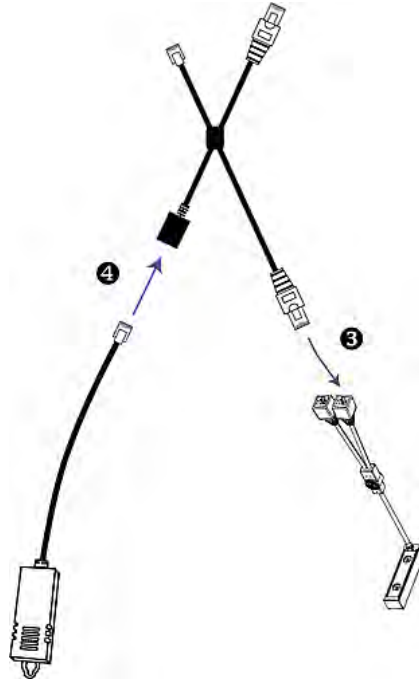

---

## Connecting a Logitech Webcam

Connect webcams to PX in order to view video or snapshots of the webcam's surrounding area.

The following UVC-compliant webcams are supported:

- Logitech® Webcam® Pro 9000, Model 960-000048
- Logitech QuickCam Deluxe for Notebooks, Model 960-000043
- Logitech QuickCam Communicate MP, Model 960-000240
- Logitech C200, C210, C270 and C920

Other UVC-compliant webcams may work. However, Raritan has neither tested them nor claimed that they will work properly. More information about the scores of UVC-compliant webcams can be found at <http://www.ideasonboard.org/uvc> (<http://www.ideasonboard.org/uvc>).

PX has only one USB-A port to connect a webcam, but you can use a "powered" USB hub to connect up to two webcams.

After connecting a webcam, visually monitor environmental conditions near the PX through the PX web interface from anywhere. If your webcam supports audio, audio is available with videos.

For more information on the Logitech webcam, see the user documentation accompanying it.

► **To connect a webcam:**

1. Connect the webcam to the USB-A port on the PX device. The PX automatically detects the webcam.
2. Position the webcam properly.

---

**Important: If a USB hub is used to connect the webcam, make sure it is a "powered" hub.**

---

Snapshots or videos captured by the webcam are immediately displayed in the PX web interface after the connection is complete. See **Viewing Webcam Snapshots or Videos** (on page 282).



---

## Connecting a GSM Modem

A Cinterion® MC52iT or MC55iT GSM modem can be connected to the PX in order to send SMS messages containing event information. See **Creating Actions** (on page 200) for more information on SMS messages.

---

*Note: PX cannot receive SMS messages.*

---

► **To connect the GSM modem:**

1. Connect the GSM modem to the DB9 serial port on the PX.
2. Configure the GSM modem as needed. See the supporting GSM modem help for information on configuring the GSM modem.
3. Configure the GSM modem settings in PX.
  - a. Click Device Settings > Serial Port Settings. The Serial Port Configuration dialog opens.
  - b. If needed, enter the GSM modem SIM PIN.

---

## Connecting an Analog Modem

The PX supports remote dial-in communications to access the CLI through an analog modem. This dial-in feature provides an additional alternative to access the PX when the LAN access is not available. To dial in to the PX, the remote computer must have a modem connected and dial the correct phone number.

Below are the analog modems that the PX supports for sure:

- NETCOMM IG6000 Industrial Grade SmartModem
- US Robotics 56K modem

The PX may also support other analog modems which Raritan did not test.

Note that the PX does NOT support dial-out or dial-back operations via the modem.

► **To connect an analog modem:**

1. Plug a telephone cord into the phone jack of the supported modem.
2. Plug the modem's RS-232 cable into the serial port labeled CONSOLE / MODEM on the PX.

You need to enable the modem dial-in support to take advantage of this feature, see **Configuring the Serial Port** (on page 118).

---

## Connecting an External Beeper

The PX supports the use of an external beeper for audio alarms. After having an external beeper connected, you can create event rules for the PX to switch on or off the external beeper when specific events occur. See **Creating an Event Rule** (on page 199).

► **To connect an external beeper:**

1. Connect a standard network patch cable to the FEATURE port of the PX.
2. Plug the other end of the cable into the external beeper's RJ-45 socket.

The beeper can be located at a distance up to 330 feet (100 m) away from the PX.

---

## Connecting a Schroff LHX/SHX Heat Exchanger

*Note: Only the PDUs whose model names begin with PX2 or PX3 support the LHX/SHX heat exchangers.*

To remotely monitor and administer the Schroff® LHX-20, LHX-40 and SHX-30 heat exchangers through the PX device, you must establish a connection between the heat exchanger and the PX device.

For more information on the LHX/SHX heat exchanger, see the user documentation accompanying that product.

To establish a connection between the PDU and LHX/SHX heat exchanger, an RJ-45 to RS-232 adapter cable provided by Schroff is required.

► **To connect an LHX or SHX heat exchanger:**

1. Plug the RS-232 DB9 end of the adapter cable into the RS-232 port on the Schroff LHX/SHX heat exchanger.
2. Plug the RJ-45 end of the cable into the port labeled FEATURE on your PX device.

See **Managing the Schroff LHX/SHX Heat Exchanger** (on page 291) for enabling the support of the LHX/SHX heat exchanger.

# Chapter 5 Using the PDU

This chapter explains how to use the PX device. It describes the LEDs and ports on the PDU, and explains how to use the front panel display. It also explains how the overcurrent protector works and when the beeper sounds.

## In This Chapter

Panel Components .....	55
Circuit Breakers .....	65
Fuse .....	67
Beeper .....	70

---

## Panel Components

The PX comes in Zero U, 1U, and 2U sizes. All types of models come with the following components on the outer panels.

- Power cord
- Outlets
- Connection ports
- LED display
- Reset button

---

### Power Cord

Most of Raritan PDUs come with an installed power cord, which is ready to be plugged into an appropriate receptacle for receiving electricity. Such devices cannot be rewired by the user.

Connect each PX to an appropriately rated branch circuit. See the label or nameplate affixed to your PX for appropriate input ratings or range of ratings.

There is no power switch on the PX device. To power cycle the PDU, unplug it from the branch circuit, wait 10 seconds and then plug it back in.

---

### Outlets

The total number of outlets varies from model to model.

**PX2-3000 Series**

These models are NOT outlet-switching capable so all outlets are always in the ON state.

Outlet LEDs are not available.

**PX2-4000 Series**

These PDUs are NOT outlet-switching capable models so all outlets are always in the ON state.

A small LED adjacent to each outlet indicates the outlet state. Outlet LEDs always light red, indicating that the outlet power is ON.

**PX2-5000 Series**

These models are outlet-switching capable. A small LED adjacent to each outlet indicates the outlet or PDU state. The PDU is shipped from the factory with all outlets turned ON. The table below explains how to interpret different outlet LED states.

LED state	Outlet status	What it means
Not lit	Powered OFF	The outlet is not connected to power, or the control circuitry's power supply is broken.
Red	ON and LIVE	LIVE power. The outlet is on and power is available.
Red flashing	ON and LIVE	The current flowing through the outlet is greater than the upper warning (non-critical) threshold.
Green	OFF and LIVE	The outlet is turned off and power is available when the outlet is turned on.
Green flashing	OFF and NOT LIVE	The outlet is turned off and power is not available because the circuit breaker has tripped.
Red and Green flashing alternatively	ON and NOT LIVE	The outlet is turned on but power is not available because a circuit breaker has tripped.
Cycling through Red, Green and Yellow	n/a	The PX device has just been plugged in and its management software is loading. LED color cycling does not interrupt power to outlets. It is an indication of firmware loading.

*Note: When a PX device powers up, it proceeds with the power-on self test and software loading for a few moments. At this time, the outlet LEDs cycle through different colors. When the software has completed loading, the outlet LEDs show a steady color and the front panel display illuminates.*

## Connection Ports

Depending on the model you purchased, the total number of ports available varies.

### Zero U Connection Ports

For most of PX2 Zero U models, there are 6 ports on the front panel.

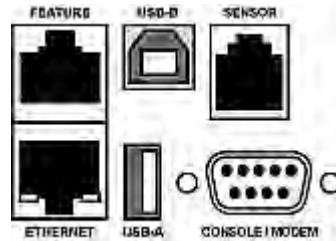

### 1U and 2U Port Locations

The difference between Zero U, 1U and 2U models is that Zero U models have all the connection ports located on the front panel while 1U and 2U models have the ports located respectively on the front and back panels. In addition, many PX2 series 1U and 2U models are implemented with two SENSOR ports on the back panel as shown on the following diagram.

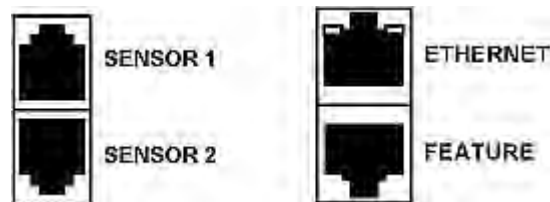

### Connection Port Functions

The table below explains the function of each port.

Port	Used for...
USB-B	Establishing a USB connection between a computer and the PX device. This port can be used for disaster recovery of the PX device. Contact Raritan Technical Support for instructions.
USB-A	Connecting a USB device, such as a Logitech® webcam. This is a "host" port, which is powered, per USB 2.0 specifications.
FEATURE	Connection to some Raritan access products (such as Dominion KX II)

Port	Used for...
	<p>through the use of a power CIM, OR --</p> <p>Connection to a Schroff® LHX-20, SHX-30 or LHX-40 device through an RJ-45 to RS-232 cable provided by Schroff, OR --</p> <p>Connection to an external beeper with the RJ-45 socket, OR --</p> <p>Connection to a Raritan asset management sensor, which allows you to track the locations of IT devices on the rack.</p> <p>See <b>Connecting External Equipment (Optional)</b> (on page 30).</p> <p>Warning: This is not an RS-232 port so do NOT plug in an RS-232 device, or damages can be caused to the device.</p>
CONSOLE/ MODEM	<p>Establishing a serial connection between a computer and the PX device:</p> <p>This is a standard DTE RS-232 port. You can use a null-modem cable with two DB9 connectors on both ends to connect the PX device to the computer.</p>
*SENSOR	<p>Connection to Raritan's environmental sensor packages.</p> <p>A sensor hub is required if you want to connect more than one DPX sensor package.</p>
ETHERNET	<p>Connecting the PX device to your company's network:</p> <p>Connect a standard Cat5e/6 UTP cable to this port and connect the other end to your network. This connection is necessary to administer or access the PX device remotely using the web interface.</p> <p>There are two small LEDs adjacent to the port:</p> <ul style="list-style-type: none"> <li>▪ Green indicates a physical link and activity.</li> <li>▪ Yellow indicates communications at 10/100 BaseT speeds.</li> </ul> <p>For a USB-cascading configuration in the bridging mode, the wired network connection is a must for the <i>master</i> PX. See <b>Cascading the PX via USB</b> (on page 25) for details.</p> <hr/> <p><i>Note: Connection to this port is not required if connection to a wireless network is preferred.</i></p>

\* The SENSOR port on a PX2 PDU is RJ-12.

## LED Display

The LED display is located on the side where outlets are available.

These diagrams show the LED display on different types of PDUs. Note that the LED display might slightly vary according to the PDU you purchased.

### Zero U models:

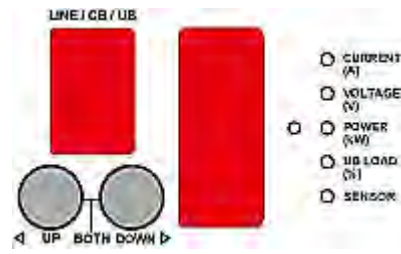

### 1U models:

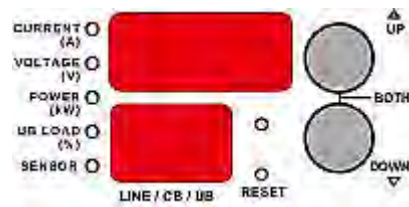

### 2U models:

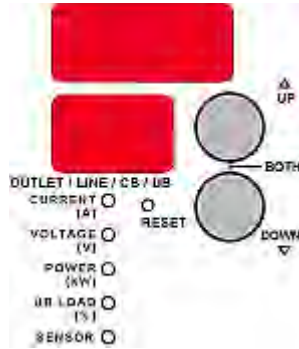

The LED display consists of:

- A row displaying three digits
- A row displaying two digits
- Up and Down buttons
- Five LEDs for measurement units

A Zero U model can detect its own orientation through the built-in tilt sensor and automatically changes the direction of the alphanumeric digits shown on the LED display for readability. To lock the direction of the digits shown on the LED display, you can set the display orientation using the command line interface. See **Changing the LED Display Orientation** (on page 363).

---

*Note: When a PX device powers up, it proceeds with the power-on self test and software loading for a few moments. When the software has completed loading, the LED display illuminates.*

---

### Three-Digit Row

The three-digit row shows the readings for the selected component. Values that may appear include:

- Current, voltage, or active power of the selected outlet
- Active power or unbalanced load of the inlet
- Current of the selected circuit breaker
- Current and voltage of the selected line

---

*Note: L1 voltage refers to the L1-L2 or L1-N voltage, L2 voltage refers to the L2-L3 or L2-N voltage, and L3 voltage refers to the L3-L1 or L3-N voltage.*

---

- The text "FuP," which indicates that the Firmware uPgrade is being performed
- The text "CbE," which indicates the circuit breaker associated with the selected outlet has tripped or the fuse has blown



**LEDs for Measurement Units**

Five small LED indicators are on the LED display: four measurement units LEDs and one Sensor LED.

The measurement units vary according to the readings that appear in the three-digit row. They are:

- Amp (A) for current
- Volt (V) for voltage
- Kilowatt (kW) for active power
- Percentage (%) of the unbalanced load

One of the measurement unit LEDs will be lit to indicate the unit for the value currently shown in the three-digit row.

The Sensor LED is lit only when PX detects the physical connection of any environmental sensor.

The five LEDs look similar to this diagram but may slightly vary according to the model you purchased.

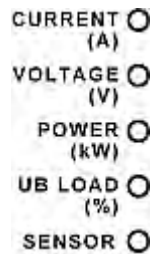
**Two-Digit Row**

The two-digit row shows the number of the currently selected outlet, line or circuit breaker. Values that may appear include:

- Two-digit numbers: This indicates the selected outlet. For example, 03 indicates outlet 3.
- C<sub>x</sub>: This indicates the selected circuit breaker, where *x* is the circuit breaker number. For example, C1 represents Circuit Breaker 1.
- L<sub>x</sub>: This indicates the selected line, where *x* is the line number. For example, L2 represents Line 2.

---

*Note: For a single-phase model, L1 current represents the Unit Current.*

---

- AP: This indicates the selected inlet's active power.
- UL: This represents the selected inlet or outlet's **Unbalanced Load**, which is only available for a three-phase PDU.
- ix: This refers to the selected inlet on a multi-inlet PDU, where x is the inlet number. For example, i1 refers to Inlet 1, and i2 refers to Inlet 2.

The two-digit row shows the inlet number while displaying an inlet's line or active power on a multi-inlet PDU. It will cycle through the selected inlet number and that inlet's line or active power (AP). For example, when cycling through i1 and L1, the value displayed in the three-digit row belongs to Inlet 1's L1, and when cycling through i2 and L1, the displayed value belongs to Inlet 2's L1.

---

*Note: The point of the alphabet 'i' cannot be displayed on the LED display so i1 looks like <sub>i</sub>1 and i2 looks like <sub>i</sub>2.*

---

During the firmware upgrade, some PX models may show b<sub>x</sub> in the two-digit row to indicate the relay or meter board numbered x is being updated.

#### **Automatic Mode**

When left alone, the LED display cycles through the line readings and circuit breaker readings at intervals of 10 seconds, as available for your PX. This is the Automatic Mode.

If your PDU is a multi-inlet PDU, it will cycle through the line readings of different inlets and circuit breaker readings.

For each line reading, the PX always displays i1 for Inlet 1 or i2 for Inlet 2 in the two-digit row of the LED display as described below:

- When showing L1 of Inlet 1, the two-digit row cycles through i1 and L1.
- When showing L1 of Inlet 2, the two-digit row cycles through i2 and L1.

---

*Note: The point of the alphabet 'i' cannot be displayed on the LED display so i1 looks like <sub>i</sub>1 and i2 looks like <sub>i</sub>2.*

---

### Manual Mode

You can press the Up or Down button to enter the Manual Mode so that a particular outlet, line or circuit breaker can be selected to show specific readings.

In addition, you can select a particular inlet if your PDU has more than one inlet. Each inlet is indicated as i1, i2, or the like in the two-digit row of the LED display.

---

*Note: The point of the alphabet 'i' cannot be displayed on the LED display so i1 looks like | 1 and i2 looks like | 2.*

---

#### ► To operate the LED display:

1. Press the Up or Down button until the desired outlet, line or circuit breaker number is selected in the two-digit row. Or you can press either button to select the inlet's active power, which is shown as AP.
  - Pressing the ▲ (UP) button moves up one selection.
  - Pressing the ▼ (DOWN) button moves down one selection.

If your PDU is a multi-inlet PDU and you select a specific inlet's line or active power (AP), the two-digit row will cycle through the selected inlet number and that inlet's line or active power. For example:

  - When showing L1 of Inlet 1, the two-digit row cycles through i1 and L1.
  - When showing L1 of Inlet 2, the two-digit row cycles through i2 and L1.
  - When showing active power of Inlet 1, the two-digit row cycles through i1 and AP.
  - When showing active power of Inlet 2, the two-digit row cycles through i2 and AP.
2. Current of the selected component is shown in the three-digit row. Simultaneously the CURRENT(A) LED is lit. See **LEDs for Measurement Units** (on page 61).
3. When selecting an outlet or a line, you can press the Up and Down buttons simultaneously to switch between voltage, active power and current readings.
  - When the voltage is displayed, the VOLTAGE(V) LED is lit. It is displayed for about five seconds, after which the current reading re-appears.
  - When the active power is displayed, the POWER(kW) LED is lit. It is displayed for about five seconds, after which the current reading re-appears.

4. When selecting AP, it displays the selected inlet's active power reading.
  - When the active power is displayed, the POWER(kW) LED is lit.

---

*Note: The LED display returns to the Automatic Mode after 20 seconds elapse since the last time any button was pressed.*

---

### Outlet Switching

This section applies to outlet-switching capable models only.

You can operate the front panel LED display to turn on or off an outlet. To do this, you must first enable the front panel outlet control function. See **Enabling Front Panel Outlet Switching** (on page 187).

► **To turn on an outlet:**

1. Press the Up or Down button until the desired outlet's number is shown in the two-digit row.
2. Press and hold the Up button until the confirmation message "on?" is shown in the three-digit row.



3. Press and hold the Up button until the above confirmation message disappears, indicating that the outlet has been turned on.
4. Verify that the desired outlet's LED has turned red.

► **To turn off an outlet:**

1. Press the Up or Down button until the desired outlet's number is shown in the two-digit row.
2. Press and hold the Down button until the confirmation message "oF?" is shown in the three-digit row.

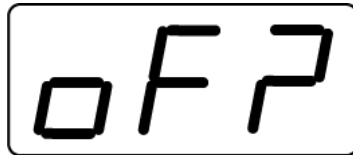

3. Press and hold the Down button until the above confirmation message disappears, indicating that the outlet has been turned off.
4. Verify that the desired outlet's LED has turned green.

---

*Tip: If you want to abort the outlet switching operation after the confirmation message appears, press either button (without holding it) and the confirmation message will disappear.*

---

### Reset Button

The reset button is located inside the small hole near the display panel on the PDU.

The PX device can be reset to its factory default values using this button when a serial connection is available. See **Resetting to Factory Defaults** (on page 523).

Without the serial connection, pressing this reset button restarts the PX device's software without any loss of power to outlets.

The following image illustrates the location of the reset button on Zero U models only.

#### PX2 Zero U models:



---

## Circuit Breakers

PX models rated over 20A (North American) or 16A (international) contain overcurrent protectors for outlets, which are usually branch circuit breakers. These circuit breakers automatically trip (disconnect power) when the current flowing through the circuit breaker exceeds its rating.

If the circuit breaker switches off power, the front panel display shows:

- CbE, which means "circuit breaker error."
- The lowest outlet number affected by the circuit breaker error.

You are still able to switch between outlets on the PDU's display panel when the circuit breaker error occurs. Outlets affected by the error show CbE. Unaffected outlets can show diverse sensor readings properly.

When a circuit breaker trips, power flow ceases to all outlets connected to it. You must manually reset the circuit breaker so that affected outlets can resume normal operation.

Depending on the model you purchased, the circuit breaker may use a button- or handle-reset mechanism.

---

### Resetting the Button-Type Circuit Breaker

Your button-type circuit breakers may look slightly different from the images shown in this section, but the reset procedure remains the same.

► **To reset the button-type breakers:**

1. Locate the breaker whose ON button is up, indicating that the breaker has tripped.

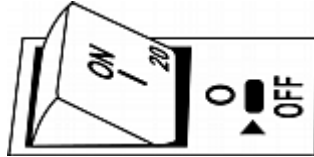

2. Examine your PX and the connected equipment to remove or resolve the cause that results in the overload or short circuit. **This step is required, or you cannot proceed with the next step.**
3. Press the ON button until it is completely down.

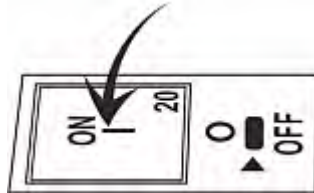

---

### Resetting the Handle-Type Circuit Breaker

Your handle-type circuit breakers may look slightly different from the images shown in this section, but the reset procedure remains the same.

► **To reset the handle-type breakers:**

1. Lift the hinged cover over the breaker.
2. Check if the colorful rectangle or triangle below the operating handle is GREEN, indicating that the breaker has tripped.

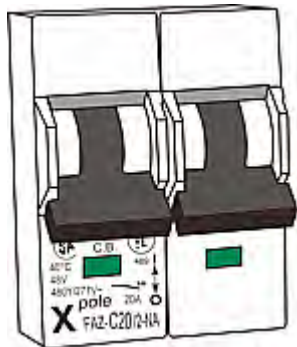

3. Examine your PX and the connected equipment to remove or resolve the cause that results in the overload or short circuit. **This step is required, or you cannot proceed with the next step.**
4. Pull up the operating handle until the colorful rectangle or triangle turns RED.



---

## Fuse

Some PX devices may be implemented with fuses instead of circuit breakers. A fuse blows to protect associated outlets if it detects the overload.

If your PDU uses fuses, you must replace it with a new one when it blows or malfunctions. The rating of the new fuse must be the same as the original one.



**Use of inappropriately rated fuse results in damage to the PDU and connected equipment, electric shock, fire, personal injury or death.**

Depending on the design of your PDU, the fuse replacement methods differ.

---

### Fuse Replacement on Zero U Models

This section only applies to a Zero U PDU with "replaceable" fuses.

► **To replace a fuse on the Zero U model:**

1. Lift the hinged cover over the fuse.



2. Verify the new fuse's rating against the rating specified in the fuse holder's cover.



3. Push the cover of the fuse holder to expose the fuse.



4. Take the fuse out of the holder.



5. Insert a new fuse into the holder. There is no orientation limit for fuse insertion.
6. Close the fuse holder and the hinged cover in a reverse order.



### Fuse Replacement on 1U Models

On the 1U model, a fuse is installed in a fuse knob, which fits into the PDU's fuse carrier.



Number	Description
①	Fuse carrier
②	Fuse knob where a fuse is installed

► **To replace a fuse on the 1U PDUs:**

1. Disconnect the PDU's power cord from the power source.
2. Remove the desired fuse from the PDU's fuse carrier using a flat screwdriver.
  - a. Rotate the fuse knob counterclockwise until its slot is inclined to 45 degrees.



- b. Take this knob out of the fuse carrier.
3. Remove the original fuse from this knob, and insert either end of a new one into the knob. Make sure the new fuse's rating is the same as the original one.



Number	Description
①	Fuse knob

Number	Description
2	Fuse

4. Install this knob along with the new fuse into the fuse carrier using a flat screwdriver.
  - a. Have this knob's slot inclined 45 degrees when inserting the knob into the fuse carrier.



- b. Gently push this knob into the fuse carrier and then rotate it clockwise until its slot is horizontal.
5. Verify whether this knob's head is aligned with the fuse carrier. If its head is higher or lower than the fuse carrier, re-install it.



Number	Description
1	INAPPROPRIATE installations
2	Appropriate installation

6. Connect the PDU's power cord to the power source and verify that the corresponding fuse LED is lit, indicating that the fuse works properly.

## Beeper

The PX includes a beeper to issue an audible alarm for an overcurrent protector which is open.

- The beeper sounds an alarm within 3 seconds of a circuit breaker trip.
- The beeper stops as soon as all circuit breakers have been reset.

*Tip: You can remotely check this beeper's state via the web interface. See **Checking the Internal Beeper State** (on page 131).*

# Chapter 6 Using the Web Interface

This chapter explains how to use the web interface to administer a PX.

## In This Chapter

Supported Web Browsers.....	71
Logging in to the Web Interface .....	72
Logout.....	75
Introduction to the Web Interface .....	76
Viewing the Dashboard .....	87
Device Management.....	89
User Management.....	132
Setting Up Roles.....	138
Access Security Control .....	141
Setting Up a TLS Certificate.....	156
Setting Up External Authentication.....	162
Outlet Management .....	170
Inlet and Overcurrent Protector Management.....	187
Setting Power Thresholds .....	192
Event Rules and Actions .....	199
Managing Event Logging.....	246
Viewing Connected Users .....	248
Monitoring Server Accessibility.....	249
Environmental Sensors and Actuators .....	254
Asset Management.....	271
Bulk Configuration .....	276
Backup and Restore of PX Device Settings .....	279
Webcam Management .....	280
Network Diagnostics.....	289
Downloading Diagnostic Information.....	290
Managing the Schroff LHX/SHX Heat Exchanger.....	291
Firmware Upgrade.....	299
Accessing the Help.....	303

---

## Supported Web Browsers

The following web browsers can be used to access the PX web interface:

- Internet Explorer® 8, 9, 10 and 11
- Firefox® 25 and later
- Safari® 5.x (MacOS Lion)
- Google® Chrome® 32 and later
- Android 4.2 and later
- IOS 7.0

---

®

---

---

## Logging in to the Web Interface

To log in to the web interface, you must enter a user name and password. The first time you log in to the PX, use the default user name (admin) and password (raritan). You are then prompted to change the password for security purposes.

---

*Exception: If you already changed the password for the admin account, use the new password instead for login, and the PX will NOT prompt you to change the password.*

---

After successfully logging in, you can create user profiles for your other users. These profiles define their login names and passwords. See **Creating a User Profile** (on page 132).

---

### Login

The web interface allows a maximum of 16 users to log in simultaneously.

You must enable JavaScript in the web browser for proper operation.

► **To log in to the web interface:**

1. Open a browser, such as Microsoft Internet Explorer or Mozilla Firefox, and type this URL:

*http(s)://<ip address>*

where *<ip address>* is the IP address of the PX.



2. If a security alert message appears, click OK or Yes to accept. The Login page then opens.
3. Type your user name in the User Name field, and password in the Password field.

A screenshot of a web browser window displaying a "Login" page. The page has a light blue background and a title bar with a user icon and the word "Login". There are two input fields: "User Name:" and "Password:". Below the fields are two buttons: "Login" and "Clear".

---

*Note: Both the user name and password are case sensitive. If needed, click Clear to clear either the inputs or any error message that appears.*

---

- If a security agreement is displayed on the Login page, accept it. To select the agreement checkbox using the keyboard, press the Space bar.

---

*Note: If you do not accept the security agreement, you cannot log in successfully.*

---

- Click Login or press Enter. The PX page opens.

---

*Note: Depending on your hardware configuration, elements shown on the web interface may appear slightly different from this image.*

---

The screenshot displays the Raritan PX IPDU web interface. The main content area is titled 'Dashboard' and includes several sections:

- Inlet:** A summary of power metrics: RMS Current (0.0 A / 32.0 A), RMS Voltage (112 V), Active Power (0 W), Apparent Power (0 VA), Power Factor (1.00), and Active Energy (2632 Wh).
- Alerted Sensors:** A table with columns for Sensor, Reading, and State.
- Alarms:** A table with columns for Name, Reason, First Appearance, Last Appearance, Count, and More Alerts.
- Outlets:** Summary statistics: Number of Outlets On (7) and Number of Outlets Off (1).
- Overcurrent Protectors (2):** A table listing two protectors with columns for #, Name (Label), Current Drawn, Current Remaining, Status, and Protected Outlets.
 

#	Name (Label)	Current Drawn	Current Remaining	Status	Protected Outlets
1	Overcurrent Protector C1	0.0 A	10.0 A	closed	1 - 4
2	Overcurrent Protector C2	0.0 A	10.0 A	closed	5 - 8
- Peripheral Devices (4 managed, 0 unmanaged):** A table with columns for Name, Position, Reading, and State.
 

Name	Position	Reading	State
Humidity 1	Port 1	63 %	normal
Humidity 2	Port 1	62 %	normal
Temperature 1	Port 1	22.0 °C	normal
Temperature 2	Port 1	22.1 °C	normal

The interface also shows a navigation menu on the left, a status bar at the bottom with user information (Administrator (admin)), and a timestamp (2/14/14 11:31 PM).

---

*Note: The IP address to access a slave device in the port forwarding mode is a combination of the IP address and the port number. See **Port Forwarding Examples** (on page 122).*

---

---

## Changing Your Password

Normal users can change their own passwords if they have the Change Own Password permission. See **Setting Up Roles** (on page 138).

If you are the administrator (admin), the PX web interface automatically prompts you to change the password if this is your first time to log in to the PX. If you have the Administrator Privileges, you can change other users' passwords, as well. See **Modifying a User Profile** (on page 136).

### ► To change your password:

1. Choose User Management > Change Password. The Change User Password dialog appears.

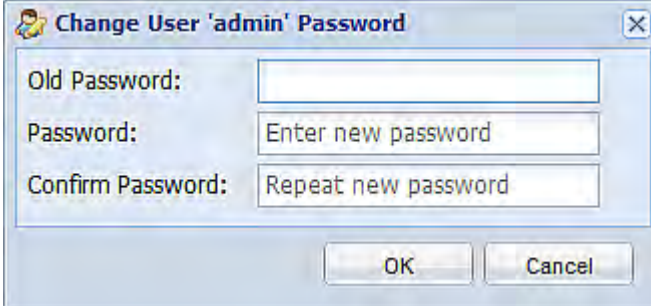

2. Type the current password in the Old Password field.
3. Type your new password in the Password and Confirm Password fields. The password can be 4 to 64 characters long. It is case sensitive.
4. Click OK.

---

## Remembering User Names and Passwords

As of release 3.0.0, the PX supports the password manager of Microsoft Internet Explorer® and Mozilla Firefox®.

You can choose to save the user name and password used to log in to the PX when these two browsers ask whether you want to remember them. If yes, next time your user name and password can be automatically completed at login.

For information on how to activate a browser's password manager, see the user documentation accompanying Internet Explorer or Firefox.



The PX does NOT support other browser password managers.

---

## Logout

After finishing your tasks with the PX, you should log out to prevent others from accessing the web interface.

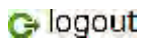
► **To log out of the web interface:**

1. Do one of these:
  - Click "logout" on the top-right corner of the web interface.  
The image shows a green circular icon with a white arrow pointing right, followed by the text "logout" in a bold, sans-serif font.
  - Close the web browser by clicking the Close button () on the top-right corner of the browser.
  - Close the web browser by choosing File > Close, or File > Exit. The command varies according to the version of the browser you use.
  - Choose the Refresh command or click the Refresh button on the web browser.
2. Either the login page opens or the browser is closed, depending on your choice in the previous step.

## Introduction to the Web Interface

The web interface provides two panes, a menu bar, a status bar, an Add Page icon, and a logout button throughout every page.

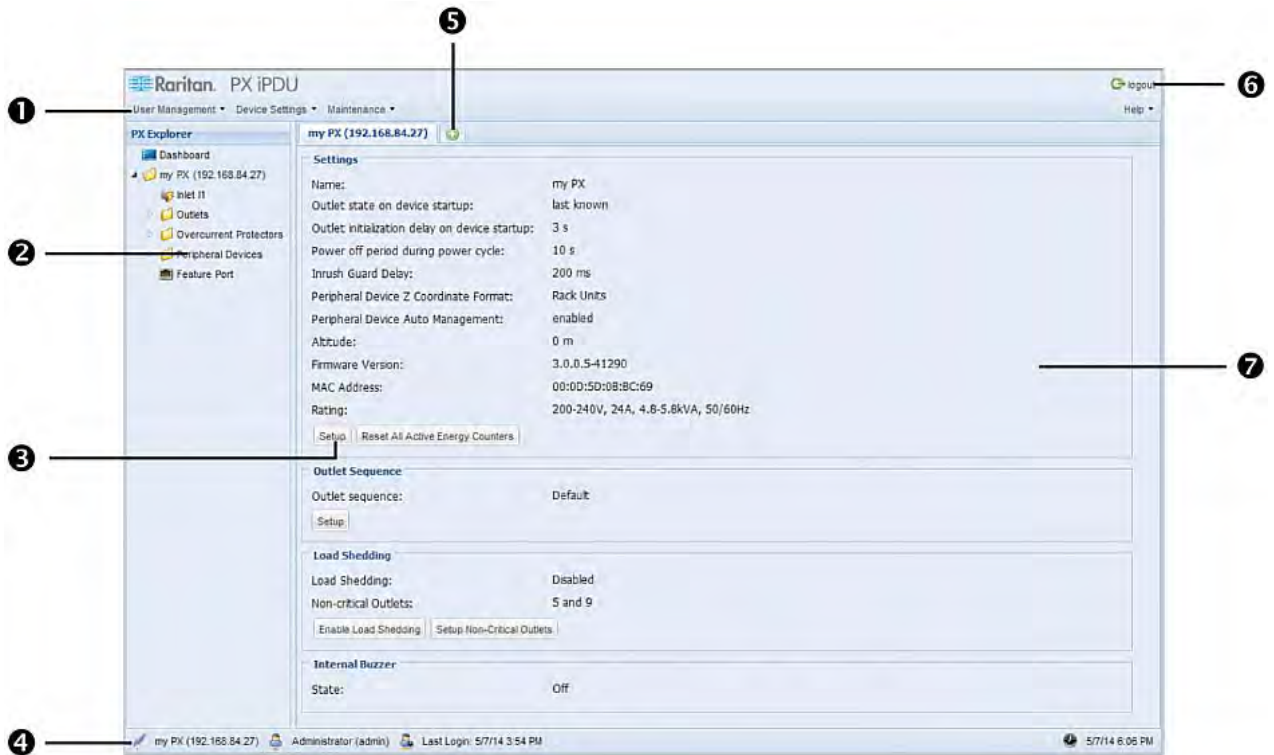

Number	Web interface element
1	Menus
2	PX Explorer pane
3	Setup button*
4	Status bar
5	Add Page icon
6	Logout button
7	Data pane

\* The Setup button is not available on some pages, such as the *Dashboard* page.

For detailed information about these web interface elements, see the sections that follow.



---

## Menus

There is a menu bar across the top of the page. You can click any menu to select the desired menu item from the drop-down list.

Four menus are available for managing different tasks or showing information.

- **User Management** contains menu items for managing user profiles, permissions (roles), and password.
- **Device Settings** deals with device-related settings, such as the device name, network settings, security settings, and system time.
- **Maintenance** provides tools that are helpful for maintaining the PX, such as the event log, hardware information, firmware upgrade and so on.
- **Help** displays information regarding the firmware and all open source packages embedded on the PX. In addition, you can access the online help from this menu.

---

## PX Explorer Pane

The hierarchical tree to the left displays the PX device you are accessing as well as all physical components embedded on or connected to this product, such as inlets, outlets, and environmental sensors. In addition, an icon named Dashboard is available for displaying the PDU summary information.

The tree structure comprises three hierarchical levels.

First level	Second level	Third level
Dashboard	None	None
PDU folder*	Inlet I1	None
	Outlets folder	1 to n**
	Overcurrent Protectors folder	<ul style="list-style-type: none"> <li>• Circuit breakers - C1 to Cn**</li> <li>• Fuses - F1 to Fn**</li> </ul>
	Peripheral Devices folder	A list of connected environmental sensors

First level	Second level	Third level
	Feature Port folder	One of the following is displayed, depending on your configuration: <ul style="list-style-type: none"> <li>• None</li> <li>• Asset Strip</li> <li>• Power CIM</li> <li>• External Beeper</li> <li>• LHX-20</li> <li>• SHX-30</li> <li>• LHX-40</li> </ul>
	Webcam Management folder	<ul style="list-style-type: none"> <li>• Snapshots</li> <li>• Webcam</li> </ul>

\* The folder is named "my PX" by default. The name can be customized.

\*\* n represents the final number of that component.

---

*Note: A Webcam icon appears only when a supported Logitech® webcam is connected to the PX. See **Connecting a Logitech Webcam** (on page 52).*

---

► **To navigate through the tree:**

1. To expand any folders, see **Expanding the Tree** (on page 78).
2. To show any tree item's data, click on that item. See **Add Page Icon** (on page 81).

**Expanding the Tree**

The icons representing all components implemented on or connected to the PX device are expanded by default. If they are hidden, you may expand the tree manually to show all component icons.

► **To expand the tree:**

1. By default, the PDU folder has been expanded.

---

*Note: The folder is named "my PX" by default. The name can be customized.*

---

If it is not expanded, click the white arrow ▸ prior to the folder icon, or double-click the folder. The arrow then turns into a black, gradient arrow ▲, and icons of components or component groups appear below the PDU folder.

- To expand any component group at the second level, click the white arrow ▸ prior to the folder icon, or double-click the folder.

The arrow then turns into a black, gradient arrow ▲, and icons representing individual components appear below the group folder.

Repeat Step 2 for other component groups you want to expand. The expanded tree looks similar to this image.

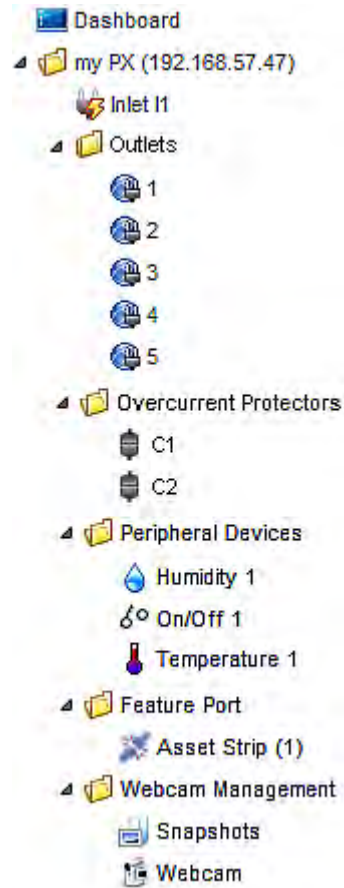

### Collapsing the Tree

You can collapse the whole tree structure or a specific component group to hide all or partial tree items.

► **To collapse the whole tree:**

- Click the black, gradient arrow ▲ prior to the root folder icon, or double-click the folder.

---

*Note: The folder is named "my PX" by default. The name can be customized.*

---

The arrow then turns into a white arrow ▾, and all items below the folder disappear.

► **To hide some tree items:**

1. Click the black, gradient arrow ▲ prior to the component group folder that you want to collapse, or double-click the folder.

The arrow then turns into a white arrow ▾, and all items below the folder disappear.

2. Repeat Step 1 for other component groups you want to collapse.

### Adjusting the Pane

You can change the width of the pane to make the area larger or smaller.

► **To adjust the pane's width:**

1. Move the mouse pointer to the right border of the Explorer pane.
2. When the mouse pointer turns into a two-way arrow, drag the border horizontally to widen or shrink the pane.

---

### Setup Button

The Setup button is available for most tree items. It triggers a setup dialog where you can change settings for the selected tree item.

---

### Status Bar

The status bar shows five pieces of information.

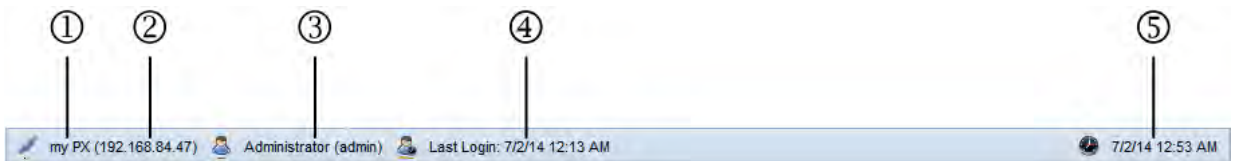

1. **Device name:**

This is the name assigned to the PX device. The default is "my PX." See **Naming the PDU** (on page 95).

2. **IP address:**

The numbers enclosed in parentheses is the IP address assigned to the PX device. See **Initial Network Configuration via CLI** (on page 19) or **Modifying Network Settings** (on page 99).

---

*Tip: The presence of the device name and IP address in the status bar indicates the connection to the PX device. If the connection is lost, it shows "  disconnected " instead.*

---

3. **Login name:**

This is the user name you used to log in to the web interface.

4. **Last login time:**

This shows the date and time this login name was used to log in to this PX device last time.

When the mouse pointer hovers over the last login time, detailed information about the last login is displayed, including the access client and IP address.

For the login via a local connection (serial RS-232 or USB), <local> is displayed instead of an IP address.

There are different types of access clients:

- Web GUI: Refers to the PX web interface.
- CLI: Refers to the command line interface (CLI).

The information in parentheses following "CLI" indicates how this user is connected to the CLI.

- *Serial*: Represents the local connection (serial RS-232 or USB).
- *SSH*: Represents the SSH connection.
- *Telnet*: Represents the Telnet connection.

5. **System date and time:**

Current date, year, and time are displayed to the right of the bar. If positioning the mouse pointer over the system date and time, the time zone information is also displayed.

---

### Add Page Icon

The Add Page icon , located on the top of the data pane, lets you open data pages of multiple tree items without overriding any opened page.

► **To open new data pages:**

1. Click the Add Page icon . A new tab along with a blank data page appears.

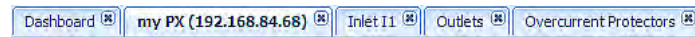

2. Click a tree item whose data page you want to open. The data of the selected tree item is then displayed on the blank page.
3. To open more data pages, repeat the above steps. All tabs representing opened pages are shown across the top of the page.

The following diagram shows a multi-tab example.



4. With multiple pages opened, you can take these actions:

- To switch to one of the opened data pages, click the corresponding tab.

If there are too many tabs to be all shown, two arrows ( and ) appear at the left and right borders of the pane. Click either arrow to navigate through all tabs.

- To close any data page, click the Close button () on the corresponding tab.

---

### Logout Button

Click the logout button when you want to log out of the web interface.



---

### Data Pane

The right pane shows the data page of the selected tree item. The data page includes the item's current status, settings and a Setup button (if available).

All tabs above the pane represent the opened data pages. The highlighted tab indicates the current selection.

You can change the width of the pane to make the area larger or smaller.

► **To adjust the pane's width:**

1. Move the mouse pointer to the left border of the right pane.
2. When the mouse pointer turns into a two-way arrow, drag the border horizontally to widen or shrink the pane.

---

### More Information

This section explains additional web interface elements or operations that are useful.

### Warning Icon

If the value you entered in a specific field is invalid, a red warning icon appears to the right and the field in question is surrounded by a red frame as shown in this illustration.

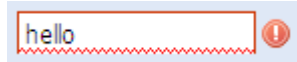

When this occurs, position your mouse pointer over the warning icon to view the reason and modify the entered value accordingly.

### The Yellow- or Red-Highlighted Sensors

When a numeric sensor's reading crosses any upper or lower threshold, the background color of the whole row turns to yellow or red for alerting users.

For a discrete (on/off) sensor, the row changes the background color when the sensor enters the abnormal state.

If any circuit breaker trips or any fuse blows, the circuit breaker or fuse's row is also highlighted in red.

See the table for the meaning of each color:

Color	State
White	<p>The background is white in one of the following scenarios:</p> <ul style="list-style-type: none"> <li>For a numeric sensor, no thresholds have been enabled.</li> <li>If any thresholds have been enabled for a numeric sensor, the sensor reading falls between the lower and upper warning thresholds.</li> <li>For a discrete (on/off) sensor, the sensor state is normal.</li> <li>The sensor is unavailable.</li> </ul>
Yellow	<p>The reading drops below the lower warning threshold or rises above the upper warning threshold.</p>
Red	<p>The meaning of the red color varies depending on the sensor type:</p> <ul style="list-style-type: none"> <li>For a numeric sensor, this color indicates the reading drops below the lower critical threshold or rises above the upper critical threshold.</li> <li>For a discrete (on/off) sensor, this color indicates the sensor is in the "alarmed" state.</li> <li>For an overcurrent protector sensor, it means the circuit breaker has tripped or the fuse has blown.</li> </ul>

To find the exact meaning of the alert, read the information shown in the State (or Status) column:

- below lower critical: The numeric sensor's reading drops below the lower critical threshold.
- below lower warning: The numeric sensor's reading drops below the lower warning threshold.
- above upper critical: The numeric sensor's reading reaches or exceeds the upper critical threshold.
- above upper warning: The numeric sensor's reading reaches or exceeds the upper warning threshold.
- alarmed: The discrete sensor is NOT in the normal state.
- Open: The circuit breaker has tripped or the fuse has blown.

For information on the thresholds, see **Setting Power Thresholds** (on page 192) and **Configuring Environmental Sensors or Actuators** (on page 259).

### Changing the View of a List

Some dialogs and data pages contain a list or table, such as the Manage Users dialog shown below. You may change the number of displayed columns or re-sort the list for better viewing the data. Note the column or sorting changes are not saved when quitting the dialog or data page. Next time when the dialog or page re-opens, the list returns to the default view.

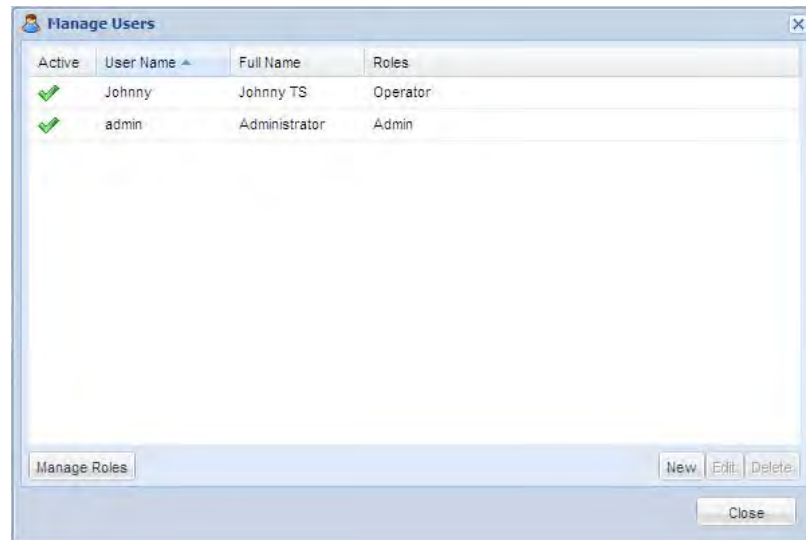

---

*Note: Not all dialogs support the sorting or column change functions.*

---



**Changing the Column**

You can hide some columns of a list or table, or adjust a specific column's width.

► **To change displayed columns:**

1. Hover your mouse pointer over any column header. A black triangle  appears to the far right of this column header.
2. Click the black triangle, and a drop-down menu appears.
3. Point to Columns. A submenu showing all columns appears.
4. Click any column you want to deselect or select.
  - To hide a column, have its checkbox deselected.
  - To show a column, have its checkbox selected.



► **To change the column width:**

1. Hover the mouse pointer to the right border of the desired column.
2. When the mouse pointer turns to a two-way arrow, drag the border horizontally to widen or shrink the column.

**Changing the Sorting**

By default, a list or table is sorted against the first column in the ascending order. You can re-sort the list in a reverse order or against a different column.

► **To re-sort the list by doing either of the following:**

- Click the column header against which you want to sort the list.
  - a. The first click sorts the list in the ascending order, indicated by a blue upward-pointing triangle .
  - b. The second click reverses the sorting to the descending order, indicated by a blue downward-pointing triangle .
- Select a sorting command from the column menu.
  - a. Hover your mouse pointer over the column header against which you want to sort the list. A black triangle  appears to the far right of this column header.
  - b. Click the black triangle, and a drop-down menu appears.
  - c. Select Sort Ascending or Sort Descending.

The newly selected column header is marked with the upward- or downward-pointing triangle.

### Resizing a Dialog

Most dialogs cannot be resized except for a few ones (such as the Event Log dialog), which can be resized to display more information at a time.

► **To resize a dialog:**

1. Hover your mouse pointer over any border of the dialog.
2. When the mouse pointer turns to a double-headed arrow, drag the border vertically or horizontally to make the dialog bigger or smaller.

### Browser-Defined Shortcut Menu

A shortcut menu, which is built in the web browser, may appear when right-clicking anywhere in the PX web interface.

The shortcut menu functions are defined by the browser. For example, the Back command on the Internet Explorer® (IE) shortcut menu works the same as the Back button in the IE browser. Both of these functions take you to the previous page.

For information on each shortcut menu command or item, see the online help or documentation accompanying your web browser.

Below is the illustration of the IE browser's shortcut menu. Available menu commands or items may slightly differ based on your web browser version.



---

## Viewing the Dashboard

When you log in to the web interface, the Dashboard page is displayed by default. This page provides an overview of the PX device's status.

The page is divided into various sections according to the component type, such as inlet(s), outlets, circuit breakers and alerted sensors.

---

*Note: If a sensor row is colored, it means the sensor reading already crosses one of the thresholds, the sensor enters an alarmed state, or the overcurrent protector has tripped or blown. See **The Yellow- or Red-Highlighted Sensors** (on page 83).*

---

After clicking any other icon in the hierarchical tree, the Dashboard page is overridden. To return to the Dashboard page, click the Dashboard icon.

When the Dashboard page is opened, you can do the following to uncover or hide specific data.

► **To collapse any section:**

1. Locate the section you want to collapse.
2. Click the upward arrow  prior to the section title. The data specific to the section is hidden.

► **To expand a collapsed section:**

1. Locate the section you want to expand.
2. Click the downward arrow  prior to the section title. The data specific to the section appears.

---

### Alerted Sensors

One of the sections on the Dashboard page only displays critical or warning conditions detected by internal or external sensors so that you are alerted to take actions. This section is labeled Alerted Sensors.

The Alerted Sensors section lists any or all of the following:

- Any sensor that enters the warning or critical range if the thresholds have been enabled
- Discrete (on/off) sensors that enter the alarmed state

- Any tripped circuit breakers or blown fuses

Sensor	Reading	State
Inlet 11 L1-L2 RMS Voltage	427 V	above upper warning
Temperature 1	20.7 °C	below lower warning
Temperature 2	20.2 °C	below lower warning
On/Off 1		alarmed

For the background color meanings in this section, see **The Yellow- or Red-Highlighted Sensors** (on page 83).

### Alarms List

You can create event rules that request users to acknowledge certain alerts, and resend alert notifications if the acknowledgment action is not taken yet. See **Creating Actions** (on page 200).

If any of these alerts has not been acknowledged since its occurrence, the Alarms section on the dashboard shows this alert until it is acknowledged. All alerts on the Alarms section are highlighted in red.

Below is the illustration of the alarms list.

Name	Reason	First Appearance	Last Appearance	Count	More Alerts	
Alarm - mail	Peripheral device 'Temperature 1' in slot '1' unavailable.	5/11/13 5:19 AM	5/11/13 5:19 AM	1	2 more reasons	<a href="#">Details</a>
Alarm - SMS message	Peripheral device 'Temperature 2' in slot '3' asserted 'above upper critical at 77.8 deg F.	5/11/13 5:36 AM	5/11/13 5:36 AM	1	-	<a href="#">Details</a>

The following table explains each column of the alarms list.

Column	Description
Name	The customized name of the Alarm action.
Reason	The first event that triggers the alert.
First Appearance	The date and time when the event indicated in the Reason column occurred for the first time.
Last Appearance	The date and time when the event indicated in the Reason column occurred for the last time.
Count	The number of times the event indicated in the Reason column has occurred.
More Alerts	<ul style="list-style-type: none"> <li>▪ A dash is displayed when there is only one event triggering this alert.</li> <li>▪ If there are other types of events triggering the same alert, the total number of these additional reasons is displayed. You can double click that alarm to view a list of all events that have occurred.</li> </ul>

Column	Description
Details	Click "Details" to trigger a dialog showing both the alarm details and the acknowledgment button.

Only users who have the Acknowledge Alarms permission can manually acknowledge an alarm.

► **To acknowledge an alarm:**

1. Double-click the alarm that you want to acknowledge, or click Details in the final column. A dialog appears.
2. Click Acknowledge Alarm to acknowledge it. That alarm then disappears from the Alarms section.

---

*Tip: When browsing through all events, you can sort the list of all events shown in the dialog by clicking the header row. See **Changing the View of a List** (on page 84).*

---



---

## Device Management

Using the web interface, you can retrieve basic hardware and software information, give the PX a new device name, set the system date and time, and modify network settings that were entered during the initial configuration process.

## Displaying PDU Information

To display information specific to the PX device that you are using, such as inlet or outlet types, trigger the Device Information dialog.

► **To display PDU-specific information:**

1. Choose Maintenance > Device Information. The Device Information dialog appears. Information is categorized by type into tabbed sections.

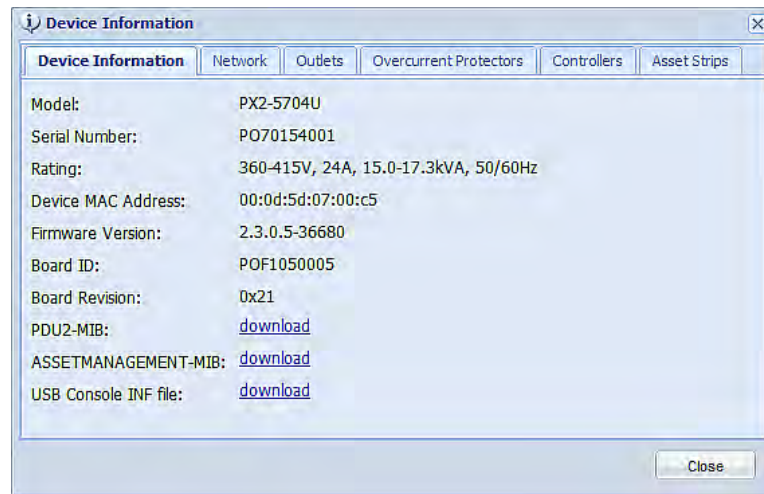

2. Click a tab to view type-specific information. The number of available tabs varies according to the model you purchased.

Tab	Data
Device Information	General PDU information, such as model name, serial number, firmware version, hardware revision, and so on.
Network	The PDU specific network information, such as the current networking mode, IPv4 and/or IPv6 addresses and so on.  This tab also indicates whether the PDU is part of an USB-cascading configuration. See <b>Identifying Cascaded Devices</b> (on page 91).
Outlets	Each outlet's receptacle type, operating voltage and rated current.
Controllers	Each outlet controller's serial number, board ID, firmware version and hardware version.
Inlets	Each inlet's plug type, rated voltage and

Tab	Data
	current.
Overcurrent Protectors	Each overcurrent protector's type, rated current and the outlets that it protects.
Peripheral Devices	Serial numbers, model names and firmware-related information of connected external devices, such as environmental sensors.
Asset Strips	Each asset sensor's ID, boot version, application version and protocol version.

3. Enlarge the dialog if necessary.
4. You can re-sort the list. See **Changing the Sorting** (on page 85).
5. Click Close to quit the dialog.

---

*Tip: The firmware version is also available by clicking the PDU folder in the PX Explorer pane.*

---

### Identifying Cascaded Devices

This section explains how to identify a cascaded PX in the Device Information dialog.

For information on how to cascade devices using USB cables, see **Cascading the PX via USB** (on page 25).

---

*Note: For more information on the USB-cascading configuration, see the USB-Cascading Solution Guide, which is available from Raritan website's **PX2 Support Files page** (<https://www.raritan.com/support/product/px2/px2-support-files>).*

---

#### ► To identify the USB-cascading status of a PX device:

1. Choose Maintenance > Device Information. The Device Information dialog appears.
2. Select the Network tab and locate the Interface section. The Interface section contains four read-only fields as listed below.

Fields	Description
Networking Mode	<p>Indicates how the PX is connected to the LAN.</p> <ul style="list-style-type: none"> <li>▪ Wired: The device is connected to the LAN through a standard network cable.</li> <li>▪ Wireless: The device is connected to the LAN through a supported USB wireless LAN adapter. See <b>USB Wireless LAN Adapters</b> (on page 18).</li> <li>▪ XXX (USB): XXX represents Wired or Wireless. The device is connected to the LAN through a USB-cascading configuration. That is, it is a slave device.</li> </ul>
Cascading Mode	Shows the cascading mode applied. See <b>Setting the Cascading Mode</b> (on page 119).
Cascade Position	<p>Indicates the position of the PX in the USB-cascading configuration.</p> <ul style="list-style-type: none"> <li>▪ 0 (zero) represents the master device.</li> <li>▪ A non-zero number represents a slave device. 1 is Slave 1, 2 is Slave 2, 3 is Slave 3 and so on.</li> </ul> <p>This field is NOT available on a standalone PX.</p>
Cascaded Device Connected	<p>Indicates whether the presence of a slave device is detected on the USB-A port.</p> <ul style="list-style-type: none"> <li>▪ yes: Connection to a slave device is detected.</li> <li>▪ no: NO connection to a slave device is detected.</li> </ul>



- A master device shows 0 (zero) in the Cascade Position field and yes in the Cascaded Device Connected field.

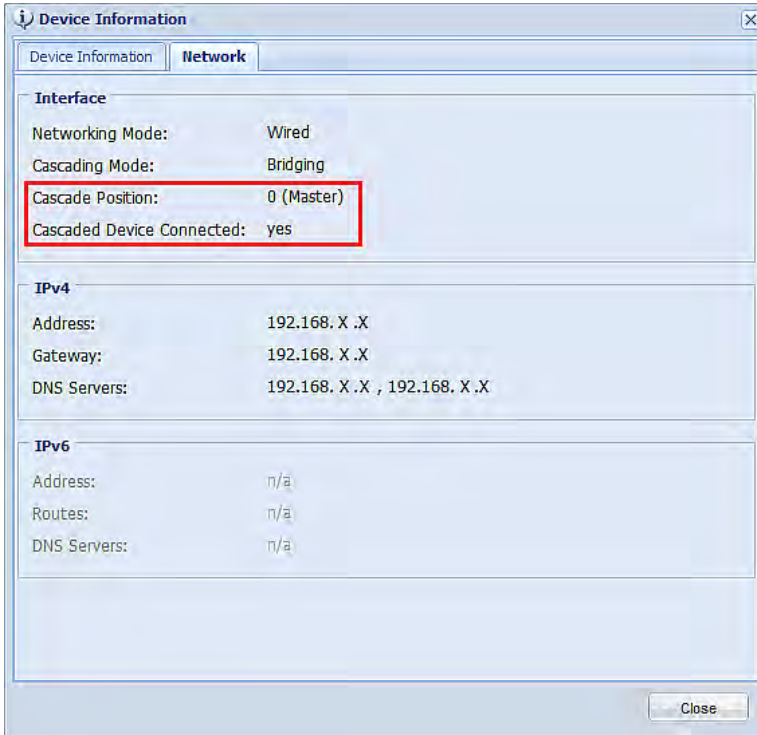

The screenshot shows a web interface window titled "Device Information" with a "Network" tab selected. The "Interface" section contains the following fields:

Networking Mode:	Wired
Cascading Mode:	Bridging
Cascade Position:	0 (Master)
Cascaded Device Connected:	yes

Below the Interface section, the "IPv4" section shows:

Address:	192.168. X .X
Gateway:	192.168. X .X
DNS Servers:	192.168. X .X , 192.168. X .X

The "IPv6" section shows:

Address:	n/a
Routes:	n/a
DNS Servers:	n/a

A "Close" button is located at the bottom right of the window.

- A slave device in the middle position shows a non-zero number which indicates its exact position in the Cascade Position field and yes in the Cascaded Device Connected field.

The following diagram shows 1, indicating it is the first slave - Slave 1.

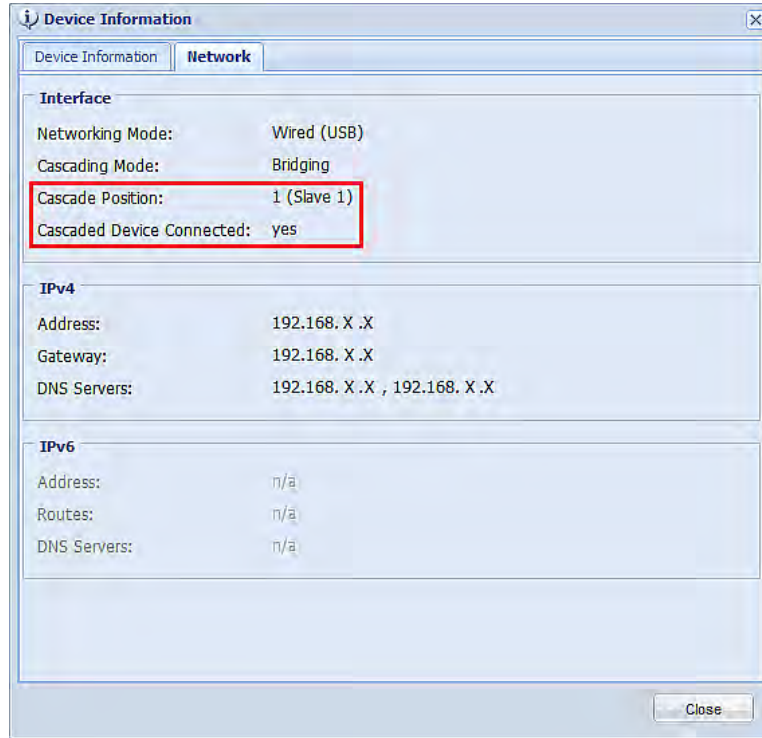

- The final slave device shows a non-zero number which indicates its position in the Cascade Position field and *no* in the Cascaded Device Connected field.

The following diagram shows 2, indicating it is the second slave - Slave 2. The Cascaded Device Connected field shows *no*, indicating that it is the final one in the chain.

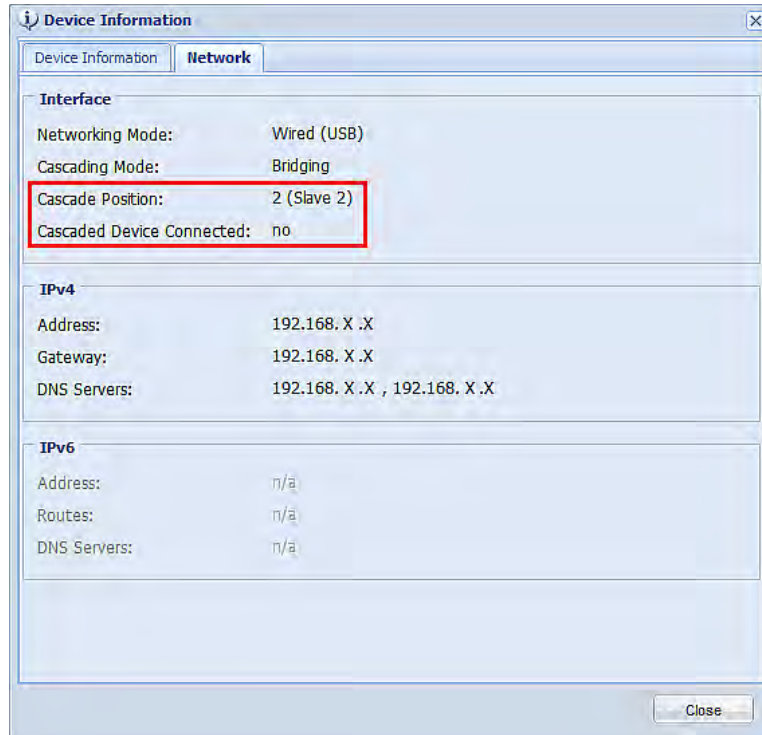

---

### Naming the PDU

The default name for PX is *my PX*. You may give it a unique device name.

#### ► To change the device name:

1. Click the PDU folder in the PX Explorer pane to open the PDU page.
2. Click Setup in the Settings section. The Pdu Setup dialog appears.
3. Type a new name in the Device Name field.
4. Click OK.

---

### Modifying the Network Configuration

The network settings you can change via the web interface include wired, wireless, IPv4 and/or IPv6 settings.

### Modifying Network Interface Settings

The PX supports two types of network interfaces: wired and wireless. You should configure the network interface settings according to the networking mode that applies. See **Connecting the PX to Your Network** (on page 17).

#### Wired Network Settings

The LAN interface speed and duplex mode were set during the initial configuration process.

By default, the LAN speed and duplex mode are set to "Auto" (automatic), which works in nearly all scenarios. You can change them if there are special local requirements.

#### ► To modify the network interface settings:

1. Choose Device Settings > Network. The Network Configuration dialog appears.
2. The Interface Settings tab should have been selected. If not, click the Interface Settings tab.
3. In the Network Interface field, click the drop-down arrow, and select Wired from the list.
4. To change the LAN speed, click the drop-down arrow in the Speed field and select an option from the list.
  - Auto: System determines the optimum LAN speed through auto-negotiation.
  - 10 Mbit/s: The LAN speed is always 10 Mbps.
  - 100 Mbit/s: The LAN speed is always 100 Mbps.
5. To change the duplex mode, click the drop-down arrow in the Duplex field and select an option from the list.
  - Auto: The PX selects the optimum transmission mode through auto-negotiation.
  - Full: Data is transmitted in both directions simultaneously.
  - Half: Data is transmitted in one direction (to or from the PX device) at a time.
6. Click OK.

---

*Tip: You can check the LAN status in the Current State field, including the speed and duplex mode.*

---

### Wireless Network Settings

Wireless SSID, PSK and BSSID parameters were set during the installation and configuration process. You can change them via the web interface.

---

*Note for USB-cascading configuration: Port forwarding mode over wireless LAN is supported as of release 3.1.0. You must upgrade all devices in the chain to version 3.1.0 or later if wireless networking is preferred. See **Cascading the PX via USB** (on page 25).*

---

► **To modify the wireless interface settings:**

1. Choose Device Settings > Network. The Network Configuration dialog appears.
2. The Interface Settings tab should have been selected. If not, click the Interface Settings tab.
3. In the Network Interface field, click the drop-down arrow, and select Wireless from the list.
4. Check the Hardware State field to ensure that the PX device has detected a wireless USB LAN adapter. If not, verify whether the USB LAN adapter is firmly connected or whether it is supported. See **Connecting the PX to Your Network** (on page 17).
5. Type the name of the wireless access point (AP) in the SSID field.
6. If the BSSID is available, select the Force AP BSSID checkbox, and type the MAC address in the BSSID field.

---

*Note: BSSID refers to the MAC address of an access point in the wireless network.*

---

7. In the Authentication field, select an appropriate option from the drop-down list.

Options	Description
No Authentication	Select this option when no authentication data is required.
PSK	A Pre-Shared Key is required for this option. <ul style="list-style-type: none"> <li>▪ In the Pre-Shared Key field, type the PSK string.</li> </ul>

Options	Description
EAP - PEAP	<p>PEAP stands for Protected Extensible Authentication Protocol.</p> <p>Enter the following authentication data:</p> <ul style="list-style-type: none"> <li>▪ Inner Authentication: Only Microsoft's Challenge Authentication Protocol Version 2 (MSCHAPv2) is supported, allowing authentication to databases that support MSCHAPv2.</li> <li>▪ Identity: Type your user name.</li> <li>▪ Password: Type your password.</li> <li>▪ CA Certificate: A third-party CA certificate may or may not be needed. If needed, follow the step below.</li> </ul>

8. When the PEAP authentication requires a CA certificate, do the following:
  - a. Select the "Enable Verification of TLS Certificate Chain" checkbox for the PX to verify the validity of the TLS certificate that will be installed. For example, the PX will check the certificate's validity period against the system time.
  - b. Click Browse to select a TLS certificate file. Then you can:
    - Click Show to view the certificate's contents.
    - Click Remove to delete the installed certificate if it is inappropriate.
  - c. Select the "Allow expired and not yet valid certificates" checkbox if intending to make the wireless network connection successful even though the installed TLS certificate chain contains any certificate that is outdated or not valid yet.
  - d. Select the "Allow wireless connection if system clock is incorrect" checkbox to make the wireless network connection successful when the PX system time is earlier than the firmware build before synchronizing with any NTP server. If the system time is incorrect, the installed TLS certificate is considered not valid yet and will cause the wireless network connection to fail while this checkbox is not selected.
 

The incorrect system time issue may occur when the PX has once been powered off for a long time.
9. Click OK.

## Modifying Network Settings

The PX was configured for network connectivity during the installation and configuration process. See **Configuring the PX** (on page 14). If necessary, you can modify any network settings using the web interface.

### Selecting the Internet Protocol

The PX device supports two types of Internet protocols -- IPv4 and IPv6. You can enable either or both protocols. After enabling the desired Internet protocol(s), all but not limited to the following protocols will be compliant with the enabled Internet protocol(s):

- LDAP
- NTP
- SMTP
- SSH
- Telnet
- FTP
- SSL/TLS
- SNMP
- SysLog

#### ► To select the appropriate Internet Protocol:

1. Choose Device Settings > Network. The Network Configuration dialog appears.
2. Click the IP Protocol tab.
3. Select one checkbox according to the Internet protocol(s) you want to enable:
  - IPv4 only: Enables IPv4 only on all interfaces. This is the default.
  - IPv6 only: Enables IPv6 only on all interfaces.
  - IPv4 and IPv6: Enables both IPv4 and IPv6 on all interfaces.
4. If you selected the "IPv4 and IPv6" checkbox in the previous step, you must determine which IP address is used when the DNS resolver returns both IPv4 and IPv6 addresses.
  - IPv4 Address: Use the IPv4 addresses returned by the DNS server.
  - IPv6 Address: Use the IPv6 addresses returned by the DNS server.
5. Click OK.

**Modifying IPv4 Settings**

You must enable the IPv4 protocol before you can modify the IPv4 network settings. See **Selecting the Internet Protocol** (on page 99).

► **To modify IPv4 settings:**

1. Choose Device Settings > Network. The Network Configuration dialog appears.
2. Click the IPv4 Settings tab.
3. In the IP Auto Configuration field, click the drop-down arrow, and select the desired option from the list.

Option	Description
DHCP	<p>To auto-configure the PX, select DHCP.</p> <p>With DHCP selected, you can enter a preferred DHCP host name, which is optional. Type the host name in the Preferred Hostname field.</p> <p>The host name:</p> <ul style="list-style-type: none"> <li>▪ Consists of alphanumeric characters and/or hyphens</li> <li>▪ Cannot begin or end with a hyphen</li> <li>▪ Cannot contain more than 63 characters</li> <li>▪ Cannot contain punctuation marks, spaces, and other symbols</li> </ul> <p>Select the "Specify DNS server manually" checkbox if necessary. Then type the address of the primary DNS server in the Primary DNS Server field. The secondary DNS server and DNS suffix are optional.</p>
Static	<p>To manually assign an IP address, select Static, and enter the following information in the corresponding fields:</p> <ul style="list-style-type: none"> <li>▪ IP address</li> <li>▪ Netmask</li> <li>▪ Default gateway</li> <li>▪ Primary DNS server</li> <li>▪ Secondary DNS server (optional)</li> <li>▪ DNS Suffix (optional)</li> </ul> <p>If your local network contains two subnets and IP forwarding has been enabled, you can click Append to add static routes so that your PX can communicate with the other subnet. Each static route requires:</p>



Option	Description
	<ul style="list-style-type: none"> <li>▪ Destination: IP address of the other subnet and subnet mask using the format "IP address/subnet mask."</li> <li>▪ Next Hop: IP address of the next hop router.</li> </ul> <p>See <b>Static Route Examples</b> (on page 103) for illustrations.</p>

4. Click OK.

---

*Note: The PX supports a maximum of 3 DNS servers. If two IPv4 DNS servers and two IPv6 DNS servers are available, the PX only uses the primary IPv4 and IPv6 DNS servers.*

---

### **Modifying IPv6 Settings**

You must enable the IPv6 protocol before you can modify the IPv6 network settings. See **Selecting the Internet Protocol** (on page 99).

#### **► To modify IPv6 settings:**

1. Choose Device Settings > Network. The Network Configuration dialog appears.
2. Click the IPv6 Settings tab.
3. In the IP Auto Configuration field, click the drop-down arrow, and select the desired option from the list.

Option	Description
Automatic	<p>To auto-configure the PX, select Automatic.</p> <p>With this option selected, you can enter a preferred host name, which is optional. Type the host name in the Preferred Hostname field.</p> <p>The host name:</p> <ul style="list-style-type: none"> <li>▪ Consists of alphanumeric characters and/or hyphens</li> <li>▪ Cannot begin or end with a hyphen</li> <li>▪ Cannot contain more than 63 characters</li> <li>▪ Cannot contain punctuation marks, spaces, and other symbols</li> </ul> <p>Select the "Specify DNS server manually" checkbox if necessary. Then type the address of the primary DNS server in the Primary DNS Server field. The secondary DNS server and DNS suffix are optional.</p>
Static	<p>To manually assign an IP address, select Static, and enter the following information in the corresponding fields:</p>

Option	Description
	<ul style="list-style-type: none"> <li>▪ IP address</li> <li>▪ Default gateway</li> <li>▪ Primary DNS server</li> <li>▪ Secondary DNS server (optional)</li> <li>▪ DNS Suffix (optional)</li> </ul> <p>If your local network contains two subnets and IP forwarding has been enabled, you can click Append to add static routes so that your PX can communicate with the other subnet. Each static route requires:</p> <ul style="list-style-type: none"> <li>▪ Destination: IP address of the current subnet and prefix length using the format "IP address/prefix."</li> <li>▪ Next Hop: IP address of the next hop router.</li> </ul> <p>See <b>Static Route Examples</b> (on page 103) for illustrations.</p>

4. Click OK.

---

*Note: The PX supports a maximum of 3 DNS servers. If two IPv4 DNS servers and two IPv6 DNS servers are available, the PX only uses the primary IPv4 and IPv6 DNS servers.*

---

**Static Route Examples**

This section has two static route examples: IPv4 and IPv6. Both examples assume that two network interface controllers (NIC) have been installed in one network server, leading to two available subnets, and IP forwarding has been enabled. All of the NICs and PX devices in the examples use static IP addresses.

► **IPv4 example:**

- Your PX: *192.168.100.64*
- Two NICs: *192.168.200.75* and *192.168.100.88*
- Two networks: *192.168.200.0* and *192.168.100.0*
- Subnet mask: *24*

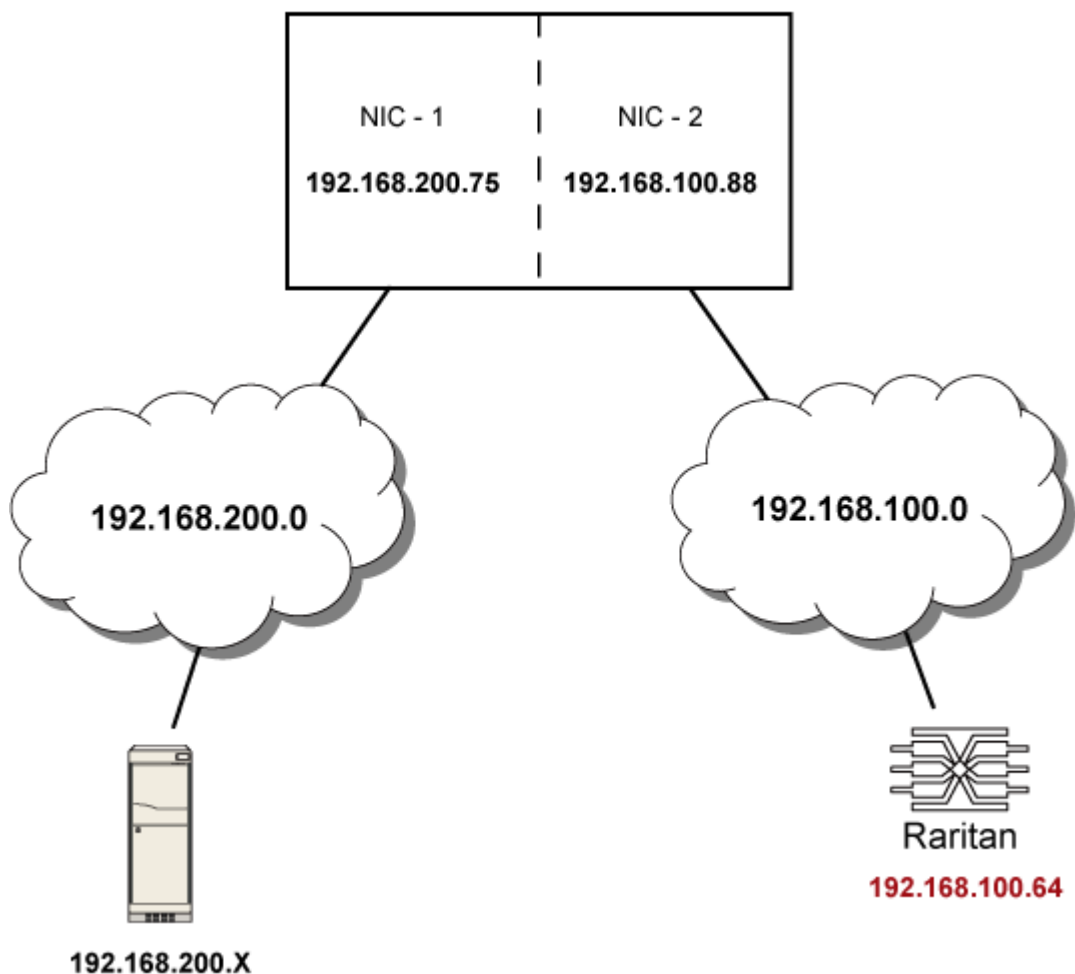

In this example, NIC-2 (192.168.100.88) is the next hop router for your PX to communicate with any device in the other subnet 192.168.200.0. In the IPv4 "Append new Route" dialog, you should specify:

- Destination: 192.168.200.0/24
- Next Hop: 192.168.100.88

► **IPv6 example:**

- Your PX: *fd07:2fa:6cff:2405::30*
- Two NICs: *fd07:2fa:6cff:1111::50* and *fd07:2fa:6cff:2405::80*
- Two networks: *fd07:2fa:6cff:1111::0* and *fd07:2fa:6cff:2405::0*
- Prefix length: 64

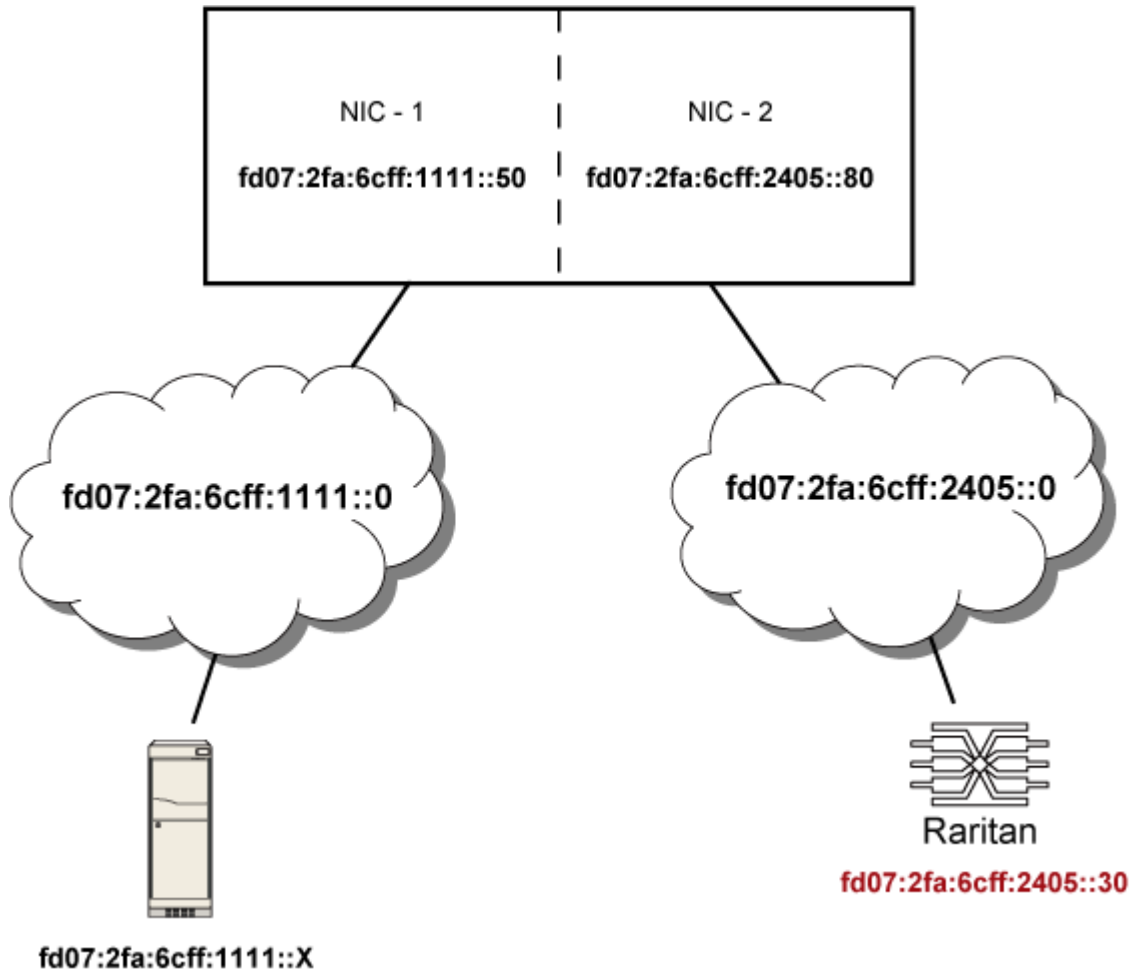

In this example, NIC-2 (fd07:2fa:6cff:2405::80) is the next hop router for your PX to communicate with any device in the other subnet fd07:2fa:6cff:1111::0. In the IPv6 'Append new Route' dialog, you should specify:

- Destination: fd07:2fa:6cff:2405::0/64
- Next Hop: fd07:2fa:6cff:2405::80

#### **Role of a DNS Server**

As Internet communications are carried out on the basis of IP addresses, appropriate DNS server settings are required for mapping domain names (host names) to corresponding IP addresses, or the PX may fail to connect to the given host.

Therefore, DNS server settings are important for external authentication. With appropriate DNS settings, the PX can resolve the external authentication server's name to an IP address for establishing a connection. If the *SSL/TLS encryption* is enabled, the DNS server settings become critical since only fully qualified domain name can be used for specifying the LDAP server.

For information on external authentication, see **Setting Up External Authentication** (on page 162).

---

#### **Modifying Network Service Settings**

The PX supports these network communication services: HTTPS, HTTP, Telnet and SSH.

HTTPS and HTTP enable the access to the web interface, and Telnet and SSH enable the access to the command line interface. See **Using the Command Line Interface** (on page 317).

By default, SSH is enabled, Telnet is disabled, and all TCP ports for supported services are set to standard ports. You can change default settings if necessary.

---

*Note: Telnet access is disabled by default because it communicates openly and is thus insecure.*

---

In addition, the PX also supports the SNMP and Modbus/TCP protocols.

#### **Changing HTTP(S) Settings**

---

**Important: Raritan disables SSL 3.0 and uses TLS for releases 3.0.4, 3.0.20 and later releases due to published security vulnerabilities in SSL 3.0. Make sure your network infrastructure, such as LDAP and mail services, uses TLS rather than SSL 3.0.**

---

HTTPS uses Transport Layer Security (TLS) technology to encrypt all traffic to and from the PX device so it is a more secure protocol than HTTP.

By default, any access to the PX device via HTTP is automatically redirected to HTTPS. You can disable this redirection if needed.

► **To change HTTP or HTTPS port settings:**

1. Choose Device Settings > Network Services > HTTP. The HTTP Settings dialog appears.
2. To use a different port for HTTP or HTTPS, type a new port number in the corresponding field. Valid range is 1 to 65535.

---

*Warning: Different network services cannot share the same TCP port.*

---

3. Enable or disable either or both ports.
  - To enable or disable the HTTP port, select or deselect the "HTTP access" checkbox.
  - To enable or disable the HTTPS port, select or deselect the "HTTPS access" checkbox.

► **To enable or disable HTTPS redirection:**

In the HTTP Settings dialog, the "Enforce use of HTTPS (redirect to HTTPS)" checkbox determines whether the HTTP access to the PX is redirected to HTTPS.

- To enable the redirection, select the checkbox.
- To disable the redirection, deselect the checkbox.

---

*Note: The redirection checkbox is configurable only when both HTTP and HTTPS ports have been enabled.*

---

### Changing SSH Settings

You can enable or disable the SSH access to the command line interface, or change the default TCP port for the SSH service. In addition, you can decide to log in using either the password or the public key over the SSH connection.

► **To change SSH service settings:**

1. Choose Device Settings > Network Services > SSH. The SSH Settings dialog appears.
2. To use a different port, type a new port number in the port field. Valid range is 1 to 65535.

3. To enable the SSH application, select the Enable SSH Access checkbox. To disable it, deselect the checkbox.
4. To select a different authentication method, select one of the checkboxes.
  - Password authentication only: Enables the password-based login only.
  - Public key authentication only: Enables the public key-based login only.
  - Password and public key authentication: Enables both the password- and public key-based login. This is the default.
5. Click OK.

If the public key authentication is selected, you must type a valid SSH public key for each user profile to log in over the SSH connection. See ***Creating a User Profile*** (on page 132).

#### **Changing Telnet Settings**

You can enable or disable the Telnet access to the command line interface, or change the default TCP port for the Telnet service.

##### **► To change Telnet service settings:**

1. Choose Device Settings > Network Services > Telnet. The Telnet Settings dialog appears.
2. To use a different port, type a new port number in the port field. Valid range is 1 to 65535.
3. To enable the Telnet application, select the Enable Telnet Access checkbox. To disable it, deselect the checkbox.
4. Click OK.

### Configuring SNMP Settings

You can enable or disable SNMP communication between an SNMP manager and the PX device. Enabling SNMP communication allows the manager to retrieve and control the power status of each outlet.

Besides, you may need to configure the SNMP destination(s) if the built-in "System SNMP Notification Rule" is enabled and the SNMP destination has not been set yet. See **Event Rules and Actions** (on page 199).

► **To configure SNMP communication:**

1. Choose Device Settings > Network Services > SNMP. The SNMP Settings dialog appears.

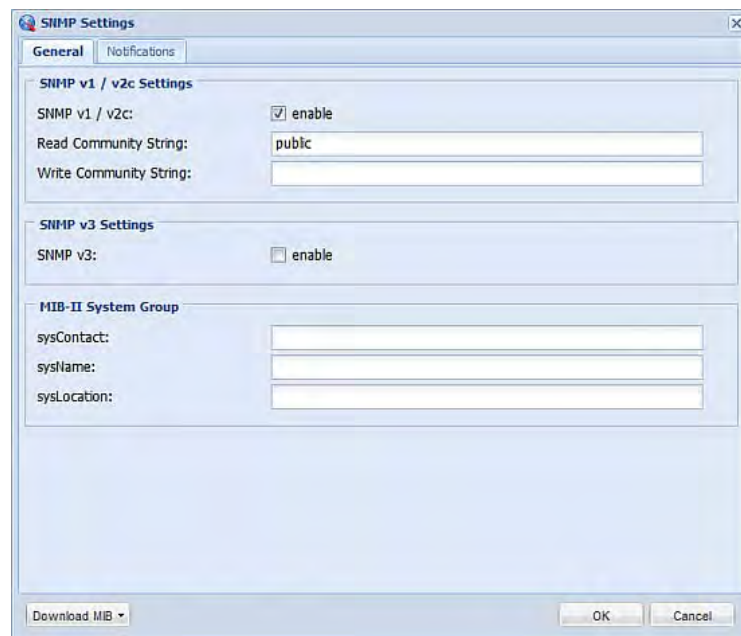

2. Select the "enable" checkbox in the "SNMP v1 / v2c" field to enable communication with an SNMP manager using SNMP v1 or v2c protocol.
  - Type the SNMP read-only community string in the Read Community String field. Usually the string is "public."
  - Type the read/write community string in the Write Community String field. Usually the string is "private."
3. Select the "enable" checkbox in the "SNMP v3" field to enable communication with an SNMP manager using SNMP v3 protocol.



---

*Tip: You can permit or disallow a user to access the PX via the SNMP v3 protocol. See **Configuring Users for Encrypted SNMP v3** (on page 307).*

---

4. Enter the MIB-II system group information, if applicable:
  - a. sysContact - the contact person in charge of the system being contacted
  - b. sysName - the name assigned to the system
  - c. sysLocation - the location of the system
5. Select the MIB to be downloaded. The SNMP MIB for your PX is used by the SNMP manager.

---

*Important: You must download the SNMP MIB for your PX to use with your SNMP manager. Click Download MIB in this dialog to download the desired MIB file. For more details, see **Downloading SNMP MIB** (on page 313).*

---

6. Click OK.

► **To configure SNMP notification destinations:**

1. Choose Device Settings > Network Services > SNMP. The SNMP Settings dialog appears.
2. Click the Notifications tab.
3. Select the Enabled checkbox.
4. Select an SNMP notification type - SNMP v2c Trap, SNMP v2c Inform, SNMP v3 Trap, and SNMP v3 Inform.
5. Specify the SNMP notification destinations by doing the following:
  - a. Specify the SNMP notification destinations in the Host field(s).
  - b. Specify a port number for the destination in the Port field(s).
  - c. Enter necessary information in other fields, such as the community string for SNMP Trap or authentication pass phrase for SNMP Inform. See **Send an SNMP Notification** (on page 209) for details.
6. Click OK.

---

*Tip: The SNMP notification destinations can be also set in the Event Rule Settings dialog. See **Modifying an Action** (on page 245).*

---

### Changing Modbus/TCP Settings

You can enable or disable the Modbus/TCP access to the PX or the read-only mode, or change the default TCP port for the Modbus service.

► **To change the Modbus service settings:**

1. Choose Device Settings > Network Services > Modbus. The Modbus Settings dialog appears.
2. To enable the Modbus access, select the Enable Modbus/TCP Access checkbox. To disable it, deselect the checkbox.
3. To use a different port, type a new port number in the port field. Valid range is 1 to 65535.
4. To enable the Modbus read-only mode, select the "Enable read-only mode" checkbox. To disable it, deselect the checkbox.

### Enabling Service Advertisement

The PX advertises all enabled services that are reachable using the IP network. This feature uses DNS-SD (Domain Name System-Service Discovery) and mDNS (multicast DNS). The advertised services are discovered by clients that have implemented DNS-SD and mDNS.

The advertised services include the following:

- HTTP
- HTTPS
- Telnet
- SSH
- Modbus
- json-rpc
- SNMP

This feature is enabled by default. The service advertisement feature supports both IPv4 and IPv6 protocols.

If you have set a preferred host name for IPv4 and/or IPv6, that host name can be used as the zero configuration .local host name, that is, `<preferred_host_name>.local`, where `<preferred_host_name>` is the preferred host name you have specified for PX. The IPv4 host name is the first priority. If an IPv4 host name is not available, then use the IPv6 host name.

---

*Note: For information on configuring IPv4 and/or IPv6 network settings, see **Modifying Network Settings** (on page 99).*

---

#### ► To enable service advertisement:

1. Choose Device Settings > Network Services to select the Service Advertisement checkbox.
2. Click Yes on the confirmation message to switch to zero configuration advertising. The feature is enabled and the Service Advertisement checkbox is selected in the submenu.

#### ► To disable service advertisement:



1. Choose Device Settings > Network Services to deselect the Service Advertisement checkbox.
2. Click Yes on the confirmation message to switch off the zero configuration advertising. The feature is disabled and the Service Advertisement checkbox is deselected in the submenu.

---

## Setting the Date and Time

Set the internal clock on the PX device manually, or link to a Network Time Protocol (NTP) server and let it set the date and time for the PX.

► **To set the date and time:**

1. Choose Device Settings > Date/Time. The Configure Date/Time Settings dialog appears.
2. In the Time Zone field, click the drop-down arrow, and select your time zone from the list.
3. If the daylight saving time applies to your time zone, verify the Automatic Daylight Saving Time Adjustment checkbox is selected.  
If the daylight saving time rules are not available for the selected time zone, the checkbox is not configurable.
4. Choose one of the methods to set the date and time:
  - To customize the date and time, select the User Specified Time radio button, and then enter the date and time in appropriate fields. Use the yyyy-mm-dd format for the date and the hh:mm:ss format for the time.
    - To set the date, delete existing numbers in the Date field and type new ones, or click the calendar icon  to select a date.
    - The time is measured in 24-hour format so enter 13 for 1:00pm, 14 for 2:00pm, and so on. You can enter the time by deleting existing numbers and typing new ones in the hour, minute and second fields, or clicking the arrows   to adjust each number.
  - To let an NTP server set the date and time, select the "Synchronize with NTP Server" radio button. There are two ways to assign the NTP servers.

- To use the DHCP-assigned NTP servers, make sure the "Always use the servers below and ignore DHCP-provided servers" checkbox is deselected. This method is usable only when either IPv4 or IPv6 DHCP is enabled.
- To use the NTP servers that are manually specified, select the "Always use the servers below and ignore DHCP-provided servers" checkbox, and specify the primary NTP server in the First Time Server field. A secondary NTP server is optional.  
You may click Check NTP Servers to verify the validity and accessibility of the specified NTP servers.

---

*Note: If the PX device's IP address is assigned through IPv4 or IPv6 DHCP, the NTP servers can be automatically discovered. When this occurs, the data you entered in the fields of First and Second Time Server will be overridden.*

---

5. Click OK.

The PX follows the NTP server sanity check per the IETF RFC. If your PX has problems synchronizing with a Windows NTP server, see **Windows NTP Server Synchronization Solution** (on page 115).

---

*Note: If you are using Raritan's Power IQ to manage the PX, you must configure Power IQ and the PX to have the same date/time or NTP settings.*

---



### How to Use the Calendar

The calendar icon  next to the Date field is a convenient tool to quickly change the year, month and date.





#### ► To select a date using the calendar:

1. To change the year shown in the calendar, do either of the following:

- Press Ctrl+Up arrow or Ctrl+Down arrow to switch between years.
- Click , which is adjacent to the year, to show a list of years and months. Select the desired year from the list to the right and click OK. If the list does not show the desired year, click  or  to show additional years.



2. To change the month shown in the calendar, do one of the following:
  - Press Ctrl+Right arrow or Ctrl+Left arrow to switch between months.
  - Click  or  on the top of the calendar to switch between months.
  - Click , which is adjacent to the year, to show a list of years and months. Select the desired month from the list to the left and click OK.
3. To select a date, click that date on the calendar.
  - Click Today if you want to select today.

---

*Note: On the calendar, the date for today is marked with a red frame.*

---

### Windows NTP Server Synchronization Solution

The NTP client on the PX follows the NTP RFC so the PX rejects any NTP servers whose root dispersion is more than one second. An NTP server with a dispersion of more than one second is considered an inaccurate NTP server by the PX.

---

*Note: For information on NTP RFC, visit*

**<http://tools.ietf.org/html/rfc4330> <http://tools.ietf.org/html/rfc4330> to refer to the section 5.**

---

Windows NTP servers may have a root dispersion of more than one second, and therefore cannot synchronize with the PX. When the NTP synchronization issue occurs, change the dispersion settings to resolve it.

► **To change the Windows NTP's root dispersion settings:**

1. Access the registry settings associated with the root dispersion on the Windows NTP server.

*HKEY\_LOCAL\_MACHINE\SYSTEM\CurrentControlSet\Services\W32Time\Config*

2. *AnnounceFlags* must be set to 0x05 or 0x06.
  - 0x05 = 0x01 (Always time server) and 0x04 (Always reliable time server)
  - 0x06 = 0x02 (Automatic time server) and 0x04 (Always reliable time server)

---

*Note: Do NOT use 0x08 (Automatic reliable time server) because its dispersion starts at a high value and then gradually decreases to one second or lower.*

---

3. *LocalClockDispersion* must be set to 0.

---

### Setting Default Measurement Units

Default measurement units are applied to the PX web and CLI interfaces across all users, including users accessing the device via external authentication servers. Default units apply only when users have not set their own preferred measurement units or the administrator has not changed preferred units for any user.

---

*Note: To set preferred measurement units for your own, see **Setting Up Your Preferred Measurement Units** (on page 137). If your preferences are different from the default measurement units, your preferences rather than the defaults apply to the PX user interfaces after you log in.*

---

► **To set up default user preferences:**

1. Choose User Management > Default User Preferences.
2. Update any of the following as needed:
  - In the Temperature Unit field, select °C (Celsius) or °F (Fahrenheit) as the measurement unit for temperatures.
  - In the Length Unit field, select "Meter" or "Feet" as the measurement unit for length or height.
  - In the Pressure Unit field, select "Pascal" or "psi" as the measurement unit for pressure.
3. Click OK.



## Configuring the Feature Port

The PX device supports connecting one of the following devices to its FEATURE port:

- Raritan Computer Interface Module (CIM) for KVM access. See ***Dominion KX II Configuration*** (on page 568).
- Raritan asset management sensors (asset sensors). See ***Connecting the Asset Management Sensor*** (on page 40).
- Raritan serial access products, including Dominion KSX II or SX. See ***Dominion KSX II or SX Configuration*** (on page 573).
- External beeper. See ***Connecting an External Beeper*** (on page 54).
- Schroff® LHX-20, SHX-30 or LHX-40 heat exchanger. See ***Connecting a Schroff LHX/SHX Heat Exchanger*** (on page 54).

By default, the FEATURE port can automatically detect and display the device connected to the FEATURE port. The only exception is the Schroff® LHX/SHX device, which requires enabling the LHX/SHX support before the PX can detect or display it. See ***Managing the Schroff LHX/SHX Heat Exchanger*** (on page 291).

You can change the mode applied to the FEATURE port so that the PX web interface only displays the device in the manner you wish.

### ► To configure the FEATURE port:

1. Click the Feature Port folder. The Feature Port page opens in the right pane.
2. Select the Port# 1 device on the Feature Port page, and click Setup. The Feature Port Setup dialog appears.
3. Select the desired mode in the Detection Mode field.
  - Auto: The PX automatically detects and displays the device connected to the FEATURE port. This is the default.
  - Disabled: The FEATURE port is disabled so the PX does not detect and display the connected device.
  - A specific device type: The PX always displays the selected device type no matter which device is connected or whether the selected device is detected or not. After selecting a device type, the Mode column shows "Pinned." Available device types are listed below.

Device type	Description
Asset Strip	Raritan asset sensors.
External Beeper	An external beeper with the RJ-45 socket.

Device type	Description
Power CIM	Select this type when connecting one of the following Raritan products: <ul style="list-style-type: none"> <li>Raritan power CIM, D2CIM-PWR. This CIM is used to connect the PX to the Raritan digital KVM switch, Dominion KX II.</li> <li>Dominion KSX II</li> <li>Dominion SX</li> </ul>
LHX 20	Schroff® LHX-20 heat exchanger. All Schroff® SHX/LHX device types are available only after the LHX/SHX support is enabled. See <b>Enabling and Disabling Schroff LHX/SHX Heat Exchanger Support</b> (on page 292).
SHX 30	Schroff® SHX-30 heat exchanger.
LHX 40	Schroff® LHX-40 heat exchanger.

- Click OK.

---

### Configuring the Serial Port

You can change the bit-rate of the serial port labeled CONSOLE / MODEM on the PX device. The default bit-rate for both console and modem operation is 115200 bps.

The PX supports the use of one of the following devices via the serial interface:

- A computer or a Raritan's KVM product for console management.
- An analog modem for remote dial-in and access to the CLI.
- A GSM modem for sending out SMS messages to a cellular phone.

Bit-rate adjustment may be necessary. Change the bit-rate before connecting the supported device to the PX through the serial port, or there are communication problems.

---

*Note: The serial port bit-rate change is needed when the PX works in conjunction with Raritan's Dominion LX KVM switch. The Dominion LX only supports 19200 bps for communications over the serial interface.*

---

You can set diverse bit-rate settings for console and modem operations. The PX can detect the type of the connected device, and automatically apply the preset bit-rate.

► **To change the serial port baud rate settings:**

- Choose Device Settings > Serial Port Settings. The Serial Port Configuration dialog appears.

- In the Console Baud Rate field, select the baud rate intended for console management.

---

*Note: For a serial RS-232 or USB connection between a computer and the PX, leave it at the default (115200 bps).*

---

- In the Modem Baud Rate field, select the baud rate used for the modem connected to the PX.

► **To configure the analog modem settings:**

- Click the Analog Modem tab.
- Select the "Answer incoming calls" checkbox to enable the remote access via a modem. Otherwise, deselect this checkbox.
- Specify the number of rings the PX must wait before answering the call. You can either type a value or click the Up/Down arrow keys to adjust the value in the "Number of rings until answering" field.

► **To configure the GSM modem settings:**

- Click the GSM Modem tab.
- Enter the SIM PIN.
- Select 'Use custom SMS center number' if a custom SMS will be used.
- Enter the SMS center number in the SMS Center field.
- Click Advanced Information to show information.
- Enter the number of the recipient's phone in the Recipients Phone field, then click Send SMS Test to send a test SMS message.

---

### Setting the Cascading Mode

A maximum of eight PX devices can be cascaded using USB cables and therefore share only one Ethernet connection. See **Cascading the PX via USB** (on page 25).

The Ethernet sharing mode applied to the USB-cascading configuration is either network bridging or port forwarding. This mode is determined by the master device.

Only the Admin user or a user who has the Administrator Privileges permission can configure the cascading mode.

To apply the "Port Forwarding" cascading mode, all cascaded PX devices must be upgraded to version 2.5.20 or later, or those devices not supporting the "Port Forwarding" mode cannot be accessed over the network. See **Updating the PX Firmware** (on page 300).

► **To configure the cascading mode:**

- Log in to the master device's web interface.

2. Choose Device Settings > USB Cascading. The USB Cascading Configuration dialog appears.
3. Verify that the "Position in cascaded chain" field shows 0 (Master), indicating that this PX is the master device.
4. Select the preferred cascading mode in the "Cascading mode" field.
  - Bridging: Each device in the USB-cascading configuration is accessed with a different IP address. This is the default.
  - Port Forwarding: Each device in the USB-cascading configuration is accessed with the same IP address with a different port number assigned. The port numbers vary based on the networking protocol and device position in the chain. See **Port Number Syntax** (on page 121).

---

*Note: If reversing or disconnecting the USB cable from a slave device, causing the slave device to become a master or standalone device, you must plug an Ethernet cable to it to update its USB-cascading status.*

---

5. Click OK.
6. If selecting Port Forwarding, a list of port numbers for diverse networking protocols will be available on the "Protocol to Port Mapping" tab of each cascaded device.

Return to the same dialog and click the "Protocol to Port Mapping" tab to view the master device's port numbers.

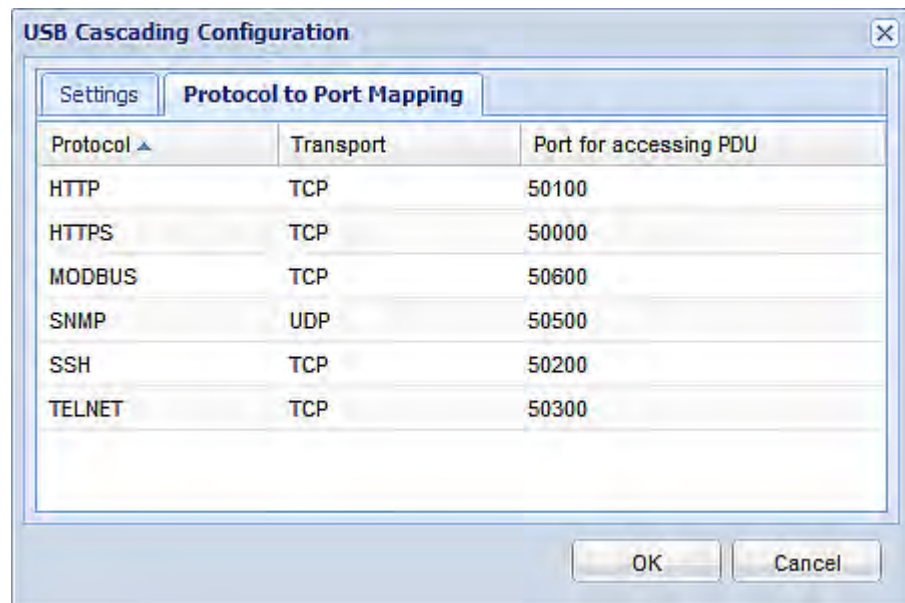

For information on accessing each cascaded device in the Port Forwarding mode, see **Port Forwarding Examples** (on page 122).

### Port Number Syntax

In the Port Forwarding mode, all devices in the USB-cascading configuration share the same IP address. To access any cascaded device, you must assign an appropriate port number to it.

- Master device: The port number is either *5NNXX* or the standard TCP/UDP port.
- Slave device: The port number is *5NNXX*.

► **5NNXX port number syntax:**

- NN is a two-digit number representing the network protocol as shown below:

Protocols	NN
HTTPS	00
HTTP	01
SSH	02
TELNET	03
SNMP	05
MODBUS	06

- XX is a two-digit number representing the device position as shown below:

Position	XX
Master device	00
Slave 1	01
Slave 2	02
Slave 3	03
Slave 4	04
Slave 5	05
Slave 6	06
Slave 7	07

For example, to access the Slave 4 device via Modbus/TCP, the port number is 50604. See **Port Forwarding Examples** (on page 122) for further illustrations.

---

*Tip: The full list of each cascaded device's port numbers can be retrieved from the web interface. See **Setting the Cascading Mode** (on page 119).*

---

► **Standard TCP/UDP ports:**

The master device can be also accessed through standard TCP/UDP ports as listed in the following table.

Protocols	Port Numbers
HTTPS	443
HTTP	80
SSH	22
TELNET	23
SNMP	161
MODBUS	502

In the Port Forwarding mode, the PX does NOT allow you to modify the standard TCP/UDP port configuration, including HTTP, HTTPS, SSH, Telnet, SNMP and Modbus/TCP.

**Port Forwarding Examples**

To access a cascaded device in the Port Forwarding mode, assign a port number to the IP address.

- Master device: Assign proper 5NNXX port numbers or standard TCP/UDP ports. See **Port Number Syntax** (on page 121) for details.
- Slave device: Assign proper 5NNXX port numbers.

**Assumption:** *The Port Forwarding mode is applied to a USB-cascading configuration comprising three Raritan products. The IP address is 192.168.84.77.*

► **Master device:**

Position code for the master device is 00 so each port number is 5NN00 as shown below.

Protocols	Port numbers
HTTPS	50000
HTTP	50100

Protocols	Port numbers
SSH	50200
TELNET	50300
SNMP	50500
MODBUS	50600

#### Examples using "5NN00" ports:

- To access the master device via HTTPS, the IP address is:  
*https://192.168.84.77:50000/*
- To access the master device via HTTP, the IP address is:  
*http://192.168.84.77:50100/*
- To access the master device via SSH, the command is:  
*ssh -p 50200 192.168.84.77*

#### Examples using standard TCP/UDP ports:

- To access the master device via HTTPS, the IP address is:  
*https://192.168.84.77:443/*
- To access the master device via HTTP, the IP address is:  
*http://192.168.84.77:80/*
- To access the master device via SSH, the command is:  
*ssh -p 22 192.168.84.77*

#### ► Slave 1 device:

Position code for Slave 1 is 01 so each port number is 5NN01 as shown below.

Protocols	Port numbers
HTTPS	50001
HTTP	50101
SSH	50201
TELNET	50301
SNMP	50501
MODBUS	50601

#### Examples:

- To access Slave 1 via HTTPS, the IP address is:  
*https://192.168.84.77:50001/*

- To access Slave 1 via HTTP, the IP address is:  
*http://192.168.84.77:50101/*
- To access Slave 1 via SSH, the command is:  
*ssh -p 50201 192.168.84.77*

▶ **Slave 2 device:**

Position code for Slave 2 is 02 so each port number is 5NN02 as shown below.

Protocols	Port numbers
HTTPS	50002
HTTP	50102
SSH	50202
TELNET	50302
SNMP	50502
MODBUS	50602

**Examples:**

- To access Slave 2 via HTTPS, the IP address is:  
*https://192.168.84.77:50002/*
- To access Slave 2 via HTTP, the IP address is:  
*http://192.168.84.77:50102/*
- To access Slave 2 via SSH, the command is:  
*ssh -p 50202 192.168.84.77*



---

## Setting Data Logging

The PX can store 120 measurements for each sensor in a memory buffer. This memory buffer is known as the data log. Sensor readings in the data log can be retrieved using SNMP.

You can configure how often measurements are written into the data log using the Measurements Per Log Entry field. Since the PX internal sensors are measured every second, specifying a value of 60, for example, would cause measurements to be written to the data log once every minute. Since there are 120 measurements of storage per sensor, specifying a value of 60 means the log can store the last two hours of measurements before the oldest one in the log gets overwritten.

Whenever measurements are written to the log, three values for each sensor are written: the average, minimum and maximum values. For example, if measurements are written every minute, the average of all measurements that occurred during the preceding 60 seconds along with the minimum and maximum measurement values are written to the log.

---

*Note: The PX device's SNMP agent must be enabled for this feature to work. See **Enabling SNMP** (on page 306) for more details. In addition, using an NTP time server ensures accurately time-stamped measurements.*

---

## Enabling Data Logging

By default, data logging is disabled. Only users having the "Administrator" or "Change Pdu, Inlet, Outlet & Overcurrent Protector Configuration" permissions can enable or disable this feature. See **Setting Up Roles** (on page 138).

### ► To configure the data logging feature:

1. Choose Device Settings > Data Logging. The Data Logging Options dialog appears.
2. To enable the data logging feature, select the "enable" checkbox in the Enable Data Logging field.
3. Type a number in the Measurements Per Log Entry field. Valid range is from 1 to 600. The default is 60.
4. Verify that all sensor logging is enabled. If not, click Enable All to have all sensors selected.
5. Click OK.

---

**Important:** Although it is possible to selectively enable/disable logging for individual sensors on the PX in Step 4, it is NOT recommended and this capability may be removed in the future.

---

---

## Configuring SMTP Settings

The PX can be configured to send alerts or event messages to a specific administrator by email. To do this, you have to configure the SMTP settings and enter an IP address for your SMTP server and a sender's email address.

If any email messages fail to be sent successfully, the failure event and reason are available in the event log. See **Viewing the Local Event Log** (on page 246).

---

*Note: See **Event Rules and Actions** (on page 199) for information on creating event rules to send email notifications.*

---

► **To set SMTP server settings:**

1. Choose Device Settings > SMTP Server. The SMTP Server Settings dialog appears.
2. Type the name or IP address of the mail server in the Server Name field.
3. Type the port number for the SMTP server in the Port field. The default is 25.
4. Type an email address for the sender in the Sender Email Address field.
5. Type the number of email retries in the "Number of Sending Retries" field. The default is 2 retries.
6. Type the time interval between email retries in the "Time Interval Between Sending Retries (in minutes)" field. The time is measured in minutes. The default is 2 minutes.
7. If your SMTP server requires password authentication, do this:
  - a. Select the Server Requires Authentication checkbox.
  - b. Type a user name in the User Name field.
  - c. Type a password in the Password field.
8. If your SMTP server supports the Transport Layer Security (TLS), select the "Enable SMTP over TLS (StartTLS)" checkbox. Then do the following:
  - a. Click Browse to select the TLS CA certificate file. Then you may:
    - Click Show to view the installed certificate's contents.
    - Click Remove to delete the installed certificate if it is inappropriate.
  - b. Select or deselect the "Allow expired and not yet valid certificates" checkbox.

- To always send the email messages even though the installed certificate chain contains a certificate that is outdated or not valid yet, select this checkbox.
  - To prevent the email messages from being sent when any certificate in the installed certificate chain is outdated or not valid yet, deselect this checkbox.
9. Now that you have set the SMTP settings, you can test it to ensure it works properly. Do the following:
    - a. Type the recipient's email address in the Recipient Email Addresses field. Use a comma to separate multiple email addresses.
    - b. Click Send Test Email.
    - c. Check if the recipient(s) receives the email successfully.
  10. Click OK.

---

### Configuring Data Push Settings

If any Raritan asset sensors have been connected to PX, you can push the asset sensor data to a remote server for data synchronization. The data will be sent in JSON format using HTTP POST requests. You need to set up the destination and authentication for data push on the PX.





For instructions on connecting asset sensors, see **Connecting the Asset Management Sensor** (on page 40).

After configuring the destination and authentication settings, do either or both of the following:

- To perform the data push after the occurrence of a certain event, create the data push action and assign it to an event rule. See **Push Out Sensor Readings** (on page 206).
- To push the data at a regular interval, schedule the data push action. See **Scheduling an Action** (on page 225).

#### ► To configure data push settings:

1. Choose Device Settings > Data Push. The Data Push dialog appears.
2. Click New. The Add New Destination dialog appears.
3. In the URL field, determine the following information.
  - Click the arrow to select http or https.
  - Type the URL or host name in the accompanying text box.
4. If the destination server requires authentication, select the "Use authentication" checkbox, and provide the authentication information:
  - In the "User name" field, type the login name.
  - In the Password field, type the login password.

5. In the "Entry type" field, determine the data that will be transmitted.
  - Asset management information: Transmit the information of the specified asset sensor(s), including the general status of the specified sensor(s) and a list of asset tags on blade extension strips if any.
  - Asset management log: Transmit the log of all asset sensors, which is generated when there are changes made to asset tags and asset sensors, including asset tag connection or disconnection events.
6. If "Asset management information" is selected in the above step, specify the asset sensor(s) whose log to send. The PX has only one FEATURE port so only one asset sensor is available.
  - To specify the asset sensor, select it in the Available list box and click  (Add) or  (Add All).
  - To remove the asset sensor, select it in the Selected list box and click  (Remove) or  (Remove All).
7. Click OK.

---

### Specifying the Device Altitude

You must specify the PX device's altitude above sea level if a Raritan differential air pressure sensor is attached. This is because the device's altitude is associated with the altitude correction factor. See **Altitude Correction Factors** (on page 588).

The default altitude measurement unit is meter. You can have the measurement unit vary between meter and foot according to user credentials. See **Setting Up Your Preferred Measurement Units** (on page 137).

► **To specify the altitude of the PX device:**

1. Click the PDU folder.

---

*Note: The folder is named "my PX" by default. The name can be customized.*

---

2. Click Setup in the Settings section. The Pdu Setup dialog appears.
3. Type an integer number in the Altitude field. Depending on the measurement unit displayed, the range of valid numbers differs.
  - For meters (m), the value ranges between 0 and 3000.
  - For feet (ft), the value ranges between 0 and 9842.
4. Click OK.

---

## Rebooting the PX Device

You can remotely reboot the PX device via the web interface.

Resetting the PX does not interrupt the operation of connected servers because there is no loss of power to outlets. Outlets that have been powered on prior to the reset remain powered on and outlets that have been powered off remain powered off during and after the reset.

### ► To reboot the device:

1. Choose Maintenance > Unit Reset. The Reset Device dialog appears.

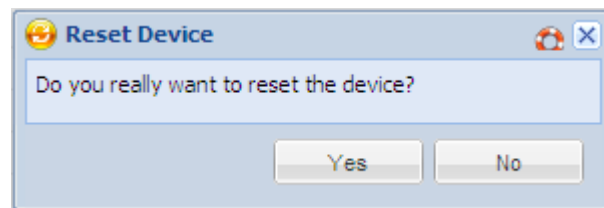

2. Click Yes to reset the PX.
3. A message appears with a countdown timer showing the remaining time of the operation. It takes about one minute to complete.
4. When the reset is complete, the Login page opens. Now you can log back in to the PX device.

---

*Note: If you are not redirected to the Login page after the reset is complete, click the underlined text "this link" in the message.*

---

---

## Resetting All Active Energy Readings

An active energy reading is a value of total accumulated energy, which is never reset, even if the power fails or the PX is reset. However, you can manually reset this reading to restart the energy accumulation process.

Only users with the "Admin" role assigned can reset active energy readings.

### ► To reset all active energy readings of the PX:

1. Click the PDU folder in the PX Explorer pane to open the PDU page.

---

*Note: The folder is named "my PX" by default. The name can be customized.*

---

2. Click Reset All Active Energy Counters in the Settings section.
3. Click Yes on the confirmation message. Now all 'Active Energy' readings on the PX are reset to 0 (zero) Wh.

---

*Tip: You can also reset the active energy readings of an individual inlet. See **Resetting Inlet Active Energy Readings** (on page 190). To reset the active energy readings of specific outlets only, see **Resetting Outlet Active Energy Readings** (on page 186).*

---

### Monitoring Total Active Energy or Power

This section applies only to multi-inlet models, including PX in-line monitors.

A PX device with multiple inlets has two additional sensors for reporting power-related readings at the PDU level: total active energy and total active power.

For a regular PX model with multiple inlets:

- Total active energy = sum of all inlets' active energy values
- Total active power = sum of all inlets' active power values

For an in-line monitor with multiple inlets/outlets:

- Total active energy = sum of all outlets' active energy values
- Total active power = sum of all outlets' active power values

---

*Tip: You can reset the active energy sensor(s) as needed. See **Resetting All Active Energy Readings** (on page 129).*

---

► **To view the total active energy and/or power of a multi-inlet PX:**

1. Click the PDU folder.

---

*Note: The folder is named "my PX" by default. The name can be customized.*

---

2. Locate the Power section in the right pane. Both values and states of Active Power and Active Energy are displayed.



Type	Value	State
Active Power	0 W	normal
Active Energy	76914 Wh	normal

---

### Checking the Internal Beeper State

The internal beeper can alert you if any overcurrent protector, including fuses and circuit breakers, has tripped or blown on the PX. See **Beeper** (on page 70). You can remotely check its state.

► **To check the PX beeper's state:**

1. Click the PDU folder.

---

*Note: The folder is named "my PX" by default. The name can be customized.*

---

2. Locate the "Internal Beeper" section in the right pane. Either of the following states is displayed.
  - Off: The beeper is turned off.
  - Active: The beeper is turned on. A field titled "Activation reason" appears below the beeper state, indicating why the beeper sounds an alarm.

---

*Tip: To check the internal beeper state via CLI, see **PDU Configuration** (on page 326).*

---

---

### Setting the EnergyWise Configuration

If a Cisco® EnergyWise energy management architecture is implemented in your place, you can enable the Cisco EnergyWise endpoint implemented on the PX device so that this device becomes part of the Cisco EnergyWise domain.

The Cisco EnergyWise feature implemented on the PX is disabled by default.

► **To set the Cisco EnergyWise configuration:**

1. Choose Device Settings > EnergyWise. The EnergyWise Configuration dialog appears.
2. In the Enable EnergyWise field, select the "enable" checkbox to enable the Cisco EnergyWise feature.
3. In the "Domain name" field, type the name of a Cisco EnergyWise domain where the PX belongs. The domain name comprises up to 127 printable ASCII characters.
  - Spaces and asterisks are NOT acceptable.
4. In the "Domain password" field, type the authentication password (secret) for entering the Cisco EnergyWise domain. The password comprises up to 127 printable ASCII characters.
  - Spaces and asterisks are NOT acceptable.

5. In the Port field, type a User Datagram Protocol (UDP) port number for communications in the Cisco EnergyWise domain. The port ranges from 1 to 65535. Default is 43440.
6. In the "Polling interval" field, type a polling interval to determine how often the PX is queried in the Cisco EnergyWise domain. The polling interval ranges from 30 to 600 seconds. Default is 180 seconds.
7. Click OK.

For PX2-3000, PX2-4000, and PX2-5000 series, the parent/child relationship is formed after the Cisco EnergyWise feature is enabled.

- The PDU becomes a parent domain member.
- All outlets become children of the PDU.

---

## User Management

The PX is shipped with one built-in user profile: **admin**, which is used for initial login and configuration. This profile has full permissions, and should be reserved for the system administrator. It cannot be deleted and its permissions are not user-configurable except for the SNMP v3 permission.

All users must have a user profile, which specifies a login name and password, and contains additional (optional) information about the user. Every user profile must have at least a role to determine the user's permissions. See **Setting Up Roles** (on page 138).

---

*Tip: By default, multiple users can log in simultaneously using the same login name.*

---

### Creating a User Profile

Creating new users adds a new login to the PX.

► **To create a user profile:**

1. Choose User Management > Users. The Manage Users dialog appears.
2. Click New. The Create New User dialog appears.
3. Type the information about the user in the corresponding fields. Note that User Name, Password and Confirm Password fields are required.

Field	Type this...
User Name	The name the user enters to log in to the PX. <ul style="list-style-type: none"><li>▪ The name can be 4 to 32 characters long.</li></ul>



Field	Type this...
	<ul style="list-style-type: none"> <li>▪ It is case sensitive.</li> <li>▪ Spaces are NOT permitted</li> </ul>
Full Name	The user's first and last names.
Password, Confirm Password	<p>The password the user enters to log in. Type it first in the Password field and then again in the Confirm Password field.</p> <ul style="list-style-type: none"> <li>▪ The password can be 4 to 64 characters long.</li> <li>▪ It is case sensitive.</li> <li>▪ Spaces are permitted.</li> </ul>
Telephone Number	A phone number where the user can be reached.
eMail Address	<p>An email address where the user can be reached.</p> <ul style="list-style-type: none"> <li>▪ The email can be up to 64 characters long.</li> <li>▪ It is case sensitive.</li> </ul>

4. Select the Enabled checkbox. This is required so the user can log in to the PX device.
5. Select the "Force password change on next login" checkbox if you prefer a password change by the user when the user logs in for the first time after this checkbox is enabled.
6. Click the SNMPv3 tab to set the SNMPv3 access permission. The permission is disabled by default.
  - a. To permit the SNMPv3 access by this user, select the "Enable SNMPv3 access" checkbox. Otherwise, leave the checkbox disabled.

---

*Note: The SNMPv3 protocol must be enabled for SNMPv3 access. See **Configuring SNMP Settings** (on page 108).*

---

- b. Set up SNMPv3 parameters if enabling the SNMPv3 access permission.

Field	Description
Security Level	<p>Click the drop-down arrow to select a preferred security level from the list:</p> <ul style="list-style-type: none"> <li>▪ NoAuthNoPriv: No authentication and no privacy.</li> <li>▪ AuthNoPriv: Authentication and no privacy.</li> </ul>

Field	Description
	<ul style="list-style-type: none"> <li>AuthPriv: Authentication and privacy. This is the default.</li> </ul>
Use Password as Authentication Pass Phrase	<p><i>This checkbox is configurable only if AuthNoPriv or AuthPriv is selected.</i></p> <p>When the checkbox is selected, the authentication pass phrase is identical to the user's password. To specify a different authentication pass phrase, disable the checkbox.</p>
Authentication Pass Phrase	<p>Type the authentication pass phrase in this field if the "Use Password as Authentication Pass Phrase" checkbox is disabled.</p> <p>The pass phrase must consist of 8 to 32 ASCII printable characters.</p>
Confirm Authentication Pass Phrase	Re-type the same authentication pass phrase for confirmation.
Use Authentication Pass Phrase as Privacy Pass Phrase	<p><i>This checkbox is configurable only if AuthPriv is selected.</i></p> <p>When the checkbox is selected, the privacy pass phrase is identical to the authentication pass phrase. To specify a different privacy pass phrase, disable the checkbox.</p>
Privacy Pass Phrase	<p>Type the privacy pass phrase in this field if the "Use Authentication Pass Phrase as Privacy Pass Phrase" checkbox is disabled.</p> <p>The pass phrase must consist of 8 to 32 ASCII printable characters.</p>
Confirm Privacy Pass Phrase	Re-type the same privacy pass phrase for confirmation.
Authentication Protocol	<p>Click the drop-down arrow and select the desired authentication protocol from the list. Two protocols are available:</p> <ul style="list-style-type: none"> <li>MD5</li> <li>SHA-1 (default)</li> </ul>
Privacy Protocol	<p>Click the drop-down arrow and select the desired privacy protocol from the list. Two protocols are available:</p> <ul style="list-style-type: none"> <li>DES (default)</li> <li>AES-128</li> </ul>

7. Click the SSH tab to enter the public key if the public key authentication for the SSH service is enabled. See **Changing SSH Settings** (on page 106).
  - a. Open the SSH public key with a text editor.
  - b. Copy and paste all contents in the text editor into the Public Key field on the SSH tab.
8. Click the Roles tab to determine the permissions of the user.
9. Select one or multiple roles by selecting corresponding checkboxes.
  - The Admin role provides full permissions.
  - The Operator role provides limited permissions for frequently-used functions. See **Setting Up Roles** (on page 138) for the scope of permissions. This role is selected by default.
  - If no roles meet your needs, you can:
    - *Modify the permissions of an existing role:* To modify the permissions of any role, double-click the role or highlight it and then click Edit Role. See **Modifying a Role** (on page 139).
    - *Create a new role by clicking the Manage Roles button:* See **Creating a Role** (on page 138).

---

*Note: With multiple roles selected, a user has the union of all roles' permissions.*

---

10. To change any measurement units displayed in the web interface and command line interface for this new user, click the Preferences tab, and do any of the following:
  - In the Temperature Unit field, select °C (Celsius) or °F (Fahrenheit) as the measurement unit for temperatures.
  - In the Length Unit field, select "Meter" or "Feet" as the measurement unit for length or height.
  - In the Pressure Unit field, select "Pascal" or "psi" as the measurement unit for pressure.

A Pascal is equal to one newton per square meter. Psi stands for pounds per square inch.

---

*Note: The measurement unit change only applies to the web interface and command line interface. Users can change the measurement units at any time by setting up their own user preferences. See **Setting Up Your Preferred Measurement Units** (on page 137).*

---

---

## Modifying a User Profile

You can change any user profile's information except for the user name.

► **To modify a user profile:**

1. Choose User Management > Users. The Manage Users dialog appears.
2. Select the user by clicking it.
3. Click Edit or double-click the user. The Edit User 'XXX' dialog appears, where XXX is the user name.
4. Make all necessary changes to the information shown.  
To change the password, type a new password in the Password and Confirm Password fields. If the password field is left blank, the password is not changed.
5. To change the SNMPv3 access permissions, click the SNMPv3 tab and make necessary changes. For details, see Step 6 of **Creating a User Profile** (on page 132).
6. To change the permissions, click the Roles tab and do one of these:
  - Select or deselect any role's checkbox.
  - To modify the permissions of any role, double-click the role or highlight it and then click Edit Role. See **Modifying a Role** (on page 139).
7. To change the measurement unit for temperature, length or pressure, click the Preferences tab, and select a different option from the drop-down list.

---

*Note: The measurement unit change only applies to the web interface and command line interface.*

---

8. Click OK.

---

## Deleting a User Profile

Delete outdated or redundant user profiles when necessary.

► **To delete user profiles:**

1. Choose User Management > Users. The Manage Users dialog appears.
2. Select the user you want to delete by clicking it. To make multiple selections, press Ctrl+click or Shift+click to highlight multiple ones.
3. Click Delete.
4. A message appears, prompting you to confirm the operation. Click Yes to confirm the deletion.

---

### Changing the User List View

You may change the number of displayed columns or re-sort the list for better viewing the data. See **Changing the View of a List** (on page 84).

---

### Setting Up Your Preferred Measurement Units

The measurement units used in your PX user interfaces can be changed according to your own preferences regardless of the permissions you have.

---

*Tip: Preferences can also be changed by administrators for specific users from the Preferences tab of the Manage Users dialog. See **Creating a User Profile** (on page 132).*

---

*Note: The measurement unit change only applies to the web interface and command line interface. Setting your preferences does not change the default measurement units, which apply to all users before any individual user or the administrator sets preferred measurement units on a per-user basis. See **Setting Default Measurement Units** (on page 116) for information on changing default measurement units.*

---

► **To change the measurement units applied to your PX graphical user interfaces:**

1. Choose User Management > User Preferences. The Setup User Preferences dialog opens.
2. Update any of the following as needed:
  - In the Temperature Unit field, select °C (Celsius) or °F (Fahrenheit) as the measurement unit for temperatures.
  - In the Length Unit field, select "Meter" or "Feet" as the measurement unit for length or height.
  - In the Pressure Unit field, select "Pascal" or "psi" as the measurement unit for pressure.
3. Click OK.

---

## Setting Up Roles

A role defines the operations and functions a user is permitted to perform or access. Every user must be assigned at least a role.

The PX is shipped with two built-in roles: **Admin** and **Operator**.

- The Admin role provides full permissions. You can neither modify nor delete this role.
- The Operator role provides limited permissions for frequently-used functions. You can modify or delete this role. By default, the Operator role contains these permissions:
  - Acknowledge Alarms
  - View Event Settings
  - View Local Event Log
  - Change Pdu, Inlet, Outlet & Overcurrent Protector Configuration
  - Change Own Password
  - Switch Outlet (all outlets)

---

*Note: PX2-3000 and PX2-4000 series are NOT outlet-switching capable so the "Switch Outlet" permission is not available.*

---

The Operator role is assigned to a newly created user profile by default. See **Creating a User Profile** (on page 132).

---

### Creating a Role

Create a new role when you need a new combination of permissions.

► **To create a role:**

1. Choose User Management > Roles. The Manage Roles dialog appears.

---

*Tip: You can also access the Manage Roles dialog by clicking the Manage Roles button in the Edit User 'XXX' dialog.*

---

2. Click New. The Create New Role dialog appears.
3. Type the role's name in the Role Name field.
4. Type a description for the role in the Description field.
5. Click the Privileges tab to assign one or multiple permissions.
  - a. Click Add. The "Add Privileges to new Role" dialog appears.
  - b. Select the permission you want from the Privileges list.

- c. If the permission you selected contains any argument setting, the Arguments list is shown to the right, such as the Switch Actuator permission. Then select one or multiple arguments.  
For example, if the Switch Outlet permission is selected, the Arguments list shows all outlets for you to determine which outlets this role can control. Select the desired outlets' checkboxes or select the checkbox labeled "all" if you want to select all outlets.
  - d. Click Add to add the selected permission (and arguments if any).
  - e. Repeat Steps a to d until you add all necessary permissions.
6. Click OK.

Now you can assign the new role to any users. See **Creating a User Profile** (on page 132) or **Modifying a User Profile** (on page 136).

---

### Modifying a Role

You can change an existing role's settings except for the name.

► **To modify a role:**

1. Choose User Management > Roles. The Manage Roles dialog appears.

---

*Tip: You can also access the Manage Roles dialog by clicking the Manage Roles button in the Edit User 'XXX' dialog.*

---

2. Select the role you want to modify by clicking it.
3. Click Edit or double-click the role. The Edit Role 'XXX' dialog appears, where XXX is the role name.

---

*Tip: You can also access the Edit Role 'XXX' dialog by clicking the Edit Role button in the Edit User 'XXX' dialog.*

---

4. Modify the text shown in the Description field if necessary.
5. To change the permissions, click the Privileges tab.

---

*Note: You cannot change the Admin role's permissions.*

---

6. To delete any permissions, do this:
  - a. Select the permission you want to remove by clicking it. To make multiple selections, press Ctrl+click or Shift+click to highlight multiple ones.
  - b. Click Delete.
7. To add any permissions, do this:
  - a. Click Add. The Add Privileges to Role 'XXX' dialog appears, where XXX is the role name.

- b. Select the permission you want from the Privileges list.
  - c. If the permission you selected contains any argument setting, the Arguments list is shown to the right, such as the Switch Actuator permission. Then select one or multiple arguments.  

For example, if the Switch Outlet permission is selected, the Arguments list shows all outlets for you to determine which outlets this role can control. Select the desired outlets' checkboxes or select the checkbox labeled "all" if you want to select all outlets.
  - d. Click Add to add the selected permission (and arguments if any).
  - e. Repeat Steps a to d until you add all necessary permissions.
8. To change a specific permission's arguments, do this:
- a. Select the permission by clicking it.
  - b. Click Edit. The "Edit arguments of privilege 'XXX'" dialog appears, where XXX is the privilege name.

---

*Note: If the permission you selected does not contain any arguments, the Edit button is disabled.*

---

- c. Select the argument you want. You can make multiple selections.
  - d. Click OK.
9. Click OK.

---

### Deleting a Role

You can delete any role other than the Admin role.

► **To delete a role:**

1. Choose User Management > Roles. The Manage Roles dialog appears.

---

*Tip: You can also access the Manage Roles dialog by clicking the Manage Roles button in the Edit User 'XXX' dialog.*

---

2. Select the role you want to delete by clicking it. To make multiple selections, press Ctrl+click or Shift+click to highlight multiple ones.
3. Click Delete.
4. A message appears, prompting you to confirm the operation. Click Yes to confirm the deletion.



---

### Changing the Role List View

You may re-sort the list for better viewing the data. See **Changing the View of a List** (on page 84).

---

## Access Security Control

The PX provides tools to control access. You can enable the internal firewall, create firewall rules, and create login limitations.

---

*Tip: You can also create and install the certificate or set up external authentication servers to control any access. See **Setting Up a TLS Certificate** (on page 156) and **Setting Up External Authentication** (on page 162).*

---

---

### Forcing HTTPS Encryption

You can force all accesses to the PX via HTTP to be redirected to HTTPS. See **Changing HTTP(S) Settings** (on page 105).

---

### Configuring the Firewall

The PX has a firewall that you can configure to prevent specific IP addresses and ranges of IP addresses from accessing the PX device or to prevent them from receiving any data from the PX.

The PX allows you to configure the firewall rules for inbound and outbound traffic respectively. Inbound rules control the data sent to the PX, and outbound rules control the data sent from the PX.

By default the firewall is disabled.

► **To configure the firewall:**

1. Enable the firewall. See **Enabling the Firewall** (on page 142).
2. Set the default policy. See **Changing the Default Policy** (on page 142).
3. Create firewall rules specifying which addresses to accept and which ones to discard. See **Creating Firewall Rules** (on page 143).

Changes made to firewall rules take effect immediately. Any unauthorized IP activities cease instantly.

---

*Note: The purpose of disabling the firewall by default is to prevent users from accidentally locking themselves out of the device.*

---

### Enabling the Firewall

The firewall rules, if any, take effect only after the firewall is enabled.

#### ► To enable the PX firewall:

1. Choose Device Settings > Security > IP Access Control. The Configure IP Access Control Settings dialog appears.
2. To enable the IPv4 firewall, click the IPv4 tab, and select the Enable IPv4 Access Control checkbox.
3. To enable the IPv6 firewall, click the IPv6 tab, and select the Enable IPv6 Access Control checkbox.
4. Click OK.

### Changing the Default Policy

After enabling the firewall, the default policy is to accept traffic from/to all IP addresses. This means only IP addresses discarded by a specific rule will NOT be permitted to access the PX or receive any data from the PX.

You can change the default policy to Drop or Reject, in which case traffic to/from all IP addresses is discarded except the IP addresses accepted by a specific rule.

Default policies for inbound and outbound traffic can be different.

#### ► To change the default policy for inbound traffic:

1. Choose Device Settings > Security > IP Access Control. The Configure IP Access Control Settings dialog appears.
2. To determine the default policy for IPv4 addresses:
  - a. Click the IPv4 tab if necessary.
  - b. Ensure the Enable IPv4 Access Control checkbox is selected.
  - c. Locate the Default Policy field in the Inbound Rules section.
  - d. The default policy is shown in the Default Policy field. To change it, select a different policy from the drop-down list.
    - Accept: Accepts traffic from all IPv4 addresses.
    - Drop: Discards traffic from all IPv4 addresses, without sending any failure notification to the source host.
    - Reject: Discards traffic from all IPv4 addresses, and an ICMP message is sent to the source host for failure notification.
3. To determine the default policy for IPv6 addresses:
  - a. Click the IPv6 tab.
  - b. Ensure the Enable IPv6 Access Control checkbox is selected.

- c. Locate the Default Policy field in the Inbound Rules section.
  - d. The default policy is shown in the Default Policy field. To change it, select a different policy from the drop-down list.
    - Accept: Accepts traffic from all IPv6 addresses.
    - Drop: Discards traffic from all IPv6 addresses, without sending any failure notification to the source host.
    - Reject: Discards traffic from all IPv6 addresses, and an ICMP message is sent to the source host for failure notification.
4. Click OK. The new default policy is applied.

► **To change the default policy for outbound traffic:**

Locate the Outbound Rules section on the IPv4 or IPv6 tab and then follow the above procedure to set up its Default Policy field by selecting one of the following options.

- Accept: Permits traffic sent from the PX to all IP addresses.
- Drop: Discards traffic sent from the PX to all IP addresses, without sending any failure notification to the destination host.
- Reject: Discards traffic sent from the PX to all IP addresses, and an ICMP message is sent to the destination host for failure notification.

### Creating Firewall Rules

Firewall rules determine whether to accept or discard traffic to/from the PX, based on the IP address of the host sending or receiving the traffic. When creating firewall rules, keep these principles in mind:

- **Rule order is important.**

When traffic reaches or is sent from the PX device, the rules are executed in numerical order. Only the first rule that matches the IP address determines whether the traffic is accepted or discarded. Any subsequent rules matching the IP address are ignored by the PX.

- **Subnet mask is required.**

When typing the IP address, you must specify BOTH the address and a subnet mask. For example, to specify a single address in a Class C network, use this format:

*x.x.x.x/24*

where /24 = a subnet mask of 255.255.255.0.

To specify an entire subnet or range of addresses, change the subnet mask accordingly.

---

*Note: Valid IPv4 addresses range from 0.0.0.0 through 255.255.255.255. Make sure the IPv4 addresses entered are within the scope.*

---

► **To create firewall rules:**

1. Choose Device Settings > Security > IP Access Control. The Configure IP Access Control Settings dialog appears.
2. Click the IPv4 tab for creating IPv4 firewall rules, or click the IPv6 tab for creating IPv6 firewall rules.
3. Ensure the Enable IPv4 Access Control checkbox is selected on the IPv4 tab, or the Enable IPv6 Access Control checkbox is selected on the IPv6 tab.
4. To set rules for inbound traffic, go to the Inbound Rules section. To set rules for outbound traffic, go to the Outbound Rules section.
5. Create specific rules. See the table for different operations.

Action	Procedure
Add a rule to the end of the rules list	<ul style="list-style-type: none"> <li>▪ Click Append. The "Append new Rule" dialog appears.</li> <li>▪ Type an IP address and subnet mask in the IP/Mask field.</li> <li>▪ Select Accept, Drop or Reject from the drop-down list in the Policy field.                             <ul style="list-style-type: none"> <li>▪ Accept: Accepts traffic from/to the specified IP address(es).</li> <li>▪ Drop: Discards traffic from/to the specified IP address(es), without sending any failure notification to the source or destination host.</li> <li>▪ Reject: Discards traffic from/to the specified IP address(es), and an ICMP message is sent to the source or destination host for failure notification.</li> </ul> </li> <li>▪ Click OK.</li> </ul> <p>The system automatically numbers the rule.</p>

Action	Procedure
Insert a rule between two existing rules	<ul style="list-style-type: none"><li>▪ Select the rule above which you want to insert a new rule. For example, to insert a rule between rules #3 and #4, select #4.</li><li>▪ Click Insert. The "Insert new Rule" dialog appears.</li><li>▪ Type an IP address and subnet mask in the IP/Mask field.</li><li>▪ Select Accept, Drop or Reject from the drop-down list in the Policy field.<ul style="list-style-type: none"><li>▪ Accept: Accepts traffic from/to the specified IP address(es).</li><li>▪ Drop: Discards traffic from/to the specified IP address(es), without sending any failure notification to the source or destination host.</li><li>▪ Reject: Discards traffic from/to the specified IP address(es), and an ICMP message is sent to the source or destination host for failure notification.</li></ul></li><li>▪ Click OK.</li></ul> <p>The system inserts the rule and automatically renumbers the following rules.</p>

- When finished, the rules appear in the Configure IP Access Control Settings dialog.

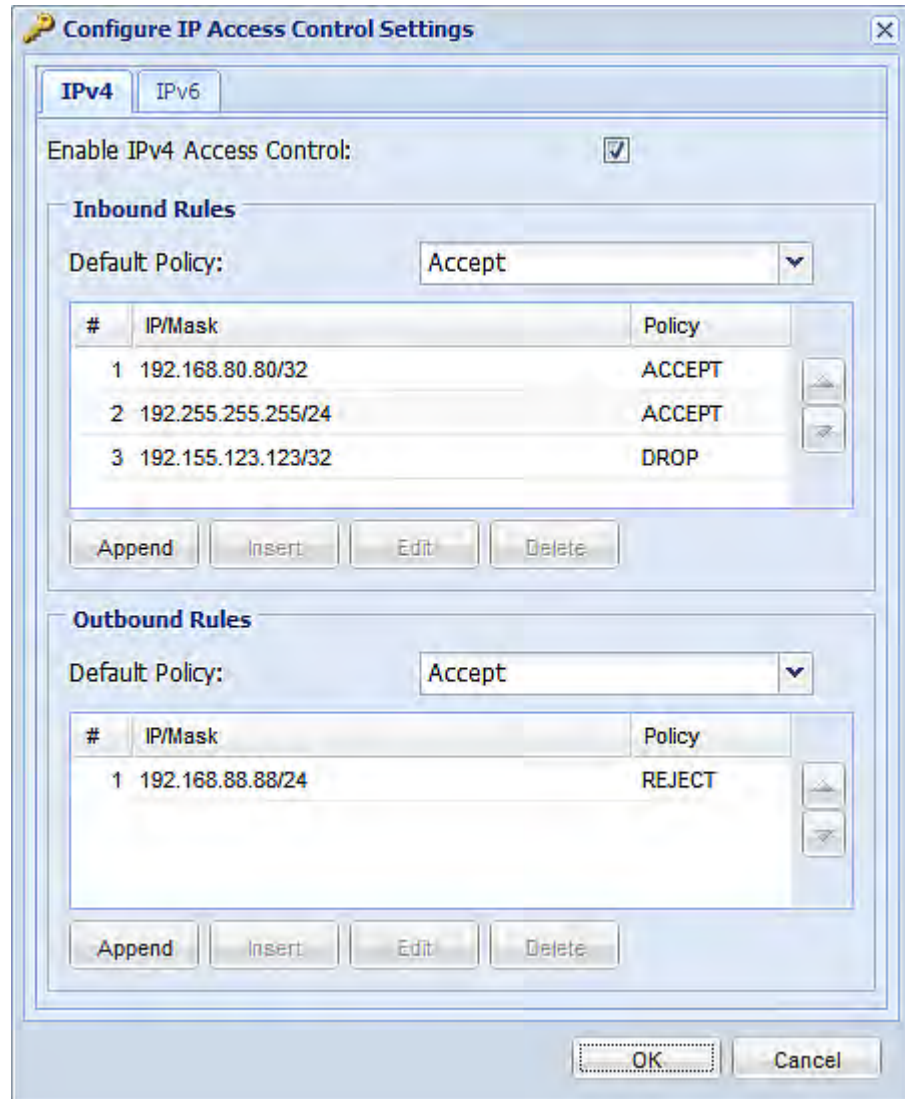

- Click OK. The rules are applied.

### Editing Firewall Rules

When an existing firewall rule requires updates of IP address range and/or policy, modify them accordingly.

► **To modify a firewall rule:**



- Choose Device Settings > Security > IP Access Control. The Configure IP Access Control Settings dialog appears.

2. To modify the IPv4 firewall rules, click the IPv4 tab. To modify the IPv6 firewall rules, click the IPv6 tab.
3. Ensure the Enable IPv4 Access Control checkbox is selected on the IPv4 tab, or the Enable IPv6 Access Control checkbox is selected on the IPv6 tab.
4. Select the rule to be modified in the rules list.
5. Click Edit or double-click the rule. The Edit Rule dialog appears.
6. Make changes to the information shown.
7. Click OK.
8. Click OK to quit the Configure IP Access Control Settings dialog, or the changes are lost.

### Sorting Firewall Rules

The rule order determines which one of the rules matching the same IP address is performed.

#### ► To sort the firewall rules:

1. Choose Device Settings > Security > IP Access Control. The Configure IP Access Control Settings dialog appears.
2. To sort the IPv4 firewall rules, click the IPv4 tab. To sort the IPv6 firewall rules, click the IPv6 tab.
3. Ensure the Enable IPv4 Access Control checkbox is selected on the IPv4 tab, or the Enable IPv6 Access Control checkbox is selected on the IPv6 tab.
4. Select a specific rule by clicking it.
5. Click  or  to move the selected rule up or down until it reaches the desired location.
6. Click OK.

### Deleting Firewall Rules

When any firewall rules become obsolete or unnecessary, remove them from the rules list.

#### ► To delete a firewall rule:

1. Choose Device Settings > Security > IP Access Control. The Configure IP Access Control Settings dialog appears.
2. To delete the IPv4 firewall rules, click the IPv4 tab. To delete the IPv6 firewall rules, click the IPv6 tab.

3. Ensure the Enable IPv4 Access Control checkbox is selected on the IPv4 tab, or the Enable IPv6 Access Control checkbox is selected on the IPv6 tab.
4. Select the rule that you want to delete. To make multiple selections, press Ctrl+click or Shift+click to highlight multiple ones.
5. Click Delete.
6. A message appears, prompting you to confirm the operation. Click Yes to remove the selected rule(s) from the rules list.
7. Click OK.

---

### Setting Up User Login Controls

You can set up login controls to make it more difficult for hackers to access the PX and the devices connected to it. You can arrange to lock persons out after a specified number of failed logins, limit the number of persons who log in using the same user name at the same time, and force users to create strong passwords.

#### Enabling User Blocking

User blocking determines how many times a user can attempt to log in to the PX and fail authentication before the user is blocked.

Note that this function applies only to local authentication instead of authentication through external AA servers.

---

*Note: If any user blocking event occurs, you can unblock that user manually by using the "unblock" CLI command via a local connection. See **Unblocking a User** (on page 474).*

---

#### ► To enable user blocking:

1. Choose Device Settings > Security > Login Settings. The Login Settings dialog appears.
2. Locate the User Blocking section.
3. To enable the user blocking feature, select the "Block user on login failure" checkbox.
4. Type a number in the "Maximum number of failed logins" field. This is the maximum number of failed logins the user is permitted before the user is blocked from accessing the PX device.
5. To determine how long the user's login is blocked, select the desired length of time from the drop-down list in the "Block timeout" field. The following describes available options.
  - Infinite: This option sets no time limit on blocking the login.



- X min: This type of option sets the time limit to X minutes, where X is a number.
- X h: This type of option sets the time limit to X hours, where X is a number.
- 1 d: This option sets the time limit to 1 day.

---

*Tip: If the desired time option is not listed, you can manually type the desired time in this field. For example, you can type "4 min" to set the time to 4 minutes.*

---

6. Click OK.

### Enabling Login Limitations

Login limitations determine whether more than one person can use the same login name at the same time, and how long users are permitted to stay idle before being forced to log out.

#### ► To enable login limitations:

1. Choose Device Settings > Security > Login Settings. The Login Settings dialog appears.
2. Locate the Login Limitations section.
3. To prevent more than one person from using the same login at the same time, select the "Prevent concurrent login with same username" checkbox.
4. To adjust how long users can remain idle before they are forcibly logged out by the PX, select a time option in the Idle Timeout Period field. The default is 10 minutes.
  - X min: This type of option sets the time limit to X minutes, where X is a number.
  - X h: This type of option sets the time limit to X hours, where X is a number.
  - 1 d: This option sets the time limit to 1 day.

---

*Tip: If the desired time option is not listed, you can manually type the desired time in this field. For example, you can type "4 min" to set the time to 4 minutes.*

---

5. Click OK.

---

*Tip: Keep the idle timeout to 20 minutes or less if possible. This reduces the number of idle sessions connected, and the number of simultaneous commands sent to the PX.*

---

### Enabling Strong Passwords

Use of strong passwords makes it more difficult for intruders to crack user passwords and access the PX device. By default, strong passwords should be at least eight characters long and contain upper- and lower-case letters, numbers, and special characters, such as @ or &.

► **To force users to create strong passwords:**

1. Choose Device Settings > Security > Password Policy. The Password Policy dialog appears.
2. Select the Strong Passwords checkbox to activate the strong password feature. The following are the default settings:

Minimum length	= 8 characters
Maximum length	= 32 characters
At least one lowercase character	= Required
At least one uppercase character	= Required
At least one numeric character	= Required
At least one special character	= Required
Number of restricted passwords in history	= 5

---

*Note: The maximum password length accepted by the PX is 64 characters.*

---

3. Make necessary changes to the default settings.
4. Click OK.

### Enabling Password Aging

Password Aging determines whether users are required to change passwords at regular intervals. The default is to disable this feature.

► **To force users to change passwords regularly:**

1. Choose Device Settings > Security > Password Policy. The Password Policy dialog appears.
2. Select the Password Aging checkbox to enable the password aging feature.
3. To determine how often users are requested to change their passwords, select a number of days in the Password Aging Interval field. Users are required to change their password every time when that number of days has passed.

---

*Tip: If the desired time option is not listed, you can manually type the desired time in this field. For example, you can type "9 d" to set the password aging time to 9 days.*

---

4. Click OK.

### Enabling and Editing the Security Banner

Use the PX restricted service agreement (security banner) if you want to require users to read and accept a security agreement when they log in to the PX.

A default agreement is provided. You can edit or replace the default text as needed by typing directly in the security dialog or pasting text into it.

A maximum of 10,000 characters can be entered or pasted into the security banner.

If a user declines the agreement, they cannot log in. An event notifying you if a user has accepted or declined the agreement can be created. See **Default Log Messages** (on page 227)

#### ► To enable the service agreement:

1. Click Device Services > Security > Restricted Service Agreement Banner. The Restricted Service Agreement Setup dialog opens.
2. Select the Enforce Restricted Service Agreement checkbox.
3. Edit the text or replace it as needed.
4. Click OK.

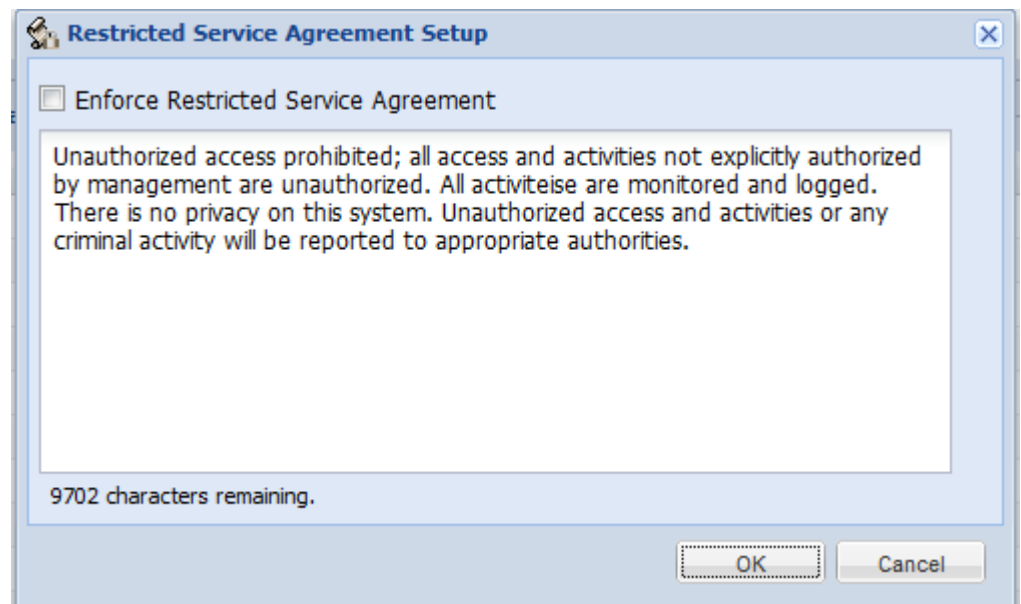

If the Restricted Service Agreement feature is enabled, the Restricted Service Agreement is displayed when any user logs in to the PX. Do either of the following, or you cannot successfully log in to the PX:

- In the web interface, select the checkbox labeled "I understand and accept the Restricted Service Agreement."

---

*Tip: To select the agreement checkbox using the keyboard, press the Space bar.*

---

- In the CLI, type `y` when the confirmation message "I understand and accept the Restricted Service Agreement" is displayed.

---

### Setting Up Role-Based Access Control Rules

Role-based access control rules are similar to firewall rules, except they are applied to members sharing a specific role. This enables you to grant system permissions to a specific role, based on their IP addresses.

#### ► To set up role-based access control rules:

1. Enable the feature. See **Enabling the Feature** (on page 152).
2. Set the default policy. See **Changing the Default Policy** (on page 153).
3. Create rules specifying which addresses to accept and which ones to discard when the addresses are associated with a specific role. See **Creating Role-Based Access Control Rules** (on page 153).

Changes made do not affect users currently logged in until the next login.

#### Enabling the Feature

You must enable this access control feature before any relevant rule can take effect.

#### ► To enable role-based access control rules:

1. Choose Device Settings > Security > Role Based Access Control. The Configure Role Based Access Control Settings dialog appears.
2. To enable the IPv4 firewall, click the IPv4 tab, and select the "Enable Role Based Access Control for IPv4" checkbox.
3. To enable the IPv6 firewall, click the IPv6 tab, and select the "Enable Role Based Access Control for IPv6" checkbox.
4. Click OK.

### Changing the Default Policy

The default policy is to accept all traffic from all IP addresses regardless of the role applied to the user.

► **To change the default policy:**

1. Choose Device Settings > Security > Role Based Access Control. The Configure Role Based Access Control Settings dialog appears.
2. To determine the default policy for IPv4 addresses:
  - a. Click the IPv4 tab if necessary.
  - b. Ensure the "Enable Role Based Access Control for IPv4" checkbox is selected.
  - c. Select the action you want from the Default Policy drop-down list.
    - Allow: Accepts traffic from all IPv4 addresses regardless of the user's role.
    - Deny: Drops traffic from all IPv4 addresses regardless of the user's role.
3. To determine the default policy for IPv6 addresses:
  - a. Click the IPv6 tab.
  - b. Ensure the "Enable Role Based Access Control for IPv6" checkbox is selected.
  - c. Select the action you want from the Default Policy drop-down list.
    - Allow: Accepts traffic from all IPv6 addresses regardless of the user's role.
    - Deny: Drops traffic from all IPv6 addresses regardless of the user's role.
4. Click OK.

### Creating Role-Based Access Control Rules

Role-based access control rules accept or drop traffic, based on the user's role and IP address. Like firewall rules, the order of rules is important, since the rules are executed in numerical order.

► **To create role-based access control rules:**

1. Choose Device Settings > Security > Role Based Access Control. The Configure Role Based Access Control Settings dialog appears.
2. Click the IPv4 tab for creating IPv4 firewall rules, or click the IPv6 tab for creating IPv6 firewall rules.

3. Ensure the "Enable Role Based Access Control for IPv4" checkbox is selected on the IPv4 tab, or the "Enable Role Based Access Control for IPv6" checkbox is selected on the IPv6 tab.
4. Create specific rules:

Action	Do this...
Add a rule to the end of the rules list	<ul style="list-style-type: none"> <li>▪ Click Append. The "Append new Rule" dialog appears.</li> <li>▪ Type a starting IP address in the Starting IP Address field.</li> <li>▪ Type an ending IP address in the Ending IP Address field.</li> <li>▪ Select a role from the drop-down list in the Role field. This rule applies to members of this role only.</li> <li>▪ Select Allow or Deny from the drop-down list in the Policy field.                             <ul style="list-style-type: none"> <li>▪ Allow: Accepts traffic from the specified IP address range when the user is a member of the specified role</li> <li>▪ Deny: Drops traffic from the specified IP address range when the user is a member of the specified role</li> </ul> </li> <li>▪ Click OK.</li> </ul> <p>The system automatically numbers the rule.</p>
Insert a rule between two existing rules	<ul style="list-style-type: none"> <li>▪ Select the rule above which you want to insert a new rule. For example, to insert a rule between rules #3 and #4, select #4.</li> <li>▪ Click Insert. The "Insert new Rule" dialog appears.</li> <li>▪ Type a starting IP address in the Starting IP Address field.</li> <li>▪ Type an ending IP address in the Ending IP Address field.</li> <li>▪ Select a role from the drop-down list in the Role field. This rule applies to members of this role only.</li> <li>▪ Select Allow or Deny from the drop-down list in the Policy field.                             <ul style="list-style-type: none"> <li>▪ Allow: Accepts traffic from the specified IP address range when the user is a member of the specified role</li> <li>▪ Deny: Drops traffic from the specified IP address range when the user is a member of the specified</li> </ul> </li> </ul>

Action	Do this...
	<ul style="list-style-type: none"> <li>role</li> <li>▪ Click OK.</li> </ul> <p>The system inserts the rule and automatically renumbers the following rules.</p>

5. Click OK.

### Editing Role-Based Access Control Rules

You can modify existing rules when these rules do not meet your needs.



#### ► To modify a role-based access control rule:

1. Choose Device Settings > Security > Role Based Access Control. The Configure Role Based Access Control Settings dialog appears.
2. To modify the IPv4 firewall rules, click the IPv4 tab. To modify the IPv6 firewall rules, click the IPv6 tab.
3. Ensure the "Enable Role Based Access Control for IPv4" checkbox is selected on the IPv4 tab, or the "Enable Role Based Access Control for IPv6" checkbox is selected on the IPv6 tab.
4. Select the rule to be modified in the rules list.
5. Click Edit or double-click the rule. The Edit Rule dialog appears.
6. Make changes to the information shown.
7. Click OK.

### Sorting Role-Based Access Control Rules

Similar to firewall rules, the order of role-based access control rules determines which one of the rules matching the IP address and role is performed.

#### ► To sort role-based access control rules:

1. Choose Device Settings > Security > Role Based Access Control. The Configure Role Based Access Control Settings dialog appears.
2. To sort the IPv4 firewall rules, click the IPv4 tab. To sort the IPv6 firewall rules, click the IPv6 tab.
3. Ensure the "Enable Role Based Access Control for IPv4" checkbox is selected on the IPv4 tab, or the "Enable Role Based Access Control for IPv6" checkbox is selected on the IPv6 tab.
4. Select a specific rule by clicking it.
5. Click  or  to move the selected rule up or down until it reaches the desired location.

6. Click OK.

### **Deleting Role-Based Access Control Rules**

When any access control rule becomes unnecessary or obsolete, remove it.

► **To delete a role-based access control rule:**

1. Choose Device Settings > Security > Role Based Access Control. The Configure Role Based Access Control Settings dialog appears.
2. To delete the IPv4 firewall rules, click the IPv4 tab. To delete the IPv6 firewall rules, click the IPv6 tab.
3. Ensure the "Enable Role Based Access Control for IPv4" checkbox is selected on the IPv4 tab, or the "Enable Role Based Access Control for IPv6" checkbox is selected on the IPv6 tab.
4. Select the rule to be deleted in the rules list. To make multiple selections, press Ctrl+click or Shift+click to highlight multiple ones.
5. Click Delete.
6. A message appears, prompting you to confirm the operation. Click Yes to confirm the deletion.
7. Click OK.

---

## **Setting Up a TLS Certificate**

---

**Important: Raritan disables SSL 3.0 and uses TLS for releases 3.0.4, 3.0.20 and later releases due to published security vulnerabilities in SSL 3.0. Make sure your network infrastructure, such as LDAP and mail services, uses TLS rather than SSL 3.0.**

---



Having an X.509 digital certificate ensures that both parties in an TLS connection are who they say they are.

To obtain a certificate for the PX, create a Certificate Signing Request (CSR) and submit it to a certificate authority (CA). After the CA processes the information in the CSR, it provides you with a certificate, which you must install on the PX device.

---

*Note 1: If you are using a TLS certificate that is part of a chain of certificates, each part of the chain is signed during the validation process.*

*Note 2: See **Forcing HTTPS Encryption** (on page 141) for instructions on forcing users to employ TLS when connecting to the PX.*

---

A CSR is not required in either of the following scenarios:

- You decide to generate and use a *self-signed* certificate on the PX device.
- Appropriate, valid certificate and key files are already available.

---

### Certificate Signing Request

When appropriate certificate and key files for the PX are NOT available, one of the alternatives is to create a CSR and private key on the PX device, and send the CSR to a CA for signing the certificate.

#### Creating a Certificate Signing Request

Follow this procedure to create the CSR for your PX device.

► **To create a CSR:**

1. Choose Device Settings > Security > SSL Certificate. The Manage SSL Certificate dialog appears.
2. Click the New SSL Certificate tab.
3. Provide the information requested.
  - In the Subject section:

Field	Type this information
Country (ISO Code)	The country where your company is located. Use the standard ISO country code. For a list of ISO codes, visit the <b>ISO website</b> ( <a href="http://www.iso.org/iso/country_codes/iso_3166_code_lists.htm">http://www.iso.org/iso/country_codes/iso_3166_code_lists.htm</a> ).
State or Province	The full name of the state or province where your company is located.
Locality	The city where your company is located.
Organization	The registered name of your company.
Organizational Unit	The name of your department.

Field	Type this information
Common Name	The fully qualified domain name (FQDN) of your PX device.
Email Address	An email address where you or another administrative user can be reached.

---

*Note: All fields in the Subject section are mandatory, except for the Organization, Organizational Unit and Email Address fields. If you generate a CSR without values entered in the required fields, you cannot obtain third-party certificates.*

---

- In the Key Creation Parameters section:

Field	Do this
Key Length	Select the key length (bits) from the drop-down list in this field. A larger key length enhances the security, but slows down the PX device's response.
Self Sign	<b>For requesting a certificate signed by the CA, ensure this checkbox is NOT selected.</b>
Challenge	Type a password. The password is used to protect the certificate or CSR. This information is optional, and the value should be 4 to 64 characters long.  The password is case sensitive, so ensure you capitalize the letters correctly.
Confirm Challenge	Type the same password again for confirmation.

4. Click Create New SSL Key to create both the CSR and private key. This may take several minutes to complete.
5. To download the newly-created CSR to your computer, click Download Certificate Signing Request.
  - a. You are prompted to open or save the file. Click Save to save it onto your computer.
  - b. After the file is stored on your computer, submit it to a CA to obtain the digital certificate.
  - c. If intended, click Delete Certificate Signing Request to remove the CSR file permanently from the PX device.
6. To store the newly-created private key on your computer, click Download Key. You are prompted to open or save the file. Click Save to save it onto your computer.
7. Click Close to quit the dialog.

### Installing a CA-Signed Certificate

After the CA provides a signed certificate according to the CSR you submitted, you must install it on the PX device.

► **To install the certificate:**

1. Choose Device Settings > Security > SSL Certificate. The Manage SSL Certificate dialog appears.
2. Click the New SSL Certificate tab.
3. In the Certificate File field, click Browse to select the certificate file provided by the CA.
4. Click Upload. The certificate is installed on the PX device.

---

*Tip: To verify whether the certificate has been installed successfully, click the Active SSL Certificate tab.*

---

5. Click Close to quit the dialog.

### Creating a Self-Signed Certificate

When appropriate certificate and key files for the PX device are unavailable, the alternative, other than submitting a CSR to the CA, is to generate a self-signed certificate.

► **To create and install a self-signed certificate:**

1. Choose Device Settings > Security > SSL Certificate. The Manage SSL Certificate dialog appears.
2. Click the New SSL Certificate tab.
3. Provide the information requested.

Field	Type this information
Country (ISO Code)	The country where your company is located. Use the standard ISO country code. For a list of ISO codes, visit the <b>ISO website</b> ( <a href="http://www.iso.org/iso/country_codes/iso_3166_code_lists.htm">http://www.iso.org/iso/country_codes/iso_3166_code_lists.htm</a> ).
State or Province	The full name of the state or province where your company is located.
Locality	The city where your company is located.
Organization	The registered name of your company.
Organizational Unit	The name of your department.
Common Name	The fully qualified domain name (FQDN) of your PX device.
Email Address	An email address where you or another administrative user can be reached.

Field	Type this information
Key Length	Select the key length (bits) from the drop-down list in this field. A larger key length enhances the security, but slows down the PX device's response.
Self Sign	<b>Ensure this checkbox is selected, which indicates that you are creating a self-signed certificate.</b>
Validity in days	This field appears after the Self Sign checkbox is selected. Type the number of days for which the self-signed certificate will be valid.

---

*Note: All fields in the Subject section are mandatory, except for the Organization, Organizational Unit and Email Address fields.*

---

A password is not required for a self-signed certificate so the Challenge and Confirm Challenge fields disappear after the Self Sign checkbox is selected.

4. Click Create New SSL Key to create both the self-signed certificate and private key. This may take several minutes to complete.
5. You can also do any of the following:
  - Click "Install Key and Certificate" to immediately install the self-signed certificate and private key. When any confirmation and security messages appear, click Yes to continue.

---

*Tip: To verify whether the certificate has been installed successfully, click the Active SSL Certificate tab.*

---

- To download the self-signed certificate or private key, click Download Certificate or Download Key. You are prompted to open or save the file. Click Save to save it onto your computer.
  - To remove the self-signed certificate and private key permanently from the PX device, click "Delete Key and Certificate".
6. If you installed the self-signed certificate in Step 5, after the installation completes, the PX device resets and the login page re-opens.

---

### Installing Existing Key and Certificate Files

If the TLS certificate and private key files are already available, you can install them directly without going through the process of creating a CSR or a self-signed certificate.

---

*Note: If you are using a TLS certificate that is part of a chain of certificates, each part of the chain is signed during the validation process.*

---

► **To install existing key and certificate files:**

1. Choose Device Settings > Security > SSL Certificate. The Manage SSL Certificate dialog appears.
2. Click the New SSL Certificate tab.
3. Select the "Upload Key and Certificate" checkbox. The Key File and Certificate File fields appear.
4. In the Key File field, click Browse to select the private key file.
5. In the Certificate File field, click Browse to select the certificate file.
6. Click Upload. The selected files are installed on the PX device.

---

*Tip: To verify whether the certificate has been installed successfully, click the Active SSL Certificate tab.*

---

7. Click Close to quit the dialog.

---

### Downloading Key and Certificate Files

You can download the key and certificate files currently installed on the PX device for backup or other operations. For example, you can install the files on a replacement PX device, add the certificate to your browser and so on.

► **To download the certificate and key files from the PX device:**

1. Choose Device Settings > Security > SSL Certificate. The Manage SSL Certificate dialog appears.
2. The Active SSL Certificate tab should open. If not, click it.
3. Click Download Key to download the private key file installed on the PX device. You are prompted to open or save the file. Click Save to save it onto your computer.
4. Click Download Certificate to download the certificate file installed on the PX device. You are prompted to open or save the file. Click Save to save it onto your computer.
5. Click Close to quit the dialog.

---

## Setting Up External Authentication

For security purposes, users attempting to log in to the PX must be authenticated. The PX supports the access using one of the following authentication mechanisms:

- Local database of user profiles on the PX device
- Lightweight Directory Access Protocol (LDAP)
- Remote Access Dial-In User Service (RADIUS) protocol

By default, the PX is configured for local authentication. If you stay with this method, you do not need to do anything other than create user profiles for each authorized user.

If you prefer external authentication, you must provide the PX with information about the external Authentication and Authorization (AA) server.

If both local and external authentication is needed, create user profiles on the PX in addition to providing the external AA server's data.

When configured for external authentication, all PX users must have an account on the external AA server. Local-authentication-only users will have no access to the PX except for the admin, who always can access the PX.

Only users who have the "Change Authentication Settings" permission can set up or modify the authentication settings.

---

**Important: Raritan disables SSL 3.0 and uses TLS for releases 3.0.4, 3.0.20 and later releases due to published security vulnerabilities in SSL 3.0. Make sure your network infrastructure, such as LDAP and mail services, uses TLS rather than SSL 3.0.**

---

---

### Gathering the External Authentication Information

No matter which type of external authentication is preferred, the first step is to gather the data of all external AA servers that you want to use.

### Gathering the LDAP Information

It requires knowledge of your LDAP server and directory settings to configure the PX for LDAP authentication. If you are not familiar with the settings, consult your LDAP administrator for help.

To configure LDAP authentication, you need to check:

- The IP address or hostname of the LDAP server
- Whether the Secure LDAP protocol (LDAP over TLS) is being used
  - If Secure LDAP is in use, consult your LDAP administrator for the CA certificate file.
- The network port used by the LDAP server
- The type of the LDAP server, usually one of the following options:
  - *OpenLDAP*
    - If using an OpenLDAP server, consult the LDAP administrator for the Bind Distinguished Name (DN) and password.
  - *Microsoft Active Directory® (AD)*
    - If using a Microsoft Active Directory server, consult your AD administrator for the name of the Active Directory Domain.
- Bind Distinguished Name (DN) and password (if anonymous bind is NOT used)
- The Base DN of the server (used for searching for users)
- The login name attribute (or AuthorizationString)
- The user entry object class
- The user search subfilter (or BaseSearch)

### Gathering the RADIUS Information

To configure RADIUS authentication, you need to collect the RADIUS information. If you are not familiar with the remote RADIUS information, consult your RADIUS administrator for help.

Below is the RADIUS information to gather:

- The IP address or host name of the RADIUS server
- Authentication protocol used by the RADIUS server
- Shared secret for a secure communication
- UDP authentication port used by the RADIUS server
- UDP accounting port used by the RADIUS server

---

### Adding Authentication Servers

Add all external AA servers that you want to use to the PX. Later you can use the sequence of the server list to control the AA servers' access priority.

### Adding LDAP Server Settings

To activate and use external LDAP/LDAPS server authentication, enable LDAP authentication and enter the information you have gathered for any LDAP/LDAPS server.

If the external LDAP/LDAPS server authentication fails, an "Authentication failed" message is displayed. Details regarding the authentication failure are available in the event log. See **Viewing the Local Event Log** (on page 246).

---

*Note: An LDAPS server refers to a TLS-secured LDAP server.*

---

► **To add new LDAP/LDAPS server settings:**

1. Choose Device Settings > Security > Authentication. The Authentication Settings dialog appears.
2. Select the LDAP radio button to activate the LDAP/LDAPS authentication.
3. Click New to add an LDAP/LDAPS AA server. The "Create new LDAP Server Configuration" dialog appears.
4. IP Address / Hostname - Type the IP address or hostname of your LDAP/LDAPS authentication server.

---

*Important: Without the TLS encryption enabled, you can type either the domain name or IP address in this field, but you must type the fully qualified domain name if the TLS encryption is enabled.*

---

5. Type of LDAP Server - Choose one of the following options:
  - OpenLDAP
  - Microsoft Active Directory. Active Directory is an implementation of LDAP/LDAPS directory services by Microsoft for use in Windows environments.
6. LDAP over SSL - Select this checkbox if you would like to use Transport Layer Security (TLS) encryption. TLS is a cryptographic protocol that allows the PX to communicate securely with the LDAPS server.
7. Port - The default Port is 389. Either use the standard LDAP TCP port or specify another port.



8. SSL Port - The default is 636. Either use the default port or specify another port. This field is enabled when the "LDAP over SSL" checkbox is selected.
9. Enable verification of LDAP Server Certificate - Select this checkbox if you would like the PX to verify the validity of the selected LDAP server certificate. For example, the PX will check the certificate's validity period against the system time.
10. CA Certificate - Consult your AA server administrator to get the CA certificate file for the LDAPS server. Click Browse to select the TLS CA certificate file.
  - Click Show to view the installed certificate's contents.
  - Click Remove to delete the installed certificate if it is inappropriate.
11. Allow expired and not yet valid certificates - If a certificate has been installed, use this checkbox to determine whether the validity period of the certificate affects the authentication.
  - To always make the authentication succeed regardless of the validity period, select this checkbox.
  - To make the authentication fail when any TLS certificate in the selected certificate chain is outdated or not valid yet, deselect the checkbox.
12. Anonymous Bind - For "OpenLDAP," use this checkbox to enable or disable anonymous bind.
  - To use anonymous bind, select this checkbox.
  - When a Bind DN and password are required to bind to the external LDAP/LDAPS server, deselect this checkbox.
13. Use Bind Credentials - For "Microsoft Active Directory," use this checkbox to enable or disable anonymous bind.
  - To use anonymous bind, deselect this checkbox. By default it is deselected.
  - When a Bind DN and password are required to bind to the external LDAP/LDAPS server, select this checkbox.
14. Bind DN - Specify the DN of the user who is permitted to search the LDAP directory in the defined search base. This information is required only when the Use Bind Credentials checkbox is selected.
15. Bind Password and Confirm Bind Password - Enter the Bind password in the Bind Password field first and then the Confirm Bind Password field. This information is required only when the Use Bind Credentials checkbox is selected.

16. Base DN for Search - Enter the name you want to bind against the LDAP/LDAPS (up to 31 characters), and where in the database to begin searching for the specified Base DN. An example Base Search value might be: `cn=Users,dc=raritan,dc=com`. Consult your AA server administrator for the appropriate values to enter into these fields.
17. Type the following information in the corresponding fields. LDAP needs this information to verify user names and passwords.
  - Login name attribute (also called AuthorizationString)
  - User entry object class
  - User search subfilter (also called BaseSearch)

---

*Note: The PX will preoccupy the login name attribute and user entry object class with default values, which should not be changed unless required.*

---

18. Active Directory Domain - Type the name of the Active Directory Domain. For example, `testradius.com`. Consult with your Active Directory Administrator for a specific domain name.
19. To verify if the authentication configuration is set correctly, you may click Test Connection to check whether the PX can connect to the remote authentication server successfully.

---

*Tip: You can also do this by using the Test Connection button in the Authentication Settings dialog.*

---

20. Click OK. The new LDAP server is listed in the Authentication Settings dialog.
21. To add additional LDAP/LDAPS servers, repeat Steps 3 to 20.
22. Click OK. The LDAP authentication is now in place.

► **To duplicate LDAP/LDAPS server settings:**

If you have added any LDAP/LDAPS server information to the PX, and the server you are adding shares identical or similar settings with an existing server, the most convenient way is to duplicate that LDAP/LDAPS server's data.

1. Repeat Steps 1 to 4 in the above procedure to add the LDAP/LDAPS server you want.
2. Select the "Use settings from LDAP Server" checkbox.
3. Click the drop-down arrow below the checkbox to select the LDAP/LDAPS server whose settings you want to copy.
4. Make necessary changes to the information shown.
5. Click OK.

---

*Note: If the PX clock and the LDAP server clock are out of sync, the installed TLS certificates, if any, may be considered expired. To ensure proper synchronization, administrators should configure the PX and the LDAP server to use the same NTP server(s).*

---

### **Adding RADIUS Server Settings**

To activate and use external RADIUS server authentication, enable RADIUS authentication and enter the information you have gathered for any RADIUS server.

► **To set up RADIUS authentication:**

1. Choose Device Settings > Security > Authentication. The Authentication Settings dialog appears.
2. Select the Radius radio button to enable the RADIUS authentication.
3. Click New to add a RADIUS AA server. The "Create new RADIUS Server Configuration" dialog appears.
4. Type the IP address or host name of the RADIUS server in the IP Address / Hostname field.
5. Select an authentication protocol in the "Type of RADIUS Authentication" field. Your choices include:
  - PAP (Password Authentication Protocol)
  - CHAP (Challenge Handshake Authentication Protocol)CHAP is generally considered more secure because the user name and password are encrypted, while in PAP they are transmitted in the clear.
6. By default, the PX uses the standard RADIUS port 1812 (authentication) and 1813 (accounting). If you prefer to use non-standard ports, change the ports.
7. Type the timeout period in seconds in the Timeout field. This sets the maximum amount of time to establish contact with the RADIUS server before timing out. Default is 1 second.
8. Type the number of retries permitted in the Retries field. Default is 3.
9. Type the shared secret in the Shared Secret and Confirm Shared Secret fields. The shared secret is necessary to protect communication with the RADIUS server.
10. To verify if the authentication configuration is set correctly, you may click Test Connection to check whether the PX can connect to the remote authentication server successfully.

---

*Tip: You can also do this by using the Test Connection button in the Authentication Settings dialog.*

---

11. Click OK. The new RADIUS server is listed in the Authentication Settings dialog.
12. To add additional RADIUS servers, repeat Steps 3 to 11.
13. Click OK. RADIUS authentication is now in place.

#### **More Information about AD or RADIUS Configuration**

For more information about the LDAP configuration using Microsoft Active Directory, see **LDAP Configuration Illustration** (on page 530).

For more information on RADIUS configuration, see **RADIUS Configuration Illustration** (on page 538).

---

#### **Sorting the Access Order**

The order of the authentication server list determines the access priority of remote authentication servers. The PX first tries to access the top server in the list for authentication, then the next one if the access to the first one fails, and so on until the PX device successfully connects to one of the listed servers.

---

*Note: After successfully connecting to one external authentication server, the PX STOPS trying to access the remaining authentication servers in the list regardless of the user authentication result.*

---

#### **► To re-sort the authentication server access list:**

1. Choose Device Settings > Security > Authentication. The Authentication Settings dialog appears.
2. Select the remote authentication server whose priority you want to change.
3. Click "Move up" or "Move down" until the selected server reaches the desired position in the list.
4. Click OK.

---

#### **Testing the Server Connection**

You can test the connection to any external authentication server to verify the server accessibility or the validity of the authentication settings.

#### **► To test the connection to an authentication server:**

1. Choose Device Settings > Security > Authentication. The Authentication Settings dialog appears.
2. Select the remote authentication server that you want to test.
3. Click Test Connection to start the connection test.

---

### Editing Authentication Server Settings

If the configuration of any external authentication server has been changed, such as the port number, you must modify the authentication settings on the PX device accordingly, or the authentication fails.

▶ **To modify the external authentication configuration:**

1. Choose Device Settings > Security > Authentication. The Authentication Settings dialog appears.
2. Select the remote authentication server that you want to edit.
3. Click Edit or double-click that server.
4. Make necessary changes to the information shown.
5. Click OK.

---

### Deleting Authentication Server Settings

You can delete the settings of a specific authentication server when that server is no longer available or used for remote authentication.

▶ **To remove one or multiple authentication servers:**

1. Choose Device Settings > Security > Authentication. The Authentication Settings dialog appears.
2. Select the remote authentication server that you want to remove. To make multiple selections, press Ctrl+click or Shift+click to highlight multiple ones.
3. Click Delete.
4. A message appears, prompting you to confirm the operation. Click Yes to confirm the deletion.
5. Click OK.

---

### Disabling External Authentication

When the remote authentication service is disabled, the PX authenticates users against the local database stored on the PX device.

▶ **To disable the external authentication service:**

1. Choose Device Settings > Security > Authentication. The Authentication Settings dialog appears.
2. Select the Local Authentication radio button.
3. Click OK.

---

### Enabling External and Local Authentication Services

To make authentication function properly all the time - even when external authentication is not available, you can enable both the local and remote authentication services.

When both authentication services are enabled, the PX follows these rules for authentication:

- When any of the remote authentication servers in the access list is accessible, the PX authenticates against the connected authentication server only.
- When the connection to all remote authentication servers fails, the PX allows authentication against the local database.

► **To enable both authentication services:**

1. Choose Device Settings > Security > Authentication. The Authentication Settings dialog appears.
2. Make sure you have selected one external authentication radio button, such as the LDAP radio button.
3. Select the "Use Local Authentication if Remote Authentication service is not available" checkbox.
4. Click OK.

---

## Outlet Management

PX allows you to remotely monitor and control outlets and manage outlet settings through the web interface.

---

*Note: To configure power thresholds, see **Setting Power Thresholds** (on page 192).*

---

---

### Naming Outlets

You can give each outlet a unique name up to 32 characters long to identify the equipment connected to it. The customized name is followed by the label in parentheses.

---

*Note: In this context, a label is an outlet number, such as 1, 2, 3 and so on.*

---

► **To name an outlet:**

1. Expand the Outlets folder in the PX Explorer pane to show all outlets. See **Expanding the Tree** (on page 78).
2. In the PX Explorer pane, click the outlet you want. The page specific to that outlet opens in the right pane.

- Click Setup in the right pane. The setup dialog for the selected outlet appears.

---

*Tip: Another way to trigger the same dialog is to use the Outlets page. Select the Outlets folder, highlight the outlet on the Outlets page and then click Setup at the bottom of the page.*

---

- Type a name in the Outlet Name field.
- Click OK.

---

### Outlet Monitoring

The PX Explorer pane provides quick access to the outlet information. The outlet information, such as RMS current, active power, power factor, and so on, is displayed immediately after an outlet icon in the tree is selected.

---

*Note: RMS refers to Root Mean Square, a statistical method for measuring certain types of variables. In this context, it gives the value of current that is equivalent to a DC value.*

---

### Monitoring All Outlets

You can view the current status of all outlets at a time.

► **To monitor all outlets:**

- Expand the PDU folder in the PX Explorer pane if necessary. See ***Expanding the Tree*** (on page 78).
- Click the Outlets folder, and the Outlets page opens in the right pane, showing all outlets with the following information:
  - Outlet number (#)
  - Outlet name
  - Outlet status (on/off)
  - Outlet sensor readings:
    - RMS current (A)
    - Active power (W)
    - Power factor
  - Non-critical outlet settings (True/False) if the PDU is outlet-switching capable

- Outlet receptacle type

#	Name (Label)	Status	Current	Active Power	Power Factor	Non Critical	Receptacle Type
1	Outlet 1	on	0.000 A	0 W	1.00	False	IEC 60320 C19
2	Outlet 2	off	0.000 A	0 W	1.00	True	IEC 60320 C13
3	Outlet 3	on	0.000 A	0 W	1.00	False	IEC 60320 C13
4	Outlet 4	on	0.000 A	0 W	1.00	False	IEC 60320 C13
5	Outlet 5	off	0.000 A	0 W	1.00	False	IEC 60320 C13
6	Outlet 6	on	0.000 A	0 W	1.00	False	IEC 60320 C13
7	Outlet 7	on	0.000 A	0 W	1.00	False	IEC 60320 C13
8	Outlet 8	on	0.000 A	0 W	1.00	False	IEC 60320 C13

---

*Note: If a sensor row is colored, it means the sensor reading already crosses one of the thresholds, the sensor enters an alarmed state, or the overcurrent protector has tripped or blown. See **The Yellow- or Red-Highlighted Sensors** (on page 83).*

---

### Monitoring an Outlet

To view a particular outlet's detailed information, follow this procedure.

#### ► To monitor an outlet:

1. Expand the Outlets folder in the PX Explorer pane to show all outlets. See **Expanding the Tree** (on page 78).
2. Click the outlet you want in the PX Explorer pane, and the outlet's details are shown in the right pane, including:
  - Outlet label (number)
  - Outlet name
  - Outlet status (on/off)

---

*Note: The outlet status is only available on an outlet-switching capable PX device.*

---

- Outlet receptacle type
- Line pair associated with this outlet
- Overcurrent protector like a circuit breaker that protects this outlet, if available on your model
- Outlet state on device startup
- Power off period during power cycle
- Non-critical outlet settings (False/True)

---

*Note: The above three pieces of information are only available on an outlet-switching capable PX device.*

---



- Outlet sensor readings:
  - RMS current (A)
  - RMS voltage (V)
  - Active power (W)
  - Apparent power (VA)
  - Power factor
  - Active energy (Wh)
  - Line frequency (Hz), if available on your model

The outlet readings turn to zero if the associated circuit breaker trips or the fuse blows.

---

*Note: If a sensor row is colored, it means the sensor reading already crosses one of the thresholds, the sensor enters an alarmed state, or the overcurrent protector has tripped or blown. See **The Yellow- or Red-Highlighted Sensors** (on page 83).*

---



---

## Outlet Switching

This section applies to outlet-switching capable models only.

You can change the power status of one or multiple outlets with one click in the web interface. To change the power state, you must have the *Switch Outlet* permission.

---

*Tip: To switch an outlet using the front panel display, see **Outlet Switching** (on page 64).*

---

### Switching Multiple or All Outlets

This section applies to outlet-switching capable models only.

The power state can be changed regardless of each outlet's current state. That is, you can turn on or off or power cycle the outlets even if they are already in the selected state.

Power cycling the outlet(s) turns the outlet(s) off and then back on.

► **To turn on or off multiple or all outlets, or cycle their power:**

1. Expand the PDU folder in the PX Explorer pane if necessary. See **Expanding the Tree** (on page 78).

---

*Note: The folder is named "my PX" by default. The name can be customized.*

---

2. Click the Outlets folder, and the Outlets page opens in the right pane.
3. Select the outlets whose power states you want to change, and ensure their checkboxes are all selected.
  - To select all outlets, select the top checkbox in the header row.

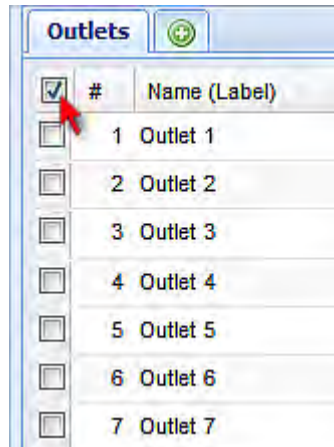

- To select multiple outlets, click the checkbox of each desired outlet one by one. Or press Shift while clicking on the rows of the first and last outlets to select a range of consecutive outlets.
  - To select a single outlet, select that outlet's checkbox.
4. Click On, Off, or Cycle.
  5. A dialog for confirming the operation appears. Click Yes and all outlets switch ON, OFF, or cycle their power.

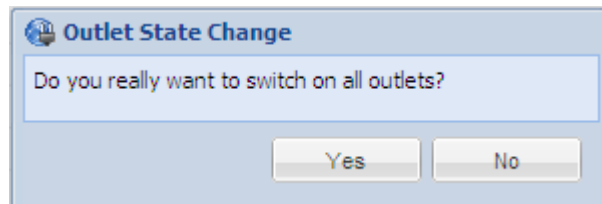

### Switching an Outlet

This section applies to outlet-switching capable models only.

You can turn on or off or power cycle any outlet regardless of the outlet's current state.

Power cycling the outlet(s) turns the outlet(s) off and then back on.

There are different ways to turn an outlet on or off, or cycle its power.

► **To control an outlet with a particular outlet icon selected:**

1. Expand the Outlets folder in the PX Explorer pane to show all outlets. See **Expanding the Tree** (on page 78).
2. Click the outlet you want in the PX Explorer pane, and locate the Control section in the right pane.
3. Click On, Off, or Cycle.
4. A dialog for confirming the operation appears. Click Yes and the outlet switches ON, OFF, or cycles its power.

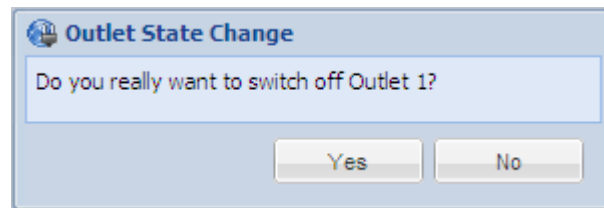

► **To control an outlet with the Outlets folder icon selected:**

- The procedure is similar to the one described in the section titled **Switching Multiple or All Outlets** (on page 173).

### Stopping the Power-On Sequence

This section applies to outlet-switching capable models only.

The PX allows you to stop the outlet power-on sequence while all outlets are being turned on. This function is useful when you have set a certain power-on sequence and certain outlets' power-on delay timing causes it to take a long time to turn on the next outlets, but you do not intend to wait anymore.

► **To cancel the power-on process:**

1. Open the Outlets page to turn on ALL outlets. See **Switching Multiple or All Outlets** (on page 173).

2. The Cancel button as shown below appears at the bottom of the Outlets page. The number in parentheses indicates how many outlets are not powered on yet.

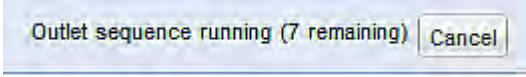

Outlet sequence running (7 remaining) Cancel

3. Click Cancel to immediately stop the power-on process.

---

### Setting the Default Outlet State

This section applies to outlet-switching capable models only.

Default outlet state determines the initial power state of outlets after the PX device powers up. You can set up the default outlet state for all outlets or for a specific outlet. Note that the value set for an individual outlet always overrides the value set for all outlets.

After removing power from the PDU, you must wait for a minimum of 10 seconds before powering it up again. Otherwise, the default outlet state settings may not work properly.

### Setting the PDU-Defined Default State

This section applies to outlet-switching capable models only.

This procedure sets the PDU-defined outlet state, which determines the initial power state of all outlets after powering up the PX device.

---

*Tip: To set a different state on a particular outlet, see **Setting the Outlet-Specific Default State** (on page 177).*

---

► **To set the default state for all outlets:**

1. Click the PDU folder.

---

*Note: The folder is named "my PX" by default. The name can be customized.*

---

2. Click Setup in the Settings section. The Pdu Setup dialog appears.
3. In the "Outlet state on device startup" field, click the drop-down arrow and select an option from the list.
  - on: Turns on all outlets when the PX powers up.
  - off: Turns off all outlets when the PX powers up.
  - last known: Restores all outlets to their previous power states before the PX was powered off.
4. Click OK.

### Setting the Outlet-Specific Default State

This section applies to outlet-switching capable models only.

By default, the power state of each outlet follows the PDU-defined setting. Setting the default state of a particular outlet to a value other than "PDU defined" overrides the PDU-defined setting on that outlet.

► **To set the default power state for a specific outlet:**

1. Expand the Outlets folder in the PX Explorer pane to show all outlets. See **Expanding the Tree** (on page 78).
2. In the PX Explorer pane, click the outlet you want. The page specific to that outlet opens in the right pane.
3. Click Setup in the right pane. The setup dialog for the selected outlet appears.

---

*Tip: Another way to trigger the same dialog is to use the Outlets page. Select the Outlets folder, highlight the outlet on the Outlets page and then click Setup at the bottom of the page.*

---

4. In the "State on device startup" field, click the drop-down arrow and select an option from the list.
  - on: Turns on this outlet when the PX powers up.
  - off: Turns off this outlet when the PX powers up.
  - last known: Restores this outlet to the previous power state before the PX was powered off.
  - PDU defined: The outlet's default power state is determined according to the PDU-defined state. See **Setting the PDU-Defined Default State** (on page 176).

---

*Tip: The information in parentheses following the option "PDU defined" indicates the current PDU-defined selection.*

---

5. Click OK.

### Changing the Cycling Power-Off Period

This section applies to outlet-switching capable models only.

Power cycling the outlet(s) turns the outlet(s) off and then back on. You can adjust the length of the time it takes for the outlets to turn back on after they are switched OFF.

The power-off period during the power cycle can be set for all outlets or for an individual outlet. Note that the value set for an individual outlet always overrides the value set for all outlets.

### Changing the PDU-Defined Cycling Power-Off Period

This section applies to outlet-switching capable models only.

The "PDU-defined" power-off period determines how long it takes for ALL outlets to turn on after they are turned OFF during the power cycle. The default PDU-defined power-off period is 10 seconds (10 s).

---

*Note: To set a different power-off period on a particular outlet, see **Changing the Outlet-Specific Cycling Power-Off Period** (on page 179).*

---

► **To set the power-off period for all outlets:**

1. Click the PDU folder.

---

*Note: The folder is named "my PX" by default. The name can be customized.*

---

2. Click Setup in the Settings section. The Pdu Setup dialog appears.
3. In the "Power off period during power cycle" field, click the drop-down arrow and select an option from the list. Valid range is zero second to one hour.

Time units in the list are explained below:

- s: second(s)
- min: minute(s)
- h: hour(s)

You can also type a value if the desired time is not listed. For example, type "15 s" for 15 seconds.

4. Click OK.

---

*Tip: When there are a large number of outlets, set the value to a lower number so that you can avoid a long wait before all the outlets are available again.*

---

### Changing the Outlet-Specific Cycling Power-Off Period

This section applies to outlet-switching capable models only.

When the power cycling occurs, the default power-off period of each outlet follows the PDU-defined setting. You can adjust the power-off period of a particular outlet so that it is turned back on after a different power-off period.

Setting the power-off period for a particular outlet to a value other than "PDU defined" overrides the PDU-defined setting on that outlet.

► **To set the power-off period for a specific outlet:**

1. Expand the Outlets folder in the PX Explorer pane to show all outlets. See **Expanding the Tree** (on page 78).
2. In the PX Explorer pane, click the outlet you want. The page specific to that outlet opens in the right pane.
3. Click Setup in the right pane. The setup dialog for the selected outlet appears.

---

*Tip: Another way to trigger the same dialog is to use the Outlets page. Select the Outlets folder, highlight the outlet on the Outlets page and then click Setup at the bottom of the page.*

---

4. In the "Power off period during power cycle" field, click the drop-down arrow and select an option from the list. Valid range is zero second to one hour.

Time units in the list are explained below:

- s: second(s)
- min: minute(s)
- h: hour(s)
- To make the outlet's power-off period identical to the PDU-defined setting, select the "PDU defined" option. See **Changing the PDU-Defined Cycling Power-Off Period** (on page 178).

---

*Tip: The information in parentheses following the option "PDU defined" indicates the current PDU-defined selection.*

---

You can also type a value if the desired time is not listed. For example, type "15 s" for 15 seconds.

5. Click OK.

---

## Setting the Initialization Delay

This section applies to outlet-switching capable models only.

The outlet initialization delay determines how long the PX device waits before providing power to all outlets during power cycling or after recovering from a temporary power loss. This is useful in cases where power may not initially be stable after being restored, or when UPS batteries may be charging.

► **To set the initialization delay for all outlets:**

1. Click the PDU folder.

---

*Note: The folder is named "my PX" by default. The name can be customized.*

---

2. Click Setup in the Settings section. The Pdu Setup dialog appears.
3. In the "Outlet initialization delay on device startup" field, click the drop-down arrow and select an option from the list. Valid range is 1 second to 1 hour.

Time units in the list are explained below:

- s: second(s)
- min: minute(s)
- h: hour(s)

You can also type a value if the desired time is not listed. For example, type "15 s" for 15 seconds.

4. Click OK.

---

*Tip: When there are a large number of outlets, set the value to a lower number so that you can avoid a long wait before all the outlets are available again.*

---



---

## Setting the Inrush Guard Delay

This section applies to outlet-switching capable models only.

When electrical devices are turned on, they can initially draw a very large current known as inrush current. Inrush current typically lasts for 20-40 milliseconds. The inrush guard delay feature prevents a circuit breaker trip due to the combined inrush current of many devices turned on at the same time. For example, if the inrush guard delay is set to 100 milliseconds and two or more outlets are turned on at the same time, the PDU will sequentially turn the outlets on with a 100 millisecond delay occurring between each one.

► **To set the inrush guard delay time:**

1. Click the PDU folder.

---

*Note: The folder is named "my PX" by default. The name can be customized.*

---

2. Click Setup in the Settings section. The Pdu Setup dialog appears.
3. In the Inrush Guard Delay field, click the drop-down arrow and select an option from the list. Valid range is from 100 milliseconds to 100 seconds.

Time units in the list are explained below:

- ms: millisecond(s)
- s: second(s)

You can also type a value if the desired time is not listed. For example, type "15 s" for 15 seconds.

4. Click OK.

---

## Setting the Outlet Power-On Sequence

This section applies to outlet-switching capable models only.

By default, the outlets are sequentially powered on in ascending order from outlet 1 to the highest-numbered outlet when turning ON or power cycling all outlets on the PX device. You can change the order in which the outlets power ON. This is useful when there is a specific order in which the connected IT equipment should be powered up.

► **To set the outlet power-on sequence:**

1. Trigger the Outlet Sequence Setup dialog by doing either of the following:

- Click the Outlets folder, and the Outlets page opens in the right pane. Click Sequence Setup.
- Click the PDU folder, and then the Setup button in the Outlet Sequence section.





---

*Note: The folder is named "my PX" by default. The name can be customized.*

---

The Outlet Sequence Setup dialog appears, with the current power-up sequence indicated by the outlet order in the list.

2. To change the priority of an outlet, select it from the list and click one of the following buttons.

- : Moves the outlet to the top of the list, making it the first outlet to receive power.
- : Moves the outlet up one position in the list.
- : Moves the outlet down one position in the list.
- : Moves the outlet to the bottom of the list, making it the final outlet to receive power.
- : Restores the list to the default power-up sequence, that is, the ascending order.

3. Click OK.

Next time when power cycling the PX, it will turn on all outlets based on the new order of the list.

---

### Setting the Outlet-Specific Power-On Delay

This section applies to outlet-switching capable models only.

You can make a power-on delay occur between two outlets that are turned on consecutively when the PX turns on all outlets.

For example, if the power-up sequence is Outlet 1 through Outlet 12, and you want the PX to wait for 5 seconds after turning on Outlet 3 before turning on Outlet 4, assign a delay of 5 seconds on Outlet 3.

► **To set the outlet-specific power-on delay:**

1. Trigger the Outlet Sequence Setup dialog by doing either of the following:
  - Click the Outlets folder, and the Outlets page opens in the right pane. Click Sequence Setup.

- Click the PDU folder, and then the Setup button in the Outlet Sequence section.

---

*Note: The folder is named "my PX" by default. The name can be customized.*

---

2. Click the Delay column of the outlet where a delay is intended after this outlet is turned on, delete the existing value and type a new number in seconds. The number can be a decimal number.
  - To disable the delay, simply type the number 0 (zero).
3. Repeat the above step to change the delay settings of additional outlets.
4. Click OK.

---

### Setting Non-Critical Outlets and Load Shedding Mode

This section applies to outlet-switching capable models only.

When a UPS supplying power to the PX switches into battery backup operation, it may be desirable to switch off non-critical outlets to conserve UPS battery life. This feature is known as load shedding.

Activation of load shedding can be accomplished using the web interface, SNMP or CLI, or triggered by the contact closure sensors.

Outlets that are turned off when load shedding is activated are called non-critical. Outlets that are not affected by load shedding are called critical outlets. When load shedding is deactivated, the PX will turn back on all non-critical outlets. By default, all outlets are configured as critical until you configure them otherwise.

#### Marking All Outlets

This section applies to outlet-switching capable models only.

You can configure all critical and non-critical outlets at a time.

#### ► To mark all outlets at a time:

1. Click the PDU folder.

---

*Note: The folder is named "my PX" by default. The name can be customized.*





---

2. Click Setup in the Load Shedding section. The Load Shedding Setup dialog appears.

---

*Tip: Another way to trigger the same dialog is to use the Outlets page. Select the Outlets folder, and then click the Setup button near the Load Shedding section at the lower left corner of the page.*

---

3. To mark an outlet as "non-critical," select it from the "Critical outlets" list box, and click  to move it to the "Non-critical outlets" list box. To make multiple selections, press Ctrl+click or Shift+click to highlight multiple ones.  
To move all outlets in the "Critical outlets" list box to the "Non-critical outlets" list box, click .
4. To mark an outlet as "critical," select it from the "Non-critical outlets" list box, and click  to move it to the "Critical outlets" list box. To make multiple selections, press Ctrl+click or Shift+click to highlight multiple ones.  
To move all outlets in the "Non-critical outlets" list box to the "Critical outlets" list box, click .
5. Click OK.

#### Marking an Outlet

This section applies to outlet-switching capable models only.

You can also choose to mark a specific outlet as a critical or non-critical outlet in its setup dialog.

#### ► To mark an outlet:

1. Expand the Outlets folder in the PX Explorer pane to show all outlets. See **Expanding the Tree** (on page 78).
2. In the PX Explorer pane, click the outlet you want. The page specific to that outlet opens in the right pane.
3. Click Setup in the right pane. The setup dialog for the selected outlet appears.

---

*Tip: Another way to trigger the same dialog is to use the Outlets page. Select the Outlets folder, highlight the outlet on the Outlets page and then click Setup at the bottom of the page.*

---

4. In the Non Critical field, select an option from the drop-down list.
  - True: This option marks the outlet as a non-critical outlet.
  - False: This option marks the outlet as a critical outlet.
5. Click OK.

### Activating or Deactivating the Load Shedding Mode

This section applies to outlet-switching capable models only.

When entering the load shedding mode, PX turns OFF all non-critical outlets.

When exiting from the load shedding mode, PX turns ON all non-critical outlets that were ON before entering the load shedding mode.

You can activate or deactivate this mode from the PDU or Outlets page.

► **To enter or exit from the load shedding mode from the PDU page:**

1. Click the PDU folder.

---

*Note: The folder is named "my PX" by default. The name can be customized.*

---

2. In the Load Shedding section, click Start to enter the load shedding mode or Stop to deactivate the mode.
3. You are then prompted to confirm this operation.

If you chose to activate the mode in the previous step, click Yes to turn off all non-critical outlets. If you chose to deactivate the mode, click Yes to turn on all non-critical outlets that were previously ON prior to the load shedding mode.

► **To enter or exit from the load shedding mode from the Outlets page:**

1. Expand the PDU folder in the PX Explorer pane if necessary. See **Expanding the Tree** (on page 78).
2. Click the Outlets folder, and the Outlets page opens in the right pane.
3. To enter the load shedding mode, click Start near the Load Shedding section at the lower left corner of the page. To exit from the load shedding mode, click Stop.
4. You are then prompted to confirm this operation.

If you chose to activate the mode in the previous step, click Yes to turn off all non-critical outlets. If you chose to deactivate the mode, click Yes to turn on all non-critical outlets that were previously ON prior to the load shedding mode.

---

*Note: During the load shedding mode, this icon  appears on all non-critical outlets on the Outlets page, and you CANNOT turn on any of them.*

---

---

### Resetting Outlet Active Energy Readings

You can reset the active energy readings of either one outlet or multiple outlets at a time.

Only users with the "Admin" role assigned can reset active energy readings.

► **To reset active energy readings of one outlet:**

1. Expand the Outlets folder in the PX Explorer pane to show all outlets. See **Expanding the Tree** (on page 78).
2. In the PX Explorer pane, select the outlet whose active energy you want to reset.
3. Click Reset Active Energy in the Sensors section.
4. Click Yes on the confirmation message. The "Active Energy" reading of the selected outlet now shows 0 (zero) Wh.

► **To reset active energy readings of multiple or all outlets:**

1. Click the Outlets folder to open the Outlets page.
2. On the Outlets page, select the checkboxes of the outlets whose active energy you want to reset.
  - To select multiple outlets, click the checkbox of each desired outlet one by one. Or press Shift while clicking on the rows of the first and last outlets to select a range of consecutive outlets.
  - To select all outlets, select the top checkbox in the header row.

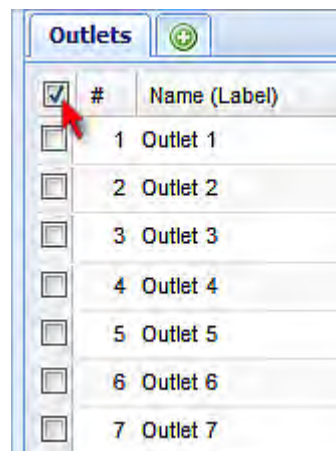

3. Click Reset Active Energy at the bottom of the page.
4. Click Yes on the confirmation message. The "Active Energy" readings of all selected outlets are now reset to 0 (zero) Wh.

---

## Enabling Front Panel Outlet Switching

This section applies to outlet-switching capable models only.

You can operate the front panel buttons to switch on or off an outlet. By default, this function is disabled.

► **To enable the front panel outlet switching function:**

1. Choose Device Settings > Security > Front Panel Permissions. The Front Panel Permissions dialog appears.
2. Select the "Outlet switching" checkbox.
3. Click OK.

---

## Inlet and Overcurrent Protector Management

You can name each inlet and overcurrent protector or monitor the inlet status. Or you can reset the inlet's active energy reading.

---

*Note: To configure power thresholds, see **Setting Power Thresholds** (on page 192).*

---

### Naming the Inlet

You can customize the inlet's name for your own purpose. For example, you can name an inlet to identify its power source. The customized name is followed by the label in parentheses.

---

*Note: In this context, the label refers to the inlet number, such as I1.*

---

This function is especially useful if there are multiple inlets on your PX device.

► **To name the inlet:**

1. Click Inlet I1 in the PX Explorer pane, and the Inlet I1 page opens in the right pane.
2. Click Setup. The Inlet I1 Setup dialog appears.
3. Type a new name in the Name field.
4. Click OK.

---

### Naming Overcurrent Protectors

You can name each overcurrent protector for easily identifying them. The customized name is followed by the label in parentheses.

---

*Note: In this context, a label is an overcurrent protector number, such as C1 for a circuit breaker or F1 for a fuse.*

---

► **To name an overcurrent protector:**

1. Expand the Overcurrent Protectors folder in the PX Explorer pane if needed. See **Expanding the Tree** (on page 78).
2. In the PX Explorer pane, click the desired overcurrent protector. The page specific to that overcurrent protector opens in the right pane.
3. Click Setup. The Overcurrent Protector Setup dialog appears.

---

*Tip: You can also trigger the same dialog by selecting the Overcurrent Protectors folder, then selecting an overcurrent protector and clicking Setup on the Overcurrent Protectors page.*

---

4. Type a new name in the Name field.
5. Click OK.

---

### Monitoring the Inlet

You can view the inlet's details, including its:

- Label (number)
- Customized name
- Inlet sensor readings:
  - RMS current per line (A)
  - RMS voltage per line pair (V)
  - Active power (W)
  - Apparent power (VA)
  - Power factor
  - Active energy (Wh)
  - Unbalanced load percentage (for 3-phase models)
  - Line frequency (Hz), if available on your PDU



---

*Note: If a sensor row is colored, it means the sensor reading already crosses one of the thresholds or the sensor enters the alarmed state. See **The Yellow- or Red-Highlighted Sensors** (on page 83).*

---

There are two ways to access the inlet information.

▶ **To get the overview of the inlet status:**

1. Click the Dashboard icon in the PX Explorer pane, and the Dashboard page opens in the right pane.
2. Locate the Inlet section on the Dashboard page.

▶ **To view the inlet's details:**

Click Inlet I1 in the PX Explorer pane, and the Inlet I1 page opens in the right pane.

---

### Monitoring Overcurrent Protectors

Each overcurrent protector on the PX device delivers power to a bank of outlets, and draws power from one or two lines.

You can view the overcurrent protector's details, including its:

- Label (number)
- Name
- Status (closed/open)
- Type
- Lines associated with this overcurrent protector
- Outlets protected by this overcurrent protector
- Sensor readings:
  - Current drawn (A)
  - Current remaining (A)

---

*Note: If a sensor row is colored, it means the sensor reading already crosses one of the thresholds, the sensor enters an alarmed state, or the overcurrent protector has tripped or blown. See **The Yellow- or Red-Highlighted Sensors** (on page 83).*

---

You can view the summary of all overcurrent protectors at a time or the status of individual overcurrent protectors.

▶ **To view all overcurrent protectors' status:**

You can check the status of all overcurrent protector at a time via either the Dashboard or Overcurrent Protectors page.

- **Using the Dashboard page:**

- a. Click the Dashboard icon in the PX Explorer pane, and the Dashboard page opens in the right pane.
- b. Locate the Overcurrent Protectors section on the Dashboard page.
  - **Using the Overcurrent Protectors page:**
    - a. Expand the PDU folder in the PX Explorer pane if necessary. See **Expanding the Tree** (on page 78).
    - b. Click Overcurrent Protectors in the PX Explorer pane to open the Overcurrent Protectors page.

► **To view an overcurrent protector's details:**

1. Expand the Overcurrent Protectors folder in the PX Explorer pane if needed. See **Expanding the Tree** (on page 78).
2. In the PX Explorer pane, click the desired overcurrent protector. The page specific to that overcurrent protector opens in the right pane.

---

### **Resetting Inlet Active Energy Readings**

You can manually reset the active energy readings of an individual inlet instead of resetting all active energy readings of the PDU. This is especially useful when your PX has more than one inlet.

Only users with the "Admin" role assigned can reset active energy readings.

► **To reset active energy readings of one inlet:**

1. If your PX has multiple inlets, expand the Inlet folder in the PX Explorer pane to show all inlets. See **Expanding the Tree** (on page 78). If your PX has only one inlet, skip this step.
2. Select the inlet whose active energy you want to reset.
3. Click Reset Active Energy in the Power section.
4. Click Yes on the confirmation message. The 'Active Energy' reading of the selected inlet now shows 0 (zero) Wh.

---

*Tip: You can reset all active energy readings at a time. See **Resetting All Active Energy Readings** (on page 129).*

---

---

### Disabling an Inlet (for Multi-Inlet PDUs)

The PX, if it has more than one inlet, enables all inlets by default so that the PX detects and displays all sensors' readings and states, and reports or shows warnings, events or alarm notifications associated with all inlets, outlets and overcurrent protectors (if available).

After disabling an inlet, the following information or feature is no longer available:

- All of the sensor readings, states, warnings, event or alarm notifications associated with the disabled inlet
- All of the sensor readings, states, warnings, event or alarm notifications for the outlets and overcurrent protectors associated with the disabled inlet
- The outlet-switching functionality, if available, for those outlets associated with the disabled inlet

---

*Exception: All active energy sensors continue to accumulate data regardless of whether any inlet has been disabled.*

---

Warning: A disabled inlet, if remaining connected to a power source, continues to receive power from the connected power source and supplies power continuously to the associated outlets and overcurrent protectors.

► **To disable an inlet:**

1. Click the Inlets folder in the PX Explorer pane, and the Inlets page opens in the right pane.
2. Select the inlet that you want to disable.
3. Click Setup.
4. Select the "Disable this inlet" checkbox.
5. To disable additional inlets, repeat the above steps.
6. If disabling an inlet will result in all inlets being disabled, a confirmation dialog appears, indicating that all inlets will be disabled. Then click Yes to confirm this operation or No to abort it.

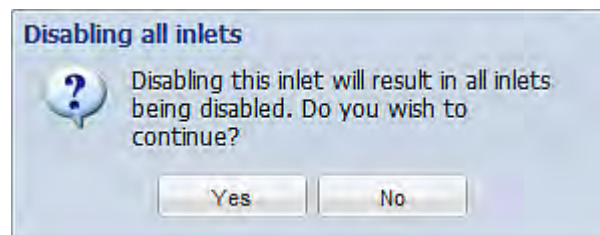

---

## Setting Power Thresholds

Setting and enabling the thresholds causes the PX to generate alert notifications when it detects that any component's power state crosses the thresholds. See **The Yellow- or Red-Highlighted Sensors** (on page 83).

There are four thresholds for each sensor: Lower Critical, Lower Warning, Upper Warning and Upper Critical.

- Upper and Lower Warning thresholds indicate the sensor reading enters the warning level.
- Upper and Lower Critical thresholds indicate the sensor reading enters the critical level.

To avoid generating a large amount of alert events, you can set the assertion timeout and deassertion hysteresis.

For detailed information, see **Sensor Threshold Settings** (on page 591).

---

*Note: After setting the thresholds, remember to configure event rules. See **Event Rules and Actions** (on page 199).*

---

---

### Setting an Outlet's Thresholds

You can set up the thresholds, deassertion hysteresis and assertion timeout for a particular outlet.

The threshold values set for an individual outlet will override the bulk threshold values stored on that outlet. See **Bulk Configuration for Outlet Thresholds** (on page 193).

► **To set the thresholds for an outlet:**

1. Expand the Outlets folder in the PX Explorer pane to show all outlets. See **Expanding the Tree** (on page 78).
2. In the PX Explorer pane, click the outlet you want. The page specific to that outlet opens in the right pane.
3. Click Setup in the right pane. The setup dialog for the selected outlet appears.

---

*Tip: Another way to trigger the same dialog is to use the Outlets page. Select the Outlets folder, highlight the outlet on the Outlets page and then click Setup at the bottom of the page.*

---

4. In the Threshold Configuration table, click the sensor whose thresholds you want to configure.
5. Click Edit or double-click the desired sensor. A threshold setup dialog appears.

6. Configure the Lower Critical, Lower Warning, Upper Warning and Upper Critical thresholds respectively.
  - To enable any threshold, select the corresponding checkbox. To disable a threshold, deselect the checkbox.
  - After any threshold is enabled, type an appropriate numeric value in the accompanying text box.
7. To set the deassertion hysteresis, type a numeric value in the Deassertion Hysteresis field. See **"To De-assert" and Deassertion Hysteresis** (on page 596).
8. To set the assertion timeout, type a numeric value in the Assertion Timeout (samples) field. See **"To Assert" and Assertion Timeout** (on page 594).
9. Click OK in the threshold setup dialog to retain the changes.
10. To set the thresholds for other sensors, repeat Steps 4 to 9.
11. Click OK.

---

**Important: The final step is required or the threshold changes are not saved.**

---

### Bulk Configuration for Outlet Thresholds

The PX allows you to set the power thresholds for multiple outlets at a time so that you can save time when configuring a number of outlet thresholds.

---

*Note: To set the power thresholds for an individual outlet, you can either follow the instructions below or those described in the section **Setting an Outlet's Thresholds** (on page 192).*

---

► **To configure thresholds, deassertion hysteresis and assertion timeout for multiple outlets:**

1. Expand the PDU folder in the PX Explorer pane if necessary. See **Expanding the Tree** (on page 78).

---

*Note: The folder is named "my PX" by default. The name can be customized.*

---

2. Click the Outlets folder. The Outlets page opens.
3. Click Bulk Setup. The Outlet Threshold Bulk Setup dialog appears, with a list of all outlets.
4. In the "Show Outlet Sensors of Type" field, select the type of power thresholds you want to configure.
5. In the "For Outlets of Receptacle Type" field, select the receptacle type you want to configure.

All outlets of the selected receptacle type are then listed.

- To show all outlets on the PX regardless of receptacle types, select Any.
6. Select desired outlets by having their corresponding checkboxes selected.
    - To select all outlets in the list, select the checkbox labeled Sensor in the header row, and all checkboxes are selected.

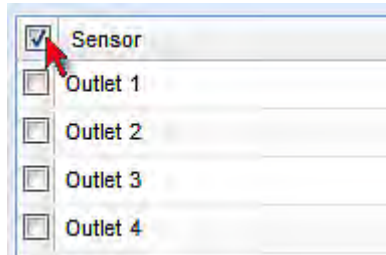

- To select partial outlets, select the corresponding checkboxes of those outlets by clicking their checkboxes.
  - To deselect any outlet, just click the checkbox once again.
7. Click Edit Thresholds. The threshold bulk setup dialog appears.
  8. Configure the Lower Critical, Lower Warning, Upper Warning and Upper Critical thresholds respectively.
    - To enable any threshold, select the corresponding checkbox. To disable a threshold, deselect the checkbox.
    - After any threshold is enabled, type an appropriate numeric value in the accompanying text box.
  9. To set the deassertion hysteresis, type a numeric value in the Deassertion Hysteresis field. See **"To De-assert" and Deassertion Hysteresis** (on page 596).
  10. To set the assertion timeout, type a numeric value in the Assertion Timeout (samples) field. See **"To Assert" and Assertion Timeout** (on page 594).
  11. Click OK.

---

### Setting Inlet Thresholds

You can set the inlet thresholds so that the alerts are generated when the inlet current and/or voltage crosses the thresholds.

► **To set the inlet thresholds:**

1. Click Inlet I1 in the PX Explorer pane, and the Inlet I1 page opens in the right pane.
2. Click Setup. The Inlet I1 Setup dialog appears.

3. In the Threshold Configuration table, click the sensor whose thresholds you want to configure.
4. Click Edit or double-click the desired sensor. A threshold setup dialog appears.
5. Configure the Lower Critical, Lower Warning, Upper Warning and Upper Critical thresholds respectively.
  - To enable any threshold, select the corresponding checkbox. To disable a threshold, deselect the checkbox.
  - After any threshold is enabled, type an appropriate numeric value in the accompanying text box.
6. To set the deassertion hysteresis, type a numeric value in the Deassertion Hysteresis field. See **"To De-assert" and Deassertion Hysteresis** (on page 596).
7. To set the assertion timeout, type a numeric value in the Assertion Timeout (samples) field. See **"To Assert" and Assertion Timeout** (on page 594).
8. Click OK in the threshold setup dialog to retain the changes.
9. To set the thresholds for other sensors, repeat Steps 4 to 8.
10. Click OK.

---

**Important: The final step is required or the threshold changes are not saved.**

---

### Setting an Overcurrent Protector's Thresholds

Setting the overcurrent protector thresholds enables the PX to generate alerts when any overcurrent protector crosses the thresholds.

► **To set thresholds for an overcurrent protector:**

1. Expand the Overcurrent Protectors folder in the PX Explorer pane if needed. See **Expanding the Tree** (on page 78).
2. In the PX Explorer pane, click the desired overcurrent protector. The page specific to that overcurrent protector opens in the right pane.
3. Click Setup. The Overcurrent Protector Setup dialog appears.
4. In the Threshold Configuration table, click the sensor whose thresholds you want to configure.
5. Click Edit or double-click the desired sensor. A threshold setup dialog appears.
6. Configure the Lower Critical, Lower Warning, Upper Warning and Upper Critical thresholds respectively.
  - To enable any threshold, select the corresponding checkbox. To disable a threshold, deselect the checkbox.

- After any threshold is enabled, type an appropriate numeric value in the accompanying text box.
- 7. To set the deassertion hysteresis, type a numeric value in the Deassertion Hysteresis field. See **"To De-assert" and Deassertion Hysteresis** (on page 596).
- 8. To set the assertion timeout, type a numeric value in the Assertion Timeout (samples) field. See **"To Assert" and Assertion Timeout** (on page 594).
- 9. Click OK.

---

### Bulk Configuration for Overcurrent Protector Thresholds

The PX allows you to set power thresholds for multiple overcurrent protectors at a time to save your time.

---

*Note: To set the power thresholds for an individual overcurrent protector, you can either follow the instructions below or those described in the section **Setting an Overcurrent Protector's Thresholds** (on page 195).*

---

► **To configure thresholds, deassertion hysteresis and assertion timeout for multiple overcurrent protectors:**

1. Click the Overcurrent Protectors folder in the PX EXplorer pane. The Overcurrent Protectors page opens.
2. Click Bulk Setup. The Overcurrent Protector Threshold Bulk Setup dialog appears, with a list of all overcurrent protectors.
3. Select desired overcurrent protectors by having their corresponding checkboxes selected.
  - To select all overcurrent protectors, select the checkbox labeled Sensor in the header row, and all checkboxes are selected.

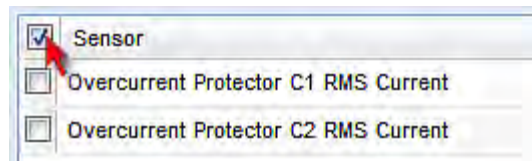

- To select partial overcurrent protectors, click the corresponding checkboxes of those overcurrent protectors.
  - To deselect any overcurrent protectors, just click their checkboxes once again.
4. Click Edit Thresholds. The threshold bulk setup dialog appears.
  5. Configure the Lower Critical, Lower Warning, Upper Warning and Upper Critical thresholds respectively.
    - To enable any threshold, select the corresponding checkbox. To disable a threshold, deselect the checkbox.



- After any threshold is enabled, type an appropriate numeric value in the accompanying text box.
6. To set the deassertion hysteresis, type a numeric value in the Deassertion Hysteresis field. See **"To De-assert" and Deassertion Hysteresis** (on page 596).
  7. To set the assertion timeout, type a numeric value in the Assertion Timeout (samples) field. See **"To Assert" and Assertion Timeout** (on page 594).
  8. Click OK.

---

### Setting Thresholds for Total Active Energy or Power

This section applies only to multi-inlet models, including PX in-line monitors.

Thresholds for total active energy and total active power are disabled by default. You can enable and set them so that you are alerted when the total active energy or total active power hits a certain level.

For a regular PX model with multiple inlets:

- Total active energy = sum of all inlets' active energy values
- Total active power = sum of all inlets' active power values

For an in-line monitor with multiple inlets/outlets:

- Total active energy = sum of all outlets' active energy values
- Total active power = sum of all outlets' active power values

---

*Tip: You can reset the active energy sensor(s) as needed. See **Resetting All Active Energy Readings** (on page 129).*

---

► **To set thresholds for total active energy and/or power on a multi-inlet PX:**

1. Click the PDU folder.

---

*Note: The folder is named "my PX" by default. The name can be customized.*

---

2. Click Setup in the Settings section. The Pdu Setup dialog appears.
3. In the Threshold Configuration table, click the sensor whose thresholds you want to configure.
4. Click Edit or double-click the desired sensor. A threshold setup dialog appears.
5. Configure the Lower Critical, Lower Warning, Upper Warning and Upper Critical thresholds respectively.

- To enable any threshold, select the corresponding checkbox. To disable a threshold, deselect the checkbox.
  - After any threshold is enabled, type an appropriate numeric value in the accompanying text box.
6. To set the deassertion hysteresis, type a numeric value in the Deassertion Hysteresis field. See **"To De-assert" and Deassertion Hysteresis** (on page 596).
  7. To set the assertion timeout, type a numeric value in the Assertion Timeout (samples) field. See **"To Assert" and Assertion Timeout** (on page 594).
  8. Click OK.

**Pdu Setup**

Device Name: PXname

Relay behaviour on power loss: Non-latching

Outlet state on device startup: off

Outlet initialization delay on device startup: 3 s

Power off period during power cycle: 10 s

Inrush Guard Delay: 300 ms

Peripheral Device Z Coordinate Format: Free-Form

Peripheral Device Auto Management:

Altitude (m): 0

Sensor	Lower Critical	Lower Warning	Upper Warning	Upper Critical
Active Energy	<input type="checkbox"/> (0 Wh)	<input type="checkbox"/> (0 Wh)	<input type="checkbox"/> (0 Wh)	<input type="checkbox"/> (0 Wh)
Active Power	<input type="checkbox"/> (0 W)	<input type="checkbox"/> (0 W)	<input type="checkbox"/> (0 W)	<input type="checkbox"/> (0 W)

Buttons: OK, Cancel, Edit

---

## Event Rules and Actions

A benefit of the product's intelligence is its ability to notify you of and react to a change in conditions. This event notification or reaction is an "event rule."

The PX is shipped with four built-in event rules, which cannot be deleted.

- System Event Log Rule: This causes ANY event occurred to the PX to be recorded in the internal log. It is enabled by default.
- System SNMP Notification Rule: This causes SNMP traps or informs to be sent to specified IP addresses or hosts when ANY event occurs to the PX. It is disabled by default.
- System Tamper Detection Alarmed: This causes the PX to send alarm notifications if a DX tamper sensor has been connected and the PX detects that the tamper sensor enters the alarmed state.
- System Tamper Detection Unavailable: This causes the PX to sends alarm notifications if a DX tamper sensor has been connected and the PX detects that the communication with the connected tamper sensor is lost.

If these do not satisfy your needs, you can create additional rules to respond to different events. You need the Administrator Privileges to configure event rules.

---

*Note: Internet Explorer® 8 (IE8) does not use compiled JAVA script. When using IE8 to create or change event rules, the CPU performance may be degraded, resulting in the appearance of the connection time out message. When this occurs, click Ignore to continue.*

---

---

### Components of an Event Rule

An event rule defines what the PX does in certain situations and is composed of two parts:

- Event: This is the situation where the PX or part of it meets a certain condition. For example, the inlet's voltage exceeds the warning threshold.
- Action: This is the response to the event. For example, the PX notifies the system administrator of the event and records the event in the log.

---

### Creating an Event Rule

The best way to create a new set of event rules in sequence is to:

- Create actions for responding to one or multiple events
- Create rules to determine what actions are taken when these events occur

### Creating Actions

The PX comes with three built-in actions:

- System Event Log Action: This action records the selected event in the internal log when the event occurs.
- System SNMP Notification Action: This action sends SNMP notifications to one or multiple IP addresses after the selected event occurs.
- System Tamper Alarm: This action causes the PX to show the alarm for the DX tamper sensor in the Alarms section of the Dashboard until a person acknowledges it. By default, this action has been assigned to the built-in tamper detection event rules. For information on acknowledging an alarm, see **Alarms List** (on page 88).

---

*Note: No IP addresses are specified in the "System SNMP Notification Action" by default so you must specify IP addresses before applying this action to any event rule.*

---

The built-in actions cannot be deleted.

► **To create new actions:**

1. Choose Device Settings > Event Rules. The Event Rule Settings dialog appears.
2. Click the Actions tab.
3. Click New.
4. In the "Action name" field, type a new name for the action. The default name is New Action <number>, where <number> is a sequential number starting at 1.
5. In the Action field, click the drop-down arrow and select the desired action:

Action	Function
Execute an action group	Creates a group of actions comprising existing actions. See <b>Action Group</b> (on page 202).
Alarm	Requires the user to acknowledge the alert when it is generated. If needed, you can have the alert notifications regularly generated until a person takes the acknowledgment action. See <b>Alarm</b> (on page 203).
External beeper	Enables or disables the connected external beeper, or causes it to enter an alarm cycle. See <b>External Beeper</b> (on page 204).

Action	Function
Log event message	Records the selected events in the internal log. See <b>Log an Event Message</b> (on page 205).
Push out sensor readings	Sends asset management sensor data to a remote server using HTTP POST requests. See <b>Push Out Sensor Readings</b> (on page 206).
Request LHX/SHX maximum cooling	Applies the maximum cooling to the LHX/SHX device. See <b>Request LHX/SHX Maximum Cooling</b> (on page 206).  This option is available only when the Schroff LHX/SHX support has been enabled.
Send snapshots via email	Emails the snapshots captured by a connected Logitech® webcam (if available). See <b>Send a Snapshot via Email</b> (on page 207).
Send email	Emails a textual message. See <b>Send Email</b> (on page 208).
Send SNMP notification	Sends SNMP traps or informs to one or multiple SNMP destinations. See <b>Send an SNMP Notification</b> (on page 209).
Syslog message	Makes the PX automatically forward event messages to the specified syslog server. See <b>Syslog Message</b> (on page 211).
Send sensor report	Reports the readings or status of the selected sensors, including internal or external sensors. See <b>Send Sensor Report</b> (on page 213).
Send SMS message	Sends a message to a mobile phone. See <b>Send SMS Message</b> (on page 215).
Internal beeper	Turns on or off the internal beeper. See <b>Internal Beeper</b> (on page 216).
Switch LHX/SHX	Switches on or off the LHX/SHX device. See <b>Switch LHX/SHX</b> (on page 216).  This option is available only when the Schroff LHX/SHX support has been enabled.
Record snapshots to webcam storage	Makes a connected webcam start or stop taking snapshots. See <b>Record Snapshots to Webcam Storage</b> (on page 219).
Change load shedding state	Enters or quits the load shedding mode. See <b>Change Load Shedding State</b> (on page 214).

Action	Function
Switch outlets	Switches on, off or cycles the power to the specified outlet(s). See <b>Switch Outlets</b> (on page 217).
Switch peripheral actuator	Switches on or off the mechanism or system connected to the specified actuator. See <b>Switch Peripheral Actuator</b> (on page 218).

*Note: The "Change load shedding state" and "Switch outlets" options are only available for outlet-switching capable models.*

- Click OK to save the new action.

*Note: If you do not click OK before quitting the current settings page, a message appears. Then click Yes to save the changes, Discard to abort or Cancel to return to the current settings page.*

- To create additional actions, repeat the above steps.
- Click Close to quit the dialog.

### Action Group

You can create an action group that performs up to 32 actions. After creating such an action group, you can easily assign this set of actions to an event rule rather than selecting all needed actions one by one per rule.

#### ► To create an action group:

- Choose Device Settings > Event Rules. The Event Rule Settings dialog appears.
- Click the Actions tab.
- Click New.
- In the "Action name" field, type a new name for the action. The default name is New Action <number>, where <number> is a sequential number starting at 1.
- In the Action field, click the drop-down arrow and select the desired action: Execute an action group.
- To mark an action as part of the action group, select it from the Available Actions list box, and click  to move it to the Used Actions list box. To make multiple selections, press Ctrl+click or Shift+click to highlight multiple ones.

To move all actions to the Used Actions list box, click . A maximum of 32 actions can be grouped.

7. To remove an action from the action group, select it from the Used Actions list box, and click  to move it to the Available Actions list box. To make multiple selections, press Ctrl+click or Shift+click to highlight multiple ones.

To remove all actions, click .

8. Click OK.
9. To create additional action groups, repeat Steps 3 to 8.

### **Alarm**

The Alarm is an action that requires users to acknowledge an alert. This helps ensure that the user is aware of the alert.

If the Alarm action has been included in a specific event rule and no one acknowledges that alert after it occurs, the PX resends or regenerates an alert notification regularly until the alert is acknowledged or it reaches the maximum number of alert notifications.

For information on acknowledging an alarm, see **Alarms List** (on page 88).





#### ► **To create an Alarm action:**

1. Click the Actions tab.
2. Click New.
3. In the "Action name" field, type a new name for the action. The default name is New Action <number>, where <number> is a sequential number starting at 1.
4. In the Action field, click the drop-down arrow and select the desired action: Alarm.
5. In the Alarm Notifications list box, specify one or multiple ways to issue the alert notifications.
  - a. In the Available Actions field, select the method to send alert notifications. Available methods vary, depending on how many notification-based actions have been created.

Notification-based action types include:

- External beeper
- Syslog message
- Send email
- Send SMS message
- Internal beeper

If no appropriate actions are available, click Create New Notification Action to immediately create them.

- b. Click  to add the selected method to the Alarm Notifications list box.
    - c. Repeat the above steps to add more methods if needed.
      - To remove any method from the Alarm Notifications list box, select that method and click .
  6. In the Notification Options section, configure the notification-resending or -regenerating feature.
    - a. To enable the notification-resending feature, select the "Enable re-scheduling of alarm notifications" checkbox. To disable this feature, deselect the checkbox.
    - b. In the "Period in Minutes" field, specify the time interval (in minutes) at which the alert notification is resent or regenerated regularly. You can either directly type a numeric value or click the Up/Down arrow keys to adjust the time.
    - c. In the "Max. numbers" field, specify the maximum number of times the alert notification is resent. Values range from 1 to infinite.
  7. If needed, you can instruct the PX to send the acknowledgment notification after the alarm is acknowledged in the Acknowledgment Notifications list box. **(Optional)**
    - a. In the Available Actions field, select the method to send the acknowledge notification. Available methods are identical to those for generating alarm notifications.
    - b. Click  to add the selected method to the Acknowledgment Notifications list box.
    - c. Repeat the above steps to add more methods if needed.
      - To remove any method from the Acknowledgment Notifications list box, select that method and click .
  8. Click OK.

### **External Beeper**

If an external beeper is connected to the PX, the PX can change the beeper's behavior or status to respond to a certain event.

► **To control the connected external beeper:**

1. Click the Actions tab.
2. Click New.



3. In the "Action name" field, type a new name for the action. The default name is New Action <number>, where <number> is a sequential number starting at 1.
4. In the Action field, click the drop-down arrow and select the desired action: External beeper.
5. From the Beeper Port drop-down list, select the port where the external beeper is connected. This port is the FEATURE port.
6. From the Beeper Action drop-down list, select an action for the external beeper to carry out.
  - Alarm: Causes the external beeper to sound an alarm cycle every 20 seconds - stays on for 0.7 seconds and then off for 19.3 seconds.
  - On: Turns on the external beeper so that it buzzes continuously.
  - Off: Turns off the external beeper so that it stops buzzing.
7. Click OK.

---

*Note: If you create an event rule for the external beeper but disconnect it when an event causes it to beep, the beeper no longer beeps after it is re-connected even though the event triggering the beeping action remains asserted.*

---

#### **Log an Event Message**

This option records the selected events in the internal log.

#### **► To create a log event message:**

1. Choose Device Settings > Event Rules. The Event Rules Settings dialog opens.
2. Click the Actions tab.
3. Click New.
4. In the "Action name" field, type a new name for the action. The default name is New Action <number>, where <number> is a sequential number starting at 1.
5. In the Action field, click the drop-down arrow and select the desired action: Log event message.
6. Click OK.

### **Push Out Sensor Readings**

If you have connected Raritan's asset sensors to the PX, you can configure the PX to push asset sensor data to a remote server after a certain event occurs.

Before creating this action, make sure that you have properly defined the destination servers and the sensor data type in the Data Push dialog. See **Configuring Data Push Settings** (on page 127).

---

*Tip: To send the asset sensor data at a regular interval, schedule this action. See **Scheduling an Action** (on page 225). Note that the "Asset management log" is generated only when there are changes made to any asset sensors or asset tags, such as connection or disconnection events.*

---

#### ► **To push out the sensor data:**

1. Choose Device Settings > Event Rules. The Event Rules Settings dialog opens.
2. Click the Actions tab.
3. Click New.
4. In the "Action name" field, type a new name for the action. The default name is New Action <number>, where <number> is a sequential number starting at 1.
5. In the Action field, click the drop-down arrow and select the desired action: Push out sensor readings.
6. Select a server or host which receives the asset sensor data in the Destination field.
  - If the desired destination is not available yet, go to the Data Push dialog to enter it. See **Configuring Data Push Settings** (on page 127).
7. Click OK.

### **Request LHX/SHX Maximum Cooling**

If Schroff LHX/SHX Support is enabled, the LHX/SHX-related actions will be available. See **Enabling and Disabling Schroff LHX/SHX Heat Exchanger Support** (on page 292).

The "Request LHX/SHX Maximum Cooling" action applies the maximum cooling to the SHX-30 device only.

#### ► **To request maximum cooling for SHX-30:**

1. Choose Device Settings > Event Rules. The Event Rules Settings dialog opens.
2. Click the Actions tab.

3. Click New.
4. In the "Action name" field, type a new name for the action. The default name is New Action <number>, where <number> is a sequential number starting at 1.
5. In the Action field, click the drop-down arrow and select the desired action: Request LHX/SHX maximum cooling.
6. Click OK.

#### **Send a Snapshot via Email**

This option notifies one or multiple persons for the selected events by emailing snapshots or videos captured by a connected Logitech® webcam.

#### ► **To create a send snapshot via email action:**

1. Choose Device Settings > Event Rules. The Event Rules Settings dialog opens.
2. Click the Actions tab.
3. Click New.
4. In the "Action name" field, type a new name for the action. The default name is New Action <number>, where <number> is a sequential number starting at 1.
5. In the Action field, click the drop-down arrow and select the desired action: Send snapshots via email.
6. In the "Recipients email addresses" field, specify the email address(es) of the recipient(s). Use a comma to separate multiple email addresses.
7. To use the SMTP server specified in the SMTP Server Settings dialog, select the Use Default SMTP Server checkbox.  
To use a different SMTP server, select the Use Custom SMTP Settings checkbox.

If the SMTP server settings are not configured yet, click Configure. See **Configuring SMTP Settings** (on page 126) for the information of each field.

8. Select the webcam that is capturing the images you want sent in the email.
9. Use the slide bars to increase or decrease the following:
  - Number of Snapshots - the number of snapshots to be included in the sequence of images that are taken when the event occurs. For example, you can specify 10 images be taken once the event triggers the action.
  - Snapshots/Mail field - the number of snapshots from the sequence to be sent at one time in the email.

- "Time before first Snapshot (s):" - the amount of time (in seconds) between when the event is triggered and the webcam begins taking snapshots.
- "Time between Snapshots (s):" - the amount of time between when each snapshot is taken.

10. Click OK.

### **Send Email**

You can configure emails to be sent when an event occurs and can customize the message.

Messages consist of a combination of free text and PX placeholders. The placeholders represent information is pulled from the PX and inserted into the message.

For example:

[USERNAME] logged into the device on [TIMESTAMP]

translates to

JQPublic logged into the device on 2012-January-30 21:00

See **Email and SMS Message Placeholders** (on page 236) for a list and definition of available variables.

#### ► **To configure sending emails:**

1. Choose Device Settings > Event Rules. The Event Rules Settings dialog opens.
2. Click the Actions tab.
3. Click New.
4. In the "Action name" field, type a new name for the action. The default name is New Action <number>, where <number> is a sequential number starting at 1.
5. In the Action field, click the drop-down arrow and select the desired action: Send email.
6. In the "Recipients email addresses" field, specify the email address(es) of the recipient(s). Use a comma to separate multiple email addresses.
7. To use the SMTP server specified in the SMTP Server Settings dialog, select the Use Default SMTP Server checkbox.  
To use a different SMTP server, select the Use Custom SMTP Settings checkbox.

If the SMTP server settings are not configured yet, click Configure. See **Configuring SMTP Settings** (on page 126) for the information of each field. Default messages are sent based on the event. See **Default Log Messages** (on page 227) for a list of default log messages and events that trigger them.

8. If needed, select the Use Custom Log Message checkbox, and then create a custom message up to 1024 characters in the provided field.
  - To start a new line in the text box, press Enter.
  - Click the Information icon  to open the Event Context Information dialog, which contains a list of placeholders and their definitions. See **Email and SMS Message Placeholders** (on page 236) for more details.
9. Click OK.

#### **Send an SNMP Notification**

This option sends an SNMP notification to one or multiple SNMP destinations.

##### **► To configure sending an SNMP notification:**

1. Choose Device Settings > Event Rules. The Event Rules Settings dialog opens.
2. Click the Actions tab.
3. Click New.
4. In the "Action name" field, type a new name for the action. The default name is New Action <number>, where <number> is a sequential number starting at 1.
5. In the Action field, click the drop-down arrow and select the desired action: Send SNMP notification.
6. Select the type of SNMP notification. See either procedure below according to your selection.

##### **► To send SNMP v2c notifications:**

1. From the Notification Type drop-down, select SNMPv2c Trap or SNMPv2c Inform.
2. For SNMP INFORM communications, leave the resend settings at their default or:

- a. In the Timeout (sec) field, enter the interval of time, in seconds, after which a new inform communication is resent if the first is not received. For example, resend a new inform communication once every 3 seconds.
  - b. In the Number of Retries field, enter the number of times you want to resend the inform communication if it fails. For example, inform communications are resent up to 5 times when the initial communication fails.
3. In the Host fields, enter the IP address of the device(s) you want to access. This is the address to which notifications are sent by the SNMP system agent.
  4. In the Port fields, enter the port number used to access the device(s).
  5. In the Community fields, enter the SNMP community string to access the device(s). The community is the group representing the PX and all SNMP management stations.

---

*Tip: An SNMP v2c notification action only permits entering a maximum of three SNMP destinations. To assign more than three SNMP destinations to a specific rule, first create several SNMP v2c notification actions, each of which contains completely different SNMP destinations, and then add all of these SNMP v2c notification actions to the same rule.*

---

► **To send SNMP v3 notifications:**

1. From the Notification Type drop-down, select SNMPv3 Trap or SNMPv3 Inform.
2. For SNMP TRAPS, the engine ID is prepopulated.
3. For SNMP INFORM communications, leave the resend settings at their default or:
  - a. In the Timeout (sec) field, enter the interval of time, in seconds, after which a new inform communication is resent if the first is not received. For example, resend a new inform communication once every 3 seconds.
  - b. In the Number of Retries field, enter the number of times you want to resend the inform communication if it fails. For example, inform communications are resent up to 5 times when the initial communication fails.
4. For both SNMP TRAPS and INFORMS, enter the following as needed and then click OK to apply the settings:
  - a. Host name
  - b. Port number
  - c. User ID needed to access the host
  - d. Select the host security level

Security level	Description
"noAuthNoPriv"	Select this if no authorization or privacy protocols are needed.
"authNoPriv"	Select this if authorization is required but no privacy protocols are required. <ul style="list-style-type: none"> <li>• Select the authentication protocol - MD5 or SHA</li> <li>• Enter the authentication passphrase and then confirm the authentication passphrase</li> </ul>
"authPriv"	Select this if authentication and privacy protocols are required. <ul style="list-style-type: none"> <li>• Select the authentication protocol - MD5 or SHA</li> <li>• Enter the authentication passphrase and confirm the authentication passphrase</li> <li>• Select the Privacy Protocol - DES or AES</li> <li>• Enter the privacy passphrase and then confirm the privacy passphrase</li> </ul>

### **Syslog Message**

Use this action to automatically forward event messages to the specified syslog server. Determine the syslog transmission mechanism you prefer when setting it up - UDP, TCP or TLS over TCP.

The PX may or may not detect the syslog message transmission failure. If yes, it will log this syslog failure as well as the failure reason in the event log. See **Viewing the Local Event Log** (on page 246).

#### ► **To configure a syslog message action:**

1. Choose Device Settings > Event Rules. The Event Rules Settings dialog opens.
2. Click the Actions tab.
3. Click New.
4. In the "Action name" field, type a new name for the action. The default name is New Action <number>, where <number> is a sequential number starting at 1.
5. In the Action field, click the drop-down arrow and select the desired action: Syslog message.

6. In the "Syslog server" field, specify the IP address to which the syslog is forwarded.
7. In the Transport Protocol field, select one of the syslog protocols: TCP or UDP. The default is UDP.

Transport protocol types	Next steps
UDP	<ul style="list-style-type: none"> <li>▪ In the UDP Port field, specify an appropriate port number. Default is 514.</li> <li>▪ Select the "Legacy BSD Syslog Protocol (UDP only)" checkbox if applicable.</li> </ul>
TCP	<p>If NO TLS certificate is required, type an appropriate port number in the TCP Port field.</p> <p>If a TLS certificate is required, select the "Enable Secure Syslog over TLS" checkbox, and then do the following:</p> <ol style="list-style-type: none"> <li>a. Specify an appropriate port number in the "TCP Port (TLS)" field. Default is 6514.</li> <li>b. In the CA Certificate field, click Browse to select a TLS certificate. After installing the certificate, you may: <ul style="list-style-type: none"> <li>▪ Click Show to view its contents.</li> <li>▪ Click Remove to delete it if it is inappropriate.</li> </ul> </li> <li>c. Determine whether to select the "Allow expired and not yet valid certificates" checkbox. <ul style="list-style-type: none"> <li>▪ To always send the event message to the specified syslog server after a TLS certificate has been installed, select this checkbox.</li> <li>▪ To prevent the event message from being sent to the specified syslog server when any TLS certificate in the selected certificate chain is outdated or not valid yet, deselect this checkbox.</li> </ul> </li> </ol>

8. Click OK.



**Send Sensor Report**

You may set the PX so that it automatically reports the latest readings or states of one or multiple sensors by sending a message or email or simply recording the report in a log. These sensors can be either internal or environmental sensors as listed below.

- Inlet sensors, including RMS current, RMS voltage, active power, apparent power, power factor and active energy.
- Outlet sensors, including RMS current, RMS voltage, active power, apparent power, power factor, active energy and outlet state (for outlet-switching capable PDUs only).
- Overcurrent protector sensors, including RMS current and tripping state.
- Peripheral device sensors, which can be any Raritan environmental sensor packages connected to the PX, such as temperature or humidity sensors.

► **To configure a sensor report action:**

1. Choose Device Settings > Event Rules. The Event Rules Settings dialog opens.
2. Click the Actions tab.
3. Click New.
4. In the "Action name" field, type a new name for the action. The default name is New Action <number>, where <number> is a sequential number starting at 1.
5. In the Action field, click the drop-down arrow and select the desired action: Send sensor report.
6. In the Destination Actions field, select the method(s) to report sensor readings or states. The number of available methods vary, depending on how many messaging actions have been created.

The messaging action types include:

- Log event message
  - Syslog message
  - Send email
  - Send SMS message
- a. If no messaging actions are available, click Create New Destination Action to immediately create them.
  - b. To select any method, select it in the right list box, and click  to move it to the left list box. To make multiple selections, press Ctrl+click or Shift+click to highlight multiple ones.

To select all methods, simply click .

- c. To delete any method, select it in the left list box, and click  to move it back to the right list box. To make multiple selections, press Ctrl+click or Shift+click to highlight multiple ones.

To remove all methods, simply click .

7. In the Available Sensors field, select the desired sensor.
  - a. Select the sensor type from the field to the left.
  - b. Select the specific sensor from the field to the right.
  - c. Click the Add button  to add the selected sensor to the Report Sensors list box.

For example, to monitor the current reading of the Inlet 1, select Inlet 1 from the left field, and then select RMS Current from the right field.

8. To report additional sensors simultaneously, repeat the above step to add more sensors.
  - To remove any sensor from the Report Sensors list box, select it and click the Delete button . To make multiple selections, press Ctrl+click or Shift+click to highlight multiple ones.
9. To immediately send out the sensor report, click Send Report Now. A message appears, indicating whether the sensor report is sent successfully.
10. To save this action, click OK.

---

*Note: When intending to send a sensor report using custom messages, use the placeholder [SENSORREPORT] to report sensor readings. See **Email and SMS Message Placeholders** (on page 236).*

---

### **Change Load Shedding State**

The "Change load shedding state" action is available only when your PX is able to control outlet power. Use this action to activate or deactivate the load shedding mode for responding to a specific event. See **Setting Non-Critical Outlets and Load Shedding Mode** (on page 183) for additional information.

#### **► To change the load shedding state:**

1. Click the Actions tab.
2. Click New.
3. In the "Action name" field, type a new name for the action. The default name is New Action <number>, where <number> is a sequential number starting at 1.
4. In the Action field, click the drop-down arrow and select the desired action: Change load shedding state.

5. From the Operation drop-down, select either of the following:
  - Start Load Shedding: Enters the load shedding mode when the specified event occurs.
  - Stop Load Shedding: Quits the load shedding mode when the specified event occurs.
6. Click OK to save the new action.
7. Click Close to quit the dialog.

### **Send SMS Message**

You can configure emails to be sent when an event occurs and can customize the message.

Messages consist of a combination of free text and PX placeholders. The placeholders represent information which is pulled from the PX and inserted into the message.

A supported modem, such as the Cinterion® GSM MC52i modem, must be plugged in to the PX in order to send SMS messages.

---

*Note: The PX cannot receive SMS messages.*

---

For example:

[USERNAME] logged into the device on [TIMESTAMP]

translates to

JQPublic logged into the device on 2012-January-30 21:00

See ***Email and SMS Message Placeholders*** (on page 236) for a list and definition of available variables.

#### ► **To configure SMS message:**

1. Choose Device Settings > Event Rules. The Event Rules Settings dialog opens.
2. Click the Actions tab.
3. Click New.
4. In the "Action name" field, type a new name for the action. The default name is New Action <number>, where <number> is a sequential number starting at 1.
5. In the Action field, click the drop-down arrow and select the desired action: Send SMS message.
6. In the Recipient Phone Number field, specify the phone number of the recipient.

7. Select the Use Custom Log Message checkbox, then create a custom message in the provided field.

Click the Information icon  to open the Event Context Information dialog, which contains a list of placeholders and their definitions. See **Email and SMS Message Placeholders** (on page 236) for more details.

---

*Note: Only the 7-bit ASCII charset is supported for SMS messages.*

---

8. Click OK.

### **Internal Beeper**

You can have the built-in beeper of the PX turned on or off when a certain event occurs.

#### **► To switch the internal beeper:**

1. Click the Actions tab.
2. Click New.
3. In the "Action name" field, type a new name for the action. The default name is New Action <number>, where <number> is a sequential number starting at 1.
4. In the Action field, click the drop-down arrow and select the desired action: Internal beeper.
5. Select an option from the Operation field.
  - Turn Beeper On: Turns on the internal beeper to make it buzz.
  - Turn Beeper Off: Turns off the internal beeper to make it stop buzzing.
6. Click OK.





### **Switch LHX/SHX**

If Schroff LHX/SHX Support is enabled, the LHX/SHX-related actions will be available. See **Enabling and Disabling Schroff LHX/SHX Heat Exchanger Support** (on page 292).

Use this action to switch the LHX/SHX on or off when, for example, temperature thresholds are reached.

#### **► To create a switch LHX/SHX action:**

1. Choose Device Settings > Event Rules. The Event Rules Settings dialog opens.
2. Click the Actions tab.
3. Click New.

4. In the "Action name" field, type a new name for the action. The default name is New Action <number>, where <number> is a sequential number starting at 1.
5. In the Action field, click the drop-down arrow and select the desired action: Switch LHX/SHX.
6. From the Operation drop-down, select Turn LHX/SHX On or Turn LHX/SHX Off.
7. From the Available LHX/SHXs list box, click on the LHX/SHX to be turned on or off, then click  or  to add to the Switched LHX/SHXs list box. Use  or  to remove the LHX/SHX from the Switched LHXs list box, thereby removing the action.
8. Click OK.

### **Switch Outlets**

The "Switch outlets" action is available only when your PX is outlet-switching capable. This action turns on, off or power cycles a specific outlet.

#### **► To switch on, off or power cycle any outlet(s):**

1. Click the Actions tab.
2. Click New.
3. In the "Action name" field, type a new name for the action. The default name is New Action <number>, where <number> is a sequential number starting at 1.
4. In the Action field, click the drop-down arrow and select the desired action: Switch outlets.
5. From the Operation drop-down list, select an operation for the selected outlet(s).
  - Turn Outlet On: Turns on the selected outlet(s).
  - Turn Outlet Off: Turns off the selected outlet(s).
  - Cycle Outlet: Cycles power to the selected outlet(s).
6. To select the outlet where this action will be applied, select it from the Available Outlets list box and click  to move it to the Switched Outlets list box. To make multiple selections, press Ctrl+click or Shift+click to highlight multiple ones.

To move all outlets to the Switched Outlets list box, click .

7. To remove any outlet from the Switched Outlets list, select it from the Switched Outlets list box and click  to move it to the Available Outlets list box. To make multiple selections, press Ctrl+click or Shift+click to highlight multiple ones.

To remove all outlets, click .

8. Click OK to save the new action.
9. Click Close to quit the dialog.

### **Switch Peripheral Actuator**

If you have any actuator connected to the PX, you can set up the PX so it automatically turns on or off the system controlled by this actuator when a specific event occurs.



---

*Note: For information on connecting actuators to the PX, see **DX Sensor Packages** (on page 37).*

---

► **To switch on or off the system connected to an actuator:**

1. Click the Actions tab.
2. Click New.
3. In the "Action name" field, type a new name for the action. The default name is New Action <number>, where <number> is a sequential number starting at 1.
4. In the Action field, click the drop-down arrow and select the desired action: Switch peripheral actuator.
5. From the Operation drop-down list, select an operation for the selected actuator.
  - Turn On: Turns on the selected actuator.
  - Turn Off: Turns off the selected actuator.
6. To select the actuator where this action will be applied, select it from the Available Actuators list and click  to add it to the Switched Actuators list box. To make multiple selections, press Ctrl+click or Shift+click to highlight multiple ones.

To add all actuators to the Switched Actuators list box, click .
7. To remove any actuator from the Switched Actuators list, select it and click  to move it back to the Available Actuators list box. To make multiple selections, press Ctrl+click or Shift+click to highlight multiple ones.

To remove all actuators, click .
8. Click OK.

**Record Snapshots to Webcam Storage**

This option allows you to define an action that starts or stops a specific webcam from taking snapshots.

► **To configure a record snapshot to webcam storage action:**

1. Choose Device Settings > Event Rules. The Event Rules Settings dialog opens.
2. Click the Actions tab.
3. Click New.
4. In the "Action name" field, type a new name for the action. The default name is New Action <number>, where <number> is a sequential number starting at 1.
5. In the Action field, click the drop-down arrow and select the desired action: Record snapshots to webcam storage.
6. Select a webcam from the Webcam drop-down.
7. Selecting the action to perform - Start recording or Stop recording. If "Start recording" is selected, do the following:
  - a. Use the slide bar to specify the total number of snapshots to be taken when the event occurs. The maximum amount of snapshots that can be stored on the PX is ten (10). If you set it for a number greater than ten and the storage location is on the PX, after the tenth snapshot is taken and stored, the oldest snapshots are overwritten.

---

*Tip: By default, the storage location is on the PX. You can specify a remote server to store the snapshots. See **Configuring Webcam Storage** (on page 288).*

---

- b. In the "Time before first Snapshot (s):" field, use the slide bar to specify the amount of time (in seconds) between when the event is triggered and the webcam begins taking snapshots.
  - c. In the "Time between Snapshots (s):" field, use the slide bar to specify the amount of time between when each snapshot is taken.
8. Click OK.

### Creating Rules

After required actions are available, you can create event rules to determine what actions are taken to respond to specific events.

By default, the PX provides the following built-in event rules:

- System Event Log Rule
- System SNMP Notification Rule
- System Tamper Detection Alarmed
- System Tamper Detection Unavailable

If the built-in rules do not satisfy your needs, create new ones.

► **To create event rules:**

1. Choose Device Settings > Event Rules. The Event Rule Settings dialog appears.
2. On the Rules tab, click New.
3. In the "Rule name" field, type a new name for identifying the rule. The default name is New Rule <number>, where <number> is a sequential number.
4. Select the Enabled checkbox to activate this event rule.
5. Click Event to select an event for which you want to trigger an action. A pull-down menu showing various types of events appears.
  - Select the desired event type from the pull-down menu, and if a submenu appears, continue the navigation until the desired event is selected.

---

*Note: To select all items or events listed on the same submenu, select the option enclosed in brackets, such as <Any sub-event>, <Any Server> and <Any user>.*

---

6. According to the event you selected in the previous step, the "Trigger condition" field containing three radio buttons may or may not appear.



Event types	Radio buttons
Numeric sensor threshold-crossing events, or the occurrence of the selected event -- true or false	<p>Available radio buttons include "Asserted," "Deasserted" and "Both."</p> <ul style="list-style-type: none"> <li>▪ Asserted: The PX takes the action only when the event occurs. This means the status of the described event transits from FALSE to TRUE.</li> <li>▪ Deasserted: The PX takes the action only when the event condition disappears. This means the status of the described event transits from TRUE to FALSE.</li> <li>▪ Both: The PX takes the action both when the event occurs (asserts) and when the event condition disappears (deasserts).</li> </ul>
Discrete (on/off) sensor state change	<p>Available radio buttons include "Alarmed/Open/On," "No longer alarmed/Closed/Off" and "Both."</p> <ul style="list-style-type: none"> <li>▪ Alarmed/Open/On: The PX takes the action only when the chosen sensor enters the alarmed, open or on state.</li> <li>▪ No longer alarmed/Closed/Off: The PX takes the action only when the chosen sensor returns to the normal, closed or off state.</li> <li>▪ Both: The PX takes the action whenever the chosen sensor switches its state.</li> </ul>
Sensor availability	<p>Available radio buttons include "Unavailable," "Available" and "Both."</p> <ul style="list-style-type: none"> <li>▪ Unavailable: The PX takes the action only when the chosen sensor is NOT detected and becomes unavailable.</li> <li>▪ Available: The PX takes the action only when the chosen sensor is detected and becomes available.</li> <li>▪ Both: The PX takes the action both when the chosen sensor becomes unavailable or available.</li> </ul>

Event types	Radio buttons
Network interface link state	<p>Available radio buttons include "Link state is up," "Link state is down" and "Both."</p> <ul style="list-style-type: none"> <li>▪ Link state is up: The PX takes the action only when the network link state changes from down to up.</li> <li>▪ Link state is down: The PX takes the action only when the network link state changes from up to down.</li> <li>▪ Both: The PX takes the action whenever the network link state changes.</li> </ul>
Function enabled or disabled	<p>Available radio buttons include "Enabled," "Disabled" and "Both."</p> <ul style="list-style-type: none"> <li>▪ Enabled: The PX takes the action only when the chosen function is enabled.</li> <li>▪ Disabled: The PX takes the action only when the chosen function is disabled.</li> <li>▪ Both: The PX takes the action when the chosen function is either enabled or disabled.</li> </ul>
User logon state	<p>Available radio buttons include "Logged in," "Logged out," and "Both."</p> <ul style="list-style-type: none"> <li>▪ Logged in: The PX takes the action only when the selected user logs in.</li> <li>▪ Logged out: The PX takes the action only when the selected user logs out.</li> <li>▪ Both: The PX takes the action both when the selected user logs in and logs out.</li> </ul>
Restricted service agreement	<p>Available radio buttons include "Accepted," "Declined," and "Both."</p> <ul style="list-style-type: none"> <li>▪ Accepted: The PX takes the action only when the specified user accepts the restricted service agreement.</li> <li>▪ Declined: The PX takes the action only when the specified user rejects the restricted service agreement.</li> <li>▪ Both: The PX takes the action both when the specified user accepts or rejects the restricted service agreement</li> </ul>





Event types	Radio buttons
Server monitoring event	<p>Available radio buttons include "Monitoring started," "Monitoring stopped," and "Both."</p> <ul style="list-style-type: none"> <li>▪ Monitoring started: The PX takes the action only when the monitoring of any specified server starts.</li> <li>▪ Monitoring stopped: The PX takes the action only when the monitoring of any specified server stops.</li> <li>▪ Both: The PX takes the action when the monitoring of any specified server starts or stops.</li> </ul>
Server reachability	<p>Available radio buttons include "Unreachable," "Reachable," and "Both."</p> <ul style="list-style-type: none"> <li>▪ Unreachable: The PX takes the action only when any specified server becomes inaccessible.</li> <li>▪ Reachable: The PX takes the action only when any specified server becomes accessible.</li> <li>▪ Both: The PX takes the action when any specified server becomes either inaccessible or accessible.</li> </ul>
Device connection or disconnection, such as a USB-cascaded slave device	<p>Available radio buttons include "Connected," "Disconnected" and "Both."</p> <ul style="list-style-type: none"> <li>▪ Connected: The PX takes the action only when the selected device is physically connected to it.</li> <li>▪ Disconnected: The PX takes the action only when the selected device is physically disconnected from it.</li> <li>▪ Both: The PX takes the action both when the selected device is physically connected to it and when it is disconnected.</li> </ul>
Outlet power state change	<p>Available radio buttons include "On," "Off" and "Both."</p> <ul style="list-style-type: none"> <li>▪ On: The PX takes the action only when the chosen outlet is turned ON.</li> <li>▪ Off: The PX takes the action only when the chosen outlet is turned OFF.</li> <li>▪ Both: The PX takes the action when the chosen outlet is either turned ON or OFF.</li> </ul>

Event types	Radio buttons
PDU load shedding	<p>Available radio buttons include "Started," "Stopped" and "Both."</p> <ul style="list-style-type: none"> <li>▪ Started: The PX takes the action only when activating the load shedding mode.</li> <li>▪ Stopped: The PX takes the action only when deactivating the load shedding mode.</li> <li>▪ Both: The PX takes the action whenever the load shedding mode is activated or deactivated.</li> </ul>

---

*Note: The outlet power state change and PDU load shedding events are available only for outlet-switching capable models.*

---

7. In the Actions field, select the desired action from the "Available actions" list box, and click  to move it to the "Selected actions" list box. To make multiple selections, press Ctrl+click or Shift+click to highlight multiple ones.
  - To add all actions, simply click .
  - If the desired action is not available yet, click Create New Action to immediately create it. Upon complete, the newly-created action is moved to the "Selected actions" list box.
8. To remove any action, select it from the "Selected actions" list box, and click  to move it back to the "Available actions" list box. To make multiple selections, press Ctrl+click or Shift+click to highlight multiple ones.
  - To remove all actions, click .
9. Click OK to save the new event rule.

---

*Note: If you do not click OK before quitting the current settings page, a message appears. Then click Yes to save the changes, Discard to abort or Cancel to return to the current settings page.*

---

10. Repeat Steps 2 to 10 to create additional event rules.
11. Click Close to quit the dialog.

### Scheduling an Action

An action can be regularly performed at a preset time interval instead of being triggered by a specific event. For example, you can make the PX report the reading or state of a specific environmental sensor regularly by scheduling the "Send Sensor Report" action.

When scheduling an action, make sure you have a minimum of 1-minute buffer time between this action's execution time and creation time. Otherwise, the scheduled action will NOT be performed at the specified time if the buffer time is too short. For example, if you want an action to be performed at 11:00 am, you should finish scheduling this action at 10:59 am or earlier.

► **To schedule any action(s):**



1. Choose Device Settings > Event Rules. The Event Rule Settings dialog appears.
2. Click the Scheduled Actions tab.
3. Click New.
4. In the "Timer name" field, type a name for this scheduled action. The default name is New Timer <n>, where <n> is the sequential number starting at 1.
5. Make sure the Enabled checkbox is selected, or the PX will not carry out this scheduled action.
6. Select the desired time frequency from the Execution Time field and then specify the time interval or a specific date and time in the Time field.

Time options	Frequency settings
<b>Minutes</b>	The frequency in minutes ranges from every minute, every 5 minutes, every 10 minutes and so on until every 30 minutes.
<b>Hourly</b>	The hourly option sets the frequency to either of the following: <ul style="list-style-type: none"> <li>One hour - then set the Minute field to 0 (zero).</li> <li>Between one and two hours, such as one hour and one minute, one hour and thirty minutes, or one hour and 59 minutes. In this case, specify a non-zero number in the Minute field.</li> </ul>
<b>Daily</b>	You need to specify the time for this daily option. For example, if you specify 13:30 in the Time field, the action is performed at 13:30 every day.
<b>Weekly</b>	Both the day and time must be specified for the weekly option. Days range from Sunday to Monday.
<b>Monthly</b>	Both the date and time must be specified for the monthly option. The dates range from 1 to 31, and the time is specified in 24-hour format.  Note that NOT every month has the date 31, and February in particular does not have the date 30 and probably even 29. Check the calendar when selecting 29, 30 or 31.
<b>Yearly</b>	This option requires three settings: <ul style="list-style-type: none"> <li>Month - January through December.</li> <li>Date - 1 to 31.</li> <li>Time - the value is specified in 24-hour format.</li> </ul>

7. In the Actions field, select the desired action from the "Available actions" list box, and click  to move it to the "Selected actions" list box. To make multiple selections, press Ctrl+click or Shift+click to highlight multiple ones.

- To add all actions, simply click .
- If the desired action is not available yet, click Create New Action to immediately create it. Upon complete, the newly-created action is moved to the "Selected actions" list box. See **Creating Actions** (on page 200).

When creating new actions from the Scheduled Actions tab, available actions are less than usual because it is meaningless to schedule certain actions like "Alarm," "Log event message," "Send email," "Syslog message" and the like.

8. To remove any action, select it from the "Selected actions" list box, and click  to move it back to the "Available actions" list box. To make multiple selections, press Ctrl+click or Shift+click to highlight multiple ones.
  - To remove all actions, click .
9. Click OK.

### Default Log Messages

Following are default log messages triggered and emailed to specified recipients when PX events occur (are TRUE) or, in some cases, do not occur (are FALSE). See **Send Email** (on page 208) for information configuring email messages to be sent when specified events occur.

Event/Context	Default Assertion Message when the Event = TRUE	Default Assertion Message when the Event = FALSE*
Asset Management > State	State of asset strip [STRIPID] ('[STRIPNAME]') changed to '[STATE]'.	
Asset Management > Rack Unit > * > Tag Connected	Asset tag with ID '[TAGID]' connected at rack unit [RACKUNIT], slot [RACKSLOT] of asset strip [STRIPID] ('[STRIPNAME]').	Asset tag with ID '[TAGID]' disconnected at rack unit [RACKUNIT], slot [RACKSLOT] of asset strip [STRIPID] ('[STRIPNAME]').
Asset Management > Rack Unit > * > Blade Extension Connected	Blade extension with ID '[TAGID]' connected at rack unit [RACKUNIT] of asset strip [STRIPID] ('[STRIPNAME]').	Blade extension with ID '[TAGID]' disconnected at rack unit [RACKUNIT] of asset strip [STRIPID] ('[STRIPNAME]').
Asset Management > Firmware Update	Firmware update for asset strip [STRIPID] ('[STRIPNAME]'): status changed to '[STATE]'.	
Asset Management > Device Config Changed	Config parameter '[PARAMETER]' of asset strip [STRIPID] ('[STRIPNAME]') changed to '[VALUE]' by user '[USERNAME]'.	
Asset Management > Rack Unit Config Changed	Config of rack unit [RACKUNIT] of asset strip [STRIPID] ('[STRIPNAME]') changed by user '[USERNAME]' to: LED Operation Mode '[LEDOPMODE]', LED Color '[LEDCOLOR]', LED Mode '[LEDMODE]'	
Asset Management > Blade Extension Overflow	Blade extension overflow occurred on strip [STRIPID] ('[STRIPNAME]').	Blade extension overflow cleared for strip [STRIPID] ('[STRIPNAME]').

Event/Context	Default Assertion Message when the Event = TRUE	Default Assertion Message when the Event = FALSE*
Asset Management > Composite Asset Strip Composition Changed	Composition changed on composite asset strip [STRIPID] ([STRIPNAME]).	
Card Reader Management > Card inserted	Card Reader with id '[CARDREADERID]' connected.	
Card Reader Management > Card Reader attached	Card Reader with id '[CARDREADERID]' disconnected.	
Card Reader Management > Card Reader detached	Card of type '[SMARTCARDTYPE]' with ID '[SMARTCARDID]' inserted.	
Card Reader Management > Card removed	Card of type '[SMARTCARDTYPE]' with ID '[SMARTCARDID]' removed.	
Device > System started	System started.	
Device > System reset	System reset performed by user '[USERNAME]' from host '[USERIP]'.	
Device > Firmware validation failed	Firmware validation failed by user '[USERNAME]' from host '[USERIP]'.	
Device > Firmware update started	Firmware upgrade started from version '[OLDVERSION]' to version '[VERSION]' by user '[USERNAME]' from host '[USERIP]'.	
Device > Firmware update completed	Firmware upgraded successfully from version '[OLDVERSION]' to version '[VERSION]' by user '[USERNAME]' from host '[USERIP]'.	
Device > Firmware update failed	Firmware upgrade failed from version '[OLDVERSION]' to version '[VERSION]' by user '[USERNAME]' from host '[USERIP]'.	
Device > Device identification changed	Config parameter '[PARAMETER]' changed to '[VALUE]' by user '[USERNAME]' from host '[USERIP]'.	
Device > Device settings saved	Device settings saved from host '[USERIP]'.	
Device > Device settings restored	Device settings restored from host '[USERIP]'.	
Device > Data push failed	Data push to URL [DATAPUSH_URL] failed. [ERRORDESC].	



Event/Context	Default Assertion Message when the Event = TRUE	Default Assertion Message when the Event = FALSE*
Device > Event log cleared	Event log cleared by user '[USERNAME]' from host '[USERIP]'.	
Device > Bulk configuration saved	Bulk configuration saved from host '[USERIP]'.	
Device > Bulk configuration copied	Bulk configuration copied from host '[USERIP]'.	
Device > Network interface link state is up	The [IFNAME] network interface link is now up.	The [IFNAME] network interface link is now down.
Device > Peripheral Device Firmware Update	Firmware update for peripheral device [EXTSENSORSERIAL] from [OLDVERSION] to [VERSION] [SENSORSTATENAME].	
Device > Sending SMTP message failed	Sending SMTP message to '[RECIPIENTS]' using server '[SERVER]' failed.	
Device > Sending SNMP inform failed or no response	Sending SNMP inform to manager [SNMPMANAGER]:[SNMPMANAGER PORT] failed or no response. [ERRORDESC].	
Device > Sending Syslog message failed	Sending Syslog message to server [SYSLOGSERVER]:[SYSLOGPORT] ([SYSLOGTRANSPORTPROTO]) failed. [ERRORDESC].	
Device > An LDAP error occurred	An LDAP error occurred: [LDAPERRORDESC].	
Device > An Radius error occurred	An Radius error occurred: [RADIUSERRORDESC].	
Device > Unknown peripheral device attached	An unknown peripheral device with rom code '[ROMCODE]' was attached at position '[PERIPHDEVPOSITION]'.	
Device > USB slave connected	USB slave connected.	USB slave disconnected.
Device > WLAN authentication over TLS with incorrect system clock	Established connection to wireless network '[SSID]' via Access Point with BSSID '[BSSID]' using '[AUTHPROTO]' authentication with incorrect system clock.	
Energywise > Enabled	User '[USERNAME]' from host '[USERIP]' enabled EnergyWise.	User '[USERNAME]' from host '[USERIP]' disabled EnergyWise.

Event/Context	Default Assertion Message when the Event = TRUE	Default Assertion Message when the Event = FALSE*
Peripheral Device Slot > * > Numeric Sensor > Unavailable	Peripheral device '[EXTSENSORNAME]' in slot '[EXTSENSORSLOT]' unavailable.	Peripheral device '[EXTSENSORNAME]' in slot '[EXTSENSORSLOT]' available.
Peripheral Device Slot > * > Numeric Sensor > Above upper critical threshold	Peripheral device '[EXTSENSORNAME]' in slot '[EXTSENSORSLOT]' asserted 'above upper critical' at [READING].	Peripheral device '[EXTSENSORNAME]' in slot '[EXTSENSORSLOT]' deasserted 'above upper critical' at [READING].
Peripheral Device Slot > * > Numeric Sensor > Above upper warning threshold	Peripheral device '[EXTSENSORNAME]' in slot '[EXTSENSORSLOT]' asserted 'above upper warning' at [READING].	Peripheral device '[EXTSENSORNAME]' in slot '[EXTSENSORSLOT]' deasserted 'above upper warning' at [READING].
Peripheral Device Slot > * > Numeric Sensor > Below lower warning threshold	Peripheral device '[EXTSENSORNAME]' in slot '[EXTSENSORSLOT]' asserted 'below lower warning' at [READING].	Peripheral device '[EXTSENSORNAME]' in slot '[EXTSENSORSLOT]' deasserted 'below lower warning' at [READING].
Peripheral Device Slot > * > Numeric Sensor > Below lower critical threshold	Peripheral device '[EXTSENSORNAME]' in slot '[EXTSENSORSLOT]' asserted 'below lower critical' at [READING].	Peripheral device '[EXTSENSORNAME]' in slot '[EXTSENSORSLOT]' deasserted 'below lower critical' at [READING].
Peripheral Device Slot > * > State Sensor > Unavailable	Peripheral device '[EXTSENSORNAME]' in slot '[EXTSENSORSLOT]' unavailable.	Peripheral device '[EXTSENSORNAME]' in slot '[EXTSENSORSLOT]' available.
Peripheral Device Slot > * > State Sensor > Alarmed / Open / On	Peripheral device '[EXTSENSORNAME]' in slot [EXTSENSORSLOT] is [SENSORSTATENAME].	Peripheral device '[EXTSENSORNAME]' in slot [EXTSENSORSLOT] is [SENSORSTATENAME].
Inlet > * > Enabled	Inlet '[INLET]' has been enabled by user '[USERNAME]' from host '[USERIP]'.	Inlet '[INLET]' has been disabled by user '[USERNAME]' from host '[USERIP]'.
Inlet > * > Sensor > * > Unavailable	Sensor '[INLETSENSOR]' on inlet '[INLET]' unavailable.	Sensor '[INLETSENSOR]' on inlet '[INLET]' available.
Inlet > * > Sensor > * > Above upper critical threshold	Sensor '[INLETSENSOR]' on inlet '[INLET]' asserted 'above upper critical'.	Sensor '[INLETSENSOR]' on inlet '[INLET]' deasserted 'above upper critical'.
Inlet > * > Sensor > * > Above upper warning threshold	Sensor '[INLETSENSOR]' on inlet '[INLET]' asserted 'above upper warning'.	Sensor '[INLETSENSOR]' on inlet '[INLET]' deasserted 'above upper warning'.

Event/Context	Default Assertion Message when the Event = TRUE	Default Assertion Message when the Event = FALSE*
Inlet > * > Sensor > * > Below lower warning threshold	Sensor '[INLETSSENSOR]' on inlet '[INLET]' asserted 'below lower warning'.	Sensor '[INLETSSENSOR]' on inlet '[INLET]' deasserted 'below lower warning'.
Inlet > * > Sensor > * > Below lower critical threshold	Sensor '[INLETSSENSOR]' on inlet '[INLET]' asserted 'below lower critical'.	Sensor '[INLETSSENSOR]' on inlet '[INLET]' deasserted 'below lower critical'.
Inlet > * > Sensor > * > Reset	Sensor '[INLETSSENSOR]' on inlet '[INLET]' has been reset by user '[USERNAME]' from host '[USERIP]'.	
Inlet > * > Pole > * > Sensor > * > Unavailable	Sensor '[POLESENSOR]' on pole '[INLETPOLE]' of inlet '[INLET]' unavailable.	Sensor '[POLESENSOR]' on pole '[INLETPOLE]' of inlet '[INLET]' available.
Inlet > * > Pole > * > Sensor > * > Above upper critical threshold	Sensor '[POLESENSOR]' on pole '[INLETPOLE]' of inlet '[INLET]' asserted 'above upper critical'.	Sensor '[POLESENSOR]' on pole '[INLETPOLE]' of inlet '[INLET]' deasserted 'above upper critical'.
Inlet > * > Pole > * > Sensor > * > Above upper warning threshold	Sensor '[POLESENSOR]' on pole '[INLETPOLE]' of inlet '[INLET]' asserted 'above upper warning'.	Sensor '[POLESENSOR]' on pole '[INLETPOLE]' of inlet '[INLET]' deasserted 'above upper warning'.
Inlet > * > Pole > * > Sensor > * > Below lower warning threshold	Sensor '[POLESENSOR]' on pole '[INLETPOLE]' of inlet '[INLET]' asserted 'below lower warning'.	Sensor '[POLESENSOR]' on pole '[INLETPOLE]' of inlet '[INLET]' deasserted 'below lower warning'.
Inlet > * > Pole > * > Sensor > * > Below lower critical threshold	Sensor '[POLESENSOR]' on pole '[INLETPOLE]' of inlet '[INLET]' asserted 'below lower critical'.	Sensor '[POLESENSOR]' on pole '[INLETPOLE]' of inlet '[INLET]' deasserted 'below lower critical'.
Modem > Dial-in link established	An incoming call from caller '[CALLERID]' was received.	The incoming call from caller '[CALLERID]' was disconnected: [CALLENDREASON].
Modem > Modem attached	A [MODEMTYPE] modem was attached.	
Modem > Modem detached	A [MODEMTYPE] modem was removed.	
Outlet > * > Power control > Powered on	Outlet '[OUTLET]' has been powered on by user '[USERNAME]' from host '[USERIP]'.	
Outlet > * > Power control > Powered off	Outlet '[OUTLET]' has been powered off by user '[USERNAME]' from host '[USERIP]'.	
Outlet > * > Power control > Power cycled	Outlet '[OUTLET]' power cycle initiated by user '[USERNAME]' from host	

Event/Context	Default Assertion Message when the Event = TRUE	Default Assertion Message when the Event = FALSE*
	'[USERIP]'.	
Outlet > * > Sensor > * > Unavailable	Sensor '[OUTLETSENSOR]' on outlet '[OUTLET]' unavailable.	Sensor '[OUTLETSENSOR]' on outlet '[OUTLET]' available.
Outlet > * > Sensor > * > Above upper critical threshold	Sensor '[OUTLETSENSOR]' on outlet '[OUTLET]' asserted 'above upper critical'.	Sensor '[OUTLETSENSOR]' on outlet '[OUTLET]' deasserted 'above upper critical'.
Outlet > * > Sensor > * > Above upper warning threshold	Sensor '[OUTLETSENSOR]' on outlet '[OUTLET]' asserted 'above upper warning'.	Sensor '[OUTLETSENSOR]' on outlet '[OUTLET]' deasserted 'above upper warning'.
Outlet > * > Sensor > * > Below lower warning threshold	Sensor '[OUTLETSENSOR]' on outlet '[OUTLET]' asserted 'below lower warning'.	Sensor '[OUTLETSENSOR]' on outlet '[OUTLET]' deasserted 'below lower warning'.
Outlet > * > Sensor > * > Below lower critical threshold	Sensor '[OUTLETSENSOR]' on outlet '[OUTLET]' asserted 'below lower critical'.	Sensor '[OUTLETSENSOR]' on outlet '[OUTLET]' deasserted 'below lower critical'.
Outlet > * > Sensor > * > Reset	Sensor '[OUTLETSENSOR]' on outlet '[OUTLET]' has been reset by user '[USERNAME]' from host '[USERIP]'.	
Outlet > * > Sensor > State > On/Off	Outlet '[OUTLET]' state changed to on.	Outlet '[OUTLET]' state changed to off.
Outlet > * > Pole > * > Sensor > Unavailable	Sensor '[POLESENSOR]' on pole '[OUTLETPOLE]' of outlet '[OUTLET]' unavailable.	Sensor '[POLESENSOR]' on pole '[OUTLETPOLE]' of outlet '[OUTLET]' available.
Outlet > * > Pole > * > Sensor > Above upper critical threshold	Sensor '[POLESENSOR]' on pole '[OUTLETPOLE]' of outlet '[OUTLET]' asserted 'above upper critical'.	Sensor '[POLESENSOR]' on pole '[OUTLETPOLE]' of outlet '[OUTLET]' deasserted 'above upper critical'.
Outlet > * > Pole > * > Sensor > Above upper warning threshold	Sensor '[POLESENSOR]' on pole '[OUTLETPOLE]' of outlet '[OUTLET]' asserted 'above upper warning'.	Sensor '[POLESENSOR]' on pole '[OUTLETPOLE]' of outlet '[OUTLET]' deasserted 'above upper warning'.
Outlet > * > Pole > * > Sensor > Below lower warning threshold	Sensor '[POLESENSOR]' on pole '[OUTLETPOLE]' of outlet '[OUTLET]' asserted 'below lower warning'.	Sensor '[POLESENSOR]' on pole '[OUTLETPOLE]' of outlet '[OUTLET]' deasserted 'below lower warning'.
Outlet > * > Pole > * > Sensor > Below lower critical threshold	Sensor '[POLESENSOR]' on pole '[OUTLETPOLE]' of outlet '[OUTLET]' asserted 'below lower critical'.	Sensor '[POLESENSOR]' on pole '[OUTLETPOLE]' of outlet '[OUTLET]' deasserted 'below lower critical'.
Overcurrent Protector > * >	Sensor '[OCPSENSOR]' on	Sensor '[OCPSENSOR]' on

Sensor > * > Unavailable	overcurrent protector '[OCP]' unavailable.	overcurrent protector '[OCP]' available.
Overcurrent Protector > * > Sensor > * > Above upper critical threshold	Sensor '[OCPSENSOR]' on overcurrent protector '[OCP]' asserted 'above upper critical'.	Sensor '[OCPSENSOR]' on overcurrent protector '[OCP]' deasserted 'above upper critical'.
Overcurrent Protector > * > Sensor > * > Above upper warning threshold	Sensor '[OCPSENSOR]' on overcurrent protector '[OCP]' asserted 'above upper warning'.	Sensor '[OCPSENSOR]' on overcurrent protector '[OCP]' deasserted 'above upper warning'.
Overcurrent Protector > * > Sensor > * > Below lower warning threshold	Sensor '[OCPSENSOR]' on overcurrent protector '[OCP]' asserted 'below lower warning'.	Sensor '[OCPSENSOR]' on overcurrent protector '[OCP]' deasserted 'below lower warning'.
Overcurrent Protector > * > Sensor > * > Below lower critical threshold	Sensor '[OCPSENSOR]' on overcurrent protector '[OCP]' asserted 'below lower critical'.	Sensor '[OCPSENSOR]' on overcurrent protector '[OCP]' deasserted 'below lower critical'.
Overcurrent Protector > * > Sensor > * > Open/Closed	Sensor '[OCPSENSOR]' on overcurrent protector '[OCP]' is open.	Sensor '[OCPSENSOR]' on overcurrent protector '[OCP]' is closed.
PDU > Load Shedding > Started	PX placed in Load Shedding Mode by user '[USERNAME]' from host '[USERIP]'.	PX removed from Load Shedding Mode by user '[USERNAME]' from host '[USERIP]'.
Server Monitoring > * > Error	Error monitoring server '[MONITOREDHOST]': [ERRORDESC]	
Server Monitoring > * > Monitored	Server '[SERVER]' is now being monitored.	Server '[SERVER]' is no longer being monitored.
Server Monitoring > * > Unreachable	Server '[SERVER]' is unreachable.	Server '[SERVER]' is reachable.
Server Monitoring > * > Unrecoverable	Connection to server '[MONITOREDHOST]' could not be restored.	
User Activity > * > User logon state	User '[USERNAME]' from host '[USERIP]' logged in.	User '[USERNAME]' from host '[USERIP]' logged out.
User Activity > * > Authentication failure	Authentication failed for user '[USERNAME]' from host '[USERIP]'.	
User Activity > * > User accepted the Restricted Service Agreement	User '[USERNAME]' from host '[USERIP]' accepted the Restricted Service Agreement.	User '[USERNAME]' from host '[USERIP]' declined the Restricted Service Agreement.
User Activity > * > User blocked	User '[USERNAME]' from host '[USERIP]' was blocked.	
User Activity > * > Session timeout	Session of user '[USERNAME]' from host '[USERIP]' timed out.	

User Administration > User added	User '[TARGETUSER]' added by user '[USERNAME]' from host '[USERIP]'.	
User Administration > User modified	User '[TARGETUSER]' modified by user '[USERNAME]' from host '[USERIP]'.	
User Administration > User deleted	User '[TARGETUSER]' deleted by user '[USERNAME]' from host '[USERIP]'.	
User Administration > Password changed	Password of user '[TARGETUSER]' changed by user '[USERNAME]' from host '[USERIP]'.	
User Administration > Password settings changed	Password settings changed by user '[USERNAME]' from host '[USERIP]'.	
User Administration > Role added	Role '[TARGETROLE]' added by user '[USERNAME]' from host '[USERIP]'.	
User Administration > Role modified	Role '[TARGETROLE]' modified by user '[USERNAME]' from host '[USERIP]'.	
User Administration > Role deleted	Role '[TARGETROLE]' deleted by user '[USERNAME]' from host '[USERIP]'.	
Webcam Management > Webcam attached	Webcam '[WEBCAMNAME]' ('[WEBCAMUVCID]') added to port '[WEBCAMUSBPORT]'.	
Webcam Management > Webcam detached	Webcam '[WEBCAMNAME]' ('[WEBCAMUVCID]') removed from port '[WEBCAMUSBPORT]'.	
Webcam Management > Webcam settings changed	Webcam '[WEBCAMNAME]' settings changed by user '[USERNAME]'.	
LHX / SHX > Connected	LHX has been connected to [PORTTYPE] port [PORTID].	LHX has been disconnected from [PORTTYPE] port [PORTID].
LHX / SHX > Operational State	LHX connected to [PORTTYPE] port [PORTID] has been switched on.	LHX connected to [PORTTYPE] port [PORTID] has been switched off.
LHX / SHX > Sensor > Unavailable	Sensor '[LHXSENSORID]' on LHX at [PORTTYPE] port '[PORTID]' unavailable.	Sensor '[LHXSENSORID]' on LHX at [PORTTYPE] port '[PORTID]' available.
LHX / SHX > Sensor > Above upper critical threshold	Sensor '[LHXSENSORID]' on LHX at [PORTTYPE] port '[PORTID]' asserted 'above upper critical'.	Sensor '[LHXSENSORID]' on LHX at [PORTTYPE] port '[PORTID]' deasserted 'above upper critical'.
LHX / SHX > Sensor > Above upper warning threshold	Sensor '[LHXSENSORID]' on LHX at [PORTTYPE] port '[PORTID]' asserted 'above upper warning'.	Sensor '[LHXSENSORID]' on LHX at [PORTTYPE] port '[PORTID]' deasserted 'above upper warning'.

LHX / SHX > Sensor > Below lower warning threshold	Sensor '[LHXSENSORID]' on LHX at [PORTTYPE] port '[PORTID]' asserted 'below lower warning'.	Sensor '[LHXSENSORID]' on LHX at [PORTTYPE] port '[PORTID]' deasserted 'below lower warning'.
LHX / SHX > Sensor > Below lower critical threshold	Sensor '[LHXSENSORID]' on LHX at [PORTTYPE] port '[PORTID]' asserted 'below lower critical'.	Sensor '[LHXSENSORID]' on LHX at [PORTTYPE] port '[PORTID]' deasserted 'below lower critical'.
LHX / SHX > Base Electronics Failure	The base electronics on LHX at [PORTTYPE] port '[PORTID]' failed.	
LHX / SHX > Condenser Pump Failure	The condenser pump on LHX at [PORTTYPE] port '[PORTID]' failed.	The condenser pump on LHX at [PORTTYPE] port '[PORTID]' is back to normal.
LHX / SHX > Emergency Cooling	Emergency cooling on LHX at [PORTTYPE] port '[PORTID]' was activated.	Emergency cooling on LHX at [PORTTYPE] port '[PORTID]' was deactivated.
LHX / SHX > Maximum cooling request	Maximum cooling was requested for LHX at [PORTTYPE] port '[PORTID]'.	Maximum cooling is not any more requested for LHX at [PORTTYPE] port '[PORTID]'.
LHX / SHX > Parameter Data Loss	Data loss in parameter memory was detected on LHX at [PORTTYPE] port '[PORTID]'.	
LHX / SHX > ST-Bus Communication Error	An ST-Bus communication error was detected on LHX at [PORTTYPE] port '[PORTID]'.	
LHX / SHX > Collective fault	A collective fault occurred on LHX at [PORTTYPE] port '[PORTID]'.	
LHX / SHX > Door Contact	The door of LHX at [PORTTYPE] port '[PORTID]' was opened.	The door of LHX at [PORTTYPE] port '[PORTID]' was closed.
LHX / SHX > Sensor Failure	A sensor failure (broken or short circuit) occurred on LHX at [PORTTYPE] port '[PORTID]' at sensor '[LHXSENSORID]'.	
LHX / SHX > Fan Failure	A fan motor failure occurred on LHX at [PORTTYPE] port '[PORTID]' at fan '[LHXFANID]'.	
LHX / SHX > Power Supply Failure	A power supply failure occurred on LHX at [PORTTYPE] port '[PORTID]' at power supply '[LHXPOWERSUPPLYID]'.	
LHX / SHX > Threshold Air Inlet	The air inlet temperature threshold on LHX at [PORTTYPE] port '[PORTID]' was crossed.	The air inlet temperature on LHX at [PORTTYPE] port '[PORTID]' is within thresholds.

LHX / SHX > Threshold Air Outlet	The air outlet temperature threshold on LHX at [PORTTYPE] port '[PORTID]' was crossed.	The air outlet temperature on LHX at [PORTTYPE] port '[PORTID]' is within thresholds.
LHX / SHX > Threshold Water Inlet	The water inlet temperature threshold on LHX at [PORTTYPE] port '[PORTID]' was crossed.	The water inlet temperature on LHX at [PORTTYPE] port '[PORTID]' is within thresholds.
LHX / SHX > Threshold Water Outlet	The water outlet temperature threshold on LHX at [PORTTYPE] port '[PORTID]' was crossed.	The water outlet temperature on LHX at [PORTTYPE] port '[PORTID]' is within thresholds.
LHX / SHX > Voltage Low	The supply voltage on LHX at [PORTTYPE] port '[PORTID]' is low.	The supply voltage on LHX at [PORTTYPE] port '[PORTID]' is back to normal.
LHX / SHX > Threshold Humidity	The humidity threshold on LHX at [PORTTYPE] port '[PORTID]' was crossed.	The humidity on LHX at [PORTTYPE] port '[PORTID]' is within thresholds.
LHX / SHX > External Water Cooling Failure	An external water cooling failure occurred on LHX at [PORTTYPE] port '[PORTID]'.	
LHX / SHX > Water Leak	Water leakage was detected on LHX at [PORTTYPE] port '[PORTID]'.	

---

*\*Note: Not set for 'trigger' events.*

---

#### Email and SMS Message Placeholders

Following are placeholders that can be used in custom event email messages.

---

*Note: Click the Information icon ⓘ to open the Event Context Information dialog, which contains a list of placeholders and their definitions. Then select the desired placeholder, and either double-click it or click the "Paste into Message" button to insert it into the customized message.*

---

Placeholder	Definition
[ACTIVEINLET]	The label of the newly activated inlet
[AMSBLADESLOTPOSITION]	The (horizontal) slot position, an action applies to
[AMSLEDCOLOR]	The RGB LED color
[AMSLEDMODE]	The LED indication mode
[AMSLEDOPMODE]	The LED operating mode
[AMSNAME]	The name of an asset strip
[AMSNUMBER]	The numeric ID of an asset strip



Placeholder	Definition
[AMSRACKUNITPOSITION]	The (vertical) rack unit position, an action applies to
[AMSSTATE]	The human readable state of an asset strip
[AMSTAGID]	The asset tag ID
[CONFIGPARAM]	The name of a configuration parameter
[CONFIGVALUE]	The new value of a parameter
[DATETIME]	The human readable timestamp of the event occurrence
[DEVICEIP]	The IP address of the device, the event occurred on
[DEVICENAME]	The name of the device, the event occurred on
[ERRORDESC]	The error message
[EVENTRULENAME]	The name of the matching event rule
[EXTSENSORNAME]	The name of a peripheral device
[EXTSENSORSLOT]	The ID of a peripheral device slot
[EXTSENSOR]	The peripheral device identifier
[IFNAME]	The human readable name of a network interface
[INLETPOLE]	The inlet power line identifier
[INLETSENSOR]	The inlet sensor name
[INLET]	The power inlet label
[ISASSERTED]	Boolean flag whether an event condition was entered (1) or left (0)
[LDAPERRORDESC]	An LDAP error occurred
[LHXFANID]	The ID of a fan connected to an LHX/SHX
[LHXPOWERSUPPLYID]	The ID of an LHX/SHX power supply
[LHXSENSORID]	The ID of an LHX/SHX sensor probe
[MONITOREDHOST]	The name or IP address of a monitored host
[OCPSENSOR]	The overcurrent protector sensor name
[OCP]	The overcurrent protector label
[OLDVERSION]	The firmware version the device is being upgraded from
[OUTLETPOLE]	The outlet power line identifier
[OUTLETSENSOR]	The outlet sensor name
[OUTLET]	The outlet label

Placeholder	Definition
[PDUPOLESENSOR]	The sensor name for a certain power line
[PDUSENSOR]	The PDU sensor name
[PERIPHDEVPOSITION]	The position of an attached peripheral device
[PORTID]	The label of the external port, the event triggering device is connected to
[PORTTYPE]	The type of the external port (for example, 'feature' or 'auxiliary'), the event triggering device is connected to
[RADIUSERRORDESC]	A Radius error occurred
[ROMCODE]	The rom code of an attached peripheral device
[SENSORREADINGUNIT]	The unit of a sensor reading
[SENSORREADING]	The value of a sensor reading
[SENSORREPORT]	The formatted sensor report contents
[SENSORSTATENAME]	The human readable state of a sensor
[SMTPRECIPIENTS]	The list of recipients, an SMTP message was sent to
[SMTPSERVER]	The name or IP address of an SMTP server
[SYSCONTACT]	SysContact as configured for SNMP
[SYSLOCATION]	SysLocation as configured for SNMP
[SYSNAME]	SysName as configured for SNMP
[TIMEREVENTID]	The id of a timer event
[TIMESTAMP]	The timestamp of the event occurrence
[TRANSFERSWITCHREASON]	The transfer reason
[TRANSFERSWITCHSENSOR]	The transfer switch sensor name
[TRANSFERSWITCH]	The transfer switch label
[UMTARGETROLE]	The name of a user management role, an action was applied on
[UMTARGETUSER]	The user, an action was triggered for
[USERIP]	The IP address, a user connected from
[USERNAME]	The user who triggered an action
[VERSION]	The firmware version the device is upgrading to

---

## Sample Event Rules

### Sample PDU-Level Event Rule

In this example, we want the PX to record the firmware upgrade failure in the internal log when it happens. The sample event rule looks like this:

- Event: Device > Firmware update failed
- Actions: System Event Log Action

► **To create the above event rule:**

1. Select Event > Device to indicate we are specifying an event at the PDU level.
2. Select "Firmware update failed" in the submenu because we want the PX to respond to the event related to firmware upgrade failure.
3. Select System Event Log Action as we intend to record the firmware update failure event in the internal log.

### Sample Outlet-Level Event Rule

In this example, we want the PX to send SNMP notifications to the SNMP manager for any sensor change event of outlet 3.

---

*Note: The SNMP notifications may be SNMP v2c or SNMP v3 traps or informs, depending on the settings for the System SNMP Notification Action. See **Configuring SNMP Notifications** (on page 308).*

---

To do that we would set up an event rule like this:

- Event: Outlet > Outlet 3 > Sensor > Any sub-event
- Actions: System SNMP Notification Action

► **To create the above event rule:**

1. Select Event > Outlet to indicate we are specifying an event at the outlet level.
2. Select "Outlet 3" from the submenu because that is the outlet in question.
3. Select "Sensor" to refer to sensor events.
4. Select "Any sub-event" because we want to specify all events related to all types of outlet sensors and thresholds, such as current, voltage, upper critical threshold, upper warning threshold, lower critical threshold, lower warning threshold, and so on.
5. Select "System SNMP Notification Action" to send SNMP notifications to respond to the specified event.

Then the SNMP notifications are sent when:

- Any numeric sensor's reading moves past any threshold into the warning or critical range.
- Any sensor reading or state returns to normal.
- Any sensor becomes unavailable.
- The active energy sensor is reset.
- Any discrete sensor changes its state -- either from normal to alarmed or from alarmed to normal.

For example, when the outlet 3's voltage crosses into the upper warning range, the SNMP notifications are sent, and when the voltage drops below the upper warning threshold, the SNMP notifications are sent again.

### Sample Inlet-Level Event Rule

In this example, we want the PX to send SNMP notifications to the SNMP manager for any sensor change event of the Inlet I1.

---

*Note: The SNMP notifications may be SNMP v2c or SNMP v3 traps or informs, depending on the settings for the System SNMP Notification Action. See **Configuring SNMP Notifications** (on page 308).*

---

The event rule is set like this:

- Event: Inlet > Inlet I1 > Sensor > Any sub-event
- Actions: System SNMP Notification Action

#### ► To create the above event rule:

1. Select Event > Inlet to indicate we are specifying an event at the inlet level.
2. Select "Inlet I1" from the submenu because that is the inlet in question.
3. Select "Sensor" to refer to sensor events.
4. Select "Any sub-event" because we want to specify all events related to all types of inlet sensors and thresholds, such as current, voltage, upper critical threshold, upper warning threshold, lower critical threshold, lower warning threshold, and so on.
5. Select "System SNMP Notification Action" to send SNMP notifications to respond to the specified event.

Then the SNMP notifications are sent when:

- Any numeric sensor's reading moves past any threshold into the warning or critical range.
- Any sensor reading or state returns to normal.
- Any sensor becomes unavailable.

- The active energy sensor is reset.

For example, when the Inlet I1's voltage enters the upper warning range, the SNMP notifications are sent, and when the voltage drops below the upper warning threshold, returning to the normal state, the SNMP notifications are sent again.

### Sample Environmental-Sensor-Level Event Rule

This section applies to outlet-switching capable models only.

In this example, we want PX to enable the load shedding function when a contact closure sensor enters the alarmed state. This sample event rule requires creating a new action before creating the rule.

#### ► Step 1: create a new action for enabling the load shedding mode

1. Choose Device Settings > Event Rules. The Event Rule Settings dialog appears.
2. Click the Actions tab.
3. Click New Action.
4. In the Action Name field, type a name to identify this action. In this illustration, type Activate Load Shedding.
5. In the Action field, select "Change load shedding state."
6. In the Operation field, select Start Load Shedding.
7. Click Save to save this action.

After the new action for enabling the load shedding mode is created, you can create an event rule that can trigger the load shedding mode when the contact closure sensor enters the alarmed state. This sample event rule looks like this:

- Event: Peripheral Device Slot > Slot 1 > State Sensor > Alarmed/Open/On
- Trigger condition: Alarmed/Open/On
- Actions: Activate Load Shedding

#### ► Step 2: create the contact closure triggered load shedding event rule

1. Click the Rules tab.
2. Click New Rule.
3. In the "Rule name" field, type a name to identify this event rule. In this illustration, type Contact Closure Triggered Load Shedding.
4. Select the Enabled checkbox. Otherwise, the new event rule will not be carried out.

5. Select Events > Peripheral Device Slot to indicate we are specifying an event related to the environmental sensor.
6. Select the ID number of the desired contact closure sensor. In this illustration, the ID number of the desired contact closure sensor is 1, so select Slot 1 in the submenu.
7. Select State Sensor because the contact closure sensor is a discrete sensor, which indicates the environmental changes through the status changes.
8. Select "Alarmed/Open/On" in the submenu since we want the action "Activate Loading Shedding" to be taken when the selected contact closure sensor changes its state related to the "alarmed" state.
9. In the "Trigger condition" field, select the Alarmed radio button because we want the PX to respond to the event only when the contact closure sensor enters the Alarm state.

---

**A Note about Infinite Loop**

You should avoid building an infinite loop when creating event rules.

The infinite loop refers to a condition where the PX keeps busy because the action or one of the actions taken for a certain event triggers an identical or similar event which will result in an action triggering one event again.

**Example 1**

This example illustrates an event rule which continuously causes the PX to send out email messages.

Event selected	Action included
Device > Sending SMTP message failed	Send email

**Example 2**

This example illustrates an event rule which continuously causes the PX to send out SMTP messages when one of the selected events listed on the Device menu occurs. Note that <Any sub-event> under the Device menu includes the event "Sending SMTP message failed."

Event selected	Action included
Device > Any sub-event	Send email

**Example 3**

This example illustrates a situation where two event rules combined regarding the outlet state changes causes the PX to continuously power cycle outlets 1 and 2.

Event selected	Action included
Outlet > Outlet 1 > Sensor > State > On/Off	Cycle Outlet 2 (Switch Outlets --> Cycle Outlet --> Outlet 2)
Outlet > Outlet 2 > Sensor > State > On/Off	Cycle Outlet 1 (Switch Outlets --> Cycle Outlet --> Outlet 1)

**Modifying an Event Rule**

You can change an event rule's event, action, trigger condition and other settings, if any.





*Exception: Events and actions selected in the built-in event rules are not changeable, including System Event Log Rule, System SNMP Notification Rule, System Tamper Detection Alarmed, and System Tamper Detection Unavailable.*

► **To modify an event rule:**

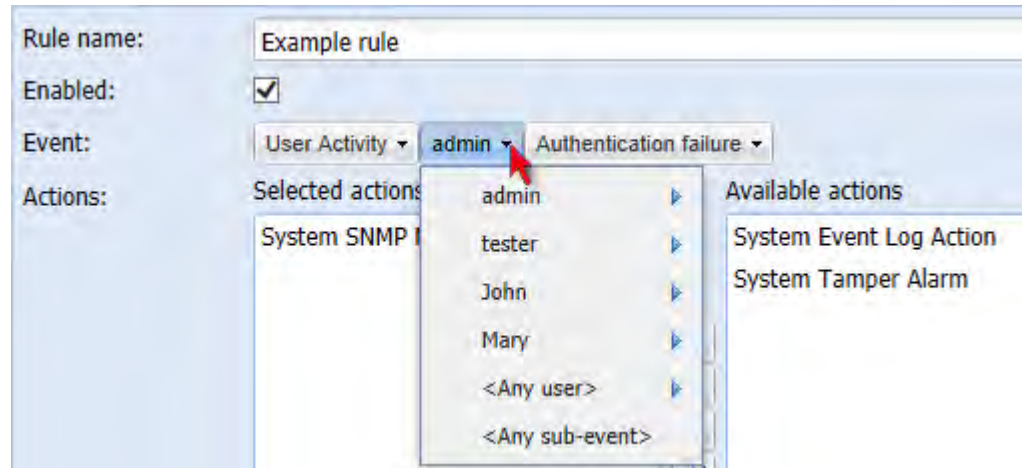
1. Choose Device Settings > Event Rules. The Event Rule Settings dialog appears.
2. On the Rules tab, select the event rule that you want to modify and click Edit, or simply double-click that rule.
3. To disable the event rule, deselect the Enabled checkbox.
4. To change the event, click the desired tab in the Event field and select a different item from the pull-down menu or submenu.

For example, in a user activity event rule for the "admin" user, you can click the "admin" tab to display a pull-down submenu showing all user names, and then select a different user name or all users (shown as <Any user>).



5. If the "Trigger condition" field is available, you may select a radio button other than the current selection to change the rule triggering condition.
6. To change the action(s), do any of the following in the Actions field:
  - To add any action, select it from the "Available actions" list box, and click . To make multiple selections, press Ctrl+click or Shift+click to highlight multiple ones.
  - To add all actions, click .
  - To remove any action, select it from the "Selected actions" list box, and click  to move it back to the "Available actions" list box. To make multiple selections, press Ctrl+click or Shift+click to highlight multiple ones.
  - To remove all actions, click .
  - To create a new action, click Create New Action. The newly created action will be moved to the "Selected actions" list box once it is created. See **Creating Actions** (on page 200) for information on creating an action.
7. Click OK to save the changes.

---

*Note: If you do not click OK before quitting the current settings page, a message appears. Then click Yes to save the changes, Discard to abort or Cancel to return to the current settings page.*

---

8. Click Close to quit the dialog.



---

## Modifying an Action

An existing action can be changed so that all event rules where this action is involved change their behavior accordingly.

---

*Exception: The built-in actions "System Event Log Action" and "System Tamper Alarm" are not user-configurable.*

---

► **To modify an action:**

1. Choose Device Settings > Event Rules. The Event Rule Settings dialog appears.
2. Click the Actions tab.
3. Select the action that you want to modify and click Edit, or simply double-click that action.
4. Make necessary changes to the information shown.
5. Click OK to save the changes.

---

*Note: If you do not click OK before quitting the current settings page, a message appears. Then click Yes to save the changes, Discard to abort or Cancel to return to the current settings page.*

---

6. Click Close to quit the dialog.

---

## Deleting an Event Rule or Action

If any event rule or action is obsolete, simply remove it.

---

*Note: You cannot delete the built-in event rules and actions.*

---

► **To delete an event rule or action:**

1. Choose Device Settings > Event Rules. The Event Rule Settings dialog appears.
2. To delete an event rule:
  - a. Ensure the Rules tab is selected. If not, click the Rules tab.
  - b. Select the desired rule from the list. To make multiple selections, press Ctrl+click or Shift+click to highlight multiple ones.
  - c. Click Delete.
  - d. Click Yes on the confirmation message.
3. To delete an action:
  - a. Click the Actions tab.
  - b. Select the desired action from the list. To make multiple selections, press Ctrl+click or Shift+click to highlight multiple ones.

- c. Click Delete.
  - d. Click Yes on the confirmation message.
4. Click Close to quit the dialog.

---

### A Note about Untriggered Rules

In some cases, a measurement exceeds a threshold causing the PX to generate an alert. The measurement then returns to a value within the threshold, but the PX does not generate an alert message for the Deassertion event. Such scenarios can occur due to the hysteresis tracking the PX uses. See *"To De-assert" and Deassertion Hysteresis* (on page 596).

---

## Managing Event Logging

By default, the PX captures certain system events and saves them in a local (internal) event log.

---

### Viewing the Local Event Log





You can view over 2000 historical events that occurred to the PX device in the local event log.

When the log size exceeds 256KB, each new entry overwrites the oldest entry.



► **To display the local log:**

1. Choose Maintenance > View Event Log. The Event Log dialog appears.

Each event entry in the local log consists of:

- Date and time of the event
  - Type of the event
  - A description of the event
  - ID number of the event
2. The dialog shows the final page by default. You can:
    - Switch between different pages by doing one of the following:
      - Click  or  to go to the first or final page.
      - Click  or  to go to the prior or next page.
      - Type a number in the Page text box and press Enter to go to a specific page.
    - Select a log entry from the list and click Show Details, or simply double-click the log entry to view detailed information.

---

*Note: Sometimes when the dialog is too narrow, the icon  takes the place of the Show Details button. In that case, click  and select Show Details to view details.*

---

- Click  to view the latest events.
- View a specific type of events only by selecting an event type in the Filter Event Class field.

### Clearing Event Entries

If it is not necessary to keep existing event history, you can remove all of it from the local log.

#### ► To delete all event entries:

1. Choose Maintenance > View Event Log. The Event Log dialog appears.
2. Click Clear Event Log.
3. Click Yes on the confirmation message.

---

### Viewing the Wireless LAN Diagnostic Log

The PX provides a diagnostic log for inspecting connection errors that occurred over the wireless network interface. The information is useful for technical support engineers.

#### ► To display the wireless LAN diagnostic log:

1. Choose Device Settings > Network. The Network Configuration dialog appears.
2. Click Show WLAN Diagnostic Log. The WLAN Diagnostic Log dialog appears.





Each entry in the log consists of the event's:

- ID number
- Date and time
- Description

---

*Note: The Show WLAN Diagnostic Log button is available only when the Network Interface is set to Wireless.*



---

3. The dialog shows the final page by default. You can:
  - Switch between different pages by doing one of the following:
    - Click  or  to go to the first or final page.
    - Click  or  to go to the prior or next page.

- Type a number in the Page text box and press Enter to go to a specific page.

- Select a log entry from the list and click Show Details, or simply double-click the log entry to view detailed information.

---

*Note: Sometimes when the dialog is too narrow, the icon  takes the place of the Show Details button. In that case, click  and select Show Details to view details.*

---

- Click  to view the latest events.

▶ **To clear the diagnostic log:**

1. Click Clear WLAN Diagnostic Log.
2. Click Yes on the confirmation message.

---

## Viewing Connected Users

You can see which users are connected to the PX device and their status. If you have administrator privileges, you can terminate any user's connection to the PX device.

▶ **To view connected users:**

1. Choose Maintenance > Connected Users. The Connected Users dialog appears, showing a list of connected users with the following information:

Column	Description
User Name	The login name used by each connected user.
IP Address	The IP address of each user's host.  For the login via a local connection (serial RS-232 or USB), <local> is displayed instead of an IP address.
Client Type	The interface through which the user is being connected to the PX. <ul style="list-style-type: none"> <li>▪ Web GUI: Refers to the PX web interface.</li> <li>▪ CLI: Refers to the command line interface (CLI).</li> </ul> <p>The information in parentheses following "CLI" indicates how this user is connected to the CLI.</p> <ul style="list-style-type: none"> <li>- <i>Serial</i>: Represents the local connection (serial RS-232 or USB).</li> <li>- <i>SSH</i>: Represents the SSH connection.</li> <li>- <i>Telnet</i>: Represents the Telnet connection.</li> </ul>

Column	Description
Idle Time	The length of time for which a user remains idle. The unit "min" represents minutes.

2. To disconnect any user, click the corresponding Disconnect button.
  - a. A dialog appears, prompting you to confirm the operation.
  - b. Click Yes to disconnect the user or No to abort the operation. If clicking Yes, the connected user is forced to log out.
3. You may change the sorting order of the list if necessary. See **Changing the Sorting** (on page 85).
4. Click Close to quit the dialog.

---

*Note: All Live Preview sessions sharing the same URL, including one Primary Standalone Live Preview window and two associated remote sessions, are identified as one single "<webcam>" user in the Connected Users dialog. You can disconnect a "<webcam>" user from this dialog to terminate a specific Primary Standalone Live Preview window and all of its remote sessions. See **Sending Snapshots or Videos in an Email or Instant Message** (on page 284).*

---

## Monitoring Server Accessibility

You can monitor whether specific IT devices are alive by having the PX device continuously ping them. An IT device's successful response to the ping commands indicates that the IT device is still alive and can be remotely accessed.

This function is especially useful when you are not located in an area with Internet connectivity.

---

### Adding IT Devices for Ping Monitoring

PX can monitor the accessibility of any type of IT equipment, such as database servers, remote authentication servers, power distribution units (PDUs), and so on.

PX supports monitoring a maximum of 8 devices.

The default ping settings may not be suitable for monitoring devices that require high connection reliability so it is strongly recommended that you should adjust the ping settings to meet your own needs.

---

*Tip: To make the PX automatically log, send notifications or perform other actions for any server accessibility or inaccessibility events, you can create event rules associated with server monitoring. See **Event Rules and Actions** (on page 199).*

---

► **To add IT equipment for ping monitoring:**

1. Choose Device Settings > Server Reachability. The Server Reachability dialog appears.
2. Click New. The Add New Server dialog appears.
3. By default, the "Enable ping monitoring for this server" checkbox is selected. If not, select it to enable this feature.
4. Provide the information required.

Field	Description
IP address/hostname	IP address or host name of the IT equipment which you want to monitor.
Number of successful pings to enable feature	The number of successful pings required to declare that the monitored equipment is "Reachable." Valid range is 0 to 200.
Wait time (in seconds) after successful ping	The wait time before sending the next ping if the previous ping was successfully responded. Valid range is 5 to 600 (seconds).
Wait time (in seconds) after unsuccessful ping	The wait time before sending the next ping if the previous ping was not responded. Valid range is 3 to 600 (seconds).
Number of consecutive unsuccessful pings for failure	The number of consecutive pings without any response before the monitored equipment is declared "Unreachable." Valid range is 1 to 100.

Field	Description
Wait time (in seconds) before resuming pinging after failure	The wait time before the PX resumes pinging after the monitored equipment is declared "Unreachable." Valid range is 1 to 1200 (seconds).
Number of consecutive failures before disabling feature (0 = unlimited)	The number of times the monitored equipment is declared "Unreachable" consecutively before the PX disables the ping monitoring feature for it and shows "Waiting for reliable connection." Valid range is 0 to 100.

5. Click OK.
6. To add more IT devices, repeat Steps 2 to 5.
7. Click Close to quit the dialog.

In the beginning, the status of the monitored equipment shows "Waiting for reliable connection," which means the requested number of consecutive successful or unsuccessful pings has not reached before the PX can declare that the monitored device is reachable or unreachable.

#### Example: Ping Monitoring and SNMP Notifications

In this illustration, it is assumed that a significant PDU (IP address: 192.168.84.95) shall be monitored by your PX to make sure that PDU is properly operating all the time, and the PX must send out SNMP notifications (trap or inform) if that PDU is declared unreachable due to power or network failure. The prerequisite for this example is that the power source for your PX is different from the power source for that PDU.

This requires two steps: set up the PDU monitoring and create an event rule.

#### ► Step 1: Set up the ping monitoring for the target PDU

1. Choose Device Settings > Server Reachability. The Server Reachability dialog appears.
2. Click New.
3. Type 192.168.84.95 in the "IP address/hostname" field.
4. Ensure the "Enable ping monitoring for this server" checkbox is selected.
5. To make the PX declare the accessibility of the monitored PDU every 15 seconds (3 pings \* 5 seconds) when that PDU is accessible, do the following:
  - a. In the "Number of successful pings to enable feature" field, type 3.

- b. In the "Wait time (in seconds) after successful ping" field, type 5.
  6. To make the PX declare the inaccessibility of the monitored PDU when that PDU becomes inaccessible for around 12 seconds (4 pings \* 3 seconds), do the following:
    - a. In the "Number of consecutive unsuccessful pings for failure" field, type 4.
    - b. In the "Wait time (in seconds) after unsuccessful ping" field, type 3.
  7. In the "Wait time (in seconds) before resuming pinging" field, type 60 to make the PX stops pinging the target PDU for 60 seconds (1 minute) after the PDU inaccessibility is declared. After 60 seconds, the PX will re-ping the target PDU.

► **Step 2: Create an event rule to send SNMP notifications for this PDU**

1. Choose Device Settings > Event Rules. The Event Rule Settings dialog appears.
2. Click New.
3. In the "Rule name" field, type "Send SNMP notifications for PDU (192.168.84.95) inaccessibility."
4. Select the Enabled checkbox to enable this new rule.
5. In the Event field, choose Server Monitoring > 192.168.84.95 > Unreachable.
6. In the "Trigger condition" field, select the Unreachable radio button. This makes the PX react only when the target PDU becomes inaccessible.
7. Select the System SNMP Notification Action from the "Available actions" list box, and click  to add it to the "Selected actions" list box.

---

*Note: If you have not configured the System SNMP Notification Action to specify the SNMP destination(s), see **Configuring SNMP Notifications** (on page 308).*

---

---

### Editing Ping Monitoring Settings

You can edit the ping monitoring settings for any IT device whenever needed.

► **To modify the ping monitoring settings for an IT device:**

1. Choose Device Settings > Server Reachability. The Server Reachability dialog appears.



2. Select the IT device whose settings you want to modify.
3. Click Edit or double-click that IT device. The Edit Server 'XXX' dialog appears, where XXX is the IP address or host name of the IT device.
4. Make changes to the information shown.
5. Click OK.

---

### Deleting Ping Monitoring Settings

When it is not necessary to monitor the accessibility of any IT device, just remove it.

► **To delete ping monitoring settings for an IT device:**



1. Choose Device Settings > Server Reachability. The Server Reachability dialog appears.
2. Select the IT device that you want to remove. To make multiple selections, press Ctrl+click or Shift+click to highlight multiple ones.
3. Click Delete.
4. Click Yes on the confirmation message.
5. Click Close to quit the dialog.

---

### Checking Server Monitoring States

Server monitoring results are available in the Server Reachability dialog after specifying IT devices for the PX device to monitor their network accessibility.

► **To check the server monitoring states and results:**

1. Choose Device Settings > Server Reachability. The Server Reachability dialog appears.
2. The column labeled "Ping Enabled" indicates whether the monitoring for the corresponding IT device is activated or not.
  -  : This icon denotes that the monitoring for the corresponding device is enabled.
  -  : This icon denotes that the monitoring for the corresponding device is disabled.
3. The column labeled "Status" indicates the accessibility of each monitored equipment.

Status	Description
Reachable	The monitored equipment is accessible.
Unreachable	The monitored equipment is inaccessible.

Waiting for reliable connection	The connection between the PX device and the monitored equipment is not reliably established yet.
---------------------------------	---

4. You may change the sorting order of the list if necessary. Or hide some columns. See **Changing the View of a List** (on page 84).
5. Click Close to quit the dialog.

---

## Environmental Sensors and Actuators

The PX can monitor the environmental conditions, such as temperature and humidity, where environmental sensors are placed. If an actuator is connected to the PX, you can use it to control a system or mechanism.

► **To add environmental sensors and actuators:**

1. Physically connect environmental sensor packages to the PX device. See **Connecting Environmental Sensor Packages** (on page 30).
2. Log in to the PX web interface. The PX should have detected the connected sensors and actuators, and display them in the web interface.
3. Identify each sensor and actuator. See **Identifying Environmental Sensors and Actuators** (on page 255).
4. The PX should automatically manage the detected sensors and actuators. Verify whether detected sensors and actuators are managed. If not, have them managed. See **Managing Environmental Sensors or Actuators** (on page 258).
5. Configure the sensors and actuators. See **Configuring Environmental Sensors or Actuators** (on page 259). The steps include:
  - a. Name the sensor or actuator.
  - b. If the connected sensor is a Raritan contact closure sensor, specify an appropriate sensor type.
  - c. Mark the sensor or actuator's physical location on the rack or in the room.
  - d. For a numeric sensor, configure the sensor's threshold, hysteresis and assertion timeout settings.

---

*Note: Numeric sensors show both numeric readings and sensor states to indicate environmental or internal conditions while discrete (on/off) sensors show sensor states only to indicate state changes. Only numeric sensors have threshold settings. As for actuators, they are used to control a device or system so they show state changes only.*

---

---

### Identifying Environmental Sensors and Actuators

Raritan has developed three types of environmental sensor packages - DPX, DPX2 and DX series. The ways to identify each type of environmental sensor packages in the web interface are different.

- DPX series: This type of environmental sensor package can be identified through its serial number.
- DPX2 and DX series: This type of environmental sensor package can be identified either through its serial number or through its chain position, which consists of the sensor port and its location in the daisy chain.

See **Matching the Serial Number** (on page 255) and **Matching the Position** (on page 256) in the PX Online Help.

---

*Note: For detailed information on each sensor package, refer to the Environmental Sensors Guide or Online Help on Raritan website's **PX2 Support Files page** (<https://www.raritan.com/support/product/px2/px2-support-files>).*

---

#### Matching the Serial Number

A DPX environmental sensor package includes a serial number tag on the sensor cable.



A DPX2 or DX sensor has a serial number tag attached to its rear side.



The serial number for each sensor or actuator appears listed in the web interface after each sensor or actuator is detected by the PX.

► **To identify each detected environmental sensor or actuator via serial numbers:**

1. Click Peripheral Devices in the Explorer pane, and the Peripheral Devices page opens in the right pane.
2. Match the serial number from the tag to those listed in the sensor table.

ID	Name	Position	Serial Number	Type	Channel	Actuator	Reading	State
1	Temperature 1	Port 1	AEI7A00022	Temperature			24.2 °C	normal
2	Humidity 1	Port 1	AEI7A00022	Humidity			60 %	normal
3	Temperature 2	Port 1	AEI7A00021	Temperature			24.4 °C	normal
4	Humidity 2	Port 1	AEI7A00021	Humidity			59 %	normal
5	On/Off 1	Port 1	PRC0190292	Contact (On/Off)	1			normal
6	On/Off 2	Port 1	PRC0190292	Contact (On/Off)	2			normal

**Matching the Position**

Both DPX2 and DX sensor packages can be daisy chained. The PX can indicate each sensor or actuator's position by showing the sensor port where the environmental sensor package is connected as well as its sequence in a sensor daisy chain.

► **To identify an environmental sensor or actuator through its position:**

1. Click Peripheral Devices in the Explorer pane, and the Peripheral Devices page opens in the right pane.
2. Locate the Position column, which shows one or two pieces of position information - the sensor port number and, if the sensor package is DPX2 or DX series, the sensor or actuator's location in a chain.

ID	Name	Position	Serial Number	Type	Channel	Actuator	Reading	State
1	Temperature 1	Port 1	AEI7A00022	Temperature			24.2 °C	normal
2	Humidity 1	Port 1	AEI7A00022	Humidity			60 %	normal
3	Temperature 2	Port 1	AEI7A00021	Temperature			24.4 °C	normal
4	Humidity 2	Port 1	AEI7A00021	Humidity			59 %	normal
5	On/Off 1	Port 1	PRC0190292	Contact (On/Off)	1			normal
6	On/Off 2	Port 1	PRC0190292	Contact (On/Off)	2			normal

- For DPX sensor series, the PX only displays the sensor port where it is physically connected.

For example, if a DPX environmental sensor package is connected to the SENSOR port numbered 1, its Position column shows "Port 1."

---

*Note: For the PX devices with only one SENSOR port, it always shows "Port 1."*

---

- For DPX2 and DX sensor series, the PX displays the sensor package's position in the chain in addition to the sensor port number.

For example, if a sensor or actuator is located on the second sensor package in the sensor chain connected to the SENSOR port 1, its Position column shows "Port 1, Chain Position 2."

### Identifying Sensor or Actuator Channels

A sensor package may have multiple contact closure (CC) or dry contact (DC) channels, such as DX-D2C6 or DX-PD2C5.

When the PX initially detects and automatically manages a sensor package with multiple channels, all channels are assigned with ID numbers in sequence.

If you manually manage these channels by selecting "Automatically assign a sensor number," the PX assigns ID numbers randomly because this option assumes that users do not care about the sequence. In this case, see the Channel column to identify each channel correctly. For example, CC1 or DC1 is Channel 1, CC2 or DC2 is Channel 2, and so on.

ID	Name	Position	Serial Number	Type	Channel	Actuator	Reading	State
1	On/Off 1	Port 1, Chain Position 1	QU74592507	Contact (On/Off)	5			normal
2	On/Off 2	Port 1, Chain Position 1	QU74592507	Contact (On/Off)	4			normal
3	On/Off 3	Port 1, Chain Position 1	QU74592507	Contact (On/Off)	3			normal
4	On/Off 4	Port 1, Chain Position 1	QU74592507	Contact (On/Off)	2			normal
5	On/Off 5	Port 1, Chain Position 1	QU74592507	Contact (On/Off)	1			normal
6	Powered Dry Contact 1	Port 1, Chain Position 1	QU74592507	Powered Dry Contact	2	✓		off
7	Powered Dry Contact 2	Port 1, Chain Position 1	QU74592507	Powered Dry Contact	1	✓		off

---

### Managing Environmental Sensors or Actuators

The PX starts to retrieve an environmental sensor's reading and/or state and records the state transitions after the environmental sensor is managed. To control an actuator, you also need to have it managed.

The PX device can manage a maximum of 32 environmental sensors or actuators.

When there are less than 32 managed sensors or actuators, the PX automatically brings detected environmental sensors or actuators under management by default. You have to manually manage a sensor or actuator only when it is not under management.

---

*Tip: You can disable the automatic management feature so that newly connected environmental sensors or actuators are NOT brought under management automatically. See **Disabling the Automatic Management Function** (on page 270).*

---

► **To manually manage an environmental sensor or actuator:**

1. Click Peripheral Devices in the Explorer pane, and the Peripheral Devices page opens in the right pane.
2. Select the checkbox of the desired sensor or actuator on the Peripheral Devices page. To manage multiple ones, select multiple checkboxes.

---

*Note: To identify all detected sensors or actuators, see **Identifying Environmental Sensors and Actuators** (on page 255).*

---

3. Click Manage. If you selected only one sensor or actuator, the "Manage peripheral device <serial number> (<sensor type>)" dialog appears, where <serial number> is the sensor or actuator's serial number and <sensor type> is its type.

---

*Note: For a sensor package with contact closure (CC) or dry contact (DC) channels, a channel number is added to the end of the <sensor type>.*

---

4. There are two ways to manage a sensor or actuator:
  - To manage it by letting the PX assign a number to it, select "Automatically assign a sensor number." This method does not release any managed sensors or actuators.
  - To manage it by assigning the number you want to it, select "Manually select a sensor number." Then click the drop-down arrow to select a number.

If the number you selected was already assigned to a sensor or actuator, that sensor or actuator becomes released after losing this ID number.

---

*Tip: The information in parentheses following each ID number indicates whether the number has been assigned to any sensor or actuator. If it has been assigned to a sensor or actuator, it shows its serial number. Otherwise, it shows the word "unused."*

---

The manual assignment method is unavailable if you selected multiple sensors or actuators in Step 2.

5. Click OK. The PX starts to display the managed sensor or actuator's reading and state.
6. To manage additional ones, repeat Steps 2 to 5.

---

*Note: When the total number of managed sensors and actuators reaches the maximum, you CANNOT manage additional sensors or actuators unless you remove or replace any managed ones. To remove a sensor or actuator, see **Unmanaging Environmental Sensors or Actuators** (on page 269).*

---

► **Special note for a Raritan humidity sensor:**

As of release 3.1.0, a Raritan humidity sensor is able to provide two measurements in the user interface - relative and absolute humidity values.

- A relative humidity value is measured in percentage (%).
- An absolute humidity value is measured in grams per cubic meter (g/m<sup>3</sup>).

Relative humidity sensors can be "automatically" managed but absolute humidity sensors CANNOT. You must "manually" manage absolute humidity sensors if absolute humidity measurements are required.

Relative and absolute humidity values of the same humidity sensor share the same serial number and port position as illustrated below.

4	Relative Humidity 1	Port 1	AEI7A00022	 Relative Humidity	66 %	normal
5	Absolute Humidity 1	Port 1	AEI7A00022	 Absolute Humidity	14.7 g/m <sup>3</sup>	normal

However, relative and absolute values of the same humidity sensor DO NOT share the same ID number. The above diagram shows that the two values have different ID numbers -- one is 4 and the other is 5.

---

### Configuring Environmental Sensors or Actuators

You can change the default name to easily identify the managed sensor or actuator, and describe its location with X, Y and Z coordinates.

► **To configure environmental sensors or actuators:**

1. Click Peripheral Devices in the Explorer pane, and the Peripheral Devices page opens in the right pane.



2. Select the sensor or actuator that you want to configure.
3. Click Setup. The "Setup of peripheral device <serial number> (<sensor type>)" dialog appears, where <serial number> is its serial number and <sensor type> is its type. For example, Setup of peripheral device AEI7A00022 (Temperature).

---

*Tip: You can also trigger the same setup dialog by selecting the desired environmental sensor or actuator icon in the navigation tree and then clicking Setup in the right pane.*

---

4. If the selected environmental sensor is a Raritan contact closure sensor connected with a third-party detector/switch, select the appropriate sensor type in the Binary Sensor Subtype field.
  - Contact: The detector/switch is designed to detect the door lock or door open/closed status.
  - Smoke Detection: The detector/switch is designed to detect the appearance of smoke.
  - Water Detection: The detector/switch is designed to detect the appearance of water on the floor.
  - Vibration: The detector/switch is designed to detect the vibration in the floor.
5. Type a new name in the Name field.
6. Describe the sensor or actuator's location by assigning alphanumeric values to the X, Y and Z coordinates. See **Describing the Sensor or Actuator's Location** (on page 262).

---

*Note: When the term "Rack Units" appears inside the parentheses in the Z location field, indicating that the Z coordinate format is set to Rack Units, you must type an integer number.*

---

7. If the sensor is the DX-PIR presence detector, a field labeled "Alarmed to Normal Delay" is available. This field determines the wait time before the PX announces that the presence detector returns to the normal state after it is back to normal.

Type both the time and measurement units in this field. For example, type '30 s' for 30 seconds, or '2 min' for 2 minutes.

8. If the selected environmental sensor is a numeric sensor, its threshold settings are displayed in the dialog. See **Sensor Threshold Settings** (on page 591) for detailed information.

There are two types of thresholds: sensor-specific thresholds and default thresholds.

To use the sensor-specific threshold settings, select the Use Sensor Specific Thresholds radio button.

- Click Edit or double-click the threshold setting row to open the threshold setup dialog.



- To enable any threshold, select the corresponding checkbox. To disable a threshold, deselect the checkbox.
- After any threshold is enabled, type an appropriate numeric value in the accompanying text box.
- To set the deassertion hysteresis, type a numeric value in the Deassertion Hysteresis field. See **"To De-assert" and Deassertion Hysteresis** (on page 596).
- To set the assertion timeout, type a numeric value in the Assertion Timeout (samples) field. See **"To Assert" and Assertion Timeout** (on page 594).

To use the default threshold settings, select the Use Default Thresholds radio button. To modify the default threshold settings, see **Changing Default Thresholds** (on page 263).

---

*Note: The Upper Critical and Lower Critical values are points at which the PX considers the operating environment critical and outside the range of the acceptable threshold.*

---

9. Click OK.
10. Repeat the same steps to configure additional ones.

---

*Tip: You can configure thresholds of multiple sensors at a time as long as these sensors are of the same type. See **Setting Thresholds for Multiple Sensors** (on page 264).*

---

### Setting the Z Coordinate Format

You can use either the number of rack units or a descriptive text to describe the vertical locations (Z coordinates) of environmental sensors and actuators.

#### ► To determine the Z coordinate format:

1. Click the PDU folder.

---

*Note: The folder is named "my PX" by default. The name can be customized.*

---

2. Click Setup in the Settings section. The Pdu Setup dialog appears.
3. In the Peripheral Device Z Coordinate Format field, click the drop-down arrow and select an option from the list.
  - Rack Units: The height of the Z coordinate is measured in standard rack units. When this is selected, you can type a numeric value in the rack unit to describe the Z coordinate of any environmental sensors or actuators.
  - Free-Form: Any alphanumeric string can be used for specifying the Z coordinate.

4. Click OK.

#### **Describing the Sensor or Actuator's Location**

Use the X, Y and Z coordinates to describe each sensor or actuator's physical location. You can use these location values to track records of environmental conditions in fixed locations around your IT equipment. The X, Y and Z values act as additional attributes and are not tied to any specific measurement scheme. If you choose to, you can use non-measurement values. For example:

*X = Brown Cabinet Row*

*Y = Third Rack*

*Z = Top of Cabinet*

Values for the X, Y and Z coordinates may consist of:

- For X and Y: Any combination of alphanumeric characters. The coordinate value can be 0 to 24 characters long.
- For Z when the Z coordinate format is set to *Rack Units*, any numeric value ranging from 0 to 60.
- For Z when the Z coordinate format is set to *Free-Form*, any alphanumeric characters from 0 to 24 characters.

---

*Tip: To configure and retrieve these coordinate values over SNMP, see the PX MIB. To configure and retrieve these values over the CLI, see **Using the Command Line Interface** (on page 317).*

---

### Changing Default Thresholds

The default thresholds are the initial threshold values that automatically apply to numeric environmental sensors. These values are configured on a sensor type basis, which include:

- Temperature sensors
- Humidity sensors (both relative and absolute humidity)
- Air pressure sensors
- Air flow sensors
- Vibration sensors

Note that changing the default thresholds re-determine the initial thresholds applying to the environmental sensors that are added or detected later on.

In addition, changing the default thresholds also change the thresholds of those environmental sensors where the default thresholds have been selected as their threshold option. See **Configuring Environmental Sensors or Actuators** (on page 259).

#### ► To change the default threshold settings:

1. Click Peripheral Devices in the Explorer pane, and the Peripheral Devices page opens in the right pane.
2. Click Default Thresholds Setup on the Peripheral Devices page. A dialog appears, showing a list of all numeric environmental sensor types.
3. Select the desired sensor type.
4. Click Edit or double-click that sensor type to adjust its threshold settings, deassertion hysteresis or assertion timeout.
  - To enable any threshold, select the corresponding checkbox. To disable a threshold, deselect the checkbox.
  - After any threshold is enabled, type an appropriate numeric value in the accompanying text box.
  - To set the deassertion hysteresis, type a numeric value in the Deassertion Hysteresis field. See **"To De-assert" and Deassertion Hysteresis** (on page 596).
  - To set the assertion timeout, type a numeric value in the Assertion Timeout (samples) field. See **"To Assert" and Assertion Timeout** (on page 594).
5. Repeat the above step to modify the threshold settings of other numeric sensor types.
6. Click OK.

### Setting Thresholds for Multiple Sensors

You can configure thresholds for multiple environmental sensors of *the same type* at a time. For example, if you want all temperature sensors to have identical upper and lower thresholds, follow the procedure below to set up all temperature sensors together.

► **To configure thresholds of multiple environmental sensors:**

1. Click Peripheral Devices in the Explorer pane, and the Peripheral Devices page opens in the right pane.
2. Select the checkboxes of those environmental sensors whose threshold settings should be the same. Make sure the selected sensors belong to the same type.
  - To select all those listed on the Peripheral Devices page, simply select the checkbox in the header row.



3. Click Setup. Note that the Setup button is disabled if any of the selected sensors belongs to a different type.
4. Configure the thresholds as described in **Configuring Environmental Sensors or Actuators** (on page 259).
5. Click OK.

---

## Viewing Sensor or Actuator Data

Readings and states of the environmental sensors or actuators will display in the web interface after the sensors and actuators are properly connected and managed.

The Dashboard page shows the information of managed environmental sensors and actuators only, while the Peripheral Devices page shows the information of both managed and unmanaged ones.

Both pages indicate an environmental sensor or actuator's position in either of the following manners:

- **Port <n>**, where <n> is the number of the SENSOR port on the PDU where a specific environmental sensor package is connected. DPX sensor packages show this information.
- **Port <n>, Chain Position <pos\_num>**, where <pos\_num> is the sensor package's sequential position in a sensor daisy chain. DPX2 and DX sensor packages show this information.

If a sensor row is colored, it means the sensor reading already crosses one of the thresholds, the sensor enters an alarmed state, or the overcurrent protector has tripped or blown. See **The Yellow- or Red-Highlighted Sensors** (on page 83).

### ► To view managed environmental sensors and actuators only:

1. Click the Dashboard icon in the PX Explorer pane, and the Dashboard page opens in the right pane.
2. Locate the Peripheral Devices section on the Dashboard page. The section shows:
  - Total number of managed sensors and actuators
  - Total number of unmanaged sensors and actuators
  - Information of each managed sensor and actuator, including:
    - Name
    - Position
    - Reading (for numeric sensors)
    - State

### ► To view both managed and unmanaged ones:

Click Peripheral Devices in the Explorer pane, and the Peripheral Devices page opens in the right pane.

Detailed information for each connected sensor or actuator is displayed, including:

- ID number
- Name

- Position
- Serial number
- Type
- Channel (for a sensor package with contact closure or dry contact channels)
- Whether the sensor is an 'Actuator' or not (if yes, this icon  appears in the Actuator column)
- Reading
- State

**States of Managed Sensors**

An environmental sensor shows the state after being managed.

Available sensor states vary depending on the sensor type -- numeric or discrete sensors. For example, a contact closure sensor is a discrete (on/off) sensor so it switches between three states only -- unavailable, alarmed and normal.

---

*Note: Numeric sensors show both numeric readings and sensor states to indicate environmental or internal conditions while discrete (on/off) sensors show sensor states only to indicate state changes.*

---

Sensor state	Applicable to
unavailable	All sensors
alarmed	Discrete sensors
normal	All sensors
below lower critical	Numeric sensors
below lower warning	Numeric sensors
above upper warning	Numeric sensors
above upper critical	Numeric sensors

**"unavailable" State**

The *unavailable* state means the connectivity or communications with the sensor is lost.

The Raritan PX pings all managed sensors at regular intervals in seconds. If it does not detect a particular sensor for three consecutive scans, the *unavailable* state is displayed for that sensor.

When the communication with a contact closure sensor's processor is lost, all detectors (that is, all switches) connected to the same sensor package show the "unavailable" state.

---

*Note: When the sensor is deemed unavailable, the existing sensor configuration remains unchanged. For example, the ID number assigned to the sensor remains associated with it.*

---

The Raritan PX continues to ping unavailable sensors, and moves out of the *unavailable* state after detecting the sensor for two consecutive scans.

Connected sensors always show *unavailable* if they are NOT under management.

For DPX2 or DX sensor packages, all of the connected sensor packages also enter the *unavailable* states if any of them is upgrading its sensor firmware.

**"normal" State**

This state indicates the sensor is in the normal state.

For a contact closure sensor, usually this state is the normal state you have set.

- If the normal state is set to Normally Closed, the *normal* state means the contact closure switch is closed.
- If the normal state is set to Normally Open, the *normal* state means the contact closure switch is open.

For a Raritan's DPX floor water sensor, the normal state must be set to Normally Closed, which means no water is detected.

---

*Note: See the Environmental Sensors Guide for information on setting the normal state or dip switch. This guide is available on Raritan's **PX2 Support Files page** (<https://www.raritan.com/support/product/px2/px2-support-files>). This Environmental Sensors Guide applies to PX, BCM and EMX products.*

---

For a numeric sensor, this state means the sensor reading is within the acceptable range as indicated below:

$$\text{Lower Warning threshold} \leq \text{Reading} < \text{Upper Warning threshold}$$

---

*Note: The symbol  $\leq$  means smaller than ( $<$ ) or equal to ( $=$ ).*

---

#### **"alarmed" State**

This state means a discrete (on/off) sensor is in the "abnormal" state.

Usually for a contact closure sensor, the meaning of this state varies based on the sensor's normal state setting.

- If the normal state is set to Normally Closed, the *alarmed* state means the contact closure switch is open.
- If the normal state is set to Normally Open, the *alarmed* state means the contact closure switch is closed.

For a Raritan's floor water sensor, the normal state must be set to Normally Closed, which means no water is detected. The *alarmed* state indicates that the presence of water is detected.

---

*Note: See the Environmental Sensors Guide for information on setting the normal state or dip switch. This guide is available on Raritan's **PX2 Support Files page** (<https://www.raritan.com/support/product/px2/px2-support-files>). This Environmental Sensors Guide applies to PX, BCM and EMX products.*

---

*Tip: A contact closure sensor's LED is lit after entering the alarmed state. Determine which contact closure switch is in the "abnormal" status according to the corresponding LED.*

---

#### **"below lower critical" State**

This state means a numeric sensor's reading is below the lower critical threshold as indicated below:

$$\text{Reading} < \text{Lower Critical Threshold}$$

#### **"below lower warning" State**

This state means a numeric sensor's reading is below the lower warning threshold as indicated below:

$$\text{Lower Critical Threshold} \leq \text{Reading} < \text{Lower Warning Threshold}$$

---

*Note: The symbol  $\leq$  means smaller than ( $<$ ) or equal to ( $=$ ).*

---

#### **"above upper warning" State**

This state means a numeric sensor's reading is above the upper warning threshold as indicated below:

$$\text{Upper Warning Threshold} \leq \text{Reading} < \text{Upper Critical Threshold}$$

---

*Note: The symbol  $\leq$  means smaller than ( $<$ ) or equal to ( $=$ ).*

---



**"above upper critical" State**

This state means a numeric sensor's reading is above the upper critical threshold as indicated below:

$$\text{Upper Critical Threshold} <= \text{Reading}$$

---

*Note: The symbol  $<=$  means smaller than ( $<$ ) or equal to ( $=$ ).*

---

**States of Managed Actuators**

DX sensor packages with dry contact channels allow you to connect actuators. An actuator has only three states described below. Note that an actuator is never highlighted in red or yellow regardless of the actuator states.

- Unavailable: The actuator is not managed or the communication with it is lost.
- On: The actuator has been turned on.
- Off: The actuator has been turned off.

**Unmanaging Environmental Sensors or Actuators**

When it is unnecessary to monitor a particular environmental factor, you can unmanage or release the corresponding environmental sensor so that the PX device stops retrieving the sensor's reading and/or state. This procedure also applies if you want to unmanage an actuator.

**► To release a managed sensor or actuator:**

1. Click Peripheral Devices in the Explorer pane, and the Peripheral Devices page opens in the right pane.
2. Select the checkbox of the desired sensor or actuator on the Peripheral Devices page. To release multiple ones, select multiple checkboxes.
  - To select all those listed on the Peripheral Devices page, simply select the checkbox in the header row.

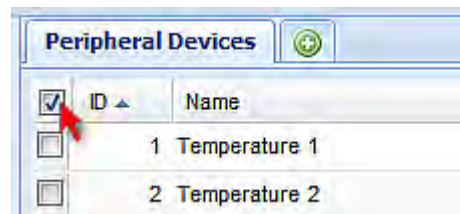

3. Click Release.

After a sensor or actuator is removed from management, the ID number assigned to it is released and can be automatically assigned to any newly-detected sensor or actuator.

---

### Disabling the Automatic Management Function

The factory default is to enable the automatic management feature for environmental sensors and actuators. Therefore, when the total number of managed sensors and actuators has not reached 32 yet, the PX automatically brings newly-connected environmental sensors and actuators under management after detecting them.

When this feature is disabled, the PX no longer automatically manages any newly-detected environmental sensors and actuators, and therefore neither ID numbers are assigned nor sensor readings or states are available for newly-added ones.

► **To disable the automatic management feature:**

1. Click the PDU folder.

---

*Note: The folder is named "my PX" by default. The name can be customized.*

---

2. Click Setup in the Settings section. The Pdu Setup dialog appears.
3. Deselect the Peripheral Device Auto Management checkbox.
4. Click OK.

---

### Controlling Actuators

If you have any DX sensor packages with actuators connected, which can move or control a mechanism or system, you can remotely turn on or off the actuators to control the connected mechanism or system.

► **To turn on or off an individual actuator:**

1. Expand the Peripheral Devices folder. See **Expanding the Tree** (on page 78).
2. Click the desired actuator from the navigation tree. That actuator's page opens in the right pane.
3. Click "Switch on" to turn on the actuator, or "Switch off" to turn it off.

► **To turn on or off multiple actuators:**

1. Click Peripheral Devices in the Explorer pane, and the Peripheral Devices page opens in the right pane.
2. Select the checkboxes of the desired actuators on the Peripheral Devices page.

---

*Tip: An actuator is indicated with the icon  displayed in the 'Actuator' column.*

---

3. Click "Switch on" or "Switch off" to turn on or off the selected actuators. Confirm you want to switch when prompted.

---

## Asset Management

Configure the asset management settings only when an asset sensor is physically connected to the PX device.

---

*Note: To set up an asset management system, see **Connecting the Asset Management Sensor** (on page 40).*

---

### Configuring the Asset Sensor

The PX cannot detect how many rack units (tag ports) a connected asset management sensor supports, so you must provide this information manually.

When you add an asset management sensor, you name it.

► **To configure an asset sensor (asset strip):**

1. If the Feature Port folder is not expanded, expand it to show the device under the Feature Port folder.
2. Click the asset sensor in the left pane. The asset sensor's page opens in the right pane.

---

*Note: The asset sensor is named "Asset Strip 1" by default. The name changes after being customized.*

---



---

*Tip: The same asset sensor's page can be also opened by clicking Feature Port in the left pane, and then double-clicking the asset sensor in the right pane.*

---

3. Click Setup. The setup dialog for the asset sensor appears.

---

*Tip: You can also trigger the same dialog by clicking Asset Management in the left pane, and then clicking Asset Strip Setup or double-clicking the asset sensor in the right pane.*

---

4. To rename the asset sensor, type a new name in the Name field.
5. In the "Number of Rack Units" field, type the total number of rack units supported by the AMS. Default is 48.
6. Here, rack units are the number of asset management tag ports on the asset management strip. For example, if the AMS has 48 asset management tag ports, it supports up to 48 rack units on a cabinet.
7. Determine how to number all rack units on the asset sensor by selecting an option in the Numbering Mode.
  - Top-Down: The rack units are numbered in the ascending order from the highest to the lowest rack unit.

- Bottom-Up: The rack units are numbered in the descending order from the highest to the lowest rack unit.
8. In the Numbering Offset field, select the starting number. For example, if you select 3, the first rack unit is numbered 3, the second is numbered 4, the third is numbered 5, and so on until the final number.
  9. Indicate how the asset sensor is mounted on the rack in the Orientation field. The rack unit that is most close to the RJ-45 connector of the asset sensor will be marked with the index number 1 in the web interface.

For the latest version of asset sensors with a built-in tilt sensor, it is NOT necessary to configure the orientation setting manually. The PX device can detect the orientation of the asset sensors and automatically configure it.

- Top Connector: This option indicates that the asset sensor is mounted with the RJ-45 connector located on the top.
- Bottom Connector: This option indicates that the asset sensor is mounted with the RJ-45 connector located at the bottom. Click OK.

---

### Setting Asset Sensor LED Colors

Each LED on the asset sensor indicates the presence and absence of a connected asset tag by changing its color. You can configure or change the color settings for all LEDs on the connected asset sensor(s) by following the procedure below.

This feature is accessible only by users with Administrative Privileges.

► **To configure all LED colors:**

1. Connect the asset sensor to the PX if it is not already.
2. Click on the Feature Ports folder in the navigation tree to expand it.
3. Click the desired asset sensor. The page specific to that asset sensor opens in the right pane, showing the asset sensor settings and information of all rack units (tag ports).

---

*Note: You can also access this dialog by double-clicking the asset sensor shown on the Dashboard page.*

---

4. Click Setup on the asset sensor page. The setup dialog for that asset sensor appears.
5. To change the LED color denoting the absence of a connected tag, either click a color in the color palette or type the hexadecimal RGB value of the color in the "Color without connected Tag" field.
6. Click OK.

---

*Tip: To make a specific LED's color settings different from other LEDs, see **Configuring a Specific Rack Unit** (on page 273).*

---

### Configuring a Specific Rack Unit

In the PX web interface, a rack unit refers to a tag port on the asset sensor. You can name a specific rack unit, or change its LED color settings so that this LED behaves differently from others on the same asset sensor.

► **To configure a specific rack unit:**

1. If the Feature Port folder is not expanded, expand it to show the device under the Feature Port folder.
2. Click the asset sensor in the left pane. The asset sensor's page opens in the right pane.

---

*Note: The asset sensor is named "Asset Strip 1" by default. The name changes after being customized.*

---

*Tip: The same asset sensor's page can be also opened by clicking Feature Port in the left pane, and then double-clicking the asset sensor in the right pane.*

---

3. Select the rack unit whose LED settings you want to change.
4. Click Configure Rack Unit or double-click the selected rack unit. The setup dialog for the selected rack unit appears.
5. In the Name field, type a name for identifying this rack unit.
6. Select either Auto or Manual Override as this rack unit's LED mode.
  - Auto (based on Tag): This is the default setting. With this option selected, the LED follows the global LED color settings.
  - Manual Override: This option differentiates this LED's behavior. After selecting this option, you must select an LED mode and/or an LED color for the selected rack unit.
    - LED Mode: Select On to have the LED stay lit, Off to have it stay off, "Slow blinking" to have it blink slowly, or "Fast blinking" to have it blink quickly.
    - LED Color: If you select On, "Slow blinking" or "Fast blinking" in the LED Mode field, select an LED color by either clicking a color in the color palette or typing the hexadecimal RGB value of a color in the accompanying text box.
7. Click OK.

### Expanding a Blade Extension Strip

A blade extension strip, like an asset sensor, has multiple tag ports. After connecting it to a specific asset sensor, it is displayed as a folder on that asset sensor's page.

*Note: If you need to temporarily disconnect the blade extension strip from the asset sensor, wait at least 1 second before re-connecting it back, or the PX device may not detect it.*

► **To expand a blade extension strip folder:**

1. Click the desired asset sensor in the left pane. The selected asset sensor's page opens in the right pane.
2. Locate the rack unit (tag port) where the blade extension strip is connected.

	Rack Unit	Index	Slot	Name	Asset / ID
	1	1			
	2	2			00000007CACB
	3	3			
	4	4			

3. Double-click that rack unit or click the white arrow ► prior to the folder icon. The arrow then turns into a black, gradient arrow ▲, and all tag ports of the blade extension strip appear below the folder.

	Rack Unit	Index	Slot	Name	Asset / ID
	1	1			
	2	2			00000007CACB
			1		
			2		
			3		
			4		
			5		
			6		
			7		
			8		
			9		
			10		
			11		
			12		
			13		
			14		
			15		
			16		
	3	3			
	4	4			

► **To collapse a blade extension strip:**

- Double-click the blade extension strip folder, or click the black, gradient arrow ▲ prior to the folder icon. All tag ports under the folder are hidden.

---

**Displaying the Asset Sensor Information**

The hardware and software information of the connected asset sensor is available through the web interface.

► **To display the asset sensor information:**

1. Connect the asset sensor to the PX if it is not already.
2. Click on the Feature Ports folder in the navigation tree to expand it.
3. Click the desired asset sensor. The page specific to that asset sensor opens in the right pane, showing the asset sensor settings and information of all rack units (tag ports).

---

*Note: You can also access this dialog by double-clicking the asset sensor shown on the Dashboard page.*

---

4. Click Extended Device Info, where the asset sensor data is displayed.
5. Click Close to quit the dialog.

---

## Bulk Configuration

The Bulk Configuration feature lets you save the settings of a configured PX device to your PC. You can use this configuration file to copy that configuration to other PX devices of the same model and firmware version.

You must have the administrator privileges to save and copy the PX configurations.

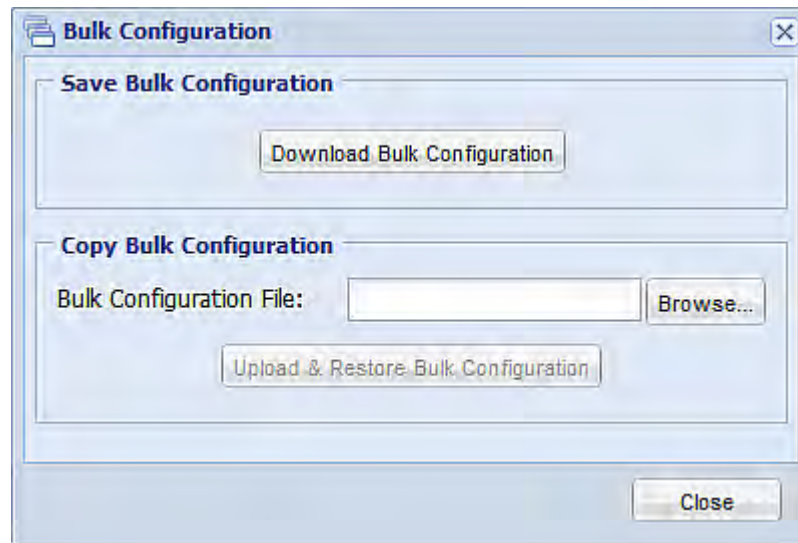

---

*Note: No device-specific data is saved to the Bulk Configuration file, such as environmental sensor or certain network settings. To back up or restore a specific PX device's all settings, use the Backup/Restore feature instead. See **Backup and Restore of PX Device Settings** (on page 279).*

---

*Tip: An additional way to bulk configure multiple PX devices is to use the TFTP server over a DHCP network. This method helps you save a lot of time when there are a large number of PX devices to configure. For details, see **Bulk Configuration or Firmware Upgrade via DHCP/TFTP** (on page 500).*

---



---

## Saving the PX Configuration

A source device is an already configured PX device that is used to create a configuration file containing the settings that can be shared between PX devices. These settings include user and role configurations, thresholds, event rules, security settings, and so on.

This file does NOT contain device-specific information, including:

- Device name
- System name, system contact and system location
- Network settings (IP address, gateway, netmask and so on)
- Device logs
- Outlet names
- Outlet status
- Environmental sensor and actuator names
- States and values of environmental sensors and actuators
- TLS certificate

Because the date and time settings are saved in the configuration file, users should exercise caution when distributing the configuration file to the PX devices in a different time zone than the source device.

### ► To save a configuration file:

1. Choose Maintenance > Bulk Configuration. The Bulk Configuration dialog appears.
2. Click Download Bulk Configuration.
3. When the web browser prompts you to open or save the configuration file, click Save. Choose a suitable location and save the configuration file to your PC.

The file is saved in the XML format, and its content is encrypted using the AES-128 encryption algorithm.

---

*Tip: You can also save a configuration file using a Secure Copy (SCP) command. See **Bulk Configuration via SCP** (on page 527).*

---

---

## Copying the PX Configuration

A target device is the PX device that loads another PX device's configuration file.

Copying a source PX device's configuration to a target device adjusts the target PX device's settings to match those of the source PX device. In order to successfully copy a source PX device's configuration:

- The user must be the Admin user. Or the Admin role is assigned to the user.
- The target PX device must be running the same firmware version as the source PX device.
- The target PX device must be of the same model type as the source PX device.

Bulk configuration is permitted if the differences between the target and source device are only mechanical designs which are indicated in a model name's suffix as listed below. In the following list, *n* represents a number.

- PDU chassis color, which is indicated as *Kn*, such as K1 and K601
- Line cord color, which is indicated as *Bn*, such as B2 and B5
- Line cord length (meters), which is indicated as *An*, such as A0 and A14
- Line cord length (centimeters), which is indicated as *Ln*

For example, Raritan's PX2-4724-E2N1K2 and PX2-4724-E2N1K9 share the same specifications, and the only difference is their chassis colors represented by K2 (blue) and K9 (gray).

### ► To copy a PX configuration:

1. Log in to the target device's web interface.
2. If the target device's firmware version does not match that of the source device, update the target's firmware. See **Firmware Upgrade** (on page 299).
3. Choose Maintenance > Bulk Configuration. The Bulk Configuration dialog appears.
4. In the Copy Bulk Configuration section, click Browse to select the configuration file stored on your PC.
5. Click Upload & Restore Bulk Configuration to copy the file.  
A message appears, prompting you to confirm the operation and enter the admin password.
6. Enter the admin password, then click Yes to confirm the operation.
7. Wait until the PX device resets and the Login page re-appears, indicating that the configuration copy is complete.

---

*Note: On startup, the PX performs all of its functions, including event rules and logs, based on the new configuration file you have selected instead of the previous configuration prior to the device reset. For example, "Bulk configuration copied" is logged only when the new configuration file contains the "Bulk configuration copied" event rule.*

---

*Tip: You can also copy a configuration file using a Secure Copy (SCP) command. See **Bulk Configuration via SCP** (on page 527).*

---

---

## Backup and Restore of PX Device Settings

Different from the Bulk Configuration file, the backup file contains device-specific data like network settings. To back up or restore PX device settings, you should perform the Backup/Restore feature.

All PX information is captured in the XML backup file except for the device logs and TLS certificate.

---

*Note: To perform the bulk configuration among multiple PX devices, perform the Bulk Configuration feature instead. See **Bulk Configuration** (on page 276).*

---

### ► To download a backup PX XML file:

1. Choose Maintenance > Backup/Restore. The Backup/Restore of Device Settings dialog opens.
2. In the Save Device Settings section, click Download Device Settings. Save the file to your computer.

The file is saved in the XML format, and its content is encrypted using the AES-128 encryption algorithm.

### ► To restore the PX using a backup XML file:

1. Choose Maintenance > Backup/Restore. The Backup/Restore of Device Settings dialog opens.
2. In the Copy Device Settings section, click Browse to locate the file.
3. Click Upload & Restore Device Settings to upload the file.  
A message appears, prompting you to confirm the operation and enter the admin password.
4. Enter the admin password, then click Yes to confirm the operation.
5. Wait until the PX device resets and the Login page re-appears, indicating that the restore is complete.

---

*Note: On startup, the PX performs all of its functions, including event rules and logs, based on the new configuration file you have selected instead of the previous configuration prior to the device reset. For example, "Bulk configuration copied" is logged only when the new configuration file contains the "Bulk configuration copied" event rule.*

---

*Tip: You can also back up and restore a configuration file using a Secure Copy (SCP) command. See **Backup and Restore via SCP** (on page 528).*

---

---

## Webcam Management

With a Logitech® webcam connected to the PX device, you can visually monitor the environment around the PX via snapshots or videos captured by the webcam.

- To view snapshots and videos, you need the permission of either "Change Webcam Configuration" or "View Webcam Sanpshots and Configuration."
- To configure webcam settings, you need the "Change Webcam Configuration" permission.

For more information on the Logitech webcam, see the user documentation accompanying it. For information on connecting a webcam to the PX, see **Connecting a Logitech Webcam** (on page 52).

You can manually store snapshots taken from the webcam onto the PX or a remote server. See **Saving Snapshots** (on page 286) or **Configuring Webcam Storage** (on page 288).

Links to snapshots or videos being captured by a webcam can be sent via email or instant message. See **Sending Snapshots or Videos in an Email or Instant Message** (on page 284).

Events that trigger emails containing snapshots from a webcam can be created. See **Creating Actions** (on page 200).

---

### Configuring Webcams

Before you can configure a webcam, it must be connected to the PX. See **Connecting a Logitech Webcam** (on page 52).

► **To configure a webcam:**

1. In the navigation tree, click on the Webcam Management folder. The Webcam Management page opens.
2. Click on the webcam you want to configure and then click Setup at the bottom right of page. The Webcam Setup dialog opens.
3. Enter a name for the webcam. Up to 64 characters are supported.

4. Type the location information in each location field if needed. Up to 63 characters are supported.
5. Select a resolution for the webcam.
  - If you connect two webcams to one USB-A port using a powered USB hub, set the resolution to 352x288 or lower for optimal performance.
6. Select the webcam mode. This can be changed as needed once the webcam is configured.
  - a. Video - the webcam is in video mode. Set the Framerate (frames per second) rate.
  - b. Snapshot - the webcam displays images from the webcam. Set the "Time between Snapshots" rate as measured in seconds.
7. Click OK. The image or video from the webcam is now available in the PX once you click on the webcam in the navigation tree.

► **To edit a webcam configuration:**

1. In the navigation tree, click on the Webcam Management folder. The Webcam Management page opens.
2. Double-click on the webcam you want to edit. The webcam image or video opens in a new tab.
3. Click Setup .
4. Edit the information as needed. Changes to the resolution do not apply to existing, stored images - it applies only to images and videos taken after the resolution is changed.
5. Click OK.

---

### Adjusting Image Properties

If any snapshot or video properties, such as the brightness, contrast, saturation, and gain settings, do not satisfy your needs, adjust them.

► **To adjust the image or video properties:**

1. Select the webcam shown on the Webcam Management page or in the navigation tree. See **Configuring Webcams** (on page 280).
2. Click Setup or .
3. Click the Controls tab.
4. Adjust the desired property by adjusting the corresponding slide bar.  
Or click "Set to webcam defaults" to restore all settings to this webcam's factory defaults.
5. Click OK.

---

## Viewing Webcam Snapshots or Videos

You can switch between snapshots or live videos being captured by a webcam.

The snapshot or video is displayed either in the PX web interface or in a Primary Standalone Live Preview window that you open.

You can open a maximum of five Primary Standalone Live Preview windows.

---

*Note: For remote Live Preview sessions, such as those accessed via a link in an email or instant message, a total of up to three (3) simultaneous Live Preview sessions are supported at a time. One (1) from the originator in the PX interface, and up to two (2) remote sessions. See **Sending Snapshots or Videos in an Email or Instant Message** (on page 284).*

---

### ► To switch between snapshot and video modes:

1. Click the desired webcam's icon in the navigation tree.

Snapshots or videos captured by the webcam are displayed in the right pane of the PX web interface once a webcam is selected in the navigation tree.

Snapshots and videos can also be displayed in Live Preview mode in the Primary Standalone Live Preview window by clicking on the Live Preview icon .

---

*Note: All Live Preview sessions sharing the same URL, including one Primary Standalone Live Preview window and two associated remote sessions, are identified as one single "<webcam>" user in the Connected Users dialog. You can disconnect a "<webcam>" user from this dialog to terminate a specific Primary Standalone Live Preview window and all of its remote sessions. See **Viewing Connected Users** (on page 248).*

---

2. By default the PX enters the snapshot mode. Wait around one minute for the snapshot to appear.

In the snapshot mode, three pieces of information are displayed on the top of the image:



- A snapshot mode icon .
- The interval time between snapshots (in seconds).
- A time stamp.



 Interval 6 s

2/03/15 1:07 AM

The webcam's location information, if available, is displayed in the Location pane of the PX web interface.

- To change any image settings, click Setup . See **Configuring Webcams** (on page 280) or **Adjusting Image Properties** (on page 281).
  - To save the snapshot being displayed, click the "Store Snapshot to Webcam Storage" icon . See **Saving Snapshots** (on page 286).
3. To switch to the video mode, click Setup  and select Video in the Webcam Mode field.

In the video mode, two pieces of information are displayed on the top of the image:

- A video mode icon .
- The number of frames to take per second (fps).

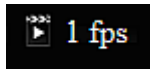

To change any video settings, click Setup .

4. To return to the snapshot mode, repeat the above step and select Snapshot.

---

### **Sending Snapshots or Videos in an Email or Instant Message**

Whenever you open a Primary Standalone Live Preview window, a unique URL is generated for this window session, which permits a link to the snapshot or video being captured.

You are able to email or instant message up to two (2) recipients a link to webcams attached to the PX. Users can then click on the links and view snapshots or videos.

A total of three sessions based on the same URL are supported, including a Primary Standalone Live Preview window of the sender and two remote sessions of the recipients.

---

*Note: All Live Preview sessions sharing the same URL, including one Primary Standalone Live Preview window and two associated remote sessions, are identified as one single "<webcam>" user in the Connected Users dialog. You can disconnect a "<webcam>" user from this dialog to terminate a specific Primary Standalone Live Preview window and all of its remote sessions. See **Viewing Connected Users** (on page 248).*

---

For explanation of this topic, the message sender is User A and the recipient is User B.

The recipient is able to access the snapshot or video image via the link in any of the following scenarios:

- The snapshot or video remains open in the Primary Standalone Live Preview window in User A's side. If so, even though User A logs out of the PX interface or the login session times out, the link is available.

Or

- At least a remote session based on the same URL remains open. If so, even though User A has closed the Primary Standalone Live Preview window, the link is available.

Or



- Neither the Primary Standalone Live Preview window nor any remote session based on the same URL remains open, but the idle timeout period has not expired yet since the last Live Preview window session was closed. For information on idle timeout, see **Enabling Login Limitations** (on page 149).

---

*Tip: If the idle timeout has not expired, the <webcam> user for that Live Preview URL remains shown in the Connected Users dialog.*

---

### Best Practice

As a best practice, User A should open the snapshot or video using a Primary Standalone Live Preview window and leave that window open at least until User B opens the snapshot or video via the link.

Once User B opens the snapshot or video via the link, User A can close the Primary Standalone Live Preview window.

User B should let User A know that the link has been opened.

#### ► To send a snapshot or video link via email or instant message:

1. In the navigation tree, click on the webcam that is capturing the snapshot or video you want to provide a link to other people. The snapshot or video is displayed in Live Preview mode in the right pane.
2. Click on the Live Preview icon  located above the snapshot or video. The snapshot or video opens in a standalone Live Preview window.
3. Copy the URL from the Live Preview window, paste it into the email or instant message application. Leave the Live Preview window open at least until the recipient opens the snapshot or video via the link.

---

## Snapshot Storage

Once a snapshot is taken using the Store Snapshot to Webcam Storage feature, it is stored locally on the PX by default. Up to ten (10) images can be stored on the PX at once.

To save more than 10 snapshots, save the images on a Common Internet File System/Samba.

---

*Note: NFS and FTP are not supported for this release and are disabled on the dialog.*

---

Snapshot files are saved as JPG files. The snapshot file is named based on the number of the snapshot starting from 1. So the first snapshot that is taken is named 1.jpg, the second is 2.jpg and so on.

Unless snapshots are deleted manually, the oldest snapshot is automatically deleted from the device when the number of snapshots exceeds ten. Rebooting the PX deletes all webcam snapshots that are saved on the device.

## Saving Snapshots

If it is intended to keep the snapshot being displayed on the webcam, you can manually save it onto the PX. A snapshot is saved as a JPEG file and stored on the Snapshots page.

Warning: The snapshots stored on the PX are cleared when rebooting the PX. Check the importance of the snapshots before performing the reset.

### ► To save the snapshot being displayed:

1. In the navigation tree, click on the webcam you want to take a snapshot with. The webcam image is displayed in the right pane.  
The webcam must be in snapshot mode in order to take snapshots. If the webcam is in video mode, click Setup in the right pane above the video image to open the Webcam Setup dialog, then select the Snapshot radio button.
2. Once the snapshot image being taken by the selected webcam is displayed in the right pane, click the Store Snapshot to Webcam Storage  icon above the image to take a snapshot. Up to ten (10) snapshots can be stored at once on the device.
3. Click on the Snapshots icon in the navigation tree to verify that those snapshots are successfully saved and listed on the Snapshots page.

---

*Tip: To store snapshots on a remote server rather than the PX, see **Configuring Webcam Storage** (on page 288).*

---

### Managing the Snapshots Saved to PX

A maximum of 10 saved snapshots can be stored and displayed on the Snapshots page of the PX.

See **Saving Snapshots** (on page 286) for instructions on storing snapshots on the PX.

The Snapshots page is categorized into three sections: Storage, Snapshot and Details.

- Storage: shows a list of all saved snapshots.  
On the top of the Storage section, the number following "Used" indicates the total of saved snapshots and the number following "Size" indicates maximum number of snapshots allowed in storage.
- Snapshot: displays the image of the snapshot being selected.
- Details: shows the information which had been entered when the snapshot was saved, including resolution and location settings.

---

*Tip: To save more than 10 snapshots, save snapshots onto a remote server. See **Configuring Webcam Storage** (on page 288).*

---

#### ► To view the saved snapshots:

1. In the navigation tree, click Snapshots under the Webcam Management folder. The snapshots are displayed in the right pane in the Storage section of the page.
2. View an individual snapshot by clicking on a snapshot file in the Storage section of the page.

The size of each snapshot file, the date and time each snapshot was taken, and the webcam that took each snapshot, is displayed when viewing snapshots.

Details, such as the webcam location and/or labels, if any, are displayed in the Details section below the snapshot in the right pane. This information is defined when the webcam is initially configured. See **Configuring Webcams** (on page 280).

3. Use the navigation icons to move through each snapshot, or enter a specific page number to jump to that snapshot page.

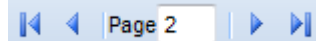

4. Click the Refresh icon  to refresh the page. New snapshots are displayed if they are available.

► **To delete any snapshot from the storage:**

- Delete snapshots by selecting the checkbox next to the snapshot you want to delete, then clicking the Delete icon  at the top of the section. To select and delete all snapshots at once, click the checkbox in the checkbox column header, then click the Delete icon.

► **To change the sorting or displayed columns of the list:**

- You can resort the snapshot list or hide any displayed column in the Storage section. For details, see **Changing the View of a List** (on page 84).

### Configuring Webcam Storage

Once a snapshot is taken using the Store Snapshot to Webcam Storage feature, it is stored locally on the PX by default. Up to ten (10) images can be stored on the PX at once.

To save more than 10 snapshots, save the images on a Common Internet File System/Samba.

---

*Note: NFS and FTP are not supported for this release and are disabled on the dialog.*

---

Snapshot files are saved as JPG files. The snapshot file is named based on the number of the snapshot starting from 1. So the first snapshot that is taken is named 1.jpg, the second is 2.jpg and so on.

Unless snapshots are deleted manually, the oldest snapshot is automatically deleted from the device when the number of snapshots exceeds ten. Rebooting the PX deletes all webcam snapshots that are saved on the device.

► **To configure another storage location for images:**

1. In the navigation tree, click Snapshots under the Webcam Management folder. The Snapshots page opens.
2. Click on the Setup Storage icon . The Storage Setup dialog opens.
3. By default, Local, meaning the PX, is the designated default storage.
4. Select CIFS/Samba as the storage location.
5. Enter the server where to store the images.
6. If needed, enter the share drive/folder to store the images in.
7. Enter the username and password needed to access the server where the images are stored.

8. Enter or use the slide bar to set the number of images that can be saved to the storage location.
9. Click OK.

---

## Network Diagnostics

The PX provides the following tools in the web interface for diagnosing potential networking issues.

- Ping
- Trace Route
- List TCP Connections

---

*Tip: These network diagnostic tools are also available through CLI. See **Network Troubleshooting** (on page 476).*

---

### Pinging a Host

The Ping tool is useful for checking whether a host is accessible through the network or Internet.

▶ **To ping a host:**

1. Choose Maintenance > Network Diagnostics > Ping. The Ping Network Host dialog appears.
2. In the Host Name field, type the name or IP address of the host that you want to check.
3. In the Number of Requests field, type a number up to 20 or adjust the value by clicking either arrow. This number determines how many packets are sent for pinging the host.
4. Click Run Ping to start pinging the host. A dialog appears, displaying the Ping results.
5. Click Close to quit the dialog.

---

### Tracing the Network Route

Trace Route lets you find out the route over the network between two hosts or systems.

▶ **To trace the route for a host:**

1. Choose Maintenance > Network Diagnostics > Trace Route. The "Trace Route to Host" dialog appears.
2. Type the IP address or name of the host whose route you want to check in the Host Name field.

3. In the Timeout (s) field, type a timeout value in seconds to end the trace route operation. Note that if the timeout value is too small, the trace route results may be incomplete.
4. To use the Internet Control Message Protocol (ICMP) packets to perform the trace route command, select the Use ICMP Packets checkbox.
5. Click Run. A dialog appears, displaying the Trace Route results.

---

### Listing TCP Connections

You can use the "List TCP Connections" to display a list of TCP connections.

► **To list TCP connections:**

1. Choose Maintenance > Network Diagnostics > List TCP Connections. The TCP Connections window appears.
2. Click Close to quit the dialog.

---

## Downloading Diagnostic Information

---

**Important: This function is for use by Raritan Field Engineers or when you are directed by Raritan Technical Support.**

---

You can download the diagnostic file from the PX device to a client machine. The file is compressed into a .tgz file and should be sent to Raritan Technical Support for interpretation.

This feature is accessible only by users with Administrative Privileges.

► **To retrieve a diagnostic file:**

1. Choose Maintenance > Download Diagnostic Information. You are then prompted to save or open the file.
2. Click Save to save the file.
3. E-mail this file as instructed by Raritan Technical Support.

---

## Managing the Schroff LHX/SHX Heat Exchanger

The PX supports monitoring and administering the Schroff® LHX-20, LHX-40 and SHX-30 heat exchanger if this device is connected to the PX.

From the PX, you can do the following remotely:

- Name a connected LHX/SHX heat exchanger
- Configure the air outlet temperature setpoint
- Configure air outlet temperature thresholds
- Configure air inlet temperature thresholds
- Configure water inlet temperature thresholds
- Configure fan speed thresholds
- Monitor the air inlet temperature
- Monitor the air outlet temperature
- Monitor the fan speed
- Depending on the model, configure the default fan speed to operate from 50% to 90% (the factory default is 80%)
- Depending on the model, request maximum cooling using the fan speed and opening the cold water valve
- Acknowledge alerts remotely (for example, return to normal operation after maximum cooling is requested)

► **To monitor one LHX/SHX heat exchanger using the PX:**

1. Physically connect an LHX-20, LHX-40 or SHX-30 heat exchanger to the PX device if it is not already connected. See **Connecting a Schroff LHX/SHX Heat Exchanger** (on page 54).
2. Enable the support of LHX/SHX heat exchanger on the PX. See **Enabling and Disabling Schroff LHX/SHX Heat Exchanger Support** (on page 292).
3. Configure the connected heat exchanger. See **Configuring the LHX/SHX Device** (on page 292).
4. Now you can remotely monitor or control the connected LHX/SHX heat exchanger via the PX.
  - To monitor the heat exchanger, see **Monitoring the LHX/SHX Device** (on page 295).
  - To control the heat exchanger, see **Turning the LHX/SHX On or Off** (on page 298).

---

### Enabling and Disabling Schroff LHX/SHX Heat Exchanger Support

By default, Schroff LHX/SHX Heat Exchanger support is disabled. As such, support needs to be enabled before the device appears in the navigation tree or on the dashboard. Additionally, Schroff LHX/SHX Heat Exchanger support must be enabled in order for the LHX-MIB to be accessible through SNMP.

► **To enable the Schroff LHX/SHX Heat Exchanger:**

1. Select Device Settings > Features, and then select the Schroff LHX/SHX Support checkbox on the menu.

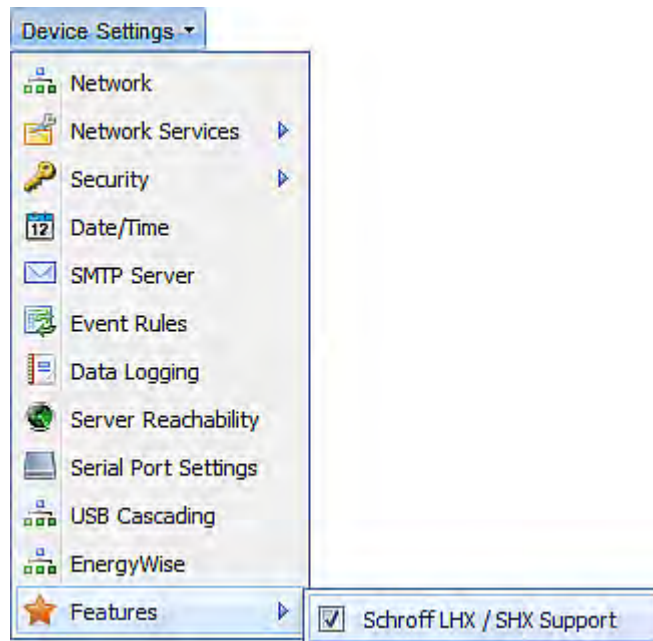

2. Click Yes to confirm.
3. Reboot the PX.

---

### Configuring the LHX/SHX Device

After enabling the LHX/SHX support on the PX, the PX should automatically detect the connected LHX/SHX device and display it under the Feature Port folder unless the Feature Port is set to a mode different than the Auto mode. If so, change the Feature Port mode so that the LHX/SHX device is correctly displayed in the web interface. See **Configuring the Feature Port** (on page 117).

Besides, the PX allows you to set temperature or fan speed thresholds for alerts or to customize the name of the LHX/SHX device for easy identification.



### Correctly Displaying the LHX/SHX Device

There are two ways to have the PX show the correct LHX/SHX model in the web interface.

- Auto detection: Set the mode of the Feature Port to Auto to let the PX automatically detect the device type.
- Manual assignment: Set the mode of the Feature Port to either LHX-20, LHX-40 or SHX-30, depending on which LHX/SHX model is physically connected to the PX.

For details on how to change the Feature Port mode, see **Configuring the Feature Port** (on page 117).

After the correct LHX/SHX device type is detected or assigned, the LHX/SHX icon  appears below the Feature Port folder.

Note that the device icon changes its image when the device changes its states. See **Device States and Icon Variations** (on page 296) for details.

### Setting Up an LHX/SHX

Once a Schroff LHX/SHX heat exchanger is connected, you can set up the device by giving it a name, and configure its setpoint air outlet and default fan speed.

#### ► To set up the LHX/SHX:

1. If the Feature Port folder is not expanded, expand it to show the device under the Feature Port folder.
2. Click the LHX/SHX heat exchanger in the PX Explorer pane. The page specific to that device opens in the right pane.
3. Click Setup in the Settings section of the page. The Setup dialog opens.
4. Type a name for the heat exchanger in the Name field. The customized LHX/SHX heat exchanger's name is followed by the device type in parentheses.
5. Enter the air outlet's temperature set point in the Setpoint Air Outlet (°C) field.
6. Enter the default fan speed in the Default Fan Speed (%) field.
7. Click OK.

### Configuring Temperature and Fan Thresholds

An LHX/SHX heat exchanger is implemented with various sensors for detecting the air temperature, water temperature, and fan speed. You can set thresholds for these sensors so that the PX alerts you when any sensor readings are getting close to a critical condition. These settings are stored on the PX port where the heat exchanger is connected, and are lost if that heat exchanger is moved to a different port.

► **To configure the thresholds for a sensor:**

1. Connect the LHX/SHX heat exchanger to PX if it is not already connected.
2. If the Feature Port folder is not expanded, expand it to show the device under the Feature Port folder.
3. Click the LHX/SHX heat exchanger in the PX Explorer pane. The page specific to that device opens in the right pane.
4. Select the desired sensor in the Sensors table and click Setup Thresholds, or simply double-click that sensor. The setup dialog for the selected sensor appears.

Setting	Enabled	Value (°C)
Lower Critical (°C)	<input checked="" type="checkbox"/>	2.0
Lower Warning (°C)	<input checked="" type="checkbox"/>	5.0
Upper Warning (°C)	<input checked="" type="checkbox"/>	24.0
Upper Critical (°C)	<input checked="" type="checkbox"/>	30.0
Hysteresis (°C)	<input type="checkbox"/>	15.0

5. Adjust the threshold and deassertion hysteresis settings. The Upper Critical and Lower Critical values are points at which the PX considers the operating environment critical and outside the range of the acceptable threshold.
  - To enable any threshold, select the corresponding checkbox. To disable a threshold, deselect the checkbox.
  - After any threshold is enabled, type an appropriate numeric value in the accompanying text box.
  - To set the deassertion hysteresis, type a numeric value in the Deassertion Hysteresis field. See **"To De-assert" and Deassertion Hysteresis** (on page 596).

- To set the assertion timeout, type a numeric value in the Assertion Timeout (samples) field. See **"To Assert" and Assertion Timeout** (on page 594).
6. Click OK.

---

### Monitoring the LHX/SHX Device

The PX web interface lets you monitor the status of the connected LHX/SHX heat exchanger as well as the status of the LHX/SHX built-in sensor.

#### Viewing the Summary

Both the Dashboard and Feature Port pages display the summary of the connected LHX/SHX heat exchangers, including the heat exchanger's name and status, if the LHX/SHX device is detected or manually assigned to the Feature Port.

If the LHX heat exchanger is highlighted in red in the summary, it indicates that there is LHX/SHX sensor failure on that heat exchanger. View the State column to identify failed sensors.

► **To view the LHX/SHX summary on the Dashboard page:**

1. Click the Dashboard icon in the PX Explorer pane, and the Dashboard page opens in the right pane.
2. Locate the LHX/SHX Heat Exchanger section.

► **To view the LHX/SHX summary on the Feature Port page:**

Click the Feature Port folder in the PX Explorer pane. The Feature Port page opens in the right pane, showing the connected LHX/SHX device information.

### Viewing Details

An LHX/SHX heat exchanger page shows detailed information, including:

- Device information and settings
- The air outlet temperature
- The default fan speed
- Readings and states of all LHX/SHX built-in sensors
- Alerts and errors, such as failed LHX/SHX sensors or emergency cooling activation
- Accumulative operating hours

In addition, SHX-30 models indicate the number of power supplies present and if a condenser pump is present, since those options are supported by the SHX-30.

► **To view details of a specific LHX/SHX heat exchanger:**

1. If the Feature Port folder is not expanded, expand it to show the device under the Feature Port folder.
2. Click the LHX/SHX icon in the left pane. The LHX/SHX page opens in the right pane.

---





*Tip: The same LHX/SHX page can be also opened by clicking Feature Port in the left pane, and then double-clicking the LHX/SHX in the right pane.*

---

If any LHX/SHX sensor reading reaches or crosses the critical or warning threshold, that sensor reading row is highlighted in red or yellow. See **The Yellow- or Red-Highlighted Sensors** (on page 83).

#### Device States and Icon Variations

The PX web interface changes icons to represent different statuses of the connected LHX/SHX heat exchanger.

Icons	Device status
	The heat exchanger is turned ON and operating normally.
	The heat exchanger is turned OFF.
	The heat exchanger is turned ON but enters the critical state because of any LHX/SHX sensor failure.
	At least one of the LHX/SHX sensor readings has entered the warning range.
	NO LHX/SHX device is detected on the FEATURE port.

To identify the cause of the critical state, view one of the following.

- The LHX/SHX Heat Exchanger section of the Dashboard page. See **Viewing the Summary** (on page 295).
- The Feature Port page. See **Viewing the Summary** (on page 295).
- The Alert States section of the LHX heat exchanger page. See **Alert States and LHX Event Log** (on page 297).

#### **Alert States and LHX Event Log**

Remote Alert Acknowledgment is supported by the LHX-20 and LHX-40. The SHX-30 does not support Remote Alert Acknowledgment.

When an LHX heat exchanger is physically connected to the PX device, a section labeled Alert States appears on its device page. The Alert States section shows information identifying the LHX sensors that currently fail.

---

*Tip: The Dashboard and Feature Port pages also point out failed sensors. See **Viewing the Summary** (on page 295).*

---

A button labeled Show Event Log is located in the Alert States section. To view LHX events associated with the PX, click this button.

---

*Note: To view the event log for an SHX-30, click Maintenance > View Event Log.*

---

#### **Operating Hours**

Operating hours are the accumulative time since the LHX/SHX heat exchanger is first connected to the PX device and turned ON.

The PX web interface displays the operating hours both for the heat exchanger and its fans. Operating hour information is located in the Statistics section of each heat exchanger page.

Statistics	
Operating Hours (Varistar LHX):	41 d 16 h
Operating Hours (Fan M1):	0 h
Operating Hours (Fan M2):	4 d 4 h
Operating Hours (Fan M3):	8 d 8 h
Operating Hours (Fan M4):	12 d 12 h
Operating Hours (Fan M5):	16 d 16 h
Operating Hours (Fan M6):	20 d 20 h
Operating Hours (Fan M7):	25 d

Below are the time units used for operating hours:

- h: hour(s)
- d: day(s)

For example, "3d 5h" means the total operating time is 3 days and 5 hours.

---

### Turning the LHX/SHX On or Off

The PX allows you to remotely turn on or off a connected heat exchanger.

► **To control the LHX/SHX heat exchanger:**

1. If the Feature Port folder is not expanded, expand it to show the device under the Feature Port folder.
2. Click the LHX/SHX heat exchanger in the PX Explorer pane. The page specific to that device opens in the right pane.
3. Locate the Information section.
  - To turn off the LHX/SHX heat exchanger, click Switch Off.
  - To turn on the LHX/SHX heat exchanger, click Switch On.
4. If you clicked Switch Off in the previous step, a dialog appears, prompting you to confirm the operation. Click Yes to turn it off or No to abort the operation.

The heat exchanger's icon shown in the web interface changes after being turned on or off. See **Device States and Icon Variations** (on page 296).

---

### Requesting Maximum Cooling for an SHX-30

PX allows you to remotely activate the Schroff SHX-30's maximum cooling feature. The LHX-20 and LHX-40 do not support remote activation of maximum cooling.

---

*Note: The maximum cooling mode is a feature of the SHX-30, not the PX.*

---

When you click Request Maximum Cooling on the PX remote interface, the SHX-30 enters into emergency cooling mode and runs at its maximum cooling level of 100% in order to cool the device.

When maximum cooling is requested for an SHX-30, the message "Maximum cooling requested" is displayed in the Alerts section of the page.

When you click the Acknowledge Alert Status button, the alert message disappears even if the actual cooling action on the device is still underway.

For additional information on the maximum cooling function, see the SHX-30 documentation.

► **To request maximum cooling for an SHX-30:**

1. If the Feature Port folder is not expanded, expand it to show the device under the Feature Port folder.
2. Click the LHX/SHX heat exchanger in the PX Explorer pane. The page specific to that device opens in the right pane.
3. Click on the desired SHX heat exchanger in the navigation tree. The page specific to that heat exchanger opens in the right pane.
4. In the Information section of the page, click Request Maximum Cooling to cool the device. The maximum cooling process begins.
5. Click Cancel Maximum Cooling to stop the process (if needed).

---

## Firmware Upgrade

You may upgrade your PX device to benefit from the latest enhancements, improvements and features.

Firmware files are available on Raritan website's **Support page** (<http://www.raritan.com/support/>).

---

### Updating the PX Firmware

When performing the firmware upgrade, the PX keeps each outlet's power status unchanged so no server operation is interrupted. Outlets that have been powered on prior to the firmware upgrade remain powered on and outlets that have been powered off remain powered off during and after the firmware upgrade.

You must be the system administrator or log in to the user profile with the Firmware Update permission to update the PX firmware.

If applicable to your model, download the latest firmware file from the Raritan website's **Support page** (<http://www.raritan.com/support/>), read the release notes, then start the upgrade. If you have any questions or concerns about the upgrade, contact Raritan Technical Support BEFORE upgrading.

On a multi-inlet PDU (any model with X2 or X3 suffixes), all inlets must be connected to the power source for the PDU to successfully upgrade its firmware.

Warning: Do NOT perform the firmware upgrade over a wireless network connection.

### Firmware Update via Web Interface

After downloading the latest firmware, log in to the PX web interface to upgrade the firmware.

---

*Tip 1: Another alternative to update the firmware is via SCP. See **Firmware Update via SCP** (on page 526).*

---

*Tip 2: If you have a large number of PX devices to update and a TFTP server is available, you can choose to perform the firmware upgrade via TFTP in a DHCP network. See **Bulk Configuration or Firmware Upgrade via DHCP/TFTP** (on page 500).*

---

► **To update the firmware:**

1. Choose Maintenance > Update Firmware. The Update Firmware dialog appears.
2. In the Firmware File field, click Browse to select an appropriate firmware file.
3. Click Upload. A progress bar appears to indicate the upload status.
4. When the upload is complete, version information of both the existing firmware and uploaded firmware is shown, providing you a last chance to terminate the update.



5. To view the certificate of the uploaded firmware, click View Certificate. **Optional.**
6. To proceed with the update, click Update Firmware. The update may take several minutes.

---

*Warning: Do NOT power off the PX during the update.*

---

During the firmware update:

- A progress bar appears in the web interface, indicating the update status.
- The front panel display on the PX shows three digits: 'FuP' or 'FUP.'

---

*Exception: A PX3 Phase II model shows the upgrade progress in percent instead of FUP on its LCD display.*

---

- The outlet LEDs flash when the relay boards are being updated.

---

*Exception: If the firmware update does not include the update of the relay board firmware, outlet LEDs do NOT flash.*

---

- No users can successfully log in to the PX.
  - The user management operation, if any, is forced to suspend.
7. When the update is complete, a message appears, indicating the update is successful.
  8. The PX resets, and the Login page re-appears. You can now log in and resume your operation.

---

*Note 1: The other logged-in users are also logged out when the firmware update is complete.*

---

---

*Note 2: If you are using the PX with an SNMP manager, download its MIB again after the firmware update to ensure your SNMP manager has the correct MIB for the latest release you are using. See **Using SNMP** (on page 306) in the online help.*

---

### **A Note about Firmware Upgrade Time**

The PDU firmware upgrade time varies from unit to unit, depending on various external and internal factors.

External factors include, but are not limited to: network throughput, firmware file size, and speed at which the firmware is retrieved from the storage location. Internal factors include: the necessity of upgrading the firmware on the microcontroller and the number of microcontrollers that require upgrade (which depends on the number of outlets). The microcontroller is upgraded only when required. Therefore, the length of firmware upgrade time ranges from approximately 3 minutes (without any microcontroller updated) to almost 7 minutes (with all microcontrollers for 48 outlets updated). Take the above factors into account when estimating the PDU's firmware upgrade time.

The time indicated in this note is for PX web-interface-based upgrades. Upgrades through other management systems, such as Raritan's Power IQ, may take additional time beyond the control of the PDU itself. This note does not address the upgrades using other management systems.

---

### **Viewing Firmware Update History**

The firmware upgrade history, if available, is permanently stored on the PX device.

This history indicates when a firmware upgrade event occurred, the prior and new versions associated with the firmware upgrade event, and the upgrade result.

#### **► To view the firmware update history:**

1. Choose Maintenance > View Firmware Update History. The Firmware Update History dialog appears, with the following information displayed.
  - Date and time of the firmware upgrade event
  - Previous firmware version
  - Update firmware version
  - Firmware upgrade result
2. You may change the number of displayed columns or re-sort the list for better viewing the data.
3. To view the details of any firmware upgrade event, select it and click Details, or simply double-click the event. The Firmware Update Details dialog appears, showing detailed information of the selected event.
4. Click Close to quit the dialog.

---

### Full Disaster Recovery

If the firmware upgrade fails, causing the PX device to stop working, you can recover it by using a special utility rather than returning the device to Raritan.

Contact Raritan Technical Support for the recovery utility, which works in Windows XP/Vista/7 and Linux. In addition, an appropriate PX firmware file is required in the recovery procedure.

---

### Updating the Asset Sensor Firmware

After connecting the asset sensor to the PX device, it automatically checks its own firmware version against the version of the asset sensor firmware stored in the PX firmware. If two versions are different, the asset sensor automatically starts downloading the new firmware from the PX device to upgrade its own firmware.

During the firmware upgrade, the following events take place:

- The asset sensor is completely lit up, with the blinking LEDs changing the color from red to green.
- A firmware upgrade process is indicated in the PX web interface.
- An SNMP trap is sent to indicate the firmware upgrade event.

---

## Accessing the Help

The Help menu provides:

- Current firmware and software packages information
- A link to the PX help

---

### Retrieving Software Packages Information

You can check the current firmware version and the information of all open source packages embedded in the PX device through the web interface.

► **To retrieve the embedded software packages information:**

1. Choose Help > About PX iPDU. The About PX iPDU dialog appears, with a list of open source packages displayed.
2. You can click any link in the dialog to access related information or download any software package.









---

## Browsing through the Online Help



The PX Online Help is accessible over the Internet.

To use online help, Active Content must be enabled in your browser. If you are using Internet Explorer 7, you must enable Scriptlets. Consult your browser help for information on enabling these features.

### ► To use the PX online help:

1. Choose Help > User Guide. The online help opens in the default web browser.
2. To view the content of any topic, click the topic in the left pane. Then its content is displayed in the right pane.
3. To select a different topic, do any of the following:
  - To view the next topic, click the Next icon  in the toolbar.
  - To view the previous topic, click the Previous icon .
  - To view the first topic, click the Home icon .
4. To expand or collapse a topic that contains sub-topics, do the following:
  - To expand any topic, click the white arrow  prior to the topic, or double-click that topic. The arrow turns into a black, gradient arrow , and sub-topics appear below the topic.
  - To collapse any expanded topic, click the black, gradient arrow  prior to the topic, or double-click the expanded topic. The arrow then turns into a white arrow , and all sub-topics below that topic disappear.
5. To search for specific information, type the key word(s) or string(s) in the Search text box, and press Enter or click the Search icon  to start the search.
  - If necessary, select the "Match partial words" checkbox to include information matching part of the words entered in the Search text box.

The search results are displayed in the left pane.

6. To have the left pane show the list of topics, click the Contents tab at the bottom.
7. To show the Index page, click the Index tab.
8. To email any URL link to the currently selected topic to any person, click the "Email this page" icon  in the toolbar.
9. To email your comments or suggestions regarding the online help to Raritan, click the "Send feedback" icon .

10. To print the currently selected topic, click the "Print this page" icon



# Chapter 7 Using SNMP

This SNMP section helps you set up the PX for use with an SNMP manager. The PX can be configured to send traps or informs to an SNMP manager, as well as receive GET and SET commands in order to retrieve status and configure some basic settings.

## In This Chapter

Enabling SNMP .....	306
Configuring Users for Encrypted SNMP v3 .....	307
Configuring SNMP Notifications .....	308
SNMP Gets and Sets .....	312

---

## Enabling SNMP

By default, SNMP v1/v2c is enabled on the PX so the PX can communicate with an SNMP manager. If you have disabled the SNMP, it must be enabled to communicate with an SNMP manager.

Note that read-only access is enabled and the community string is public.

► **To enable SNMP:**

1. Choose Device Settings > Network Services > SNMP. The SNMP Settings dialog appears.

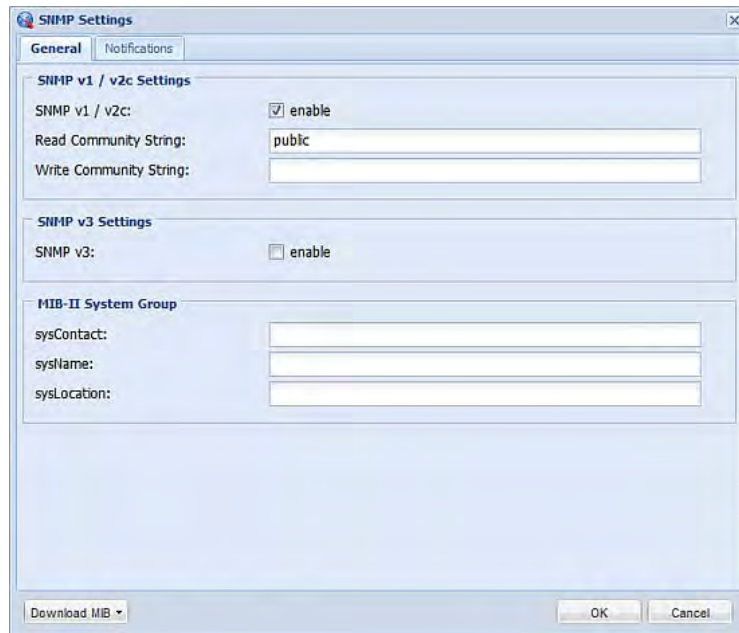

2. Select the "enable" checkbox in the "SNMP v1 / v2c" field to enable communication with an SNMP manager using SNMP v1 or v2c protocol.
  - Type the SNMP read-only community string in the Read Community String field. Usually the string is "public."
  - Type the read/write community string in the Write Community String field. Usually the string is "private."
3. Select the "enable" checkbox in the "SNMP v3" field to enable communication with an SNMP manager using SNMP v3 protocol.

---

*Tip: You can permit or disallow a user to access the PX via the SNMP v3 protocol. See **Configuring Users for Encrypted SNMP v3** (on page 307).*

---

4. Enter the MIB-II system group information, if applicable:
  - a. sysContact - the contact person in charge of the system being contacted
  - b. sysName - the name assigned to the system
  - c. sysLocation - the location of the system
5. Select the MIB to be downloaded. The SNMP MIB for your PX is used by the SNMP manager.

---

*Important: You must download the SNMP MIB for your PX to use with your SNMP manager. Click Download MIB in this dialog to download the desired MIB file. For more details, see **Downloading SNMP MIB** (on page 313).*

---

6. Click OK.

---

## Configuring Users for Encrypted SNMP v3

The SNMP v3 protocol allows for encrypted communication. To take advantage of this, users need to have an Authentication Pass Phrase and Privacy Pass Phrase, which act as shared secrets between them and the PX.

### ► To configure users for SNMP v3 encrypted communication:

1. Choose User Management > Users. The Manage Users dialog appears.
2. Select the user by clicking it.
3. Click Edit or double-click the user. The Edit User 'XXX' dialog appears, where XXX is the user name.
4. To change the SNMPv3 access permissions, click the SNMPv3 tab and make necessary changes. For details, see Step 6 of **Creating a User Profile** (on page 132).

5. Click OK. The user is now set up for encrypted SNMP v3 communication.

---

## Configuring SNMP Notifications

The PX automatically keeps an internal log of events that occur. See **Event Rules and Actions** (on page 199). These events can also be used to send SNMP v2c or v3 notifications to a third-party destination.

The PX provides you with the ability to create SNMPv2c and SNMPv3 TRAP communications, or SNMPv2c and SNMPv3 INFORM communications.

SNMP TRAP communications capture and send information via SNMP, but no confirmation that the communication between the devices has succeeded is provided by the receiving device.

SNMP INFORM communications capture and send information via SNMP, and an acknowledgment that the communication was received by the receiving device is provided. If the inform communication fails, it is resent. You can define the number of times and the intervals to resend the inform communication, or leave the defaults of five (5) resends in three (3) second intervals.

---

*Note: SNMP INFORM communications may take up slightly more network resources than SNMP TRAP communications since there are additional communications between the devices, and due to additional network traffic created should the initial communication fail and another is sent.*

---

Use SNMP TRAP rules if you do not need confirmation that the communication has succeeded, and if you need to conserve network resources. Use SNMP INFORM communications to ensure more reliable communications, and if network resources can be managed with the potential additional network traffic.

---

*Note: You should update the MIB used by your SNMP manager when updating to a new PX release. This ensures your SNMP manager has the correct MIB for the release you are using. See **Downloading SNMP MIB** (on page 313).*

---



## SNMPv2c Notifications

► **To configure the PX to send SNMP notifications:**

1. Choose Device Settings > Network Services > SNMP. The SNMP Settings dialog appears.

The image shows the 'SNMP Settings' dialog box with the 'General' tab selected. The dialog is divided into three main sections:

- SNMP v1 / v2c Settings:** Includes a checked 'enable' checkbox, a 'Read Community String' field containing 'public', and an empty 'Write Community String' field.
- SNMP v3 Settings:** Includes an unchecked 'enable' checkbox.
- MIB-II System Group:** Includes three empty text input fields labeled 'sysContact:', 'sysName:', and 'sysLocation:'.

At the bottom of the dialog, there is a 'Download MIB' dropdown menu, and 'OK' and 'Cancel' buttons.

2. Enter the MIB-II system group information, if applicable:
  - a. sysContact - the contact person in charge of the system being contacted
  - b. sysName - the name assigned to the system
  - c. sysLocation - the location of the system
3. Select the MIB to be downloaded. The SNMP MIB for your PX is used by the SNMP manager.

---

*Important: You must download the SNMP MIB for your PX to use with your SNMP manager. Click Download MIB in this dialog to download the desired MIB file. For more details, see **Downloading SNMP MIB** (on page 313).*

---

4. Click OK.
5. On the Notifications tab, select the Enable checkbox to enable the SNMP notification feature.
6. From the Notification Type drop-down, select the type of SNMP notification.
7. For SNMP INFORM communications, leave the resend settings at their default or:

- a. In the Timeout (sec) field, enter the interval of time, in seconds, after which a new inform communication is resent if the first is not received. For example, resend a new inform communication once every 3 seconds.
  - b. In the Number of Retries field, enter the number of times you want to resend the inform communication if it fails. For example, inform communications are resent up to 5 times when the initial communication fails.
8. In the Host fields, enter the IP address of the device(s) you want to access. This is the address to which notifications are sent by the SNMP system agent. You can specify up to 3 SNMP destinations.
  9. In the Port fields, enter the port number used to access the device(s).
  10. In the Community fields, enter the SNMP community string to access the device(s). The community is the group representing the PX and all SNMP management stations.
  11. Click OK.

---

### SNMPv3 Notifications

► **To configure the PX to send SNMPv3 notifications:**

1. Choose Device Settings > Network Services > SNMP. The SNMP Settings dialog appears.

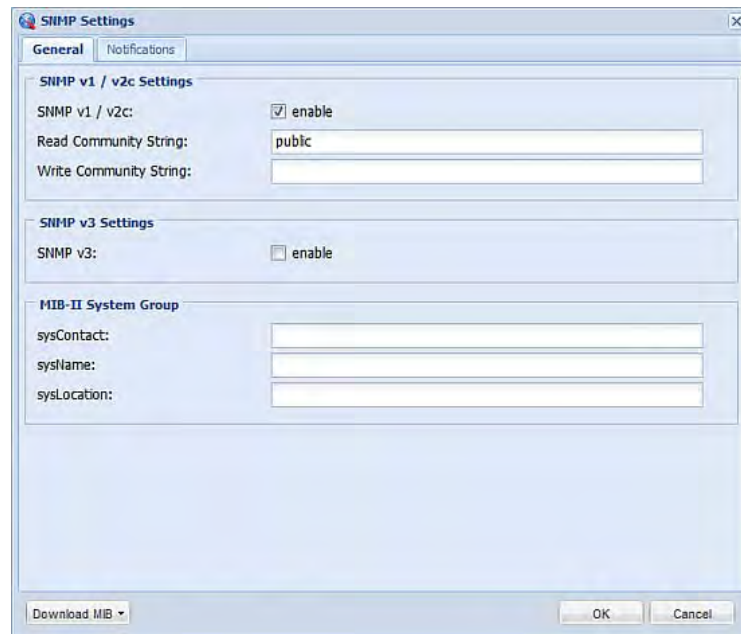

2. Enter the MIB-II system group information, if applicable:

- a. sysContact - the contact person in charge of the system being contacted
  - b. sysName - the name assigned to the system
  - c. sysLocation - the location of the system
3. Select the MIB to be downloaded. The SNMP MIB for your PX is used by the SNMP manager.

---

*Important: You must download the SNMP MIB for your PX to use with your SNMP manager. Click Download MIB in this dialog to download the desired MIB file. For more details, see **Downloading SNMP MIB** (on page 313).*

---

4. Click OK.
5. On the Notifications tab, select the Enable checkbox to enable the SNMP notification feature.
6. From the Notification Type drop-down, select the type of SNMP notification.
7. For SNMP TRAPS, the engine ID is prepopulated.
8. For SNMP INFORM communications, leave the resend settings at their default or:
  - a. In the Timeout (sec) field, enter the interval of time, in seconds, after which a new inform communication is resent if the first is not received. For example, resend a new inform communication once every 3 seconds.
  - b. In the Number of Retries field, enter the number of times you want to resend the inform communication if it fails. For example, inform communications are resent up to 5 times when the initial communication fails.
9. For both SNMP TRAPS and INFORMS, enter the following as needed and then click OK to apply the settings:
  - a. Host name
  - b. Port number
  - c. User ID needed to access the host
  - d. Select the host security level

Security level	Description
"noAuthNoPriv"	Select this if no authorization or privacy protocols are needed.
"authNoPriv"	Select this if authorization is required but no privacy protocols are required. <ul style="list-style-type: none"> <li>• Select the authentication protocol - MD5 or SHA</li> <li>• Enter the authentication passphrase and then confirm the authentication passphrase</li> </ul>
"authPriv"	Select this if authentication and privacy protocols are required. <ul style="list-style-type: none"> <li>• Select the authentication protocol - MD5 or SHA</li> <li>• Enter the authentication passphrase and confirm the authentication passphrase</li> <li>• Select the Privacy Protocol - DES or AES</li> <li>• Enter the privacy passphrase and then confirm the privacy passphrase</li> </ul>

---

## SNMP Gets and Sets

In addition to sending traps, the PX is able to receive SNMP get and set requests from third-party SNMP managers.

- Get requests are used to retrieve information about the PX, such as the system location, and the current on a specific outlet.
- Set requests are used to configure a subset of the information, such as the SNMP system name.

---

*Note: The SNMP system name is the PX device name. When you change the SNMP system name, the device name shown in the web interface is also changed.*

---

The PX does NOT support configuring IPv6-related parameters using the SNMP set requests.

Valid objects for these requests are limited to those found in the SNMP MIB-II System Group and the custom PX MIB.

---

## The PX MIB

The SNMP MIB file is required for using your PX device with an SNMP manager. An SNMP MIB file describes the SNMP functions.

### Downloading SNMP MIB

The SNMP MIB file for the PX can be easily downloaded from the web interface. There are two ways to download the SNMP MIB file.

▶ **To download the file from the SNMP Settings dialog:**

1. Choose Device Settings > Network Services > SNMP. The SNMP Settings dialog appears.
2. Click Download MIB. A submenu of MIB files appears.
3. Select the desired MIB file to download.
  - PDU2-MIB: The SNMP MIB file for PX power management.
  - ASSETMANAGEMENT-MIB: The SNMP MIB file for asset management.
4. Click Save to save the file onto your computer.

▶ **To download the file from the Device Information dialog:**

1. Choose Maintenance > Device Information. The Device Information dialog appears.
2. Click the PDU2-MIB or ASSETMANAGEMENT-MIB link to download the desired SNMP MIB file.
  - PDU2-MIB: The SNMP MIB file for PX power management.
  - ASSETMANAGEMENT-MIB: The SNMP MIB file for asset management.

The "USB Console INF file" link lets you download the USB-to-serial driver that may be required only when the PX is connected to a computer via an USB cable for configuration. See ***Installing the USB-to-Serial Driver (Optional)*** (on page 16) for details.

3. Click Save to save the file onto your computer.

---

*Note: If the LHX/SHX support has been enabled, LHX-MIB is available for download in either dialog.*

---

## Layout

Opening the MIB reveals the custom objects that describe the PX system at the unit level as well as at the individual-outlet level.

As standard, these objects are first presented at the beginning of the file, listed under their parent group. The objects then appear again individually, defined and described in detail.

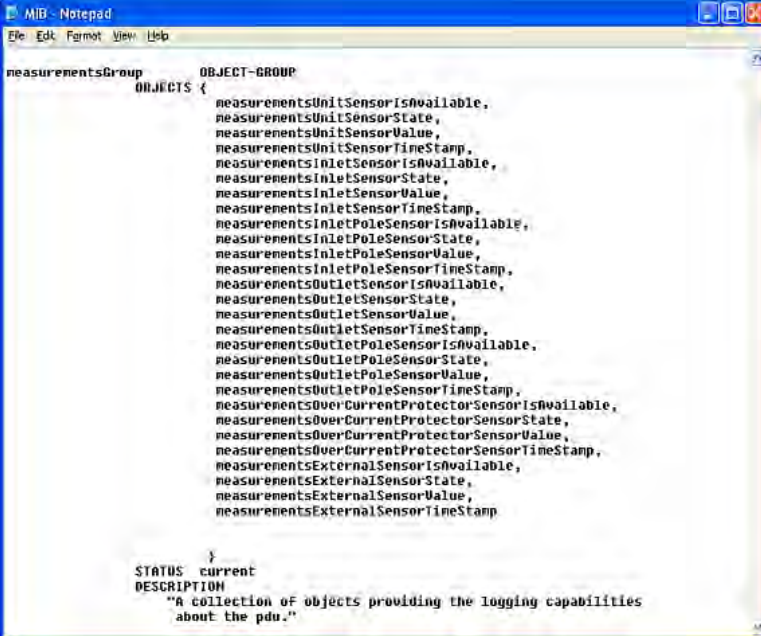

```

MIB - Notepad
File Edit Format View Help

measurementsGroup      OBJECT-GROUP
OBJECTS {
    measurementsUnitSensorIsAvailable,
    measurementsUnitSensorState,
    measurementsUnitSensorValue,
    measurementsUnitSensorTimeStamp,
    measurementsInletSensorIsAvailable,
    measurementsInletSensorState,
    measurementsInletSensorValue,
    measurementsInletSensorTimeStamp,
    measurementsInletPoleSensorIsAvailable,
    measurementsInletPoleSensorState,
    measurementsInletPoleSensorValue,
    measurementsInletPoleSensorTimeStamp,
    measurementsOutletSensorIsAvailable,
    measurementsOutletSensorState,
    measurementsOutletSensorValue,
    measurementsOutletSensorTimeStamp,
    measurementsOutletPoleSensorIsAvailable,
    measurementsOutletPoleSensorState,
    measurementsOutletPoleSensorValue,
    measurementsOutletPoleSensorTimeStamp,
    measurementsOverCurrentProtectorSensorIsAvailable,
    measurementsOverCurrentProtectorSensorState,
    measurementsOverCurrentProtectorSensorValue,
    measurementsOverCurrentProtectorSensorTimeStamp,
    measurementsExternalSensorIsAvailable,
    measurementsExternalSensorState,
    measurementsExternalSensorValue,
    measurementsExternalSensorTimeStamp
}
STATUS current
DESCRIPTION
    "A collection of objects providing the logging capabilities
    about the pdu."
  
```

For example, the measurementsGroup group contains objects for sensor readings of PX as a whole. One object listed under this group, measurementsUnitSensorValue, is described later in the MIB as "The sensor value". pduRatedCurrent, part of the configGroup group, describes the PDU current rating.

### SNMP Sets and Thresholds

Some objects can be configured from the SNMP manager using SNMP set commands. Objects that can be configured have a MAX-ACCESS level of "read-write" in the MIB.

These objects include threshold objects, which causes the PX to generate a warning and send an SNMP notification when certain parameters are exceeded. See **Setting Power Thresholds** (on page 192) for a description of how thresholds work.

---

*Note: When configuring the thresholds via SNMP set commands, ensure the value of upper critical threshold is higher than that of upper warning threshold.*

---

### Configuring NTP Server Settings

Using SNMP, you can change the following NTP server-related settings:

- Enable or disable synchronizing the PDU's date and time with NTP servers.
- Enable or disable the use of DHCP-assigned NTP servers if synchronization with NTP servers is enabled.
- Manually assign the primary NTP server if the use of DHCP-assigned NTP servers is disabled.
- Manually assign the secondary NTP server (optional).

---

*Tip: To specify the time zone, use the CLI or web interface instead. For the CLI, see **Setting the Time Zone** (on page 390). For the web interface, see **Setting the Date and Time** (on page 112).*

---

When using the SNMP SET command to specify or change NTP servers, it is required that both the NTP server's address type and address be set in the command line simultaneously.

For example, the SNMP command to change the primary NTP server's address from IPv4 (192.168.84.84) to host name looks similar to the following:

```
snmpset -v2c -c private 192.168.84.84
firstNTPServerAddressType = dns firstNTPServerAddress =
"angu.pep.com"
```

---

### Retrieving Energy Usage

You can discover how much energy an IT device consumes by retrieving the Active Energy for the outlet this IT device is plugged into. The Active Energy values are included in the outletSensorMeasurementsTable, along with other outlet sensor readings.

---

**A Note about Enabling Thresholds**

When enabling previously disabled thresholds via SNMP, make sure you set a correct value for all thresholds that are supposed to be enabled prior to actually enabling them. Otherwise, you may get an error message.



## Chapter 8 Using the Command Line Interface

This section explains how to use the command line interface (CLI) to administer a PX device.

### In This Chapter

About the Interface .....	317
Logging in to CLI .....	318
Help Command.....	322
Querying Available Parameters for a Command.....	323
Showing Information.....	323
Clearing Information .....	354
Configuring the PX Device and Network .....	355
Load Shedding Configuration Commands .....	466
Power Control Operations .....	468
Checking the Accessibility of NTP Servers .....	472
Actuator Control Operations.....	472
Unblocking a User .....	474
Resetting the PX.....	474
Network Troubleshooting.....	476
Retrieving Previous Commands.....	479
Automatically Completing a Command .....	479
Logging out of CLI .....	480

---

### About the Interface

The PX provides a command line interface that enables data center administrators to perform some basic management tasks.

Using this interface, you can do the following:

- Reset the PX device
- Display the PX and network information, such as the device name, firmware version, IP address, and so on
- Configure the PX and network settings
- Troubleshoot network problems

You can access the interface over a local connection using a terminal emulation program such as HyperTerminal, or via a Telnet or SSH client such as PuTTY.

---

*Note: Telnet access is disabled by default because it communicates openly and is thus insecure. To enable Telnet, see **Modifying Network Service Settings** (on page 105).*

---

---

## Logging in to CLI

Logging in via HyperTerminal over a local connection is a little different than logging in using SSH or Telnet.

If a security login agreement has been enabled, you must accept the agreement in order to complete the login. Users are authenticated first and the security banner is checked afterwards.

---

### With HyperTerminal

You can use any terminal emulation programs for local access to the command line interface.

This section illustrates HyperTerminal, which is part of Windows operating systems prior to Windows Vista.

► **To log in using HyperTerminal:**

1. Connect your computer to the PX via a local connection.
2. Launch HyperTerminal on your computer and open a console window. When the window first opens, it is blank.

Make sure the COM port settings use this configuration:

- Bits per second = 115200 (115.2Kbps)
- Data bits = 8
- Stop bits = 1
- Parity = None
- Flow control = None

---

*Tip: For a USB connection, you can determine the COM port by choosing Control Panel > System > Hardware > Device Manager, and locating the "Serial Console" under the Ports group.*

---

3. In the communications program, press Enter to send a carriage return to the PX. The Username prompt appears.

```
Username: _
```

4. Type a name and press Enter. The name is case sensitive. Then you are prompted to enter a password.

```
Username: admin
Password: _
```

5. Type a password and press Enter. The password is case sensitive.

After properly entering the password, the # or > system prompt appears. See **Different CLI Modes and Prompts** (on page 321) in the online help for more information.

---

*Tip: The "Last Login" information, including the date and time, is also displayed if the same user profile was used to log in to this product's web interface or CLI.*

---

6. You are now logged in to the command line interface and can begin administering the PX.

---

### With SSH or Telnet

You can remotely log in to the command line interface (CLI) using an SSH or Telnet client, such as PuTTY.

---

*Note: PuTTY is a free program you can download from the Internet. See PuTTY's documentation for details on configuration.*

---

#### ► To log in using SSH or Telnet:

1. Ensure SSH or Telnet has been enabled. See **Modifying Network Service Settings** (on page 105) in the online help.
2. Launch an SSH or Telnet client and open a console window. A login prompt appears.

```
login as: █
```

3. Type a name and press Enter. The name is case sensitive.

---

*Note: If using the SSH client, the name must NOT exceed 25 characters. Otherwise, the login fails.*

---

Then you are prompted to enter a password.

```
login as: admin
admin@192.168.84.88's password: █
```

4. Type a password and press Enter. The password is case sensitive.
5. After properly entering the password, the # or > system prompt appears. See **Different CLI Modes and Prompts** (on page 321) in the online help for more information.

---

*Tip: The "Last Login" information, including the date and time, is also displayed if the same user profile was used to log in to this product's web interface or CLI.*

---

6. You are now logged in to the command line interface and can begin administering the PX.

---

### With an Analog Modem

The PX supports remote access to the CLI via a connected analog modem. This feature is especially useful when the LAN access is not available.

► **To connect to the PX via the modem:**

1. Make sure the PX has an analog modem connected. See **Connecting an Analog Modem** (on page 53).
2. Make sure the computer you are using has an appropriate modem connected.
3. Launch a terminal emulation program, and configure its baud rate settings according to the baud rate set for the analog modem connected to the PX. See **Configuring the Serial Port** (on page 118).
4. Type the following AT command to make a connection with the PX.  
`ATD<modem phone number>`
5. The CLI login prompt appears after the connection is established successfully. Then type the user name and password to log in to the CLI.

► **To disconnect from the PX:**

1. Return to the modem's command mode using the escape code +++.
2. After the OK prompt appears, type the following AT command to disconnect from the PX.

`ATH`

---

### Different CLI Modes and Prompts

Depending on the login name you use and the mode you enter, the system prompt in the CLI varies.

- **User Mode:** When you log in as a normal user, who may not have full permissions to configure the PX device, the **>** prompt appears.
- **Administrator Mode:** When you log in as an administrator, who has full permissions to configure the PX device, the **#** prompt appears.
- **Configuration Mode:** You can enter the configuration mode from the administrator or user mode. In this mode, the prompt changes to **config:#** or **config:>** and you can change PX device and network configurations. See **Entering Configuration Mode** (on page 355).
- **Diagnostic Mode:** You can enter the diagnostic mode from the administrator or user mode. In this mode, the prompt changes to **diag:#** or **diag:>** and you can perform the network troubleshooting commands, such as the ping command. See **Entering Diagnostic Mode** (on page 476).

---

### Closing a Local Connection

Close the window or terminal emulation program when you finish accessing a PX device over the local connection.

When accessing or upgrading multiple PX devices, do not transfer the local connection cable from one device to another without closing the local connection window first.

---

## Help Command

The help (?) command shows a list of main CLI commands available for the current mode. This is helpful when you are not familiar with CLI commands.

▶ **Help command under the administrator mode:**

```
# ?
```

▶ **Help command under the configuration mode:**

```
config:# ?
```

▶ **Help command under the diagnostic mode:**

```
diag:# ?
```

Press Enter after typing the help command, and a list of main commands for the current mode is displayed.

---

*Tip: You can check what parameters are available for a specific CLI command by adding the help command to the end of the queried command. See **Querying Available Parameters for a Command** (on page 323).*

---

---

## Querying Available Parameters for a Command

If you are not sure what commands or parameters are available for a particular type of CLI command or its syntax, you can have the CLI show them by adding a space and the help command (?) to the end of that command. A list of available parameters and their descriptions will be displayed.

The following shows a few query examples.

▶ **To query available parameters for the "show" command:**

```
# show ?
```

▶ **To query available parameters for the "show user" command:**

```
# show user ?
```

▶ **To query available network configuration parameters:**

```
config:# network ?
```

▶ **To query available role configuration parameters:**

```
config:# role ?
```

▶ **To query available parameters for the "role create" command:**

```
config:# role create ?
```

---

## Showing Information

You can use the show commands to view current settings or the status of the PX device or part of it, such as the IP address, networking mode, firmware version, states or readings of internal or external sensors, user profiles, and so on.

Some "show" commands have two formats: one with the parameter "details" and the other without. The difference is that the command without the parameter "details" displays a shortened version of information while the other displays in-depth information.

After typing a "show" command, press Enter to execute it.

---

*Note: Depending on your login name, the # prompt may be replaced by the > prompt. See **Different CLI Modes and Prompts** (on page 321).*

---

---

### Network Configuration

This command shows all network configuration, such as the IP address, networking mode, and MAC address.

```
# show network
```

### IP Configuration

This command shows the IP-related configuration only, such as IPv4 and IPv6 configuration, address(es), gateway, and subnet mask.

```
# show network ip <option>
```

*Variables:*

- <option> is one of the options: *all*, *v4* or *v6*.

Option	Description
all	This options shows both IPv4 and IPv6 settings. <i>Tip: You can also type the command without adding this option "all" to get the same data.</i>
v4	This option shows the IPv4 settings only.
v6	This option shows the IPv6 settings only.

### LAN Interface Settings

This command shows the LAN interface information only, including LAN interface speed, duplex mode, current LAN interface status and LAN interface MAC address.

```
# show network interface
```



**Networking Mode**

This command shows whether the current networking mode is wired or wireless.

```
# show network mode
```

---

*Note: If the PX is a slave device connected to the LAN via the master PX device, the `show network mode` command displays wired(USB) instead of wired.*

---

**Wireless Configuration**

This command only shows the wireless configuration of the PX device, such as the SSID parameter.

```
# show network wireless
```

To show detailed information, add the parameter "details" to the end of the command.

```
# show network wireless details
```

**Network Service Settings**

This command shows the network service settings only, including the Telnet setting, TCP ports for HTTP, HTTPS, SSH and Modbus/TCP services, and SNMP settings.

```
# show network services <option>
```

*Variables:*

- <option> is one of the options: *all, http, https, telnet, ssh, snmp, modbus* and *zeroconfig*.

Option	Description
all	Displays the settings of all network services, including HTTP, HTTPS, Telnet, SSH and SNMP. <i>Tip: You can also type the command without adding this option "all" to get the same data.</i>
http	Only displays the TCP port for the HTTP service.

Option	Description
https	Only displays the TCP port for the HTTPS service.
telnet	Only displays the settings of the Telnet service.
ssh	Only displays the settings of the SSH service.
snmp	Only displays the SNMP settings.
modbus	Only displays the settings of the Modbus/TCP service.
zeroconfig	Only displays the settings of the zero configuration advertising.

---

### PDU Configuration

This command shows the PDU configuration, such as the device name, firmware version and model type.

```
# show pdu
```

To show detailed information, add the parameter "details" to the end of the command.

```
# show pdu details
```

---

### Outlet Information

This command syntax shows the outlet information.

```
# show outlets <n>
```

To show detailed information, add the parameter "details" to the end of the command.

```
# show outlets <n> details
```

*Variables:*

- <n> is one of the options: *all*, or a number.

Option	Description
all	Displays the information for all outlets.  <i>Tip: You can also type the command without adding this option "all" to get the same data.</i>
A specific outlet number	Displays the information for the specified outlet only.

*Displayed information:*

- Without the parameter "details," only the outlet name and state are displayed.
- With the parameter "details," more outlet information is displayed in addition to the state, such as rated current, voltage, active power, active energy, and outlet settings.

---

### Inlet Information

This command syntax shows the inlet information.

```
#          show inlets <n>
```

To show detailed information, add the parameter "details" to the end of the command.

```
#          show inlets <n> details
```

*Variables:*

- <n> is one of the options: *all*, or a number.

Option	Description
all	Displays the information for all inlets.  <i>Tip: You can also type the command without adding this option "all" to get the same data.</i>
A specific inlet number	Displays the information for the specified inlet only. An inlet number needs to be specified only when there are more than 1 inlet on your PDU.

*Displayed information:*

- Without the parameter "details," only the inlet's name and RMS current are displayed.
- With the parameter "details," more inlet information is displayed in addition to the inlet name and RMS current, such as the inlet's RMS voltage, active power and active energy.

---

## Overcurrent Protector Information

This command is only available for models with overcurrent protectors for protecting outlets.

This command syntax shows the overcurrent protector information, such as a circuit breaker or a fuse.

```
#          show ocp <n>
```

To show detailed information, add the parameter "details" to the end of the command.

```
#          show ocp <n> details
```

*Variables:*

- <n> is one of the options: *all*, or a number.

Option	Description
all	Displays the information for all overcurrent protectors.  <i>Tip: You can also type the command without adding this option "all" to get the same data.</i>
A specific overcurrent protector number	Displays the information for the specified overcurrent protector only.

*Displayed information:*

- Without the parameter "details," only the overcurrent protector status and name are displayed.
- With the parameter "details," more overcurrent protector information is displayed in addition to status, such as the rating and RMS current value.

---

### Date and Time Settings

This command shows the current date and time settings on the PX device.

```
# show time
```

To show detailed information, add the parameter "details" to the end of the command.

```
# show time details
```

---

### Default Measurement Units

This command shows the default measurement units applied to the PX web and CLI interfaces across all users, especially those users authenticated through remote authentication servers.

```
# show user defaultPreferences
```

---

*Note: If a user has set his/her own preferred measurement units or the administrator has changed any user's preferred units, the web and CLI interfaces show the preferred measurement units for that user instead of the default ones after that user logs in to the PX. See **Existing User Profiles** (on page 343) for the preferred measurement units for a specific user.*

---

---

### Environmental Sensor Information

This command syntax shows the environmental sensor's information.

```
# show externalsensors <n>
```

To show detailed information, add the parameter "details" to the end of the command.

```
# show externalsensors <n> details
```

```
External sensor 3 ('Temperature 1')
```

```
Sensor type: Temperature
```

```
Reading:      31.8 deg C (normal)
```

```
Serial number:      AEI0950133
```

```
Description:       Not configured
```

```
Location:          X Not configured
```

```
                  Y Not configured
```

```
                  Z Not configured
```

```
Position:         Port 1
```

```
Using default thresholds: yes
```

Variables:

- <n> is one of the options: *all*, or a number.

Option	Description
all	Displays the information of all environmental sensors.  <i>Tip: You can also type the command without adding this option "all" to get the same data.</i>
A specific environmental sensor number*	Displays the information for the specified environmental sensor only.

\* The environmental sensor number is the ID number assigned to the sensor, which can be found on the Peripheral Devices page of the PX web interface.

*Displayed information:*

- Without the parameter "details," only the sensor ID, sensor type and reading are displayed.

---

*Note: A discrete (on/off) sensor displays the sensor state instead of the numeric reading.*

---

- With the parameter "details," more information is displayed in addition to the ID number and sensor reading, such as the serial number, sensor position, and X, Y, and Z coordinates.

---

*Note: DPX sensor packages do not provide chain position information..*

---



---

### Environmental Sensor Package Information

Different from the "show externalsensors" commands, which show the reading, status and configuration of an individual environmental sensor, the following command shows the information of all connected environmental sensor packages, each of which may contain more than one sensor or actuator.

```
# show peripheralDevicePackages
```

Information similar to the following is displayed. An environmental sensor package is a peripheral device package.

```
Peripheral Device Package 1
Serial Number:    AEI7A00022
Package Type:    DPX-T1H1
Position:        Port 1
Package State:    operational
Firmware Version: Not available
```

```
Peripheral Device Package 2
Serial Number:    AEI7A00021
Package Type:    DPX-T3H1
Position:        Port 1
Package State:    operational
Firmware Version: Not available
```

---

### Actuator Information

This command syntax shows an actuator's information.

```
# show actuators <n>
```

To show detailed information, add the parameter "details" to the end of the command.

```
# show actuators <n> details
```

Variables:

- <n> is one of the options: *all*, or a number.

Option	Description
all	Displays the information for all actuators.  <i>Tip: You can also type the command without adding this option "all" to get the same data.</i>
A specific actuator number*	Displays the information for the specified actuator only.

\* The actuator number is the ID number assigned to the actuator. The ID number can be found using the PX web interface or CLI. It is an integer starting at 1.

*Displayed information:*

- Without the parameter "details," only the actuator ID, type and state are displayed.
- With the parameter "details," more information is displayed in addition to the ID number and actuator state, such as the serial number and X, Y, and Z coordinates.

---

### Outlet Sensor Threshold Information

This command syntax shows the specified outlet sensor's threshold-related information.

```
# show sensor outlet <n> <sensor type>
```

To show detailed information, add the parameter "details" to the end of the command.

```
# show sensor outlet <n> <sensor type> details
```

#### Variables:

- <n> is the number of the outlet whose sensors you want to query.
- <sensor type> is one of the following sensor types:

Sensor type	Description
current	Current sensor
voltage	Voltage sensor
activePower	Active power sensor
apparentPower	Apparent power sensor
powerFactor	Power factor sensor
activeEnergy	Active energy sensor
lineFrequency	Line frequency sensor

#### Displayed information:

- Without the parameter "details," only the sensor reading, state, threshold, deassertion hysteresis and assertion timeout settings of the specified outlet sensor are displayed.
- With the parameter "details," more sensor information is displayed, including resolution and range.
- If the requested sensor type is not supported, the "Sensor is not available" message is displayed.

### Outlet Pole Sensor Threshold Information

This command is available for an in-line monitor only, including PX2-3000 and PX3-3000 series.

This command syntax shows the specified outlet pole sensor's threshold-related information.

```
# show sensor outletpole <n> <p> <sensor type>
```

To show detailed information, add the parameter "details" to the end of the command.

```
# show sensor outletpole <n> <p> <sensor type> details
```

*Variables:*

- <n> is the number of the outlet whose pole sensors you want to query.
- <p> is the label of the outlet pole whose sensors you want to query.

Pole	Label <p>	Current sensor	Voltage sensor
1	L1	L1	L1 - L2
2	L2	L2	L2 - L3
3	L3	L3	L3 - L1

- <sensor type> is one of the following sensor types:

Sensor type	Description
current	Current sensor
voltage	Voltage sensor
activePower	Active power sensor
apparentPower	Apparent power sensor
powerFactor	Power factor sensor
activeEnergy	Active energy sensor

*Displayed information:*

- Without the parameter "details," only the reading, state, threshold, deassertion hysteresis and assertion delay settings of the specified outlet pole sensor are displayed.
- With the parameter "details," more sensor information is displayed, including resolution and range.
- If the requested sensor type is not supported, the "Sensor is not available" message is displayed.

**Inlet Sensor Threshold Information**

This command is NOT available for an in-line monitor (PX2-3000 series).

This command syntax shows the specified inlet sensor's threshold-related information.

```
#          show sensor inlet <n> <sensor type>
```

To show detailed information, add the parameter "details" to the end of the command.

```
#          show sensor inlet <n> <sensor type> details
```

*Variables:*

- <n> is the number of the inlet whose sensors you want to query. For a single-inlet PDU, <n> is always the number 1.
- <sensor type> is one of the following sensor types:

Sensor type	Description
current	Current sensor
voltage	Voltage sensor
activePower	Active power sensor
apparentPower	Apparent power sensor
powerFactor	Power factor sensor
activeEnergy	Active energy sensor
unbalancedCurrent	Unbalanced load sensor
lineFrequency	Line frequency sensor

*Displayed information:*

- Without the parameter "details," only the reading, state, threshold, deassertion hysteresis and assertion timeout settings of the specified inlet sensor are displayed.
- With the parameter "details," more sensor information is displayed, including resolution and range.
- If the requested sensor type is not supported, the "Sensor is not available" message is displayed.

---

**Inlet Pole Sensor Threshold Information**

This command is only available for a three-phase PDU except for an in-line monitor (PX2-3000 series).

This command syntax shows the specified inlet pole sensor's threshold-related information.

```
# show sensor inletpole <n> <p> <sensor type>
```

To show detailed information, add the parameter "details" to the end of the command.

```
# show sensor inletpole <n> <p> <sensor type> details
```

*Variables:*

- <n> is the number of the inlet whose pole sensors you want to query. For a single-inlet PDU, <n> is always the number 1.
- <p> is the label of the inlet pole whose sensors you want to query.

Pole	Label <p>	Current sensor	Voltage sensor
1	L1	L1	L1 - L2
2	L2	L2	L2 - L3
3	L3	L3	L3 - L1

- <sensor type> is one of the following sensor types:

Sensor type	Description
current	Current sensor
voltage	Voltage sensor
activePower	Active power sensor

Sensor type	Description
apparentPower	Apparent power sensor
powerFactor	Power factor sensor
activeEnergy	Active energy sensor

*Displayed information:*

- Without the parameter "details," only the reading, state, threshold, deassertion hysteresis and assertion timeout settings of the specified inlet pole sensor are displayed.
- With the parameter "details," more sensor information is displayed, including resolution and range.
- If the requested sensor type is not supported, the "Sensor is not available" message is displayed.

---

### Overcurrent Protector Sensor Threshold Information

This command is only available for models with overcurrent protectors for protecting outlets.

This command syntax shows the specified overcurrent protector sensor's threshold-related information.

```
# show sensor ocp <n> <sensor type>
```

To show detailed information, add the parameter "details" to the end of the command.

```
# show sensor ocp <n> <sensor type> details
```

*Variables:*

- <n> is the number of the overcurrent protector whose sensors you want to query.
- <sensor type> is one of the following sensor types:

Sensor type	Description
current	Current sensor

*Displayed information:*

- Without the parameter "details," only the reading, state, threshold, deassertion hysteresis and assertion timeout settings of the specified overcurrent protector sensor are displayed.
- With the parameter "details," more sensor information is displayed, including resolution and range.

---

### Environmental Sensor Threshold Information

This command syntax shows the specified environmental sensor's threshold-related information.

```
# show sensor externalsensor <n>
```

To show detailed information, add the parameter "details" to the end of the command.

```
# show sensor externalsensor <n> details
```

```
External sensor 3 (Temperature):
```

```
Reading: 31.8 deg C
```

```
State: normal
```

```
Active Thresholds: Sensor specific thresholds
```

```
Default Thresholds for Temperature sensors:
```

```
Lower critical threshold: 10.0 deg C
```

```
Lower warning threshold: 15.0 deg C
```

```
Upper warning threshold: 30.0 deg C
```

```
Upper critical threshold: 35.0 deg C
```

```
Deassertion hysteresis: 1.0 deg C
```

```
Assertion timeout: 0 samples
```

```
Sensor Specific Thresholds:
```

```
Lower critical threshold: 8.0 deg C
```

```
Lower warning threshold: 13.0 deg C
```

```
Upper warning threshold: 28.0 deg C
```

```
Upper critical threshold: 33.0 deg C
```

```
Deassertion hysteresis: 1.0 deg C
```

```
Assertion timeout: 0 samples
```



*Variables:*

- <n> is the environmental sensor number. The environmental sensor number is the ID number assigned to the sensor, which can be found on the Peripheral Devices page of the PX web interface.

*Displayed information:*

- Without the parameter "details," only the reading, threshold, deassertion hysteresis and assertion timeout settings of the specified environmental sensor are displayed.
- With the parameter "details," more sensor information is displayed, including resolution and range.

---

*Note: For a discrete (on/off) sensor, the threshold-related and accuracy-related data is NOT available.*

---

**Environmental Sensor Default Thresholds**

This command syntax shows a certain sensor type's default thresholds, which are the initial thresholds applying to the specified type of sensor.

```
#          show defaultThresholds <sensor type>
```

To show detailed information, add the parameter "details" to the end of the command.

```
#          show defaultThresholds <sensor type> details
```

*Variables:*

- <sensor type> is one of the following numeric sensor types:

Sensor types	Description
absoluteHumidity	Absolute humidity sensors
relativeHumidity	Relative humidity sensors
temperature	Temperature sensors
airPressure	Air pressure sensors
airFlow	Air flow sensors
vibration	Vibration sensors
all	All of the above numeric sensors
	<i>Tip: You can also type the command without adding this option "all" to get the same data.</i>

*Displayed information:*

- Without the parameter "details," only the default upper and lower thresholds, deassertion hysteresis and assertion timeout settings of the specified sensor type are displayed.
- With the parameter "details," the threshold range is displayed in addition to default thresholds settings.

---

**Security Settings**

This command shows the security settings of the PX.

```
#          show security
```

To show detailed information, add the parameter "details" to the end of the command.

```
#          show security details
```

*Displayed information:*

- Without the parameter "details," the information including IP access control, role-based access control, password policy, and HTTPS encryption is displayed.
- With the parameter "details," more security information is displayed, such as user blocking time, user idle timeout and front panel permissions (if supported by your model).

---

### Existing User Profiles

This command shows the data of one or all existing user profiles.

```
# show user <user_name>
```

To show detailed information, add the parameter "details" to the end of the command.

```
# show user <user_name> details
```

#### Variables:

- <user\_name> is the name of the user whose profile you want to query. The variable can be one of the options: *all* or a user's name.

Option	Description
all	This option shows all existing user profiles. <i>Tip: You can also type the command without adding this option "all" to get the same data.</i>
a specific user's name	This option shows the profile of the specified user only.

#### Displayed information:

- Without the parameter "details," only four pieces of user information are displayed: user name, user "Enabled" status, SNMP v3 access privilege, and role(s).
- With the parameter "details," more user information is displayed, such as the telephone number, e-mail address, preferred measurement units and so on.

---

### Existing Roles

This command shows the data of one or all existing roles.

```
# show roles <role_name>
```

*Variables:*

- <role\_name> is the name of the role whose permissions you want to query. The variable can be one of the following options:

Option	Description
all	This option shows all existing roles.  <i>Tip: You can also type the command without adding this option "all" to get the same data.</i>
a specific role's name	This option shows the data of the specified role only.

*Displayed information:*

- Role settings are displayed, including the role description and privileges.

---

### Load Shedding Settings

This section applies to outlet-switching capable models only.

This command shows the load shedding settings.

```
# show loadshedding
```

*Displayed information:*

- The load shedding state is displayed along with non-critical outlets.

*Note: The load shedding mode is associated with critical and non-critical outlets. To specify critical and non-critical outlets through CLI, see **Specifying Non-Critical Outlets** (on page 360).*

---

---

**Serial Port Settings**

This command shows the baud rate setting of the serial port labeled CONSOLE / MODEM on the PX device.

```
# show serial
```

---

**EnergyWise Settings**

This command shows the PX device's current configuration for Cisco® EnergyWise.

```
# show energywise
```

---

**USB-Cascading Configuration Information**

This command shows the USB-cascading configuration, such as the cascading mode and device position.

```
# show cascading
```

To show detailed information, add the parameter "details" to the end of the command.

```
# show cascading details
```

---

**Asset Sensor Settings**

This command shows the asset sensor settings, such as the total number of rack units (tag ports), asset sensor state, numbering mode, orientation, available tags and LED color settings.

```
# show assetStrip <n>
```

*Variables:*

- <n> is one of the options: *all*, or a number.

Option	Description
all	Displays all asset sensor information.
	<i>Tip: You can also type the command without adding this option "all" to get the same data.</i>

Option	Description
A specific asset sensor number	Displays the settings of the asset sensor connected to the specified FEATURE port number.  For the PX device with only one FEATURE port, the valid number is always 1.

### Rack Unit Settings of an Asset Sensor

For the Raritan asset sensor, a rack unit refers to a tag port. This command shows the settings of a specific rack unit or all rack units on an asset sensor, such as a rack unit's LED color and LED mode.

```
# show rackUnit <n> <rack_unit>
```

#### Variables:

- <n> is the number of the FEATURE port where the selected asset sensor is physically connected. For the PX device with only one FEATURE port, the number is always 1.
- <rack\_unit> is one of the options: *all* or a specific rack unit's index number.

Option	Description
all	Displays the settings of all rack units on the specified asset sensor.  <i>Tip: You can also type the command without adding this option "all" to get the same data.</i>
A specific number	Displays the settings of the specified rack unit on the specified asset sensor.  Use the index number to specify the rack unit. The index number of each rack unit is available on the Asset Strip page of the web interface.

---

### Blade Extension Strip Settings

This command shows the information of a blade extension strip, including the total number of tag ports, and if available, the ID (barcode) number of any connected tag.

```
#          show bladeSlot <n> <rack_unit> <blade_slot>
```

#### Variables:

- <n> is the number of the FEATURE port where the selected asset sensor is physically connected. For the PX device with only one FEATURE port, the number is always 1.
- <rack\_unit> is the index number of the desired rack unit (tag port) on the selected asset sensor. The index number of each rack unit is available on the Asset Strip page of the web interface.
- <blade\_slot> is one of the options: *all* or a specific number of a tag port on the blade extension strip.

Option	Description
all	<p>Displays the information of all tag ports on the specified blade extension strip connected to a particular rack unit.</p> <hr/> <p><i>Tip: You can also type the command without adding this option "all" to get the same data.</i></p>
A specific number	<p>Displays the information of the specified tag port on the blade extension strip connected to a particular rack unit.</p> <p>The number of each tag port on the blade extension strip is available on the Asset Strip page.</p>

---

## Event Log

The command used to show the event log begins with `show eventlog`. You can add either the *limit* or *class* parameters or both to show specific events.

▶ **Show the last 30 entries:**

```
# show eventlog
```

▶ **Show a specific number of last entries in the event log:**

```
# show eventlog limit <n>
```

▶ **Show a specific type of events only:**

```
# show eventlog class <event_type>
```

▶ **Show a specific number of last entries associated with a specific type of events only:**

```
# show eventlog limit <n> class <event_type>
```

*Variables:*

- <n> is one of the options: *all* or a number.

Option	Description
all	Displays all entries in the event log.
An integer number	Displays the specified number of last entries in the event log. The number ranges between 1 to 10,000.

- <event\_type> is one of the following event types.

Event type	Description
all	All events.
device	Device-related events, such as system starting or firmware upgrade event.
userAdministration	User management events, such as a new user profile or a new role.
userActivity	User activities, such as login or logout.
pdu	Displays PDU-related events, such as entry or exit of the load shedding mode.



Event type	Description
sensor	Internal or external sensor events, such as state changes of any sensors.
serverMonitor	Server-monitoring records, such as a server being declared reachable or unreachable.
energywise	Cisco EnergyWise-related events, such as enabling the support of the EnergyWise function.
assetManagement	Raritan asset management events, such as asset tag connections or disconnections.
lhx	Schroff® LHX/SHX heat exchanger events.
modem	Modem-related events.
timerEvent	Scheduled action events.
webcam	Events for webcam management, if available.
cardReader	Events for card reader management, if available.

---

*Note: You can ignore the powerLogic event type in the CLI because the PX does not support it.*

---

### Wireless LAN Diagnostic Log

This command shows the diagnostic log for the wireless LAN connection.

```
# show wlanlog
```

### Server Reachability Information

This command shows all server reachability information with a list of monitored servers and status.

```
# show serverReachability
```

**Server Reachability Information for a Specific Server**

To show the server reachability information for a certain IT device only, use the following command.

```
# show serverReachability server <n>
```

To show detailed information, add the parameter "details" to the end of the command.

```
# show serverReachability server <n> details
```

*Variables:*

- <n> is a number representing the sequence of the IT device in the monitored server list.

You can find each IT device's sequence number using the CLI command of `show serverReachability` as illustrated below.

#	IP address	Enabled	Status
1	192.168.84.126	Yes	Waiting for reliable connection
2	www.raritan.com	Yes	Waiting for reliable connection

*Displayed information:*

- Without the parameter "details," only the specified device's IP address, monitoring enabled/disabled state and current status are displayed.
- With the parameter "details," more settings for the specified device are displayed, such as number of pings and wait time prior to the next ping.

---

### Command History

This command syntax shows the command history for current connection session.

```
#          show history
```

*Displayed information:*

- A list of commands that were previously entered in the current session is displayed.

---

### History Buffer Length

This command syntax shows the length of the history buffer for storing history commands.

```
#          show history bufferlength
```

*Displayed information:*

- The current history buffer length is displayed.

---

### Reliability Data

This command shows the reliability data.

```
#          show reliability data
```

---

### Reliability Error Log

This command shows the reliability error log.

```
#          show reliability errorlog <n>
```

*Variables:*

- <n> is one of the options: 0 (zero) or any other integer number.

Option	Description
0	Displays all entries in the reliability error log. <i>Tip: You can also type the command without adding this option "0" to get all data.</i>
A specific integer number	Displays the specified number of last entries in the reliability error log.

---

## Examples

This section provides examples of the show command.

### Example 1 - Basic Security Information

The diagram shows the output of the *show security* command.

```
# show security
IPv4 access control: Disabled
IPv6 access control: Disabled
Role based access control for IPv4: Disabled
Role based access control for IPv6: Disabled
Password aging: Disabled
Prevent concurrent user login: No
Strong passwords: Disabled
Enforce HTTPS for web access: Yes
Restricted Service Agreement: disabled
```

**Example 2 - In-Depth Security Information**

More information is displayed when typing the *show security details* command.

```
# show security details
IPv4 access control: Disabled

IPv6 access control: Disabled

Role based access control for IPv4: Disabled
Role based access control for IPv6: Disabled

Password aging: Disabled

Prevent concurrent user login: No
Maximum number of failed logins: 3
User block time: 10 minutes

User idle timeout: 1440 minutes

Strong passwords: Disabled

Enforce HTTPS for web access: Yes

Restricted Service Agreement: disabled
Restricted Service Agreement Banner Content:
Unauthorized access prohibited; all access and activities not explicitly authori
zed by management are unauthorized. All activities are monitored and logged. The
re is no privacy on this system. Unauthorized access and activities or any crimi
nal activity will be reported to appropriate authorities.
```

**Example 3 - Basic PDU Information**

The diagram shows the output of the *show pdu* command.

```
# show pdu
PDU 'my PX'
Model: PX3-XXXX
Firmware Version: 2.X.0.5-40956
```

#### Example 4 - In-Depth PDU Information

More information is displayed when typing the *show pdu details* command. Displayed information varies depending on the model you purchased.

```
# show pdu details
PDU 'my PX'
Model:          PX3-XXXX
Firmware Version: 2.X.0.5-40956
Serial Number:  QGZ3792136
Board Revision:  0x01

Voltage rating:  200-240V
Current rating:  16A
Frequency rating: 50/60Hz
Power rating:    3.2-3.8kVA

Sensor data retrieval: Enabled
Measurements per log entry: 60

External sensor Z coordinate format: Rack units
Device altitude:          0 m
```

---

## Clearing Information

You can use the clear commands to remove unnecessary data from the PX.

After typing a "clear" command, press Enter to execute it.

---

*Note: Depending on your login name, the # prompt may be replaced by the > prompt. See **Different CLI Modes and Prompts** (on page 321).*

---

### Clearing Event Log

This command removes all data from the event log.

```
#          clear eventlog

-- OR --

#          clear eventlog /y
```

If you entered the command without "/y," a message appears, prompting you to confirm the operation. Type *y* to clear the event log or *n* to abort the operation.

If you type *y*, a message "Event log was cleared successfully" is displayed after all data in the event log is deleted.

---

## Configuring the PX Device and Network

To configure the PX device or network settings through the CLI, it is highly recommended to log in as the administrator so that you have full permissions.

To configure any settings, enter the configuration mode. Configuration commands are case sensitive so ensure you capitalize them correctly.

---

### Entering Configuration Mode

Configuration commands function in configuration mode only.

► **To enter configuration mode:**

1. Ensure you have entered administrator mode and the # prompt is displayed.

---

*Note: If you enter configuration mode from user mode, you may have limited permissions to make configuration changes. See **Different CLI Modes and Prompts** (on page 321).*

---

2. Type `config` and press Enter.
3. The `config:#` prompt appears, indicating that you have entered configuration mode.

```
config:# _
```

4. Now you can type any configuration command and press Enter to change the settings.

---

**Important: To apply new configuration settings, you must issue the "apply" command before closing the terminal emulation program. Closing the program does not save any configuration changes. See *Quitting Configuration Mode* (on page 355).**

---

---

### Quitting Configuration Mode

Both of "apply" and "cancel" commands let you quit the configuration mode. The difference is that "apply" saves all changes you made in the configuration mode while "cancel" aborts all changes.

► **To quit the configuration mode, use either command:**

```
config:# apply
```

```
-- OR --
```

```
config:#    cancel
```

The # or > prompt appears after pressing Enter, indicating that you have entered the administrator or user mode. See ***Different CLI Modes and Prompts*** (on page 321).

---

## PDU Configuration Commands

A PDU configuration command begins with *pdu*. You can use the PDU configuration commands to change the settings that apply to the whole PX device.

### Changing the PDU Name

This command changes the PX device's name.

```
config:#    pdu name "<name>"
```

#### Variables:

- <name> is a string comprising up to 32 ASCII printable characters. The <name> variable must be enclosed in quotes when it contains spaces.

### Setting the Outlet Power-On Sequence

This section applies to outlet-switching capable models only.

This command sets the outlet power-on sequence when the PDU powers up.

```
config:#    pdu outletSequence <option>
```

#### Variables:

- <option> is one of the options: *default*, or a comma-separated list of outlet numbers.

Option	Description
default	All outlets are switched ON in the ASCENDING order (from outlet 1 to the final outlet) when the PX device powers up.



Option	Description
A comma-separated list of outlet numbers	All outlets are switched ON in the order you specify using the comma-separated list. The list must include all outlets on the PDU.

### Setting the Outlet Power-On Sequence Delay

This section applies to outlet-switching capable models only.

This command sets the delays (in seconds) for outlets when turning on all outlets in sequence.

```
config:# pdu outletSequenceDelay <outlet1>:<delay1>;<outlet2>:<delay2>;
<outlet3>:<delay3>;...
```

Separate outlet numbers and their delay settings with a colon. Outlets followed by delays are separated with a semicolon.

#### Variables:

- <outlet1>, <outlet2>, <outlet3> and the like are individual outlet numbers or a range of outlets using a dash. For example, 3-8 represents outlets 3 to 8.
- <delay1>, <delay2>, <delay3> and the like are the delay time in seconds.

### Setting the PDU-Defined Default Outlet State

This section applies to outlet-switching capable models only.

This command determines the initial power condition of all outlets after powering up the PDU.

```
config:# pdu outletStateOnDeviceStartup <option>
```

Variables:

- <option> is one of the options: *off*, *on* or *lastKnownState*.

Option	Description
off	Switches OFF all outlets when the PX device powers up.
on	Switches ON all outlets when the PX device powers up.
lastKnownState	Restores all outlets to the previous status before powering down the PX device when the PDU powers up again.

### Setting the PDU-Defined Cycling Power-Off Period

This section applies to outlet-switching capable models only.

This command sets the power-off period of the power cycling operation for all outlets.

```
config:# pdu cyclingPowerOffPeriod <timing>
```

Variables:

- <timing> is the time of the cycling power-off period in seconds, which is an integer between 0 and 3600, or *pduDefined* for following the PDU-defined timing.

### Setting the Inrush Guard Delay Time

This section applies to outlet-switching capable models only.

This command sets the inrush guard delay.

```
config:# pdu inrushGuardDelay <timing>
```

*Variables:*

- <timing> is a delay time between 100 and 100000 milliseconds.

### Setting the Outlet Initialization Delay

This section applies to outlet-switching capable models only.

This command determines the outlet initialization delay timing on device startup. See **Setting the Initialization Delay** (on page 180) for information on outlet initialization delay.

```
config:# pdu outletInitializationDelayOnDeviceStartup <timing>
```

*Variables:*

- <timing> is a delay time between 1 and 3600 seconds.

### Specifying Non-Critical Outlets

This section applies to outlet-switching capable models only.

This command determines critical and non-critical outlets. It is associated with the load shedding mode. See **Setting Non-Critical Outlets and Load Shedding Mode** (on page 183).

```
config:# pdu nonCriticalOutlets <outlets1>:false;<outlets2>:true
```

Separate outlet numbers and their settings with a colon. Separate each "false" and "true" setting with a semicolon.

#### Variables:

- <outlets1> is one or multiple outlet numbers to be set as critical outlets. Use commas to separate outlet numbers.  
Use a dash for a range of consecutive outlets. For example, 3-8 represents outlets 3 to 8.
- <outlets2> is one or multiple outlet numbers to be set as NON-critical outlets. Use commas to separate outlet numbers.  
Use a dash for a range of consecutive outlets. For example, 3-8 represents outlets 3 to 8.

### Enabling or Disabling Data Logging

This command enables or disables the data logging feature.

```
config:# pdu dataRetrieval <option>
```

#### Variables:

- <option> is one of the options: *enable* or *disable*.

Option	Description
enable	Enables the data logging feature.
disable	Disables the data logging feature.

For more information, see **Setting Data Logging** (on page 125).

### Setting Data Logging Measurements Per Entry

This command defines the number of measurements accumulated per log entry.

```
config:# pdu measurementsPerLogEntry <number>
```

#### Variables:

- <number> is an integer between 1 and 600. The default is 60 samples per log entry.

For more information, see **Setting Data Logging** (on page 125).

### Specifying the Device Altitude

This command specifies your PX device's altitude above sea level (in meters). You must specify the PX device's altitude above sea level if a Raritan differential air pressure sensor is attached. This is because the device's altitude is associated with the altitude correction factor. See **Altitude Correction Factors** (on page 588).

```
config:# pdu deviceAltitude <altitude>
```

#### Variables:

- <altitude> is an integer between 1 and 3000 meters.

**Setting the Z Coordinate Format for Environmental Sensors**

This command enables or disables the use of rack units for specifying the height (Z coordinate) of environmental sensors.

```
config:# pdu externalSensorsZCoordinateFormat <option>
```

*Variables:*

- <option> is one of the options: *rackUnits* or *freeForm*.

Option	Description
rackUnits	The height of the Z coordinate is measured in standard rack units. When this is selected, you can type a numeric value in the rack unit to describe the Z coordinate of any environmental sensors or actuators.
freeForm	Any alphanumeric string can be used for specifying the Z coordinate.

---

*Note:* After determining the format for the Z coordinate, you can set a value for it. See **Setting the Z Coordinate** (on page 435).

---

**Enabling or Disabling Peripheral Device Auto Management**

This command enables or disables the Peripheral Device Auto Management feature.

```
config:# pdu peripheralDeviceAutoManagement <option>
```

*Variables:*

- <option> is one of the options: *enable* or *disable*.

Option	Description
enable	Enables the automatic management feature for environmental sensors.
disable	Disables the automatic management feature for environmental sensors.

For more information, see **Disabling the Automatic Management Function** (on page 270).

### Changing the LED Display Orientation

This command determines the orientation of the alphanumeric values shown on the LED display of a *Zero U* PDU.

```
config:# pdu displayOrientation <orientation>
```

*Variables:*

- <orientation> is one of the options: *automatic*, *flipped* or *normal*.

Option	Description
automatic	The direction of the values shown on the LED display is determined depending on the PDU's orientation detected by the built-in tilt sensor.
flipped	The values shown on the LED display always stay in the opposite direction regardless of the PDU's orientation.
normal	The values shown on the LED display always stay in the normal direction regardless of the PDU's orientation.

Note that this command is NOT applicable to a non-Zero U PDU.

### Examples

This section illustrates several PDU configuration examples.

#### **Example 1 - PDU Naming**

The following command assigns the name "my px12" to the PDU.

```
config:# pdu name "my px12"
```

#### **Example 2 - Outlet Sequence**

The following command causes a 10-outlet PDU to first power on the 8th to 6th outlets and then the rest of outlets in the ascending order after the PDU powers up.

```
config:# pdu outletSequence 8-6,1-5,9,10
```

**Example 3 - Outlet Sequence Delay**

The following command determines that the outlet 1's delay is 2.5 seconds, outlet 2's delay is 3 seconds, and the delay for outlets 3 through 5 is 10 seconds.

```
config:# pdu outletSequenceDelay 1:2.5;2:3;3-5:10
```

**Example 4 - Non-Critical Outlets**

The following command sets outlets 1, 2, 3, 7, and 9 to be critical outlets, and 4, 5, 6, 8, 10, 11 and 12 to be non-critical outlets on a 12-outlet PX.

```
config:# pdu nonCriticalOutlets 1-3,7,9:false;4-6,8,10-12:true
```

**Network Configuration Commands**

A network configuration command begins with *network*. A number of network settings can be changed through the CLI, such as the IP address, transmission speed, duplex mode, and so on.

**Setting the Networking Mode**

If your PX device is implemented with both wired and wireless networking mechanisms, you must determine which mechanism is enabled for network connectivity before further configuring networking parameters.

This command enables the wired or wireless networking mode.

```
config:# network mode <mode>
```

Variables:

- <mode> is one of the modes: *wired* or *wireless*.

Mode	Description
wired	Enables the wired networking mode.
wireless	Enables the wireless networking mode.

*Note: If you enable the wireless networking mode, and the PX does not detect any wireless USB LAN adapter or the connected wireless USB LAN adapter is not supported, the message "Supported Wireless device not found" is displayed.*



### Configuring IP Protocol Settings

By default, only the IPv4 protocol is enabled. You can enable both the IPv4 and IPv6 protocols, or only the IPv6 protocol for your PX device.

An IP protocol configuration command begins with *network ip*.

#### Enabling IPv4 or IPv6

This command determines which IP protocol is enabled on the PX.

```
config:# network ip proto <protocol>
```

Variables:

- <protocol> is one of the options: *v4Only*, *v6Only* or *both*.

Mode	Description
v4Only	Enables IPv4 only on all interfaces. This is the default.
v6Only	Enables IPv6 only on all interfaces.
both	Enables both IPv4 and IPv6 on all interfaces.

#### Selecting IPv4 or IPv6 Addresses

This command determines which IP address is used when the DNS server returns both of IPv4 and IPv6 addresses. You need to configure this setting only after both IPv4 and IPv6 protocols are enabled on the PX.

```
config:# network ip dnsResolverPreference <resolver>
```

Variables:

- <resolver> is one of the options: *preferV4* or *preferV6*.

Option	Description
preferV4	Use the IPv4 addresses returned by the DNS server.
preferV6	Use the IPv6 addresses returned by the DNS server.

### Setting Wireless Parameters

You must configure wireless parameters, including Service Set Identifier (SSID), authentication method, Pre-Shared Key (PSK), and Basic Service Set Identifier (BSSID) after the wireless networking mode is enabled.

A wireless configuration command begins with *network wireless*.

---

*Note: If current networking mode is not wireless, the SSID, PSK and BSSID values are not applied until the networking mode is changed to "wireless." In addition, a message appears, indicating that the active network interface is not wireless.*

---

#### Setting the SSID

This command specifies the SSID string.

```
config:# network wireless SSID <ssid>
```

*Variables:*

- <ssid> is the name of the wireless access point, which consists of:
  - Up to 32 ASCII characters
  - No spaces
  - ASCII codes 0x20 ~ 0x7E

#### Setting the Authentication Method

This command sets the wireless authentication method to either PSK or Extensible Authentication Protocol (EAP).

```
config:# network wireless authMethod <method>
```

*Variables:*

- <method> is one of the authentication methods: *PSK* or *EAP*.

Method	Description
PSK	The wireless authentication method is set to PSK.
EAP	The wireless authentication method is set to EAP.

### **Setting the PSK**

If the Pre-Shared Key (PSK) authentication method is selected, you must assign a PSK passphrase by using this command.

```
config:# network wireless PSK <psk>
```

#### *Variables:*

- <psk> is a string or passphrase that consists of:
  - 8 to 63 characters
  - No spaces
  - ASCII codes 0x20 ~ 0x7E

### Setting EAP Parameters

When the wireless authentication method is set to EAP, you must configure EAP authentication parameters, including outer authentication, inner authentication, EAP identity, password, and CA certificate.

▶ **Determine the outer authentication protocol:**

```
config:# network wireless eapOuterAuthentication <outer_auth>
```

▶ **Determine the inner authentication protocol:**

```
config:# network wireless eapInnerAuthentication <inner_auth>
```

▶ **Set the EAP identity:**

```
config:# network wireless eapIdentity <identity>
```

▶ **Set the EAP password:**

```
config:# network wireless eapPassword
```

After performing the above command, the PX prompts you to enter the password. Then type the password and press Enter.

▶ **Provide a CA TLS certificate:**

```
config:# network wireless eapCACertificate
```

After performing the above command, the system prompts you to enter the CA certificate's contents. For details, see **EAP CA Certificate Example** (on page 370).

▶ **Enable or disable verification of the TLS certificate chain:**

```
config:# network wireless enableCertVerification <option1>
```

▶ **Allow expired and not yet valid TLS certificates:**

```
config:# network wireless allowOffTimeRangeCerts <option2>
```

▶ **Allow wireless network connection with incorrect system time:**

```
config:# network wireless allowConnectionWithIncorrectClock <option3>
```

*Variables:*

- The value of <outer\_auth> is *PEAP* because PX only supports Protected Extensible Authentication Protocol (PEAP) as the outer authentication.
- The value of <inner\_auth> is *MSCHAPv2* because PX only supports Microsoft's Challenge Authentication Protocol Version 2 (MSCHAPv2) as the inner authentication.
- <identity> is your user name for the EAP authentication.
- <option1> is one of the options: *true* or *false*.

Option	Description
true	Enables the verification of the TLS certificate chain.
false	Disables the verification of the TLS certificate chain.

- <option2> is one of the options: *true* or *false*.

Option	Description
true	Always make the wireless network connection successful even though the TLS certificate chain contains any certificate which is outdated or not valid yet.
false	The wireless network connection is NOT successfully established when the TLS certificate chain contains any certificate which is outdated or not valid yet.

- <option3> is one of the options: *true* or *false*.

Option	Description
true	Make the wireless network connection successful when the PX system time is earlier than the firmware build before synchronizing with the NTP server, causing the TLS certificate to become invalid.
false	The wireless network connection is NOT successfully established when the PX finds that the TLS certificate is not valid due to incorrect system time.

**EAP CA Certificate Example**

This section provides a CA certificate example only. Your CA certificate contents should be different from the contents displayed in this example.

► **To provide a CA certificate:**

1. Make sure you have entered the configuration mode. See **Entering Configuration Mode** (on page 355).

2. Type the following command and press Enter.

```
config:# network wireless eapCACertificate
```

3. The system prompts you to enter the contents of the CA certificate.
4. Open a CA certificate using a text editor. You should see certificate contents similar to the following.

```
--- BEGIN CERTIFICATE ---
MIICjTCCAfigAwIBAgIEMaYgRzALBgkqhkiG9w0BAQQwRTELMAkGA1UEBhMCVVMx
NjA0BgNVBAoTLU5hdGlvbmFsIEFlcm9uYXV0aWNzIGFuZCBTcGFjZSBBZG1pbmlz
dHJhdGlvbjAmFxE5NjA1MjgxMzQ5MDUrMDgwMBcROTgwNTI4MTM0OTA1KzA4MDAw
ZzELMAkGA1UEBhMCVVMxNjA0BgNVBAoTLU5hdGlvbmFsIEFlcm9uYXV0aWNzIGFu
ZCBTcGFjZSBBZG1pbmlzdHJhdGlvbjEgMAkGA1UEBRMCMTYwEwYDQDEwxtZGV2
ZSBTY2hvY2gwWDALBgkqhkiG9w0BAQEESQAwwRgJBALrAwyYdgxmzNP/ts0Uyf6Bp
miJYktU/w4NG67ULaN4B5CnEz7k57s9o3YY3LecETgQ5iQHmkw/YDTL2ftgVfw0C
AQOjgaswgagwZAYDVR0ZAQH/BFowWDBWMFQxCzAJBgNVBAYTAiVTMTYwNAYDQVQK
Ey1OYXRpb25hbCBBZjJvbmF1dGljcyBhbmQgU3BhY2UgQWRtaW5pc3RyYXRpb24x
DTALBgNVBAMTBENSTDEwFwYDVR0BAQH/BA0wC4AJODMyOTcwODEwMBgGA1UdAgQR
MA8ECTgzMjk3MDgyM4ACBSAwDQYDVR0KBAYwBAMCBkAwCwYJKoZIhvcNAQEEA4GB
AH2y1VCEw/A4zaXzSYZJTTUi3uawbbFiS2yxHvgf28+8Js0OHXk1H1w2d6qOHH21
X82tZXd/0JtG0g1T9usFFBDvYK8O0ebgz/P5ELJnBL2+atObEuJy1ZZ0pBDWINR3
WkDNLCGItkCKp0F5EWIrVDwh54NNeVkcQRZita+z4IBO
--- END CERTIFICATE ---
```

5. Select and copy the contents as illustrated below, excluding the starting line containing "BEGIN CERTIFICATE" and the ending line containing "END CERTIFICATE."

```
MIICjTCCAf igAwIBAgIEMaYgRzALBgkqhkiG9w0BAQQwRTELMak
GA1UEBhMCMVVMxNjA0BgNVBAoTLU5hdGlvbmFsIEFlcm9uYXV0aW
NzIGFuZCBTcGFjZSBBZG1pbmlzdHJhdGlvbjAmFxE5NjA1MjgXM
zQ5MDUrdGwMBcROUgNTI4MTM0OTA1KzA4MDAwZzELMakGA1UE
BhMCMVVMxNjA0BgNVBAoTLU5hdGlvbmFsIEFlcm9uYXV0aW
NzIGFuZCBTcGFjZSBBZG1pbmlzdHJhdGlvbjEgMAkGA1UEBRMCMTYwEw
YDVQQDEwxTdGV2ZSBTY2hvY2gwWDALBgkqhkiG9w0BAQEDSQAwr
gJBALrAwYydgxmzNP / ts0Uyf6BpmiJYktU/w4NG67ULa4B5CnE
z7k57s9o3YY3LecETgQ5iQHmkwlyDTL2ftgVfw0CAQOjgaswgag
wZAYDVR0ZAQH/BFowWDBWMFQxCzAJBgNVBAYTAlVTMTYwNAZDVQ
QKEy1OYXRpb25hbCBBBZxJvbmF1dG1jcyBhbmQgU3BhY2UgQWRta
W5pc3RyYXRpb24xDALBgNVBAMTBENSTDEwFwYDVR0BAQH/BA0w
C4AJODMyOTcwODEwMBGGA1UdAgQRMA8ECTgzMjk3MDgyM4ACBSA
wDQYDVR0KBAYwBAMCBkAwCwYJKoZIhvcNAQEEA4GBAH2y1VCEw/
A4zaXzSYZJTTUi3uawbbFis2yxHvgf28+8Js0OHXk1H1w2d6qOH
H21X82tZXd/0JtG0g1T9usFFBDvYK800ebgz/P5ELJnBL2+atOb
EuJy1ZZ0pBDWINR3WkDNLCGiTkCKp0F5EWIrVDwh54NNEvkCQRZ
ita+z4IBO
```

6. Paste the contents in the terminal.
7. Press Enter.
8. Verify whether the system shows the following command prompt, indicating the provided CA certificate is valid.

```
config:#
```

### Setting the BSSID

This command specifies the BSSID.

```
config:# network wireless BSSID <bssid>
```

#### Variables:

- <bssid> is either the MAC address of the wireless access point or *none* for automatic selection.

### Configuring IPv4 Parameters

An IPv4 configuration command begins with *network ipv4*.

Configuration commands are case sensitive so ensure you capitalize them correctly.

**Setting the IPv4 Configuration Mode**

This command determines the IP configuration mode.

```
config:# network ipv4 ipConfigurationMode <mode>
```

Variables:

- <mode> is one of the modes: *dhcp* or *static*.

Mode	Description
dhcp	The IPv4 configuration mode is set to DHCP.
static	The IPv4 configuration mode is set to static IP address.

**Setting the IPv4 Preferred Host Name**

After selecting DHCP as the IPv4 configuration mode, you can specify the preferred host name, which is optional. The following is the command:

```
config:# network ipv4 preferredHostName <name>
```

Variables:

- <name> is a host name which:
  - Consists of alphanumeric characters and/or hyphens
  - Cannot begin or end with a hyphen
  - Cannot contain more than 63 characters
  - Cannot contain punctuation marks, spaces, and other symbols

**Setting the IPv4 Address**

After selecting the static IP configuration mode, you can use this command to assign a permanent IP address to the PX device.

```
config:# network ipv4 ipAddress <ip address>
```

Variables:

- <ip address> is the IP address being assigned to your PX device. The value ranges from 0.0.0.0 to 255.255.255.255.



**Setting the IPv4 Subnet Mask**

After selecting the static IP configuration mode, you can use this command to define the subnet mask.

```
config:# network ipv4 subnetMask <netmask>
```

*Variables:*

- <netmask> is the subnet mask address. The value ranges from 0.0.0.0 to 255.255.255.255.

**Setting the IPv4 Gateway**

After selecting the static IP configuration mode, you can use this command to specify the gateway.

```
config:# network ipv4 gateway <ip address>
```

*Variables:*

- <ip address> is the IP address of the gateway. The value ranges from 0.0.0.0 to 255.255.255.255.

**Setting the IPv4 Primary DNS Server**

After selecting the static IP configuration mode, use this command to specify the primary DNS server. If you have selected the DHCP configuration mode, you still can manually specify DNS servers with this command and then override the DHCP-assigned DNS servers. See **Overriding the IPv4 DHCP-Assigned DNS Server** (on page 374).

```
config:# network ipv4 primaryDNSServer <ip address>
```

*Variables:*

- <ip address> is the IP address of the primary DNS server. The value ranges from 0.0.0.0 to 255.255.255.255.

**Setting the IPv4 Secondary DNS Server**

After selecting the static IP configuration mode, you can use this command to specify the secondary DNS server. If you have selected the DHCP configuration mode, you still can manually specify DNS servers with this command and then override the DHCP-assigned DNS servers. See **Overriding the IPv4 DHCP-Assigned DNS Server** (on page 374).

```
config:# network ipv4 secondaryDNSServer <ip address>
```

*Variables:*

- <ip address> is the IP address of the secondary DNS server. The value ranges from 0.0.0.0 to 255.255.255.255.

---

*Note: The PX supports a maximum of 3 DNS servers. If two IPv4 DNS servers and two IPv6 DNS servers are available, the PX only uses the primary IPv4 and IPv6 DNS servers.*

---

**Overriding the IPv4 DHCP-Assigned DNS Server**

After specifying the primary/secondary DNS server, you can use this command to override the DHCP-assigned DNS server with the one you specified.

```
config:# network ipv4 overrideDNS <option>
```

*Variables:*

- <option> is one of the options: *enable* or *disable*.

Option	Description
enable	This option overrides the DHCP-assigned DNS server with the primary/secondary DNS server you assign.
disable	This option resumes using the DHCP-assigned DNS server.

**Setting IPv4 Static Routes**

If the IPv4 network mode is set to static IP and your local network contains two subnets, you can configure static routes to enable or disable communications between the PX and devices in the other subnet.

These commands are prefixed with *network ipv4 staticRoutes*.

▶ **Add a static route:**

```
config:# network ipv4 staticRoutes add <dest-1> <hop>
```

▶ **Delete an existing static route:**

```
config:# network ipv4 staticRoutes delete <route_ID>
```

▶ **Modify an existing static route:**

```
config:# network ipv4 staticRoutes modify <route_ID> <dest-2> <hop>
```

*Variables:*

- <dest-1> is a combination of the IP address and subnet mask of the other subnet. The format is *IP address/subnet mask*.
- <hop> is the IP address of the next hop router.
- <route\_ID> is the ID number of the route setting which you want to delete or modify.
- <dest-2> is a modified route setting that will replace the original route setting. Its format is *IP address/subnet mask*. You can modify either the IP address or the subnet mask or both.

**Configuring IPv6 Parameters**

An IPv6 configuration command begins with *network ipv6*.

Configuration commands are case sensitive so ensure you capitalize them correctly.

### Setting the IPv6 Configuration Mode

This command determines the IP configuration mode.

```
config:# network ipv6 ipConfigurationMode <mode>
```

Variables:

- <mode> is one of the modes: *automatic* or *static*.

Mode	Description
automatic	The IPv6 configuration mode is set to automatic.
static	The IPv6 configuration mode is set to static IP address.

### Setting the IPv6 Preferred Host Name

After selecting DHCP as the IPv6 configuration mode, you can specify the preferred host name, which is optional. The following is the command:

```
config:# network ipv6 preferredHostName <name>
```

Variables:

- <name> is a host name which:
  - Consists of alphanumeric characters and/or hyphens
  - Cannot begin or end with a hyphen
  - Cannot contain more than 63 characters
  - Cannot contain punctuation marks, spaces, and other symbols

**Setting the IPv6 Address**

After selecting the static IP configuration mode, you can use this command to assign a permanent IP address to the PX device.

```
config:# network ipv6 ipAddress <ip address>
```

*Variables:*

- <ip address> is the IP address being assigned to your PX device. This value uses the IPv6 address format. Note that you must add /xx, which indicates a prefix length of bits such as /64, to the end of this IPv6 address.

**Setting the IPv6 Gateway**

After selecting the static IP configuration mode, you can use this command to specify the gateway.

```
config:# network ipv6 gateway <ip address>
```

*Variables:*

- <ip address> is the IP address of the gateway. This value uses the IPv6 address format.

**Setting the IPv6 Primary DNS Server**

After selecting the static IP configuration mode, use this command to specify the primary DNS server. If you have selected the automatic configuration mode, you still can manually specify DNS servers with this command and then override the DHCP-assigned DNS servers. See **Overriding the IPv6 DHCP-Assigned DNS Server** (on page 378).

```
config:# network ipv6 primaryDNSServer <ip address>
```

*Variables:*

- <ip address> is the IP address of the primary DNS server. This value uses the IPv6 address format.

**Setting the IPv6 Secondary DNS Server**

After selecting the static IP configuration mode, you can use this command to specify the secondary DNS server. If you have selected the automatic configuration mode, you still can manually specify DNS servers with this command and then override the DHCP-assigned DNS servers. See **Overriding the IPv6 DHCP-Assigned DNS Server** (on page 378).

```
config:# network ipv6 secondaryDNSServer <ip address>
```

*Variables:*

- <ip address> is the IP address of the secondary DNS server. This value uses the IPv6 address format.

---

*Note: The PX supports a maximum of 3 DNS servers. If two IPv4 DNS servers and two IPv6 DNS servers are available, the PX only uses the primary IPv4 and IPv6 DNS servers.*

---

**Overriding the IPv6 DHCP-Assigned DNS Server**

After specifying the primary/secondary DNS server, you can use this command to override the DHCP-assigned DNS server with the one you specified.

```
config:# network ipv6 overrideDNS <option>
```

*Variables:*

- <option> is one of the options: *enable* or *disable*.

Option	Description
enable	This option overrides the DHCP-assigned DNS server with the primary/secondary DNS server you assign.
disable	This option resumes using the DHCP-assigned DNS server.

**Setting IPv6 Static Routes**

If the IPv6 network mode is set to static IP and your local network contains two subnets, you can configure static routes to enable or disable communications between the PX and devices in the other subnet.

These commands are prefixed with *network ipv6 staticRoutes*.

▶ **Add a static route:**

```
config:# network ipv6 staticRoutes add <dest-1> <hop>
```

▶ **Delete a static route**

```
config:# network ipv6 staticRoutes delete <route_ID>
```

▶ **Modify an existing static route:**

```
config:# network ipv6 staticRoutes modify <route_ID> <dest-2> <hop>
```

*Variables:*

- <dest-1> is the IP address and prefix length of the subnet where the PX belongs. The format is *IP address/prefix length*.
- <hop> is the IP address of the next hop router.
- <route\_ID> is the ID number of the route setting which you want to delete or modify.
- <dest-2> is a modified route setting that will replace the original route setting. Its format is *IP address/prefix length*. You can modify either the IP address or the prefix length or both.

**Setting LAN Interface Parameters**

A LAN interface configuration command begins with *network interface*.

**Changing the LAN Interface Speed**

This command determines the LAN interface speed.

```
config:# network interface LANInterfaceSpeed <option>
```

Variables:

- <option> is one of the options: *auto*, *10Mbps*, and *100Mbps*.

Option	Description
auto	System determines the optimum LAN speed through auto-negotiation.
10Mbps	The LAN speed is always 10 Mbps.
100Mbps	The LAN speed is always 100 Mbps.

**Changing the LAN Duplex Mode**

This command determines the LAN interface duplex mode.

```
config:# network interface LANInterfaceDuplexMode <mode>
```

Variables:

- <mode> is one of the modes: *auto*, *half* or *full*.

Option	Description
auto	The PX selects the optimum transmission mode through auto-negotiation.
half	Half duplex: Data is transmitted in one direction (to or from the PX device) at a time.
full	Full duplex: Data is transmitted in both directions simultaneously.

**Setting Network Service Parameters**

A network service command begins with *network services*.



**Setting the HTTP Port**

The commands used to configure the HTTP port settings begin with *network services http*.

► **Change the HTTP port:**

```
config:# network services http port <n>
```

► **Enable or disable the HTTP port:**

```
config:# network services http enabled <option>
```

*Variables:*

- <n> is a TCP port number between 1 and 65535. The default HTTP port is 80.
- <option> is one of the options: *true* or *false*.

Option	Description
true	The HTTP port is enabled.
false	The HTTP port is disabled.

### Setting the HTTPS Port

The commands used to configure the HTTPS port settings begin with *network services https*.

► **Change the HTTPS port:**

```
config:# network services https port <n>
```

► **Enable or disable the HTTPS access:**

```
config:# network services https enabled <option>
```

Variables:

- <n> is a TCP port number between 1 and 65535. The default HTTPS port is 443.
- <option> is one of the options: *true* or *false*.

Option	Description
true	Forces any access to the PX via HTTP to be redirected to HTTPS.
false	No HTTP access is redirected to HTTPS.

### Changing the Telnet Configuration

You can enable or disable the Telnet service, or change its TCP port using the CLI commands.

A Telnet command begins with *network services telnet*.

### Enabling or Disabling Telnet

This command enables or disables the Telnet service.

```
config:# network services telnet enabled <option>
```

Variables:

- <option> is one of the options: *true* or *false*.

Option	Description
true	The Telnet service is enabled.

Option	Description
false	The Telnet service is disabled.

### Changing the Telnet Port

This command changes the Telnet port.

```
config:# network services telnet port <n>
```

*Variables:*

- <n> is a TCP port number between 1 and 65535. The default Telnet port is 23.

### Changing the SSH Configuration

You can enable or disable the SSH service, or change its TCP port using the CLI commands.

An SSH command begins with *network services ssh*.

### Enabling or Disabling SSH

This command enables or disables the SSH service.

```
config:# network services ssh enabled <option>
```

*Variables:*

- <option> is one of the options: *true* or *false*.

Option	Description
true	The SSH service is enabled.
false	The SSH service is disabled.

### Changing the SSH Port

This command changes the SSH port.

```
config:# network services ssh port <n>
```

*Variables:*

- <n> is a TCP port number between 1 and 65535. The default SSH port is 22.

### Setting the SNMP Configuration

You can enable or disable the SNMP v1/v2c or v3 agent, configure the read and write community strings, or set the MIB-II parameters, such as sysContact, using the CLI commands.

An SNMP command begins with *network services snmp*.

### Enabling or Disabling SNMP v1/v2c

This command enables or disables the SNMP v1/v2c protocol.

```
config:# network services snmp v1/v2c <option>
```

Variables:

- <option> is one of the options: *enable* or *disable*.

Option	Description
enable	The SNMP v1/v2c protocol is enabled.
disable	The SNMP v1/v2c protocol is disabled.

### Enabling or Disabling SNMP v3

This command enables or disables the SNMP v3 protocol.

```
config:# network services snmp v3 <option>
```

Variables:

- <option> is one of the options: *enable* or *disable*.

Option	Description
enable	The SNMP v3 protocol is enabled.
disable	The SNMP v3 protocol is disabled.

**Setting the SNMP Read Community**

This command sets the SNMP read-only community string.

```
config:# network services snmp readCommunity <string>
```

*Variables:*

- <string> is a string comprising 4 to 64 ASCII printable characters.
- The string CANNOT include spaces.

**Setting the SNMP Write Community**

This command sets the SNMP read/write community string.

```
config:# network services snmp writeCommunity <string>
```

*Variables:*

- <string> is a string comprising 4 to 64 ASCII printable characters.
- The string CANNOT include spaces.

**Setting the sysContact Value**

This command sets the SNMP MIB-II sysContact value.

```
config:# network services snmp sysContact <value>
```

*Variables:*

- <value> is a string comprising 0 to 255 alphanumeric characters.

**Setting the sysName Value**

This command sets the SNMP MIB-II sysName value.

```
config:# network services snmp sysName <value>
```

*Variables:*

- <value> is a string comprising 0 to 255 alphanumeric characters.

**Setting the sysLocation Value**

This command sets the SNMP MIB-II sysLocation value.

```
config:# network services snmp sysLocation <value>
```

*Variables:*

<value> is a string comprising 0 to 255 alphanumeric characters.

### Changing the Modbus Configuration

You can enable or disable the Modbus agent, configure its read-only capability, or change its TCP port.

A Modbus command begins with *network services modbus*.

### Enabling or Disabling Modbus

This command enables or disables the Modbus protocol.

```
config:# network services modbus enabled <option>
```

Variables:

- <option> is one of the options: *true* or *false*.

Option	Description
true	The Modbus agent is enabled.
false	The Modbus agent is disabled.

### Enabling or Disabling the Read-Only Mode

This command enables or disables the read-only mode for the Modbus agent.

```
config:# network services modbus readonly <option>
```

Variables:

- <option> is one of the options: *true* or *false*.

Option	Description
true	The read-only mode is enabled.
false	The read-only mode is disabled.

**Changing the Modbus Port**

This command changes the Modbus port.

```
config:# network services modbus port <n>
```

*Variables:*

- <n> is a TCP port number between 1 and 65535. The default Modbus port is 502.

**Enabling or Disabling the Service Advertisement**

This command enables or disables the zero configuration protocol, which enables advertising or auto discovery of network services. See **Enabling Service Advertisement** (on page 111) for details.

```
config:# network services zeroconfig enabled <option>
```

*Variables:*

- <option> is one of the options: *true* or *false*.

Option	Description
true	The zero configuration protocol is enabled.
false	The zero configuration protocol is disabled.

**Examples**

This section illustrates several network configuration examples.

**Example 1 - Networking Mode**

The following command enables the wired networking mode.

```
config:# network mode wired
```

**Example 2 - Enabling Both IP Protocols**

The following command determines that both IPv4 and IPv6 protocols are enabled.

```
config:# network ip proto both
```

**Example 3 - Wireless Authentication Method**

The following command sets the wireless authentication method to PSK.

```
config:# network wireless authMethod PSK
```

**Example 4 - Static IPv4 Configuration**

The following command enables the Static IP configuration mode.

```
config:# network ipv4 ipConfigurationMode static
```

---

**Time Configuration Commands**

A time configuration command begins with *time*.

**Determining the Time Setup Method**

This command determines the method to configure the system date and time.

```
config:# time method <method>
```

*Variables:*

- <method> is one of the time setup options: *manual* or *ntp*.

Mode	Description
manual	The date and time settings are customized.
ntp	The date and time settings synchronize with a specified NTP server.

**Setting NTP Parameters**

A time configuration command that is used to set the NTP parameters begins with *time ntp*.



**Specifying the Primary NTP Server**

This command specifies the primary time server if synchronization with the NTP server is enabled.

```
config:#    time ntp firstServer <first_server>
```

*Variables:*

- The <first\_server> is the IP address or host name of the primary NTP server.

**Specifying the Secondary NTP Server**

This command specifies the primary time server if synchronization with the NTP server is enabled.

```
config:#    time ntp secondServer <second_server>
```

*Variables:*

- The <second\_server> is the IP address or host name of the secondary NTP server.

**Overriding DHCP-Assigned NTP Servers**

This command determines whether the customized NTP server settings override the DHCP-specified NTP servers.

```
config:#    time ntp overrideDHCPProvidedServer <option>
```

*Variables:*

- <option> is one of these options: *true* or *false*.

Mode	Description
true	Customized NTP server settings override the DHCP-specified NTP servers.
false	Customized NTP server settings do NOT override the DHCP-specified NTP servers.

### Setting the Time Zone

In addition to the web interface, the CLI also provides a list of time zones for you to configure the date and time for your PX device.

```
config:# time zone
```

After a list of time zones is displayed, you can either type the index number of the desired time zone or simply press Enter to cancel this setting.

#### Example

► **To set the time zone:**

1. Type the time zone command as shown below and press Enter.  

```
config:# time zone
```
2. The system shows a list of time zones. Type the index number of the desired time zone and press Enter.
3. Type `apply` for the selected time zone to take effect.

### Setting the Automatic Daylight Savings Time

This command determines whether the daylight savings time is applied to the time settings.

```
config:# time autoDST <option>
```

Variables:

- <option> is one of the options: *enable* or *disable*.

Mode	Description
enable	Daylight savings time is enabled.
disable	Daylight savings time is disabled.

#### Examples

This section illustrates several time configuration examples.

**Example 1 - Time Setup Method**

The following command sets the date and time settings by using the NTP servers.

```
config:#    time method ntp
```

**Example 2 - Primary NTP Server**

The following command sets the primary time server to 192.168.80.66.

```
config:#    time ntp firstServer 192.168.80.66
```

---

**Security Configuration Commands**

A security configuration command begins with *security*.

**Firewall Control**

You can manage firewall control features through the CLI. The firewall control lets you set up rules that permit or disallow access to the PX device from a specific or a range of IP addresses.

- An IPv4 firewall configuration command begins with *security ipAccessControl ipv4*.
- An IPv6 firewall configuration command begins with *security ipAccessControl ipv6*.

**Modifying Firewall Control Parameters**

There are different commands for modifying firewall control parameters.

- *IPv4 commands*

- ▶ **Enable or disable the IPv4 firewall control feature:**

```
config:#    security ipAccessControl ipv4 enabled <option>
```

- ▶ **Determine the default IPv4 firewall control policy for inbound traffic:**

```
config:#    security ipAccessControl ipv4 defaultPolicyIn <policy>
```

- ▶ **Determine the default IPv4 firewall control policy for outbound traffic:**

```
config:# security ipAccessControl ipv4 defaultPolicyOut <policy>
```

- IPv6 commands

▶ **Enable or disable the IPv6 firewall control feature:**

```
config:# security ipAccessControl ipv6 enabled <option>
```

▶ **Determine the default IPv6 firewall control policy for inbound traffic:**

```
config:# security ipAccessControl ipv6 defaultPolicyIn <policy>
```

▶ **Determine the default IPv6 firewall control policy for outbound traffic:**

```
config:# security ipAccessControl ipv6 defaultPolicyOut <policy>
```

*Variables:*

- <option> is one of the options: *true* or *false*.

Option	Description
true	Enables the IP access control feature.
false	Disables the IP access control feature.

- <policy> is one of the options: *accept*, *drop* or *reject*.

Option	Description
accept	Accepts traffic from all IP addresses.
drop	Discards traffic from all IP addresses, without sending any failure notification to the source host.
reject	Discards traffic from all IP addresses, and an ICMP message is sent to the source host for failure notification.

---

*Tip:* You can combine both commands to modify all firewall control parameters at a time. See **Multi-Command Syntax** (on page 465).

---

**Managing Firewall Rules**

You can add, delete or modify firewall rules using the CLI commands.

- An IPv4 firewall control rule command begins with *security ipAccessControl ipv4 rule*.
- An IPv6 firewall control rule command begins with *security ipAccessControl ipv6 rule*.

**Adding a Firewall Rule**

Depending on where you want to add a new firewall rule in the list, the command for adding a rule varies.

- *IPv4 commands*

▶ **Add a new rule to the bottom of the IPv4 rules list:**

```
config:# security ipAccessControl ipv4 rule add <direction> <ip_mask> <policy>
```

▶ **Add a new IPv4 rule by inserting it above or below a specific rule:**

```
config:# security ipAccessControl ipv4 rule add <direction> <ip_mask> <policy> <insert>
<rule_number>
```

-- OR --

```
config:# security ipAccessControl ipv4 rule add <direction> <insert> <rule_number>
<ip_mask> <policy>
```

- *IPv6 commands*

▶ **Add a new rule to the bottom of the IPv6 rules list:**

```
config:# security ipAccessControl ipv6 rule add <direction> <ip_mask> <policy>
```

▶ **Add a new IPv6 rule by inserting it above or below a specific rule:**

```
config:# security ipAccessControl ipv6 rule add <direction> <ip_mask> <policy> <insert>
<rule_number>
```

-- OR --

```
config:# security ipAccessControl ipv6 rule add <direction> <insert> <rule_number>
<ip_mask> <policy>
```

*Variables:*

- <direction> is one of the options: *in* or *out*.

Direction	Description
in	Inbound traffic.
out	Outbound traffic.

- <ip\_mask> is the combination of the IP address and subnet mask values (or prefix length), which are separated with a slash. For example, an IPv4 combination looks like this: *192.168.94.222/24*.
- <policy> is one of the options: *accept*, *drop* or *reject*.

Policy	Description
accept	Accepts traffic from/to the specified IP address(es).
drop	Discards traffic from/to the specified IP address(es), without sending any failure notification to the source or destination host.
reject	Discards traffic from/to the specified IP address(es), and an ICMP message is sent to the source or destination host for failure notification.

- <insert> is one of the options: *insertAbove* or *insertBelow*.

Option	Description
insertAbove	Inserts the new rule above the specified rule number. Then: <i>new rule's number = the specified rule number</i>
insertBelow	Inserts the new rule below the specified rule number. Then: <i>new rule's number = the specified rule number + 1</i>

- <rule\_number> is the number of the existing rule which you want to insert the new rule above or below.

**Modifying a Firewall Rule**

Depending on what to modify in an existing rule, the command varies.

- *IPv4 commands*

▶ **Modify an IPv4 rule's IP address and/or subnet mask:**

```
config:# security ipAccessControl ipv4 rule modify <direction> <rule_number> ipMask
<ip_mask>
```

▶ **Modify an IPv4 rule's policy:**

```
config:# security ipAccessControl ipv4 rule modify <direction> <rule_number> policy
<policy>
```

▶ **Modify all contents of an existing IPv4 rule:**

```
config:# security ipAccessControl ipv4 rule modify <direction> <rule_number> ipMask
<ip_mask> policy <policy>
```

- *IPv6 commands*

▶ **Modify an IPv6 rule's IP address and/or prefix length:**

```
config:# security ipAccessControl ipv6 rule modify <direction> <rule_number> ipMask
<ip_mask>
```

▶ **Modify an IPv6 rule's policy:**

```
config:# security ipAccessControl ipv6 rule modify <direction> <rule_number> policy
<policy>
```

▶ **Modify all contents of an IPv6 existing rule:**

```
config:# security ipAccessControl ipv6 rule modify <direction> <rule_number> ipMask
<ip_mask> policy <policy>
```

*Variables:*

- <direction> is one of the options: *in* or *out*.

Direction	Description
in	Inbound traffic.
out	Outbound traffic.

- `<rule_number>` is the number of the existing rule that you want to modify.
- `<ip_mask>` is the combination of the IP address and subnet mask values (or prefix length), which are separated with a slash. For example, an IPv4 combination looks like this: `192.168.94.222/24`.
- `<policy>` is one of the options: `accept`, `drop` or `reject`.

Option	Description
accept	Accepts traffic from/to the specified IP address(es).
drop	Discards traffic from/to the specified IP address(es), without sending any failure notification to the source or destination host.
reject	Discards traffic from/to the specified IP address(es), and an ICMP message is sent to the source or destination host for failure notification.

### Deleting a Firewall Rule

The following commands remove a specific IPv4 or IPv6 rule from the list.

#### ▶ IPv4 commands

```
config:# security ipAccessControl ipv4 rule delete <direction> <rule_number>
```

#### ▶ IPv6 commands

```
config:# security ipAccessControl ipv6 rule delete <direction> <rule_number>
```

Variables:

- `<direction>` is one of the options: `in` or `out`.

Direction	Description
in	Inbound traffic.
out	Outbound traffic.

- `<rule_number>` is the number of the existing rule that you want to remove.



**Restricted Service Agreement**

The CLI command used to set the Restricted Service Agreement feature begins with `security restrictedServiceAgreement`,

**Enabling or Disabling the Restricted Service Agreement**

This command activates or deactivates the Restricted Service Agreement.

```
config:# security restrictedServiceAgreement enabled <option>
```

*Variables:*

- <option> is one of the options: *true* or *false*.

Option	Description
true	Enables the Restricted Service Agreement feature.
false	Disables the Restricted Service Agreement feature.

If the Restricted Service Agreement feature is enabled, the Restricted Service Agreement is displayed when any user logs in to the PX. Do either of the following, or you cannot successfully log in to the PX:

- In the web interface, select the checkbox labeled "I understand and accept the Restricted Service Agreement."

---

*Tip: To select the agreement checkbox using the keyboard, press the Space bar.*

---

- In the CLI, type `y` when the confirmation message "I understand and accept the Restricted Service Agreement" is displayed.

**Specifying the Agreement Contents**

This command allows you to create or modify contents of the Restricted Service Agreement.

```
config:# security restrictedServiceAgreement bannerContent
```

After performing the above command, do the following:

1. Type the text comprising up to 10,000 ASCII characters when the CLI prompts you to enter the content.
2. To end the content:
  - a. Press Enter.

- b. Type `--END--` to indicate the end of the content.
- c. Press Enter again.

If the content is successfully entered, the CLI displays this message "Successfully entered Restricted Service Agreement" followed by the total number of entered characters in parentheses.

---

*Note: The new content of Restricted Service Agreement is saved only after typing the `apply` command. See **Quitting Configuration Mode** (on page 355).*

---

### Example

The following example illustrates how to specify the content of the Restricted Service Agreement.

1. Type the following command and press Enter to start entering the content.

```
config:# security restrictedServiceAgreement bannerContent
```

2. Type the following content when the CLI prompts you to enter the content.

```
IMPORTANT!! You are accessing a PDU. If you are not the  
system administrator, do NOT power off or power cycle  
any outlet without the permission of the system  
administrator.
```

3. Press Enter.
4. Type the following:  

```
--END--
```
5. Press Enter again.
6. Verify that the message "Successfully entered Restricted Service Agreement" is displayed, indicating that the content input is successful.

### Login Limitation

The login limitation feature controls login-related limitations, such as password aging, simultaneous logins using the same user name, and the idle time permitted before forcing a user to log out.

A login limitation command begins with `security loginLimits`.

You can combine multiple commands to modify various login limitation parameters at a time. See **Multi-Command Syntax** (on page 465).

**Single Login Limitation**

This command enables or disables the single login feature, which controls whether multiple logins using the same login name simultaneously is permitted.

```
config:# security loginLimits singleLogin <option>
```

Variables:

- <option> is one of the options: *enable* or *disable*.

Option	Description
enable	Enables the single login feature.
disable	Disables the single login feature.

**Password Aging**

This command enables or disables the password aging feature, which controls whether the password should be changed at a regular interval:

```
config:# security loginLimits passwordAging <option>
```

Variables:

- <option> is one of the options: *enable* or *disable*.

Option	Description
enable	Enables the password aging feature.
disable	Disables the password aging feature.

**Password Aging Interval**

This command determines how often the password should be changed.

```
config:# security loginLimits passwordAgingInterval <value>
```

Variables:

- <value> is a numeric value in days set for the password aging interval. The interval ranges from 7 to 365 days.

### **Idle Timeout**

This command determines how long a user can remain idle before that user is forced to log out of the PX web interface or CLI.

```
config:# security loginLimits idleTimeout <value>
```

#### *Variables:*

- <value> is a numeric value in minutes set for the idle timeout. The timeout ranges from 1 to 1440 minutes (24 hours).

### **User Blocking**

There are different commands for changing different user blocking parameters. These commands begin with `security userBlocking`.

You can combine multiple commands to modify the user blocking parameters at a time. See **Multi-Command Syntax** (on page 465).

- ▶ **Determine the maximum number of failed logins before blocking a user:**

```
config:# security userBlocking maximumNumberOfFailedLogins <value1>
```

- ▶ **Determine how long a user is blocked:**

```
config:# security userBlocking blockTime <value2>
```

#### *Variables:*

- <value1> is an integer between 3 and 10, or *unlimited*, which sets no limit on the maximum number of failed logins and thus disables the user blocking function.
- <value2> is a numeric value ranging from 1 to 1440 minutes (one day), or *infinite*, which blocks the user all the time until the user is unblocked manually.

**Strong Passwords**

The strong password commands determine whether a strong password is required for login, and what a strong password should contain at least.

A strong password command begins with `security strongPasswords`.

You can combine multiple strong password commands to modify different parameters at a time. See **Multi-Command Syntax** (on page 465).

**Enabling or Disabling Strong Passwords**

This command enables or disables the strong password feature.

```
config:# security strongPasswords enabled <option>
```

Variables:

- <option> is one of the options: *true* or *false*.

Option	Description
true	Enables the strong password feature.
false	Disables the strong password feature.

**Minimum Password Length**

This command determines the minimum length of the password.

```
config:# security strongPasswords minimumLength <value>
```

Variables:

- <value> is an integer between 8 and 32.

**Maximum Password Length**

This command determines the maximum length of the password.

```
config:# security strongPasswords maximumLength <value>
```

Variables:

- <value> is an integer between 16 and 64.

**Lowercase Character Requirement**

This command determines whether a strong password includes at least a lowercase character.

```
config:# security strongPasswords enforceAtLeastOneLowerCaseCharacter <option>
```

*Variables:*

- <option> is one of the options: *enable* or *disable*.

Option	Description
enable	At least one lowercase character is required.
disable	No lowercase character is required.

**Uppercase Character Requirement**

This command determines whether a strong password includes at least an uppercase character.

```
config:# security strongPasswords enforceAtLeastOneUpperCaseCharacter <option>
```

*Variables:*

- <option> is one of the options: *enable* or *disable*.

Option	Description
enable	At least one uppercase character is required.
disable	No uppercase character is required.

**Numeric Character Requirement**

This command determines whether a strong password includes at least a numeric character.

```
config:# security strongPasswords enforceAtLeastOneNumericCharacter <option>
```

*Variables:*

- <option> is one of the options: *enable* or *disable*.

Option	Description
enable	At least one numeric character is required.

Option	Description
disable	No numeric character is required.

### **Special Character Requirement**

This command determines whether a strong password includes at least a special character.

```
config:# security strongPasswords enforceAtLeastOneSpecialCharacter <option>
```

*Variables:*

- <option> is one of the options: *enable* or *disable*.

Option	Description
enable	At least one special character is required.
disable	No special character is required.

### **Maximum Password History**

This command determines the number of previous passwords that CANNOT be repeated when changing the password.

```
config:# security strongPasswords passwordHistoryDepth <value>
```

*Variables:*

- <value> is an integer between 1 and 12.

### **Role-Based Access Control**

In addition to firewall access control based on IP addresses, you can configure other access control rules that are based on both IP addresses and users' roles.

- An IPv4 role-based access control command begins with *security roleBasedAccessControl ipv4*.
- An IPv6 role-based access control command begins with *security roleBasedAccessControl ipv6*.

**Modifying Role-Based Access Control Parameters**

There are different commands for modifying role-based access control parameters.

- IPv4 commands

▶ **Enable or disable the IPv4 role-based access control feature:**

```
config:# security roleBasedAccessControl ipv4 enabled <option>
```

▶ **Determine the IPv4 role-based access control policy:**

```
config:# security roleBasedAccessControl ipv4 defaultPolicy <policy>
```

- IPv6 commands

▶ **Enable or disable the IPv6 role-based access control feature:**

```
config:# security roleBasedAccessControl ipv6 enabled <option>
```

▶ **Determine the IPv6 role-based access control policy:**

```
config:# security roleBasedAccessControl ipv6 defaultPolicy <policy>
```

Variables:

- <option> is one of the options: *true* or *false*.

Option	Description
true	Enables the role-based access control feature.
false	Disables the role-based access control feature.

- <policy> is one of the options: *allow* or *deny*.

Policy	Description
allow	Accepts traffic from all IP addresses regardless of the user's role.
deny	Drops traffic from all IP addresses regardless of the user's role.



---

*Tip: You can combine both commands to modify all role-based access control parameters at a time. See **Multi-Command Syntax** (on page 465).*

---

### **Managing Role-Based Access Control Rules**

You can add, delete or modify role-based access control rules.

- An IPv4 role-based access control command for managing rules begins with *security roleBasedAccessControl ipv4 rule*.
- An IPv6 role-based access control command for managing rules begins with *security roleBasedAccessControl ipv6 rule*.

### **Adding a Role-Based Access Control Rule**

Depending on where you want to add a new rule in the list, the command syntax for adding a rule varies.

- *IPv4 commands*

▶ **Add a new rule to the bottom of the IPv4 rules list:**

```
config:# security roleBasedAccessControl ipv4 rule add <start_ip> <end_ip> <role>
<policy>
```

▶ **Add a new IPv4 rule by inserting it above or below a specific rule:**

```
config:# security roleBasedAccessControl ipv4 rule add <start_ip> <end_ip> <role>
<policy> <insert> <rule_number>
```

- *IPv6 commands*

▶ **Add a new rule to the bottom of the IPv6 rules list:**

```
config:# security roleBasedAccessControl ipv6 rule add <start_ip> <end_ip> <role>
<policy>
```

▶ **Add a new IPv6 rule by inserting it above or below a specific rule:**

```
config:# security roleBasedAccessControl ipv6 rule add <start_ip> <end_ip> <role>
<policy> <insert> <rule_number>
```

*Variables:*

- <start\_ip> is the starting IP address.
- <end\_ip> is the ending IP address.
- <role> is the role for which you want to create an access control rule.
- <policy> is one of the options: *allow* or *deny*.

Policy	Description
allow	Accepts traffic from the specified IP address range when the user is a member of the specified role
deny	Drops traffic from the specified IP address range when the user is a member of the specified role

- <insert> is one of the options: *insertAbove* or *insertBelow*.

Option	Description
insertAbove	Inserts the new rule above the specified rule number. Then: <i>new rule's number = the specified rule number</i>
insertBelow	Inserts the new rule below the specified rule number. Then: <i>new rule's number = the specified rule number + 1</i>

- <rule\_number> is the number of the existing rule which you want to insert the new rule above or below.

**Modifying a Role-Based Access Control Rule**

Depending on what to modify in an existing rule, the command syntax varies.

- *IPv4 commands*

▶ **Modify a rule's IPv4 address range:**

```
config:# security roleBasedAccessControl ipv4 rule modify <rule_number>
startIpAddress <start_ip> endIpAddress <end_ip>
```

▶ **Modify an IPv4 rule's role:**

```
config:# security roleBasedAccessControl ipv4 rule modify <rule_number> role <role>
```

▶ **Modify an IPv4 rule's policy:**

```
config:# security roleBasedAccessControl ipv4 rule modify <rule_number> policy  
<policy>
```

▶ **Modify all contents of an existing IPv4 rule:**

```
config:# security roleBasedAccessControl ipv4 rule modify <rule_number>  
startIpAddress <start_ip> endIpAddress <end_ip> role <role> policy <policy>
```

- *IPv6 commands*

▶ **Modify a rule's IPv6 address range:**

```
config:# security roleBasedAccessControl ipv6 rule modify <rule_number>  
startIpAddress <start_ip> endIpAddress <end_ip>
```

▶ **Modify an IPv6 rule's role:**

```
config:# security roleBasedAccessControl ipv6 rule modify <rule_number> role <role>
```

▶ **Modify an IPv6 rule's policy:**

```
config:# security roleBasedAccessControl ipv6 rule modify <rule_number> policy  
<policy>
```

▶ **Modify all contents of an existing IPv6 rule:**

```
config:# security roleBasedAccessControl ipv6 rule modify <rule_number>
startIpAddress <start_ip> endIpAddress <end_ip> role <role> policy <policy>
```

*Variables:*

- <rule\_number> is the number of the existing rule that you want to modify.
- <start\_ip> is the starting IP address.
- <end\_ip> is the ending IP address.
- <role> is one of the existing roles.
- <policy> is one of the options: *allow* or *deny*.

Policy	Description
allow	Accepts traffic from the specified IP address range when the user is a member of the specified role
deny	Drops traffic from the specified IP address range when the user is a member of the specified role

**Deleting a Role-Based Access Control Rule**

These commands remove a specific rule from the list.

▶ IPv4 commands

```
config:# security roleBasedAccessControl ipv4 rule delete <rule_number>
```

▶ IPv6 commands

```
config:# security roleBasedAccessControl ipv6 rule delete <rule_number>
```

*Variables:*

- <rule\_number> is the number of the existing rule that you want to remove.

### Enabling or Disabling Front Panel Outlet Switching

This section applies to outlet-switching capable models only.

The following CLI commands control whether you can turn on or off an outlet by operating the front panel display.

► **To enable the front panel outlet control feature:**

```
config:# security frontPanelPermissions add switchOutlet
```

► **To disable the front panel outlet control feature:**

```
config:# security frontPanelPermissions remove switchOutlet
```

### Examples

This section illustrates several security configuration examples.

#### **Example 1 - IPv4 Firewall Control Configuration**

The following command sets up two parameters of the IPv4 access control feature.

```
config:# security ipAccessControl ipv4 enabled true defaultPolicyIn accept
defaultPolicyOut accept
```

#### *Results:*

- The IPv4 access control feature is enabled.
- The default policy for inbound traffic is set to "accept."
- The default policy for outbound traffic is set to "accept."

#### **Example 2 - Adding an IPv4 Firewall Rule**

The following command adds a new IPv4 access control rule and specifies its location in the list.

```
config:# security ipAccessControl ipv4 rule add 192.168.84.123/24 accept
insertAbove 5
```

*Results:*

- A new IPv4 firewall control rule is added to accept all packets sent from the IPv4 address 192.168.84.123.
- The newly-added rule is inserted above the 5th rule. That is, the new rule becomes the 5th rule, and the original 5th rule becomes the 6th rule.

**Example 3 - User Blocking**

The following command sets up two user blocking parameters.

```
config:# security userBlocking maximumNumberOfFailedLogins 5 blockTime 30
```

*Results:*

- The maximum number of failed logins is set to 5.
- The user blocking time is set to 30 minutes.

**Example 4 - Adding an IPv4 Role-based Access Control Rule**

The following command creates a new IPv4 role-based access control rule and specifies its location in the list.

```
config:# security roleBasedAccessControl ipv4 rule add 192.168.78.50 192.168.90.100
admin deny insertAbove 3
```

*Results:*

- A new IPv4 role-based access control rule is added, dropping all packets from any IPv4 address between 192.168.78.50 and 192.168.90.100 when the user is a member of the role "admin."
- The newly-added IPv4 rule is inserted above the 3rd rule. That is, the new rule becomes the 3rd rule, and the original 3rd rule becomes the 4th rule.

---

## Outlet Configuration Commands

An outlet configuration command begins with *outlet*. Such a command allows you to configure an individual outlet.

### Changing the Outlet Name

This command names an outlet.

```
config:#  outlet <n> name "<name>"
```

*Variables:*

- <n> is the number of the outlet that you want to configure.
- <name> is a string comprising up to 32 ASCII printable characters. The <name> variable must be enclosed in quotes when it contains spaces.

### Changing an Outlet's Default State

This section applies to outlet-switching capable models only.

This command determines the initial power condition of an outlet after the PX powers up.

```
config:#  outlet <n> stateOnDeviceStartup <option>
```

*Variables:*

- <n> is the number of the outlet that you want to configure.
- <option> is one of the options: *off*, *on*, *lastKnownState* and *pduDefined*.

Option	Description
off	Turn off the outlet.
on	Turn on the outlet.
lastKnownState	Restore the outlet to the state prior to last PDU power down.
pduDefined	PDU-defined setting.

---

*Note:* Setting the outlet's default state to an option other than *pduDefined* overrides the PDU-defined default state on that outlet. See **Setting the PDU-Defined Default Outlet State** (on page 358).

---

### Setting an Outlet's Cycling Power-Off Period

This section applies to outlet-switching capable models only.

This command determines the power-off period of the power cycling operation for a specific outlet.

```
config:#    outlet <n> cyclingPowerOffPeriod <timing>
```

#### Variables:

- <n> is the number of the outlet that you want to configure.
- <timing> is the time of the cycling power-off period in seconds, which is an integer between 0 and 3600, or *pduDefined* for following the PDU-defined timing.

---

*Note: This setting overrides the PDU-defined cycling power-off period on a particular outlet. See **Setting the PDU-Defined Cycling Power-Off Period** (on page 358).*

---

#### Example - Outlet Naming

The following command assigns the name "Win XP" to outlet 8.

```
config:#    outlet 8 name "Win XP"
```

---

### Inlet Configuration Commands

An inlet configuration command begins with *inlet*. You can configure an inlet by using the inlet configuration command.



**Changing the Inlet Name**

This command syntax names an inlet.

```
config:#  inlet <n> name "<name>"
```

*Variables:*

- <n> is the number of the inlet that you want to configure. For a single-inlet PDU, <n> is always the number 1. The value is an integer between 1 and 50.
- <name> is a string comprising up to 32 ASCII printable characters. The <name> variable must be enclosed in quotes when it contains spaces.

**Enabling or Disabling an Inlet (for Multi-Inlet PDUs)**

Enabling or disabling an inlet takes effect on a multi-inlet PDU only.

This command enables or disables an inlet.

```
config:#  inlet <n> enabled <option>
```

*Variables:*

- <n> is the number of the inlet that you want to configure. For a single-inlet PDU, <n> is always the number 1. The value is an integer between 1 and 50.
- <option> is one of the options: *true* or *false*.

Option	Description
true	The specified inlet is enabled.
false	The specified inlet is disabled.

*Note: If performing this command causes all inlets to be disabled, a warning message appears, prompting you to confirm. When this occurs, press y to confirm or n to cancel the operation.*

### Example - Inlet Naming

The following command assigns the name "AC source" to the inlet 1. If your PX device contains multiple inlets, this command names the 1st inlet.

```
config:#    inlet 1 name "AC source"
```

---

### Overcurrent Protector Configuration Commands

An overcurrent protector configuration command begins with *ocp*. The command configures an individual circuit breaker or fuse which protects outlets.

#### Changing the Overcurrent Protector Name

This command names a circuit breaker or a fuse which protects outlets on your PX.

```
config:#    ocp <n> name "<name>"
```

*Variables:*

- <n> is the number of the overcurrent protector that you want to configure. The value is an integer between 1 and 50.
- <name> is a string comprising up to 32 ASCII printable characters. The <name> variable must be enclosed in quotes when it contains spaces.

### Example - OCP Naming

The command assigns the name "Email servers CB" to the overcurrent protector labeled 2.

```
config:#    ocp 2 name "Email servers CB"
```

---

### User Configuration Commands

Most user configuration commands begin with *user* except for the password change command.

### Creating a User Profile

This command creates a new user profile.

```
config:# user create <name> <option> <roles>
```

After performing the user creation command, the PX prompts you to assign a password to the newly-created user. Then:

1. Type the password and press Enter.
2. Re-type the same password for confirmation and press Enter.

*Variables:*

- <name> is a string comprising up to 32 ASCII printable characters. The <name> variable CANNOT contain spaces.
- <option> is one of the options: *enable* or *disable*.

Option	Description
enable	Enables the newly-created user profile.
disable	Disables the newly-created user profile.

- <roles> is a role or a list of comma-separated roles assigned to the specified user profile.

### Modifying a User Profile

A user profile contains various parameters that you can modify.

---

*Tip: You can combine all commands to modify the parameters of a specific user profile at a time. See **Multi-Command Syntax** (on page 465).*

---

### Changing a User's Password

This command allows you to change an existing user's password if you have the Administrator Privileges.

```
config:# user modify <name> password
```

After performing the above command, PX prompts you to enter a new password. Then:

1. Type a new password and press Enter.

2. Re-type the new password for confirmation and press Enter.

*Variables:*

- <name> is the name of the user whose settings you want to change.

### **Example**

The following procedure illustrates how to change the password of the user "May."

1. Verify that you have entered the configuration mode. See **Entering Configuration Mode** (on page 355).
2. Type the following command to change the password for the user profile "May."  

```
config:# user modify May password
```
3. Type a new password when prompted, and press Enter.
4. Type the same new password and press Enter.
5. If the password change is completed successfully, the config:# prompt appears.

**Modifying a User's Personal Data**

You can change a user's personal data, including the user's full name, telephone number, and email address.

Various commands can be combined to modify the parameters of a specific user profile at a time. See **Multi-Command Syntax** (on page 465).

**► Change a user's full name:**

```
config:# user modify <name> fullName "<full_name>"
```

**► Change a user's telephone number:**

```
config:# user modify <name> telephoneNumber "<phone_number>"
```

**► Change a user's email address:**

```
config:# user modify <name> emailAddress <email_address>
```

*Variables:*

- <name> is the name of the user whose settings you want to change.
- <full\_name> is a string comprising up to 32 ASCII printable characters. The <full\_name> variable must be enclosed in quotes when it contains spaces.
- <phone\_number> is the phone number that can reach the specified user. The <phone\_number> variable must be enclosed in quotes when it contains spaces.
- <email\_address> is the email address of the specified user.

**Enabling or Disabling a User Profile**

This command enables or disables a user profile. A user can log in to the PX device only after that user's user profile is enabled.

```
config:# user modify <name> enabled <option>
```

Variables:

- <name> is the name of the user whose settings you want to change.
- <option> is one of the options: *true* or *false*.

Option	Description
true	Enables the specified user profile.
false	Disables the specified user profile.

**Forcing a Password Change**

This command determines whether the password change is forced when a user logs in to the specified user profile next time.

```
config:# user modify <name> forcePasswordChangeOnNextLogin <option>
```

Variables:

- <name> is the name of the user whose settings you want to change.
- <option> is one of the options: *true* or *false*.

Option	Description
true	A password change is forced on the user's next login.
false	No password change is forced on the user's next login.

**Modifying SNMPv3 Settings**

There are different commands to modify the SNMPv3 parameters of a specific user profile. You can combine all of the following commands to modify the SNMPv3 parameters at a time. See **Multi-Command Syntax** (on page 465).

► **Enable or disable the SNMP v3 access to PX for the specified user:**

```
config:# user modify <name> snmpV3Access <option1>
```

*Variables:*

- <name> is the name of the user whose settings you want to change.
- <option1> is one of the options: *enable* or *disable*.

Option	Description
enable	Enables the SNMP v3 access permission for the specified user.
disable	Disables the SNMP v3 access permission for the specified user.

► **Determine the security level:**

```
config:# user modify <name> securityLevel <option2>
```

*Variables:*

- <name> is the name of the user whose settings you want to change.
- <option2> is one of the options: *noAuthNoPriv*, *authNoPriv* or *authPriv*.

Option	Description
noAuthNoPriv	No authentication and no privacy.
authNoPriv	Authentication and no privacy.
authPriv	Authentication and privacy.

► **Determine whether the authentication passphrase is identical to the password:**

```
config:# user modify <name> userPasswordAsAuthenticationPassphrase <option3>
```

*Variables:*

- <name> is the name of the user whose settings you want to change.
- <option3> is one of the options: *true* or *false*.

Option	Description
true	Authentication passphrase is identical to the password.
false	Authentication passphrase is different from the password.

► **Determine the authentication passphrase:**

```
config:# user modify <name> authenticationPassPhrase <authentication_passphrase>
```

*Variables:*

- <name> is the name of the user whose settings you want to change.
- <authentication\_passphrase> is a string used as an authentication passphrase, comprising 8 to 32 ASCII printable characters.

► **Determine whether the privacy passphrase is identical to the authentication passphrase:**

```
config:# user modify <name> useAuthenticationPassPhraseAsPrivacyPassPhrase <option4>
```

*Variables:*

- <name> is the name of the user whose settings you want to change.
- <option4> is one of the options: *true* or *false*.

Option	Description
true	Privacy passphrase is identical to the authentication passphrase.
false	Privacy passphrase is different from the authentication passphrase.



► **Determine the privacy passphrase:**

```
config:# user modify <name> privacyPassPhrase <privacy_passphrase>
```

*Variables:*

- <name> is the name of the user whose settings you want to change.
- <privacy\_passphrase> is a string used as a privacy passphrase, comprising 8 to 32 ASCII printable characters.

► **Determine the authentication protocol:**

```
config:# user modify <name> authenticationProtocol <option5>
```

*Variables:*

- <name> is the name of the user whose settings you want to change.
- <option5> is one of the options: *MD5* or *SHA-1*.

Option	Description
MD5	MD5 authentication protocol is applied.
SHA-1	SHA-1 authentication protocol is applied.

► **Determine the privacy protocol:**

```
config:# user modify <name> privacyProtocol <option6>
```

*Variables:*

- <name> is the name of the user whose settings you want to change.
- <option6> is one of the options: *DES* or *AES-128*.

Option	Description
DES	DES privacy protocol is applied.
AES-128	AES-128 privacy protocol is applied.

### Changing the Role(s)

This command changes the role(s) of a specific user.

```
config:# user modify <name> roles <roles>
```

Variables:

- <name> is the name of the user whose settings you want to change.
- <roles> is a role or a list of comma-separated roles assigned to the specified user profile. See **All Privileges** (on page 428).

### Changing Measurement Units

You can change the measurement units displayed for temperatures, length, and pressure for a specific user profile. Different measurement unit commands can be combined so that you can set all measurement units at a time. To combine all commands, see **Multi-Command Syntax** (on page 465).

---

*Note: The measurement unit change only applies to the web interface and command line interface.*

---



---

*Tip: To set the default measurement units applied to the PX user interfaces for all users via CLI, see **Setting Up User Preferences (Units of Measure)** (see "Setting Default Measurement Units" on page 425).*

---

#### ► Set the preferred temperature unit:

```
config:# user modify <name> preferredTemperatureUnit <option1>
```

Variables:

- <name> is the name of the user whose settings you want to change.
- <option1> is one of the options: *C* or *F*.

Option	Description
C	This option displays the temperature in Celsius.
F	This option displays the temperature in Fahrenheit.

► **Set the preferred length unit:**

```
config:# user modify <name> preferredLengthUnit <option2>
```

*Variables:*

- <name> is the name of the user whose settings you want to change.
- <option2> is one of the options: *meter* or *feet*.

Option	Description
meter	This option displays the length or height in meters.
feet	This option displays the length or height in feet.

► **Set the preferred pressure unit:**

```
config:# user modify <name> preferredPressureUnit <option3>
```

*Variables:*

- <name> is the name of the user whose settings you want to change.
- <option3> is one of the options: *pascal* or *psi*.

Option	Description
pascal	This option displays the pressure value in Pascals (Pa).
psi	This option displays the pressure value in psi.

**Changing the SSH Public Key**

This command changes the role(s) of a specific user.

```
config:# user modify <name> sshPublicKey
```

After performing the above command, you are prompted to enter the SSH public key. You can either enter the new SSH public key or simply press Enter without entering any SSH public key to remove the existing SSH public key.

### Example

The following procedure illustrates how to change the SSH public key for the user "assistant."

1. Verify that you have entered the configuration mode. See **Entering Configuration Mode** (on page 355).
2. Type the following command and press Enter.  

```
config:# user modify assistant sshPublicKey
```
3. You are prompted to enter a new SSH public key.
4. Type the new key and press Enter.

### Deleting a User Profile

This command deletes an existing user profile.

```
config:# user delete <name>
```

### Changing Your Own Password

Every user can change their own password via this command if they have the Change Own Password privilege. Note that this command does not begin with *user*.

```
config:# password
```

After performing this command, the PX prompts you to enter both current and new passwords respectively.

---

**Important: After the password is changed successfully, the new password is effective immediately no matter you type the command "apply" or not to save the changes.**

---

### Example

This procedure changes your own password:

1. Verify that you have entered the configuration mode. See **Entering Configuration Mode** (on page 355).
2. Type the following command and press Enter.  

```
config:# password
```
3. Type the existing password and press Enter when the following prompt appears.

```
Current password:
```

4. Type the new password and press Enter when the following prompt appears.

```
Enter new password:
```

5. Re-type the new password for confirmation and press Enter when the following prompt appears.

```
Re-type new password:
```

### Setting Default Measurement Units

Default measurement units, including temperature, length, and pressure units, apply to the PX user interfaces across all users except for those whose preferred measurement units are set differently by themselves or the administrator. Diverse measurement unit commands can be combined so that you can set all default measurement units at a time. To combine all commands, see **Multi-Command Syntax** (on page 465).

---

*Note: The measurement unit change only applies to the web interface and command line interface.*

---

*Tip: To change the preferred measurement units displayed in the PX user interfaces for a specific user via CLI, see **Changing Measurement Units** (on page 422).*

---

#### ► Set the default temperature unit:

```
config:# user defaultpreferences preferredTemperatureUnit <option1>
```

*Variables:*

- <option1> is one of the options: C or F.

Option	Description
C	This option displays the temperature in Celsius.
F	This option displays the temperature in Fahrenheit.

#### ► Set the default length unit:

```
config:# user defaultpreferences preferredLengthUnit <option2>
```

*Variables:*

- <option2> is one of the options: *meter* or *feet*.

Option	Description
meter	This option displays the length or height in meters.
feet	This option displays the length or height in feet.

► **Set the default pressure unit:**

```
config:# user defaultpreferences preferredPressureUnit <option3>
```

*Variables:*

- <option3> is one of the options: *pascal* or *psi*.

Option	Description
pascal	This option displays the pressure value in Pascals (Pa).
psi	This option displays the pressure value in psi.

**Examples**

This section illustrates several user configuration examples.

**Example 1 - Creating a User Profile**

The following command creates a new user profile and sets two parameters for the new user.

```
config:# user create May enable admin
```

*Results:*

- A new user profile "May" is created.
- The new user profile is enabled.
- The **admin** role is assigned to the new user profile.

**Example 2 - Modifying a User's Roles**

The following command assigns two roles to the user "May."

```
config:# user modify May roles admin,tester
```

*Results:*

- The user May has the union of all privileges of "admin" and "tester."

**Example 3 - Default Measurement Units**

The following command sets all default measurement units at a time.

```
config:# user defaultpreferences preferredTemperatureUnit F preferredLengthUnit feet
preferredPressureUnit psi
```

*Results:*

- The default temperature unit is set to Fahrenheit.
- The default length unit is set to feet.
- The default pressure unit is set to psi.

---

**Role Configuration Commands**

A role configuration command begins with *role*.

**Creating a Role**

This command creates a new role, with a list of semicolon-separated privileges assigned to the role.

```
config:# role create <name> <privilege1>;<privilege2>;<privilege3>...
```

If a specific privilege contains any arguments, that privilege should be followed by a colon and the argument(s).

```
config:#  role create <name> <privilege1>:<argument1>,<argument2>...;
         <privilege2>:<argument1>,<argument2>...;
         <privilege3>:<argument1>,<argument2>...;
         ...
```

*Variables:*

- <name> is a string comprising up to 32 ASCII printable characters.
- <privilege1>, <privilege2>, <privilege3> and the like are names of the privileges assigned to the role. Separate each privilege with a semi-colon. See **All Privileges** (on page 428).
- <argument1>, <argument2> and the like are arguments set for a particular privilege. Separate a privilege and its argument(s) with a colon, and separate arguments with a comma if there are more than one argument for a privilege.

**All Privileges**

This table lists all privileges. Note that available privileges vary according to the model you purchased. For example, a PDU without the outlet switching function does not have the privilege "switchOutlet."

Privilege	Description
acknowledgeAlarms	Acknowledge Alarms
adminPrivilege	Administrator Privileges
changeAssetStripConfiguration	Change Asset Strip Configuration
changeAuthSettings	Change Authentication Settings
changeDateTimeSettings	Change Date/Time Settings
changeExternalSensorsConfiguration	Change Peripheral Device Configuration
changeLhxConfiguration	Change LHX Configuration
changeModemConfiguration	Change Modem Configuration
changeNetworkSettings	Change Network Settings
changePassword	Change Own Password
changePduConfiguration	Change Pdu, Inlet, Outlet & Overcurrent Protector Configuration
changeStsConfiguration	Change STS Configuration
changeSecuritySettings	Change Security Settings



Privilege	Description
changeSnmpSettings	Change SNMP Settings
changeUserSettings	Change Local User Management
changeWebcamSettings	Change Webcam Configuration
clearLog	Clear Local Event Log
firmwareUpdate	Firmware Update
performReset	Reset (Warm Start)
switchOutlet*	Switch Outlet
switchActuator**	Switch Actuator
viewEventSetup	View Event Settings
viewLog	View Local Event Log
viewSecuritySettings	View Security Settings
viewSnmpSettings	View SNMP Settings
viewUserSettings	View Local User Management
viewWebcamSettings	View Webcam Snapshots and Configuration

\* The "switchOutlet" privilege requires an argument that is separated with a colon. The argument could be:

- All outlets, that is,  
switchOutlet:all
- An outlet number. For example:  
switchOutlet:1  
switchOutlet:2  
switchOutlet:3
- A list of comma-separated outlets. For example:  
switchOutlet:1,3,5,7,8,9

\*\* The "switchActuator" privilege requires an argument that is separated with a colon. The argument could be:

- All actuators, that is,  
switchActuator:all
- An actuator's ID number. For example:  
switchActuator:1  
switchActuator:2

```
switchActuator:3
```

- A list of comma-separated ID numbers of different actuators. For example:

```
switchActuator:1,3,6
```

---

*Note: The ID number of each actuator is shown in the PX web interface. It is an integer between 1 and 32.*

---

### Modifying a Role

You can modify diverse parameters of an existing role, including its privileges.

▶ **Modify a role's description:**

```
config:#    role modify <name> description "<description>"
```

*Variables:*

- <name> is a string comprising up to 32 ASCII printable characters.
- <description> is a description comprising alphanumeric characters. The <description> variable must be enclosed in quotes when it contains spaces.

▶ **Add more privileges to a specific role:**

```
config:#    role modify <name> addPrivileges  
            <privilege1>;<privilege2>;<privilege3>...
```

If a specific privilege contains any arguments, add a colon and the argument(s) after that privilege.

```
config:#  role modify <name> addPrivileges
          <privilege1>:<argument1>,<argument2>...;
          <privilege2>:<argument1>,<argument2>...;
          <privilege3>:<argument1>,<argument2>...;
          ...
```

**Variables:**

- <name> is a string comprising up to 32 ASCII printable characters.
- <privilege1>, <privilege2>, <privilege3> and the like are names of the privileges assigned to the role. Separate each privilege with a semi-colon. See **All Privileges** (on page 428).
- <argument1>, <argument2> and the like are arguments set for a particular privilege. Separate a privilege and its argument(s) with a colon, and separate arguments with a comma if there are more than one argument for a privilege.

► **Remove specific privileges from a role:**

```
config:#  role modify <name> removePrivileges
          <privilege1>;<privilege2>;<privilege3>...
```

If a specific privilege contains any arguments, add a colon and the argument(s) after that privilege.

```
config:#  role modify <name> removePrivileges
          <privilege1>:<argument1>,<argument2>...;
          <privilege2>:<argument1>,<argument2>...;
          <privilege3>:<argument1>,<argument2>...;
          ...
```

---

*Note: When removing privileges from a role, make sure the specified privileges and arguments (if any) exactly match those assigned to the role. Otherwise, the command fails to remove specified privileges that are not available.*

---

**Variables:**

- <name> is a string comprising up to 32 ASCII printable characters.
- <privilege1>, <privilege2>, <privilege3> and the like are names of the privileges assigned to the role. Separate each privilege with a semi-colon. See **All Privileges** (on page 428).
- <argument1>, <argument2> and the like are arguments set for a particular privilege. Separate a privilege and its argument(s) with a colon, and separate arguments with a comma if there are more than one argument for a privilege.

### Deleting a Role

This command deletes an existing role.

```
config:#  role delete <name>
```

### Example - Creating a Role

The following command creates a new role and assigns privileges to the role.

```
config:#  role create tester firmwareUpdate;viewEventSetup
```

*Results:*

- A new role "tester" is created.
- Two privileges are assigned to the role: firmwareUpdate (Firmware Update) and viewEventSetup (View Event Settings).

---

### Environmental Sensor Configuration Commands

An environmental sensor configuration command begins with *externalsensor*. You can configure the name and location parameters of an individual environmental sensor.

---

*Note:* To configure an actuator, see **Actuator Configuration Commands** (on page 449).

---

### Changing the Sensor Name

This command names an environmental sensor.

```
config:# externalsensor <n> name "<name>"
```

*Variables:*

- <n> is the ID number of the environmental sensor that you want to configure. The ID number is available in the PX web interface or using the command "show externalsensors <n>" in the CLI. It is an integer between 1 and 32.
- <name> is a string comprising up to 32 ASCII printable characters. The <name> variable must be enclosed in quotes when it contains spaces.

---

*Note: To name an actuator, see **Actuator Configuration Commands** (on page 449).*

---

### Specifying the CC Sensor Type

Raritan's contact closure sensor (DPX-CC2-TR) supports the connection of diverse third-party or Raritan's detectors/switches. You must specify the type of connected detector/switch for proper operation. Use this command when you need to specify the sensor type.

```
config:# externalsensor <n> sensorSubType <sensor_type>
```

*Variables:*

- <n> is the ID number of the environmental sensor that you want to configure. The ID number is available in the PX web interface or using the command "show externalsensors <n>" in the CLI. It is an integer between 1 and 32.
- <sensor\_type> is one of these types: *contact*, *smokeDetection*, *waterDetection* or *vibration*.

Type	Description
contact	The connected detector/switch is for detection of door lock or door closed/open status.
smokeDetection	The connected detector/switch is for detection of the smoke presence.
waterDetection	The connected detector/switch is for detection of the water presence.
vibration	The connected detector/switch is for detection of the vibration.

### Setting the X Coordinate

This command specifies the X coordinate of an environmental sensor.

```
config:#    externalsensor <n> xlabel "<coordinate>"
```

#### *Variables:*

- <n> is the ID number of the environmental sensor that you want to configure. The ID number is available in the PX web interface or using the command "show externalsensors <n>" in the CLI. It is an integer between 1 and 32.
- <coordinate> is a string comprising up to 24 ASCII printable characters, and it must be enclosed in quotes.

### Setting the Y Coordinate

This command specifies the Y coordinate of an environmental sensor.

```
config:#    externalsensor <n> ylabel "<coordinate>"
```

#### *Variables:*

- <n> is the ID number of the environmental sensor that you want to configure. The ID number is available in the PX web interface or using the command "show externalsensors <n>" in the CLI. It is an integer between 1 and 32.
- <coordinate> is a string comprising up to 24 ASCII printable characters, and it must be enclosed in quotes.

**Setting the Z Coordinate**

This command specifies the Z coordinate of an environmental sensor.

```
config:#  externalsensor <n> zlabel "<coordinate>"
```

Variables:

- <n> is the ID number of the environmental sensor that you want to configure. The ID number is available in the PX web interface or using the command "show externalsensors <n>" in the CLI. It is an integer between 1 and 32.
- Depending on the Z coordinate format you set, there are two types of values for the <coordinate> variable:

Type	Description
Free form	<coordinate> is a string comprising up to 24 ASCII printable characters, and it must be enclosed in quotes.
Rack units	<coordinate> is an integer number in rack units.

---

*Note: To specify the Z coordinate using the rack units, see **Setting the Z Coordinate Format for Environmental Sensors** (on page 362).*

---

**Changing the Sensor Description**

This command provides a description for a specific environmental sensor.

```
config:#  externalsensor <n> description "<description>"
```

Variables:

- <n> is the ID number of the environmental sensor that you want to configure. The ID number is available in the PX web interface or using the command "show externalsensors <n>" in the CLI. It is an integer between 1 and 32.
- <description> is a string comprising up to 64 ASCII printable characters, and it must be enclosed in quotes.

### Using Default Thresholds

This command determines whether default thresholds, including the deassertion hysteresis and assertion timeout, are applied to a specific environmental sensor.

```
config:#    externalsensor <n> useDefaultThresholds <option>
```

#### Variables:

- <n> is the ID number of the environmental sensor that you want to configure. The ID number is available in the PX web interface or using the command "show externalsensors <n>" in the CLI. It is an integer between 1 and 32.
- <option> is one of the options: *true* or *false*.

Option	Description
true	Default thresholds are selected as the threshold option for the specified sensor.
false	Sensor-specific thresholds are selected as the threshold option for the specified sensor.

### Setting the Alarmed to Normal Delay for DX-PIR

This command determines the value of the Alarmed to Normal Delay setting for a DX-PIR presence detector.

```
config:#    externalsensor <n> alarmedToNormalDelay <time>
```

#### Variables:

- <n> is the ID number of the environmental sensor that you want to configure. The ID number is available in the PX web interface or using the command "show externalsensors <n>" in the CLI. It is an integer between 1 and 32.
- <time> is an integer number in seconds, ranging between 0 and 300.

### Examples

This section illustrates several environmental sensor configuration examples.



**Example 1 - Environmental Sensor Naming**

The following command assigns the name "Cabinet humidity" to the environmental sensor with the ID number 4.

```
config:#    externalsensor 4 name "Cabinet humidity"
```

**Example 2 - Sensor Threshold Selection**

The following command sets the environmental sensor #1 to use the default thresholds, including the deassertion hysteresis and assertion timeout, as its threshold settings.

```
config:#    externalsensor 1 useDefaultThresholds true
```

---

**Configuring Environmental Sensors' Default Thresholds**

You can set the default values of upper and lower thresholds, deassertion hysteresis and assertion timeout on a sensor type basis, including temperature, humidity, air pressure and air flow sensors. The default thresholds automatically apply to all environmental sensors that are newly detected or added.

A default threshold configuration command begins with *defaultThresholds*.

You can configure various default threshold settings for the same sensor type at a time by combining multiple commands. See **Multi-Command Syntax** (on page 465).

- ▶ **Set the Default Upper Critical Threshold for a specific sensor type:**

```
config:#    defaultThresholds <sensor type> upperCritical <value>
```

- ▶ **Set the Default Upper Warning Threshold for a specific sensor type:**

```
config:#    defaultThresholds <sensor type> upperWarning <value>
```

- ▶ **Set the Default Lower Critical Threshold for a specific sensor type:**

```
config:#    defaultThresholds <sensor type> lowerCritical <value>
```

- ▶ **Set the Default Lower Warning Threshold for a specific sensor type:**

```
config:# defaultThresholds <sensor type> lowerWarning <value>
```

- ▶ **Set the Default Deassertion Hysteresis for a specific sensor type:**

```
config:# defaultThresholds <sensor type> hysteresis <hy_value>
```

- ▶ **Set the Default Assertion Timeout for a specific sensor type:**

```
config:# defaultThresholds <sensor type> assertionTimeout <as_value>
```

*Variables:*

- <sensor type> is one of the following numeric sensor types:

Sensor types	Description
absoluteHumidity	Absolute humidity sensors
relativeHumidity	Relative humidity sensors
temperature	Temperature sensors
airPressure	Air pressure sensors
airFlow	Air flow sensors
vibration	Vibration sensors

- <value> is the value for the specified threshold of the specified sensor type. Note that diverse sensor types use different measurement units.

Sensor types	Measurement units
absoluteHumidity	g/m <sup>3</sup> (that is, g/m³)
relativeHumidity	%
temperature	Degrees Celsius (°C) or Fahrenheit (°F), depending on your measurement unit settings.
airPressure	Pascal (Pa) or psi, depending on your measurement unit settings.
airFlow	m/s
vibration	g

- <hy\_value> is the deassertion hysteresis value applied to the specified sensor type.
- <as\_value> is the assertion timeout value applied to the specified sensor type. It ranges from 0 to 100 (samples).

**Example - Default Upper Thresholds for Temperature**

It is assumed that your preferred measurement unit for temperature is set to degrees Celsius. Then the following command sets the default Upper Warning threshold to 20°C and Upper Critical threshold to 24°C for all temperature sensors.

```
config:# defaultThresholds temperature upperWarning 20
        upperCritical 24
```

---

**Sensor Threshold Configuration Commands**

A sensor configuration command begins with *sensor*. You can use the commands to configure the threshold, hysteresis and assertion timeout values for any sensor associated with the following items:

- Outlets
- Inlets
- Inlet poles (for three-phase PDUs only)
- Overcurrent protectors
- Environmental sensors

It is permitted to assign a new value to the threshold at any time regardless of whether the threshold has been enabled.

**Commands for Outlet Sensors**

A sensor configuration command for outlets begins with *sensor outlet*.

You can configure various outlet sensor threshold settings at a time by combining multiple commands. See **Multi-Command Syntax** (on page 465).

▶ **Set the Upper Critical threshold for an outlet sensor:**

```
config:# sensor outlet <n> <sensor type> upperCritical <option>
```

▶ **Set the Upper Warning threshold for an outlet sensor:**

```
config:# sensor outlet <n> <sensor type> upperWarning <option>
```

▶ **Set the Lower Critical threshold for an outlet sensor:**

```
config:# sensor outlet <n> <sensor type> lowerCritical <option>
```

▶ **Set the Lower Warning threshold for an outlet sensor:**

```
config:# sensor outlet <n> <sensor type> lowerWarning <option>
```

▶ **Set the deassertion hysteresis for an outlet sensor:**

```
config:# sensor outlet <n> <sensor type> hysteresis <hy_value>
```

▶ **Set the assertion timeout for an outlet sensor:**

```
config:# sensor outlet <n> <sensor type> assertionTimeout <as_value>
```

*Variables:*

- <n> is the number of the outlet that you want to configure.
- <sensor type> is one of the following sensor types:

Sensor type	Description
current	Current sensor
voltage	Voltage sensor
activePower	Active power sensor
apparentPower	Apparent power sensor
powerFactor	Power factor sensor
activeEnergy	Active energy sensor
lineFrequency	Line frequency sensor

---

*Note: If the requested sensor type is not supported, the "Sensor is not available" message is displayed.*

---

- <option> is one of the options: *enable*, *disable* or a numeric value.

Option	Description
enable	Enables the specified threshold for a specific outlet sensor.
disable	Disables the specified threshold for a specific outlet sensor.

Option	Description
A numeric value	Sets a value for the specified threshold of a specific outlet sensor and enables this threshold at the same time.

- <hy\_value> is a numeric value that is assigned to the hysteresis for the specified outlet sensor. See **"To De-assert" and Deassertion Hysteresis** (on page 596).
- <as\_value> is a number in samples that is assigned to the assertion timeout for the specified outlet sensor. See **"To Assert" and Assertion Timeout** (on page 594).

### Commands for Inlet Sensors

A sensor configuration command for inlets begins with *sensor inlet*.

You can configure various inlet sensor threshold settings at a time by combining multiple commands. See **Multi-Command Syntax** (on page 465).

▶ **Set the Upper Critical threshold for an inlet sensor:**

```
config:# sensor inlet <n> <sensor type> upperCritical <option>
```

▶ **Set the Upper Warning threshold for an inlet sensor:**

```
config:# sensor inlet <n> <sensor type> upperWarning <option>
```

▶ **Set the Lower Critical threshold for an inlet sensor:**

```
config:# sensor inlet <n> <sensor type> lowerCritical <option>
```

▶ **Set the Lower Warning threshold for an inlet sensor:**

```
config:# sensor inlet <n> <sensor type> lowerWarning <option>
```

▶ **Set the deassertion hysteresis for an inlet sensor:**

```
config:# sensor inlet <n> <sensor type> hysteresis <hy_value>
```

▶ **Set the assertion timeout for an inlet sensor:**

```
config:# sensor inlet <n> <sensor type> assertionTimeout <as_value>
```

*Variables:*

- <n> is the number of the inlet that you want to configure. For a single-inlet PDU, <n> is always the number 1.
- <sensor type> is one of the following sensor types:

Sensor type	Description
current	Current sensor
peakCurrent	Peak current sensor
voltage	Voltage sensor
activePower	Active power sensor
apparentPower	Apparent power sensor
powerFactor	Power factor sensor
activeEnergy	Active energy sensor
unbalancedCurrent	Unbalanced load sensor
lineFrequency	Line frequency sensor
residualCurrent	Residual current sensor
phaseAngle	Inlet phase angle sensor

*Note: If the requested sensor type is not supported, the "Sensor is not available" message is displayed.*

- <option> is one of the options: *enable*, *disable* or a numeric value.

Option	Description
enable	Enables the specified threshold for a specific inlet sensor.
disable	Disables the specified threshold for a specific inlet sensor.
A numeric value	Sets a value for the specified threshold of a specific inlet sensor and enables this threshold at the same time.

- <hy\_value> is a numeric value that is assigned to the hysteresis for the specified inlet sensor. See **"To De-assert" and Deassertion Hysteresis** (on page 596).
- <as\_value> is a numeric value that is assigned to the assertion timeout for the specified inlet sensor. See **"To Assert" and Assertion Timeout** (on page 594).

**Commands for Inlet Pole Sensors**

A sensor configuration command for inlet poles begins with *sensor inletpole*. This type of command is available on a three-phase PDU only.

You can configure various inlet pole sensor threshold settings at a time by combining multiple commands. See **Multi-Command Syntax** (on page 465).

▶ **Set the Upper Critical Threshold for an Inlet Pole:**

```
config:# sensor inletpole <n> <p> <sensor type> upperCritical <option>
```

▶ **Set the Upper Warning Threshold for an Inlet Pole:**

```
config:# sensor inletpole <n> <p> <sensor type> upperWarning <option>
```

▶ **Set the Lower Critical Threshold for an Inlet Pole:**

```
config:# sensor inletpole <n> <p> <sensor type> lowerCritical <option>
```

▶ **Set the Lower Warning Threshold for an Inlet Pole:**

```
config:# sensor inletpole <n> <p> <sensor type> lowerWarning <option>
```

▶ **Set the Inlet Pole's Deassertion Hysteresis:**

```
config:# sensor inletpole <n> <p> <sensor type> hysteresis <hy_value>
```

▶ **Set the Inlet Pole's Assertion Timeout:**

```
config:# sensor inletpole <n> <p> <sensor type> assertionTimeout <as_value>
```

*Variables:*

- <n> is the number of the inlet whose pole sensors you want to configure.
- <p> is the label of the inlet pole that you want to configure.

Pole	Label <p>	Current sensor	Voltage sensor
1	L1	L1	L1 - L2
2	L2	L2	L2 - L3
3	L3	L3	L3 - L1

- <sensor type> is one of the following sensor types:

Sensor type	Description
current	Current sensor
voltage	Voltage sensor
activePower	Active power sensor
apparentPower	Apparent power sensor
powerFactor	Power factor sensor
activeEnergy	Active energy sensor
unbalancedCurrent	Unbalanced load sensor

*Note: If the requested sensor type is not supported, the "Sensor is not available" message is displayed.*

- <option> is one of the options: *enable*, *disable* or a numeric value.

Option	Description
enable	Enables the specified threshold for the specified inlet pole sensor.
disable	Disables the specified threshold for the specified inlet pole sensor.
A numeric value	Sets a value for the specified threshold of the specified inlet pole sensor and enables this threshold at the same time.

- <hy\_value> is a numeric value that is assigned to the hysteresis for the specified inlet pole sensor. See **"To De-assert" and Deassertion Hysteresis** (on page 596).
- <as\_value> is a number in samples that is assigned to the assertion timeout for the specified inlet pole sensor. See **"To Assert" and Assertion Timeout** (on page 594).

#### Commands for Overcurrent Protector Sensors

A sensor configuration command for overcurrent protectors begins with *sensor ocp*.

You can configure various overcurrent protector threshold settings at a time by combining multiple commands. See **Multi-Command Syntax** (on page 465).

- ▶ **Set the Upper Critical threshold for an overcurrent protector:**



```
config:# sensor ocp <n> <sensor type> upperCritical <option>
```

▶ **Set the Upper Warning threshold for an overcurrent protector:**

```
config:# sensor ocp <n> <sensor type> upperWarning <option>
```

▶ **Set the Lower Critical threshold for an overcurrent protector:**

```
config:# sensor ocp <n> <sensor type> lowerCritical <option>
```

▶ **Set the Lower Warning threshold for an overcurrent protector:**

```
config:# sensor ocp <n> <sensor type> lowerWarning <option>
```

▶ **Set the deassertion hysteresis for an overcurrent protector:**

```
config:# sensor ocp <n> <sensor type> hysteresis <hy_value>
```

▶ **Set the assertion timeout for an overcurrent protector:**

```
config:# sensor ocp <n> <sensor type> assertionTimeout <as_value>
```

*Variables:*

- <n> is the number of the overcurrent protector that you want to configure.
- <sensor type> is one of the following sensor types:

Sensor type	Description
current	Current sensor

*Note: If the requested sensor type is not supported, the "Sensor is not available" message is displayed.*

- <option> is one of the options: *enable*, *disable* or a numeric value.

Option	Description
enable	Enables the specified threshold for the overcurrent protector sensor.

Option	Description
disable	Disables the specified threshold for the overcurrent protector sensor.
A numeric value	Sets a value for the specified threshold of the overcurrent protector sensor and enables this threshold at the same time.

- <hy\_value> is a numeric value that is assigned to the hysteresis for the specified overcurrent protector sensor. See **"To De-assert" and Deassertion Hysteresis** (on page 596).
- <as\_value> is a number in samples that is assigned to the assertion timeout for the specified overcurrent protector sensor. See **"To Assert" and Assertion Timeout** (on page 594).

### Commands for Environmental Sensors

A sensor threshold configuration command for environmental sensors begins with *sensor externalsensor*.

You can configure various environmental sensor threshold settings at a time by combining multiple commands. See **Multi-Command Syntax** (on page 465).

▶ **Set the Upper Critical threshold for an environmental sensor:**

```
config:# sensor externalsensor <n> <sensor type> upperCritical <option>
```

▶ **Set the Upper Warning threshold for an environmental sensor:**

```
config:# sensor externalsensor <n> <sensor type> upperWarning <option>
```

▶ **Set the Lower Critical threshold for an environmental sensor:**

```
config:# sensor externalsensor <n> <sensor type> lowerCritical <option>
```

▶ **Set the Lower Warning threshold for an environmental sensor:**

```
config:# sensor externalsensor <n> <sensor type> lowerWarning <option>
```

▶ **Set the deassertion hysteresis for an environmental sensor:**

```
config:# sensor externalsensor <n> <sensor type> hysteresis <hy_value>
```

► **Set the assertion timeout for an environmental sensor:**

```
config:# sensor externalsensor <n> <sensor type> assertionTimeout <as_value>
```

*Variables:*

- <n> is the ID number of the environmental sensor that you want to configure. The ID number is available in the PX web interface or using the command "show externalsensors <n>" in the CLI. It is an integer between 1 and 32.
- <sensor type> is one of these sensor types: *temperature*, *absoluteHumidity*, *relativeHumidity*, *airPressure*, *airFlow* or *vibration*.

---

*Note: If the specified sensor type does not match the type of the specified environmental sensor, this error message appears: "Specified sensor type 'XXX' does not match the sensor's type (<sensortype>)," where XXX is the specified sensor type, and <sensortype> is the correct sensor type.*

---

- <option> is one of the options: *enable*, *disable* or a numeric value.

Option	Description
enable	Enables the specified threshold for a specific environmental sensor.
disable	Disables the specified threshold for a specific environmental sensor.
A numeric value	Sets a value for the specified threshold of a specific environmental sensor and enables this threshold at the same time.

- <hy\_value> is a numeric value that is assigned to the hysteresis for the specified environmental sensor. See **"To De-assert" and Deassertion Hysteresis** (on page 596).
- <as\_value> is a number in samples that is assigned to the assertion timeout for the specified environmental sensor. It ranges between 1 and 100. See **"To Assert" and Assertion Timeout** (on page 594).

**Examples**

This section illustrates several environmental sensor threshold configuration examples.

**Example 2 - Warning Thresholds for Inlet Sensors**

The following command sets both the Upper Warning and Lower Warning thresholds for the inlet 1 RMS current.

```
config:# sensor inlet 1 current upperWarning 20 lowerWarning 12
```

*Results:*

- The Upper Warning threshold for the inlet 1 RMS current is set to 20A. It also enables the upper warning threshold if this threshold has not been enabled yet.
- The Lower Warning threshold for the inlet 1 RMS current is set to 12A. It also enables the lower warning threshold if this threshold has not been enabled yet.

**Example 1 - Upper Critical Threshold for a Temperature Sensor**

The following command sets the Upper Critical threshold of the environmental "temperature" sensor with the ID number 2 to 40 degrees Celsius. It also enables the upper critical threshold if this threshold has not been enabled yet.

```
config:# sensor externalsensor 2 temperature upperCritical 40
```

**Example 3 - Upper Thresholds for Overcurrent Protector Sensors**

The following command sets both the Upper Critical and Upper Warning thresholds for the 2nd overcurrent protector.

```
config:# sensor ocp 2 current upperWarning enable upperCritical 16
```

*Results:*

- The Upper Critical threshold for the 2nd overcurrent protector's RMS current is set to 16A. It also enables the upper critical threshold if this threshold has not been enabled yet.
- The Upper Warning threshold for the 2nd overcurrent protector's RMS current is enabled.

---

## Actuator Configuration Commands

An actuator configuration command begins with *actuator*. You can configure the name and location parameters of an individual actuator.

You can configure various parameters for one actuator at a time. See **Multi-Command Syntax** (on page 465).

► **Change the name:**

```
config:# actuator <n> name "<name>"
```

► **Set the X coordinate:**

```
config:# actuator <n> xlabel "<coordinate>"
```

► **Set the Y coordinate:**

```
config:# actuator <n> ylabel "<coordinate>"
```

► **Set the Z coordinate:**

```
config:# actuator <n> zlabel "<z_label>"
```

► **Modify the actuator's description:**

```
config:# actuator <n> description "<description>"
```

### Variables:

- <n> is the ID number assigned to the actuator. The ID number can be found using the PX web interface or CLI. It is an integer starting at 1.
- <name> is a string comprising up to 32 ASCII printable characters. The <name> variable must be enclosed in quotes when it contains spaces.
- <coordinate> is a string comprising up to 24 ASCII printable characters, and it must be enclosed in quotes.
- There are two types of values for the <z\_label> variable, depending on the Z coordinate format you set:

Type	Description
Free form	<coordinate> is a string comprising up to 24 ASCII printable characters, and it must be enclosed in quotes.
Rack units	<coordinate> is an integer number in rack units.

---

*Note: To specify the Z coordinate using the rack units, see **Setting the Z Coordinate Format for Environmental Sensors** (on page 362).*

---

- <description> is a sentence or paragraph comprising up to 64 ASCII printable characters, and it must be enclosed in quotes.

**Example - Actuator Naming**

The following command assigns the name "Door lock" to the actuator whose ID number is 9.

```
config:# actuator 9 name "Door lock"
```

---

**Server Reachability Configuration Commands**

You can use the CLI to add or delete an IT device, such as a server, from the server reachability list, or modify the settings for a monitored IT device. A server reachability configuration command begins with *serverReachability*.

**Adding a Monitored Device**

This command adds a new IT device to the server reachability list.

```
config:# serverReachability add <IP_host> <enable> <succ_ping>
<fail_ping> <succ_wait> <fail_wait> <resume> <disable_count>
```

*Variables:*

- <IP\_host> is the IP address or host name of the IT device that you want to add.
- <enable> is one of the options: *true* or *false*.

Option	Description
true	Enables the ping monitoring feature for the newly added device.
false	Disables the ping monitoring feature for the newly added device.

- <succ\_ping> is the number of successful pings for declaring the monitored device "Reachable." Valid range is 0 to 200.
- <fail\_ping> is the number of consecutive unsuccessful pings for declaring the monitored device "Unreachable." Valid range is 1 to 100.
- <succ\_wait> is the wait time to send the next ping after a successful ping. Valid range is 5 to 600 (seconds).
- <fail\_wait> is the wait time to send the next ping after a unsuccessful ping. Valid range is 3 to 600 (seconds).
- <resume> is the wait time before the PX resumes pinging after declaring the monitored device "Unreachable." Valid range is 5 to 120 (seconds).
- <disable\_count> is the number of consecutive "Unreachable" declarations before the PX disables the ping monitoring feature for the monitored device and returns to the "Waiting for reliable connection" state. Valid range is 1 to 100 or *unlimited*.

### Deleting a Monitored Device

This command removes a monitored IT device from the server reachability list.

```
config:# serverReachability delete <n>
```

*Variables:*

- <n> is a number representing the sequence of the IT device in the monitored server list.

You can find each IT device's sequence number using the CLI command of `show serverReachability` as illustrated below.

#	IP address	Enabled	Status
1	192.168.84.126	Yes	Waiting for reliable connection
2	www.raritan.com	Yes	Waiting for reliable connection

### Modifying a Monitored Device's Settings

The command to modify a monitored IT device's settings begins with `serverReachability modify`.

You can modify various settings for a monitored device at a time. See **Multi-Command Syntax** (on page 465).

- ▶ **Modify a device's IP address or host name:**

```
config:# serverReachability modify <n> ipAddress <IP_host>
```

- ▶ **Enable or disable the ping monitoring feature for the device:**

```
config:# serverReachability modify <n> pingMonitoringEnabled <option>
```

- ▶ **Modify the number of successful pings for declaring "Reachable":**

```
config:# serverReachability modify <n> numberOfSuccessfulPingsToEnable  
<succ_number>
```

- ▶ **Modify the number of unsuccessful pings for declaring "Unreachable":**

```
config:# serverReachability modify <n> numberOfUnsuccessfulPingsForFailure  
<fail_number>
```

- ▶ **Modify the wait time after a successful ping:**

```
config:# serverReachability modify <n> waitTimeAfterSuccessfulPing  
<succ_wait>
```

- ▶ **Modify the wait time after a unsuccessful ping:**

```
config:# serverReachability modify <n> waitTimeAfterUnsuccessfulPing  
<fail_wait>
```

- ▶ **Modify the wait time before resuming ping after declaring "Unreachable":**

```
config:# serverReachability modify <n> waitTimeBeforeResumingPinging  
<resume>
```

- ▶ **Modify the number of consecutive "Unreachable" declarations before disabling the ping monitoring feature:**



```
config:# serverReachability modify <n> numberOfFailuresToDisable
        <disable_count>
```

*Variables:*

- <n> is a number representing the sequence of the IT device in the server monitoring list.
- <IP\_host> is the IP address or host name of the IT device whose settings you want to modify.
- <option> is one of the options: *true* or *false*.

Option	Description
true	Enables the ping monitoring feature for the monitored device.
false	Disables the ping monitoring feature for the monitored device.

- <succ\_number> is the number of successful pings for declaring the monitored device "Reachable." Valid range is 0 to 200.
- <fail\_number> is the number of consecutive unsuccessful pings for declaring the monitored device "Unreachable." Valid range is 1 to 100.
- <succ\_wait> is the wait time to send the next ping after a successful ping. Valid range is 5 to 600 (seconds).
- <fail\_wait> is the wait time to send the next ping after a unsuccessful ping. Valid range is 3 to 600 (seconds).
- <resume> is the wait time before the PX resumes pinging after declaring the monitored device "Unreachable." Valid range is 5 to 120 (seconds).
- <disable\_count> is the number of consecutive "Unreachable" declarations before the PX disables the ping monitoring feature for the monitored device and returns to the "Waiting for reliable connection" state. Valid range is 1 to 100 or *unlimited*.

**Example - Server Settings Changed**

The following command modifies several ping monitoring settings for the second server in the server reachability list.

```
config:# serverReachability modify 2 numberOfSuccessfulPingsToEnable 10
        numberOfUnsuccessfulPingsForFailure 8
        waitTimeAfterSuccessfulPing 30
```

---

## EnergyWise Configuration Commands

An EnergyWise configuration command begins with *energywise*.

### Enabling or Disabling EnergyWise

This command syntax determines whether the Cisco® EnergyWise endpoint implemented on the PX device is enabled.

```
config:# energywise enabled <option>
```

*Variables:*

- <option> is one of the options: *true* or *false*.

Option	Description
true	The Cisco EnergyWise feature is enabled.
false	The Cisco EnergyWise feature is disabled.

### Specifying the EnergyWise Domain

This command syntax specifies to which Cisco® EnergyWise domain the PX device belongs.

```
config:# energywise domain <name>
```

*Variables:*

- <name> is a string comprising up to 127 ASCII printable characters. Spaces and asterisks are NOT acceptable.

**Specifying the EnergyWise Secret**

This command syntax specifies the password (secret) to enter the Cisco® EnergyWise domain.

```
config:# energywise secret <password>
```

*Variables:*

- <password> is a string comprising up to 127 ASCII printable characters. Spaces and asterisks are NOT acceptable.

**Changing the UDP Port**

This command syntax specifies the UDP port for communications in the Cisco® EnergyWise domain.

```
config:# energywise port <port>
```

*Variables:*

- <port> is the UDP port number ranging between 1 and 65535.

**Setting the Polling Interval**

This command syntax determines the polling interval at which the Cisco® EnergyWise domain queries the PX device.

```
config:# energywise polling <timing>
```

*Variables:*

- <timing> is an integer number in seconds. It ranges between 30 and 600 seconds.

### Example - Setting Up EnergyWise

The following command sets up two Cisco® EnergyWise-related features.

```
config:# energywise enabled true port 10288
```

*Results:*

- The EnergyWise feature implemented on the PX is enabled.
- The UDP port is set to 10288.

---

### USB-Cascading Configuration Commands

A USB-cascading configuration command begins with *cascading*. You can set the cascading mode on the master device.

---

*Note: You CANNOT change the cascading mode on slave devices.*

---

### Configuring the Cascading Mode

This command determines the cascading mode.

```
config:# cascading mode <mode>
```

*Variables:*

- <mode> is one of the following cascading modes:

Mode	Description
bridging	The network bridging mode, where each cascaded device is assigned a unique IP address.
portForwarding	The port forwarding mode, where every cascaded device in the chain shares the same IP address, with diverse port numbers assigned.

---

### Asset Management Commands

You can use the CLI commands to change the settings of the connected asset sensor (if any) or the settings of LEDs on the asset sensor.

**Asset Sensor Management**

An asset sensor management configuration command begins with `assetStrip`.

***Naming an Asset Sensor***

This command syntax names or changes the name of an asset sensor connected to the PX device.

```
config:#  assetStrip <n> name "<name>"
```

*Variables:*

- <n> is the number of the FEATURE port where the selected asset sensor is physically connected. For the PX device with only one FEATURE port, the number is always 1.
- <name> is a string comprising up to 32 ASCII printable characters. The <name> variable must be enclosed in quotes when it contains spaces.

***Specifying the Number of Rack Units***

This command syntax specifies the total number of rack units on an asset sensor connected to the PX device.

```
config:#  assetStrip <n> numberOfRackUnits <number>
```

---

*Note:* For the Raritan asset sensor, a rack unit refers to a tag port.

---

*Variables:*

- <n> is the number of the FEATURE port where the selected asset sensor is physically connected. For the PX device with only one FEATURE port, the number is always 1.
- <number> is the total number of rack units available on the connected asset sensor. This value ranges from 8 to 64.

**Specifying the Rack Unit Numbering Mode**

This command syntax specifies the numbering mode of rack units on the asset sensors connected to the PX device. The numbering mode changes the rack unit numbers.

```
config:#    assetStrip <n> rackUnitNumberingMode <mode>
```

Variables:

- <n> is the number of the FEATURE port where the selected asset sensor is physically connected. For the PX device with only one FEATURE port, the number is always 1.
- <mode> is one of the numbering modes: *topDown* or *bottomUp*.

Mode	Description
topDown	The rack units are numbered in the ascending order from the highest to the lowest rack unit.
bottomUp	The rack units are numbered in the descending order from the highest to the lowest rack unit.

**Specifying the Rack Unit Numbering Offset**

This command syntax specifies the starting number of rack units on the asset sensors connected to the PX device.

```
config:#    assetStrip <n> rackUnitNumberingOffset <number>
```

Variables:

- <n> is the number of the FEATURE port where the selected asset sensor is physically connected. For the PX device with only one FEATURE port, the number is always 1.
- <number> is a starting number for numbering rack units on the connected asset sensor. This value is an integer number.

**Specifying the Asset Sensor Orientation**

This command syntax specifies the orientation of the asset sensors connected to the PX device. Usually you do not need to perform this command unless your asset sensors do NOT come with the tilt sensor, causing the PX unable to detect the asset sensors' orientation.

```
config:#  assetStrip <n> assetStripOrientation <orientation>
```

*Variables:*

- <n> is the number of the FEATURE port where the selected asset sensor is physically connected. For the PX device with only one FEATURE port, the number is always 1.
- <orientation> is one of the options: *topConnector* or *bottomConnector*.

Orientation	Description
topConnector	This option indicates that the asset sensor is mounted with the RJ-45 connector located on the top.
bottomConnector	This option indicates that the asset sensor is mounted with the RJ-45 connector located at the bottom.

**Setting LED Colors for Connected Tags**

This command syntax sets the LED color for all rack units on the asset sensor #1 to indicate the presence of a connected asset tag.

```
config:#  assetStrip <n> LEDColorForConnectedTags <color>
```

*Variables:*

- <color> is the hexadecimal RGB value of a color in HTML format. The <color> variable ranges from #000000 to #FFFFFF.

### **Setting LED Colors for Disconnected Tags**

This command syntax sets the LED color for all rack units on the connected asset sensor(s) to indicate the absence of a connected asset tag.

```
config:#    assetStrip <n> LEDColorForDisconnectedTags <color>
```

*Variables:*

- <color> is the hexadecimal RGB value of a color in HTML format. The <color> variable ranges from #000000 to #FFFFFF.

### **Rack Unit Configuration**

For the Raritan asset sensor, a rack unit refers to a tag port. A rack unit configuration command begins with `rackUnit`.

#### ***Naming a Rack Unit***

This command syntax assigns or changes the name of the specified rack unit on the specified asset sensor.

```
config:#    rackUnit <n> <rack_unit> name "<name>"
```

*Variables:*

- <n> is the number of the FEATURE port where the selected asset sensor is physically connected. For the PX device with only one FEATURE port, the number is always 1.
- <rack\_unit> is the index number of the desired rack unit. The index number of each rack unit is available on the Asset Strip page of the web interface.
- <name> is a string comprising up to 32 ASCII printable characters. The <name> variable must be enclosed in quotes when it contains spaces.



**Setting the LED Operation Mode**

This command syntax determines whether a specific rack unit on the specified asset sensor follows the global LED color settings.

```
config:#    rackUnit <n> <rack_unit> LEDOperationMode <mode>
```

*Variables:*

- <n> is the number of the FEATURE port where the selected asset sensor is physically connected. For the PX device with only one FEATURE port, the number is always 1.
- <rack\_unit> is the index number of the desired rack unit. The index number of each rack unit is available on the Asset Strip page of the web interface.
- <mode> is one of the LED modes: *automatic* or *manual*.

Mode	Description
automatic	This option makes the LED of the specified rack unit follow the global LED color settings. See <b>Setting LED Colors for Connected Tags</b> (on page 459) and <b>Setting LED Colors for Disconnected Tags</b> (on page 460). This is the default.
manual	This option enables selection of a different LED color and LED mode for the specified rack unit. When this option is selected, see <b>Setting an LED Color for a Rack Unit</b> (on page 462) and <b>Setting an LED Mode for a Rack Unit</b> (on page 462) to set different LED settings.

**Setting an LED Color for a Rack Unit**

This command syntax sets the LED color for a specific rack unit on the specified asset sensor. You need to set a rack unit's LED color only when the LED operation mode of this rack unit has been set to "manual."

```
config:#   rackUnit <n> <rack_unit> LEDColor <color>
```

*Variables:*

- <n> is the number of the FEATURE port where the selected asset sensor is physically connected. For the PX device with only one FEATURE port, the number is always 1.
- <rack\_unit> is the index number of the desired rack unit. The index number of each rack unit is available on the Asset Strip page of the web interface.
- <color> is the hexadecimal RGB value of a color in HTML format. The <color> variable ranges from #000000 to #FFFFFF.

---

*Note: A rack unit's LED color setting overrides the global LED color setting on it. See **Setting LED Colors for Connected Tags** (on page 459) and **Setting LED Colors for Disconnected Tags** (on page 460).*

---

**Setting an LED Mode for a Rack Unit**

This command syntax sets the LED mode for a specific rack unit on the specified asset sensor. You need to set a rack unit's LED mode only when the LED operation mode of this rack unit has been set to "manual."

```
config:#   rackUnit <n> <rack_unit> LEDMode <mode>
```

*Variables:*

- <n> is the number of the FEATURE port where the selected asset sensor is physically connected. For the PX device with only one FEATURE port, the number is always 1.
- <rack\_unit> is the index number of the desired rack unit. The index number of each rack unit is available on the Asset Strip page of the web interface.
- <mode> is one of the LED modes: *on*, *off*, *blinkSlow* or *blinkFast*.

Mode	Description
on	This mode has the LED stay lit permanently.
off	This mode has the LED stay off permanently.
blinkSlow	This mode has the LED blink slowly.

Mode	Description
blinkFast	This mode has the LED blink quickly.

### Examples

This section illustrates several asset management examples.

#### **Example 1 - Asset Sensor LED Colors for Disconnected Tags**

This command syntax sets the LED color for all rack units on the asset sensor #1 to BLACK (that is, 000000) to indicate the absence of a connected asset tag.

```
config:#    assetStrip 1 LEDColorForDisconnectedTags #000000
```

---

*Note: Black color causes the LEDs to stay off.*

---

#### **Example 2 - Rack Unit Naming**

The following command assigns the name "Linux server" to the rack unit whose index number is 25 on the asset sensor#1.

```
config:#    rackUnit 1 25 name "Linux server"
```

---

### Serial Port Configuration Commands

A serial port configuration command begins with *serial*.

### Setting the Serial Port Baud Rate

The following command syntax sets the CONSOLE baud rate (bps) of the serial port labeled CONSOLE / MODEM on the PX device. Change the CONSOLE baud rate before connecting it to any Raritan device, such as Raritan's P2CIM-SER, through the serial port, or there are communications errors. If you change the baud rate dynamically after the connection has been made, you must reset the PX or power cycle the connected Raritan device for proper communications.

```
config:#    serial baudRate <baud_rate>
```

*Variables:*

- <baud\_rate> is one of the CONSOLE baud rate options: 1200, 2400, 4800, 9600, 19200, 38400, 57600, 115200.

---

*Note: The serial port bit-rate change is needed when the PX works in conjunction with Raritan's Dominion LX KVM switch. The Dominion LX only supports 19200 bps for communications over the serial interface.*

---

### Example

The following command sets the baud rate of the PX device's serial port to 9600 bps.

```
config:#    serial baudRate 9600
```

---

### Setting the History Buffer Length

This command syntax sets the history buffer length, which determines the amount of history commands that can be retained in the buffer. The default length is 25.

```
config:#    history length <n>
```

*Variables:*

- <n> is an integer number between 1 and 250.

---

### Multi-Command Syntax

To shorten the configuration time, you can combine various configuration commands in one command to perform all of them at a time. All combined commands must belong to the same configuration type, such as commands prefixed with *network*, *user modify*, *sensor externalsensor* and so on.

A multi-command syntax looks like this:

```
<configuration type> <setting 1> <value 1> <setting 2>
<value 2> <setting 3> <value 3> ...
```

#### Example 1 - Combination of IP, Subnet Mask and Gateway Parameters

The following multi-command syntax configures IPv4 address, subnet mask and gateway for the network connectivity simultaneously.

```
config:# network ipv4 ipAddress 192.168.84.225 subnetMask 255.255.255.0
gateway 192.168.84.0
```

*Results:*

- The IP address is set to 192.168.84.225.
- The subnet mask is set to 255.255.255.0.
- The gateway is set to 192.168.84.0.

#### Example 2 - Combination of Upper Critical and Upper Warning Settings

The following multi-command syntax simultaneously configures Upper Critical and Upper Warning thresholds for the RMS current of the 2nd overcurrent protector.

```
config:# sensor ocp 2 current upperCritical disable upperWarning 15
```

*Results:*

- The Upper Critical threshold of the 2nd overcurrent protector's RMS current is disabled.
- The Upper Warning threshold of the 2nd overcurrent protector's RMS current is set to 15A and enabled at the same time.

### Example 3 - Combination of SSID and PSK Parameters

This multi-command syntax configures both SSID and PSK parameters simultaneously for the wireless feature.

```
config:# network wireless SSID myssid PSK encryp_key
```

*Results:*

- The SSID value is set to myssid.
- The PSK value is set to encryp\_key.

### Example 4 - Combination of Upper Critical, Upper Warning and Lower Warning Settings

The following multi-command syntax configures Upper Critical, Upper Warning and Lower Warning thresholds for the outlet 5 RMS current simultaneously.

```
config:# sensor outlet 5 current upperCritical disable upperWarning enable  
lowerWarning 1.0
```

*Results:*

- The Upper Critical threshold of outlet 5 RMS current is disabled.
- The Upper Warning threshold of outlet 5 RMS current is enabled.
- The Lower Warning threshold of outlet 5 RMS current is set to 1.0A and enabled at the same time.

---

## Load Shedding Configuration Commands

This section applies to outlet-switching capable models only.

A load shedding configuration command begins with *loadshedding*.

Unlike other CLI configuration commands, the load shedding configuration command is performed in the *administrator mode* rather than the configuration mode. See ***Different CLI Modes and Prompts*** (on page 321).

---

## Enabling or Disabling Load Shedding

This section applies to outlet-switching capable models only.

This command determines whether to enter or exit from the load shedding mode.

```
#          loadshedding <option>
```

After performing the above command, PX prompts you to confirm the operation. Press *y* to confirm or *n* to abort the operation.

To skip the confirmation step, you can add the */y* parameter to the end of the command so that the operation is executed immediately.

```
#          loadshedding <option> /y
```

*Variables:*

- *<option>* is one of the options: *enable* or *disable*.

Option	Description
start	Enter the load shedding mode.
stop	Quit the load shedding mode.

### Example

The following command has the PX enter the load shedding mode.

```
config:#  loadshedding start
```

## Power Control Operations

This section applies to outlet-switching capable models only.

Outlets on the PX device can be turned on or off or power cycled through the CLI.

Besides, you can cancel the power-on process while the PX is powering on ALL outlets.

You must perform this operation in the *administrator mode*. See ***Different CLI Modes and Prompts*** (on page 321).

### Turning On the Outlet(s)

This section applies to outlet-switching capable models only.

This command turns on one or multiple outlets.

```
# power outlets <numbers> on
```

To quicken the operation, you can add the parameter "/y" to the end of the command, which confirms the operation.

```
# power outlets <numbers> on /y
```

*Variables:*

- <numbers> is one of the options: *all*, an outlet number, a list or a range of outlets.

Option	Description
all	Switches ON all outlets.
A specific outlet number	Switches ON the specified outlet.
A comma-separated list of outlets	Switches ON multiple, inconsecutive or consecutive outlets. For example, to specify 7 outlets -- 2, 4, 9, 11, 12, 13 and 15, type <code>outlets 2,4,9,11-13,15</code> .
A range of outlets with an en dash in between	Switches ON multiple, consecutive outlets. For example, to specify 6 consecutive outlets -- 3, 4, 5, 6, 7, 8, type <code>outlets 3-8</code> .



If you entered the command without `/y`, a message appears, prompting you to confirm the operation. Then:

- Type `y` to confirm the operation, OR
- Type `n` to abort the operation

---

### Turning Off the Outlet(s)

This section applies to outlet-switching capable models only.

This command turns off one or multiple outlets.

```
#          power outlets <numbers> off
```

To quicken the operation, you can add the parameter `/y` to the end of the command, which confirms the operation.

```
#          power outlets <numbers> off /y
```

*Variables:*

- `<numbers>` is one of the options: *all*, an outlet number, a list or a range of outlets.

Option	Description
all	Switches OFF all outlets.
A specific outlet number	Switches OFF the specified outlet.
A comma-separated list of outlets	Switches OFF multiple, inconsecutive or consecutive outlets. For example, to specify 7 outlets -- 2, 4, 9, 11, 12, 13 and 15, type <code>outlets 2,4,9,11-13,15</code> .
A range of outlets with an en dash in between	Switches OFF multiple, consecutive outlets. For example, to specify 6 consecutive outlets -- 3, 4, 5, 6, 7, 8, type <code>outlets 3-8</code> .

If you entered the command without `/y`, a message appears, prompting you to confirm the operation. Then:

- Type `y` to confirm the operation, OR

- Type `n` to abort the operation

---

### Power Cycling the Outlet(s)

This section applies to outlet-switching capable models only.

This command power cycles one or multiple outlets.

```
# power outlets <numbers> cycle
```

To quicken the operation, you can add the parameter `/y` to the end of the command, which confirms the operation.

```
# power outlets <numbers> cycle /y
```

*Variables:*

- `<numbers>` is one of the options: *all*, an outlet number, a list or a range of outlets.

Option	Description
all	Power cycles all outlets.
A specific outlet number	Power cycles the specified outlet.
A comma-separated list of outlets	Power cycles multiple, inconsecutive or consecutive outlets. For example, to specify 7 outlets -- 2, 4, 9, 11, 12, 13 and 15, type <code>outlets 2,4,9,11-13,15</code> .
A range of outlets with an en dash in between	Power cycles multiple, consecutive outlets. For example, to specify 6 consecutive outlets -- 3, 4, 5, 6, 7, 8, type <code>outlets 3-8</code> .

If you entered the command without `/y`, a message appears, prompting you to confirm the operation. Then:

- Type `y` to confirm the operation, OR
- Type `n` to abort the operation

---

### Canceling the Power-On Process

This section applies to outlet-switching capable models only.

After issuing the command to power on ALL outlets, you can use the following command to stop the power-on process.

```
# power cancelSequence
```

To quicken the operation, you can add the parameter "/y" to the end of the command, which confirms the operation.

```
# power cancelSequence /y
```

---

### Example - Power Cycling Specific Outlets

The following command power cycles these outlets: 2, 6, 7, 8, 10, 13, 14, 15 and 16.

```
# power outlets 2,6-8,10,13-16 cycle
```

---

## Checking the Accessibility of NTP Servers

This command verifies the accessibility of NTP servers specified manually on your PX and then shows the result. For instructions on specifying NTP servers via CLI, see **Setting NTP Parameters** (on page 388).

To perform this command successfully, you must:

- Own the "Change Date/Time Settings" permission.
- Customize NTP servers. See **Setting NTP Parameters** (on page 388).
- Make the customized NTP servers override the DHCP-assigned ones. See **Overriding DHCP-Assigned NTP Servers** (on page 389).

This command is available either in the administrator/user mode or in the configuration mode. See **Different CLI Modes and Prompts** (on page 321).

▶ **In the administrator/user mode:**

```
#          check ntp
```

▶ **In the configuration mode:**

```
config#   check ntp
```

---

## Actuator Control Operations

An actuator, which is connected to a dry contact signal channel of a DX sensor, can control a mechanism or system. You can switch on or off that mechanism or system through the actuator control command in the CLI.

Perform these commands in the administrator or user mode. See **Different CLI Modes and Prompts** (on page 321).

---

### Switching On an Actuator

This command syntax turns on one actuator.

```
# control actuator <n> on
```

To quicken the operation, you can add the parameter `/y` to the end of the command, which confirms the operation.

```
# control actuator <n> on /y
```

#### *Variables:*

- `<n>` is an actuator's ID number.  
The ID number is available in the PX web interface or using the `show` command in the CLI. It is an integer between 1 and 32.

If you entered the command without `/y`, a message appears, prompting you to confirm the operation. Then:

- Type `y` to confirm the operation, OR
- Type `n` to abort the operation

---

### Switching Off an Actuator

This command syntax turns off one actuator.

```
# control actuator <n> off
```

To quicken the operation, you can add the parameter `/y` to the end of the command, which confirms the operation.

```
# control actuator <n> off /y
```

#### *Variables:*

- `<n>` is an actuator's ID number.  
The ID number is available in the PX web interface or using the `show` command in the CLI. It is an integer between 1 and 32.

If you entered the command without `/y`, a message appears, prompting you to confirm the operation. Then:

- Type `y` to confirm the operation, OR
- Type `n` to abort the operation

---

### Example - Turning On a Specific Actuator

The following command turns on the actuator whose ID number is 8.

```
# control actuator 8 on
```

---

## Unlocking a User

If any user is blocked from accessing the PX, you can unblock them at the local console.

► **To unblock a user:**

1. Log in to the CLI interface using any terminal program via a local connection. See ***With HyperTerminal*** (on page 318).
2. When the Username prompt appears, type `unlock` and press Enter.

```
Username: unlock
```

3. When the "Username to unblock" prompt appears, type the name of the blocked user and press Enter.

```
Username to unblock:
```

4. A message appears, indicating that the specified user was unblocked successfully.

---

## Resetting the PX

You can reset the PX device to factory defaults or simply restart it using the CLI commands.

---

## Restarting the PDU

This command restarts the PX device. It is not a factory default reset.

► **To restart the PX device:**

1. Ensure you have entered administrator mode and the # prompt is displayed.
2. Type either of the following commands to restart the PX device.

```
# reset unit
-- OR --
# reset unit /y
```
3. If you entered the command without "/y" in Step 2, a message appears prompting you to confirm the operation. Type y to confirm the reset.
4. Wait until the Username prompt appears, indicating the reset is complete.

---

*Note: If you are performing this command over a USB connection, re-connect the USB cable after the reset is completed, or the CLI communications are lost.*

---

---

## Resetting Active Energy Readings

You can reset either one active energy sensor or all active energy sensors at a time to restart the energy accumulation process.

Only users with the "Admin" role assigned can reset active energy readings.

► **To reset all active energy readings of the PX:**

```
# reset activeEnergy pdu
-- OR --
# reset activeEnergy pdu /y
```

► **To reset one inlet's active energy readings:**

```
# reset activeEnergy inlet <n>
-- OR --
# reset activeEnergy inlet <n> /y
```

► **To reset one outlet's active energy readings:**

```
# reset activeEnergy outlet <outlet_n>
-- OR --
```

```
# reset activeEnergy outlet <outlet_n> /y
```

If you entered the command without "/y", a message appears prompting you to confirm the operation. Type y to confirm the reset or n to abort it.

*Variables:*

- <n> is the inlet number.
- <outlet\_n> is an outlet number.

---

### Resetting to Factory Defaults

The following commands restore all settings of the PX device to factory defaults.

► **To reset PX settings after login, use either command:**

```
# reset factorydefaults
-- OR --
# reset factorydefaults /y
```

► **To reset PX settings before login:**

```
Username: factorydefaults
```

See *Using the CLI Command* (on page 524) for details.

---

## Network Troubleshooting

The PX provides 4 diagnostic commands for troubleshooting network problems: *nslookup*, *netstat*, *ping*, and *traceroute*. The diagnostic commands function as corresponding Linux commands and can get corresponding Linux outputs.

---

### Entering Diagnostic Mode

Diagnostic commands function in the diagnostic mode only.

► **To enter the diagnostic mode:**

1. Enter either of the following modes:
  - Administrator mode: The # prompt is displayed.
  - User mode: The > prompt is displayed.
2. Type `diag` and press Enter. The `diag#` or `diag>` prompt appears, indicating that you have entered the diagnostic mode.
3. Now you can type any diagnostic commands for troubleshooting.



---

## Quitting Diagnostic Mode

► **To quit the diagnostic mode, use this command:**

```
diag>      exit
```

The # or > prompt appears after pressing Enter, indicating that you have entered the administrator or user mode. See **Different CLI Modes and Prompts** (on page 321).

---

## Diagnostic Commands

The diagnostic command syntax varies from command to command.

### Querying DNS Servers

This command syntax queries Internet domain name server (DNS) information of a network host.

```
diag>      nslookup <host>
```

*Variables:*

- <host> is the name or IP address of the host whose DNS information you want to query.

### Showing Network Connections

This command syntax displays network connections and/or status of ports.

```
diag>      netstat <option>
```

*Variables:*

- <option> is one of the options: *ports* or *connections*.

Option	Description
ports	Shows TCP/UDP ports.
connections	Shows network connections.

### Testing the Network Connectivity

This ping command sends the ICMP ECHO\_REQUEST message to a network host for checking its network connectivity. If the output shows the host is responding properly, the network connectivity is good. If not, either the host is shut down or it is not being properly connected to the network.

```
diag> ping <host>
```

*Variables:*

- <host> is the host name or IP address whose networking connectivity you want to check.

*Options:*

- You can include any or all of additional options listed below in the ping command.

Options	Description
count <number1>	Determines the number of messages to be sent. <number1> is an integer number between 1 and 100.
size <number2>	Determines the packet size. <number2> is an integer number in bytes between 1 and 65468.
timeout <number3>	Determines the waiting period before timeout. <number3> is an integer number in seconds ranging from 1 to 600.

The command looks like the following when it includes all options:

```
diag> ping <host> count <number1> size <number2> timeout <number3>
```

### Tracing the Route

This command syntax traces the network route between your PX device and a network host.

```
diag>          traceroute <host>
```

*Variables:*

- <host> is the name or IP address of the host you want to trace.

### Example - Ping Command

The following command checks the network connectivity of the host 192.168.84.222 by sending the ICMP ECHO\_REQUEST message to the host for 5 times.

```
diag>          ping 192.168.84.222 count 5
```

---

## Retrieving Previous Commands

If you would like to retrieve any command that was previously typed in the same connection session, press the Up arrow (↑) on the keyboard until the desired command is displayed.

---

## Automatically Completing a Command

A CLI command always consists of several words. You can easily enter a command by typing first word(s) or letter(s) and then pressing Tab or Ctrl+i instead of typing the whole command word by word.

► **To have a command completed automatically:**

1. Type initial letters or words of the desired command. Make sure the letters or words you typed are unique so that the CLI can identify the command you want.
2. Press Tab or Ctrl+i until the complete command appears.

*Example 1:*

Type the first word and the first letter of the second word of the "reset factorydefaults" command, that is, `reset f`. Then press Tab or Ctrl+i to complete the second word.

*Example 2:*

Type the first word and initial letters of the second word of the "security enforceHttpsForWebAccess" command, that is, `security enf`. Then press Tab or Ctrl+i to complete the second word.

---

## Logging out of CLI

After completing your tasks using the CLI, always log out of the CLI to prevent others from accessing the CLI.

► **To log out of the CLI:**

1. Ensure you have entered administrator mode and the # prompt is displayed.
2. Type `exit` and press Enter.

# Chapter 9 In-Line Monitors

The model name of a PX in-line monitor follows this format: PX2-3nnn, where n is a number, such as PX2-3411.

Unlike most of PX devices, each inlet of an in-line monitor is connected to an outlet only, so an inlet's rating is the same as an outlet's rating.

## In This Chapter

Overview.....	481
Safety Instructions.....	481
Flexible Cord Installation Instructions.....	482
In-Line Monitor's LED Display.....	490
In-Line Monitor's Web Interface.....	491

---

### Overview

An in-line monitor is implemented with the same number of inlets and outlets. An inlet is connected to a power source for receiving electricity, such as electric distribution panels or branch circuit receptacles. An outlet is connected to a device that draws power, such as a cooling or IT device.

Inlets are located at the side labeled **Line**, and outlets are located at the side labeled **Load**.

---

### Safety Instructions

1. Installation of this product should only be performed by a licensed electrician.
2. Make sure the line cord is disconnected from power before physically mounting or moving the location of this product.
3. This product is intended to be located in an equipment rack in an information technology room. In the United States, installation must comply and be done in accordance with NEC (2011) Article 645 *Information Technology Equipment*.
4. This product is designed to be used within an electronic equipment rack. The metal case of this product is electrically bonded to the line cord ground wire. A threaded grounding point on the case may be used as an additional means of protectively grounding this product and the rack.
5. Examine the branch circuit receptacle that will supply electric power to this product. Make sure the receptacle's power lines, neutral and protective earth ground pins are wired correctly and are the correct voltage and phase. Make sure the branch circuit receptacle is protected by a suitably rated fuse or circuit breaker.

6. If the product is a model that contains receptacles that can be switched on/off, electric power may still be present at a receptacle even when it is switched off.

---

## Flexible Cord Installation Instructions

The following instructions are for Raritan products manufactured to accept user-installed flexible cords. These products are visually identified by the cable gland used to hold the flexible cord.



---

**Important:** Complete and the most updated instructions on installing a flexible cord on Raritan PDUs are included in the *Raritan PX Power Cord Installation Guide*, which is available on the Raritan website at this URL: <http://www.raritan.com/support/product/px2/px2-support-files>.

---

### Flexible Cord Selection

- The preferred flexible cable is type SOOW, 600V, 90°C or 105°C. Consult Raritan before using a different flexible cable type.
- The rated ampacity of the flexible cord must be greater than or equal to the Raritan product's rated ampacity marked on its nameplate. In the United States, relevant ampacity ratings for flexible cords can be found in NEC(2011) section 400.5.
- The number of wires in the flexible cord must match the number of terminals (including the ground terminal) inside the Raritan product. See **Wiring of 3-Phase In-Line Monitors** (on page 484) for exceptions.
- If a plug is to be attached to the flexible cord, the length of the flexible cord must not exceed 4.5 meters - as specified in UL 60950-1 (2007) and NEC 645.5 (2011).
- The flexible cord may be permanently connected to power subject to local regulatory agency approval. In the United States, relevant electrical regulations can be found in NEC (2011) sections 400.7(A)(8), 400.7(B), 368.56 and table 400.4.

---

### Plug Selection

If a plug is to be attached to the flexible cord, the plug's rated ampacity is chosen as follows:

- In the United States, as specified in UL 60950-1, the plug's rated ampacity must be 125% greater than the Raritan product's rated ampacity. In some Raritan products, such as 35A 3-phase delta wired PDUs, an exactly 125% rated plug is not available. In these cases, choose the closest plug that is more than 125%. For example, a 50A plug is the closest fit for a 35A 3-phase PDU.
- For all other locations, subject to local regulatory agency policy, the plug's rated ampacity is the same as the Raritan products rated ampacity.

---

### Receptacle Selection

For Raritan in-line monitors, any receptacle fitted to the outlet flexible cord must have identical ratings as the plug attached to the inlet flexible cord.

---

### Derating a Raritan Product

Lower rated plugs, receptacles and flexible cords may be connected to a Raritan product. This results in a derated (reduced) ampacity rating for the product.

#### ► Derating guidelines:

1. Choose the plug and use its rated ampacity to determine the derated ampacity.
  - In the United States, as specified in UL 60950-1, the derated ampacity is 80% of the plug's rated ampacity. For example, a 30A plug would result in a derated ampacity of 24A.
  - In other geographic locations, subject to local regulatory agency approval, the derated ampacity is the plug's rated ampacity. For example, using a 16A plug would result in a derated ampacity of 16A.
2. The derated ampacity must be marked on the Raritan product so the new reduced rating can be easily identified.
3. For in-line monitors, the receptacles used must have the same voltage and ampacity rating as the plug chosen in step 1.

4. The flexible cord must have a rated ampacity greater than or equal to the derated ampacity. Since the new flexible cord may be smaller diameter, a check must be performed to insure the cable gland nut, when tightened, will securely hold the flexible cord so that it cannot be twisted, pulled or pushed in the cable gland. A sealing ring, for small diameter flexible cords, may have been included with the Raritan product, or one can be requested from Raritan, to reduce the inside diameter of the cable gland.

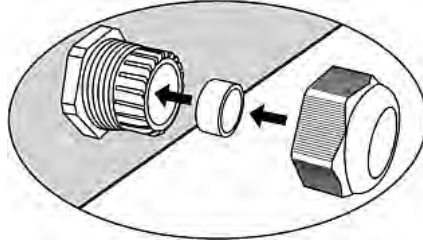

---

### Wiring of 3-Phase In-Line Monitors

3-phase in-line monitors contain 4-pole wiring terminal blocks (L1, L2, L3, N) to monitor 5-wire (4P+PE) 3-phase wye connections. Delta wired 4-wire (3P+PE) 3-phase connections are also permitted (no wire connected to the terminal block neutral "N"). No additional hardware or firmware configuration is required to specify whether the connection is 5-wire wye or 4-wire delta.

---

### In-Line Monitor Unused Channels

It is not necessary to wire up all channels of multi-channel in-line monitors. The inlet and outlet openings of unused channels must be completely closed off. "Goof plugs" for this purpose may be a good choice if they are available in your country or region.

---

### Step by Step Flexible Cord Installation

The following items are required to complete the installation:

- Flexible cord(s).
- Insulated ring terminals (one for each wire) and appropriate crimp tool.
- Plug(s) and receptacle(s) (for in-line monitors)
- Torque screwdriver, torque nut driver and torque wrench to tighten the wiring terminal block screws, ground nut and cable gland nut.

▶ **To install a flexible cord:**

1. Open the PDU's access panel (or in-line monitor top panel) to expose the power wiring terminal block(s).



### One-channel in-line monitor

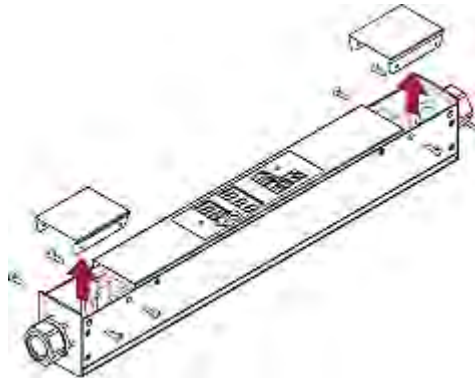

### Zero U PDU

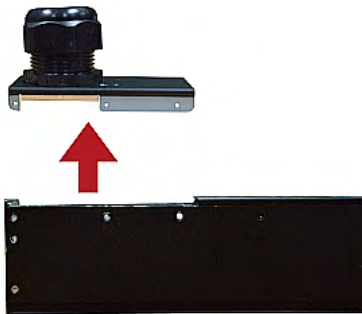

Make sure to locate the ground wire mounting stud(s). There is a separate ground wire mounting stud for each terminal block. Each flexible cord **MUST** have its green (or green/yellow) ground wire bonded to a ground wire mounting stud.



For in-line monitors, make sure to identify the inlet terminal blocks (rear of monitor) and outlet terminal blocks (front of monitor). Each inlet terminal block has a corresponding outlet terminal block.

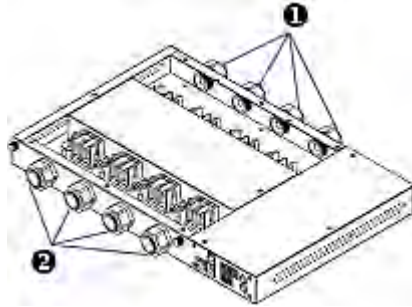

Number	Description
①	Inlets (labeled LINE)
②	Outlets (labeled LOAD)

2. Strip off the outer jacket of the flexible cord and remove any jute, paper or other fillers. Use the following to help determine how much jacket to remove:
  - In the finished assembly, the outer jacket should protrude inside the Raritan product.
  - The wires will have ring terminals crimped onto them.
  - In the finished assembly, the wires should have some slack and not be taught.
  - In the finished assembly, if the flexible cord slips in the cable gland placing a strain on the cord's wires, the ground wire must be the last wire to take the strain.
3. Crimp an insulated ring terminal onto each wire. A non-insulated ring terminal may be used for the ground wire. Inspect each crimp to insure it is secure and verify no exposed wire protrudes from the rear of an insulated ring terminal.
4. Loosen the cable gland nut and push the flexible cord assembly through the gland.



Temporarily hand tighten the gland nut and verify the cord cannot be twisted or pushed or pulled in the gland. Do not proceed if hand tightening results in a loose cord. In some models, especially in-line monitors, the flexible cord's diameter may be too small for the cable gland. A sealing ring for smaller diameter line cords may have been included with the Raritan product, or can be requested from Raritan, to reduce the inside diameter of the cable gland.

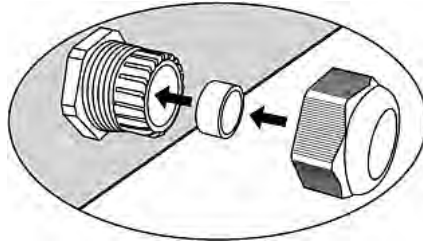

5. Fasten the ring terminal of the green (or green/yellow) ground wire to the chassis's threaded ground stud in this order:
  - a. Place the lock washer on the stud.
  - b. Place the ground wire ring terminal on the stud.
  - c. Place the nut on the stud and tighten with a torque wrench. The appropriate torque settings vary according to the nut size.

Nut size	Torque setting (N-m)	Tolerance
M3	0.49	10%
M4	1.27	8%
M5	1.96	5%
M6	2.94	3.5%
M8	4.9	2%

- d. Check the ground wire connection. It should be secure and not move or rotate.



6. Fasten the ring terminals of all remaining wires to the terminal block and tighten each using a torque screwdriver. The appropriate torque settings vary according to the screw size.

Screw size	Torque setting (N-m)	Tolerance
M3	0.49	10%
M4	1.27	8%
M5	1.96	5%
M6	2.94	3.5%
M8	4.9	2%

Make sure each ring terminal is firmly fastened and cannot be twisted by hand. Use the following guidelines to help terminal block wiring.

- In single-phase Raritan products with world-wide ratings, the terminals are labeled L1 and L2. L1 is the phase wire. L2 is either the neutral (120/230V installations) or another phase wire (208V installations).

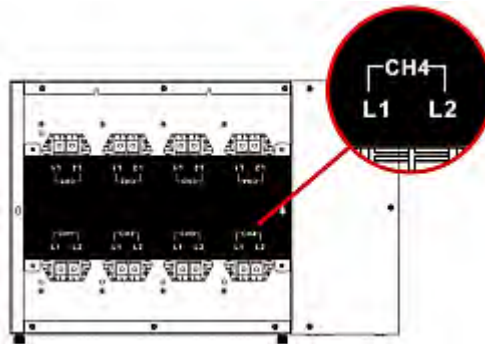

- In all 3-phase products, L1 is phase A, L2 is phase B, L3 is phase C and N is neutral.

- If your PDU is inlet metered, such as PDU models PX2-1nnn and PX2-2nnn (where n is a number), you must pass each line cord wire through the correct CT in the correct direction. Each CT is labeled and contains a direction arrow. Push the ring terminal end of the line cord through the CT in the direction indicated by the arrow. For example, push the L1 line cord wire through the CT labeled L1 and then connect it to the L1 terminal block.

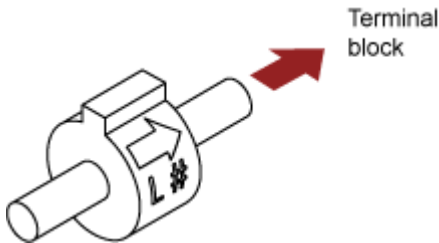

- For Raritan in-line monitors, where there is a one to one correspondence between plug and receptacle, maintain the same wire colors for inlet and outlet flexible cords.
7. Make final adjustments to the cable gland and verify the jacket of the flexible cord extends into the Raritan product. Hand tighten the gland nut and finish tightening with a torque wrench. Appropriate torque settings vary according to the cable gland size.

Cable gland size	Torque setting (N·m)
M12x1.5	0.7 to 0.9
M16x1.5	2.0 to 3.0
M20x1.5	2.7 to 4.0
M25x1.5	5.0 to 7.5
M32x1.5	7.5 to 10.0
M40x1.5	7.5 to 10.0
M50x1.5	7.5 to 10.0
M63x1.5	7.5 to 10.0

*Note: The cable gland size is marked on the cable gland body.*

After tightening, examine the flexible cord and cable gland for the following:

- Make sure you can see a few remaining threads between the cable gland body and cable gland nut. The gland nut must not bottom out on the gland body.
  - Make sure the flexible cord does not move in the cable gland when it is twisted, pushed or pulled.
8. Re-install the PDU wiring access panel or in-line monitor cover plate. This completes internal wiring of the Raritan product.

9. For in-line monitors, fasten the receptacles to the outlet flexible cords following the manufacturer's instructions.
10. Complete the wiring of the inlet flexible cord by performing one of these steps:
  - Assemble the plug following the manufacturer's instructions.
  - Permanently attach and strain relief the flexible cord to a junction box following applicable electrical codes.

---

## In-Line Monitor's LED Display

The LED display of an in-line monitor is the same as a regular PX model. See **LED Display** (on page 59).

---

### Automatic Mode

Unlike regular PX models, the in-line monitor's LED display only cycles through the current readings of each outlet in the Automatic Mode.

---

### Manual Mode

You can switch between voltage, active power and current readings of the selected outlet in the Manual Mode on an in-line monitor. To enter the Manual Mode, press the Up or Down button.

► **To operate the LED display of an inline monitor:**

1. Press the Up or Down button until the desired outlet number is selected in the two-digit row.
  - Pressing the Up button moves up one selection.
  - Pressing the Down button moves down one selection.If your inline monitor has only one outlet, go to Step 2.
2. Current of the selected outlet is shown in the three-digit row. Simultaneously the CURRENT(A) LED is lit. See **LEDs for Measurement Units** (on page 61).
3. If desired, you can press the Up and Down buttons simultaneously to switch between voltage, active power and current readings.
  - The voltage appears in this format: XXX (V). It is displayed for about five seconds, after which the current reading re-appears. When the voltage is displayed, the VOLTAGE(V) LED is lit.
  - The active power appears in one of the formats: X.XX, XX.X, and XXX (kW). It is displayed for about five seconds, after which the current reading re-appears. When the active power is displayed, the POWER(kW) LED is lit.

4. While the final outlet's active power is being displayed, you can press the Up button to show the first outlet's unbalanced load. The UB LOAD (%) LED is lit.
  - Then press the Up and Down buttons to switch between different outlet's unbalanced load readings if there are more than one outlet.

---

*Note: The LED display returns to the Automatic Mode after 20 seconds elapse since the last time any button was pressed.*

---

---

## **In-Line Monitor's Web Interface**

An in-line monitor's web interface is similar to a regular PX model's web interface.

See ***Using the Web Interface*** (on page 71) for login instructions and additional information.

## Dashboard Page

After login, the web interface displays the Dashboard page by default. An inline monitor's Dashboard page looks slightly different from a regular PX device's Dashboard page.

The power status of the outlet on a three-phase Y-wired inline monitor is displayed on this page, including:

- Current of L1, L2 and L3
- Voltage of L1-L2, L2-L3, and L3-L1
- Active power
- Apparent power
- Power factor

*Note: Depending on your model, elements shown on the same page may appear slightly different from this image.*

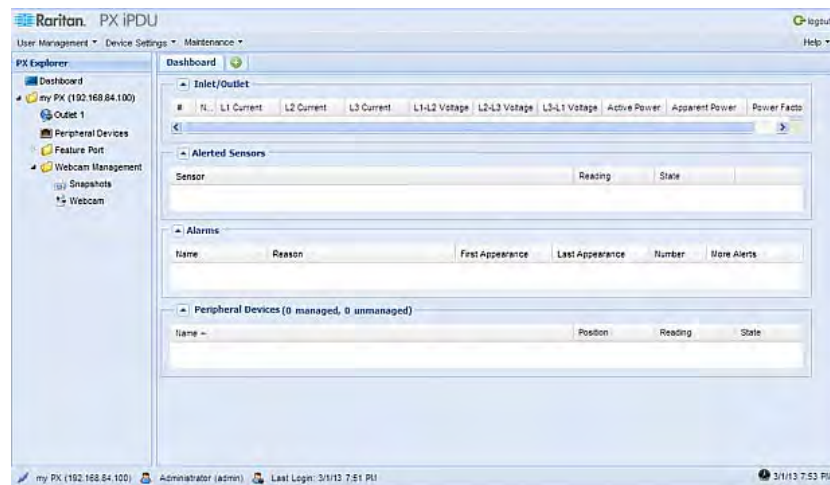

## Outlet Page

An inline monitor's Outlet page displays more information than a regular PX device's Outlet page, including:

- Current per outlet  
Current per line (for a three-phase model)
- Voltage per outlet  
Voltage per line (for a three-phase model)
- Power-related readings per outlet  
Power-related readings per line (for a three-phase model)



- Threshold settings per outlet  
 Threshold settings per line (for a three-phase model)

*Note: Depending on your model, elements shown on the same page may appear slightly different from this image.*

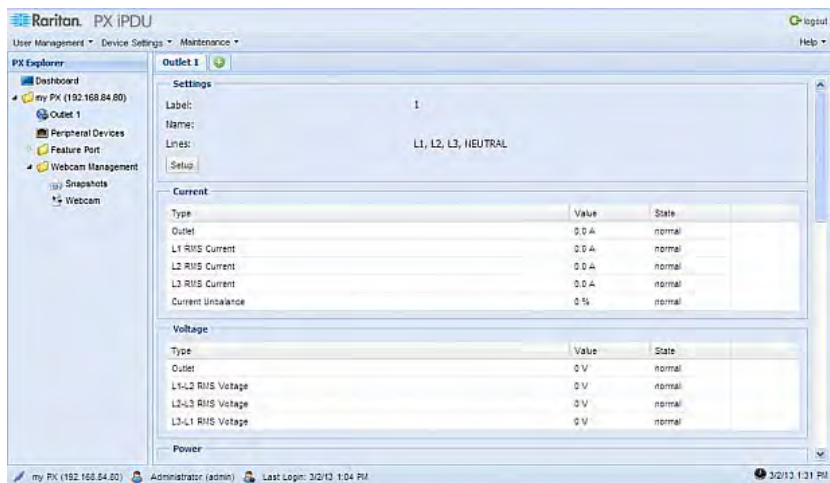

# Appendix A Specifications

## In This Chapter

Maximum Ambient Operating Temperature .....	494
Serial RS-232 Port Pinouts.....	494
Sensor RJ-12 Port Pinouts .....	494
Feature RJ-45 Port Pinouts .....	495

---

## Maximum Ambient Operating Temperature

The maximum ambient operating temperature (TMA) for PX varies from 50 to 60 degrees Celsius, depending on the model and certification standard (CE or UL). If necessary, contact Raritan Technical Support for this information for your model.

Specification	Measure
Max Ambient Temperature	50 to 60 degrees Celsius

---

## Serial RS-232 Port Pinouts

RS-232 Pin/signal definition			
Pin No.	Signal	Direction	Description
1	DCD	Input	Data
2	RxD	Input	Receive data (data in)
3	TxD	Output	Transmit data
4	DTR	Output	Data terminal ready
5	GND	—	Signal ground
6	DSR	Input	Data set ready
7	RTS	Output	Request to send
8	CTS	Input	Clear to send
9	RI	Input	Ring indicator

---

## Sensor RJ-12 Port Pinouts

RJ-12 Pin/signal definition			
Pin No.	Signal	Direction	Description
1	+12V	—	Power (500mA, fuse protected)
2	GND	—	Signal Ground
3	—	—	—
4	—	—	—
5	GND	—	Signal Ground
6	1-wire		Used for Feature Port

---

### Feature RJ-45 Port Pinouts

RJ-45 Pin/signal definition			
Pin No.	Signal	Direction	Description
1	DTR	Output	Reserved
2	GND	—	Signal Ground
3	+5V	—	Power for CIM (200mA, fuse protected)  Warning: Pin 3 is only intended for use with Raritan devices.
4	TxD	Output	Transmit Data (Data out)
5	RxD	Input	Receive Data (Data in)
6	N/C	N/C	No Connection
7	GND	—	Signal Ground
8	DCD	Input	Reserved

# Appendix B Equipment Setup Worksheet

PX Series Model \_\_\_\_\_

PX Series Serial Number \_\_\_\_\_

OUTLET 1	OUTLET 2	OUTLET 3
MODEL	MODEL	MODEL
SERIAL NUMBER	SERIAL NUMBER	SERIAL NUMBER
USE	USE	USE
OUTLET 4	OUTLET 5	OUTLET 6
MODEL	MODEL	MODEL
SERIAL NUMBER	SERIAL NUMBER	SERIAL NUMBER
USE	USE	USE

OUTLET 7	OUTLET 8	OUTLET 9
MODEL	MODEL	MODEL
SERIAL NUMBER	SERIAL NUMBER	SERIAL NUMBER
USE	USE	USE
OUTLET 10	OUTLET 11	OUTLET 12
MODEL	MODEL	MODEL
SERIAL NUMBER	SERIAL NUMBER	SERIAL NUMBER
USE	USE	USE
OUTLET 13	OUTLET 14	OUTLET 15
MODEL	MODEL	MODEL
SERIAL NUMBER	SERIAL NUMBER	SERIAL NUMBER
USE	USE	USE

Appendix B: Equipment Setup Worksheet

OUTLET 16	OUTLET 17	OUTLET 18
MODEL	MODEL	MODEL
SERIAL NUMBER	SERIAL NUMBER	SERIAL NUMBER
USE	USE	USE
OUTLET 19	OUTLET 20	OUTLET 21
MODEL	MODEL	MODEL
SERIAL NUMBER	SERIAL NUMBER	SERIAL NUMBER
USE	USE	USE

OUTLET 22	OUTLET 23	OUTLET 24
MODEL	MODEL	MODEL
SERIAL NUMBER	SERIAL NUMBER	SERIAL NUMBER
USE	USE	USE

Types of adapters

---

Types of cables

---

Name of software program

---

# Appendix C Bulk Configuration or Firmware Upgrade via DHCP/TFTP

If a TFTP server is available, you can use it and appropriate configuration files to perform any or all of the following tasks for a large number of PX devices in the same network.

- Initial deployment
- Configuration changes
- Firmware upgrade
- Downloading diagnostic data

This feature is drastically useful if you have hundreds or even thousands of PX devices to configure or upgrade.

Warning: The feature of bulk configuration or firmware upgrade via DHCP/TFTP only works on standalone PX devices directly connected to the network. This feature does NOT work for slave devices in the USB-cascading configuration.

## In This Chapter

Bulk Configuration/Upgrade Procedure .....	500
TFTP Requirements .....	501
DHCP IPv4 Configuration in Windows .....	502
DHCP IPv6 Configuration in Windows .....	512
DHCP IPv4 Configuration in Linux .....	519
DHCP IPv6 Configuration in Linux .....	521

---

## Bulk Configuration/Upgrade Procedure

The DHCP/TFTP feature is supported as of release 3.1.0 so make sure that all PX devices which you want to configure or upgrade are running firmware version 3.1.0 or later. If not, upgrade them first.

### ► Steps of using DHCP/TFTP for bulk configuration/upgrade:

1. Create configuration files specific to your PX models and firmware versions. You must contact Raritan Technical Support to properly prepare these files, which include some or all of the following:
  - *fwupdate.cfg* (always required)
  - *config.txt*
  - *devicelist.csv*



Contact information of worldwide Raritan Technical Support is available on the Raritan website's **Support page** (<http://www.raritan.com/support/>).

---

*Note: Supported syntax of "fwupdate.cfg" and "config.txt" may vary based on different firmware versions. If you have existing configuration files, it is suggested to double check with Raritan Technical Support for the correctness of these files prior to using this feature.*

---

2. Configure your TFTP server properly. See **TFTP Requirements** (on page 501).
3. Copy ALL required configuration files into the TFTP root directory. If the tasks you will perform include firmware upgrade, an appropriate firmware binary file is also required.
4. Properly configure your DHCP server so that it refers to the file "fwupdate.cfg" on the TFTP server for your PX.

Click one or more of the following links for detailed DHCP configuration instructions, based on your system and the IP address type.

- **DHCP IPv4 Configuration in Windows** (on page 502)
  - **DHCP IPv6 Configuration in Windows** (on page 512)
  - **DHCP IPv4 Configuration in Linux** (on page 519)
  - **DHCP IPv6 Configuration in Linux** (on page 521)
5. Verify that all of the desired PX devices use DHCP as the IP configuration method and have been *directly* connected to the network.
  6. Re-boot these PX devices. The DHCP server will execute the commands in the "fwupdate.cfg" file on the TFTP server to configure or upgrade those PX devices supporting DHCP in the same network.  
  
DHCP will execute the "fwupdate.cfg" commands once for IPv4 and once for IPv6 respectively if both IPv4 and IPv6 settings are configured properly in DHCP.

---

## TFTP Requirements

To perform bulk configuration or firmware upgrade successfully, your TFTP server must meet the following requirements:

- The server is able to work with both IPv4 and IPv6.  
In Linux, remove any IPv4 or IPv6 flags from `/etc/xinetd.d/tftp`.

---

*Note: DHCP will execute the "fwupdate.cfg" commands once for IPv4 and once for IPv6 respectively if both IPv4 and IPv6 settings are configured properly in DHCP.*

---

- All required configuration files are available in the TFTP root directory. See **Bulk Configuration/Upgrade Procedure** (on page 500).

If you are going to upload any PX diagnostic file or create a log file in the TFTP server, the first of the following requirements is also required.

- The TFTP server supports the write operation, including file creation and upload.

In Linux, provide the option "-c" for write support.

- **Required for uploading the diagnostic file only** - the timeout for file upload is set to one minute or larger.

---

## DHCP IPv4 Configuration in Windows

For those PX devices using IPv4 addresses, follow this procedure to configure your DHCP server. The following illustration is based on Microsoft® Windows Server 2012 system.

► **Required Windows IPv4 settings in DHCP:**

1. Add a new vendor class for Raritan PX under IPv4.
  - a. Right-click the IPv4 node in DHCP to select Define Vendor Classes.
  - b. Click Add to add a new vendor class.

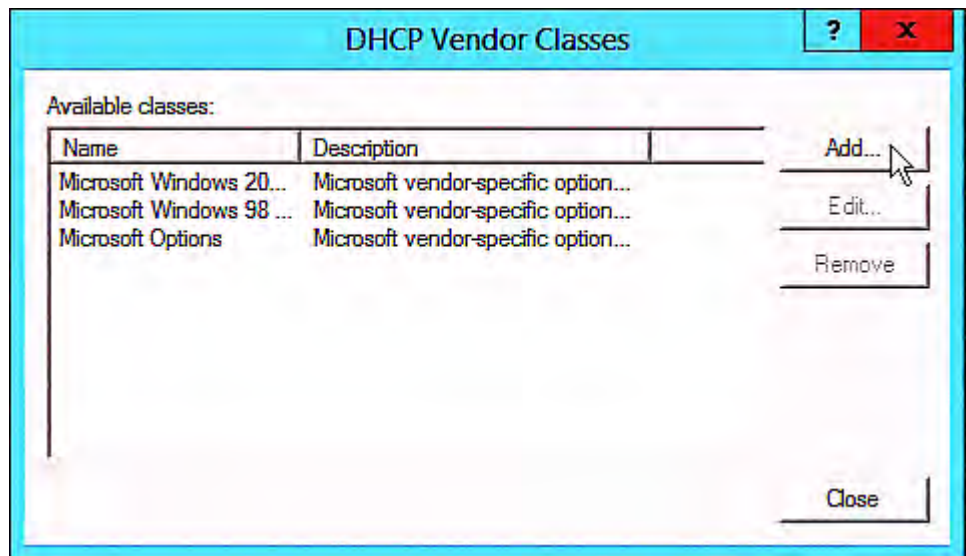

- c. Specify a unique name for this vendor class and type the binary codes of "Raritan PDU 1.0" in the New Class dialog.

The vendor class is named "Raritan PDU" in this illustration.

**New Class**

Display name:  
Raritan PDU

Description:  
Raritan PDU

ID:	Binary:	ASCII:
0000	52 61 72 69 74 61 6E 20	Raritan
0008	50 44 55 20 31 2E 30	PDU 1.0

OK Cancel

2. Define one DHCP standard option - Vendor Class Identifier.
  - a. Right-click the IPv4 node in DHCP to select Set Predefined Options.

- b. Select DHCP Standard Options in the "Option class" field, and Vendor Class Identifier in the "Option name" field. Leave the String field blank.

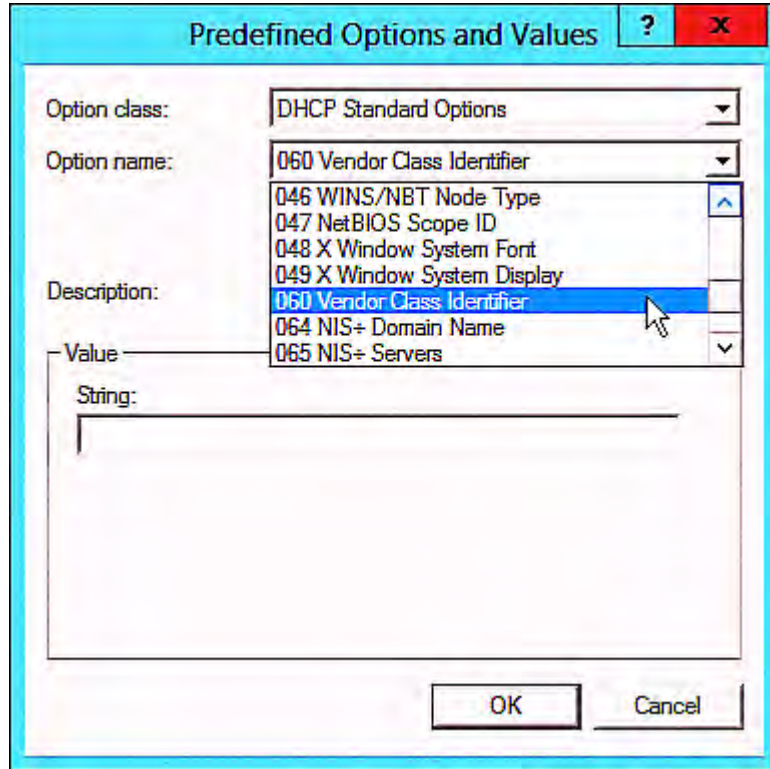

3. Add three options to the new vendor class "Raritan PDU" in the same dialog.

- a. Select Raritan PDU in the "Option class" field.

The screenshot shows a dialog box titled "Predefined Options and Values". It has a light blue header with a question mark and a close button (X). The "Option class:" field is a dropdown menu currently showing "Raritan PDU". Below it, the "Option name:" field is an open dropdown menu with a list of options: "DHCP Standard Options", "Microsoft Windows 2000 Options", "Microsoft Windows 98 Options", "Microsoft Options", and "Raritan PDU". The "Raritan PDU" option is highlighted in blue. The "Description:" field is empty. Below that, the "Value" section is a large text area with a "String:" label and a cursor. At the bottom, there are "OK" and "Cancel" buttons.

- b. Click Add to add the first option. Type "pdu-tftp-server" in the Name field, select IP Address as the data type, and type 1 in the Code field.

The screenshot shows a dialog box titled "Option Type". It has a light blue header with a question mark and a close button (X). The "Class:" field is a dropdown menu showing "Raritan PDU". The "Name:" field is a text box containing "pdu-tftp-server". The "Data type:" field is a dropdown menu showing "IP Address" and an unchecked "Array" checkbox. The "Code:" field is a text box containing "1". The "Description:" field is empty. At the bottom, there are "OK" and "Cancel" buttons.

- c. Click Add to add the second option. Type "pdu-update-control-file" in the Name field, select String as the data type, and type 2 in the Code field.

The screenshot shows a dialog box titled "Option Type" with a question mark and a close button (X) in the top right corner. The dialog contains the following fields:

- Class:** Raritan PDU
- Name:** pdu-update-control-file
- Data type:** String (selected in a dropdown menu), with an unchecked checkbox for Array.
- Code:** 2
- Description:** (empty text area)

At the bottom right, there are two buttons: "OK" and "Cancel". A mouse cursor is pointing at the "OK" button.

- d. Click Add to add the third one. Type "pdu-update-magic" in the Name field, select String as the data type, and type 3 in the Code field.

The screenshot shows a dialog box titled "Option Type" with a question mark and a close button (X) in the top right corner. The dialog contains the following fields:

- Class:** Raritan PDU
- Name:** pdu-update-magic
- Data type:** String (selected in a dropdown menu), with an unchecked checkbox for Array.
- Code:** 3
- Description:** (empty text area)

At the bottom right, there are two buttons: "OK" and "Cancel". A mouse cursor is pointing at the "OK" button.

- 4. Create a new policy associated with the "Raritan PDU" vendor class.
  - a. Right-click the Policies node under IPv4 to select New Policy.
  - b. Specify a policy name, and click Next.

The policy is named "PDU" in this illustration.

The screenshot shows a window titled "DHCP Policy Configuration Wizard" with a sub-header "Policy based IP Address and Option Assignment". The main text explains that this feature allows distributing settings based on conditions and that the wizard will guide the user in setting up a new policy. Two input fields are present: "Policy Name" with the value "PDU" and an empty "Description" field. At the bottom, there are three buttons: "< Back", "Next >", and "Cancel". A mouse cursor is pointing at the "Next >" button.

c. Click Add to add a new condition.



- d. Select the vendor class "Raritan PDU" in the Value field, click Add and then Ok.

Specify a condition for the policy being configured. Select a criteria, operator and values for the condition.

Criteria: Vendor Class

Operator: Equals

Value(s)

Value: Raritan PDU [Add]

Prefix wildcard(\*)

Append wildcard(\*)

Raritan PDU [Remove]

Ok Cancel

- e. Click Next.



- f. Select DHCP Standard Options in the "Vendor class" field, select "060 Vendor Class Identifier" from the Available Options list, and type "Raritan PDU 1.0" in the "String value" field.

### DHCP Policy Configuration Wizard

**Configure settings for the policy**

If the conditions specified in the policy match a client request, the settings will be applied.

Vendor class:

Available Options	Description
<input type="checkbox"/> 049 X Window System Display	Array of X Windows Display M
<input checked="" type="checkbox"/> 060 Vendor Class Identifier	
<input type="checkbox"/> 064 NIS+ Domain Name	The name of the client's NIS+

Data entry

String value:

- g. Select the "Raritan PDU" in the "Vendor class" field, select "001 pdu-tftp-server" from the Available Options list, and type your TFTP server's IPv4 address in the "IP address" field.

The screenshot shows the "DHCP Policy Configuration Wizard" window. At the top, it says "Configure settings for the policy" and includes a note: "If the conditions specified in the policy match a client request, the settings will be applied." Below this, the "Vendor class" dropdown menu is set to "Raritan PDU". A table of "Available Options" is shown with three entries: "001 pdu-tftp-server" (checked), "002 pdu-update-control-file" (unchecked), and "003 pdu-update-magic" (unchecked). In the "Data entry" section, the "IP address" field contains "192 . 168 . 85 . 93". At the bottom, there are three buttons: "< Back", "Next >", and "Cancel".

Available Options	Description
<input checked="" type="checkbox"/> 001 pdu-tftp-server	
<input type="checkbox"/> 002 pdu-update-control-file	
<input type="checkbox"/> 003 pdu-update-magic	

Data entry

IP address: 192 . 168 . 85 . 93

- h. Select "002 pdu-update-control-file" from the Available Options list, and type the filename "fwupdate.cfg" in the "String value" field.

**DHCP Policy Configuration Wizard**

**Configure settings for the policy**  
If the conditions specified in the policy match a client request, the settings will be applied.

Vendor class:

Available Options	Description
<input checked="" type="checkbox"/> 001 pdu-tftp-server	
<input checked="" type="checkbox"/> 002 pdu-update-control-file	
<input type="checkbox"/> 003 pdu-update-magic	

Data entry

String value:

- i. Select "003 pdu-update-magic" from the Available Options list, and type any string in the "String value" field. This third option/code is the magic cookie to prevent the *fwupdate.cfg* commands from being executed repeatedly. It does NOT matter whether the IPv4 magic cookie is identical to or different from the IPv6 magic cookie.

The magic cookie is a string comprising numerical and/or alphabetical digits in any format. In the following illustration diagram, it is a combination of a date and a serial number.

---

*Important: The magic cookie is transmitted to and stored in PX at the time of executing the "fwupdate.cfg" commands. The DHCP/TFTP operation is triggered only when there is a mismatch between the magic cookie in DHCP and the one stored in PX. Therefore, you must modify the magic cookie's value in DHCP when intending to execute the "fwupdate.cfg" commands next time.*

---

**DHCP Policy Configuration Wizard**

**Configure settings for the policy**  
If the conditions specified in the policy match a client request, the settings will be applied.

Vendor class: Raritan PDU

Available Options	Description
<input checked="" type="checkbox"/> 001 pdu-tftp-server	
<input checked="" type="checkbox"/> 002 pdu-update-control-file	
<input checked="" type="checkbox"/> 003 pdu-update-magic	

Data entry

String value:  
20150427-0001

< Back   Next >   Cancel

---

## DHCP IPv6 Configuration in Windows

For those PX devices using IPv6 addresses, follow this procedure to configure your DHCP server. The following illustration is based on Microsoft® Windows Server 2012 system.

► **Required Windows IPv6 settings in DHCP:**

1. Add a new vendor class for Raritan PX under IPv6.

- a. Right-click the IPv6 node in DHCP to select Define Vendor Classes.
- b. Click Add to add a new vendor class.

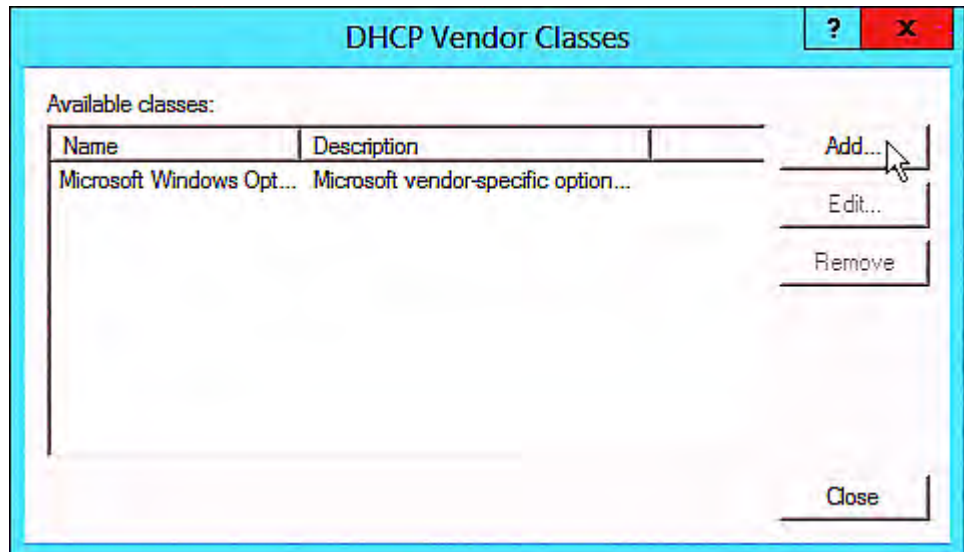

- c. Specify a unique name for the vendor class, type "13742" in the "Vendor ID (IANA)" field, and type the binary codes of "Raritan PDU 1.0" in the New Class dialog.

The vendor class is named "Raritan PDU 1.0" in this illustration.

ID:	Binary:	ASCII:
0000	52 61 72 69 74 61 6E 20	Raritan
0008	50 44 55 20 31 2E 30	PDU 1.0

2. Add three options to the "Raritan PDU 1.0" vendor class.
  - a. Right-click the IPv6 node in DHCP to select Set Predefined Options.



- b. Select Raritan PDU 1.0 in the "Option class" field.

Predefined Options and Values for v6

Option class: Raritan PDU 1.0

Option name: Raritan PDU 1.0

Description:

Value

String:

OK Cancel

- c. Click Add to add the first option. Type "pdu-tftp-server" in the Name field, select IP Address as the data type, and type 1 in the Code field.

Option Type

Class: Raritan PDU 1.0

Name: pdu-tftp-server

Data type: IP Address  Array

Code: 1

Description:

OK Cancel

- d. Click Add to add the second option. Type "pdu-update-control-file" in the Name field, select String as the data type, and type 2 in the Code field.

Option Type

Class: Raritan PDU 1.0

Name: pdu-update-control-file

Data type: String  Array

Code: 2

Description:

OK Cancel

- e. Click Add to add the third one. Type "pdu-update-magic" in the Name field, select String as the data type, and type 3 in the Code field.

Option Type

Class: Raritan PDU 1.0

Name: pdu-update-magic

Data type: String  Array

Code: 3

Description:

OK Cancel

- 3. Configure server options associated with the "Raritan PDU 1.0" vendor class.
  - a. Right-click the Server Options node under IPv6 to select Configure Options.
  - b. Click the Advanced tab.



- c. Select "Raritan PDU 1.0" in the "Vendor class" field, select "00001 pdu-ftp-server" from the Available Options list, and type your TFTP server's IPv6 address in the "IPv6 address" field.

The screenshot shows a configuration window titled "Server Options" with a light blue header. It has two tabs: "General" (selected) and "Advanced".

Under the "General" tab, there are two dropdown menus: "Vendor class" set to "Raritan PDU 1.0" and "User class" set to "Default User Class".

Below these is a list of "Available Options" with a "Description" column. The first option, "00001 pdu-ftp-server", is checked and highlighted in blue. Other options include "00002 pdu-update-control-file" and "00003 pdu-update-magic".

At the bottom of the list is a "Data entry" section with a text field labeled "IPv6 address" containing the value "fd07:2fa:6cff:1010::200".

At the bottom of the window are three buttons: "OK", "Cancel", and "Apply".

- d. Select "00002 pdu-update-control-file" from the Available Options list, and type the filename "fwupdate.cfg" in the "String value" field.

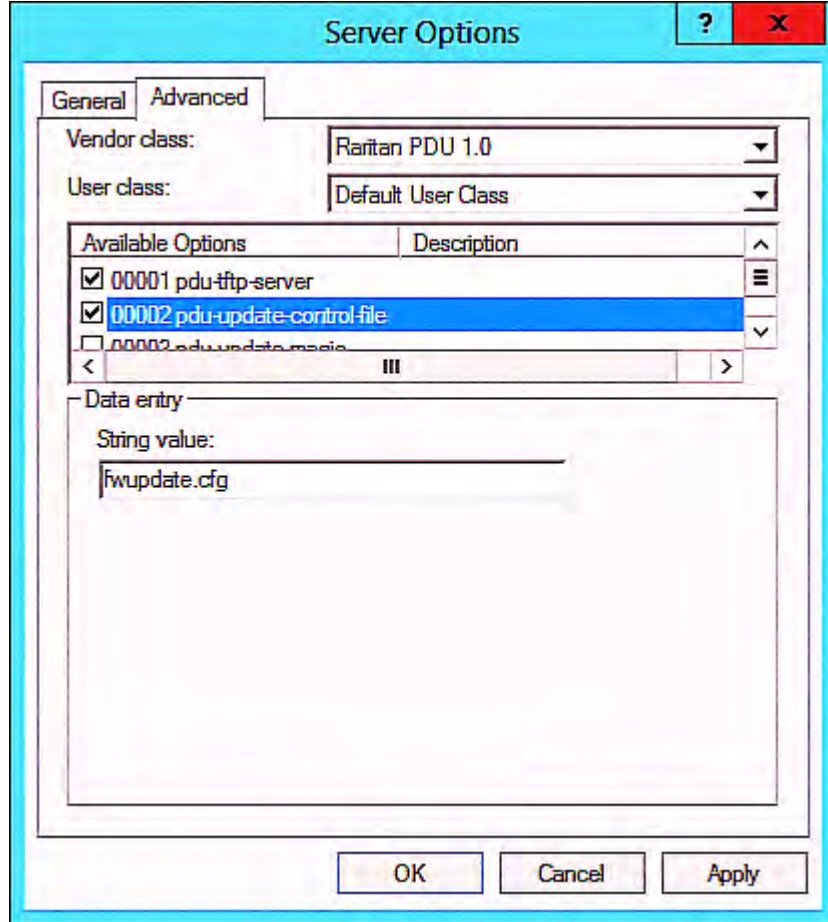

- e. Select "00003 pdu-update-magic" from the Available Options list, and type any string in the "String value" field. This third option/code is the magic cookie to prevent the *fwupdate.cfg* commands from being executed repeatedly. It does NOT matter whether the IPv6 magic cookie is identical to or different from the IPv4 magic cookie.

The magic cookie is a string comprising numerical and/or alphabetical digits in any format. In the following illustration diagram, it is a combination of a date and a serial number.

---

*Important: The magic cookie is transmitted to and stored in PX at the time of executing the "fwupdate.cfg" commands. The DHCP/TFTP operation is triggered only when there is a mismatch between the magic cookie in DHCP and the one stored in PX. Therefore, you must modify the magic cookie's value in DHCP when intending to execute the "fwupdate.cfg" commands next time.*

---

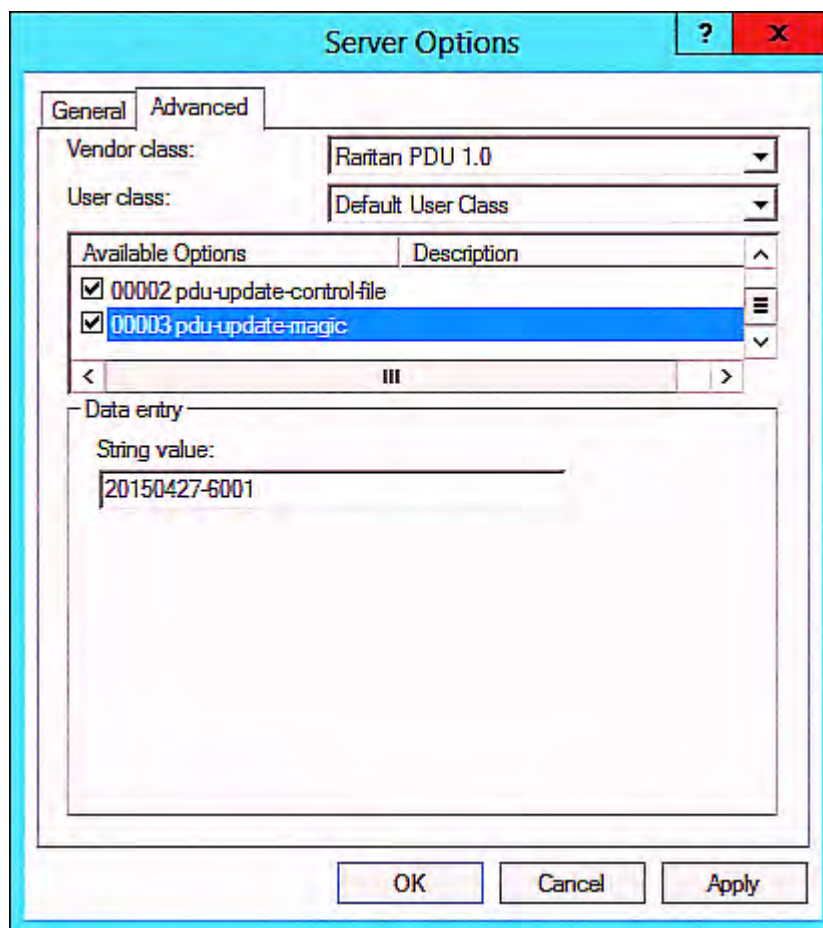

---

## DHCP IPv4 Configuration in Linux

Modify the "dhcpd.conf" file for IPv4 settings when your DHCP server is running Linux.

► **Required Linux IPv4 settings in DHCP:**

1. Locate and open the "dhcpd.conf" file of the DHCP server.
2. The PX will provide the following value of the vendor-class-identifier option (option 60).
  - vendor-class-identifier = "Raritan PDU 1.0"

Configure the same option in DHCP accordingly. The PX accepts the configuration or firmware upgrade only when this value in DHCP matches.

3. Set the following three sub-options in the "vendor-encapsulated-options" (option 43).
  - code 1 (pdu-tftp-server) = the TFTP server's IPv4 address
  - code 2 (pdu-update-control-file) = the name of the control file "fwupdate.cfg"
  - code 3 (pdu-update-magic) = any string

This third option/code is the magic cookie to prevent the *fwupdate.cfg* commands from being executed repeatedly. It does NOT matter whether the IPv4 magic cookie is identical to or different from the IPv6 magic cookie.

The magic cookie is a string comprising numerical and/or alphabetical digits in any format. In the following illustration diagram, it is a combination of a date and a serial number.

---

*Important: The magic cookie is transmitted to and stored in PX at the time of executing the "fwupdate.cfg" commands. The DHCP/TFTP operation is triggered only when there is a mismatch between the magic cookie in DHCP and the one stored in PX. Therefore, you must modify the magic cookie's value in DHCP when intending to execute the "fwupdate.cfg" commands next time.*

---

► IPv4 illustration example in dhcpd.conf:

```
[...]

set vendor-string = option vendor-class-identifier;
option space RARITAN code width 1 length width 1 hash size 3;
option RARITAN.pdu-tftp-server code 1 = ip-address;
option RARITAN.pdu-update-control-file code 2 = text;
option RARITAN.pdu-update-magic code 3 = text;

class "raritan" {
    match if option vendor-class-identifier = "Raritan PDU 1.0";
    vendor-option-space          RARITAN;
    option RARITAN.pdu-tftp-server 192.168.1.7;
    option RARITAN.pdu-update-control-file "fwupdate.cfg";
    option RARITAN.pdu-update-magic "20150123-0001";
    option vendor-class-identifier "Raritan PDU 1.0";
}

[...]
```

## DHCP IPv6 Configuration in Linux

Modify the "dhcpd6.conf" file for IPv6 settings when your DHCP server is running Linux.

► Required Linux IPv6 settings in DHCP:

1. Locate and open the "dhcpd6.conf" file of the DHCP server.
2. The PX will provide the following values to the "vendor-class" option (option 16). Configure related settings in DHCP accordingly.
  - 13742 (Raritan's IANA number)
  - Raritan PDU 1.0
  - 15 (the length of the above string "Raritan PDU 1.0")
3. Set the following three sub-options in the "vendor-opts" (option 17).
  - code 1 (pdu-tftp-server) = the TFTP server's IPv6 address

- code 2 (pdu-update-control-file) = the name of the control file "fwupdate.cfg"
- code 3 (pdu-update-magic) = any string

This third option/code is the magic cookie to prevent the *fwupdate.cfg* commands from being executed repeatedly. It does NOT matter whether the IPv6 magic cookie is identical to or different from the IPv4 magic cookie.

The magic cookie is a string comprising numerical and/or alphabetical digits in any format. In the following illustration diagram, it is a combination of a date and a serial number.

---

*Important: The magic cookie is transmitted to and stored in PX at the time of executing the "fwupdate.cfg" commands. The DHCP/TFTP operation is triggered only when there is a mismatch between the magic cookie in DHCP and the one stored in PX. Therefore, you must modify the magic cookie's value in DHCP when intending to execute the "fwupdate.cfg" commands next time.*

---

► IPv6 illustration example in `dhcpd6.conf`:

```
[...]

option space RARITAN code width 2 length width 2 hash size 3;
option RARITAN.pdu-tftp-server code 1 = ip6-address;
option RARITAN.pdu-update-control-file code 2 = text;
option RARITAN.pdu-update-magic code 3 = text;
option vsio.RARITAN code 13742 = encapsulate RARITAN;

[...]

subnet6 xxxx {

[...]

    option RARITAN.pdu-tftp-server 1::2;
    option RARITAN.pdu-update-control-file "fwupdate.cfg";
    option RARITAN.pdu-update-magic "20150123-0001";

[...]

}
```

# Appendix D Resetting to Factory Defaults

You can use either the reset button or the command line interface (CLI) to reset the PX.

---

**Important: Exercise caution before resetting the PX to its factory defaults. This erases existing information and customized settings, such as user profiles, threshold values, and so on. Only active energy data and firmware upgrade history are retained.**

---

## In This Chapter

Using the Reset Button.....	523
Using the CLI Command .....	524

---

## Using the Reset Button

An RS-232 serial connection to a computer is required for using the reset button.

► **To reset to factory defaults using the reset button:**

1. Connect a computer to the PX device. See **Connecting the PX to a Computer** (on page 15).
2. Launch a terminal emulation program such as HyperTerminal, Kermit, or PuTTY, and open a window on the PX. For information on the serial port configuration, see Step 2 of **Initial Network Configuration via CLI** (on page 19).
3. Press (and release) the Reset button of the PX device while pressing the Esc key of the keyboard several times in rapid succession. A prompt (=>) should appear after about one second.
4. Type *defaults* to reset the PX to its factory defaults.
5. Wait until the Username prompt appears, indicating the reset is complete.



This diagram shows the location of the reset button on Zero U models.



This diagram shows the location of the reset button on 1U models.

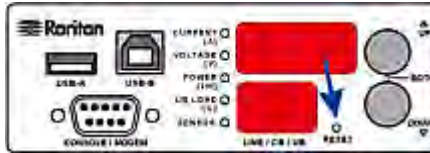

This diagram shows the location of the reset button on 2U models.

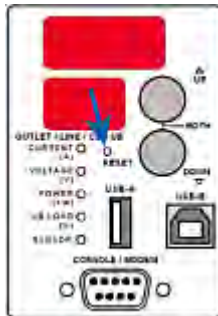

---

*Note: HyperTerminal is available on Windows operating systems prior to Windows Vista. For Windows Vista or later versions, you may use PuTTY, which is a free program you can download from the Internet. See PuTTY's documentation for details on configuration.*

---

## Using the CLI Command

The Command Line Interface (CLI) provides a reset command for restoring the PX to factory defaults. For information on CLI, see **Using the Command Line Interface** (on page 317).

► **To reset to factory defaults after logging in to the CLI:**

1. Connect to the PX device. See **Logging in to CLI** (on page 318) or **Connecting the PX to a Computer** (on page 15).
2. Launch a terminal emulation program such as HyperTerminal, Kermit, or PuTTY, and open a window on the PX. For information on the serial port configuration, see Step 2 of **Initial Network Configuration via CLI** (on page 19).
3. Log in to the CLI by typing the user name "admin" and its password.



4. After the # system prompt appears, type either of the following commands and press Enter.  

```
#    reset factorydefaults
```

-- OR --

```
#    reset factorydefaults /y
```
5. If you entered the command without "/y" in Step 4, a message appears prompting you to confirm the operation. Type y to confirm the reset.
6. Wait until the Username prompt appears, indicating the reset is complete.

► **To reset to factory defaults without logging in to the CLI:**

The PX provides an easier way to reset the product to factory defaults in the CLI prior to login.

1. Connect to the PX and launch a terminal emulation program as described in the above procedure.
2. At the Username prompt in the CLI, type "factorydefaults" and press Enter.

```
Username: factorydefaults
```

3. Type y on a confirmation message to perform the reset.

# Appendix E Available SCP Commands

You can perform a Secure Copy (SCP) command to update the PX firmware, do bulk configuration, or back up and restore the configuration.

## In This Chapter

Firmware Update via SCP .....	526
Bulk Configuration via SCP .....	527
Backup and Restore via SCP .....	528

---

## Firmware Update via SCP

Same as any PX firmware update, all user management operations are suspended and all login attempts fail during the SCP firmware update. For details, see **Firmware Update via Web Interface** (on page 300).

Warning: Do NOT perform the firmware upgrade over a wireless network connection.

### ► To update the firmware using the SCP command:

1. Type the following SCP command and press Enter.

```
scp <firmware file> <user name>@<device ip>:/fwupdate
```

- *<firmware file>* is the PX firmware's filename. If the firmware file is not in the current directory, you must include the path in the filename.
  - *<user name>* is the "admin" or any user profile with the Firmware Update permission.
  - *<device ip>* is the IP address of the PX that you want to update.
2. When the system prompts you to enter the password for the specified user profile, type it and press Enter.
  3. The system transmits the specified firmware file to the PX, and shows the transmission speed and percentage.
  4. When the transmission is complete, it shows the following message, indicating that the PX starts to update its firmware now. Wait until the upgrade completes.

```
Starting firmware update. The connection will be closed now.
```

► **SCP command example:**

```
scp pdu-px2-030000-41270.bin
admin@192.168.87.50:/fwupdate
```

---

*Tip: The PSCP works in a similar way to the SCP so the PSCP syntax is similar.*

```
pscp <firmware file> <user name>@<device ip>:/fwupdate
```

---

## Bulk Configuration via SCP

Like performing bulk configuration via the web interface, there are two steps with the bulk configuration using the SCP commands:

- a. Save a configuration from a source PX.
- b. Copy the configuration file to one or multiple destination PX.

For detailed information on the bulk configuration requirements, see **Bulk Configuration** (on page 276).

► **To save the configuration using the SCP command:**

1. Type the following SCP command and press Enter.

```
scp <user name>@<device ip>:/bulk_config.xml
```

- *<user name>* is the "admin" or any user profile with the administrator privileges.
  - *<device ip>* is the IP address of the PX that you want to update.
2. Type the password when the system prompts you to type it.
  3. The system saves the configuration from the PX to a file named "bulk\_config.xml."

► **To copy the configuration using the SCP command:**

1. Type the following SCP command and press Enter.

```
scp bulk_config.xml <user name>@<device ip>:/bulk_restore
```

- *<user name>* is the "admin" or any user profile with the administrator privileges.
  - *<device ip>* is the IP address of the PX that you want to update.
2. Type the password when the system prompts you to type it.

3. The system copies the configuration included in the file "bulk\_config.xml" to another PX, and displays the following message.  
Starting restore operation. The connection will be closed now.

► **SCP command examples:**

- Save operation's example:

```
scp admin@192.168.87.50:/bulk_config.xml
```

- Copy operation's example:

```
scp bulk_config.xml  
admin@192.168.87.47:/bulk_restore
```

---

*Tip: The PSCP works in a similar way to the SCP so its syntax is similar.*  
*Save operation -- pscp <user name>@<device ip>:/bulk\_config.xml*  
*Copy operation -- pscp bulk\_config.xml <user name>@<device ip>:/bulk\_restore*

---

---

## Backup and Restore via SCP

To back up ALL settings of a PX, including device-specific settings, you should perform the backup operation instead of the bulk configuration.

You can restore all settings to previous ones after a backup file is available.

► **To back up the settings using the SCP command:**

1. Type the following SCP command and press Enter.

```
scp <user name>@<device ip>:/backup_settings.xml
```

- *<user name>* is the "admin" or any user profile with the administrator privileges.
  - *<device ip>* is the IP address of the PX that you want to update.
2. Type the password when the system prompts you to type it.
  3. The system saves the settings from the PX to a file named "backup\_settings.xml."

► **To restore the settings using the SCP command:**

1. Type the following SCP command and press Enter.

```
scp backup_settings.xml <user name>@<device ip>:/settings_restore
```

- *<user name>* is the "admin" or any user profile with the administrator privileges.
  - *<device ip>* is the IP address of the PX that you want to update.
2. Type the password when the system prompts you to type it.
  3. The system copies the configuration included in the file "backup\_settings.xml" to the PX, and displays the following message.

Starting restore operation. The connection will be closed now.

► **SCP command examples:**

- Backup example:

```
scp admin@192.168.87.50:/backup_settings.xml
```

- Settings restoration example:

```
scp backup_settings.xml
admin@192.168.87.50:/settings_restore
```

---

*Tip: The PSCP works in a similar way to the SCP so its syntax is similar.*

*Backup operation -- pscp <user name>@<device ip>:/backup\_settings.xml*

*Restoration operation -- pscp backup\_settings.xml <user name>@<device ip>:/settings\_restore*

---

# Appendix F LDAP Configuration Illustration

This section provides an LDAP example for illustrating the configuration procedure using Microsoft Active Directory® (AD). To configure LDAP authentication, four main steps are required:

- a. Determine user accounts and groups intended for the PX
- b. Create user groups for the PX on the AD server
- c. Configure LDAP authentication on the PX device
- d. Configure roles on the PX device

---

**Important: Raritan disables SSL 3.0 and uses TLS for releases 3.0.4, 3.0.20 and later releases due to published security vulnerabilities in SSL 3.0. Make sure your network infrastructure, such as LDAP and mail services, uses TLS rather than SSL 3.0.**

---

## In This Chapter

Step A. Determine User Accounts and Groups.....	530
Step B. Configure User Groups on the AD Server.....	531
Step C. Configure LDAP Authentication on the PX Device.....	532
Step D. Configure User Groups on the PX Device .....	534

---

## Step A. Determine User Accounts and Groups

Determine the user accounts and groups that are authenticated for accessing the PX. In this example, we will create two user groups with different permissions. Each group will consist of two user accounts available on the AD server.

User groups	User accounts (members)
PX_User	usera
	pxuser2
PX_Admin	userb
	pxuser

### Group permissions:

- The PX\_User group will have neither system permissions nor outlet permissions.
- The PX\_Admin group will have full system and outlet permissions.

## Step B. Configure User Groups on the AD Server

You must create the groups for the PX on the AD server, and then make appropriate users members of these groups.

In this illustration, we assume:

- The groups for the PX are named *PX\_Admin* and *PX\_User*.
- User accounts *pxuser*, *pxuser2*, *usera* and *userb* already exist on the AD server.

► **To configure the user groups on the AD server:**

1. On the AD server, create new groups -- *PX\_Admin* and *PX\_User*.

*Note: See the documentation or online help accompanying Microsoft AD for detailed instructions.*

2. Add the *pxuser2* and *usera* accounts to the *PX\_User* group.
3. Add the *pxuser* and *userb* accounts to the *PX\_Admin* group.
4. Verify whether each group comprises correct users.



---

## Step C. Configure LDAP Authentication on the PX Device

You must enable and set up LDAP authentication properly on the PX device to use external authentication.

In the illustration, we assume:

- The DNS server settings have been configured properly. See **Modifying Network Settings** (on page 99) and **Role of a DNS Server** (on page 105).
- The AD server's domain name is *techadssl.com*, and its IP address is *192.168.56.3*.
- The AD protocol is NOT encrypted over TLS.
- The AD server uses the default TCP port *389*.
- Anonymous bind is used.

► **To configure LDAP authentication:**

1. Choose Device Settings > Security > Authentication. The Authentication Settings dialog appears.
2. Select the LDAP radio button to activate the LDAP/LDAPS authentication.
3. Click New to add an LDAP/LDAPS AA server. The "Create new LDAP Server Configuration" dialog appears.
4. Provide the PX with the information about the AD server.
  - IP Address / Hostname - Type the domain name *techadssl.com* or IP address *192.168.56.3*.

---

*Important: Without the TLS encryption enabled, you can type either the domain name or IP address in this field, but you must type the fully qualified domain name if the TLS encryption is enabled.*

---

- Use settings from LDAP server - Leave the checkbox deselected.
- Type of LDAP Server - Select "Microsoft Active Directory" from the drop-down list.
- LDAP over SSL - Have the checkbox deselected since the TLS encryption is not applied in this example.
- Port - Ensure the field is set to *389*.
- SSL Port and Server Certificate - Skip the two fields since the TLS encryption is not enabled.
- Use Bind Credentials - Do NOT select this checkbox because anonymous bind is used.
- Bind DN, Bind Password and Confirm Bind Password -- Skip the three fields because anonymous bind is used.



- Base DN for Search - Type `dc=techadssl,dc=com` as the starting point where your search begins on the AD server.
- Login Name Attribute - Ensure the field is set to `sAMAccountName` because the LDAP server is Microsoft Active Directory.
- User Entry Object Class - Ensure the field is set to `user` because the LDAP server is Microsoft Active Directory.
- User Search Subfilter - The field is optional. The subfilter information is also useful for filtering out additional objects in a large directory structure. In this example, we leave it blank.
- Active Directory Domain - Type `techadssl.com`.

**Create new LDAP Server Configuration**

IP Address / Hostname:  ⓘ

Use settings from LDAP Server

Select LDAP Server:  ▼

Type of LDAP Server:  ▼

LDAP over SSL

Port:

SSL Port:

Use only trusted LDAP Server Certificates

Server Certificate: not set

Anonymous Bind

Use Bind Credentials

Bind DN:

Bind Password:

Confirm Bind Password:

Base DN for Search:

Login Name Attribute:

User Entry Object Class:

User Search Subfilter:

Active Directory Domain:

5. Click OK. The LDAP server is saved.

6. Click OK. The LDAP authentication is activated.

---

*Note: If the PX clock and the LDAP server clock are out of sync, the installed TLS certificates, if any, may be considered expired. To ensure proper synchronization, administrators should configure the PX and the LDAP server to use the same NTP server(s).*

---

---

## Step D. Configure User Groups on the PX Device

A role on the PX device determines the system and outlet permissions. You must create the roles whose names are identical to the user groups created for the PX on the AD server or authorization will fail. Therefore, we will create the roles named *PX\_User* and *PX\_Admin* on the PDU.

In this illustration, we assume:

- Users assigned to the *PX\_User* role can neither configure PX nor access the outlets.
- Users assigned to the *PX\_Admin* role have the Administrator permissions so they can both configure PX and access the outlets.

► **To create the *PX\_User* role with appropriate permissions assigned:**

1. Choose User Management > Roles. The Manage Roles dialog appears.

---

*Tip: You can also access the Manage Roles dialog by clicking the Manage Roles button in the Edit User 'XXX' dialog.*

---

2. Click New. The Create New Role dialog appears.
3. Type `PX_User` in the Role Name field.
4. Type a description for the *PX\_User* role in the Description field. In this example, we type "The role can only view PX settings" to describe the role.
5. Click the Privileges tab to select all View XXX permissions (where XXX is the name of the setting). A View XXX permission lets users view the XXX settings without the capability to configure or change them.
  - a. Click Add. The "Add Privileges to new Role" dialog appears.
  - b. Select a permission beginning with the word "View" from the Privileges list, such as View Event Settings.
  - c. Click Add.

- d. Repeat Steps a to c to add all permissions beginning with "View."

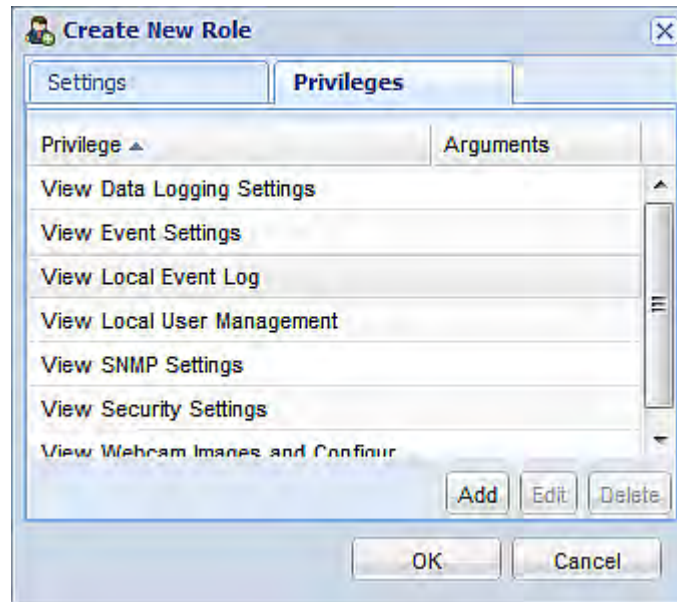

6. Click OK. The PX\_User role is created.



7. Keep the Manage Roles dialog opened to create the PX\_Admin role.

► **To create the PX\_Admin role with full permissions assigned:**

1. Click New. The Create New Role dialog appears.
2. Type PX\_Admin in the Role Name field.

3. Type a description for the PX\_Admin role in the Description field. In this example, we type "The role includes all privileges" to describe the role.
4. Click the Privileges tab to select the Administrator permission. The Administrator permission allows users to configure or change all PX settings.
  - a. Click Add. The "Add Privileges to new Role" dialog appears.
  - b. Select the permission named Administrator Privileges from the Privileges list.
  - c. Click Add.

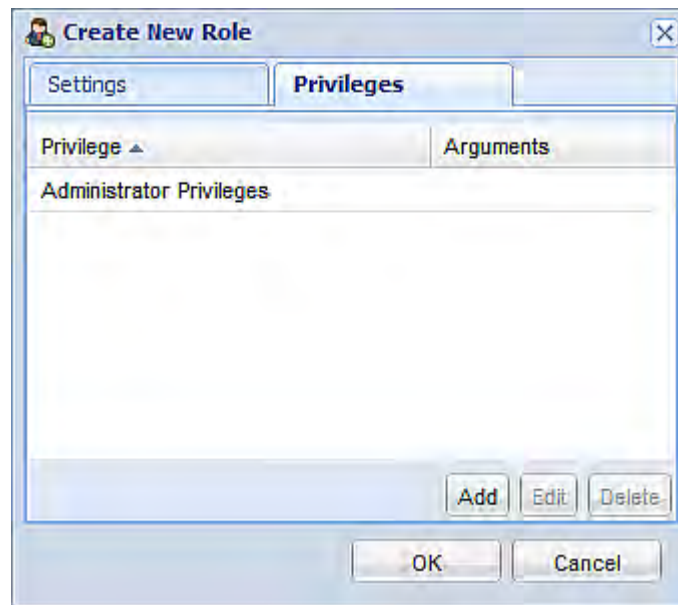

- Click OK. The PX\_Admin role is created.



- Click Close to quit the dialog.

# Appendix G RADIUS Configuration Illustration

This section provides illustrations for configuring RADIUS authentication. One illustration is based on the Microsoft® Network Policy Server (NPS), and the other is based on a non-Windows RADIUS server, such as FreeRADIUS.

The following steps are required for any RADIUS authentication:

1. Configure RADIUS authentication on the PX device. See **Adding RADIUS Server Settings** (on page 167).
2. Configure roles on the PX device. See **Creating a Role** (on page 138).
3. Configure your RADIUS server. See **Microsoft Network Policy Server** (on page 538) or **Non-Windows RADIUS Server** (on page 562).

## In This Chapter

Microsoft Network Policy Server .....	538
Non-Windows RADIUS Server .....	562

---

## Microsoft Network Policy Server

In this Microsoft NPS illustration, we assume that the NPS is running on the Windows 2008 system.

Three major steps are required for configuring Windows 2008 NPS:

- a. Add your PX device to NPS as a RADIUS client
- b. Configure connection request policies on NPS
- c. Configure a vendor-specific attribute on NPS

Some configuration associated with Microsoft Active Directory (AD) is also required for RADIUS authentication. See **AD-Related Configuration** (on page 559).

---

**Step A: Add Your PX as a RADIUS Client**

The RADIUS implementation on a PX follows the standard RADIUS Internet Engineering Task Force (IETF) specification so you must select "RADIUS Standard" as its vendor name when configuring the NPS server.

In this illustration, we assume:

- IP address of your PX: 192.168.56.29
- RADIUS authentication port specified for PX: 1812
- RADIUS accounting port specified for PX: 1813

► **To add your PX to the RADIUS NPS:**

1. Choose Start > Administrative Tools > Network Policy Server. The Network Policy Server console window opens.

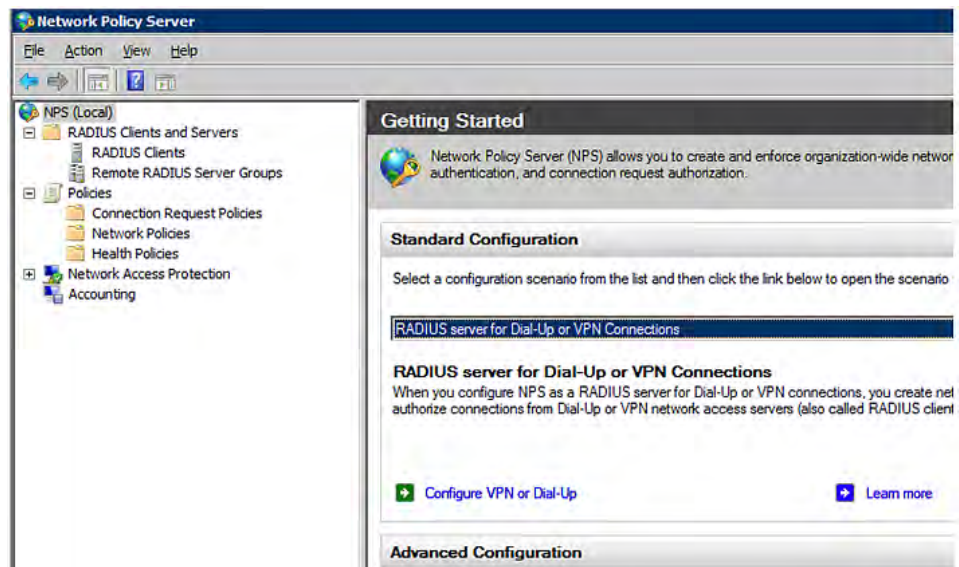



2. Right-click NPS (Local), and select Properties.

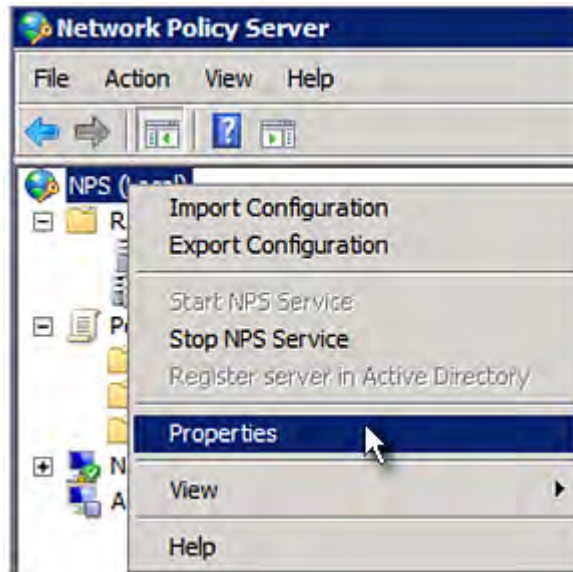

Verify the authentication and accounting port numbers shown in the properties dialog are the same as those specified on your PX. In this example, they are 1812 and 1813. Then close this dialog.

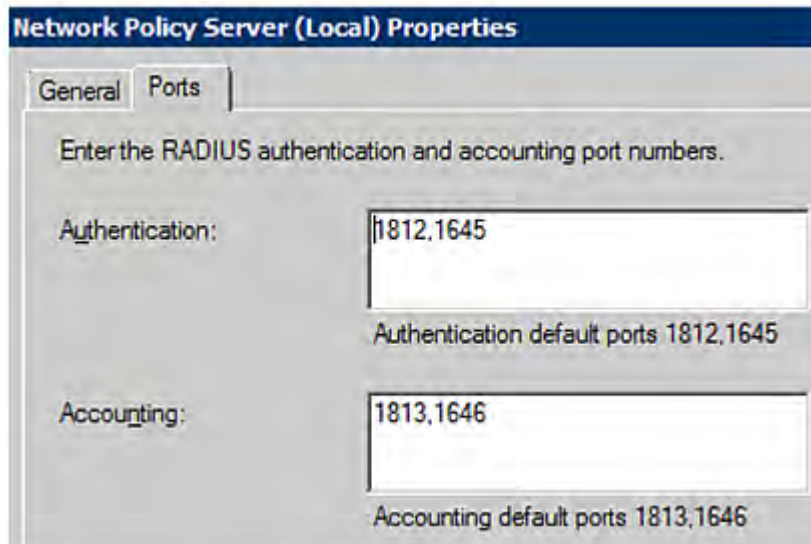



3. Under "RADIUS Clients and Servers," right-click RADIUS Client and select New RADIUS Client. The New RADIUS Client dialog appears.

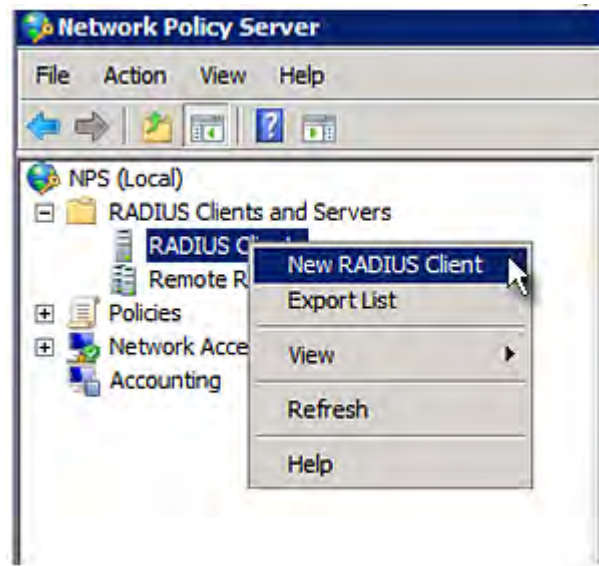

4. Do the following to add your PX to NPS:
  - a. Verify the "Enable this RADIUS client" checkbox is selected.
  - b. Type a name for identifying your PX in the "Friendly name" field.
  - c. Type *192.168.56.29* in the "Address (IP or DNS)" field.
  - d. Select *RADIUS Standard* in the "Vendor name" field.
  - e. Select the *Manual* radio button.

- f. Type the shared secret in the "Shared secret" and "Confirm shared secret" fields. The shared secret must be the same as the one specified on your PX.

**New RADIUS Client**

Enable this RADIUS client

Name and Address

Friendly name:  
RaritanDominion

Address (IP or DNS):  
192.168.56.29 Verify...

Vendor

Specify RADIUS Standard for most RADIUS clients, or select the RADIUS client vendor from the list.

Vendor name:  
RADIUS Standard

Shared Secret

To manually type a shared secret, click Manual. To automatically generate a shared secret, click Generate. You must configure the RADIUS client with the same shared secret entered here. Shared secrets are case-sensitive.

Manual  Generate

Shared secret:  
.....

Confirm shared secret:  
.....

Additional Options

Access-Request messages must contain the Message-Authenticator attribute

RADIUS client is NAP-capable

OK Cancel

- 5. Click OK.

### Step B: Configure Connection Request Policies

You need to configure the following for connection request policies:

- a. IP address or host name of the PX

- b. Connection request forwarding method
- c. Authentication method(s)
- d. Standard RADIUS attributes

In the following illustration, we assume:

- *Local* NPS server is used
- IP address of your PX: *192.168.56.29*
- RADIUS protocol selected on your PX: *CHAP*
- Existing role of your PX: *Admin*

► **To configure connection request policies:**

1. Open the NPS console, and expand the Policies folder.

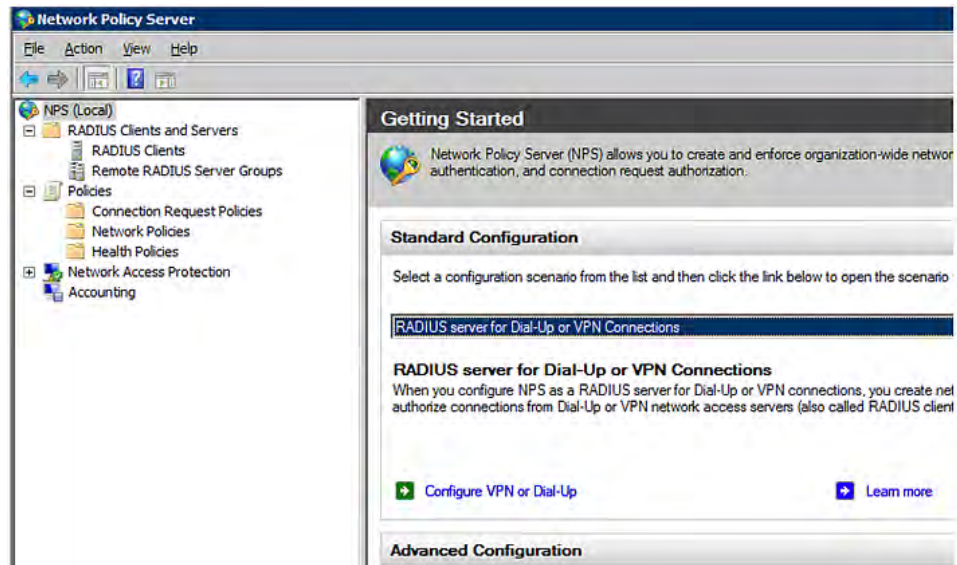

2. Right-click Connection Request Policies and select New. The New Connection Request Policy dialog appears.

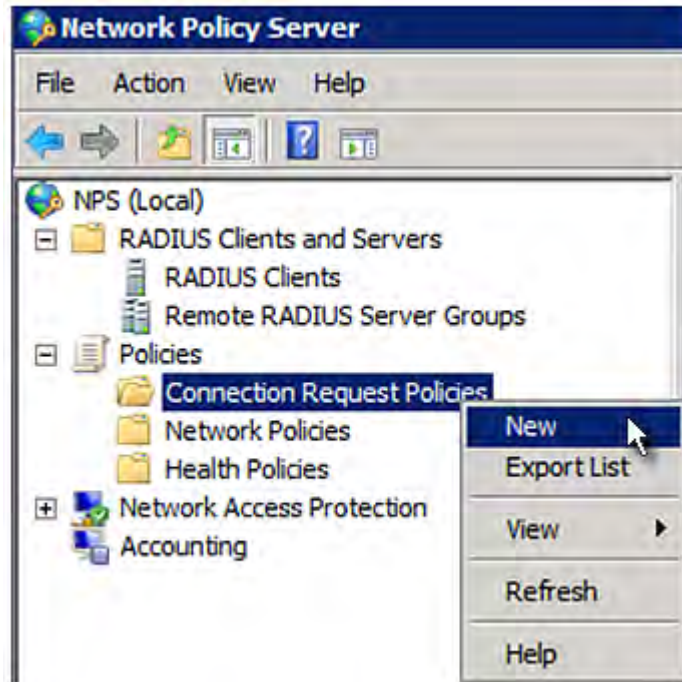

3. Type a descriptive name for identifying this policy in the "Policy name" field.

- You can leave the "Type of network access server" field to the default -- Unspecified.

**New Connection Request Policy**

 **Specify Connection Request Policy Name**

You can specify a name for your connection request policy and it will be applied.

**Policy name:**  
RaritanDominionPolicy

**Network connection method**  
Select the type of network access server that sends the connection request to NPS.  
Type or Vendor specific.

**Type of network access server:**  
Unspecified

**Vendor specific:**  
TO

4. Click Next to show the "Specify Conditions" screen. Click Add.

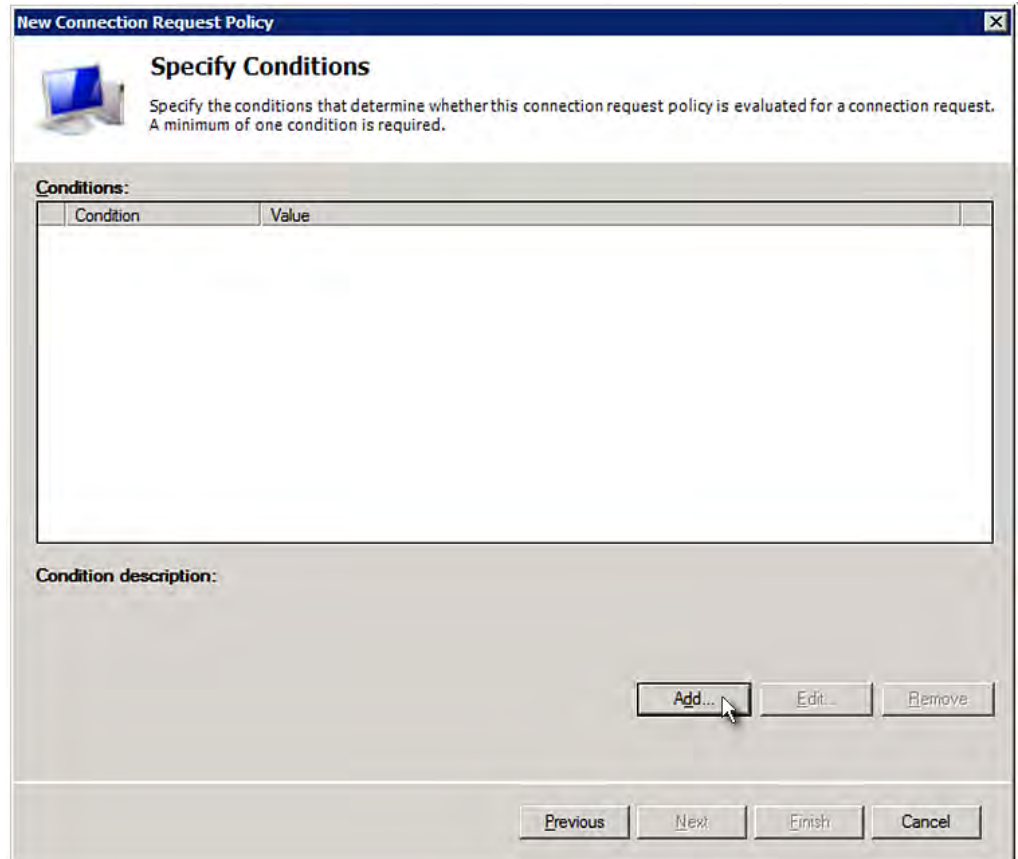

5. The "Select condition" dialog appears. Click Add.

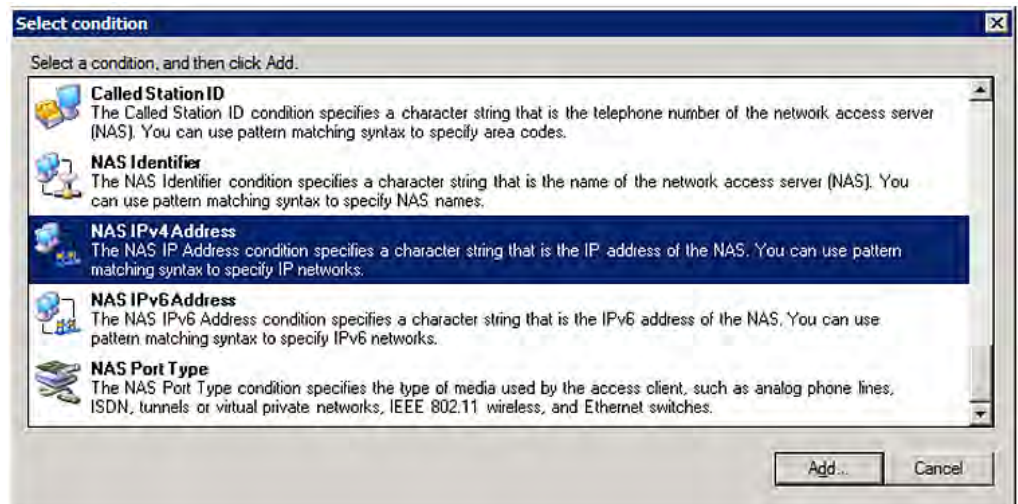



- The NAS IPv4 Address dialog appears. Type the PX IP address -- 192.168.56.29, and click OK.

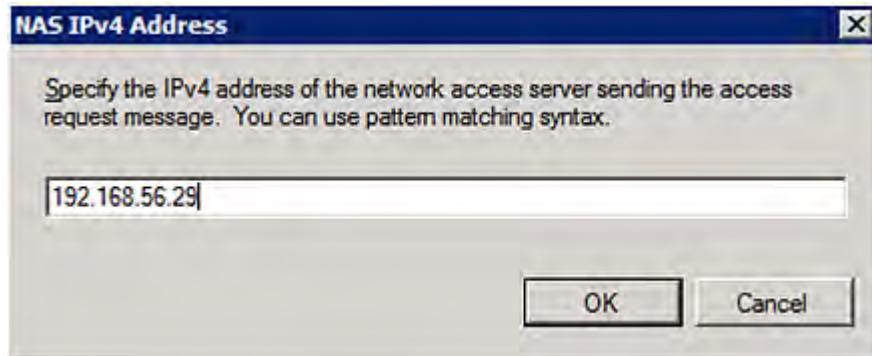

- Click Next in the New Connection Request Policy dialog.

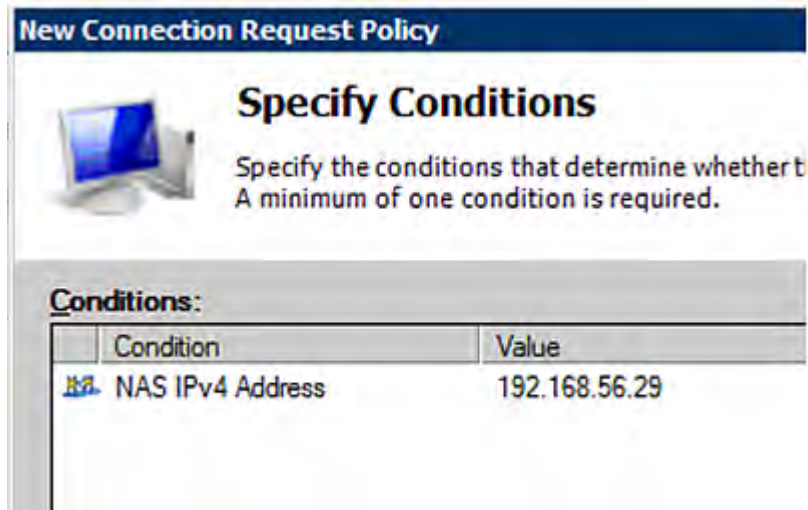

- Select "Authenticate requests on this server" because a local NPS server is used in this example. Then click Next.

---

*Note: Connection Request Forwarding options must match your environment.*

---

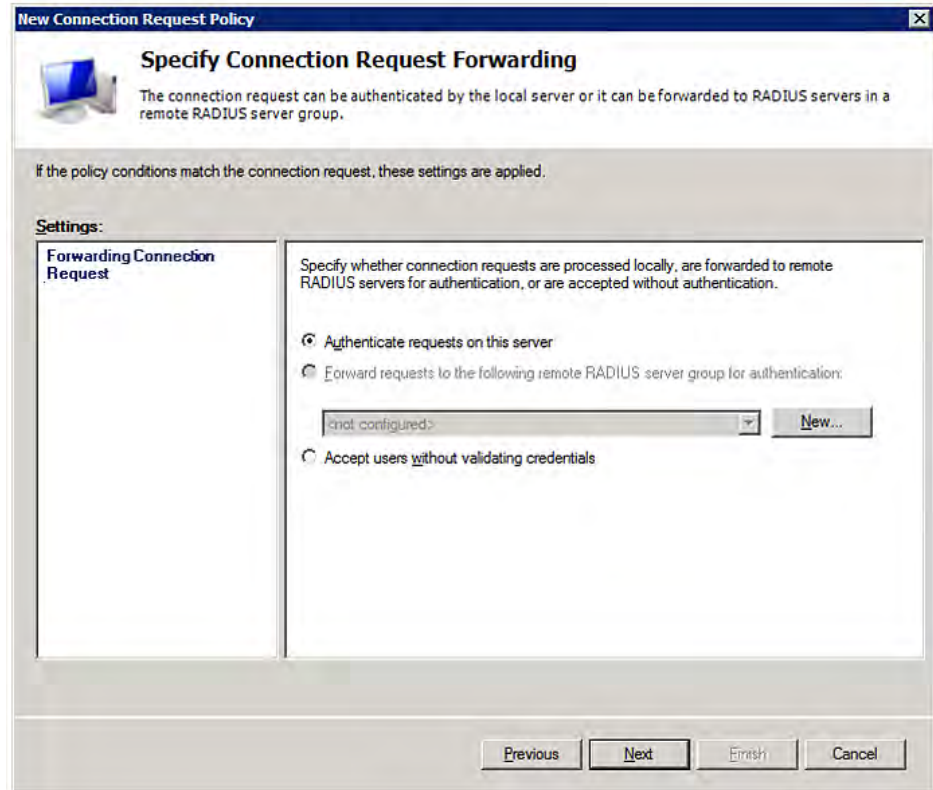

9. When the system prompts you to select the authentication method, select the following two options:
  - Override network policy authentication settings
  - CHAP -- the PX uses "CHAP" in this example



---

*Note: If your PX uses PAP, then select "PAP."*

---

**New Connection Request Policy**

 **Specify Authentication Methods**

Configure one or more authentication methods required authentication, you must configure an EAP type. If you d Protected EAP.

**Override network policy authentication settings**

These authentication settings are used rather than the constraints and auth connections with NAP. you must configure PEAP authentication here.

EAP types are negotiated between NPS and the client in the order in which

**EAP Types:**

**Less secure authentication methods:**

- Microsoft Encrypted Authentication version 2 (MS-CHAP-v2)
  - User can change password after it has expired
- Microsoft Encrypted Authentication (MS-CHAP)
  - User can change password after it has expired
- Encrypted authentication (CHAP)
- Unencrypted authentication (PAP, SPAP)
- Allow clients to connect without negotiating an authentication method.

10. Select Standard to the left of the dialog and then click Add.

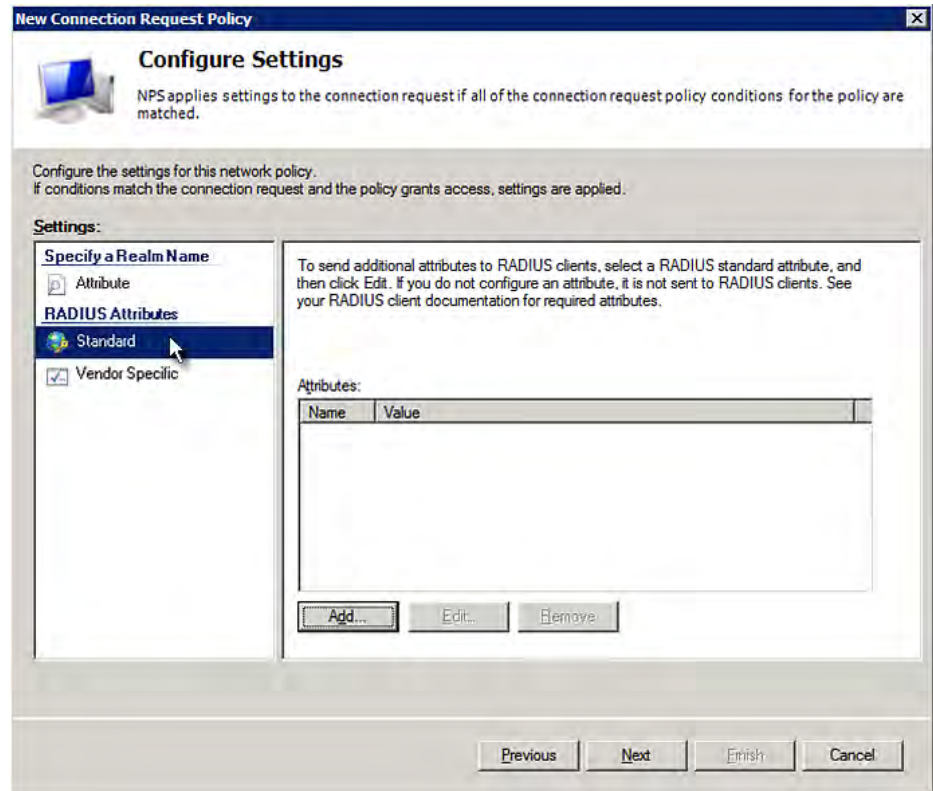

11. Select Filter-Id from the list of attributes and click Add.

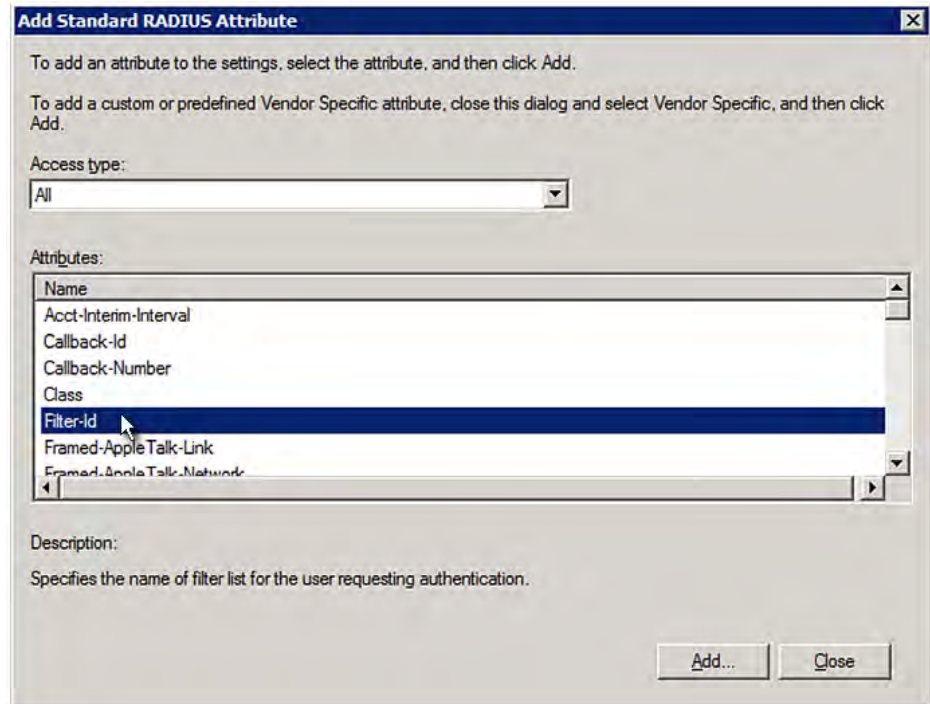

12. In the Attribute Information dialog, click Add.

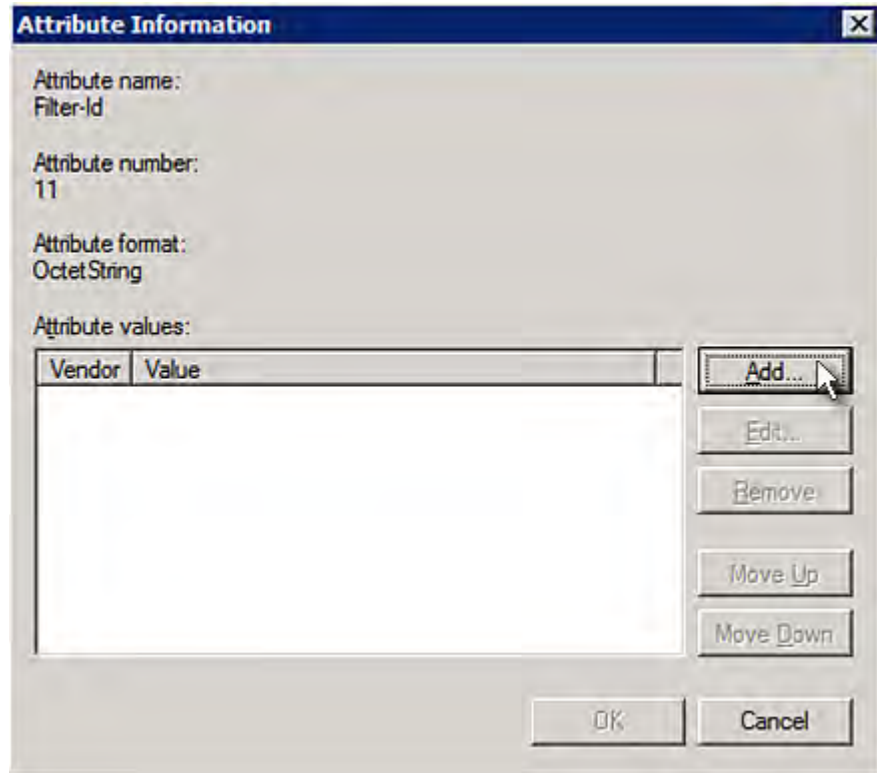

13. Select String, type *Raritan:G{Admin}* in the text box, and then click OK.

*Admin* inside the curved brackets {} is the existing role on the PX. It is recommended to use the Admin role to test this configuration. The role name is case sensitive.

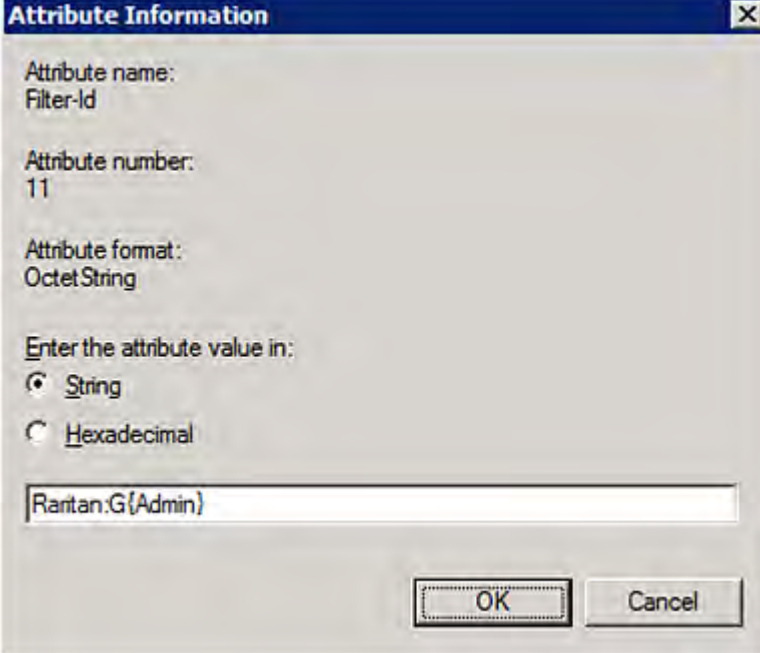

The image shows a dialog box titled "Attribute Information" with a close button (X) in the top right corner. The dialog contains the following fields and options:

- Attribute name: Filter-Id
- Attribute number: 11
- Attribute format: OctetString
- Enter the attribute value in:
  - String
  - Hexadecimal
- A text input field containing the value: Raritan.G{Admin}
- Buttons: OK and Cancel

14. The new attribute is added. Click OK.

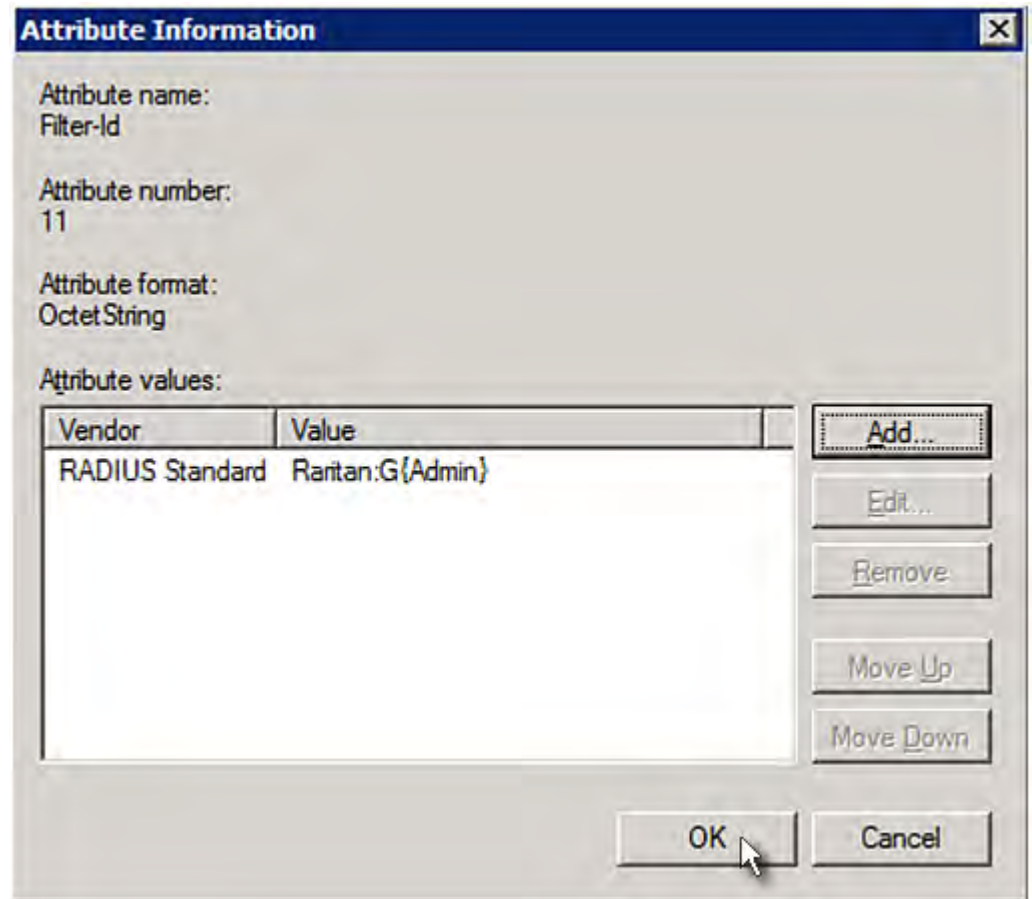

15. Click Next to continue.

**New Connection Request Policy**

### Configure Settings

NPS applies settings to the connection request if all of the connect matched.

Configure the settings for this network policy.  
If conditions match the connection request and the policy grants access, settings are a

**Settings:**

**Specify a Realm Name**

Attribute

**RADIUS Attributes**

Standard

Vendor Specific

To send additional attributes to RADIUS client then click Edit. If you do not configure an attr your RADIUS client documentation for require

Attributes:

Name	Value
Filter-Id	Rantan:G{Admin}

16. A summary showing connection request policy settings is displayed. Click Finish to close the dialog.

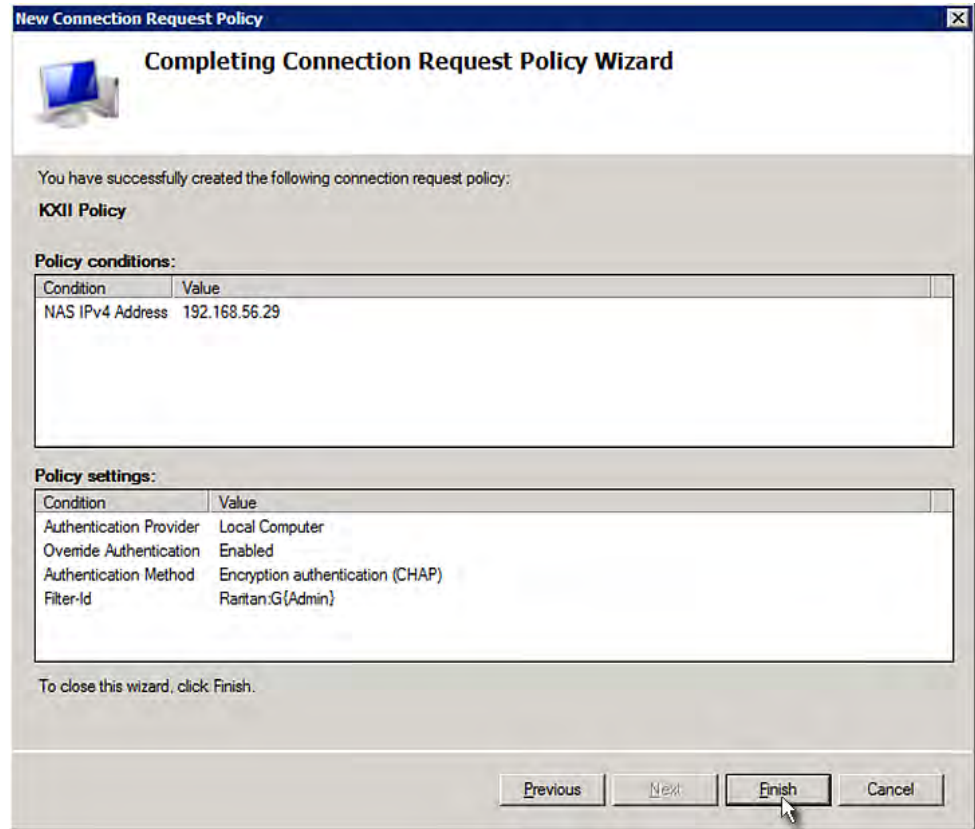



### Step C: Configure a Vendor-Specific Attribute

You must specify a vendor-specific attribute (VSA) for Raritan on Windows 2008 NPS. Raritan's vendor code is **13742**.

In the following illustration, we assume:

- There are three roles available on your PX: *Admin*, *User*, and *SystemTester*.

#### ► To configure VSA:

1. Open the NPS console, and expand the Policies folder.

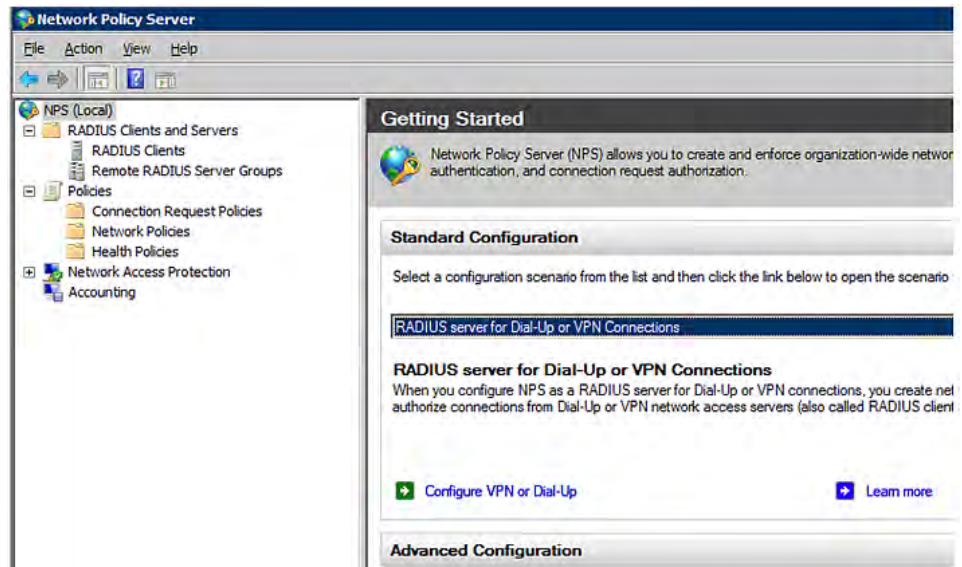

2. Select Connection Request Policies and double-click the policy where you want to add a custom VSA. The policy's properties dialog appears.
3. Click the Settings tab.
4. Select Vendor Specific, and click Add. The Add Vendor Specific Attribute dialog appears.
5. Select Custom in the Vendor field, and click Add. The Attribute Information dialog appears.
6. Click Add, and the Vendor-Specific Attribute Information dialog appears.
7. Click "Enter Vendor Code" and type *13742*.
8. Select "Yes, it conforms" to indicate that the custom attribute conforms to the RADIUS Request For Comment (RFC).
9. Click Configure Attribute, and then:
  - a. Type 26 in the "Vendor-assigned attribute number" field.

- b. Select String in the "Attribute format" field.
- c. Type *Raritan:G{Admin User SystemTester}* in the "Attribute value" field. In this example, three roles are specified inside the curved brackets {} -- Admin, User and SystemTester.

Note that different roles must be separated with a space.

10. Click OK.

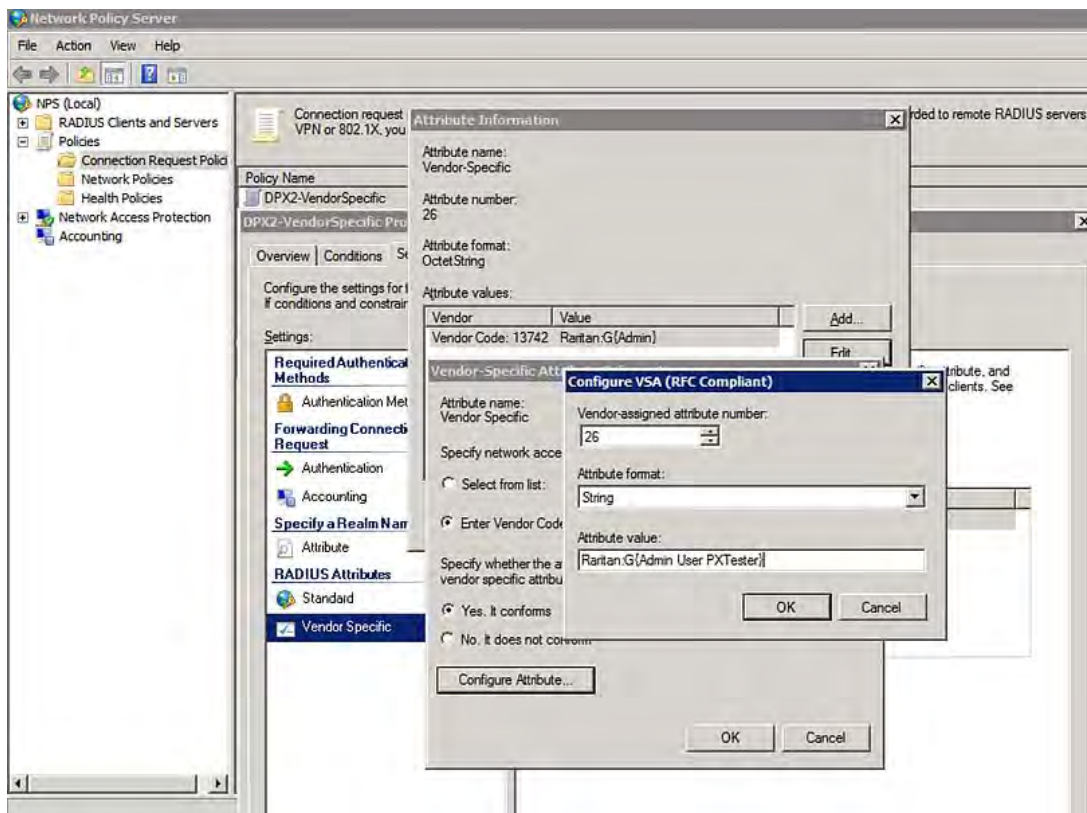

---

### AD-Related Configuration

When RADIUS authentication is intended, make sure you also configure the following settings related to Microsoft Active Directory (AD):

- Register the NPS server in AD
- Configure remote access permission for users in AD

The NPS server is registered in AD only when NPS is configured for the FIRST time and user accounts are created in AD.

If CHAP authentication is used, you must enable the following feature for user accounts created in AD:

- Store password using reversible encryption

---

**Important: Reset the user password if the password is set before you enable the "Store password using reversible encryption" feature.**

---

► **To register NPS:**

1. Open the NPS console.
2. Right-click NPS (Local) and select "Register server in Active Directory."

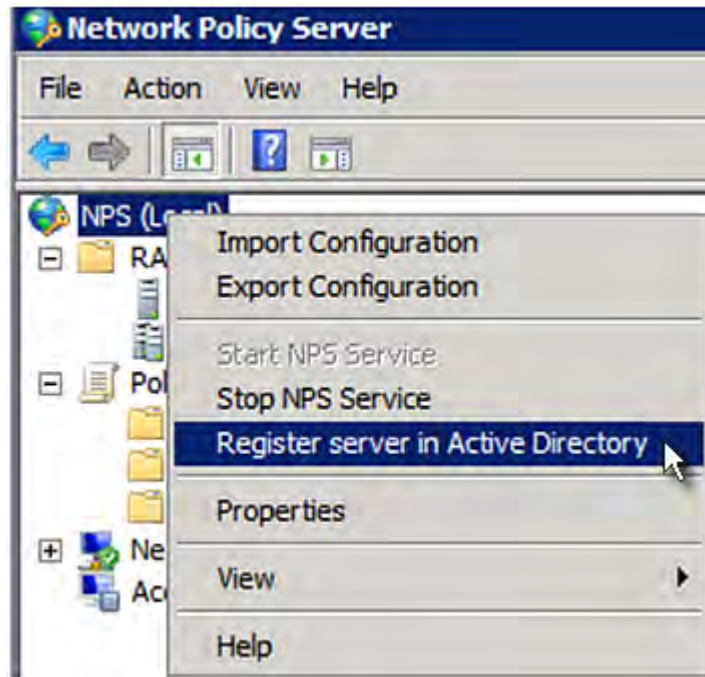

3. Click OK, and then OK again.

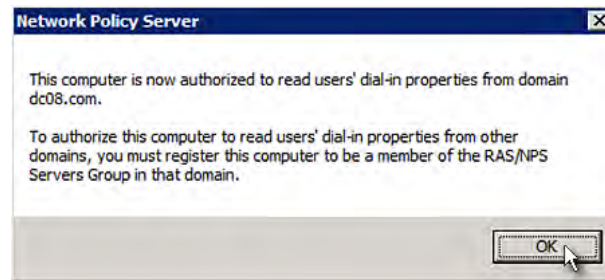

► **To grant PX users remote access permission:**

1. Open Active Directory Users and Computers.
2. Open the properties dialog of the user whom you want to grant the access permission.

- Click the Dial-in tab and select the "Allow access" checkbox.

The screenshot shows the 'Dial-in' sub-tab of the 'Terminal Services Profile' dialog box. The 'Network Access Permission' section is expanded, showing three radio button options: 'Allow access' (selected), 'Deny access', and 'Control access through NPS Network Policy'. Below this is a 'Verify Caller-ID' checkbox and an empty text field. The 'Callback Options' section has three radio button options: 'No Callback' (selected), 'Set by Caller (Routing and Remote Access Service only)', and 'Always Callback to:' followed by an empty text field. The 'Assign Static IP Addresses' section has a checkbox and a 'Static IP Addresses...' button. The 'Apply Static Routes' section has a checkbox and a 'Static Routes...' button. At the bottom are 'OK', 'Cancel', 'Apply', and 'Help' buttons.

► **To enable reversible encryption for CHAP authentication:**

- Open Active Directory Users and Computers.
- Open the properties dialog of the user that you want to configure.

3. Click the Account tab and select the "Store password using reversible encryption" checkbox.

The screenshot shows the 'Account' tab in the Local Security and Authentication console. The 'User logon name' is 'DC08\Administrator'. Under 'Account options', the 'Store password using reversible encryption' checkbox is checked. The 'Account expires' section is set to 'Never'. Buttons for 'Logon Hours...', 'Log On To...', 'OK', 'Cancel', 'Apply', and 'Help' are visible.

---

## Non-Windows RADIUS Server

For a non-Windows RADIUS server, such as FreeRADIUS, a vendor-specific dictionary file is required.

---

### Dictionary File

Create a vendor-specific dictionary file for Raritan and add the following information to it. Raritan's vendor code is **13742**.



```

# -*- text -*-
#
# dictionary.raritan
#
#
# Version:      $Id$
#
VENDOR          Raritan          13742
#
# Standard attribute
#
BEGIN-VENDOR    Raritan

ATTRIBUTE       Raritan-Vendor-Specific    26    string

END-VENDOR      Raritan

```

Note that "string" in the above contents must be replaced by `Raritan:G{roles}`, where "roles" are one or multiple roles to which the user belongs. For more details, see **Format of the "string"** (on page 563).

---

### Format of the "string"

The format of `string` in the dictionary file is:

```
Raritan:G{roles}
```

"roles" inside the curved brackets `{}` are role names, which comprise one or multiple roles to which the user belongs.

Multiple role names are separated with a space.

#### ► Example:

If the user has three roles -- *Admin*, *User* and *SystemTester*, then type:

```
Raritan:G{Admin User SystemTester}
```

Therefore, in Raritan's dictionary file, the attribute line is like the following:

Appendix G: RADIUS Configuration Illustration

```
ATTRIBUTE Raritan-Vendor-Specific 26 Raritan:G{Admin User SystemTester}
```



# Appendix H Integration

The PX device can work with certain Raritan products to provide diverse power solutions.

## In This Chapter

Power IQ Configuration .....	565
Dominion KX II Configuration .....	568
Dominion KSX II or SX Configuration.....	573
dcTrack.....	581

---

## Power IQ Configuration

Raritan's Power IQ is a software application that collects and manages the data from different PDUs installed in your server room or data center. With this software, you can:

- Do bulk configuration for multiple PDUs
- Name outlets on different PDUs
- Switch on/off outlets on outlet-switching capable PDUs

For more information on Power IQ, see either of the following available on Raritan's website:

- Power IQ User Guide: Available on the **Support page** (<http://www.raritan.com/support/>).
- Power IQ Online Help: Available on the **Product Online Help page** (<http://www.raritan.com/support/online-help/>).

---

*Note: Power IQ supports the port forwarding mode comprising 2 PDUs as of release 4.3.0. For more information on the USB-cascading configuration, see the USB-Cascading Solution Guide, which is available from Raritan website's **PX2 Support Files page** (<https://www.raritan.com/support/product/px2/px2-support-files>).*

---

---

### Adding PDUs to Power IQ Management

Once Power IQ is configured, add Raritan PX or other PDUs to its management. Power IQ can then gather data from these PDUs. If you're adding a PDU that uses a custom dynamic plugin, see Adding PDUs with Custom Dynamic Plugins.

You can also add PDUs to Power IQ by uploading a CSV file containing the information. See Adding PDUs in Bulk with CSV Files in the Power IQ User Guide.

► **To add PDUs to Power IQ management:**

1. In the PDUs tab, click Add.
2. Enter the IP address of the PDU.
3. If the PDU is in a daisy-chained configuration or console server configuration, enter the PDU's position number in the chain or serial port number in the Proxy Index field. For example, this field is mandatory for a *slave* Raritan PDU in the port forwarding configuration. See Adding Raritan PDUs in the Port Forwarding Configuration.

You can also specify branch circuit monitors using the Proxy Index field. See Adding Veris Branch Circuit Monitors with Acquisuite.

---

*Note: If the PDU is not in this type of configuration, leave the Proxy Index field blank.*

---

4. Enter an asset tag number or other asset management code in the External Key field. **Optional.**
5. Enter data in Custom Field 1 and Custom Field 2. **Optional.** The labels may have been changed in Power IQ to identify these fields.
6. If the PDU is a Raritan PX, enter a valid Username and Password for the PDU in the PDU Administrative Credentials section. Re-enter the password in the Password Confirm field.
7. Select the SNMP Version.
  - For SNMP version 1/2c PDUs, enter an SNMP Community String that has at least READ permissions to this PDU. This enables polling the PDU for data. Enter an SNMP community string that has both READ and WRITE permissions to the PDU to enable power control, outlet naming, sensor naming, and buffered data retrieval.
  - For SNMP version 3 PDUs, enter the Username and select an Authorization Level. The authorization levels are:

- noAuthNoPriv - No Authentication Passkey, No Encoding Passkey
  - authNoPriv - Authentication Passkey, No Encoding Passkey
  - authPriv - Authentication Passkey, Encoding Passkey
- a. Depending on the Authorization Level selected, you must enter additional credentials for Authorization and Privacy.
  - b. Authorization Protocol: Select MD5 or SHA.
  - c. Enter the PDU's Authorization Passkey, then re-enter the passkey in the Authorization Passkey Confirm field.
  - d. Privacy Protocol: Select DES or AES.
  - e. Enter the PDU's Privacy Passkey, then re-enter the passkey in the Privacy Passkey Confirm field.

---

*Note: You must enable the SNMP agent on all PDUs added to Power IQ.*

---

8. Select "Validate and wait for discovery to complete before proceeding" to check credentials and view the discovery process status as you add this PDU. **Optional.** See Validating PDU Credentials in the Power IQ User Guide.
9. Click Add.

---

*Note: PDU discovery is complete once the PDU model type is determined. SNMP fields such as contact or location values are not determined until this device is polled for the first time.*

---

Once added, the PDU appears in the PDU list. Power IQ begins polling the PDU for sensor data. You can configure how often Power IQ polls PDU. See Configuring Polling Intervals in the Power IQ User Guide.

---

## Dominion KX II Configuration

Raritan PX2, PX3 or PX3TS series can be connected to the Raritan's Dominion KX II device (a digital KVM switch) to provide one more alternative of power management.

Note that this integration requires the following firmware versions:

- Dominion KX II -- 2.4 or later
- PX2 series -- 2.2 or later
- PX3 series -- 2.5.10 or later
- PX3TS series -- 2.6.1 or later

Dominion KX II integration requires D2CIM-PWR and straight CAT5 cable.

For more information on Dominion KX II, see either of the following:

- Dominion KX II User Guide: Available on the Raritan website's **Support page** (<http://www.raritan.com/support/>).
- Dominion KX II Online Help: Available on the **Product Online Help page** (<http://www.raritan.com/support/online-help/>).

---

### Configuring Rack PDU (Power Strip) Targets

The KX II allows you to connect rack PDUs (power strips) to KX II ports. KX II rack PDU configuration is done from the KX II Port Configuration page.

---

*Note: Raritan recommends no more than eight (8) rack PDUs (power strips) be connected to a KX II at once since performance may be affected.*

---

### Connecting a Rack PDU

Rack PDUs are connected to the KX II using the D2CIM-PWR CIM.

► **To connect the rack PDU:**

1. Connect the male RJ-45 of the D2CIM-PWR to the female RJ-45 connector labeled "FEATURE" of the rack PDU.
2. Connect the female RJ-45 connector of the D2CIM-PWR to any of the available female system port connectors on the KX II using a straight through Cat5 cable.
3. Attach an AC power cord to the target server and an available rack PDU outlet.
4. Connect the rack PDU to an AC power source.

5. Power on the device.



### Naming the Rack PDU in the KX II or LX (Port Page for Power Strips)

---

*Note: PX rack PDUs (power strips) can be named in the PX as well as in KX II and LX.*

---

Once a Raritan remote rack PDU is connected to the KX II or LX, it will appear on the Port Configuration page. Click on the power port name on that page to access it. The Type and the Name fields are prepopulated.

---

*Note: The (CIM) Type cannot be changed.*

---

The following information is displayed for each outlet on the rack PDU: [Outlet] Number, Name, and Port Association.

Use this page to name the rack PDU and its outlets. Names can be up to 32 alphanumeric characters and can include special characters.

---

*Note: When a rack PDU is associated with a target server (port), the outlet name is replaced by the target server name, even if you assigned another name to the outlet.*

---

#### ► To name the rack PDU and outlets:

---

*Note: CommandCenter Secure Gateway does not recognize rack PDU names containing spaces.*

---

1. Enter the Name of the rack PDU (if needed).
2. Change the [Outlet] Name if desired. (Outlet names default to the outlet #.)

3. Click OK.

Home > Device Settings > Port Configuration > Port

---

**Port 17**

**Type:**  
PowerStrip

**Name:**

---

**Outlets**

Number	Name	Port Association
1	<input type="text" value="Dominion-Port1(1)"/>	<b>Dominion- Port7</b>
2	<input type="text" value="Outlet 2"/>	
3	<input type="text" value="Outlet 3"/>	
4	<input type="text" value="Outlet 4"/>	
5	<input type="text" value="Outlet 5"/>	
6	<input type="text" value="Outlet 6"/>	
7	<input type="text" value="Outlet 7"/>	
8	<input type="text" value="Outlet 8"/>	

### Associating Outlets with Target Servers on KX II and LX

The Port page opens when you click on a port on the Port Configuration page. From this page, you can make power associations, change the port name to something more descriptive, and update target server settings if you are using the D2CIM-VUSB CIM. The (CIM) Type and the (Port) Name fields are prepopulated; note that the CIM type cannot be changed.

A server can have up to four power plugs and you can associate a different rack PDU (power strip) with each. From this page, you can define those associations so that you can power on, power off, and power cycle the server from the Port Access page.

To use this feature, you will need:

- Raritan remote rack PDU(s)
- Power CIMs (D2CIM-PWR)

► **To make power associations (associate rack PDU outlets to KVM target servers):**

---

*Note: When a rack PDU is associated to a target server (port), the outlet name is replaced by the target server name (even if you assigned another name to the outlet).*

---

1. On the Port Configuration page, select the target server you are associating the PDU with.
2. Choose the rack PDU from the Power Strip Name drop-down list.
3. For that rack PDU, choose the outlet from the Outlet Name drop-down list.
4. Repeat steps 1 and 2 for all desired power associations.
5. Click OK. A confirmation message is displayed.

► **To change the port name:**

1. Type something descriptive in the Name field. For example, the name of the target server would be a likely candidate. The name can be up to 32 alphanumeric characters and can include special characters.
2. Click OK.

### Removing Power Associations

When disconnecting target servers and/or rack PDUs from the device, all power associations should first be deleted. When a target has been associated with a rack PDU and the target is removed from the device, the power association remains. When this occurs, you are not able to access the Port Configuration for that disconnected target server in Device Settings so that the power association can be properly remove.

► **To remove a rack PDU association:**

1. Select the appropriate rack PDU from the Power Strip Name drop-down list.
2. For that rack PDU, select the appropriate outlet from the Outlet Name drop-down list.
3. From the Outlet Name drop-down list, select None.
4. Click OK. That rack PDU/outlet association is removed and a confirmation message is displayed.

► **To remove a rack PDU association if the rack PDU has been removed from the target:**

1. Click Device Settings > Port Configuration and then click on the active target.
2. Associate the active target to the disconnected power port. This will break the disconnected target's power association.

Finally, associate the active target to the correct power port.



---

## Dominion KSX II or SX Configuration

Raritan PX2, PX3 and PX3TS series support the integration with Raritan's Dominion KSX II or SX serial access products.

Different cables are needed when connecting to different Raritan access products.

- Use a Category 5 cable to connect from the PDU (power control) port of the Dominion KSX II to the FEATURE port of the PX.
- Use a CSCSPCS cable to connect from the PDU port of the Dominion SX to the FEATURE port of the PX.

---

*Note: To only access the CLI of the PX via the SX, you can treat the PX as a serial device by connecting to the PDU's serial port instead of the FEATURE port.*

---

For more information on either Raritan serial access product, see either of the following:

- Dominion KSX II or SX User Guide: Available on the Raritan website's **Support page** (<http://www.raritan.com/support/>).
- Dominion KSX II or SX Online Help: Available on the **Product Online Help page** (<http://www.raritan.com/support/online-help/>).

---

### Dominion KSX II

After connecting a Dominion KSX II to the Raritan PDU, you can monitor the PDU and even control its outlets if the PDU is an outlet-switching capable model.

#### Overview

The KSX II allows you to control Raritan PX and RPC series rack PDU (power strip) outlets. Once a PX or RPC series is setup and then attached to the KSX II, the rack PDU and its outlets can be controlled from the Powerstrip page in the KSX II interface. This page is accessed by clicking on the Power menu at the top of the page.

The Powerstrip page will display rack PDUs attached to the KSX II for which the user has been granted appropriate port access permissions.

---

*Note: For information on setting up a PX, see the **Raritan PX Online Help**.*

---

From the Powerstrip page, you are able to turn the outlets on and off, as well as cycle their power. You are also able to view the following power strip and outlet information:

- Powerstrip Device Information:
  - Name

- Model
- Temperature
- Current Amps
- Maximum Amps
- Voltage
- Power in Watts
- Power in Volts Ampere
- Outlet Display Information:
  - Name - Named assigned to the outlet when it was configured.
  - State - On or Off status of the outlet
  - Control - Turn outlets on or off, or cycle their power
  - Association - The ports associated with the outlet

Initially, when you open the Powerstrip page, the power strips that are currently connected to the KSX II are displayed in the Powerstrip drop-down.

Additionally, information relating to the currently selected power strip is displayed.

If no power strips are connected to the KSX II, a message stating "No powerstrips found" will be displayed in the Powerstrip Device section of the page.

Home > Powerstrip

*Operation completed successfully.*

**Powerstrip Device**

Powerstrip: rk-power

Name: Model: Temperature: CurrentAmps: MaxAmps: Voltage: PowerInWatt: PowerInVA:  
 rk-power PCR8 29 °C 0 A 0 A 118 V 3 W 0 VA

Name	State	Control	Associations
Outlet 1	on	<input type="button" value="On"/> <input type="button" value="Off"/> <input type="button" value="Cycle"/>	Dominion_Port9
Outlet 2	on	<input type="button" value="On"/> <input type="button" value="Off"/> <input type="button" value="Cycle"/>	
Outlet 3	on	<input type="button" value="On"/> <input type="button" value="Off"/> <input type="button" value="Cycle"/>	
Outlet 4	on	<input type="button" value="On"/> <input type="button" value="Off"/> <input type="button" value="Cycle"/>	
Outlet 5	on	<input type="button" value="On"/> <input type="button" value="Off"/> <input type="button" value="Cycle"/>	Dominion_Port2
Outlet 6	on	<input type="button" value="On"/> <input type="button" value="Off"/> <input type="button" value="Cycle"/>	
Outlet 7	on	<input type="button" value="On"/> <input type="button" value="Off"/> <input type="button" value="Cycle"/>	
Outlet 8	on	<input type="button" value="On"/> <input type="button" value="Off"/> <input type="button" value="Cycle"/>	

### Configuring KSX II Ports

The Port Configuration page displays a list of the KSX II ports.

Ports connected to KVM target servers (blades and standard servers) and rack PDUs (power strips) are displayed in blue, and can be edited.

If a KSX II port has no CIM connected or is connected to a CIM with no name, a default port name of **Dominion\_** is assigned to the port. **Dominion\_** is the device model and **Port#** is the number of the KSX II physical port. **Port#** is assigned, where **Port#** is the number of the KSX II physical port.

► **To access a port configuration:**

1. Choose Device Settings > Port Configuration. The Port Configuration Page opens.

This page is initially displayed in port number order, but can be sorted on any of the fields by clicking on the column heading.

- Port Number - Numbered from 1 to the total number of ports available for the KSX II device
- Port Name - The name assigned to the port

---

*Note: Do not use apostrophes for the Port (CIM) Name.*

---

- Port Type:

- DCIM - Dominion CIM
  - TierDevice - Tier device
  - Not Available - No CIM connected
  - PCIM - Paragon CIM
  - PowerStrip (rack PDU) - Power strip connected
  - Dual - VM - Virtual media CIM (D2CIM-VUSB and D2CIM-DVUSB)
  - Blade Chassis - Blade chassis and the blades associated with that chassis (displayed in a hierarchical order)
  - KVM Switch - Generic KVM Switch connection
  - DVM-DP - Display Port
  - DVM-HDMI - HDMI CIM
  - DVM-DVI - DVI CIM
2. Click the Port Name for the port you want to edit.
- For KVM ports, the Port page for KVM and blade chassis ports is opened.
  - For rack PDUs, the Port page for rack PDUs (power strips) is opened. From this page, you can name the rack PDUs and their outlets.
  - For serial ports, the Port page for serial ports is opened.

**Port Configuration**

▲ No.	Name	Type
1	KX-local	Not Available
2	Dominion_KSX2_Port2	Not Available
3	KX8-Local	Not Available
4	Dominion_KSX2_Port4	Not Available
5	Blade_Chassis_Port3	Not Available
6	Dominion_KSX2_Port6	Not Available
7	Dominion_KSX2_Port7	Not Available
8	Dominion_KSX2_Port8	Not Available
9	Serial Port 1	Serial
10	Serial Port 2	Serial
11	Serial Port 3	Serial
12	Serial Port 4	Serial
13	Serial Port 5	Serial
14	Serial Port 6	Serial
15	Serial Port 7	Serial
16	Serial Port 8	Serial
17	Power Port 1	PowerStrip
18	Power Port 2	PowerStrip

## Power Control

### ▶ To turn an outlet on:

1. Click the Power menu to access the Powerstrip page.
2. From the Powerstrip drop-down, select the PX rack PDU (power strip) you want to turn on.
3. Click Refresh to view the power controls.
4. Click On.
5. Click OK to close the Power On confirmation dialog. The outlet will be turned on and its state will be displayed as 'on'.

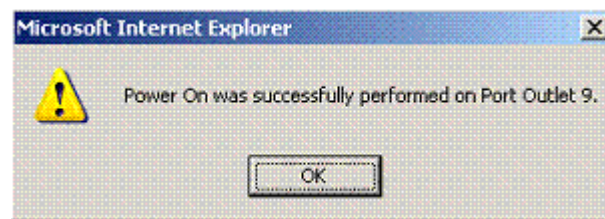

### ▶ To turn an outlet off:

1. Click Off.
2. Click OK on the Power Off dialog.

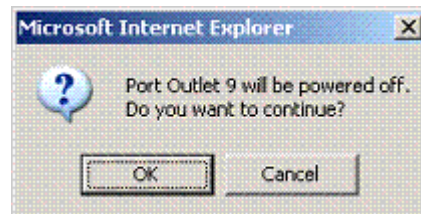

3. Click OK on the Power Off confirmation dialog. The outlet will be turned off and its state will be displayed as 'off'.

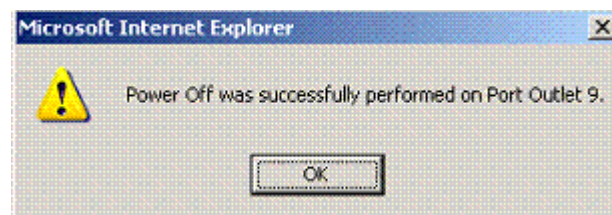

► **To cycle the power of an outlet:**

1. Click Cycle. The Power Cycle Port dialog opens.

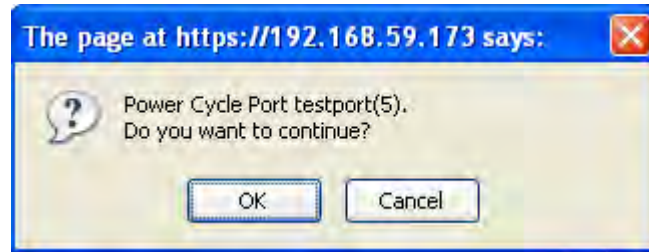

2. Click OK. The outlet will then cycle (note that this may take a few seconds).

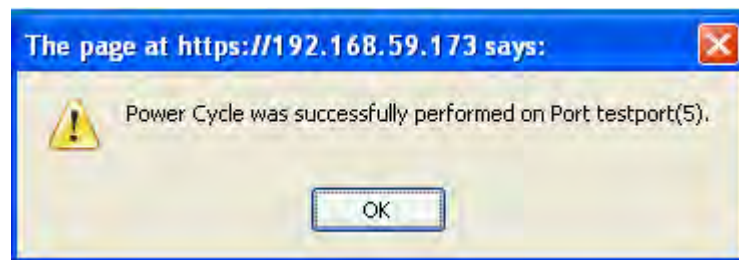

3. Once the cycling is complete the dialog will open. Click OK to close the dialog.

---

### **Dominion SX**

By connecting to a Dominion SX device, you can associate one or more outlets on a PX device to specific Dominion SX ports.

#### **Configuring a PX on Dominion SX**

1. Choose Setup > Power Strip Configuration.

2. Click Add. The Power Strip Configuration screen appears.

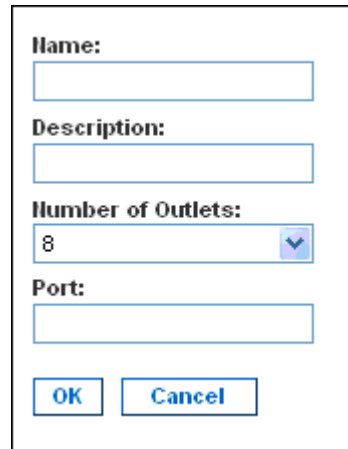

The image shows a configuration dialog box with the following fields and controls:

- Name:** A text input field.
- Description:** A text input field.
- Number of Outlets:** A drop-down menu with the value '8' selected.
- Port:** A text input field.
- Buttons:** 'OK' and 'Cancel' buttons at the bottom.

3. Type a name and description in the Name and Description fields.
4. Select the number of outlets from the Number of Outlets drop-down menu.
5. Type the port number in the Port field.
6. Click OK.

### Power Control

1. Choose Power Control > Power Strip Power Control. The Outlet Control screen appears.

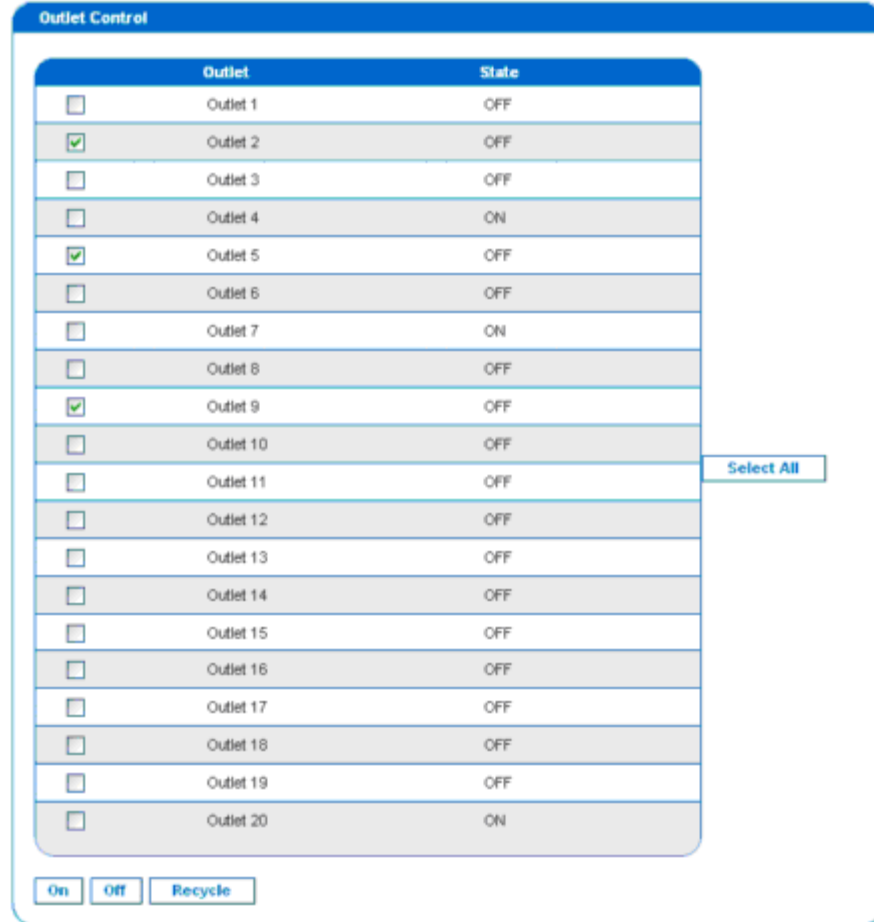

2. Check the box of outlet number you wish to control, and click On/Off buttons to power on/off the selected outlet(s).
3. A confirmation message appears, indicating successful operation.

***Outlet 19: The power operation has been sent.***

***The system shall reflect successful operations shortly.***



### Checking Power Strip Status

1. Choose Power Control > Power Strip Status.

#### DPX Status:

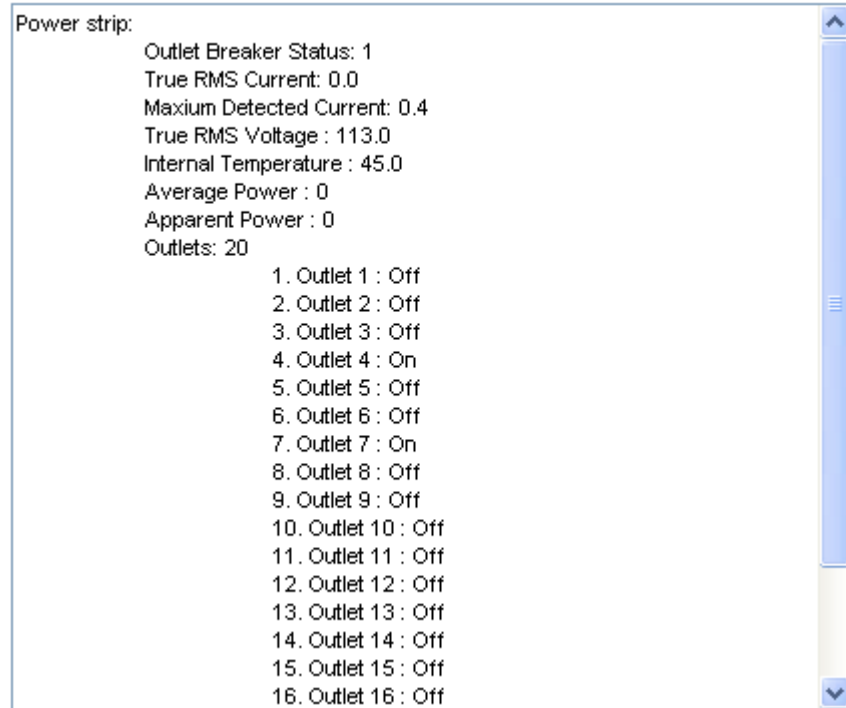

2. A status box appears, displaying details of the controlled PX, including power state of each outlet on the device.

---

## dcTrack

dcTrack® is a Raritan product that allows you to manage the data center. You can use dcTrack to:

- Record and manage the data center infrastructure and assets
- Monitor the electrical consumption of the data center
- Track environmental factors in the data center, such as temperature and humidity
- Optimize the data center growth

For more information on dcTrack, see the online help accessible from the dcTrack application, or User/Administrator Guide for dcTrack.

---

## dcTrack Overview

dcTrack® is a powerful and intelligent data center management and automation application.

dcTrack has been designed by data center and IT professionals to provide broad and deep visibility into the data center. It empowers data center managers to plan for growth and change by optimizing their current operations, assets, and infrastructure.

With dcTrack, you can view everything in the data center from servers, blades, virtual servers and applications to data networks, IP addressing space and cabling. dcTrack also allows you to track real-time power consumption and manage raised floor space and rack elevations.

Use dcTrack to build your floor map data center map directly in the application, or import an existing floor map into the dcTrack. Further, dcTrack allows you to import AutoCAD® 2012 (and earlier) objects to build a data center map.

If you currently maintain data center information in spreadsheet format, that data can be imported into dcTrack using the Import wizard.

Isolate potential problems with end-to-end power and data circuits by visually tracing them. This allows you to identify all intermediate circuit points and locate problems.

By using dcTrack's workflow and change management feature, data center managers are better able to enforce best practices across the enterprise and meet ITIL framework guidelines. You can also opt to skip the Change Control workflow process and work in Request Bypass so requests are processed immediately.

dcTrack® can be used as a standalone product or integrated with **Raritan's Power IQ** <http://www.raritan.com/products/dcim-software/power-iq>® for power and environmental monitoring.

---

## Adding the PX to dcTrack Management

The PX is categorized as a power item in dcTrack. dcTrack offers an import wizard for conveniently adding the PX as well as other IT equipment to dcTrack for management. You can import either all devices in a cabinet or all devices in a data center into dcTrack.

For detailed instructions, see the section titled Import Cabinets with the Import Wizard or Import Items with the Import Wizard in the dcTrack Administrator Guide.

### ► To import data into dcTrack:

1. Note down the data of all equipment, including PDUs, in a cabinet or a data center in a spreadsheet.

2. Launch dcTrack to import the spreadsheet file.

# Appendix I Additional PX Information

## In This Chapter

MAC Address .....	584
Locking Outlets and Cords .....	584
Unbalanced Current Calculation .....	587
Altitude Correction Factors .....	588
Data for BTU Calculation.....	589
Raritan Training Website .....	589
Truncated Data in the Web Interface .....	590
Reserving IP Addresses in Windows DHCP Servers.....	590
Sensor Threshold Settings .....	591
Ways to Probe Existing User Profiles.....	598

---

## MAC Address

A label is affixed to the PX, showing both the serial number and MAC address.



If necessary, you can find its IP address through the MAC address by using commonly-used network tools. Contact your LAN administrator for assistance.

---

## Locking Outlets and Cords

In addition to the cable retention clips, Raritan also provides other approaches to secure the connection of the power cords from your IT equipment to the Raritan PDUs, including:

- SecureLock™ outlets and cords
- Button-type locking outlets

Note that NOT all Raritan PDUs are implemented with any of the above locking outlets.

### SecureLock™ Outlets and Cords

SecureLock™ is an innovative mechanism designed by Raritan, which securely holds C14 or C20 plugs that are plugged into Raritan PDUs in place. This method requires the following two components:

- Raritan PDU with SecureLock™ outlets, which have a latch slot inside either side of the outlet.
- SecureLock™ cords, which is a power cord with a locking latch on each side of its plug. The following diagram illustrates such a plug.

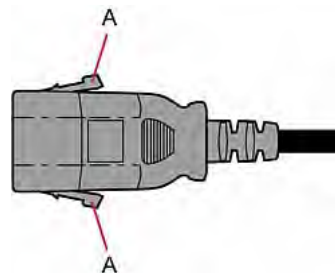

Item	Description
A	Latches on the SecureLock™ cord's plug

Only specific PDUs are implemented with the SecureLock™ mechanism. If your PDU does not have this design, do NOT use the SecureLock™ cords with it.

*Tip: The SecureLock™ outlets can accept regular power cords for power distribution but the SecureLock™ mechanism does not take effect.*

► **To lock a power cord using the SecureLock™ mechanism:**

1. Verify that the SecureLock™ cord you purchased meets your needs.
  - The cords' female socket matches the power socket type (C14 or C20) on your IT equipment.
  - The cord's male plug matches the outlet type (C13 or C19) on your PDU.
2. Connect the SecureLock™ cord between the IT equipment and your PDU.
  - Plug the female socket end of the cord into the power socket of the desired IT equipment.
  - Plug the male plug end of the cord into the appropriate SecureLock™ outlet on the PDU. Push the plug toward the outlet until you hear the click, which indicates the plug's latches are snapped into the latch slots of the outlet.

► **To remove a SecureLock™ power cord from the PDU:**

1. Press and hold down the two latches on the cord's plug as illustrated in the diagram below.

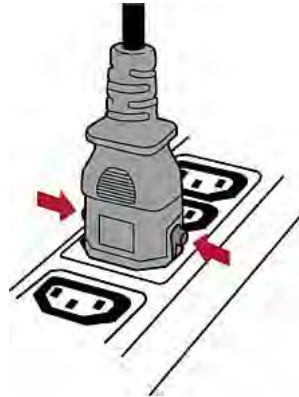

2. Unplug the cord now.

---

**Button-Type Locking Outlets**

A button-type locking outlet has a button on it. Such outlets do not require any special power cords to achieve the locking purpose. All you need to do is simply plug a regular power cord into the locking outlet and the outlet automatically locks the cord.

► **To remove a power cord from the locking outlet:**

1. Press and hold down the tiny button on the outlet. Depending on the outlet type, the button location differs.

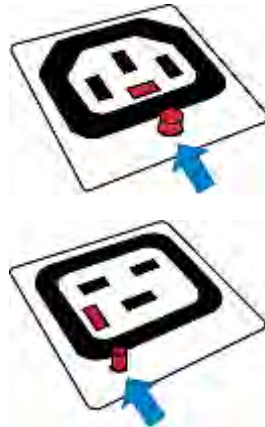

2. Unplug the power cord now.

---

## Unbalanced Current Calculation

Unbalanced current information is available on 3-phase models only. This section explains how the PX calculates the unbalanced current percentage.

► **Calculation:**

1. Calculate the average current of all 3 lines.

$$\text{Average current} = (L1+L2+L3) / 3$$

2. Calculate each line's current unbalance by having each line current subtracted and divided with the average current.

$$L1 \text{ current unbalance} = (L1 - \text{average current}) / \text{average current}$$

$$L2 \text{ current unbalance} = (L2 - \text{average current}) / \text{average current}$$

$$L3 \text{ current unbalance} = (L3 - \text{average current}) / \text{average current}$$

3. Determine the maximum absolute value among three lines' current unbalance values.

$$\text{Maximum} ( |L1 \text{ current unbalance}| , |L2 \text{ current unbalance}| , |L3 \text{ current unbalance}| )$$

4. Convert the maximum value to a percentage.

$$\text{Unbalanced load percent} = 100 * \text{maximum current unbalance}$$

► **Example:**

- Each line's current:

$$L1 = 5.5 \text{ amps}$$

$$L2 = 5.2 \text{ amps}$$

$$L3 = 4.0 \text{ amps}$$

- Average current:  $(5.5+5.2+4.0) / 3 = 4.9$  amps
  
- L1 current unbalance:  $(5.5 - 4.9) / 4.9 = 0.1224$
- L2 current unbalance:  $(5.2 - 4.9) / 4.9 = 0.0612$
- L3 current unbalance:  $(4.0 - 4.9) / 4.9 = -0.1837$
  
- Maximum current unbalance:  
 Maximum  $(|0.1224|, |0.0612|, |-0.1837|) = 0.1837$
  
- Current unbalance converted to a percentage:  
 $100 * (0.1837) = 18\%$

---

### Altitude Correction Factors

If a Raritan differential air pressure sensor is attached to your device, the altitude you enter for the device can serve as an altitude correction factor. That is, the reading of the differential air pressure sensor will be multiplied by the correction factor to get a correct reading.

This table shows the relationship between different altitudes and correction factors.

Altitude (meters)	Altitude (feet)	Correction factor
0	0	0.95
250	820	0.98
425	1394	1.00
500	1640	1.01
740	2428	1.04
1500	4921	1.15
2250	7382	1.26
3000	9842	1.38



---

## Data for BTU Calculation

The heat generated by the PX device differs according to the model you purchased. To calculate the heat (BTU/hr), use the following power data according to your model type in the BTU calculation formula.

Model name	Maximum power (Watt)
PX2-1000	5
PX3-1000	
PX2-2000	20
PX3-2000	
PX2-3000	24
PX3-3000	
PX2-4000	24
PX3-4000	
PX2-5000	24
PX3-5000	

---

## Raritan Training Website

Raritan offers free training materials for various Raritan products on the **Raritan training website** <http://www.raritantraining.com>. The Raritan products introduced on this website include the intelligent PDU, dcTrack®, Power IQ, KVM, EMX, BCM and CommandCenter Secure Gateway (CC-SG). Raritan would update the training materials irregularly according to the latest development of Raritan products.

To get access to these training materials or courses, you need to apply for a username and password through the Raritan training website. After you are verified, you can access the Raritan training website anytime.

Having access to the training website could be helpful for learning or getting some ideas regarding Raritan products and making correct decisions on purchasing them. For example, you can take the dcTrack video training before implementing or using it.

---

## Truncated Data in the Web Interface

Some fields of the PX web interface can accommodate data entry up to 256 characters. When the data entered is too long, it may be truncated due to some or all of the following factors:

- Screen resolution
- Font size
- Font type
- Size of different characters

Current web browser technology cannot break or wrap these fields with long inputs.

The solution for this issue includes:

- Increase of the screen resolution
- Application of smaller font size
- Use of other interfaces, such as the CLI or SNMP, to view the data in these fields

---

## Reserving IP Addresses in Windows DHCP Servers

The PX uses its serial number as the client identifier in the DHCP request. Therefore, to successfully reserve an IP address for the PX in a Windows® DHCP server, use the PX device's serial number as the unique ID instead of the MAC address.

Convert the serial number into ASCII codes for the IP address reservation entry. For example, if the PX device's serial number is PEG1A00003, use the serial number's ASCII codes "50 45 47 31 41 30 30 30 30 33" as the unique ID.

---

## Sensor Threshold Settings

This section explains the thresholds settings in a threshold setup dialog for a numeric internal or external sensor.

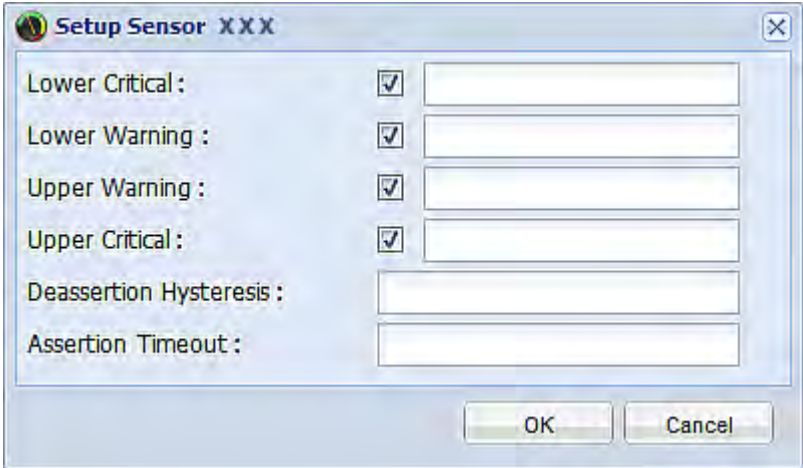

---

### Thresholds and Sensor States

A numeric sensor has four threshold settings: Lower Critical, Lower Warning, Upper Warning and Upper Critical.

The threshold settings determine how many sensor states are available for a certain sensor and the range of each sensor state. The diagram below shows how each threshold relates to each state.

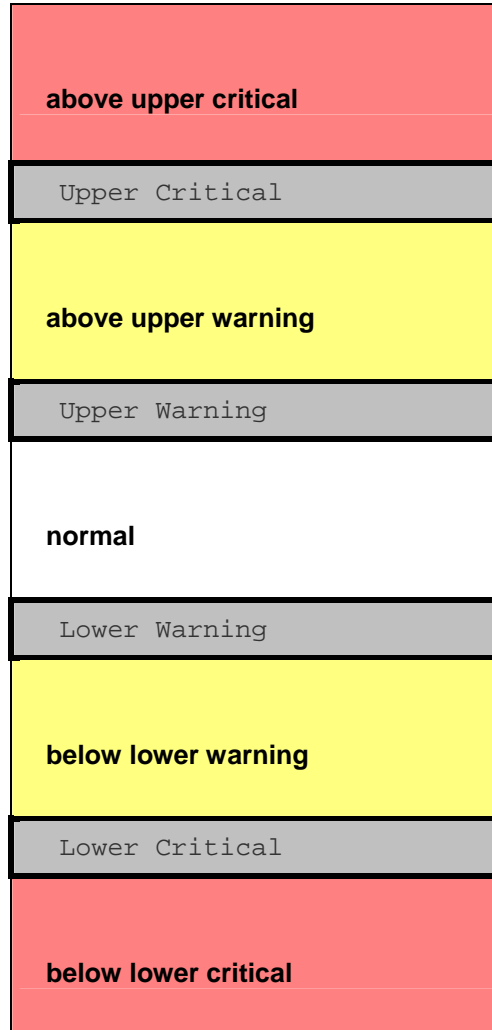

► **Available sensor states:**

The more thresholds are enabled for a sensor, the more sensor states are available for it. The "normal" state is always available regardless of whether any threshold is enabled.

For example:

- When a sensor only has the Upper Critical threshold enabled, it has two sensor states: normal and above upper critical.
- When a sensor has both the Upper Critical and Upper Warning thresholds enabled, it has three sensor states: normal, above upper warning, and above upper critical.
- When a sensor has all thresholds enabled, 5 sensor states are available: normal, above upper warning, above upper critical, below lower warning, and below lower critical.

Both states of "above upper warning" and "below lower warning" are warning states to call for users' attention.

Both states of "above upper critical" and "below lower critical" are critical states that require users to immediately handle.

► **Range of each available sensor state:**

The value of each enabled threshold determines the reading range of each available sensor state. For details, see:

- **"above upper critical" State** (on page 269)
- **"above upper warning" State** (on page 268)
- **"below lower critical" State** (on page 268)
- **"below lower warning" State** (on page 268)

---

### "To Assert" and Assertion Timeout

If multiple sensor states are available for a specific sensor, the PX asserts a state for it whenever a bad state change occurs.

► **Assert a state:**

To assert a state is to announce a "worse" new state. Below are bad state changes that cause the PX to assert.

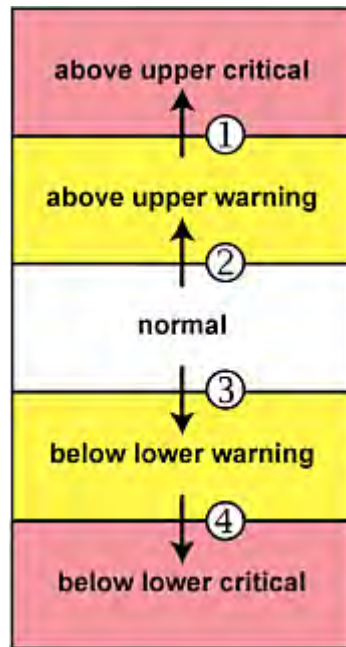

1. above upper warning --> above upper critical
2. normal --> above upper warning
3. normal --> below lower warning
4. below lower warning --> below lower critical

► **Assertion Timeout:**

In the threshold setup dialog, the Assertion Timeout field impacts the "assertion" action. It determines how long a sensor must be in the "worse" new state before the PX turns on the "assertion" action. If that sensor changes its state again within the specified wait time, the PX does NOT assert the worse state.

To disable the assertion timeout, set it to 0 (zero).

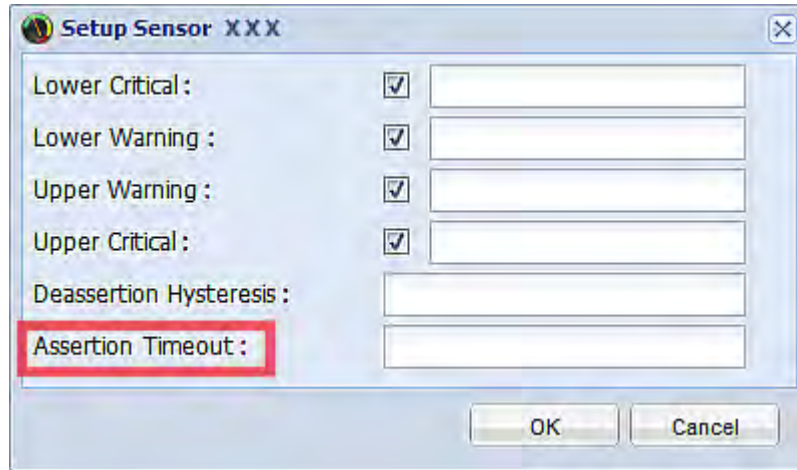

*Note: For most sensors, the measurement unit in the "Assertion Timeout" field is sample. Because the PX measures each sensor every second, timing of a sample is equal to a second.*

► **How "Assertion Timeout" is helpful:**

If you have created an event rule that instructs the PX to send notifications for assertion events, setting the "Assertion Timeout" is helpful for eliminating a number of notifications that you may receive in case the sensor's reading fluctuates around a certain threshold.

**Assertion Timeout Example for Temperature Sensors**

*Assumption:*

Upper Warning threshold is enabled.  
 Upper Warning = 25 (degrees Celsius)  
 Assertion Timeout = 5 samples (that is, 5 seconds)

When a temperature sensor's reading exceeds 25 degrees Celsius, moving from the "normal" range to the "above upper warning" range, the PX does NOT immediately announce this warning state. Instead it waits for 5 seconds, and then does either of the following:

- If the temperature remains above 25 degrees Celsius in the "above upper warning" range for 5 seconds, the PX turns on the "assertion" action to announce the "above upper warning" state.
- If the temperature drops below 25 degrees Celsius within 5 seconds, the PX does NOT turn on the "assertion" action.

---

### "To De-assert" and Deassertion Hysteresis

After the PX asserts a worse state for a sensor, it may de-assert the same state later on.

► **To de-assert a state:**

To de-assert a state is to announce the end of the previously asserted worse state. Below are good state changes that cause the PX to de-assert the previous state.

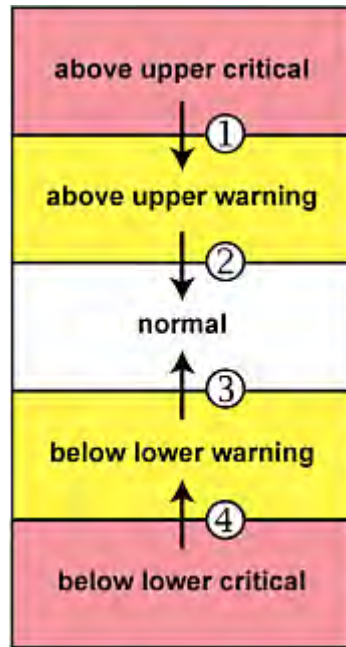

1. above upper critical --> above upper warning
2. above upper warning --> normal
3. below lower warning --> normal
4. below lower critical --> below lower warning

► **Deassertion Hysteresis:**

In the threshold settings dialog, the Deassertion Hysteresis field determines a new level to turn on the "deassertion" action.



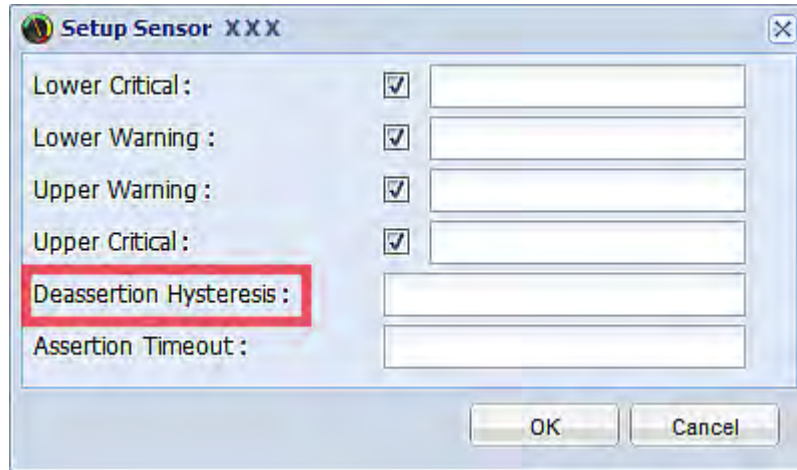

This function is similar to a thermostat, which instructs the air conditioner to turn on the cooling system when the temperature exceeds a pre-determined level. "Deassertion Hysteresis" instructs the PX to de-assert the worse state for a sensor only when that sensor's reading hits the pre-determined "deassertion" level.

For upper thresholds, this "deassertion" level is a decrease against each threshold. For lower thresholds, this level is an increase to each threshold. The value of the decrease or increase is exactly the hysteresis value.

For example:

If Deassertion Hysteresis = 2,

- Upper Critical = 33, so its "deassertion" level =  $33 - 2 = 31$ .
- Upper Warning = 25, so its "deassertion" level =  $25 - 2 = 23$ .
- Lower Critical = 10, so its "deassertion" level =  $10 + 2 = 12$ .
- Lower Warning = 18, so its "deassertion" level =  $18 + 2 = 20$ .

To use each threshold as the "deassertion" level instead of determining a new level, set the Deassertion Hysteresis to 0 (zero).

► **How "Deassertion Hysteresis" is helpful:**

If you have created an event rule that instructs the PX to send notifications for deassertion events, setting the "Deassertion Hysteresis" is helpful for eliminating a number of notifications that you may receive in case a sensor's reading fluctuates around a certain threshold.

**Deassertion Hysteresis Example for Temperature Sensors**

*Assumption:*

Upper Warning threshold is enabled.

Upper Warning = 20 (degrees Celsius)

Deassertion Hysteresis = 3 (degrees Celsius)

"Deassertion" level =  $20 - 3 = 17$  (degrees Celsius)

When the PX detects that a temperature sensor's reading drops below 20 degrees Celsius, moving from the "above upper warning" range to the "normal" range, either of the following may occur:

- If the temperature falls between 20 and 17 degrees Celsius, the PX does NOT turn on the "deassertion" action.
- If the temperature drops to 17 degrees Celsius or lower, the PX turns on the "deassertion" action to announce the end of the "above upper warning" state.

---

## Ways to Probe Existing User Profiles

This section indicates available ways to query existing user accounts on the PX.

- With SNMP v3 activated, you get the "user unknown" error when the user name used to authenticate does not exist.
- Any user with the permission to view event rules can query all local existing users via JSON RPC.
- Any user with the permission to view the event log may get information about existing users from the log entries.
- Any authenticated users can query currently-existing connection sessions, including Webcam-Live-Preview sessions, which show a list of associated user names.

# Index

## 1

1U and 2U Port Locations • 57  
1U Products • 2

## 2

2U Products • 2

## A

A Note about Enabling Thresholds • 316  
A Note about Firmware Upgrade Time • 302  
A Note about Infinite Loop • 242  
A Note about Untriggered Rules • 246  
About the Interface • 317  
Access Security Control • 141  
Accessing the Help • 303  
Action Group • 200, 202  
Activating or Deactivating the Load Shedding Mode • xviii, 185  
Actuator Configuration Commands • 432, 433, 449  
Actuator Control Operations • 472  
Actuator Information • 334  
Add Page Icon • 78, 82  
Adding a Firewall Rule • 393  
Adding a Monitored Device • 450  
Adding a Role-Based Access Control Rule • 405  
Adding Authentication Servers • 164  
Adding IT Devices for Ping Monitoring • 250  
Adding LDAP Server Settings • xviii, 164  
Adding PDUs to Power IQ Management • 566  
Adding RADIUS Server Settings • 167, 538  
Adding the PX to dcTrack Management • xix, 582  
Additional PX Information • 584  
Adjusting Image Properties • xix, 281, 283  
Adjusting the Pane • 80  
AD-Related Configuration • 538, 559  
Alarm • xviii, 200, 203  
Alarms List • xviii, 89, 200, 203  
Alert States and LHX Event Log • 297  
Alerted Sensors • 88  
All Privileges • 422, 428, 431  
Altitude Correction Factors • 128, 361, 588  
Applicable Models • xvi

Assertion Timeout Example for Temperature Sensors • 595  
Asset Management • 271  
Asset Management Commands • 456  
Asset Sensor Management • 457  
Asset Sensor Settings • 345  
Associating Outlets with Target Servers on KX II and LX • 571  
Automatic Mode • 62, 491  
Automatically Completing a Command • 479  
Available SCP Commands • xix, 526

## B

Backup and Restore of PX Device Settings • 276, 279  
Backup and Restore via SCP • 280, 528  
Beeper • 70, 131  
Before You Begin • 11  
Blade Extension Strip Settings • 347  
Browser-Defined Shortcut Menu • 87  
Browsing through the Online Help • 304  
Bulk Configuration • 276, 279, 527  
Bulk Configuration for Outlet Thresholds • 192, 193  
Bulk Configuration for Overcurrent Protector Thresholds • 196  
Bulk Configuration or Firmware Upgrade via DHCP/TFTP • xix, 14, 276, 300, 500  
Bulk Configuration via SCP • 277, 279, 527  
Bulk Configuration/Upgrade Procedure • 500, 502  
Button-Type Locking Outlets • 586

## C

Canceling the Power-On Process • 471  
Cascading the PX via USB • xviii, 17, 25, 58, 92, 98, 119  
Certificate Signing Request • 157  
Change Load Shedding State • xix, 201, 214  
Changing a User's Password • 415  
Changing an Outlet's Default State • 411  
Changing Default Thresholds • xix, 261, 263  
Changing HTTP(S) Settings • 106, 141  
Changing Measurement Units • 422, 425  
Changing Modbus/TCP Settings • 110  
Changing SSH Settings • 107, 135  
Changing Telnet Settings • 108

- Changing the Column • 86
- Changing the Cycling Power-Off Period • 177
- Changing the Default Policy • 141, 142, 152, 153
- Changing the Inlet Name • 413
- Changing the LAN Duplex Mode • 380
- Changing the LAN Interface Speed • 380
- Changing the LED Display Orientation • 60, 363
- Changing the Modbus Configuration • 386
- Changing the Modbus Port • 387
- Changing the Outlet Name • 411
- Changing the Outlet-Specific Cycling Power-Off Period • 178, 179
- Changing the Overcurrent Protector Name • 414
- Changing the PDU Name • 356
- Changing the PDU-Defined Cycling Power-Off Period • 178, 179
- Changing the Role List View • 141
- Changing the Role(s) • 422
- Changing the Sensor Description • 435
- Changing the Sensor Name • 433
- Changing the Sorting • 86, 92, 249
- Changing the SSH Configuration • 383
- Changing the SSH Port • 383
- Changing the SSH Public Key • 423
- Changing the Telnet Configuration • 382
- Changing the Telnet Port • 383
- Changing the UDP Port • 455
- Changing the User List View • 137
- Changing the View of a List • 85, 90, 137, 141, 254, 288
- Changing Your Own Password • 424
- Changing Your Password • 74
- Checking Power Strip Status • 581
- Checking Server Monitoring States • 253
- Checking the Accessibility of NTP Servers • 472
- Checking the Branch Circuit Rating • 12
- Checking the Internal Beeper State • 70, 131
- Circuit Breaker Orientation Limitation • 4, 6, 7, 8
- Circuit Breakers • 65
- Clearing Event Entries • 247
- Clearing Event Log • 354
- Clearing Information • 354
- Closing a Local Connection • 321
- Collapsing the Tree • 80
- Combining Asset Sensors • 40
- Command History • 351
- Commands for Environmental Sensors • 446
- Commands for Inlet Pole Sensors • 443
- Commands for Inlet Sensors • 441
- Commands for Outlet Sensors • 439
- Commands for Overcurrent Protector Sensors • 444
- Components of an Event Rule • 199
- Configuring a PX on Dominion SX • 578
- Configuring a Specific Rack Unit • 273
- Configuring Data Push Settings • xviii, 127, 206
- Configuring Environmental Sensors' Default Thresholds • 437
- Configuring Environmental Sensors or Actuators • xix, 85, 254, 259, 263, 264
- Configuring IP Protocol Settings • 365
- Configuring IPv4 Parameters • 371
- Configuring IPv6 Parameters • 375
- Configuring KSX II Ports • 575
- Configuring NTP Server Settings • 316
- Configuring Rack PDU (Power Strip) Targets • 568
- Configuring SMTP Settings • xviii, 126, 207, 209
- Configuring SNMP Notifications • 239, 240, 252, 309
- Configuring SNMP Settings • 109, 133
- Configuring Temperature and Fan Thresholds • 294
- Configuring the Asset Sensor • 43, 271
- Configuring the Cascading Mode • 26, 456
- Configuring the Feature Port • 117, 292, 293
- Configuring the Firewall • 141
- Configuring the LHX/SHX Device • 291, 292
- Configuring the PX • 14, 100
- Configuring the PX Device and Network • 355
- Configuring the Serial Port • 53, 118, 320
- Configuring Users for Encrypted SNMP v3 • 109, 307, 308
- Configuring Webcam Storage • 219, 280, 287, 288
- Configuring Webcams • xix, 280, 281, 283, 287
- Connecting a DPX2 Sensor Package to DX • xviii, 38
- Connecting a GSM Modem • 53
- Connecting a Logitech Webcam • xviii, 52, 78, 280
- Connecting a Rack PDU • 568
- Connecting a Schroff LHX/SHX Heat Exchanger • 54, 117, 291

- Connecting an Analog Modem • 53, 320
  - Connecting an External Beeper • 54, 117
  - Connecting Asset Sensors to the PX • 42, 47
  - Connecting Blade Extension Strips • xviii, 44
  - Connecting Composite Asset Sensors (AMS-Mx-Z) • xviii, 47, 50
  - Connecting Environmental Sensor Packages • 30, 51, 254
  - Connecting External Equipment (Optional) • 30, 57
  - Connecting the Asset Management Sensor • 40, 117, 127, 271
  - Connecting the PDU to a Power Source • 13
  - Connecting the PX to a Computer • 15, 523, 524
  - Connecting the PX to Your Network • 17, 97, 98
  - Connection Port Functions • 57
  - Connection Ports • 57
  - Controlling Actuators • 270
  - Copying the PX Configuration • 278
  - Correctly Displaying the LHX/SHX Device • 293
  - Creating a Certificate Signing Request • 157
  - Creating a Role • 135, 138, 427, 538
  - Creating a Self-Signed Certificate • 159
  - Creating a User Profile • 72, 108, 132, 136, 137, 138, 139, 308, 415
  - Creating Actions • xviii, 53, 89, 200, 226, 244, 280
  - Creating an Event Rule • 54, 199
  - Creating Firewall Rules • 141, 143
  - Creating Role-Based Access Control Rules • 152, 153
  - Creating Rules • xix, 220
- D**
- Daisy-Chain Limitations of Composite Asset Sensors • xviii, 48, 49
  - Dashboard Page • 492
  - Data for BTU Calculation • 589
  - Data Pane • 83
  - Date and Time Settings • 330
  - dcTrack • 581
  - dcTrack Overview • 582
  - Deassertion Hysteresis Example for Temperature Sensors • 597
  - Default Log Messages • xix, 151, 209, 227
  - Default Measurement Units • 330
  - Deleting a Firewall Rule • 396
  - Deleting a Monitored Device • 451
  - Deleting a Role • 140, 432
  - Deleting a Role-Based Access Control Rule • 408
  - Deleting a User Profile • 136, 424
  - Deleting an Event Rule or Action • 245
  - Deleting Authentication Server Settings • 169
  - Deleting Firewall Rules • 147
  - Deleting Ping Monitoring Settings • 253
  - Deleting Role-Based Access Control Rules • 156
  - Derating a Raritan Product • 484
  - Describing the Sensor or Actuator's Location • 260, 262
  - Determining the Time Setup Method • 388
  - Device Management • 90
  - Device States and Icon Variations • 293, 296, 298
  - DHCP IPv4 Configuration in Linux • 501, 519
  - DHCP IPv4 Configuration in Windows • 501, 502
  - DHCP IPv6 Configuration in Linux • 501, 521
  - DHCP IPv6 Configuration in Windows • 501, 512
  - Diagnostic Commands • 477
  - Dictionary File • 562
  - Different CLI Modes and Prompts • 319, 321, 323, 354, 355, 356, 466, 468, 472, 477
  - Disabling an Inlet (for Multi-Inlet PDUs) • 191
  - Disabling External Authentication • 169
  - Disabling the Automatic Management Function • 258, 270, 362
  - Displaying PDU Information • 91
  - Displaying the Asset Sensor Information • 275
  - Dominion KSX II • 573
  - Dominion KSX II or SX Configuration • 117, 573
  - Dominion KX II Configuration • 117, 568
  - Dominion SX • 578
  - Downloading Diagnostic Information • 290
  - Downloading Key and Certificate Files • 161
  - Downloading SNMP MIB • 110, 308, 309, 310, 312, 314
  - DPX Sensor Packages • 30
  - DPX2 Sensor Packages • xviii, 30, 35
  - DX Sensor Packages • xviii, 30, 37, 218
- E**
- EAP CA Certificate Example • 368, 370
  - Editing Authentication Server Settings • 169
  - Editing Firewall Rules • 146
  - Editing Ping Monitoring Settings • 252

- Editing Role-Based Access Control Rules • 155
- Email and SMS Message Placeholders • xix, 208, 209, 214, 215, 216, 236
- Enabling and Disabling Schroff LHX/SHX Heat Exchanger Support • 118, 206, 216, 291, 292
- Enabling and Editing the Security Banner • 151
- Enabling Data Logging • 125
- Enabling External and Local Authentication Services • 170
- Enabling Front Panel Outlet Switching • 64, 187
- Enabling IPv4 or IPv6 • 365
- Enabling Login Limitations • 149, 285
- Enabling or Disabling a User Profile • 418
- Enabling or Disabling an Inlet (for Multi-Inlet PDUs) • 413
- Enabling or Disabling Data Logging • 360
- Enabling or Disabling EnergyWise • 454
- Enabling or Disabling Front Panel Outlet Switching • 409
- Enabling or Disabling Load Shedding • 467
- Enabling or Disabling Modbus • 386
- Enabling or Disabling Peripheral Device Auto Management • 362
- Enabling or Disabling SNMP v1/v2c • 384
- Enabling or Disabling SNMP v3 • 384
- Enabling or Disabling SSH • 383
- Enabling or Disabling Strong Passwords • 401
- Enabling or Disabling Telnet • 382
- Enabling or Disabling the Read-Only Mode • 386
- Enabling or Disabling the Restricted Service Agreement • 397
- Enabling or Disabling the Service Advertisement • 387
- Enabling Password Aging • 150
- Enabling Service Advertisement • 111, 387
- Enabling SNMP • 125, 307
- Enabling Strong Passwords • 150
- Enabling the Feature • 152
- Enabling the Firewall • 141, 142
- Enabling User Blocking • 148
- EnergyWise Configuration Commands • 454
- EnergyWise Settings • 345
- Entering Configuration Mode • 321, 355, 370, 416, 424
- Entering Diagnostic Mode • 321, 476
- Environmental Sensor Configuration Commands • 432
- Environmental Sensor Default Thresholds • 341
- Environmental Sensor Information • 331
- Environmental Sensor Package Information • 333
- Environmental Sensor Threshold Information • 340
- Environmental Sensors and Actuators • xix, 254
- Equipment Setup Worksheet • 12, 496
- Event Log • 348
- Event Rules and Actions • 109, 126, 192, 199, 250, 309
- Example • 390, 398, 416, 424, 464, 467
  - Ping Monitoring and SNMP Notifications • 251
- Example - Actuator Naming • 450
- Example - Creating a Role • 432
- Example - Default Upper Thresholds for Temperature • 439
- Example - Inlet Naming • 414
- Example - OCP Naming • 414
- Example - Outlet Naming • 412
- Example - Ping Command • 479
- Example - Power Cycling Specific Outlets • 471
- Example - Server Settings Changed • 453
- Example - Setting Up EnergyWise • 456
- Example - Turning On a Specific Actuator • 474
- Example 1 • 242
- Example 1 - Asset Sensor LED Colors for Disconnected Tags • 463
- Example 1 - Basic Security Information • 352
- Example 1 - Combination of IP, Subnet Mask and Gateway Parameters • 465
- Example 1 - Creating a User Profile • 426
- Example 1 - Environmental Sensor Naming • 437
- Example 1 - IPv4 Firewall Control Configuration • 409
- Example 1 - Networking Mode • 387
- Example 1 - PDU Naming • 363
- Example 1 - Time Setup Method • 391
- Example 1 - Upper Critical Threshold for a Temperature Sensor • 448
- Example 2 • 242
- Example 2 - Adding an IPv4 Firewall Rule • 409



Example 2 - Combination of Upper Critical and Upper Warning Settings • 465  
 Example 2 - Enabling Both IP Protocols • 387  
 Example 2 - In-Depth Security Information • 353  
 Example 2 - Modifying a User's Roles • 427  
 Example 2 - Outlet Sequence • 363  
 Example 2 - Primary NTP Server • 391  
 Example 2 - Rack Unit Naming • 463  
 Example 2 - Sensor Threshold Selection • 437  
 Example 2 - Warning Thresholds for Inlet Sensors • 448  
 Example 3 • 243  
 Example 3 - Basic PDU Information • 353  
 Example 3 - Combination of SSID and PSK Parameters • 466  
 Example 3 - Default Measurement Units • 427  
 Example 3 - Outlet Sequence Delay • 364  
 Example 3 - Upper Thresholds for Overcurrent Protector Sensors • 448  
 Example 3 - User Blocking • 410  
 Example 3 - Wireless Authentication Method • 388  
 Example 4 - Adding an IPv4 Role-based Access Control Rule • 410  
 Example 4 - Combination of Upper Critical, Upper Warning and Lower Warning Settings • 466  
 Example 4 - In-Depth PDU Information • 354  
 Example 4 - Non-Critical Outlets • 364  
 Example 4 - Static IPv4 Configuration • 388  
 Examples • 352, 363, 387, 390, 409, 426, 436, 447, 463  
 Existing Roles • 344  
 Existing User Profiles • 330, 343  
 Expanding a Blade Extension Strip • 274  
 Expanding the Tree • 78, 170, 171, 172, 173, 175, 177, 179, 184, 185, 186, 188, 190, 192, 193, 195, 270  
 External Beeper • 200, 204

## F

Feature RJ-45 Port Pinouts • 495  
 Filling Out the Equipment Setup Worksheet • 12  
 Firewall Control • 391  
 Firmware Update via SCP • 300, 526  
 Firmware Update via Web Interface • 300, 526  
 Firmware Upgrade • 278, 299  
 Flexible Cord Installation Instructions • 482  
 Flexible Cord Selection • 483

Forcing a Password Change • 418  
 Forcing HTTPS Encryption • 141, 157  
 Format of the • 563  
 Full Disaster Recovery • 303  
 Fuse • 67  
 Fuse Replacement on 1U Models • 69  
 Fuse Replacement on Zero U Models • 67

## G

Gathering the External Authentication Information • 162  
 Gathering the LDAP Information • 163  
 Gathering the RADIUS Information • 163  
 Guidelines for PX with Two Sensor Ports • xviii, 36, 38, 39

## H

Help Command • 322  
 History Buffer Length • 351  
 How to Use the Calendar • 113

## I

Identifying Cascaded Devices • 27, 91, 92  
 Identifying Environmental Sensors and Actuators • 254, 255, 258  
 Identifying Sensor or Actuator Channels • 257  
 Idle Timeout • 400  
 Initial Network Configuration via CLI • 19, 81, 523, 524  
 Inlet and Overcurrent Protector Management • 187  
 Inlet Configuration Commands • 412  
 Inlet Information • 328  
 Inlet Pole Sensor Threshold Information • 338  
 Inlet Sensor Threshold Information • 337  
 In-Line Monitor Unused Channels • 485  
 In-Line Monitors • 481  
 In-Line Monitor's LED Display • 490  
 In-Line Monitor's Web Interface • 492  
 Installation and Configuration • 11  
 Installing a CA-Signed Certificate • 159  
 Installing Cable Retention Clips on Outlets (Optional) • 28  
 Installing Cable Retention Clips on the Inlet (Optional) • 12  
 Installing Existing Key and Certificate Files • 161  
 Installing the USB-to-Serial Driver (Optional) • 15, 16, 314

Integration • 565  
 Internal Beeper • xix, 201, 216  
 Introduction • 1  
 Introduction to the Web Interface • 76  
 IP Configuration • 324

## L

LAN Interface Settings • 324  
 Layout • 315  
 LDAP Configuration Illustration • 168, 530  
 LED Display • 59, 490  
 LEDs for Measurement Units • 61, 63, 491  
 Listing TCP Connections • 290  
 Load Shedding Configuration Commands • 466  
 Load Shedding Settings • 344  
 Locking Outlets and Cords • 28, 584  
 Log an Event Message • 201, 205  
 Logging in to CLI • 318, 524  
 Logging in to the Web Interface • 72  
 Logging out of CLI • 480  
 Login • 72  
 Login Limitation • 398  
 Logout • 75  
 Logout Button • 82  
 Lowercase Character Requirement • 402

## M

MAC Address • 14, 584  
 Managing Environmental Sensors or Actuators • xix, 37, 254, 258  
 Managing Event Logging • 246  
 Managing Firewall Rules • 393  
 Managing Role-Based Access Control Rules • 405  
 Managing the Schroff LHX/SHX Heat Exchanger • 54, 117, 291  
 Managing the Snapshots Saved to PX • xix, 287  
 Manual Mode • 63, 491  
 Marking All Outlets • xviii, 183  
 Marking an Outlet • 184  
 Matching the Position • 255, 256  
 Matching the Serial Number • 255  
 Maximum Ambient Operating Temperature • 12, 494  
 Maximum Password History • 403  
 Maximum Password Length • 401  
 Menus • 77

Microsoft Network Policy Server • 538  
 Minimum Password Length • 401  
 Modifying a Firewall Rule • 394  
 Modifying a Monitored Device's Settings • 451  
 Modifying a Role • 135, 136, 139, 430  
 Modifying a Role-Based Access Control Rule • 406  
 Modifying a User Profile • 74, 136, 139, 415  
 Modifying a User's Personal Data • 417  
 Modifying an Action • 110, 245  
 Modifying an Event Rule • 243  
 Modifying Firewall Control Parameters • 391  
 Modifying IPv4 Settings • 101  
 Modifying IPv6 Settings • 102  
 Modifying Network Interface Settings • 97  
 Modifying Network Service Settings • 106, 317, 319  
 Modifying Network Settings • 81, 100, 111, 532  
 Modifying Role-Based Access Control Parameters • 404  
 Modifying SNMPv3 Settings • 419  
 Modifying the Network Configuration • 96  
 Monitoring All Outlets • 171  
 Monitoring an Outlet • 172  
 Monitoring Overcurrent Protectors • 189  
 Monitoring Server Accessibility • 249  
 Monitoring the Inlet • 188  
 Monitoring the LHX/SHX Device • 291, 295  
 Monitoring Total Active Energy or Power • xviii, 130  
 More Information • 83  
 More Information about AD or RADIUS Configuration • 168  
 Mounting 1U or 2U Models • 9  
 Mounting Zero U Models Using Button Mount • 6  
 Mounting Zero U Models Using Claw-Foot Brackets • 7  
 Mounting Zero U Models Using L-Brackets • 4  
 Mounting Zero U Models Using Two Rear Buttons • 8  
 Multi-Command Syntax • 392, 398, 400, 401, 405, 415, 417, 419, 422, 425, 437, 439, 441, 443, 444, 446, 449, 451, 465

## N

Naming a Rack Unit • 460  
 Naming an Asset Sensor • 457  
 Naming Outlets • 170



- Naming Overcurrent Protectors • 188
- Naming the Inlet • 187
- Naming the PDU • 81, 96
- Naming the Rack PDU in the KX II or LX (Port Page for Power Strips) • 569
- Network Configuration • 324
- Network Configuration Commands • 364
- Network Diagnostics • 289
- Network Service Settings • 325
- Network Troubleshooting • 289, 476
- Networking Mode • 325
- Non-Windows RADIUS Server • 538, 562
- Numeric Character Requirement • 402

## O

- Operating Hours • 297
- Outlet Configuration Commands • 411
- Outlet Information • 327
- Outlet Management • 170
- Outlet Monitoring • 171
- Outlet Page • 493
- Outlet Pole Sensor Threshold Information • 336
- Outlet Sensor Threshold Information • 335
- Outlet Switching • 64, 173
- Outlets • 55
- Overcurrent Protector Configuration Commands • 414
- Overcurrent Protector Information • 329
- Overcurrent Protector Sensor Threshold Information • 339
- Overriding DHCP-Assigned NTP Servers • 389, 472
- Overriding the IPv4 DHCP-Assigned DNS Server • 373, 374
- Overriding the IPv6 DHCP-Assigned DNS Server • 377, 378
- Overview • 481, 573

## P

- Package Contents • 1, 11
- Panel Components • 55
- Password Aging • 399
- Password Aging Interval • 399
- PDU Configuration • 131, 326
- PDU Configuration Commands • 356
- Pinging a Host • 289
- Plug Selection • 483
- Port Forwarding Examples • 74, 120, 122
- Port Number Syntax • 120, 121, 122

- Power Control • 577, 580
- Power Control Operations • 468
- Power Cord • 55
- Power Cycling the Outlet(s) • 470
- Power IQ Configuration • 565
- Preparing the Installation Site • 11
- Product Models • 1
- Push Out Sensor Readings • xix, 127, 201, 206
- PX Explorer Pane • 77
- PX2-3000 Series • 56
- PX2-4000 Series • 56
- PX2-5000 Series • 56

## Q

- Querying Available Parameters for a Command • 322, 323
- Querying DNS Servers • 477
- Quitting Configuration Mode • 355, 398
- Quitting Diagnostic Mode • 477

## R

- Rack Unit Configuration • 460
- Rack Unit Settings of an Asset Sensor • 346
- Rackmount Safety Guidelines • 3
- Rack-Mounting the PDU • 3
- RADIUS Configuration Illustration • xix, 168, 538
- Raritan Training Website • 589
- Rebooting the PX Device • 129
- Receptacle Selection • 483
- Record Snapshots to Webcam Storage • 201, 219
- Reliability Data • 351
- Reliability Error Log • 351
- Remembering User Names and Passwords • 74
- Request LHX/SHX Maximum Cooling • 201, 206
- Requesting Maximum Cooling for an SHX-30 • 299
- Reserving IP Addresses in Windows DHCP Servers • 590
- Reset Button • 65
- Resetting Active Energy Readings • 475
- Resetting All Active Energy Readings • 129, 130, 190, 197
- Resetting Inlet Active Energy Readings • 130, 190

- Resetting Outlet Active Energy Readings • 130, 186
  - Resetting the Button-Type Circuit Breaker • 66
  - Resetting the Handle-Type Circuit Breaker • 66
  - Resetting the PX • 474
  - Resetting to Factory Defaults • 65, 476, 523
  - Resizing a Dialog • 87
  - Restarting the PDU • 475
  - Restricted Service Agreement • 397
  - Retrieving Energy Usage • 316
  - Retrieving Previous Commands • 479
  - Retrieving Software Packages Information • 303
  - Role Configuration Commands • 427
  - Role of a DNS Server • 106, 532
  - Role-Based Access Control • 403
- S**
- Safety Guidelines • ii
  - Safety Instructions • iii, 12, 481
  - Sample Environmental-Sensor-Level Event Rule • 241
  - Sample Event Rules • 239
  - Sample Inlet-Level Event Rule • 240
  - Sample Outlet-Level Event Rule • 239
  - Sample PDU-Level Event Rule • 239
  - Saving Snapshots • 280, 283, 286, 287
  - Saving the PX Configuration • xix, 277
  - Scheduling an Action • xix, 127, 206, 225
  - SecureLock™ Outlets and Cords • 585
  - Security Configuration Commands • 391
  - Security Settings • 342
  - Selecting IPv4 or IPv6 Addresses • 365
  - Selecting the Internet Protocol • 100, 101, 102
  - Send a Snapshot via Email • 201, 207
  - Send an SNMP Notification • 110, 201, 209
  - Send EMail • xix, 201, 208, 227
  - Send Sensor Report • 201, 213
  - Send SMS Message • 201, 215
  - Sending Snapshots or Videos in an Email or Instant Message • xix, 249, 280, 282, 284
  - Sensor RJ-12 Port Pinouts • 494
  - Sensor Threshold Configuration Commands • 439
  - Sensor Threshold Settings • 192, 260, 591
  - Serial Port Configuration Commands • 463
  - Serial Port Settings • 345
  - Serial RS-232 Port Pinouts • 494
  - Server Reachability Configuration Commands • 450
  - Server Reachability Information • 349
  - Server Reachability Information for a Specific Server • 350
  - Setting an LED Color for a Rack Unit • 461, 462
  - Setting an LED Mode for a Rack Unit • 461, 462
  - Setting an Outlet's Cycling Power-Off Period • 412
  - Setting an Outlet's Thresholds • 192, 193
  - Setting an Overcurrent Protector's Thresholds • 195, 196
  - Setting Asset Sensor LED Colors • 272
  - Setting Data Logging • 125, 361
  - Setting Data Logging Measurements Per Entry • 361
  - Setting Default Measurement Units • 116, 137, 422, 425
  - Setting EAP Parameters • 368
  - Setting Inlet Thresholds • 194
  - Setting IPv4 Static Routes • 375
  - Setting IPv6 Static Routes • 379
  - Setting LAN Interface Parameters • 379
  - Setting LED Colors for Connected Tags • 459, 461, 462
  - Setting LED Colors for Disconnected Tags • 460, 461, 462
  - Setting Network Service Parameters • 380
  - Setting Non-Critical Outlets and Load Shedding Mode • 183, 214, 360
  - Setting NTP Parameters • 388, 472
  - Setting Power Thresholds • 85, 170, 187, 192, 315
  - Setting the Alarmed to Normal Delay for DX-PIR • 436
  - Setting the Authentication Method • 366
  - Setting the Automatic Daylight Savings Time • 390
  - Setting the BSSID • 371
  - Setting the Cascading Mode • 25, 26, 93, 119, 122
  - Setting the Date and Time • 112, 316
  - Setting the Default Outlet State • 176
  - Setting the EnergyWise Configuration • 131
  - Setting the History Buffer Length • 464
  - Setting the HTTP Port • 381
  - Setting the HTTPS Port • 382
  - Setting the Initialization Delay • 180, 359
  - Setting the Inrush Guard Delay • 181

- Setting the Inrush Guard Delay Time • 359
- Setting the IPv4 Address • 372
- Setting the IPv4 Configuration Mode • 372
- Setting the IPv4 Gateway • 373
- Setting the IPv4 Preferred Host Name • 372
- Setting the IPv4 Primary DNS Server • 373
- Setting the IPv4 Secondary DNS Server • 374
- Setting the IPv4 Subnet Mask • 373
- Setting the IPv6 Address • 377
- Setting the IPv6 Configuration Mode • 376
- Setting the IPv6 Gateway • 377
- Setting the IPv6 Preferred Host Name • 376
- Setting the IPv6 Primary DNS Server • 377
- Setting the IPv6 Secondary DNS Server • 378
- Setting the LED Operation Mode • 461
- Setting the Networking Mode • 364
- Setting the Outlet Initialization Delay • 359
- Setting the Outlet Power-On Sequence • 181, 356
- Setting the Outlet Power-On Sequence Delay • 357
- Setting the Outlet-Specific Default State • 176, 177
- Setting the Outlet-Specific Power-On Delay • 182
- Setting the PDU-Defined Cycling Power-Off Period • 358, 412
- Setting the PDU-Defined Default Outlet State • 358, 411
- Setting the PDU-Defined Default State • 176, 177
- Setting the Polling Interval • 455
- Setting the PSK • 367
- Setting the Serial Port Baud Rate • 464
- Setting the SNMP Configuration • 384
- Setting the SNMP Read Community • 385
- Setting the SNMP Write Community • 385
- Setting the SSID • 366
- Setting the sysContact Value • 385
- Setting the sysLocation Value • 385
- Setting the sysName Value • 385
- Setting the Time Zone • 316, 390
- Setting the X Coordinate • 434
- Setting the Y Coordinate • 434
- Setting the Z Coordinate • 362, 435
- Setting the Z Coordinate Format • 261
- Setting the Z Coordinate Format for Environmental Sensors • 362, 435, 450
- Setting Thresholds for Multiple Sensors • 261, 264
- Setting Thresholds for Total Active Energy or Power • xviii, 197
- Setting Up a TLS Certificate • xviii, 141, 156
- Setting Up an LHX/SHX • 293
- Setting Up External Authentication • xviii, 106, 141, 162
- Setting Up Role-Based Access Control Rules • 152
- Setting Up Roles • 74, 125, 132, 135, 138
- Setting Up User Login Controls • 148
- Setting Up Your Preferred Measurement Units • 116, 128, 135, 137
- Setting Wireless Parameters • 366
- Setup Button • 80
- Showing Information • 323
- Showing Network Connections • 477
- Single Login Limitation • 399
- Snapshot Storage • 286
- SNMP Gets and Sets • 313
- SNMP Sets and Thresholds • 315
- SNMPv2c Notifications • 310
- SNMPv3 Notifications • 311
- Sorting Firewall Rules • 147
- Sorting Role-Based Access Control Rules • 155
- Sorting the Access Order • 168
- Special Character Requirement • 403
- Specifications • 3, 494
- Specifying Non-Critical Outlets • 344, 360
- Specifying the Agreement Contents • 397
- Specifying the Asset Sensor Orientation • 459
- Specifying the CC Sensor Type • 433
- Specifying the Device Altitude • 128, 361
- Specifying the EnergyWise Domain • 454
- Specifying the EnergyWise Secret • 455
- Specifying the Number of Rack Units • 457
- Specifying the Primary NTP Server • 389
- Specifying the Rack Unit Numbering Mode • 458
- Specifying the Rack Unit Numbering Offset • 458
- Specifying the Secondary NTP Server • 389
- States of Managed Actuators • 269
- States of Managed Sensors • 266
- Static Route Examples • 101, 102, 104
- Status Bar • 80
- Step A
  - Add Your PX as a RADIUS Client • 539
- Step A. Determine User Accounts and Groups • 530
- Step B

## Index

- Configure Connection Request Policies • 542
- Step B. Configure User Groups on the AD Server • 531
- Step by Step Flexible Cord Installation • 485
- Step C
  - Configure a Vendor-Specific Attribute • 557
- Step C. Configure LDAP Authentication on the PX Device • 532
- Step D. Configure User Groups on the PX Device • 534
- Stopping the Power-On Sequence • 175
- Strong Passwords • 401
- Supported Maximum DPX Sensor Distances • 30, 34
- Supported Web Browsers • 72
- Supported Wireless LAN Configuration • 19
- Switch LHX/SHX • 201, 216
- Switch Outlets • 202, 217
- Switch Peripheral Actuator • 202, 218
- Switching an Outlet • 175
- Switching Multiple or All Outlets • 173, 175
- Switching Off an Actuator • 473
- Switching On an Actuator • 473
- Syslog Message • xix, 201, 211

## T

- Testing the Network Connectivity • 478
- Testing the Server Connection • 168
- TFTP Requirements • 501
- The PX MIB • 314
- The Yellow- or Red-Highlighted Sensors • 84, 88, 89, 172, 173, 189, 192, 265, 296
- Three-Digit Row • 60
- Thresholds and Sensor States • 592
- Time Configuration Commands • 388
- Tracing the Network Route • 289
- Tracing the Route • 479
- Truncated Data in the Web Interface • 590
- Turning Off the Outlet(s) • 469
- Turning On the Outlet(s) • 468
- Turning the LHX/SHX On or Off • 291, 298
- Two-Digit Row • 61

## U

- Unbalanced Current Calculation • 587
- Unblocking a User • 148, 474
- Unmanaging Environmental Sensors or Actuators • 37, 259, 269

- Unpacking the Product and Components • 11
- Updating the Asset Sensor Firmware • 303
- Updating the PX Firmware • 25, 119, 300
- Uppercase Character Requirement • 402
- USB Wireless LAN Adapters • xviii, 18, 19, 26, 93
- USB-Cascading Configuration Commands • 456
- USB-Cascading Configuration Information • 345
- User Blocking • 400
- User Configuration Commands • 414
- User Management • 132
- Using a Raritan Y cable • 33
- Using an Optional Sensor Hub • 31
- Using an X Cable • 49
- Using Default Thresholds • 436
- Using SNMP • 301, 306
- Using the CLI Command • 476, 524
- Using the Command Line Interface • xix, 106, 262, 317, 524
- Using the PDU • 55
- Using the Reset Button • 523
- Using the Web Interface • 71, 492

## V

- Viewing Connected Users • 248, 282, 284
- Viewing Details • 296
- Viewing Firmware Update History • 302
- Viewing Sensor or Actuator Data • 265
- Viewing the Dashboard • 88
- Viewing the Local Event Log • xix, 126, 164, 211, 246
- Viewing the Summary • 295, 297
- Viewing the Wireless LAN Diagnostic Log • xix, 247
- Viewing Webcam Snapshots or Videos • xix, 52, 282

## W

- Warning Icon • 83
- Ways to Probe Existing User Profiles • xix, 598
- Webcam Management • 280
- What's New in the PX User Guide • xviii
- Windows NTP Server Synchronization Solution • 113, 115
- Wired Network Settings • 97
- Wireless Configuration • 325
- Wireless LAN Diagnostic Log • 349

Wireless Network Settings • xviii, 98  
Wiring of 3-Phase In-Line Monitors • 483, 484  
With an Analog Modem • 320  
With HyperTerminal • 318, 474  
With SSH or Telnet • 319

## Z

Zero U Connection Ports • 57  
Zero U Products • 1

▶ **U.S./Canada/Latin America**

Monday - Friday  
8 a.m. - 6 p.m. ET  
Phone: 800-724-8090 or 732-764-8886  
For CommandCenter NOC: Press 6, then Press 1  
For CommandCenter Secure Gateway: Press 6, then Press 2  
Fax: 732-764-8887  
Email for CommandCenter NOC: tech-ccnoc@raritan.com  
Email for all other products: tech@raritan.com

▶ **China**

**Beijing**

Monday - Friday  
9 a.m. - 6 p.m. local time  
Phone: +86-10-88091890

**Shanghai**

Monday - Friday  
9 a.m. - 6 p.m. local time  
Phone: +86-21-5425-2499

**GuangZhou**

Monday - Friday  
9 a.m. - 6 p.m. local time  
Phone: +86-20-8755-5561

▶ **India**

Monday - Friday  
9 a.m. - 6 p.m. local time  
Phone: +91-124-410-7881

▶ **Japan**

Monday - Friday  
9:30 a.m. - 5:30 p.m. local time  
Phone: +81-3-5795-3170  
Email: support.japan@raritan.com

▶ **Europe**

**Europe**

Monday - Friday  
8:30 a.m. - 5 p.m. GMT+1 CET  
Phone: +31-10-2844040  
Email: tech.europe@raritan.com

**United Kingdom**

Monday - Friday  
8:30 a.m. to 5 p.m. GMT  
Phone +44(0)20-7090-1390

**France**

Monday - Friday  
8:30 a.m. - 5 p.m. GMT+1 CET  
Phone: +33-1-47-56-20-39

**Germany**

Monday - Friday  
8:30 a.m. - 5:30 p.m. GMT+1 CET  
Phone: +49-20-17-47-98-0  
Email: rg-support@raritan.com

▶ **Melbourne, Australia**

Monday - Friday  
9:00 a.m. - 6 p.m. local time  
Phone: +61-3-9866-6887

▶ **Taiwan**

Monday - Friday  
9 a.m. - 6 p.m. GMT -5 Standard -4 Daylight  
Phone: +886-2-8919-1333  
Email: support.apac@raritan.com