



# **MX910 Series**

---

## **User's Guide**

**June 2014**

**[www.lexmark.com](http://www.lexmark.com)**

---

Machine type(s):

7421

Model(s):

036, 236, 436

# Contents

- Safety information.....7**
- Learning about the printer.....9**
  - Finding information about the printer.....9
  - Connecting the printer to an outlet.....10
  - Selecting a location for the printer.....10
  - Printer configurations.....11
  - Understanding the basic functions of the scanner.....13
  - Using the ADF and scanner glass.....14
- Understanding the printer control panel.....15**
  - Using the control panel.....15
  - Understanding the colors of the Sleep button and indicator lights.....15
  - Understanding the home screen.....16
  - Using the touch-screen buttons.....18
- Setting up and using the home screen applications.....20**
  - Finding the IP address of the printer.....20
  - Finding the IP address of the computer.....20
  - Accessing the Embedded Web Server.....20
  - Customizing the home screen.....21
  - Understanding the different applications.....21
  - Activating the home screen applications.....22
    - Finding information about the home screen applications.....22
    - Setting up Forms and Favorites .....22
    - Setting up Card Copy .....23
    - Using MyShortcut .....23
    - Setting up Multi Send .....24
    - Setting up Scan to Network .....24
  - Setting up Remote Operator Panel.....25
  - Exporting and importing a configuration.....26
- Additional printer setup.....27**
  - Installing internal options.....27
  - Installing hardware options.....38
  - Attaching cables.....44

Setting up the printer software.....	45
Networking.....	46
Verifying printer setup.....	50
<b>Loading paper and specialty media.....</b>	<b>51</b>
Setting the paper size and type.....	51
Configuring Universal paper settings.....	51
Loading trays.....	51
Loading the multipurpose feeder.....	53
Linking and unlinking trays.....	56
<b>Paper and specialty media guide.....</b>	<b>58</b>
Using specialty media.....	58
Paper guidelines.....	60
Supported paper sizes, types, and weights.....	63
<b>Printing.....</b>	<b>70</b>
Printing forms and a document.....	70
Printing from a flash drive or mobile device.....	71
Printing confidential and other held jobs.....	73
Printing information pages.....	74
Canceling a print job.....	75
<b>Copying.....</b>	<b>76</b>
Making copies.....	76
Creating a copy shortcut.....	77
Customizing copy settings.....	78
Placing a header or footer on pages.....	81
Canceling a copy job while pages are being printed.....	81
Understanding the copy options.....	81
<b>E-mailing.....</b>	<b>84</b>
Setting up the printer to e-mail.....	84
Creating an e-mail shortcut.....	85
E-mailing a document.....	85
Customizing e-mail settings.....	86
Canceling an e-mail.....	86
Understanding the e-mail options.....	86

---

<b>Faxing.....</b>	<b>89</b>
Setting up the printer to fax.....	89
Sending a fax.....	105
Creating shortcuts.....	107
Customizing fax settings.....	108
Canceling a fax job.....	109
Holding and forwarding faxes.....	109
Understanding the fax options.....	110
<b>Scanning.....</b>	<b>112</b>
Using Scan to Network.....	112
Scanning to an FTP address.....	112
Scanning to a computer or flash drive.....	114
Understanding the scan options.....	115
<b>Understanding the printer menus.....</b>	<b>117</b>
Menus list.....	117
Paper menu.....	118
Reports menu.....	128
Network/Ports menu.....	129
Security menu.....	141
Settings menu.....	148
<b>Saving money and the environment.....</b>	<b>198</b>
Saving paper and toner.....	198
Saving energy.....	199
Recycling.....	200
<b>Securing the printer.....</b>	<b>202</b>
Using the security lock feature.....	202
Statement of Volatility.....	202
Erasing volatile memory.....	203
Erasing non-volatile memory.....	203
Erasing printer hard disk memory.....	203
Configuring printer hard disk encryption.....	204
Finding printer security information.....	204

**Maintaining the printer.....205**

- Cleaning printer parts.....205
- Checking the status of parts and supplies.....210
- Estimated number of remaining pages.....210
- Ordering supplies.....211
- Ordering a 300K maintenance kit.....212
- Storing parts and supplies.....212
- Replacing supplies.....213
- Replacing the 300K maintenance kit.....225
- Replacing the ADF scan pad.....235
- Moving the printer.....237

**Managing the printer.....239**

- Checking the virtual display.....239
- Setting up e-mail alerts.....239
- Viewing reports.....239
- Copying printer settings to other printers.....240
- Configuring supply notifications from the Embedded Web Server.....240
- Restoring factory default settings.....241

**Clearing jams.....242**

- Avoiding jams.....242
- Understanding jam messages and locations.....243
- [x]-page jam, clear jammed paper from multipurpose feeder. [200.xx].....245
- [x]-page jam, open door C and clear all jammed paper. [2yy.xx].....245
- [x]-page jam, slide the 3000-sheet tray and open door C. [2yy.xx].....247
- [x]-page jam, open door D and clear all jammed paper. [24y.xx].....249
- [x]-page jam, slide the 3000-sheet tray and open door D. [24y.xx].....251
- [x]-page jam, slide the 3000-sheet tray and open door F. [24y.xx].....252
- [x]-page jam, open doors G, H, and J and clear jammed paper. Leave paper in bin. [4yy.xx].....255
- [x]-page jam, press latch to access area G. Leave paper in bin. [40y.xx].....258
- [x]-page jam, press latch to access area G and clear jammed staples. Leave paper in bin. [402.93].....261
- [x]-page jam, open door H and rotate knob H6 clockwise. Leave paper in bin. [426.xx–428.xx].....264
- [x]-page jam, press latch at area E to open ADF’s top cover. [28y.xx].....269

<b>Troubleshooting.....</b>	<b>271</b>
Understanding the printer messages.....	271
Solving printer problems.....	287
Solving print problems.....	294
Solving copy problems.....	320
Solving fax problems.....	322
Solving scanner problems.....	329
Solving home screen application problems.....	333
Embedded Web Server does not open.....	333
Contacting customer support.....	334
<b>Notices.....</b>	<b>335</b>
Product information.....	335
Edition notice.....	335
Power consumption.....	340
<b>Index.....</b>	<b>353</b>

## Safety information

Connect the power cord directly to an appropriately rated and properly grounded electrical outlet that is near the product and easily accessible.

 **CAUTION—POTENTIAL INJURY:** Do not use this product with extension cords, multioutlet power strips, multioutlet extenders, or other types of surge or UPS devices. The power rating capacity of these types of accessories can be easily overloaded by a laser printer and may result in poor printer performance, property damage, or potential fire.

Do not place or use this product near water or wet locations.

 **CAUTION—POTENTIAL INJURY:** This product uses a laser. Use of controls or adjustments or performance of procedures other than those specified herein may result in hazardous radiation exposure.

This product uses a printing process that heats the print media, and the heat may cause the media to release emissions. You must understand the section in your operating instructions that discusses the guidelines for selecting print media to avoid the possibility of harmful emissions.

 **CAUTION—POTENTIAL INJURY:** The lithium battery in this product is not intended to be replaced. There is a danger of explosion if a lithium battery is incorrectly replaced. Do not recharge, disassemble, or incinerate a lithium battery. Discard used lithium batteries according to the manufacturer's instructions and local regulations.

 **CAUTION—HOT SURFACE:** The inside of the printer might be hot. To reduce the risk of injury from a hot component, allow the surface to cool before touching it.

 **CAUTION—POTENTIAL INJURY:** The printer weight is greater than 18 kg (40 lb) and requires two or more trained personnel to lift it safely.

 **CAUTION—POTENTIAL INJURY:** Before moving the printer, follow these guidelines to avoid personal injury or printer damage:

- Turn off the printer, and then unplug the power cord from the electrical outlet.
- Disconnect all cords and cables from the printer.
- If the printer does not have a caster base but is configured with optional trays, then remove the trays.
- Use the handholds located on both sides of the printer to lift it.
- Make sure your fingers are not under the printer when you set it down.
- Make sure there is adequate clearance around the printer.
- Use only the power cord provided with this product or the manufacturer's authorized replacement.

Use only the telecommunications (RJ-11) cord provided with this product or a 26 AWG or larger replacement when connecting this product to the public switched telephone network.

 **CAUTION—SHOCK HAZARD:** If you are accessing the controller board or installing optional hardware or memory devices sometime after setting up the printer, then turn the printer off, and unplug the power cord from the electrical outlet before continuing. If you have any other devices attached to the printer, then turn them off as well, and unplug any cables going into the printer.

 **CAUTION—SHOCK HAZARD:** Make sure that all external connections (such as Ethernet and telephone system connections) are properly installed in their marked plug-in ports.

This product is designed, tested, and approved to meet strict global safety standards with the use of specific manufacturer's components. The safety features of some parts may not always be obvious. The manufacturer is not responsible for the use of other replacement parts.

This product produces ozone during normal operation, and is equipped with a filter designed to limit ozone concentrations to levels well below the recommended exposure limits. To avoid high ozone concentration levels during extensive usage, install this product in a well-ventilated area and replace the ozone and exhaust filters as indicated in the product maintenance instructions.

 **CAUTION—POTENTIAL INJURY:** Do not cut, twist, bind, crush, or place heavy objects on the power cord. Do not subject the power cord to abrasion or stress. Do not pinch the power cord between objects such as furniture and walls. If any of these things happen, a risk of fire or electrical shock results. Inspect the power cord regularly for signs of such problems. Remove the power cord from the electrical outlet before inspecting it.

Refer service or repairs, other than those described in the user documentation, to a service representative.

 **CAUTION—SHOCK HAZARD:** To avoid the risk of electrical shock when cleaning the exterior of the printer, unplug the power cord from the electrical outlet and disconnect all cables from the printer before proceeding.

 **CAUTION—SHOCK HAZARD:** Do not use the fax feature during a lightning storm. Do not set up this product or make any electrical or cabling connections, such as the fax feature, power cord, or telephone, during a lightning storm.

 **CAUTION—TIPPING HAZARD:** Floor-mounted configurations require additional furniture for stability. You must use either a printer stand or printer base if you are using multiple input options. If you purchased a multifunction printer (MFP) that scans, copies, and faxes, then you may need additional furniture. For more information, see [www.lexmark.com/multifunctionprinters](http://www.lexmark.com/multifunctionprinters).

 **CAUTION—POTENTIAL INJURY:** To reduce the risk of equipment instability, load each tray separately. Keep all other trays closed until needed.

**SAVE THESE INSTRUCTIONS.**



# Learning about the printer

## Finding information about the printer

What are you looking for?	Find it here
Initial setup instructions: <ul style="list-style-type: none"> <li>• Connecting the printer</li> <li>• Installing the printer software</li> </ul>	Setup documentation—The setup documentation came with the printer and is also available at <a href="http://support.lexmark.com">http://support.lexmark.com</a> .
Additional setup and instructions for using the printer: <ul style="list-style-type: none"> <li>• Selecting and storing paper and specialty media</li> <li>• Loading paper</li> <li>• Configuring printer settings</li> <li>• Viewing and printing documents and photos</li> <li>• Setting up and using the printer software</li> <li>• Configuring the printer on a network</li> <li>• Caring for and maintaining the printer</li> <li>• Troubleshooting and solving problems</li> </ul>	<i>User's Guide</i> and <i>Quick Reference Guide</i> —The guides are available at <a href="http://support.lexmark.com">http://support.lexmark.com</a> . <b>Note:</b> These guides are also available in other languages.
Information on setting up and configuring the accessibility features of your printer	<i>Lexmark Accessibility Guide</i> —This guide is available at <a href="http://support.lexmark.com">http://support.lexmark.com</a> .
Help using the printer software	Windows or Mac Help—Open a printer software program or application, and then click <b>Help</b> .  Click  to view context-sensitive information. <b>Notes:</b> <ul style="list-style-type: none"> <li>• Help is automatically installed with the printer software.</li> <li>• The printer software is located in the printer program folder or on the desktop, depending on your operating system.</li> </ul>

What are you looking for?	Find it here
<p>The latest supplemental information, updates, and customer support:</p> <ul style="list-style-type: none"> <li>• Documentation</li> <li>• Driver downloads</li> <li>• Live chat support</li> <li>• E-mail support</li> <li>• Voice support</li> </ul>	<p>Lexmark support Web site—  <a href="http://support.lexmark.com">http://support.lexmark.com</a></p> <p><b>Note:</b> Select your country or region, and then select your product to view the appropriate support site.</p> <p>Support telephone numbers and hours of operation for your country or region can be found on the support Web site or on the printed warranty that came with your printer.</p> <p>Record the following information (located on the store receipt and at the back of the printer), and have it ready when you contact customer support so that they may serve you faster:</p> <ul style="list-style-type: none"> <li>• Machine Type number</li> <li>• Serial number</li> <li>• Date purchased</li> <li>• Store where purchased</li> </ul>
<p>Warranty information</p>	<p>Warranty information varies by country or region:</p> <ul style="list-style-type: none"> <li>• <b>In the U.S.</b>—See the Statement of Limited Warranty included with this printer, or go to <a href="http://support.lexmark.com">http://support.lexmark.com</a>.</li> <li>• <b>In other countries and regions</b>—See the printed warranty that came with this printer.</li> </ul>

## Connecting the printer to an outlet

Connect the power cord to the printer and then to a properly grounded and easily accessible electrical outlet.

**Note:** The electrical outlet may look different depending on your country or region.

## Selecting a location for the printer

 **CAUTION—POTENTIAL INJURY:** The printer weight is greater than 18 kg (40 lb) and requires two or more trained personnel to lift it safely.

When selecting a location for the printer, leave enough room to open trays, covers, and doors. If you plan to install any options, then leave enough room for them also. It is important to:

- Set up the printer near a properly grounded and easily accessible electrical outlet.
- Make sure that airflow in the room meets the latest revision of the ASHRAE 62 standard or the CEN Technical Committee 156 standard.
- Provide a flat, sturdy, and stable surface.
- Keep the printer:
  - Clean, dry, and free of dust.
  - Away from stray staples and paper clips.
  - Away from the direct airflow of air conditioners, heaters, or ventilators.
  - Free from direct sunlight and humidity extremes.

- Observe the recommended temperatures and avoid fluctuations:

Ambient temperature	10 to 30°C (50 to 86°F)
Storage temperature	-10 to 40°C (14 to 104°F)

- Allow the following recommended amount of space around the printer for proper ventilation:

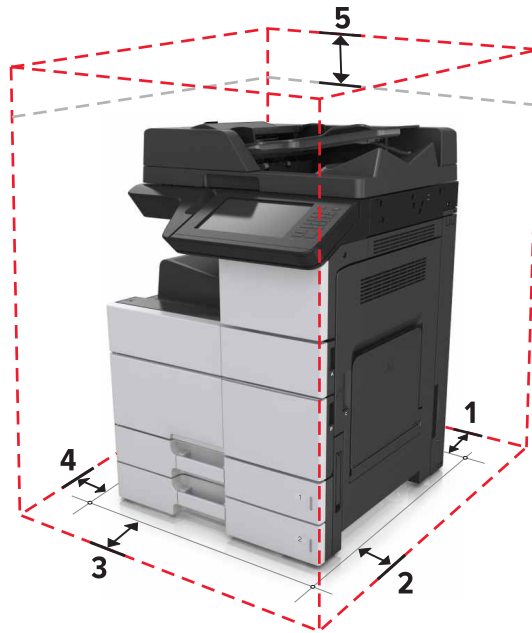

1	Rear	120 mm (4.80 in.)
2	Right side	400 mm (15.70 in.)
3	Front	444.5 mm (17.50 in.)
4	Left side	120 mm (4.80 in.)
5	Top	400 mm (15.70 in.)

## Printer configurations

**Note:** Make sure to configure the printer on a flat, sturdy, and stable surface.

## Basic model

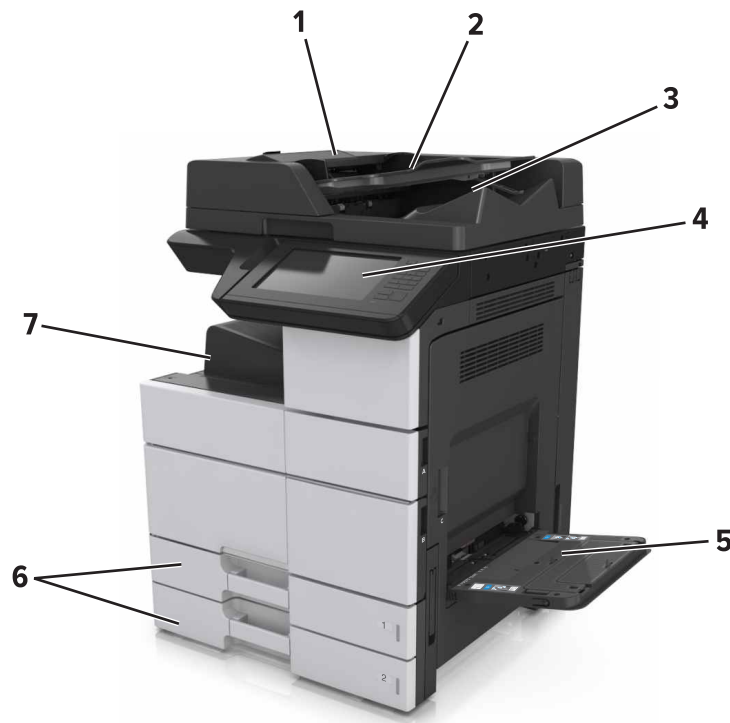

1	Automatic document feeder (ADF)
2	ADF tray
3	ADF bin
4	Control panel
5	Multipurpose feeder
6	Standard 2 x 500-sheet tray
7	Standard bin

## Configured model

**CAUTION—TIPPING HAZARD:** Floor-mounted configurations require additional furniture for stability. You must use either a printer stand or printer base if you are using multiple input options. If you purchased a multifunction printer (MFP) that scans, copies, and faxes, then you may need additional furniture. For more information, see [www.lexmark.com/multifunctionprinters](http://www.lexmark.com/multifunctionprinters).



	Hardware option	Alternative hardware option
1	Staple finisher <b>Note:</b> This is supported only in select printer models.	None
2	3000-sheet tray	None
3	2 x 500-sheet tray	2500-sheet tray
4	2500-sheet tray	2 x 500-sheet tray
5	Finisher <ul style="list-style-type: none"> <li>• Staple, hole punch finisher</li> <li>• Booklet finisher</li> </ul>	None

When using optional trays:

- The 3000-sheet tray is supported only if another optional tray is installed.
- The staple finisher is not supported if another finisher is installed.

## Understanding the basic functions of the scanner

- Make quick copies or set the printer to perform specific copy jobs.
- Send a fax using the printer control panel.
- Send a fax to multiple fax destinations at the same time.
- Scan documents and send them to your computer, an e-mail address, a flash drive, or an FTP destination.
- Scan documents and send them to another printer (PDF through an FTP).

## Using the ADF and scanner glass

### Automatic document feeder (ADF)



- Use the ADF for multiple-page or two-sided documents.
- Load an original document faceup.

### Scanner glass



- Use the scanner glass for single-page documents, book pages, small items (such as postcards or photos), transparencies, photo paper, or thin media (such as magazine clippings).
- Place the document facedown in the corner with the arrow.

# Understanding the printer control panel

## Using the control panel



Use the		To
1	Display	<ul style="list-style-type: none"> <li>View the printer status and messages.</li> <li>Set up and operate the printer.</li> </ul>
2	Home button	Go to the home screen.
3	Sleep button	Enable Sleep mode or Hibernate mode. The following actions wake the printer from Sleep mode: <ul style="list-style-type: none"> <li>Touching the control panel home screen</li> <li>Opening the scanner cover</li> </ul> The following actions wake the printer from Hibernate mode: <ul style="list-style-type: none"> <li>Pressing the Sleep button until the printer wakes</li> <li>Performing a power-on reset using the main power switch</li> </ul>
4	Keypad	Enter numbers, letters, or symbols.
5	Start button	Start a job, depending on which mode is selected.
6	Clear all / Reset button	Reset the default settings of a function, such as copying, faxing, or scanning.
7	Stop or Cancel button	Stop all printer activity.
8	Indicator light	Check the status of the printer.

## Understanding the colors of the Sleep button and indicator lights

The colors of the Sleep button and indicator lights on the printer control panel signify a certain printer status or condition.

Indicator light	Printer status
Off	The printer is off or in Hibernate mode.
Blinking green	The printer is warming up, processing data, or printing.
Solid green	The printer is on, but idle.
Blinking red	The printer requires user intervention.

  

Sleep button light	Printer status
Off	The printer is off, idle or in Ready state.
Solid amber	The printer is in Sleep mode.
Blinking amber	The printer is entering or waking from Hibernate mode.
Blinking amber for 0.1 second, then goes completely off for 1.9 seconds in a slow, pulsing pattern	The printer is in Hibernate mode.

## Understanding the home screen

When the printer is turned on, the display shows a basic screen, referred to as the home screen. Touch the home screen buttons and icons to initiate an action such as copying, faxing, or scanning; to open the menu screen; or to respond to messages.

**Note:** Your home screen may vary depending on your home screen customization settings, administrative setup, and active embedded solutions.

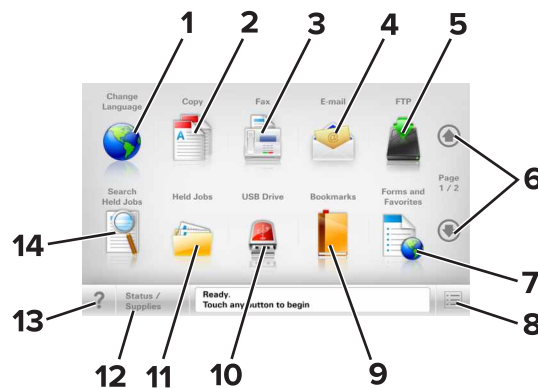



Touch	To
1	Change Language Launch the Change Language pop-up window that lets you change the primary language of the printer.
2	Copy Access the Copy menus and make copies.
3	Fax Access the Fax menus and send fax.
4	E-mail Access the E-mail menus and send e-mails.
5	FTP Access the File Transfer Protocol (FTP) menus and scan documents directly to an FTP server.
6	Arrows Scroll up or down.



Touch		To
7	Forms and Favorites	Quickly find and print frequently used online forms.
8	Menu icon	Access the printer menus. <b>Note:</b> The menus are available only when the printer is in Ready state.
9	Bookmarks	Create, organize, and save a set of bookmarks (URL) into a tree view of folders and file links. <b>Note:</b> The tree view supports only bookmarks created from this function, and not from any other application.
10	USB Drive	View, select, print, scan, or e-mail photos and documents from a flash drive. <b>Note:</b> This icon appears only when you return to the home screen while a memory card or flash drive is connected to the printer.
11	Held Jobs	Display all current held jobs.
12	Status/Supplies	<ul style="list-style-type: none"> <li>• Show a warning or error message whenever the printer requires intervention to continue processing.</li> <li>• Access the messages screen for more information on the message, and how to clear it.</li> </ul>
13	Tips	Open a context-sensitive Help dialog.
14	Search Held Jobs	Search for one or more of the following items: <ul style="list-style-type: none"> <li>• User name for held or confidential print jobs</li> <li>• Job names for held jobs, excluding confidential print jobs</li> <li>• Profile names</li> <li>• Bookmark container or print job names</li> <li>• USB container or print job names for supported file types</li> </ul>

## Features

Feature	Description
Menu trail line Example: <u>Menus</u> > <u>Settings</u> > <u>Copy Settings</u> > Number of Copies	A menu trail line is located at the top of each menu screen. This feature shows the path taken to arrive at the current menu.  Touch any of the underlined words to return to that menu.  Number of Copies is not underlined because it is the current screen. If you touch an underlined word on the “Number of Copies” screen before the number of copies is set and saved, then the selection is not saved, and it does not become the default setting.
Attendance message alert  	If an attendance message affects a function, then this icon appears and the red indicator light blinks.
Warning  	If an error condition occurs, then this icon appears.

Feature	Description
Status message bar	<ul style="list-style-type: none"> <li>• Show the current printer status such as <b>Ready</b> or <b>Busy</b>.</li> <li>• Show printer conditions such as <b>Toner Low</b> or <b>Cartridge Low</b>.</li> <li>• Show intervention messages so the printer can continue processing.</li> </ul>
Printer IP address Example: 123 . 123 . 123 . 123	The IP address of your network printer is located at the upper left corner of the home screen and appears as four sets of numbers separated by periods. You can use the IP address when accessing the Embedded Web Server so you can view and remotely configure printer settings even when you are not physically near the printer.

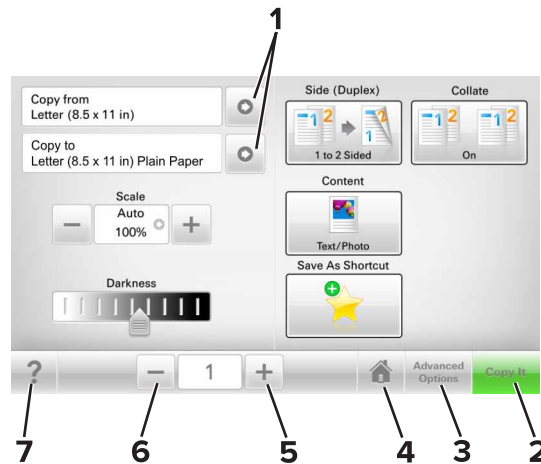

## Using the touch-screen buttons

**Note:** Your home screen, icons, and buttons may vary, depending on your home screen customization settings, administrative setup, and active embedded solutions.



	Touch	To
1	Arrows	View a list of options.
2	Copy It	Print a copy.
3	Advanced Options	Select a copy option.
4	Home	Go to the home screen.
5	Increase	Select a higher value.
6	Decrease	Select a lower value.
7	Tips	Open a context-sensitive Help dialog.

## Other touch-screen buttons

Touch	To
Accept 	Save a setting.
Cancel 	<ul style="list-style-type: none"><li>• Cancel an action or a selection.</li><li>• Exit a screen and return to the previous screen without saving changes.</li></ul>
Reset 	Reset values on the screen.

# Setting up and using the home screen applications

## Notes:

- Your home screen may vary depending on your home screen customization settings, administrative setup, and active embedded applications.
- There may be additional solutions and applications available for purchase. For more information, go to [www.lexmark.com](http://www.lexmark.com) or contact the place where you purchased the printer.
- The shortcuts that you created using MyShortcut can only be edited or deleted using the application. For more information, see [“Using MyShortcut” on page 23](#).

## Finding the IP address of the printer

**Note:** Make sure your printer is connected to a network or to a print server.

You can find the printer IP address:

- From the top left corner of the printer home screen.
- From the TCP/IP section in the Network/Ports menu.
- By printing a network setup page or menu settings page, and then finding the TCP/IP section.

**Note:** An IP address appears as four sets of numbers separated by periods, such as 123.123.123.123.

## Finding the IP address of the computer

### For Windows users

- 1 In the Run dialog box, type `cmd` to open the command prompt.
- 2 Type `ipconfig`, and then look for the IP address.

### For Macintosh users

- 1 From System Preferences in the Apple menu, select **Network**.
- 2 Select your connection type, and then click **Advanced > TCP/IP**.
- 3 Look for the IP address.

## Accessing the Embedded Web Server

The Embedded Web Server is the printer Web page that lets you view and remotely configure printer settings even when you are not physically near the printer.

- 1 Obtain the printer IP address:
  - From the printer control panel home screen
  - From the TCP/IP section in the Network/Ports menu
  - By printing a network setup page or menu settings page, and then finding the TCP/IP section

**Note:** An IP address appears as four sets of numbers separated by periods, such as 123 . 123 . 123 . 123.

**2** Open a Web browser, and then type the printer IP address in the address field.

**3** Press **Enter**.

**Note:** If you are using a proxy server, then temporarily disable it to load the Web page correctly.

## Customizing the home screen

**1** Open a Web browser, and then type the printer IP address in the address field.

**Note:** View the printer IP address on the printer home screen. The IP address appears as four sets of numbers separated by periods, such as 123.123.123.123.

**2** Do one or more of the following:

- Show or hide the icons of basic printer functions.
  - a** Click **Settings > General Settings > Home screen customization**.
  - b** Select the check boxes to specify which icons appear on the home screen.

**Note:** If you clear a check box beside an icon, then the icon does not appear on the home screen.

- c** Click **Submit**.
- Customize the icon for an application. For more information, see [“Finding information about the home screen applications” on page 22](#) or see the documentation that came with the application.

## Understanding the different applications

Use	To
<b>Card Copy</b>	Scan and print both sides of a card on a single page. For more information, see <a href="#">“Setting up Card Copy” on page 23</a> .
<b>Fax</b>	Scan a document, and then send it to a fax number. For more information, see <a href="#">“Faxing” on page 89</a> .
<b>Forms and Favorites</b>	Quickly find and print frequently used online forms directly from the printer home screen. For more information, see <a href="#">“Setting up Forms and Favorites” on page 22</a> .
<b>Multi Send</b>	Scan a document, and then send it to multiple destinations. For more information, see <a href="#">“Setting up Multi Send” on page 24</a> .
<b>MyShortcut</b>	Create shortcuts directly on the printer home screen. For more information, see <a href="#">“Using MyShortcut” on page 23</a> .
<b>Scan to E-mail</b>	Scan a document, and then send it to an e-mail address. For more information, see <a href="#">“E-mailing” on page 84</a> .
<b>Scan to Computer</b>	Scan a document, and then save it to a predefined folder on a host computer. For more information, see <a href="#">“Setting up Scan to Computer” on page 114</a> .
<b>Scan to FTP</b>	Scan documents directly to a File Transfer Protocol (FTP) server. For more information, see <a href="#">“Scanning to an FTP address” on page 113</a> .
<b>Scan to Network</b>	Scan a document, and then send it to a network shared folder. For more information, see <a href="#">“Setting up Scan to Network” on page 24</a> .

## Activating the home screen applications

### Finding information about the home screen applications

Your printer comes with preinstalled home screen applications. Before you can use these applications, you must first activate and set up these applications using the Embedded Web Server. For more information on accessing the Embedded Web Server, see [“Accessing the Embedded Web Server” on page 20](#).

For more information on configuring and using the home screen applications, do the following:

- 1 Go to <http://support.lexmark.com>.
- 2 Click **Software Solutions**, and then select either of the following:
  - **Scan to Network**—This lets you find information about the Scan to Network application.
  - **Other Applications**—This lets you find information about the other applications.
- 3 Click the **Manuals** tab, and then select the document for the home screen application.

### Setting up Forms and Favorites

**Note:** A later version of this *User's Guide* may contain a direct link to the *Administrator's Guide* of this application. To check for updates of this *User's Guide*, go to <http://support.lexmark.com>.

Use	To
	<p>Streamline work processes by letting you quickly find and print frequently used online forms directly from the printer home screen.</p> <p><b>Note:</b> The printer must have permission to access the network folder, FTP site, or Web site where the bookmark is stored. From the computer where the bookmark is stored, use sharing, security, and firewall settings to allow the printer at least a <i>read</i> access. For help, see the documentation that came with your operating system.</p>

- 1 Open a Web browser, and then type the printer IP address in the address field.

**Note:** View the printer IP address on the printer home screen. The IP address appears as four sets of numbers separated by periods, such as 123.123.123.123.

- 2 Click **Settings > Apps > Apps Management > Forms and Favorites**.
- 3 Click **Add**, and then customize the settings.

**Notes:**

- See the mouse-over help beside each field for a description of the setting.
- To make sure the location settings of the bookmark are correct, type the correct IP address of the host computer where the bookmark is located. For more information on obtaining the IP address of the host computer, see [“Finding the IP address of the computer” on page 20](#).
- Make sure the printer has access rights to the folder where the bookmark is located.

- 4 Click **Apply**.

To use the application, touch **Forms and Favorites** on the printer home screen, and then navigate through form categories, or search for forms based on a form number, name, or description.

## Setting up Card Copy

**Note:** A later version of this *User's Guide* may contain a direct link to the *Administrator's Guide* of this application. To check for updates of this *User's Guide*, go to <http://support.lexmark.com>.

Use	To
	<p>Quickly and easily copy insurance, identification, and other wallet-size cards.</p> <p>You can scan and print both sides of a card on a single page, saving paper and showing the information on the card in a more convenient manner.</p>

**1** Open a Web browser, and then type the printer IP address in the address field.

**Note:** View the printer IP address on the printer home screen. The IP address appears as four sets of numbers separated by periods, such as 123.123.123.123.

**2** Click **Settings > Apps > Apps Management > Card Copy**.

**3** Change the default scanning options, if necessary.

- **Default tray**—Select the default tray to be used for printing scan images.
- **Default number of copies**—Specify the number of copies that should automatically print when the application is used.
- **Default contrast setting**—Specify a setting to increase or decrease the level of contrast when a copy of the scanned card is printed. Select **Best for Content** if you want the printer to adjust the contrast automatically.
- **Default scale setting**—Set the size of the scanned card when printed. The default setting is 100% (full size).
- **Resolution setting**—Adjust the quality of the scanned card.

**Notes:**

- When scanning a card, make sure the scan resolution is not more than 200 dpi for color, and 400 dpi for black and white.
- When scanning multiple cards, make sure the scan resolution is not more than 150 dpi for color, and 300 dpi for black and white.

- **Print Borders**—Select the check box to print the scan image with a border around it.

**4** Click **Apply**.

To use the application, touch **Card Copy** on the printer home screen, and then follow the instructions.

## Using MyShortcut

**Note:** A later version of this *User's Guide* may contain a direct link to the *Administrator's Guide* of this application. To check for updates of this *User's Guide*, go to <http://support.lexmark.com>.

Use	To
	Create shortcuts on the printer home screen, with settings for up to 25 frequently used copy, fax, or e-mail jobs.

To use the application, touch **MyShortcut**, and then follow the instructions on the printer display.

## Setting up Multi Send

**Note:** A later version of this *User's Guide* may contain a direct link to the *Administrator's Guide* of this application. To check for updates of this *User's Guide*, go to <http://support.lexmark.com>.

Use	To
	Scan a document, and then send the scanned document to multiple destinations. <b>Note:</b> Make sure there is enough space in the printer hard disk.

- 1 Open a Web browser, and then type the printer IP address in the address field.

**Note:** View the printer IP address on the printer home screen. The printer IP address appears as four sets of numbers separated by periods, such as 123.123.123.123.

- 2 Click **Settings** > **Apps** > **Apps Management** > **Multi Send**.

- 3 From the Profiles section, click **Add**, and then customize the settings.

**Notes:**

- See the mouse-over help beside each field for a description of the setting.
- If you select **FTP** or **Share Folder** as a destination, then make sure the location settings of the destination are correct. Type the correct IP address of the host computer where the specified destination is located. For more information on obtaining the IP address of the host computer, see [“Finding the IP address of the computer” on page 20](#).

- 4 Click **Apply**.

To use the application, touch **Multi Send** on the printer home screen, and then follow the instructions on the printer display.

## Setting up Scan to Network

**Note:** A later version of this *User's Guide* may contain a direct link to the *Administrator's Guide* of this application. To check for updates of this *User's Guide*, go to <http://support.lexmark.com>.



Use	To
	<p>Scan a document and send it to a shared network folder. You can define up to 30 unique folder destinations.</p> <p><b>Notes:</b></p> <ul style="list-style-type: none"> <li>• The printer must have permission to write to the destinations. From the computer where the destination is specified, use sharing, security, and firewall settings to allow the printer at least a <i>write</i> access. For help, see the documentation that came with your operating system.</li> <li>• The Scan to Network icon appears only when one or more destinations are defined.</li> </ul>

- 1 Open a Web browser, and then type the printer IP address in the address field.

**Note:** View the printer IP address on the printer home screen. The IP address appears as four sets of numbers separated by periods, such as 123.123.123.123.

- 2 Do either of the following:
  - Click **Set up Scan to Network** > **Click here**.
  - Click **Settings** > **Apps** > **Apps Management** > **Scan to Network**.

- 3 Specify the destinations, and then customize the settings.

**Notes:**

- See the mouse-over help beside some of the fields for a description of the setting.
- To make sure the location settings of the destination are correct, type the correct IP address of the host computer where the specified destination is located. For more information on obtaining the IP address of the host computer, see [“Finding the IP address of the computer” on page 20](#).
- Make sure the printer has access rights to the folder where the specified destination is located.

- 4 Click **Apply**.

To use the application, touch **Scan to Network** on the printer home screen, and then follow the instructions on the printer display.

## Setting up Remote Operator Panel

This application enables you to interact with the printer control panel even when you are not physically near the network printer. From your computer, you can view the printer status, release held print jobs, create bookmarks, and do other print-related tasks.

- 1 Open a Web browser, and then type the printer IP address in the address field.

**Note:** View the printer IP address on the printer home screen. The IP address appears as four sets of numbers separated by periods, such as 123.123.123.123.

- 2 Click **Settings** > **Remote Operator Panel Settings**.
- 3 Select the **Enable** check box, and then customize the settings.
- 4 Click **Submit**.

To use the application, click **Remote Operator Panel** > **Launch VNC Applet**.

## Exporting and importing a configuration

You can export configuration settings into a text file, and then import the file to apply the settings to other printers.

- 1 Open a Web browser, and then type the printer IP address in the address field.

**Note:** View the IP address on the printer home screen. The IP address appears as four sets of numbers separated by periods, such as 123.123.123.123.

- 2 Export or import a configuration file for one or multiple applications.

### For one application

- a Navigate to:

**Settings > Apps > Apps Management > select an application > Configure**

- b Export or import the configuration file.

#### Notes:

- If a **JVM Out of Memory** error occurs, then repeat the export process until the configuration file is saved.
- If a timeout occurs and a blank screen appears, then refresh the Web browser, and then click **Apply**.

### For multiple applications

- a Click **Settings > Import/Export**.

- b Export or import a configuration file.

**Note:** When importing a configuration file, click **Submit** to complete the process.

# Additional printer setup

## Installing internal options

**⚠ CAUTION—SHOCK HAZARD:** If you are accessing the controller board or installing optional hardware or memory devices sometime after setting up the printer, then turn the printer off, and unplug the power cord from the electrical outlet before continuing. If you have any other devices attached to the printer, then turn them off as well, and unplug any cables going into the printer.

## Available internal options

- Memory card
  - DDR2 DIMM
  - Flash memory
    - Fonts
    - Firmware cards
      - Forms and Bar Code
      - PRESCRIBE
      - IPDS
- Lexmark™ Internal Solutions Ports (ISP)
  - Standard 10/100/1000 Ethernet
  - MarkNet™ N8350 802.11 b/g/n wireless print server
  - MarkNet N8352 802.11 b/g/n wireless print server

## Accessing the controller board

**Note:** Use the screwdriver located inside the bottom front door of the printer.

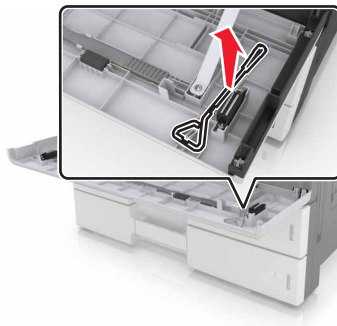

**⚠ CAUTION—SHOCK HAZARD:** If you are accessing the controller board or installing optional hardware or memory devices sometime after setting up the printer, then turn the printer off, and unplug the power cord from the electrical outlet before continuing. If you have any other devices attached to the printer, then turn them off as well, and unplug any cables going into the printer.

- 1 Remove the connector cover.

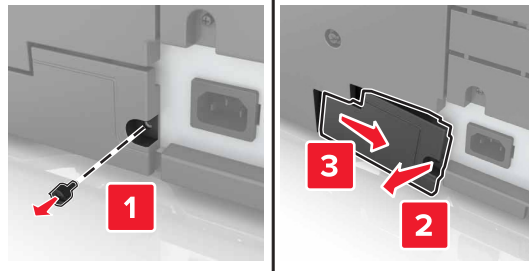

- 2 Remove the screws from the controller board access cover.

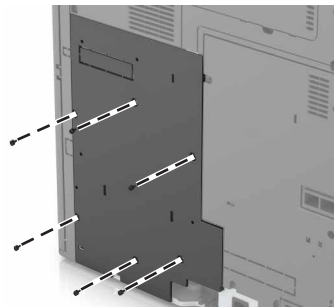

- 3 Remove the access cover.

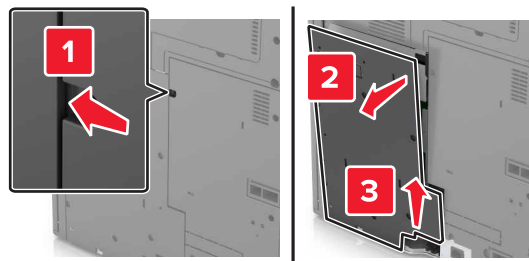

- 4 Use the following illustration to locate the appropriate connector:

**Warning—Potential Damage:** Controller board electronic components are easily damaged by static electricity. Touch a metal surface on the printer before touching any controller board electronic components or connectors.

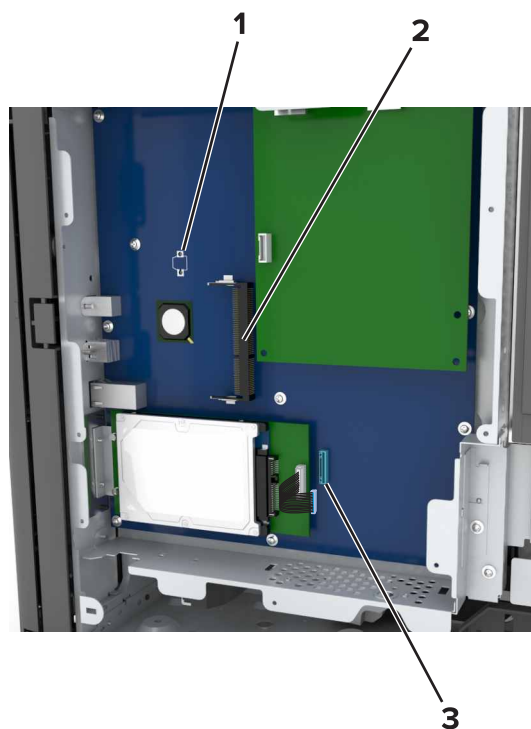

1	Option card connector
2	Memory card connector
3	Lexmark Internal Solutions Port or printer hard disk connector

5 Align the base of the access cover to the printer.

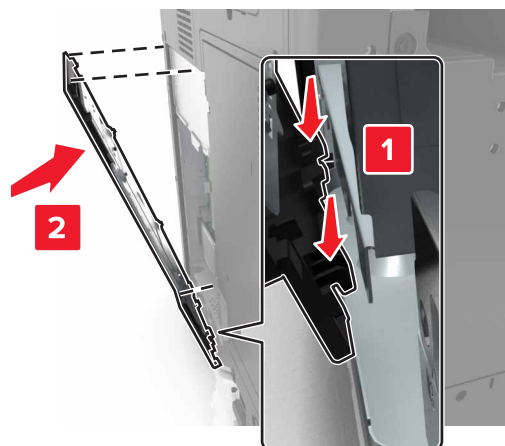

- 6 Reattach the access cover.

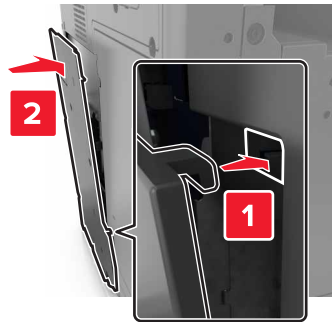

- 7 Tighten the screws on the access cover.
- 8 Reattach the connector cover.

## Installing a memory card

**CAUTION—SHOCK HAZARD:** If you are accessing the controller board or installing optional hardware or memory devices sometime after setting up the printer, then turn the printer off, and unplug the power cord from the electrical outlet before continuing. If you have any other devices attached to the printer, then turn them off as well, and unplug any cables going into the printer.

- 1 Access the controller board.

For more information, see [“Accessing the controller board” on page 27](#).

- 2 Unpack the memory card.

**Warning—Potential Damage:** Do not touch the connection points along the edge of the card. Doing so may cause damage.

- 3 Align the notch (1) on the memory card with the ridge (2) on the connector.

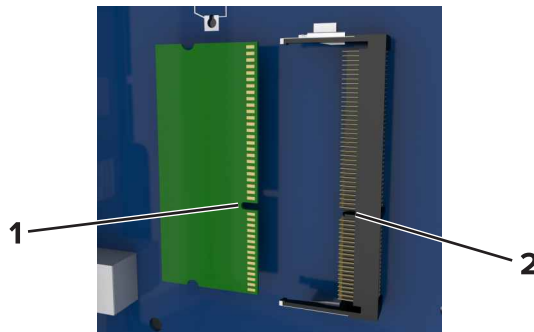

- 4 Push the memory card straight into the connector, and then push the card toward the controller board wall until it *clicks* into place.

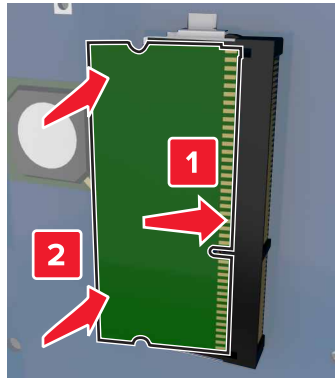

## Installing an optional card

**CAUTION—SHOCK HAZARD:** If you are accessing the controller board or installing optional hardware or memory devices sometime after setting up the printer, then turn the printer off, and unplug the power cord from the electrical outlet before continuing. If you have any other devices attached to the printer, then turn them off as well, and unplug any cables going into the printer.

**Warning—Potential Damage:** Controller board electronic components are easily damaged by static electricity. Touch a metal surface on the printer before touching any controller board electronic components or connectors.

- 1 Access the controller board.

For more information, see [“Accessing the controller board” on page 27](#).

- 2 Unpack the optional card.

**Warning—Potential Damage:** Avoid touching the connection points along the edge of the card. Doing so may cause damage.

- 3 Holding the card by its sides, align the plastic pins (1) on the card with the holes (2) on the controller board.

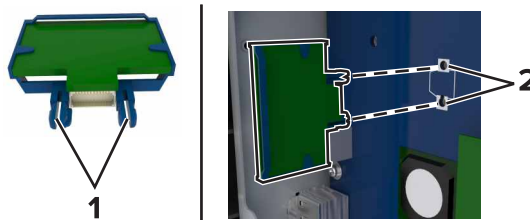

- 4 Push the card firmly into place.

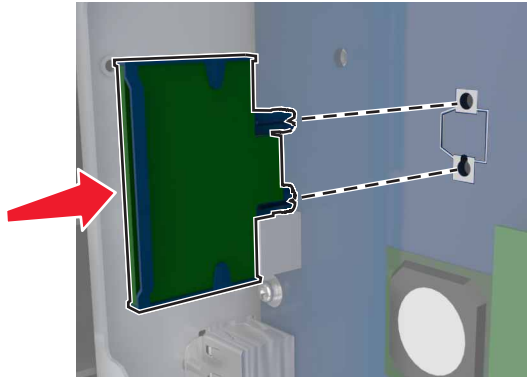

**Warning—Potential Damage:** Improper installation of the card may cause damage to the card and the controller board.

**Note:** The entire length of the connector on the card must touch and be flush with the controller board.

## Installing an Internal Solutions Port

The controller board supports one optional Lexmark Internal Solutions Port (ISP). Install an ISP for additional connectivity options.

**Note:** Use the screwdriver located inside the bottom front door of the printer.

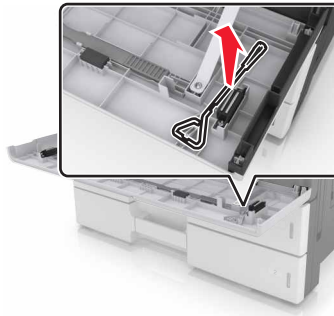

**CAUTION—SHOCK HAZARD:** If you are accessing the controller board or installing optional hardware or memory devices sometime after setting up the printer, then turn the printer off, and unplug the power cord from the electrical outlet before continuing. If you have any other devices attached to the printer, then turn them off as well, and unplug any cables going into the printer.

**Warning—Potential Damage:** Controller board electronic components are easily damaged by static electricity. Touch a metal surface on the printer before touching any controller board electronic components or connectors.

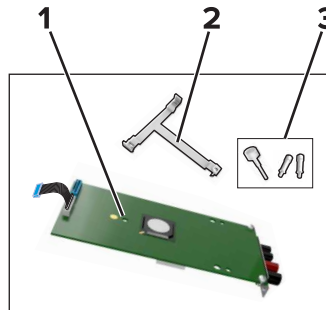

**1** Unpack the ISP kit.

<b>1</b>	ISP
<b>2</b>	Plastic mounting bracket
<b>3</b>	Thumbscrews

**2** Access the controller board. For more information, see [“Accessing the controller board” on page 27.](#)**3** Remove the printer hard disk.

**Note:** The hard disk must be removed before installing an ISP.

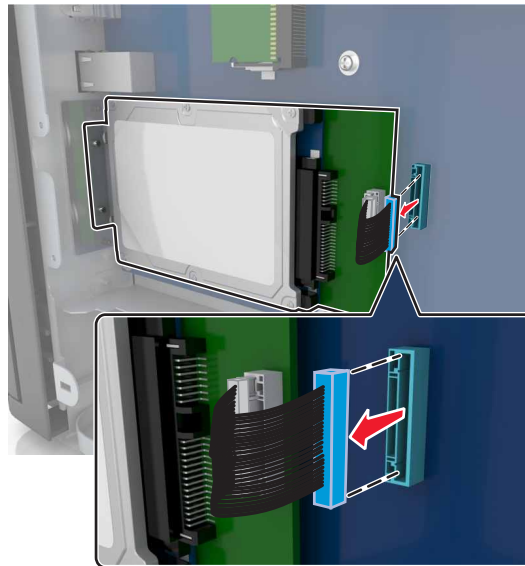
**a** Unplug the hard disk interface cable from the controller board.

- b** Remove the screws that secure the hard disk.

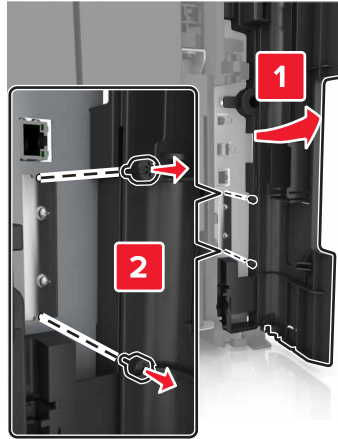

- c** Remove the hard disk.

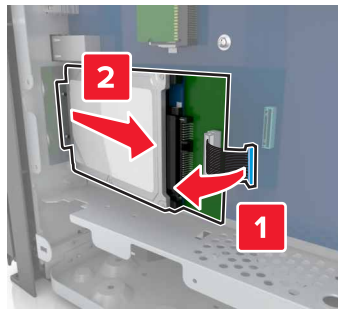

- 4** Install the ISP in the same location where the hard disk was located on the controller board.

- a** Align the posts of the plastic mounting bracket with the holes on the controller board cage, and then press the bracket on the cage until it *clicks* into place.

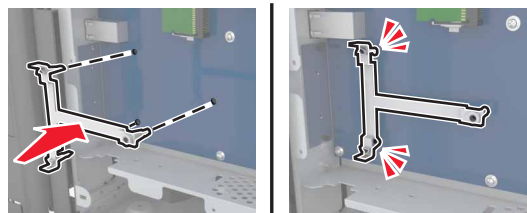

- b** Install the ISP on the bracket.

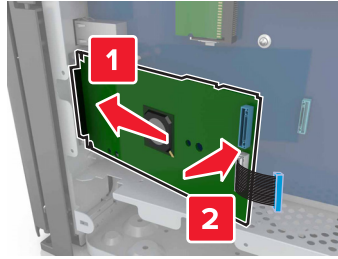

- c** Use the provided thumbscrew for the ISP to attach the ISP to the bracket.

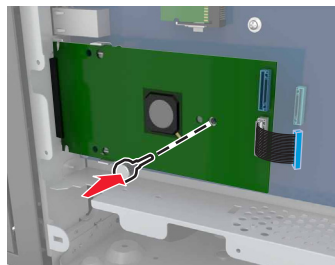

- 5** Secure the ISP mounting bracket to the controller board cage using the screws.

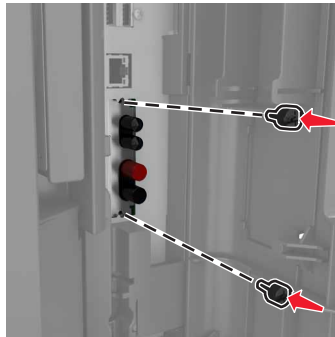

- 6** Remove the thumbscrews that attach the hard disk mounting bracket to the hard disk, and then remove the bracket.

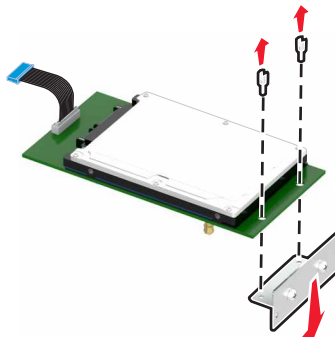

- 7** Align the standoffs of the hard disk with the holes on the ISP, and then press the hard disk down until the standoffs *click* into place.

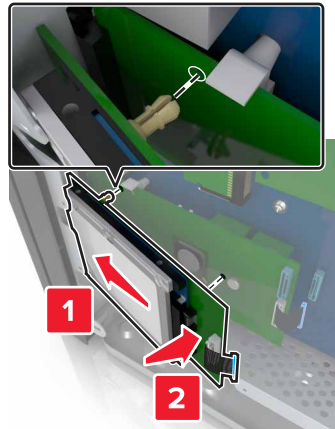

- 8** Insert the plug of the hard disk interface cable into the connector on the ISP, and then connect the ISP solution interface cable into the receptacle of the controller board.

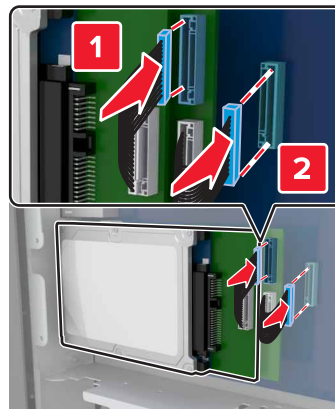

## Removing a printer hard disk

**Note:** Use the screwdriver located inside the bottom front door of the printer.

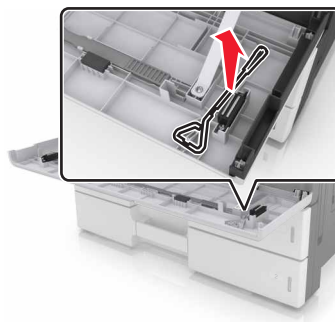

**CAUTION—SHOCK HAZARD:** If you are accessing the controller board or installing optional hardware or memory devices sometime after setting up the printer, then turn the printer off, and unplug the power cord from the electrical outlet before continuing. If you have any other devices attached to the printer, then turn them off as well, and unplug any cables going into the printer.

**Warning—Potential Damage:** Controller board electronic components are easily damaged by static electricity. Touch a metal surface on the printer before touching any controller board electronic components or connectors.

**1** Access the controller board.

For more information, see [“Accessing the controller board” on page 27](#).

**2** Unplug the hard disk interface cable from the controller board, leaving the cable attached to the hard disk. To unplug the cable, squeeze the paddle at the plug of the interface cable to disengage the latch before pulling out the cable.

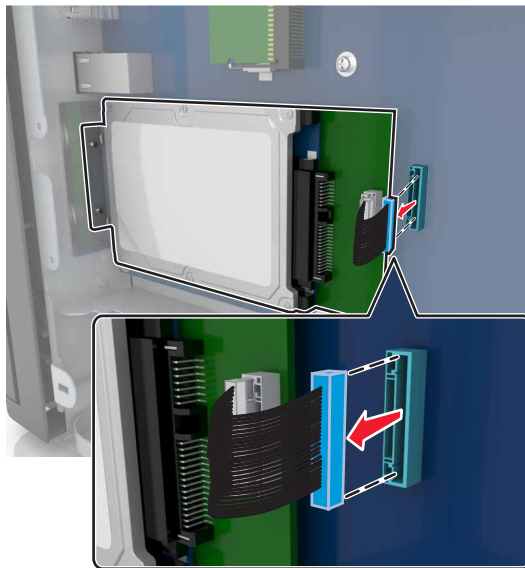

**3** Remove the screws holding the hard disk in place.

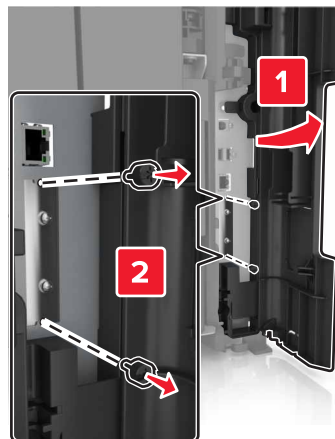

- 4 Remove the hard disk.

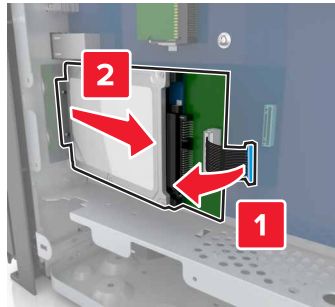

## Installing hardware options

### Order of installation

- CAUTION—POTENTIAL INJURY:** The printer weight is greater than 18 kg (40 lb) and requires two or more trained personnel to lift it safely.
- CAUTION—TIPPING HAZARD:** Floor-mounted configurations require additional furniture for stability. You must use either a printer stand or printer base if you are using multiple input options. If you purchased a multifunction printer (MFP) that scans, copies, and faxes, then you may need additional furniture. For more information, see [www.lexmark.com/multifunctionprinters](http://www.lexmark.com/multifunctionprinters).
- CAUTION—SHOCK HAZARD:** If you are accessing the controller board or installing optional hardware or memory devices sometime after setting up the printer, then turn the printer off, and unplug the power cord from the electrical outlet before continuing. If you have any other devices attached to the printer, then turn them off as well, and unplug any cables going into the printer.

Install the printer and any options you have purchased in the following order:

- Optional 2 x 500- or 2500-sheet tray
- Printer
- Staple finisher

**Note:** This option is supported only in select printer models.

- Staple, hole punch finisher or booklet finisher
- Optional 3000-sheet tray

**Note:** The staple finisher is not supported if another finisher is installed. For more information on installing the finishers and optional trays, see the instruction sheet that came with the option.

### Installing optional trays

#### Notes:

- For information on installing the optional 3000-sheet tray, see the instruction sheet that came with the option.
- Use the screwdriver located inside the bottom front door of the printer.

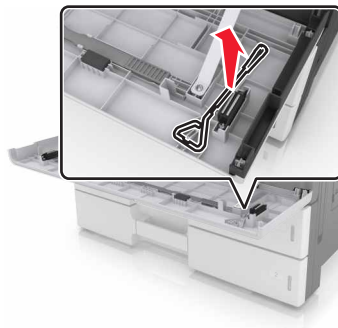

- ⚠ CAUTION—POTENTIAL INJURY:** The printer weight is greater than 18 kg (40 lb) and requires two or more trained personnel to lift it safely.
- ⚠ CAUTION—SHOCK HAZARD:** If you are accessing the controller board or installing optional hardware or memory devices sometime after setting up the printer, then turn the printer off, and unplug the power cord from the electrical outlet before continuing. If you have any other devices attached to the printer, then turn them off as well, and unplug any cables going into the printer.
- ⚠ CAUTION—TIPPING HAZARD:** Floor-mounted configurations require additional furniture for stability. You must use either a printer stand or printer base if you are using multiple input options. If you purchased a multifunction printer (MFP) that scans, copies, and faxes, then you may need additional furniture. For more information, see [www.lexmark.com/multifunctionprinters](http://www.lexmark.com/multifunctionprinters).

The optional trays come with the following accessories:

Accessory name	Quantity
Stabilizing feet 	2
Locking clip 	3
Metal bracket 	1

Accessory name	Quantity
Screw 	5

- 1 Turn off the printer.

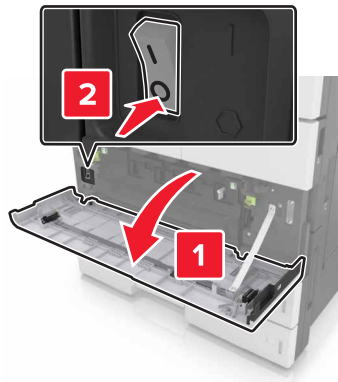

- 2 Unplug the power cord from the electrical outlet and then from the printer.
- 3 Unpack the optional tray, and then remove all packing material.

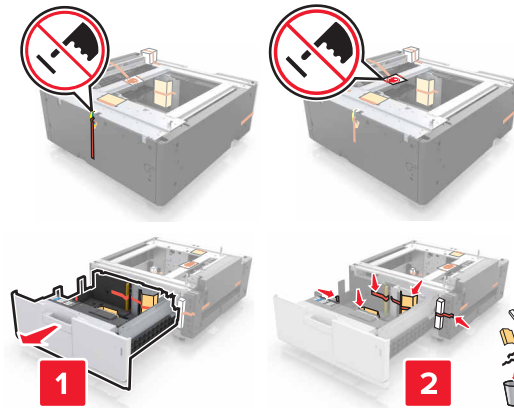

- 4 Attach the stabilizing feet to the optional tray.

**Note:** Make sure the feet *click* into place.



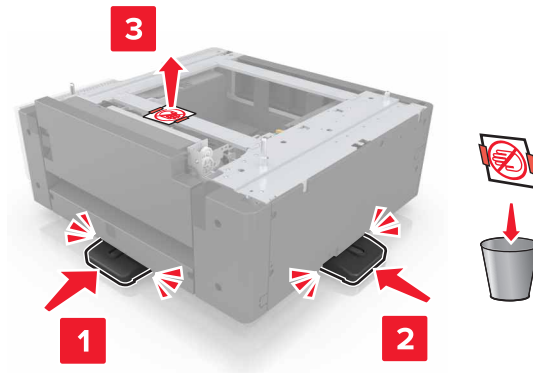

5 Remove the connector cover from the printer.

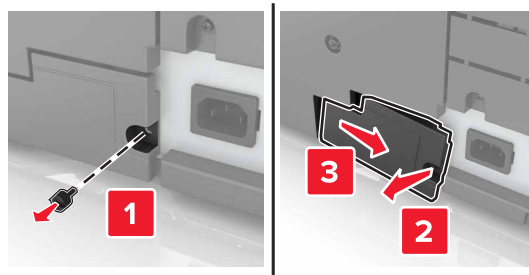

6 Lift the printer using the handles at the sides.

**CAUTION—POTENTIAL INJURY:** The printer weight is greater than 18 kg (40 lb) and requires two or more trained personnel to lift it safely.



**7** Align the printer with the tray, and then lower the printer into place.



**8** Remove the tape from the connectors, and then plug the connectors into the receptacles of the printer.

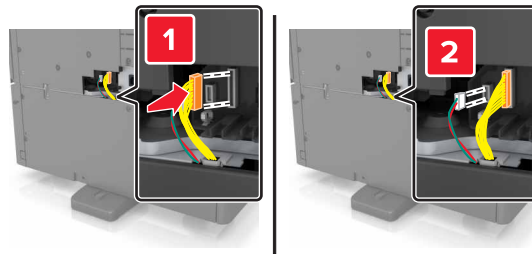

**9** Open Tray 2 and Tray 3.

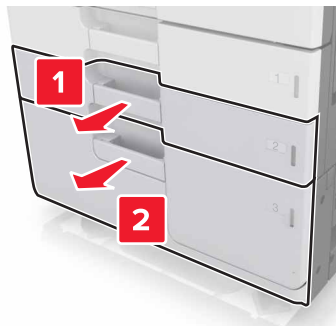

**10** Secure the tray to the printer using the locking clips and the metal bracket.

- Back

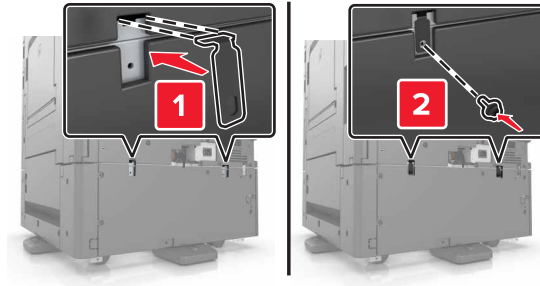

- Front

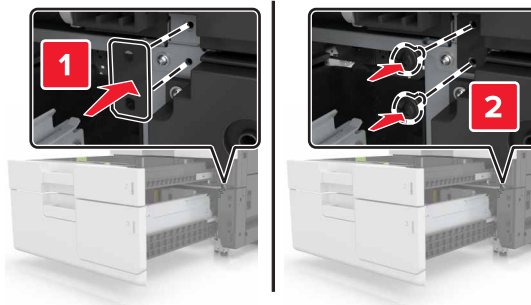
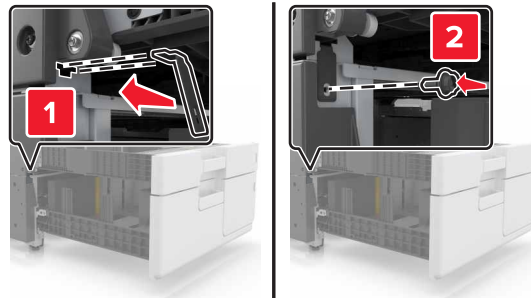

**11** Reinstall the connector cover.

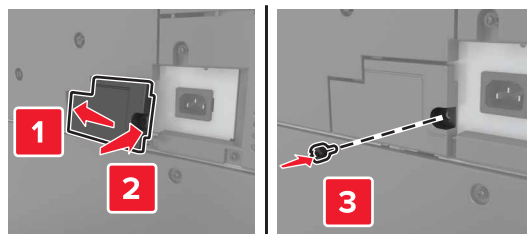

**12** Connect the power cord to the printer and electrical outlet.

13 Turn on the printer.

14 Set the printer software to recognize the optional tray. For more information, see [“Adding available options in the print driver” on page 45](#).

## Attaching cables

**⚠ CAUTION—POTENTIAL INJURY:** Do not use the fax feature during a lightning storm. Do not set up this product or make any electrical or cabling connections, such as the fax feature, power cord, or telephone, during a lightning storm.

Connect the printer to the computer using a USB cable, or to the network using an Ethernet cable.

Make sure to match the following:

- The USB symbol on the cable with the USB symbol on the printer
- The appropriate Ethernet cable to the Ethernet port

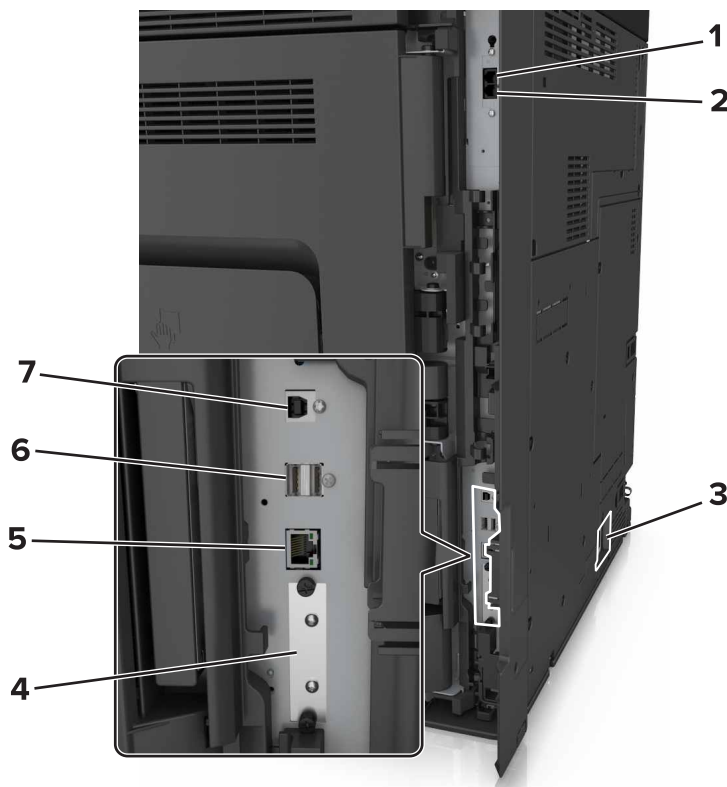

	Use the	To
1	EXT port	Connect additional devices (telephone or answering machine) to the printer and the telephone line. Use this port if you do not have a dedicated fax line for the printer and if this connection method is supported in your country or region. <b>Note:</b> Remove the plug to access the port.
2	LINE port	Connect the printer to an active telephone line through a standard wall jack (RJ-11), DSL filter, or VoIP adapter, or any other adapter that allows you to access the telephone line to send and receive faxes.

	Use the	To
3	Printer power cord socket	Connect the printer to a properly grounded electrical outlet.
4	Internal Solutions Port (ISP) or printer hard disk slot <b>Note:</b> If the printer has support for wireless connection, then the wireless antenna is attached here.	Attach an ISP or a printer hard disk.
5	Ethernet port	Connect the printer to a network.
6	USB ports	Attach a keyboard.
7	USB printer port	Connect the printer to a computer.

**Warning—Potential Damage:** Do not touch the USB cable, any wireless network adapter, or the printer in the area shown while actively printing. Loss of data or a malfunction can occur.

## Setting up the printer software

### Installing the printer

- 1 Obtain a copy of the software installer package.
- 2 Run the installer, and then follow the instructions on the computer screen.
- 3 For Macintosh users, add the printer.

**Note:** Obtain the printer IP address from the TCP/IP section in the Network/Ports menu.

### Adding available options in the print driver

#### For Windows users

- 1 Open the printers folder.

##### In Windows 8

From the Search charm, type **run**, and then navigate to:

**Run** > type **control printers** > **OK**

##### In Windows 7 or earlier

- a Click , or click **Start** and then click **Run**.
  - b Type **control printers**.
  - c Press **Enter**, or click **OK**.
- 2 Select the printer you want to update, and then do either of the following:
    - For Windows 7 or later, select **Printer properties**.
    - For earlier versions, select **Properties**.

- 3 Navigate to the Configuration tab, and then select **Update Now - Ask Printer**.
- 4 Apply the changes.

### For Macintosh users

- 1 From System Preferences in the Apple menu, navigate to your printer, and then select **Options & Supplies**.
- 2 Navigate to the list of hardware options, and then add any installed options.
- 3 Apply the changes.

## Networking

### Notes:

- Purchase a MarkNet N8350 wireless network adapter first before setting up the printer on a wireless network. For information on installing the wireless network adapter, see the setup sheet that came with the adapter.
- A Service Set Identifier (SSID) is a name assigned to a wireless network. Wired Equivalent Privacy (WEP), Wi-Fi Protected Access (WPA), and WPA2 are types of security used on a network.

### Preparing to set up the printer on an Ethernet network

To configure your printer to connect to an Ethernet network, organize the following information before you begin:

**Note:** If your network automatically assigns IP addresses to computers and printers, continue on to installing the printer.

- A valid, unique IP address for the printer to use on the network
- The network gateway
- The network mask
- A nickname for the printer (optional)

**Note:** A printer nickname can make it easier for you to identify your printer on the network. You can choose to use the default printer nickname, or assign a name that is easier for you to remember.

You will need an Ethernet cable to connect the printer to the network and an available port where the printer can physically connect to the network. Use a new network cable when possible to avoid potential problems caused by a damaged cable.

### Preparing to set up the printer on a wireless network

### Notes:

- Make sure your wireless network adapter is installed in your printer and working properly. For more information, see the instruction sheet that came with the wireless network adapter.
- Make sure your access point (wireless router) is turned on and is working properly.

Make sure you have the following information before setting up the printer on a wireless network:

- **SSID**—The SSID is also referred to as the network name.
- **Wireless Mode (or Network Mode)**—The mode is either infrastructure or ad hoc.

- **Channel (for ad hoc networks)**—The channel defaults to automatic for infrastructure networks.  
Some ad hoc networks will also require the automatic setting. Check with your system support person if you are not sure which channel to select.
- **Security Method**—There are four basic options for Security Method:
  - WEP key  
If your network uses more than one WEP key, then enter up to four in the provided spaces. Select the key currently in use on the network by selecting the default WEP transmit key.
  - WPA or WPA2 preshared key or passphrase  
WPA includes encryption as an additional layer of security. The choices are AES or TKIP. Encryption must be set for the same type on the router and on the printer, or the printer will not be able to communicate on the network.
  - 802.1X–RADIUS  
If you are installing the printer on an 802.1X network, then you may need the following:
    - Authentication type
    - Inner authentication type
    - 802.1X user name and password
    - Certificates
  - No security  
If your wireless network does not use any type of security, then you will not have any security information.  
**Note:** We do not recommend using an unsecured wireless network.

**Notes:**

- If you do not know the SSID of the network that your computer is connected to, then launch the wireless utility of the computer network adapter, and then look for the network name. If you cannot find the SSID or the security information for your network, then see the documentation that came with the access point, or contact your system support person.
- To find the WPA/WPA2 preshared key or passphrase for the wireless network, see the documentation that came with the access point, see the Embedded Web Server associated with the access point, or consult your system support person.

## Connecting the printer using the Wireless Setup Wizard

Before you begin, make sure that:

- A wireless network adapter is installed in the printer and is working properly. For more information, see the instruction sheet that came with the wireless network adapter.
- An Ethernet cable is disconnected from the printer.
- Active NIC is set to Auto. To set this to Auto, navigate to:



> **Network/Ports > Active NIC > Auto > Submit**

**Note:** Make sure to turn off the printer, then wait for at least five seconds, and then turn the printer back on.

1 From the printer control panel, navigate to:



> **Network/Ports** > **Network [x]** > **Network [x] Setup** > **Wireless** > **Wireless Connection Setup**

2 Select a wireless connection setup.

Use	To
<b>Search for networks</b>	Show available wireless connections. <b>Note:</b> This menu item shows all broadcast secured or unsecured SSIDs.
<b>Enter a network name</b>	Manually type the SSID. <b>Note:</b> Make sure to type the correct SSID.
<b>Wi-Fi Protected Setup</b>	Connect the printer to a wireless network using Wi-Fi Protected Setup.

3 Follow the instructions on the printer display.

## Connecting the printer to a wireless network using Wi-Fi Protected Setup

Before you begin, make sure that:

- The access point (wireless router) is Wi-Fi Protected Setup (WPS) certified or WPS-compatible. For more information, see the documentation that came with your access point.
- A wireless network adapter installed in your printer is attached and working properly. For more information, see the instruction sheet that came with the wireless network adapter.

### Using the Push Button Configuration method

1 From the printer control panel, navigate to:



> **Network/Ports** > **Network [x]** > **Network [x] Setup** > **Wireless** > **Wireless Connection Setup** > **Wi-Fi Protected Setup** > **Start Push Button Method**

2 Follow the instructions on the printer display.

### Using the Personal Identification Number (PIN) method

1 From the printer control panel, navigate to:



> **Network/Ports** > **Network [x]** > **Network [x] Setup** > **Wireless** > **Wireless Connection Setup** > **Wi-Fi Protected Setup** > **Start PIN Method**

2 Copy the eight-digit WPS PIN.

3 Open a Web browser, and then type the IP address of your access point in the address field.

#### Notes:

- The IP address appears as four sets of numbers separated by periods, such as 123.123.123.123.
- If you are using a proxy server, then temporarily disable it to load the Web page correctly.

4 Access the WPS settings. For more information, see the documentation that came with your access point.

5 Enter the eight-digit PIN, and then save the setting.



## Connecting the printer to a wireless network using the Embedded Web Server

Before you begin, make sure that:

- Your printer is connected temporarily to an Ethernet network.
- A wireless network adapter is installed in your printer and working properly. For more information, see the instruction sheet that came with the wireless network adapter.

**1** Open a Web browser, and then type the printer IP address in the address field.

**Notes:**

- View the printer IP address on the printer control panel. The IP address appears as four sets of numbers separated by periods, such as 123.123.123.123.
- If you are using a proxy server, then temporarily disable it to load the Web page correctly.

**2** Click **Settings > Network/Ports > Wireless**.

**3** Modify the settings to match the settings of your access point (wireless router).

**Note:** Make sure to enter the correct SSID, security method, preshared key or passphrase, network mode, and channel.

**4** Click **Submit**.

**5** Turn off the printer, and then disconnect the Ethernet cable. Then wait for at least five seconds, and then turn the printer back on.

**6** To verify if your printer is connected to the network, print a network setup page. Then in the Network Card [x] section, see if the status is Connected.

## Changing port settings after installing a new network ISP

**Notes:**

- If the printer has a static IP address, then you do not need to make any changes.
- If the computers are configured to use the network name, instead of an IP address, then you do not need to make any changes.
- If you are adding a wireless ISP to a printer previously configured for an Ethernet connection, then make sure the printer is disconnected from the Ethernet network.

### For Windows users

**1** Open the printers folder.

**2** From the shortcut menu of the printer with the new ISP, open the printer properties.

**3** Configure the port from the list.

**4** Update the IP address.

**5** Apply the changes.

### For Macintosh users

**1** From System Preferences in the Apple menu, navigate to the list of printers, and then select **+ > IP**.

**2** Type the IP address in the address field.

- 3 Apply the changes.

## Setting up serial printing (Windows only)

After installing the serial or communication (COM) port, configure the printer and the computer.

**Note:** Serial printing reduces print speed.

- 1 Set the parameters in the printer.
  - a From the control panel, navigate to the menu for the port settings.
  - b Locate the menu for the serial port settings, and then adjust the settings, if necessary.
  - c Save the settings.
- 2 From your computer, open the printers folder, and then select your printer.
- 3 Open the printer properties, and then select the COM port from the list.
- 4 Set the COM port parameters in Device Manager.

Use the Run dialog box to open the command prompt, and then type `devmgmt.msc`.

## Verifying printer setup

When all hardware and software options are installed and the printer is turned on, verify that the printer is set up correctly by printing the following:

- **Menu settings page**—Use this page to verify that all printer options are installed correctly. A list of installed options appears toward the bottom of the page. If an option you installed is not listed, then it is not installed correctly. Remove the option, and then install it again.
- **Network setup page**—If your printer has Ethernet or wireless capability and is attached to a network, then print a network setup page to verify the network connection. This page also provides important information that aids network printing configuration.

### Printing a menu settings page

From the home screen, navigate to:



> **Reports > Menu Settings Page**

### Printing a network setup page

If the printer is attached to a network, then print a network setup page to verify the network connection. This page also provides important information that aids network printing configuration.

- 1 From the home screen, navigate to:



> **Reports > Network Setup Page**

- 2 Check the first section of the network setup page, and confirm that the status is **Connected**.

If the status is **Not Connected**, then the LAN drop may not be active, or the network cable may be malfunctioning. Consult a system support person for a solution, and then print another network setup page.

## Loading paper and specialty media

The selection and handling of paper and specialty media can affect how reliably documents print. For more information, see [“Avoiding jams” on page 242](#) and [“Storing paper” on page 63](#).

### Setting the paper size and type

From the home screen navigate to:

 > **Paper Menu** > **Paper Size/Type** > select a tray > select the paper size or type > **Submit**

### Configuring Universal paper settings

The Universal paper size setting is a user-defined setting that lets you print on paper sizes that are not preset in the printer menus.

1 From the home screen, navigate to:

 > **Paper Menu** > **Universal Setup**

2 Select a unit of measure, and then set the portrait width and height.

3 Apply the changes.

### Loading trays

 **CAUTION—POTENTIAL INJURY:** To reduce the risk of equipment instability, load each tray separately. Keep all other trays closed until needed.

1 Pull out the tray.

**Note:** Do not remove trays while a job prints or while **Busy** appears on the printer display. Doing so may cause a jam.

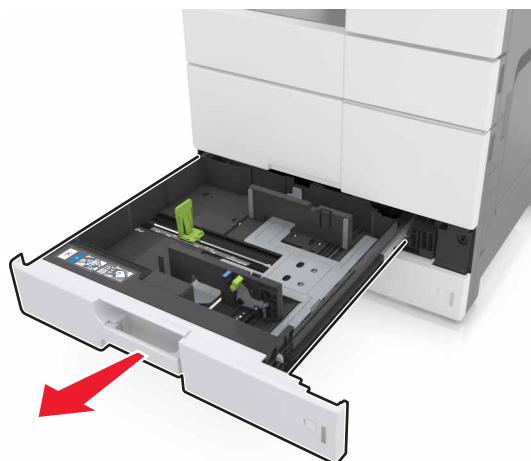

- 2 Squeeze and slide the paper guides to the correct position for the size of the paper you are loading.

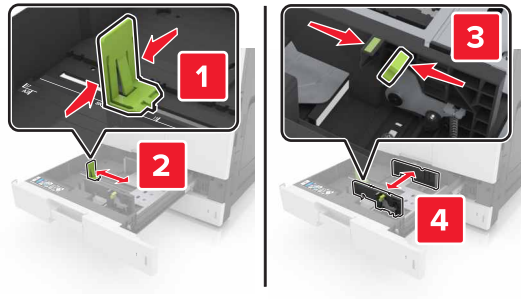

**Note:** Use the indicators on the bottom of the tray to position the guides.



- 3 Flex the sheets back and forth to loosen them, and then fan them. Do not fold or crease the paper. Straighten the edges on a level surface.

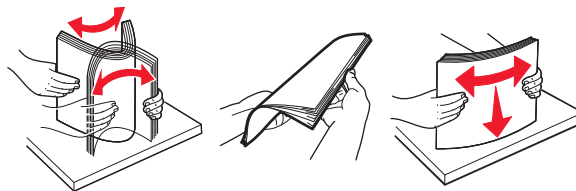

4 Load the paper stack with the printable side faceup.



**Notes:**

- Load printable side facedown for duplex printing.
- Load pre-punched paper with the holes toward the front or the left side of the tray.
- Load letterhead with the header on the left side of the tray.
- Make sure that the paper is below the maximum fill line on the edge of the paper tray. Overfilling may cause paper jams.

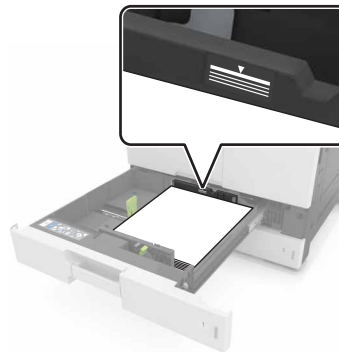

5 Insert the tray.

6 From the control panel, set the paper size and paper type in the Paper menu to match the paper loaded in the tray.

## Loading the multipurpose feeder

1 Open the multipurpose feeder.

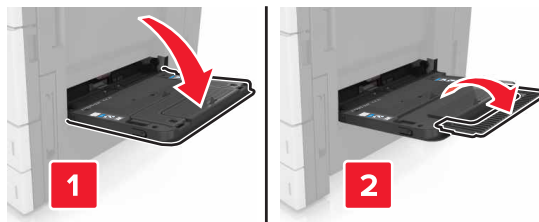

2 Adjust the guide to match the size of the paper you are loading.



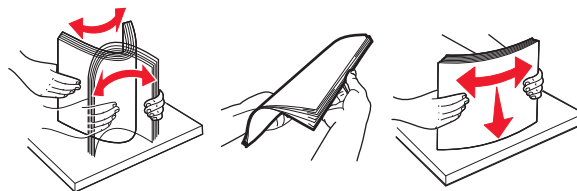

3 Flex the sheets of paper back and forth to loosen them, and then fan them. Do not fold or crease the paper. Straighten the edges on a level surface.





4 Load the paper.



- Load only one size and type of paper.

**Loading letterhead**

Without an optional finisher	With an optional finisher
<p>One-sided printing</p>  <p><b>Note:</b> For long-edge orientation, load letterhead facedown with the header on the left side of the feeder.</p>	<p>One-sided printing</p>  <p><b>Note:</b> For long-edge orientation, load letterhead facedown with the header on the right side of the feeder.</p>

Without an optional finisher	With an optional finisher
<p>Two-sided printing</p>  <p><b>Note:</b> For long-edge orientation, load letterhead faceup with the header on the right side of the feeder.</p>	<p>Two-sided printing</p>  <p><b>Note:</b> For long-edge orientation, load letterhead faceup with the header on the left side of the feeder.</p>

**Loading prepunched paper**

One-sided printing	Two-sided printing
	

- Load envelopes with the flap side up.

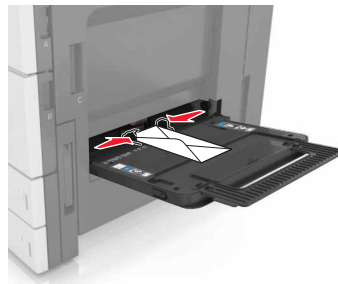

**Warning—Potential Damage:** Never use envelopes with stamps, clasps, snaps, windows, coated linings, or self-stick adhesives. These envelopes may severely damage the printer.

- Make sure that the paper is below the maximum fill line. Overfilling may cause paper jams.

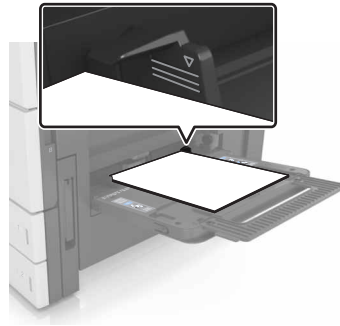

- 5 From the control panel, set the paper size and paper type in the Paper menu to match the paper loaded in the feeder.

## Linking and unlinking trays

The printer links trays when the specified paper size and type are the same. When a linked tray becomes empty, paper feeds from the next linked tray. To prevent trays from linking, assign a unique custom paper type name.

### Linking and unlinking trays

- 1 Open a Web browser, and then type the printer IP address in the address field.

**Notes:**

- View the printer IP address on the printer home screen. The IP address appears as four sets of numbers separated by periods, such as 123.123.123.123.
- If you are using a proxy server, then temporarily disable it to load the Web page correctly.

- 2 Click **Settings > Paper Menu**.

- 3 Change the paper size and type settings for the trays you are linking.

- To link trays, make sure the paper size and type for the tray match that of the other tray.
- To unlink trays, make sure the paper size or type for the tray does *not* match that of the other tray.

- 4 Click **Submit**.

**Note:** You can also change the paper size and type settings using the printer control panel. For more information, see [“Setting the paper size and type” on page 51](#).

**Warning—Potential Damage:** Paper loaded in the tray should match the paper type name assigned in the printer. The temperature of the fuser varies according to the specified paper type. Printing issues may occur if settings are not properly configured.



## Creating a custom name for a paper type

- 1 From the home screen, navigate to:



> **Paper Menu** > **Custom Names**

- 2 Type a custom paper type name, and then apply the changes.
- 3 Touch **Custom Types**, and then verify if the new custom paper type name has replaced the custom name.

## Assigning a custom paper type

### Using the Embedded Web Server

Assign a custom paper type name to a tray when linking or unlinking trays.

- 1 Open a Web browser, and then type the printer IP address in the address field.

#### Notes:

- View the printer IP address on the printer home screen. The IP address appears as four sets of numbers separated by periods, such as 123.123.123.123.
- If you are using a proxy server, then temporarily disable it to load the Web page correctly.

- 2 Click **Settings** > **Paper Menu** > **Custom Types**.
- 3 Select a custom paper type name, and then select a paper type.

**Note:** Paper is the factory default paper type for all user-defined custom names.

- 4 Click **Submit**.

### Using the printer control panel

- 1 From the home screen, navigate to:



> **Paper Menu** > **Custom Types**

- 2 Select a custom paper type name, and then select a paper type.

**Note:** Paper is the factory default paper type for all user-defined custom names.

- 3 Touch **Submit**.

# Paper and specialty media guide

## Notes:

- Make sure that the paper size, type, and weight are set correctly on the computer or control panel.
- Flex, fan, and straighten specialty media before loading them.
- The printer may print at a reduced speed to prevent damage to the fuser.
- For more information on card stock and labels, see the *Card Stock & Label Guide* on the Lexmark support Web site at <http://support.lexmark.com>.

## Using specialty media

### Tips on using card stock

Card stock is heavy, single-ply specialty media. Many of its variable characteristics, such as moisture content, thickness, and texture, can significantly affect print quality.

- From the printer control panel, set the paper size, type, texture, and weight in the Paper menu to match the card stock loaded in the tray.
- Print samples on the card stock being considered for use before buying large quantities.
- Specify the paper texture and weight from the tray settings to match the paper loaded in the tray.
- Preprinting, perforation, and creasing may significantly affect the print quality and cause jams or other paper feed problems.
- Before loading the card stock on the tray, flex and fan the card stock to loosen them. Straighten the edges on a level surface.

### Tips on using envelopes

- From the printer control panel, set the paper size, type, texture, and weight in the Paper menu to match the envelopes loaded in the tray.
- Print samples on the envelopes being considered for use before buying large quantities.
- Use envelopes designed specifically for laser printers.
- For best performance, use envelopes made from 90-g/m<sup>2</sup> (24-lb) paper or 25% cotton.
- Use only new envelopes from undamaged packages.
- To optimize performance and minimize jams, do not use envelopes that:
  - Have excessive curl or twist.
  - Are stuck together or damaged in any way.
  - Have windows, holes, perforations, cutouts, or embossing.
  - Have metal clasps, string ties, or folding bars.
  - Have an interlocking design.
  - Have postage stamps attached.
  - Have any exposed adhesive when the flap is in the sealed or closed position.

- Have bent corners.
- Have rough, cockle, or laid finishes.
- Adjust the width guides to fit the width of the envelopes.
- Before loading the envelopes on the tray, flex the stack of envelopes back and forth to loosen them, and then fan them. Straighten the edges on a level surface.

**Note:** A combination of high humidity (over 60%) and high printing temperature may wrinkle or seal envelopes.

## Tips on using labels

- From the printer control panel, set the paper size, type, texture, and weight in the Paper menu to match the labels loaded in the tray.
- Print samples on labels being considered for use before buying large quantities.
- For more information on label printing, characteristics, and design, see the *Card Stock & Label Guide* on the Lexmark Web site at <http://support.lexmark.com>.
- Use labels designed specifically for laser printers.
- Do not use labels with slick backing material.
- Do not use labels with exposed adhesive.
- Use full label sheets. Partial sheets may cause labels to peel off during printing, resulting in a jam. Partial sheets also contaminate the printer and the cartridge with adhesive, and could void the printer and toner cartridge warranties.
- Before loading labels on the tray, flex and fan labels to loosen them. Straighten the edges on a level surface.

## Tips on using letterhead

- Use letterhead specifically for laser printers.
- Print samples before buying large quantities.
- Before loading letterhead, flex and fan the sheets.
- When printing on letterhead, take note of the page orientation.

Source	Printing	Side with the letterhead	Paper orientation
Trays	One-sided	Faceup	Load the sheet with the top edge toward the back of the tray.
	Two-sided	Facedown	Load the sheet with the top edge toward the front of the tray.
Multipurpose feeder	One-sided	Facedown	Load the sheet with the top edge on the left side.
	Two-sided	Faceup	Load the sheet with the top edge on the right side.

## Tips on using transparencies

- From the printer control panel, set the paper size, type, texture, and weight in the Paper menu to match the transparencies loaded in the tray.
- Print a test page on the transparencies being considered for use before buying large quantities.
- Use transparencies designed specifically for laser printers.
- Avoid getting fingerprints on the transparencies to prevent print quality problems.
- Before loading transparencies, flex and fan the sheets to prevent them from sticking together.
- When printing on large volumes of transparencies, make sure to print by batches of only up to 20 with an interval of at least three minutes between batches, to prevent the transparencies from sticking together in the bin. You can also remove transparencies from the bin by batches of 20.

## Paper guidelines

### Paper characteristics

The following paper characteristics affect print quality and reliability. Consider these factors before printing on them:

#### Weight

The printer trays can feed paper weights between 60–256 g/m<sup>2</sup> (16–68-lb) grain long paper. The multipurpose feeder can feed paper weights between 60–256 g/m<sup>2</sup> (16–68-lb) grain long paper. Paper lighter than 60 g/m<sup>2</sup> (16 lb) might not be stiff enough to feed properly, and may cause jams.

**Note:** Two-sided printing is supported for 60–169 g/m<sup>2</sup> (16–45-lb) paper.

#### Curl

Curl is the tendency for paper to curl at its edges. Excessive curl can cause paper feeding problems. Curl can occur after the paper passes through the printer, where it is exposed to high temperatures. Storing paper unwrapped in hot, humid, cold, or dry conditions, even in the trays, can contribute to paper curling prior to printing and can cause feeding problems.

#### Smoothness

Paper smoothness directly affects print quality. If paper is too rough, toner cannot fuse to it properly. If paper is too smooth, it can cause paper feeding or print quality issues. Always use paper between 100 and 200 Sheffield points.

#### Moisture content

The amount of moisture in paper affects both print quality and the ability of the printer to feed the paper correctly. Leave paper in its original wrapper until it is time to use it. This limits the exposure of paper to moisture changes that can degrade its performance.

Store paper in its original wrapper in the same environment as the printer for 24 to 48 hours before printing. Extend the time several days if the storage or transportation environment is very different from the printer environment. Thick paper may also require a longer conditioning period.

## Grain direction

Grain refers to the alignment of the paper fibers in a sheet of paper. Grain is either *grain long*, running the length of the paper, or *grain short*, running the width of the paper.

For 60–256 g/m<sup>2</sup> (16–68-lb) paper, grain long paper is recommended.

## Fiber content

Most high-quality xerographic paper is made from 100% chemically treated pulped wood. This content provides the paper with a high degree of stability, resulting in fewer paper feeding problems and better print quality. Paper containing fibers such as cotton can negatively affect paper handling.

## Selecting paper

Using the appropriate paper prevents jams and helps ensure trouble-free printing.

To help avoid paper jams and poor print quality:

- *Always* use new, undamaged paper.
- Before loading paper, know the recommended printable side of the paper. This information is usually indicated on the paper package.
- *Do not* use paper that has been cut or trimmed by hand.
- *Do not* mix paper sizes, types, or weights in the same tray; mixing results in jams.
- *Do not* use coated papers unless they are specifically designed for electrophotographic printing.

## Selecting preprinted forms and letterhead

- Use grain long for 60–256-g/m<sup>2</sup> (16–68-lb) paper.
- Use only forms and letterhead printed using an offset lithographic or engraved printing process.
- Avoid paper with rough or heavily textured surfaces.
- Use inks that are not affected by the resin in toner. Inks that are oxidation-set or oil-based generally meet these requirements; latex inks might not.
- Print samples on preprinted forms and letterheads considered for use before buying large quantities. This determines whether or not the ink in the preprinted form or letterhead will affect print quality.
- When in doubt, contact your paper supplier.

## Using recycled paper and other office papers

As an environmentally conscientious company, Lexmark supports the use of recycled paper produced specifically for use in laser (electrophotographic) printers.

While no blanket statement can be made that all recycled paper will feed well, Lexmark consistently tests papers that represent recycled cut size copier papers available on the global market. This scientific testing is conducted with rigor and discipline. Many factors are taken into consideration both separately and as a whole, including the following:

- Amount of post-consumer waste (Lexmark tests up to 100% post-consumer waste content.)
- Temperature and humidity conditions (Testing chambers simulate climates from all over the world.)
- Moisture content (Business papers should have low moisture: 4–5%.)
- Bending resistance and proper stiffness means optimum feeding through the printer.

- Thickness (impacts how much can be loaded into a tray)
- Surface roughness (measured in Sheffield units, impacts print clarity and how well toner fuses to the paper)
- Surface friction (determines how easily sheets can be separated)
- Grain and formation (impacts curling, which also influences the mechanics of how the paper behaves as it moves through the printer)
- Brightness and texture (look and feel)

Recycled papers are better than ever; however, the amount of recycled content in a paper affects the degree of control over foreign matter. And while recycled papers are one good path to printing in an environmentally responsible manner, they are not perfect. The energy required to de-ink and deal with additives such as colorants and “glue” often generates more carbon emissions than does normal paper production. However, using recycled papers enables better resource management overall.

Lexmark concerns itself with the responsible use of paper in general based on life cycle assessments of its products. To gain a better understanding of the impact of printers on the environment, the company commissioned a number of life cycle assessments and found that paper was identified as the primary contributor (up to 80%) of carbon emissions caused throughout the entire life of a device (from design to end-of-life). This is due to the energy-intensive manufacturing processes required to make paper.

Thus, Lexmark seeks to educate customers and partners on minimizing the impact of paper. Using recycled paper is one way. Eliminating excessive and unnecessary paper consumption is another. Lexmark is well-equipped to help customers minimize printing and copying waste. In addition, the company encourages purchasing paper from suppliers who demonstrate their commitment to sustainable forestry practices.

Lexmark does not endorse specific suppliers, although a converter’s product list for special applications is maintained. However, the following paper choice guidelines will help alleviate the environmental impact of printing:

- 1 Minimize paper consumption.
- 2 Be selective about the origin of wood fiber. Buy from suppliers who carry certifications such as the Forestry Stewardship Council (FSC) or the Program for the Endorsement of Forest Certification (PEFC). These certifications guarantee that the paper manufacturer uses wood pulp from forestry operators that employ environmentally and socially responsible forest management and restoration practices.
- 3 Choose the most appropriate paper for printing needs: normal 75 or 80 g/m<sup>2</sup> certified paper, lower weight paper, or recycled paper.

## Unacceptable paper examples

Test results indicate that the following paper types are at risk for use with laser printers:

- Chemically treated papers used to make copies without carbon paper, also known as *carbonless papers*
- Preprinted papers with chemicals that may contaminate the printer
- Preprinted papers that can be affected by the temperature in the printer fuser
- Preprinted papers that require a registration (the precise location on the page) greater than  $\pm 2.3$  mm ( $\pm 0.9$  in.), such as optical character recognition (OCR) forms. In some cases, registration can be adjusted with a software application to successfully print on these forms.)
- Coated papers (erasable bond), synthetic papers, thermal papers
- Rough-edged, rough or heavily textured surface papers or curled papers
- Recycled papers that fail EN12281:2002 (European testing)
- Paper weighing less than 60 g/m<sup>2</sup> (16 lb)
- Multiple part forms or documents

For more information about Lexmark, visit [www.lexmark.com](http://www.lexmark.com). General sustainability-related information can be found at the **Environmental Sustainability** link.

## Storing paper

Use these paper storage guidelines to help avoid jams and uneven print quality:

- For best results, store paper where the temperature is 21°C (70°F) and the relative humidity is 40 percent. Most label manufacturers recommend printing in a temperature range of 18–24°C (65–75°F) with relative humidity between 40 and 60 percent.
- Store paper in cartons, on a pallet or shelf, rather than on the floor.
- Store individual packages on a flat surface.
- Do not store anything on top of individual paper packages.
- Take paper out of the carton or wrapper only when you are ready to load it in the printer. The carton and wrapper help keep the paper clean, dry, and flat.

## Supported paper sizes, types, and weights

The following tables provide information on standard and optional paper sources and the sizes, types, and weights of paper they support.

**Note:** For an unlisted paper size, select the closest *larger* listed size.

### Paper sizes supported by the printer

#### Paper sizes supported by the trays and multipurpose feeder

Paper size	Dimensions	Standard 500-sheet tray (Tray 1)	Standard 500-sheet tray (Tray 2)	2 x 500-sheet tray	2500-sheet tray	3000-sheet tray	Multipurpose feeder <sup>3</sup>	Two-sided printing
A4	210 x 297 mm (8.3 x 11.7 in.)	✓	✓	✓	✓ <sup>2</sup>	✓ <sup>2</sup>	✓ <sup>2</sup>	✓
A5	148 x 210 mm (5.8 x 8.3 in.)	✓ <sup>1</sup>	✓ <sup>1</sup>	✓ <sup>1</sup>	X	X	✓	✓
A6	105 x 148 mm (4.1 x 5.8 in.)	X	X	X	X	X	✓ <sup>1</sup>	✓
JIS B5	182 x 257 mm (7.2 x 10.1 in.)	✓	✓	✓	X	X	✓	✓

<sup>1</sup> Supported only in short-edge orientation.

<sup>2</sup> Supported only in long-edge orientation.

<sup>3</sup> Supports paper size without *size sensing*.

<sup>4</sup> Supported only if the width is from 139.7 mm (5.5 in.) to 320 mm (12.6 in.), and the length is from 148 mm (5.83 in.) to 458 mm (18 in.).

**Note:** Banner is supported in the multipurpose feeder only if the width is up to 296.9 mm (11.69 in.), and the length is up to 1219.2 mm (48 in.). Set the paper size to Universal.

Paper size	Dimensions	Standard 500-sheet tray (Tray 1)	Standard 500-sheet tray (Tray 2)	2 x 500-sheet tray	2500-sheet tray	3000-sheet tray	Multipurpose feeder <sup>3</sup>	Two-sided printing
<b>Letter</b>	216 x 279 mm (8.5 x 11 in.)	✓	✓	✓	✓ <sup>2</sup>	✓ <sup>2</sup>	✓	✓
<b>Legal</b>	216 x 356 mm (8.5 x 14 in.)	✓	✓	✓	✗	✗	✓	✓
<b>Executive</b>	184 x 267 mm (7.3 x 10.5 in.)	✓	✓	✓	✗	✗	✓	✓
<b>JIS B4</b>	257 x 364 mm (10.12 x 14.33 in.)	✓	✓	✓	✗	✗	✓	✓
<b>SRA3</b>	320 x 450 mm (12.6 x 17.7 in.)	✗	✓ <sup>1</sup>	✗	✗	✗	✓ <sup>1</sup>	✓
<b>A3</b>	297 x 420 mm (11.69 x 16.54 in.)	✓	✓	✓	✗	✗	✓	✓
<b>12 x 18</b>	305 x 457 mm (12 x 18 in.)	✗	✓ <sup>1</sup>	✗	✗	✗	✓ <sup>1</sup>	✓
<b>11 x 17</b>	279.4 x 431.8 mm (11 x 17 in.)	✓	✓	✓	✗	✗	✓	✓
<b>Oficio</b>	216 x 340 mm (8.5 x 13.4 in.)	✓	✓	✓	✗	✗	✓	✓
<b>Folio</b>	216 x 330 mm (8.5 x 13 in.)	✓	✓	✓	✗	✗	✓	✓
<b>Statement</b>	140 x 216 mm (5.5 x 8.5 in.)	✓ <sup>1</sup>	✓ <sup>1</sup>	✓ <sup>1</sup>	✗	✗	✓	✓
<b>Universal</b>	76.2 x 76.2 mm (3 x 3 in.) to 320 x 1219.2 mm (12.6 x 48 in.)	✓	✓	✓	✗	✗	✓	✓ <sup>4</sup>
<b>7 3/4 Envelope</b>	98 x 191 mm (3.9 x 7.5 in.)	✗	✗	✗	✗	✗	✓	✗
<b>9 Envelope</b>	98 x 225 mm (3.9 x 8.9 in.)	✗	✗	✗	✗	✗	✓	✗
<b>10 Envelope</b>	105 x 241 mm (4.1 x 9.5 in.)	✗	✗	✗	✗	✗	✓	✗

<sup>1</sup> Supported only in short-edge orientation.

<sup>2</sup> Supported only in long-edge orientation.

<sup>3</sup> Supports paper size without *size sensing*.

<sup>4</sup> Supported only if the width is from 139.7 mm (5.5 in.) to 320 mm (12.6 in.), and the length is from 148 mm (5.83 in.) to 458 mm (18 in.).

**Note:** Banner is supported in the multipurpose feeder only if the width is up to 296.9 mm (11.69 in.), and the length is up to 1219.2 mm (48 in.). Set the paper size to Universal.



Paper size	Dimensions	Standard 500-sheet tray (Tray 1)	Standard 500-sheet tray (Tray 2)	2 x 500-sheet tray	2500-sheet tray	3000-sheet tray	Multipurpose feeder <sup>3</sup>	Two-sided printing
<b>DL Envelope</b>	110 x 220 mm (4.3 x 8.7 in.)	X	X	X	X	X	✓	X
<b>C5 Envelope</b>	162 x 229 mm (6.4 x 9 in.)	X	X	X	X	X	✓	X
<b>B5 Envelope</b>	176 x 250 mm (6.9 x 9.8 in.)	X	X	X	X	X	✓	X
<b>Other Envelope</b>	98 x 162 mm (3.9 x 6.3 in.) to 176 x 250 mm (6.9 x 9.8 in.)	X	X	X	X	X	✓	X

<sup>1</sup> Supported only in short-edge orientation.

<sup>2</sup> Supported only in long-edge orientation.

<sup>3</sup> Supports paper size without *size sensing*.

<sup>4</sup> Supported only if the width is from 139.7 mm (5.5 in.) to 320 mm (12.6 in.), and the length is from 148 mm (5.83 in.) to 458 mm (18 in.).

**Note:** Banner is supported in the multipurpose feeder only if the width is up to 296.9 mm (11.69 in.), and the length is up to 1219.2 mm (48 in.). Set the paper size to Universal.

### Paper sizes supported by the ADF and scanner glass

Paper size	Dimensions	ADF	Scanner glass
<b>Business card</b>		X	✓ <sup>1,2</sup>
<b>3 x 5</b>	76.2 x 127 mm (3 x 5 in.)	X	✓ <sup>1,2</sup>
<b>4 x 6</b>	101.6 x 152.4 mm (4 x 6 in.)	✓ <sup>2</sup>	✓ <sup>1,2</sup>
<b>A4</b>	210 x 297 mm (8.3 x 11.7 in.)	✓	✓
<b>A5</b>	148 x 210 mm (5.8 x 8.3 in.)	✓	✓ <sup>2</sup>
<b>A6</b>	105 x 148 mm (4.1 x 5.8 in.)	✓ <sup>1,2</sup>	✓ <sup>1,2</sup>
<b>JIS B5</b>	182 x 257 mm (7.2 x 10.1 in.)	✓	✓
<b>Letter</b>	216 x 279 mm (8.5 x 11 in.)	✓	✓
<b>Legal</b>	216 x 356 mm (8.5 x 14 in.)	✓	✓
<b>Executive</b>	184 x 267 mm (7.3 x 10.5 in.)	✓	✓
<b>JIS B4</b>	257 x 364 mm (10.12 x 14.33 in.)	✓	✓
<b>SRA3</b>	320 x 450 mm (12.6 x 17.7 in.)	X	X

<sup>1</sup> Supported only in short-edge orientation.

<sup>2</sup> Supports paper size without *size sensing*.

Paper size	Dimensions	ADF	Scanner glass
<b>A3</b>	297 x 420 mm (11.69 x 16.54 in.)	✓	✓
<b>12 x 18</b>	305 x 457 mm (12 x 18 in.)	X	X
<b>11 x 17</b>	279.4 x 431.8 mm (11 x 17 in.)	✓	✓
<b>Oficio</b>	216 x 340 mm (8.5 x 13.4 in.)	✓ <sup>2</sup>	✓ <sup>2</sup>
<b>Folio</b>	216 x 330 mm (8.5 x 13 in.)	✓	✓
<b>Statement</b>	140 x 216 mm (5.5 x 8.5 in.)	✓	✓
<b>Universal</b>	89 x 98.4 mm (3.50 x 3.87 in.) to 297 x 431.8 mm (11.69 x 17.00 in.)	✓ <sup>2</sup>	✓ <sup>2</sup>
<b>7 3/4 Envelope</b>	98 x 191 mm (3.9 x 7.5 in.)	X	X
<b>9 Envelope</b>	98 x 225 mm (3.9 x 8.9 in.)	X	X
<b>10 Envelope</b>	105 x 241 mm (4.1 x 9.5 in.)	X	X
<b>DL Envelope</b>	110 x 220 mm (4.3 x 8.7 in.)	X	X
<b>C5 Envelope</b>	162 x 229 mm (6.4 x 9 in.)	X	X
<b>B5 Envelope</b>	176 x 250 mm (6.9 x 9.8 in.)	X	X
<b>Other Envelope</b>	98 x 162 mm (3.9 x 6.3 in.) to 176 x 250 mm (6.9 x 9.8 in.)	X	X
<b>Custom Scan Size [x]</b>		✓ <sup>2</sup>	✓ <sup>2</sup>

<sup>1</sup> Supported only in short-edge orientation.

<sup>2</sup> Supports paper size without *size sensing*.

## Paper types and weights supported by the printer

The printer engine supports 60–256-g/m<sup>2</sup> (16–68-lb) paper weights.

**Note:** Labels, transparencies, envelopes, and card stock always print at reduced speed.

Paper type	Standard 500-sheet tray (Tray 1)	Standard 500-sheet tray (Tray 2)	2 x 500-sheet tray	2500-sheet tray	3000-sheet tray	Multipurpose feeder	ADF	Scanner
<b>Plain Paper<sup>1</sup></b>	✓	✓	✓	✓	✓	✓	✓	✓
<b>Card Stock<sup>1</sup></b>	✓	✓	✓	✓	✓	✓	✓	✓
<b>Transparencies<sup>2</sup></b>	X	X	X	X	X	✓	✓	✓
<b>Recycled<sup>1</sup></b>	✓	✓	✓	✓	✓	✓	✓	✓

<sup>1</sup> Paper is supported for two-sided printing.

<sup>2</sup> Print transparencies in batches of only up to 20 to prevent them from sticking together. For more information, see [“Tips on using transparencies” on page 60](#).

Paper type	Standard 500-sheet tray (Tray 1)	Standard 500-sheet tray (Tray 2)	2 x 500-sheet tray	2500-sheet tray	3000-sheet tray	Multipurpose feeder	ADF	Scanner
Glossy <sup>1</sup>	✓	✓	✓	✓	✓	✓	✓	✓
Heavy Glossy <sup>1</sup>	✓	✓	✓	✓	✓	✓	✓	✓
Labels	X	X	X	X	X	✓	✓	✓
Vinyl Labels	X	X	X	X	X	X	✓	✓
Bond <sup>1</sup>	✓	✓	✓	✓	✓	✓	✓	✓
Envelope	X	X	X	X	X	✓	✓	✓
Rough Envelope	X	X	X	X	X	✓	✓	✓
Letterhead <sup>1</sup>	✓	✓	✓	✓	✓	✓	✓	✓
Preprinted <sup>1</sup>	✓	✓	✓	✓	✓	✓	✓	✓
Colored Paper <sup>1</sup>	✓	✓	✓	✓	✓	✓	✓	✓
Light Paper <sup>1</sup>	✓	✓	✓	✓	✓	✓	✓	✓
Heavy Paper <sup>1</sup>	✓	✓	✓	✓	✓	✓	✓	✓
Rough Cotton <sup>1</sup>	✓	✓	✓	✓	✓	✓	✓	✓
Custom Type <sup>1</sup>	✓	✓	✓	✓	✓	✓	✓	✓

<sup>1</sup> Paper is supported for two-sided printing.

<sup>2</sup> Print transparencies in batches of only up to 20 to prevent them from sticking together. For more information, see [“Tips on using transparencies”](#) on page 60.

## Paper sizes, types, and weights supported by the finishers

The printer engine supports 60–256 g/m<sup>2</sup> (16–68-lb) paper weights.

**Note:** When a finisher is installed, the standard finisher bin becomes the default bin even for print jobs that do not require finishing.

## Supported paper sizes

Paper size	Staple finisher	Staple, hole punch finisher bin 1	Staple, hole punch finisher bin 2	Booklet finisher
A6	√ <sup>3</sup>	√ <sup>3</sup>	X	X
A5	√ <sup>3</sup>	√ <sup>3</sup>	√ <sup>2</sup>	X
JIS B5	√	√	√	X
JIS B4	√	√	√	√
Executive	√	√	√	X
Letter	√	√	√	√
A4	√	√	√	√
Legal	√	√ <sup>4</sup>	√	√
12 x 18	√ <sup>1</sup>	√ <sup>3</sup>	√ <sup>1</sup>	√
11 x 17	√	√	√	√
SRA3	√ <sup>1</sup>	√ <sup>3</sup>	√ <sup>1</sup>	√
A3	√	√	√	√
Oficio	√ <sup>1</sup>	√ <sup>3</sup>	√ <sup>3</sup>	X
Folio	√ <sup>1</sup>	√ <sup>3</sup>	√ <sup>3</sup>	X
Statement	√ <sup>1</sup>	√ <sup>3</sup>	√ <sup>3</sup>	X
Universal	√	√ <sup>3</sup>	√ <sup>1</sup>	√ <sup>5</sup>

<sup>1</sup> Paper is supported only if the finisher stacks the paper but does not staple or punch holes in it.

<sup>2</sup> Paper is supported only if the finisher stacks or staples the paper but does not punch holes in it.

<sup>3</sup> Paper is supported but the finisher does not stack, staple, or punch holes in it.

<sup>4</sup> Paper is supported only for 2-hole punch.

<sup>5</sup> Paper is supported only if the paper size is between 210 x 279.4 mm (8.27 x 11 in.) and 320 x 457.2 mm (12.6 x 18 in.).

## Supported paper types

Paper type	Staple finisher	Staple, hole punch finisher	Booklet finisher
Plain Paper	√	√	√ <sup>5</sup>

<sup>1</sup> Print on transparencies by batches of only up to 20 to prevent them from sticking together. For more information, see [“Tips on using transparencies” on page 60.](#)

<sup>2</sup> Paper is supported only if the finisher stacks the paper but does not staple it.

<sup>3</sup> Paper is supported only if the finisher stacks the paper but does not staple or punch holes in it.

<sup>4</sup> Paper is supported only if the finisher punches holes or stacks the paper but does not staple it.

<sup>5</sup> Paper is supported only if the finisher staples or folds the paper.

Paper type	Staple finisher	Staple, hole punch finisher	Booklet finisher
Card Stock	√ <sup>2</sup>	√	X
Transparency <sup>1</sup>	√ <sup>2</sup>	√ <sup>3</sup>	X
Recycled	√ <sup>2</sup>	√	√ <sup>5</sup>
Glossy	√ <sup>2</sup>	√	√ <sup>5</sup>
Heavy Glossy	√ <sup>2</sup>	√ <sup>4</sup>	X
Labels	√ <sup>2</sup>	√ <sup>3</sup>	X
Bond	√	√	√ <sup>5</sup>
Envelope	√ <sup>2</sup>	√ <sup>3</sup>	X
Rough Envelope	√ <sup>2</sup>	√ <sup>3</sup>	X
Letterhead	√	√	√ <sup>5</sup>
Preprinted	√	√	√ <sup>5</sup>
Colored Paper	√	√	√ <sup>5</sup>
Light Paper	√	√	√ <sup>5</sup>
Heavy Paper	√ <sup>2</sup>	√ <sup>4</sup>	X
Rough Cotton	√ <sup>2</sup>	√	X
Custom Type	√	√	√ <sup>5</sup>

<sup>1</sup> Print on transparencies by batches of only up to 20 to prevent them from sticking together. For more information, see [“Tips on using transparencies” on page 60.](#)

<sup>2</sup> Paper is supported only if the finisher stacks the paper but does not staple it.

<sup>3</sup> Paper is supported only if the finisher stacks the paper but does not staple or punch holes in it.

<sup>4</sup> Paper is supported only if the finisher punches holes or stacks the paper but does not staple it.

<sup>5</sup> Paper is supported only if the finisher staples or folds the paper.

# Printing

## Printing forms and a document

### Printing forms

Use Forms and Favorites to quickly and easily access frequently used forms or other information that is regularly printed. Before you can use this application, first set it up on the printer. For more information, see [“Setting up Forms and Favorites” on page 22](#).

- 1 From the home screen, navigate to:  
**Forms and Favorites** > select the form from the list > enter the number of copies > adjust other settings
- 2 Apply the changes.

### Printing a document

- 1 From the printer control panel, set the paper type and size to match the paper loaded.
- 2 Send the print job:

#### For Windows users

- a With a document open, click **File > Print**.
- b Click **Properties, Preferences, Options, or Setup**.
- c Adjust the settings, if necessary.
- d Click **OK > Print**.

#### For Macintosh users

- a Customize the settings in the Page Setup dialog:
  - 1 With a document open, choose **File > Page Setup**.
  - 2 Choose a paper size or create a custom size to match the paper loaded.
  - 3 Click **OK**.
- b Customize the settings in the Print dialog:
  - 1 With a document open, choose **File > Print**.  
If necessary, click the disclosure triangle to see more options.
  - 2 From the print options pop-up menus, adjust the settings, if necessary.

**Note:** To print on a specific paper type, adjust the paper type setting to match the paper loaded, or select the appropriate tray or feeder.

- 3 Click **Print**.

## Adjusting toner darkness

1 From the home screen, navigate to:

 > **Settings** > **Print Settings** > **Quality Menu**

2 Adjust the toner darkness setting, and then save the changes.

## Printing from a flash drive or mobile device

### Printing from a flash drive

#### Notes:

- Before printing an encrypted PDF file, you are prompted to type the file password from the control panel.
- You cannot print files for which you do not have printing permissions.

1 Insert a flash drive into the USB port.

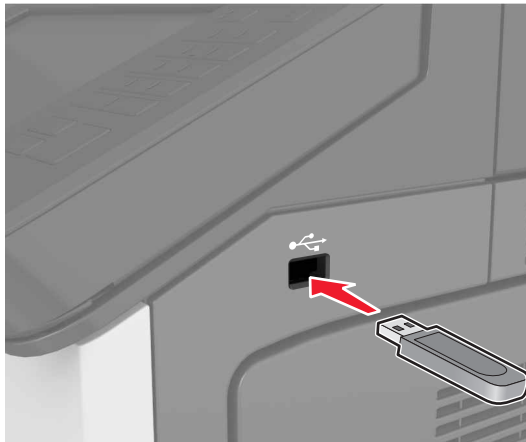

#### Notes:

- A flash drive icon appears on the printer home screen when a flash drive is inserted.
- If you insert the flash drive when the printer requires attention, such as when a jam has occurred, then the printer ignores the flash drive.
- If you insert the flash drive while the printer is processing other print jobs, then **Busy** appears on the printer display. After these print jobs are processed, you may need to view the held jobs list to print documents from the flash drive.

**Warning—Potential Damage:** Do not touch the printer or the flash drive in the area shown while actively printing, reading, or writing from the memory device. Loss of data or a malfunction can occur.



- 2 From the control panel, touch the document you want to print.
- 3 Specify the number of copies to be printed, and then send the job for printing.

**Notes:**

- Do not remove the flash drive from the USB port until the document has finished printing.
- If you leave the flash drive in the printer after leaving the initial USB menu screen, then touch **Held Jobs** on the home screen to print files from the flash drive.

## Supported flash drives and file types

**Notes:**

- High-speed USB flash drives must support the full-speed standard. Low-speed USB devices are not supported.
- USB flash drives must support the File Allocation Table (FAT) system. Devices formatted with New Technology File System (NTFS) or any other file system are not supported.

Recommended flash drives	File type
<ul style="list-style-type: none"> <li>• Lexar FireFly (512MB and 1GB)</li> <li>• SanDisk Cruzer Micro (512MB and 1GB)</li> <li>• Sony (512MB and 1GB)</li> </ul>	<p>Documents:</p> <ul style="list-style-type: none"> <li>• .pdf</li> <li>• .xps</li> </ul> <p>Images:</p> <ul style="list-style-type: none"> <li>• .dcx</li> <li>• .gif</li> <li>• .jpeg or .jpg</li> <li>• .bmp</li> <li>• .pcx</li> <li>• .tiff or .tif</li> <li>• .png</li> </ul>

## Printing from a mobile device

To download a compatible mobile printing application, visit [www.lexmark.com/mobile](http://www.lexmark.com/mobile).



**Note:** Mobile printing applications may also be available from your mobile device manufacturer.

## Printing confidential and other held jobs

### Storing print jobs in the printer

1 From the printer control panel, navigate to:

 > **Security** > **Confidential Print** > select the print job type

Use	To
Max Invalid PIN	Limit the number of times an invalid PIN can be entered. <b>Note:</b> When the limit is reached, the print jobs for that user name and PIN are deleted.
Confidential Job Expiration	Hold print jobs in the computer until you enter the PIN from the printer control panel. <b>Note:</b> The PIN is set from the computer. It must be four digits, using the numbers 1–9.
Repeat Job Expiration	Print and store print jobs in the printer memory.
Verify Job Expiration	Print one copy of a print job and hold the remaining copies. It allows you to examine if the first copy is satisfactory. The print job is automatically deleted from the printer memory when all copies are printed.
Reserve Job Expiration	Store print jobs for printing at a later time. <b>Note:</b> The print jobs are held until deleted from the Held Jobs menu.
<p><b>Notes:</b></p> <ul style="list-style-type: none"> <li>• Confidential, Verify, Reserve, and Repeat print jobs may be deleted if the printer requires extra memory to process additional held jobs.</li> <li>• You can set the printer to store print jobs in the printer memory until you start the print job from the printer control panel.</li> <li>• All print jobs that can be initiated by the user at the printer are called <i>held jobs</i>.</li> </ul>	

2 Touch **Submit**.

## Printing confidential and other held jobs

**Notes:**

- Confidential and Verify print jobs are automatically deleted from memory after printing. Repeat and Reserve jobs are *held* in the printer until you delete them.
- Confidential print jobs require a four-digit PIN.

**For Windows users**

- 1 With a document open, select **File** > **Print**.
- 2 Open the printer properties, and then select **Print and Hold**.

- 3 Select the print job type, and then assign a user name.
- 4 Send the print job to the printer.
- 5 From the printer home screen, open the Held Jobs folder and then release the job.

#### For Macintosh users

- 1 With a document open, select **File > Print**.
- 2 From the print options or Copies & Pages pop-up menu, select **Job Routing**.
- 3 Select the print job type, and then assign a user name.
- 4 Send the print job to the printer.
- 5 From the printer home screen, open the Held Jobs folder and then release the job.

## Modifying confidential print settings

**Note:** This feature is available only in network printers or printers connected to print servers.

- 1 Open a Web browser, and then type the printer IP address in the address field.

#### Notes:

- View the printer IP address in the TCP/IP section in the Network/Ports menu. The IP address appears as four sets of numbers separated by periods, such as 123.123.123.123.
- If you are using a proxy server, then temporarily disable it to load the Web page correctly.

- 2 Click **Settings** tab > **Security** > **Confidential Print Setup**.
- 3 Modify the settings:
  - Set a maximum number of PIN entry attempts. When a user exceeds a specific number of PIN entry attempts, all of the jobs for that user are deleted.
  - Set an expiration time for confidential print jobs. When a user has not printed the jobs within the specified time, all of the jobs for that user are deleted.
- 4 Save the modified settings.

## Printing information pages

For more information on printing information pages, see [“Printing a menu settings page” on page 50](#) and [“Printing a network setup page” on page 50](#).

### Printing a font sample list

- 1 From the home screen, navigate to:



> **Reports** > **Print Fonts**

- 2 Touch **PCL Fonts** or **PostScript Fonts**.

## Printing a directory list

A directory list shows the resources stored in a flash memory or in the printer hard disk.

From the home screen, navigate to:



> **Reports** > **Print Directory**

## Canceling a print job

### Canceling a print job from the printer control panel

- 1 From the printer control panel, touch **Cancel Job** or press  on the keypad.
- 2 Touch the print job you want to cancel, and then touch **Delete Selected Jobs**.

**Note:** If you press  on the keypad, then touch **Resume** to return to the home screen.

### Canceling a print job from the computer

#### For Windows users

- 1 Open the printers folder.

##### In Windows 8

From the Search charm, type `run`, and then navigate to:

`Run > type control printers > OK`



##### In Windows 7 or earlier

- a Click , or click **Start** and then click **Run**.
  - b Type `control printers`.
  - c Press **Enter**, or click **OK**.
- 2 Double-click the printer icon.
  - 3 Select the print job you want to cancel.
  - 4 Click **Delete**.

#### For Macintosh users

- 1 From System Preferences in the Apple menu, open the printers folder.
- 2 Open the print queue, select the print job you want to cancel, and then delete it.

# Copying

Automatic document feeder (ADF)	Scanner glass
 <ul style="list-style-type: none"> <li>• Use the ADF for multiple-page or two-sided documents.</li> <li>• Load the original document faceup.</li> </ul>	 <ul style="list-style-type: none"> <li>• Use the scanner glass for single-page documents, book pages, small items (such as postcards or photos), transparencies, photo paper, or thin media (such as magazine clippings).</li> <li>• Place the document facedown in the corner with the arrow.</li> </ul>

## Making copies

### Copying using the ADF or scanner glass

- 1 Load an original document into the ADF tray or on the scanner glass.

**Note:** To avoid a cropped image, make sure the size of the original document and the size of the copy paper are the same.

- 2 From the home screen, navigate to:

**Copy** > specify the copy settings > **Copy It**

**Note:** To make a quick copy, from the control panel, press .

### Copying photos





- 1 Place a photo on the scanner glass.
- 2 From the home screen, navigate to:

**Copy** > **Content** > **Photo** > 

- 3 From the Content Source menu, select the setting that best matches the original photo.



- 4 Touch  > **Copy It**.

## Copying on transparencies or letterhead

- 1 Load an original document into the ADF tray or on the scanner glass.
- 2 From the home screen, navigate to:  
**Copy > Copy from** > select the size of the original document >   
**3** Touch **Copy to**, and then select the tray that contains the specialty media.  
If you are loading the specialty media into the multipurpose feeder, then navigate to:  
**Multipurpose Feeder** >  > select the size of the specialty media >  > **Transparency or Letterhead**
- 4 Touch  > **Copy It**.

## Creating a copy shortcut

### Notes:

- Make sure that Copy Shortcuts is set to Display. From the home screen, touch  > **Settings > General Settings > Home screen customization > Copy Shortcuts > Display > Submit**.
- To delete a copy shortcut, touch  > **Manage Shortcuts > Copy Shortcuts** > the shortcut to delete > **Delete now**.

## Creating a copy shortcut using the printer control panel



- 1 From the home screen, touch **Copy**.
- 2 Adjust the copy settings, and then touch **Save as Shortcut**.  
**Note:** If you change the settings after the copy shortcut has been created, then the settings are not saved.
- 3 Type a unique name for the shortcut, and then touch **Done**.
- 4 Verify that the shortcut name is correct, and then touch **OK**.  
If the shortcut name is incorrect, then touch **Cancel**, and then reenter the information.

### Notes:



- The shortcut name appears in the Copy Shortcuts icon on the printer home screen.
- You can use the shortcut when copying another document using the same settings.

## Customizing copy settings

### Copying to a different size



- 1 Load an original document into the ADF tray or on the scanner glass.
- 2 From the home screen, navigate to:  
**Copy > Copy from** > select the size of the original document > 
- 3 Touch **Copy to**, and then select a new size for the copy.
- 4 Touch  > **Copy It**.

### Making copies using paper from a selected tray



- 1 Load an original document into the ADF tray or on the scanner glass.
- 2 From the home screen, navigate to:  
**Copy > Copy from** > select the size of the original document > 
- 3 Touch **Copy to**, and then select the tray containing the paper type you want to use.
- 4 Touch  > **Copy It**.

### Copying different paper sizes

#### Copying onto mixed paper sizes

- 1 Load an original document into the ADF tray or on the scanner glass.
- 2 From the home screen, navigate to:  
**Copy > Copy from > Mixed Sizes** > 
- 3 Touch **Copy to > Auto Size Match** >  > **Copy It**.

#### Copying onto a single paper size

- 1 Load an original document into the ADF tray or on the scanner glass.
- 2 From the home screen, navigate to:  
**Copy > Copy from > Mixed Sizes** > 
- 3 Touch **Copy to > Letter** >  > **Copy It**.

The scanner identifies the different paper sizes as they are scanned, and then scales the mixed paper sizes to fit on the paper size selected.

## Copying on both sides of the paper (two-sided)



- 1 Load an original document into the ADF tray or on the scanner glass.
- 2 From the home screen, navigate to:  
**Copy > Sides (Duplex)** > select the preferred two-sided method

**Note:** For the preferred method, the first number represents sides of the original documents while the second number represents sides of the copy. For example, select “2 sided to 2 sided” if you have two-sided original documents and you want two-sided copies.

- 3 Touch  > **Copy It.**

## Reducing or enlarging copies

Copies can be scaled from 25% to 400% of the original document size.



- 1 Load an original document into the ADF tray or on the scanner glass.
- 2 From the home screen, touch **Copy**.
- 3 From the Scale area, touch  or  to decrease or increase the value by 1%.

Touching “Copy to” or “Copy from” after setting Scale manually changes the scale value back to Auto.

**Note:** Auto is the factory default setting. This automatically adjusts the scan image of the original document to fit the size of the paper onto which you are copying.



- 4 Touch **Copy It.**

## Adjusting copy quality

- 1 Load an original document into the ADF tray or on the scanner glass.
- 2 From the home screen, navigate to:  
**Copy > Content** > specify the content type of the document > 
- 3 Specify the content source of the document, and then touch  > **Copy It.**

## Collating copies

If you print multiple copies of a document, then you can choose to print the copies as a set (collated) or to print the copies as groups of pages (not collated).

Collated	Not collated
	

- 1 Load an original document into the ADF tray or on the scanner glass.
- 2 From the home screen, navigate to:

**Copy** > enter the number of copies > **Collate** > select the preferred order of pages >  > **Copy It**

## Placing separator sheets between copies

- 1 Load an original document into the ADF tray or on the scanner glass.
- 2 From the home screen, navigate to:

**Copy** > **Advanced Options** > **Separator Sheets** > select where you want to place the separator sheets

**Note:** Set Collate to (1,2,3) (1,2,3) to place separator sheets between copies. If Collate is set to (1,1,1) (2,2,2), then the separator sheets are added to the end of the copy job. For more information, see [“Collating copies” on page 79](#).

- 3 Touch  > **Copy It**.

## Copying multiple pages onto a single sheet

In order to save paper, you can copy either two or four consecutive pages of a multiple-page document onto a single sheet of paper.

### Notes:

- Make sure to set the paper size to letter, legal, A4, or JIS B5.
- Make sure to set the copy size to 100%.

- 1 Load an original document into the ADF tray or on the scanner glass.
- 2 From the home screen, navigate to:

**Copy** > **Advanced Options** > **Paper Saver** > select the output you want >  > **Copy It**

**Note:** If Paper Saver is set to Off, then the Print Page Borders option is unavailable.

## Creating a custom copy job

The custom copy job is used to combine one or more sets of original documents into a single copy job.

The definition of a set depends on the scan source:

- If you scan a document on the scanner glass, then a set consists of one page.
- If you scan multiple pages using the ADF, then a set consists of all scanned pages until the ADF tray becomes empty.
- If you scan one page using the ADF, then a set consists of one page.

- 1 Load an original document into the ADF tray or on the scanner glass.
- 2 From the home screen, navigate to:

**Copy** > **Advanced Options** > **Custom Job** > **On** >  > **Copy It**

**Note:** When the end of a set is reached, the scan screen appears.





- 3 Load the next document into the ADF tray or on the scanner glass, and then touch **Scan from automatic feeder** or **Scan from flatbed**.

**Note:** Change the scan job settings, if necessary.

- 4 If you have another document to scan, then repeat the previous step. Otherwise, touch **Finish the job**.

## Placing a header or footer on pages

- 1 Load an original document into the ADF tray or on the scanner glass.
- 2 From the home screen, navigate to:  
**Copy > Advanced Options > Header/Footer** > select where you want to place the header or footer > select the type of header or footer you want
- 3 Enter the required information depending on the header or footer you selected, and then touch **Done**.
- 4 Touch , and then press .

## Canceling a copy job while pages are being printed

- 1 From the printer control panel, touch **Cancel Job** or press  on the keypad.
- 2 Touch the job you want to cancel, and then touch **Delete Selected Jobs**.

**Note:** If you press  on the keypad, then touch **Resume** to return to the home screen.

## Understanding the copy options

### Copy from

This option opens a screen where you can select the paper size of the original document.

- Touch the paper size that matches the original document.
- To copy an original document that contains mixed paper sizes with the same width, touch **Mixed Sizes**.
- To set the printer to automatically detect the size of the original document, touch **Auto Size Sense**.



### Copy to

This option opens a screen where you can enter the paper size and type on which your copies will be printed.

- Touch the paper size and type that matches the paper loaded.
- If the paper size setting for “Copy from” and “Copy to” are different, then the printer automatically adjusts the Scale setting to accommodate the difference.

## Scale

This option lets you scale the document from 25% to 400% of the original document size. You can also set automatic scaling.

- When copying to a different paper size, such as from legal-size to letter-size paper, set the “Copy from” and “Copy to” paper sizes automatically to scale the scan image to fit the size of the paper onto which you are copying.
- To decrease or increase the value by 1%, touch  or  on the printer control panel. To make a continuous decrease or increase in value, hold the button for two seconds or more.

## Darkness

This option lets you adjust how light or dark the copies are in relation to the original document.

## Sides (Duplex)

This option lets you make one- or two-sided copies from one- or two-sided original documents.

## Collate

This option keeps the pages of a print job stacked in sequence when printing multiple copies of the document.

## Copies

This option lets you set the number of copies to be printed.

## Content

This option lets you specify the content type and source of the original document.

## Save As Shortcut

This option lets you save the current settings by assigning a shortcut name.

**Note:** Selecting this option automatically assigns the next available shortcut number.



## Punch

This setting specifies whether copy jobs will have holes punched in them.



## Staple

This setting specifies whether copy jobs that contain multiple pages will be stapled.

## Using the advanced options

- **Advanced Duplex**—This specifies the document orientation, one-sided or two-sided printing, and type of binding.
- **Advanced Imaging**—This adjusts the Auto Center, Background Removal, Color Balance, Color Dropout, Contrast, Mirror Image, Negative Image, Scan Edge to Edge, Shadow Detail, and Sharpness settings before you copy the document.
- **Create Booklet**—This creates a one-sided or two-sided booklet.  
**Note:** This option appears only when a printer hard disk is installed.
- **Cover Page Setup**—This sets up the cover page of copies and booklets.
- **Custom Job**—This combines multiple scanning jobs into a single job.  
**Note:** This option appears only when a printer hard disk is installed.
- **Edge Erase**—This removes smudges or marks around the edges of a document. You can choose to remove an equal area around all four sides of the paper, or pick a particular edge. Edge Erase removes whatever is within the area selected.
- **Fold**—This folds the paper in two (bifold) or three (trifold).  
**Note:** This option appears only if a booklet finisher is installed.
- **Header/Footer**—This inserts Date/Time, Page number, Bates number, or Custom text in the specified header or footer location.
- **Margin Shift**—This increases or decreases the page margin by shifting the scanned image. Touch  or  to set the margin you want. If the additional margin is too large, then the copy is cropped.
- **Offset Pages**—This offsets pages between copies or between jobs.
- **Overlay**—This creates a watermark or message that overlays each page of your copy. You can choose from preset messages or enter a custom message.
- **Paper Saver**—This prints two or more pages of an original document on the same page. Paper Saver is also called *N-up* printing, where *N* stands for the number of pages. For example, 2-up would print two pages on a single page, and 4-up would print four pages on a single page.
- **Separator Sheets**—This places a blank sheet of paper between copies, pages, or print jobs. The separator sheets can be drawn from a tray that contains a type or color of paper that is different from the paper your copies are printed on.

## E-mailing

Automatic document feeder (ADF)	Scanner glass
 <ul style="list-style-type: none"><li>• Use the ADF for multiple-page or two-sided documents.</li><li>• Load the original document faceup.</li></ul>	 <ul style="list-style-type: none"><li>• Use the scanner glass for single-page documents, book pages, small items (such as postcards or photos), transparencies, photo paper, or thin media (such as magazine clippings).</li><li>• Place the document facedown in the corner with the arrow.</li></ul>

## Setting up the printer to e-mail

### Configuring e-mail settings

- 1 Open a Web browser, and then type the printer IP address in the address field.



**Notes:**

- View the printer IP address on the printer home screen. The IP address appears as four sets of numbers separated by periods, such as 123.123.123.123.
- If you are using a proxy server, then temporarily disable it to load the Web page correctly.

- 2 Click **Settings > E-mail/FTP Settings > E-mail Settings**.
- 3 Enter the appropriate information, and then click **Submit**.

## Creating an e-mail shortcut

### Notes:

- Make sure that E-mail Shortcuts is set to Display. From the home screen, touch  > **Settings** > **General Settings** > **Home screen customization** > **E-mail Shortcuts** > **Display** > **Submit**.
- To delete an e-mail shortcut, touch  > **Manage Shortcuts** > **E-mail Shortcuts** > the shortcut to delete > **Delete Entry** > **Delete now**.

## Creating an e-mail shortcut using the Embedded Web Server

- 1 Open a Web browser, and then type the printer IP address in the address field.

### Notes:

- View the printer IP address on the printer home screen. The IP address appears as four sets of numbers separated by periods, such as 123.123.123.123.
- If you are using a proxy server, then temporarily disable it to load the Web page correctly.

- 2 Click **Settings**.
- 3 From the Other Settings column, click **Manage Shortcuts** > **E-mail Shortcut Setup**.
- 4 Type a unique name for the e-mail recipient, and then type the e-mail address. If you are entering multiple addresses, then separate each address with a comma.
- 5 Click **Add**.

## Creating an e-mail shortcut using the control panel

- 1 From the home screen, navigate to:  
**MyShortcut** > **Create** > **E-mail**
- 2 Type a unique shortcut name, and then touch **Done**.
- 3 Configure the e-mail settings, and then touch **Done**.
- 4 Touch **E-mail Shortcuts** on the home screen to verify the shortcut.

## E-mailing a document

### Sending an e-mail using the control panel

- 1 Load an original document into the ADF tray or on the scanner glass.
- 2 From the home screen, touch **E-mail**, and then enter the information needed.
- 3 Configure and then save the output file type settings.
- 4 Touch **Send It**.

## Sending an e-mail using a shortcut number

- 1 Load an original document into the ADF tray or on the scanner glass.
- 2 Press #, and then enter the shortcut number using the keypad.
- 3 Touch **Send It**.

## Sending an e-mail using the address book

- 1 Load an original document into the ADF tray or on the scanner glass.
- 2 From the home screen, navigate to:  
E-mail > **Recipient(s)** >  > type the name of the recipient > **Search**
- 3 Select the recipient's name, and then touch **Done**.

## Customizing e-mail settings

### Changing the output file type

- 1 Load an original document into the ADF tray or on the scanner glass.
- 2 From the home screen, navigate to:  
E-mail > **Recipient(s)** > type the e-mail address > **Done** > **Send as**
- 3 Select the file type you want to send.  
**Note:** If you select Secure PDF, then you will be prompted to enter your password twice.
- 4 Touch  > **Send It**.

## Canceling an e-mail

- When using the ADF, touch **Cancel Job** while **Scanning** appears.
- When using the scanner glass, touch **Cancel Job** while **Scanning** appears, or while **Scan the Next Page / Finish the Job** appears.

## Understanding the e-mail options

### Recipient(s)

This option lets you enter the recipient of your e-mail. You may enter multiple e-mail addresses.

### Subject

This option lets you type a subject line for your e-mail.

## Message

This option lets you type a message that will be sent with your scanned attachment.

## File Name

This option lets you customize the attachment file name.

## Original Size

This option lets you set the paper size of the documents you are going to e-mail. When Original Size is set to Mixed Sizes, you can scan an original document that contains mixed paper sizes (letter- and legal-size pages).

## Resolution

This option lets you adjust the output quality of your e-mail. Increasing the image resolution increases the e-mail file size and the time needed to scan your original document. Decreasing the image resolution reduces the file size.

## Content

This option lets you specify the content type and source of the original document.

## Save As Shortcut

This option lets you save the current settings as a shortcut by assigning a shortcut name.

**Note:** Selecting this option automatically assigns the next available shortcut number.

## Darkness

This option lets you adjust how light or dark your scanned documents are in relation to the original document.

## Send As

This option lets you set the output type for the scan image.

Select one of the following:

- **PDF**—Use this to create a single file with multiple pages. This can be sent as a secured or compressed file.
- **TIFF**—Use this to create multiple files or a single file. If Multi-page TIFF is turned off in the Settings menu of the Embedded Web Server, then TIFF saves one page in each file. The file size is usually larger than an equivalent JPEG.
- **JPEG**—Use this to create and attach a separate file for each page of your original document.
- **XPS**—Use this to create a single XPS file with multiple pages.

## Page Setup

This option lets you change the following settings:

- **Sides (Duplex)**—This specifies if the original document is printed on only one side or on both sides of the paper. This also identifies what needs to be scanned for inclusion in the e-mail.
- **Orientation**—This specifies the orientation of the original document, and then changes the Sides (Duplex) and Binding settings to match the orientation.
- **Binding**—This specifies if the original document is bound on the long-edge or short-edge side.

## Scan Preview

This option lets you view the first page of the image before it is included in the e-mail. When the first page is scanned, the scanning is paused and a preview image appears.

**Note:** This option appears only when a working printer hard disk is installed.



## Using the advanced options

Select from the following settings:

- **Advanced Imaging**—This adjusts the Background Removal, Color Balance, Color Dropout, Contrast, JPEG Quality, Mirror Image, Negative Image, Scan Edge to Edge, Shadow Detail, Sharpness, and Temperature settings before you e-mail the document.
- **Custom Job**—This combines multiple scanning jobs into a single job.  
**Note:** This option appears only when a formatted, working printer hard disk is installed.
- **Edge Erase**—This removes smudges or marks around the edges of a document. You can choose to remove an equal area around all four sides of the paper, or pick a particular edge. Edge Erase will erase whatever is within the area selected, leaving nothing on that portion of the scan.
- **Transmission Log**—This prints the transmission log or transmission error log.



## Faxing

Automatic document feeder (ADF)	Scanner glass
 <ul style="list-style-type: none"> <li>• Use the ADF for multiple-page or two-sided documents.</li> <li>• Load the original document faceup.</li> </ul>	 <ul style="list-style-type: none"> <li>• Use the scanner glass for single-page documents, book pages, small items (such as postcards or photos), transparencies, photo paper, or thin media (such as magazine clippings).</li> <li>• Place the document facedown in the corner with the arrow.</li> </ul>

## Setting up the printer to fax

 **CAUTION—SHOCK HAZARD:** Do not use the fax feature during a lightning storm. Do not set up this product or make any electrical or cabling connections, such as the fax feature, power cord, or telephone, during a lightning storm.

### Notes:

- The following connection methods are applicable only in some countries or regions.
- During the initial printer setup, clear the fax function check box and any other function you plan to set up later, and then touch **Continue**.
- The indicator light may blink red if the fax function is enabled and not fully set up.

**Warning—Potential Damage:** Do not touch cables or the printer in the area shown while actively sending or receiving a fax.

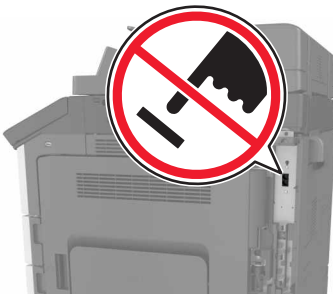

## Initial fax setup

Many countries and regions require outgoing faxes to contain the following information in a margin at the top or bottom of each transmitted page, or on the first page of the transmission: fax name (identification of the business, other entity, or individual sending the message) and fax number (telephone number of the sending fax machine, business, other entity, or individual). For more information, see [“Regulatory notices for telecommunication terminal equipment” on page 342](#).

To enter your fax setup information, use the printer control panel, or use your browser to access the Embedded Web Server and then enter the Settings menu.

**Note:** If you do not have a TCP/IP environment, then you must use the printer control panel to enter your fax setup information.

### Using the printer control panel for fax setup

When the printer is turned on for the first time, a series of start-up screens appear. If the printer has fax capabilities, then the Fax Name and Fax Number screens appear.

- 1 When the Fax Name screen appears, do the following:
  - a Enter the name to be printed on all outgoing faxes.
  - b Enter the fax name, and then touch **Submit**.
- 2 When the Fax Number screen appears, enter the fax number, and then touch **Submit**.

### Using the Embedded Web Server for fax setup

- 1 Open a Web browser, and then type the printer IP address in the address field.

**Notes:**

- View the printer IP address on the printer home screen. The IP address appears as four sets of numbers separated by periods, such as 123.123.123.123.
- If you are using a proxy server, then temporarily disable it to load the Web page correctly.

- 2 Click **Settings > Fax Settings > Analog Fax Setup**.
- 3 In the Fax Name field, type the name to be printed on all outgoing faxes.
- 4 In the Fax Number field, enter the printer fax number.
- 5 Click **Submit**.

## Choosing a fax connection

### Scenario 1: Standard telephone line

#### Setup 1: Printer is connected to a dedicated fax line

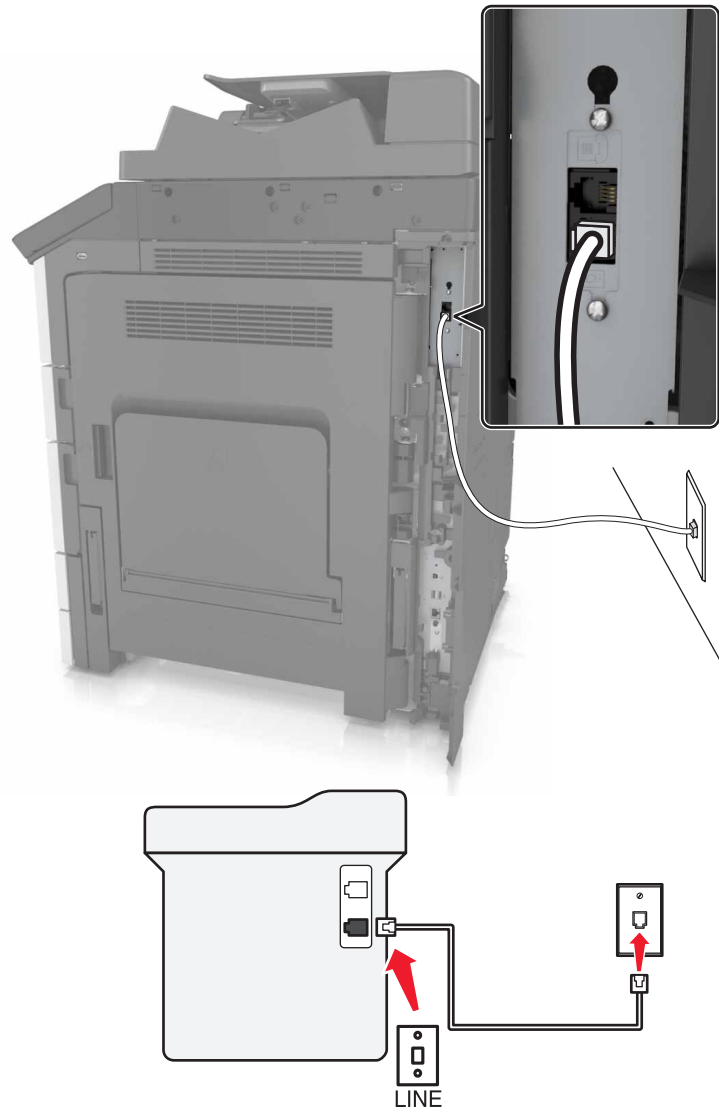



#### To connect:

- 1 Connect one end of the telephone cable that came with the printer to the  port of the printer.
- 2 Connect the other end of the telephone cable to an active analog wall jack.

#### Tips for this setup:

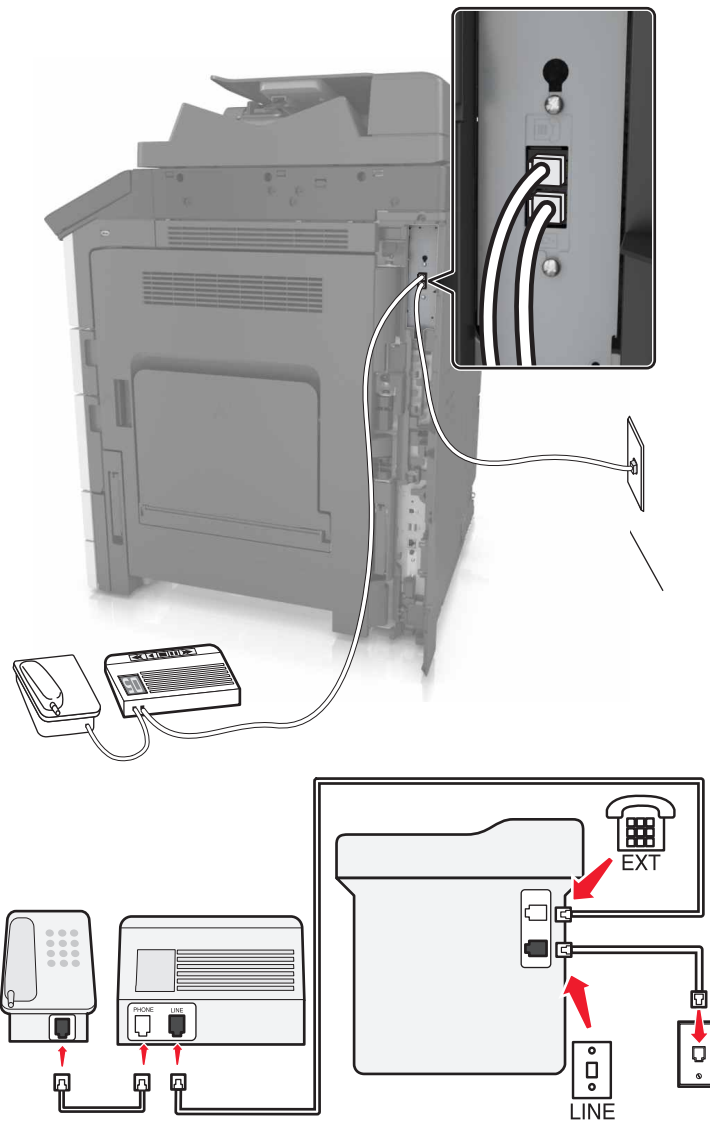
- You can set the printer to receive faxes automatically (Auto Answer On) or manually (Auto Answer Off).
- If you want to receive faxes automatically (Auto Answer On), then set the printer to pick up on any number of rings that you want.

**Setup 2: Printer is sharing the line with an answering machine****Connected to the same telephone wall jack****To connect:**

- 1 Connect one end of the telephone cable that came with the printer to the  port of the printer.
- 2 Connect the other end of the telephone cable to an active analog wall jack.
- 3 Connect the answering machine to the  port of the printer.

### Connected to different wall jacks

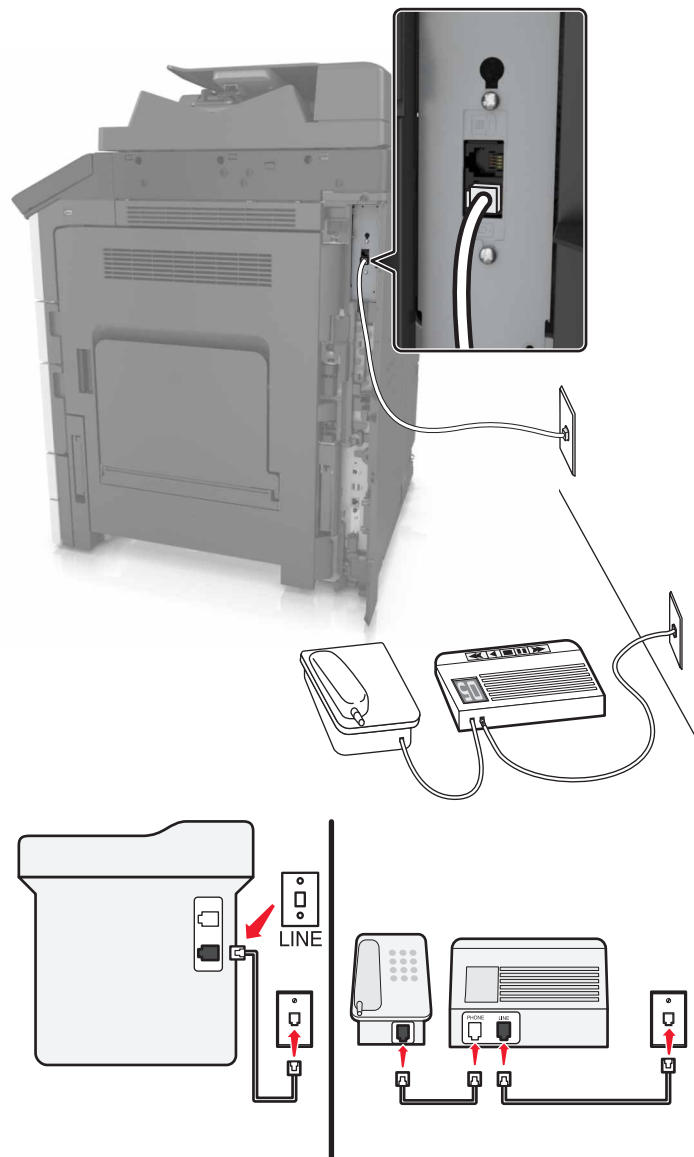

#### To connect:

- 1 Connect one end of the telephone cable that came with the printer to the  port of the printer.
- 2 Connect the other end of the telephone cable to an active analog wall jack.

#### Tips for this setup:



- If you have only one telephone number on your line, then you need to set the printer to receive faxes automatically (Auto Answer On).
- Set the printer to pick up calls two rings after the answering machine. For example, if the answering machine picks up calls after four rings, then set the printer to pick up after six rings. This way, the answering machine picks up calls first and your voice calls are received. If the call is a fax, then the printer detects the fax signal on the line and takes over the call.

- If you subscribe to a distinctive ring service provided by your telephone company, then make sure that you set the correct ring pattern for the printer. Otherwise, the printer does not receive faxes even if you have set it to receive faxes automatically.

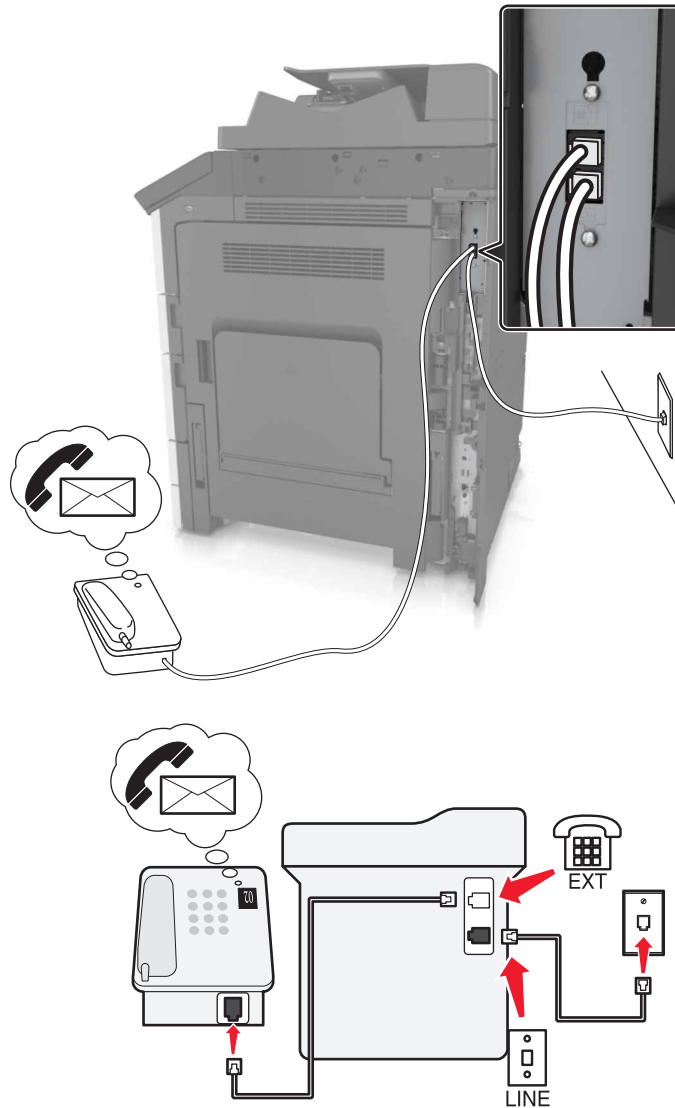
### Setup 3: Printer is sharing the line with a telephone subscribed to voice mail service



#### To connect:

- 1 Connect one end of the telephone cable that came with the printer to the  port of the printer.
- 2 Connect the other end of the telephone cable to an active analog wall jack.
- 3 Connect the telephone to the  port of the printer.

**Tips for this setup:**

- This setup works best if you subscribe to a distinctive ring service. If you have distinctive ring service, then make sure that you set the correct ring pattern for the printer. Otherwise, the printer does not receive faxes even if you have set it to receive faxes automatically.
- If you have only one telephone number on your line, then you need to set the printer to receive faxes manually (Auto Answer Off).

When you answer the telephone and you hear fax tones, press **\*9\*** or the manual answer code on the telephone to receive the fax.

- You can also set the printer to receive faxes automatically (Auto Answer On), but you need to turn off the voice mail service when you are expecting a fax. This setting works best if you are using voice mail more often than fax.

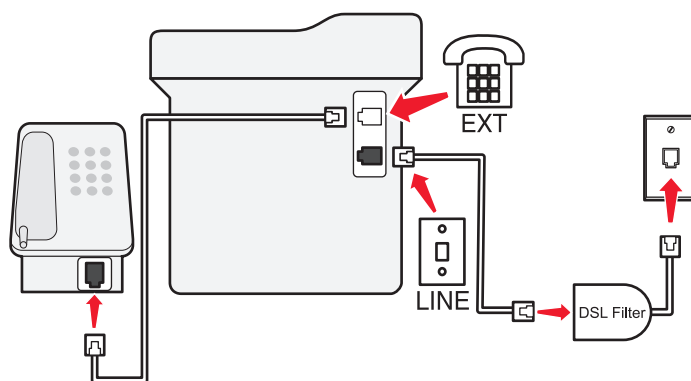
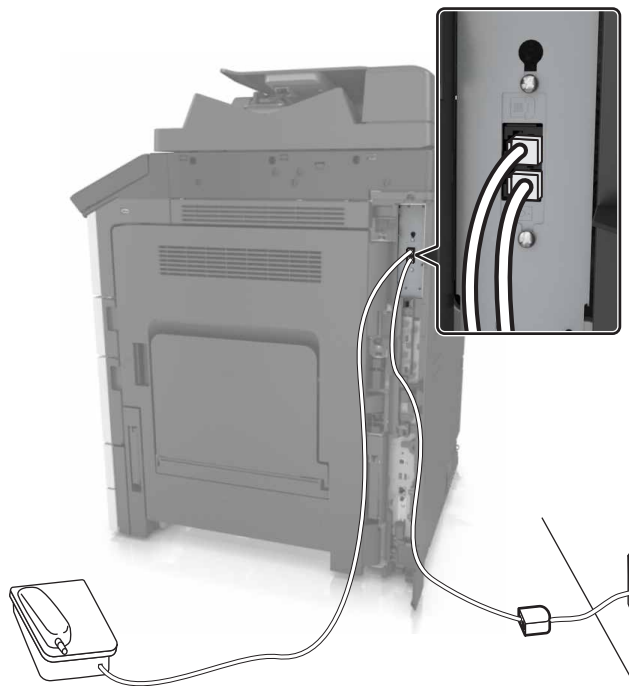

**Scenario 2: Digital Subscriber Line (DSL)**

A Digital Subscriber Line splits your regular telephone line into two channels: voice and Internet. Telephone and fax signals travel through the voice channel, and Internet signals pass through the other channel. This way, you can use the same line for analog voice calls (including faxes) and digital Internet access.

To minimize interference between the two channels and ensure a quality connection, you need to install a DSL filter for the analog devices (fax machine, telephone, answering machine) in your network. Interference causes noise and static on the telephone, failed and poor quality faxes for the printer, and slow Internet connection on your computer.

**Note:** Contact your DSL provider to obtain a DSL filter.

To install a filter for the printer:

- 1 Connect the line port of the DSL filter to the wall jack.
- 2 Connect one end of the telephone cable that came with your printer to the  port of the printer. Connect the other end to the phone port on the DSL filter.
- 3 To connect a telephone to the printer, remove any installed adapter plug from the  port of the printer, and then connect the telephone to the port.

### Scenario 3: VoIP telephone service

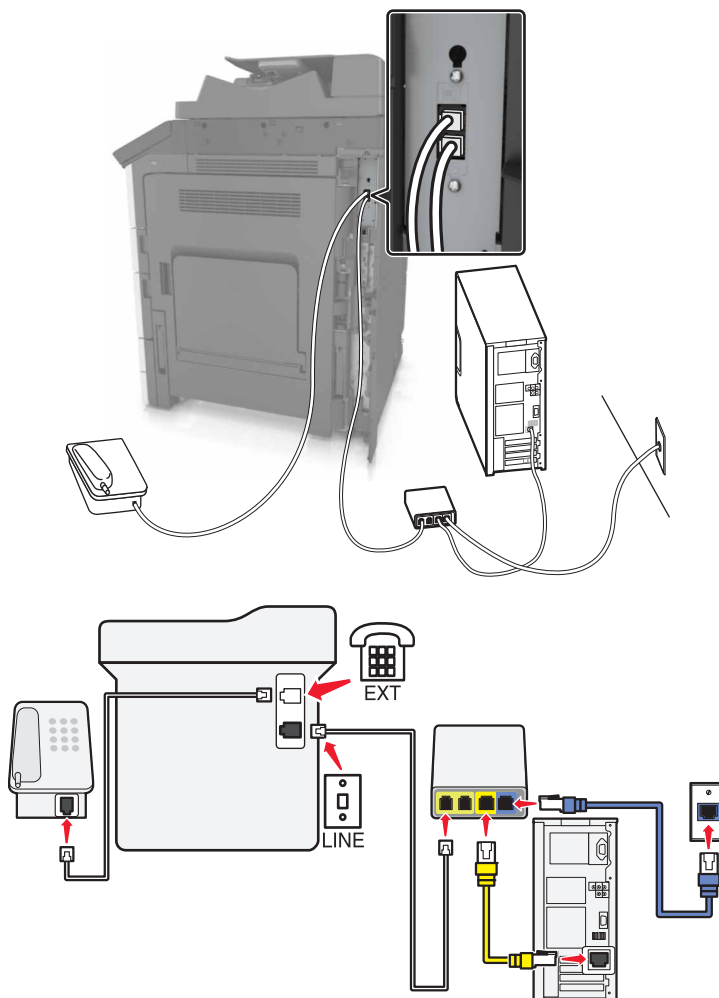



**To connect:**

- 1 Connect one end of the telephone cable that came with the printer to the  port of the printer.
- 2 Connect the other end of the cable to the port labeled **Phone Line 1** or **Phone Port** on the VoIP adapter.

**Note:** The port labeled **Phone Line 2** or **Fax Port** is not always active. VoIP providers may charge additional cost for activation of the second phone port.

- 3 Connect the telephone to the  port of the printer.

**Tips for this setup:**

- To make sure that the phone port on the VoIP adapter is active, plug an analog telephone into the phone port, and then listen for a dial tone. If you hear a dial tone, then the port is active.
- If you need two phone ports for your devices, but do not want to pay additional cost, then do not plug the printer into the second phone port. You can use a phone splitter. Plug the phone splitter into the port labeled **Phone Line 1** or **Phone Port**, and then plug the printer and telephone into the splitter.

**Note:** Make sure you use a phone splitter, *not* a line splitter. To make sure that you are using the correct splitter, plug an analog telephone into the splitter and then listen for a dial tone.

## Scenario 4: Digital telephone service through a cable provider

### Setup 1: Printer is connected directly to a cable modem

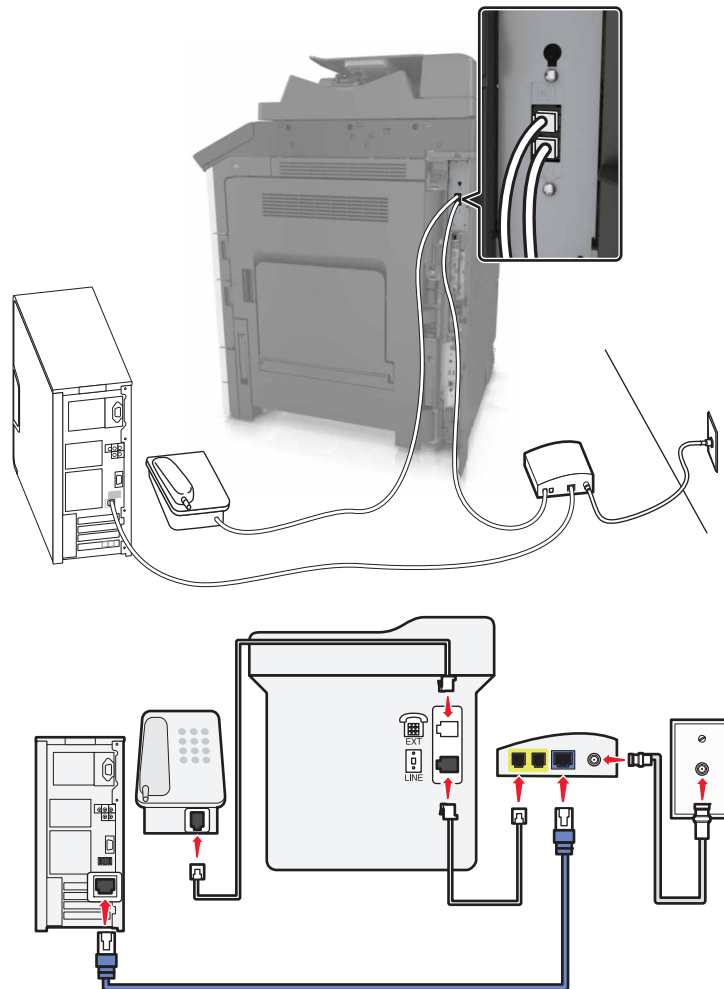

- 1 Connect one end of the telephone cable that came with your printer to the  port of the printer.
- 2 Connect the other end of the cable to the port labeled **Phone Line 1** or **Phone Port** on the cable modem.



**Note:** The port labeled **Phone Line 2** or **Fax Port** is not always active. VoIP providers may charge additional cost for activation of the second phone port.

- 3 Connect your analog telephone phone to the  port of the printer.

#### Notes:

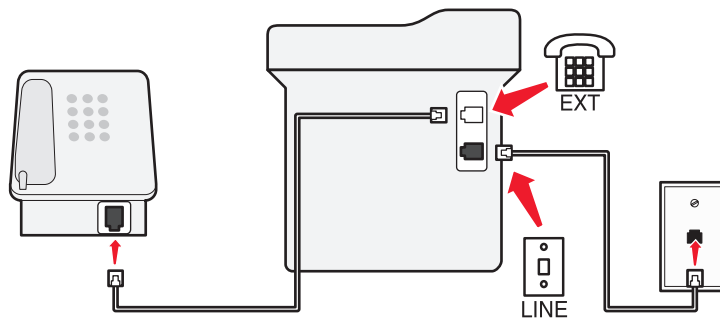
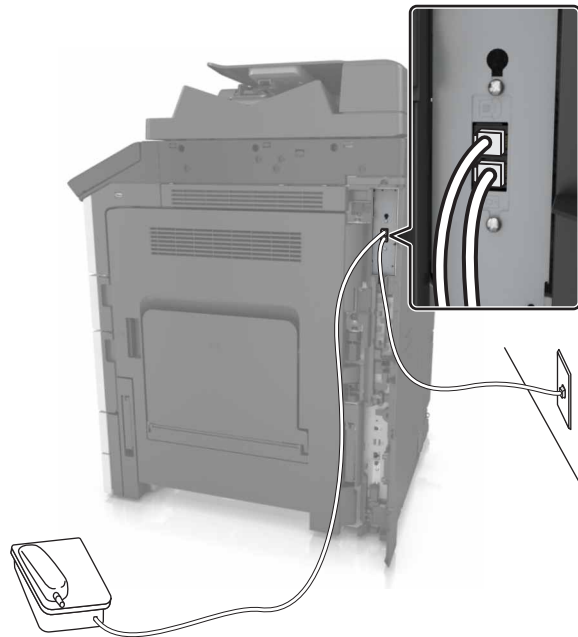
- To make sure that the telephone port on the cable modem is active, plug an analog telephone into the telephone port, and then listen for a dial tone. If you hear a dial tone, then the port is active.
- If you need two telephone ports for your devices, but do not want to pay additional cost, then do not plug the printer into the second telephone port. You can use a phone splitter. Plug the phone splitter into the **Phone Line 1** or **Phone Port**, and then plug the printer and telephone into the splitter.
- Make sure you use a phone splitter, *not* a line splitter. To make sure that you are using the correct splitter, plug an analog telephone into the splitter and then listen for a dial tone.

**Setup 2: Printer is connected to a wall jack; cable modem is installed elsewhere in the facility**



- 1 Connect one end of the telephone cable that came with your printer to the  port of the printer.
- 2 Connect the other end of the telephone cable to an active analog telephone wall jack.
- 3 Connect your analog telephone to the  port of the printer.

**Scenario 5: Countries or regions with different telephone wall jacks and plugs**

Some countries or regions may have different types of telephone wall jack connectors than those that came with the printer. The standard wall jack adopted by most countries or regions is RJ-11. Your printer comes with the RJ-11 jack and a telephone cable with the RJ-11 plug.

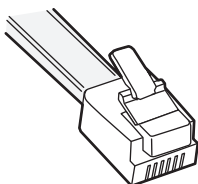
If the wall jack or equipment in your facility is not compatible with this type of connection, then you need to use a telephone adapter. An adapter for your country or region may not come with your printer, and you may need to purchase it separately.



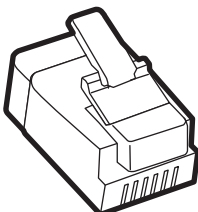

There may be an adapter plug installed in the  port of the printer. If you are using a telephone adapter or a facility that has a cascaded or serial wiring scheme, then do not remove the adapter plug from the  port of the printer.



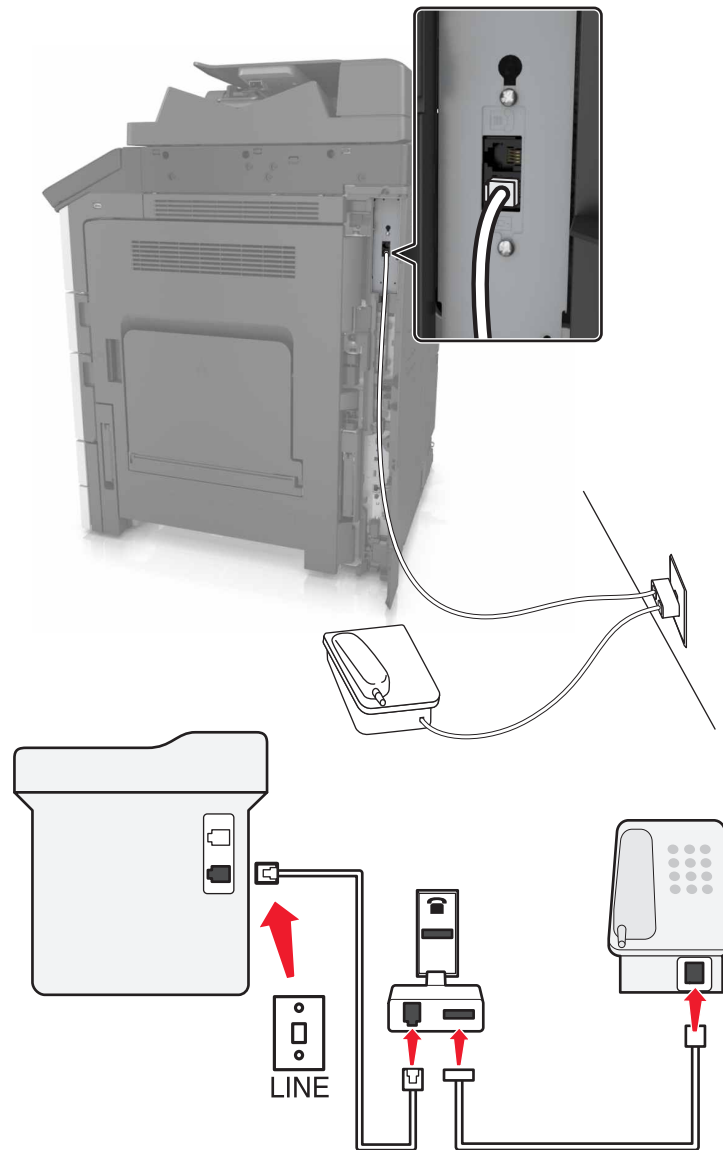

Part name	Part number
Lexmark adapter plug	40X8519

## Connecting the printer to a non-RJ-11 wall jack



- 1 Connect one end of the telephone cable that came with printer to the  port of the printer.
- 2 Connect the other end of the cable to the RJ-11 adapter, and then connect the adapter to the wall jack.
- 3 If you want to connect another device (telephone or answering machine) to the same wall jack, and if the device has a non-RJ-11 connector, then connect it directly to the telephone adapter.

### Notes:

- The  port of the printer may have an adapter plug for use with the adapter. Do *not* remove the plug from the  port of the printer.
- In some countries or regions, the printer may not come with a telephone adapter or an adapter plug.

**Connecting the printer to a wall jack in Germany**

The German wall jack has two kinds of ports. The N ports are for fax machines, modems, and answering machines. The F port is for telephones.

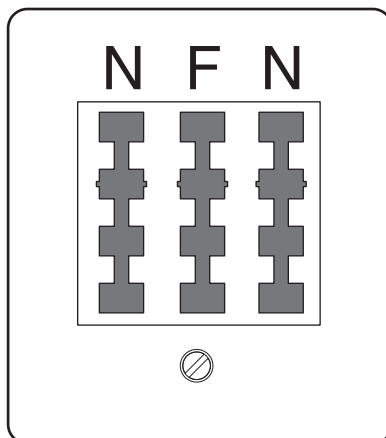

Connect the printer to any of the N ports.

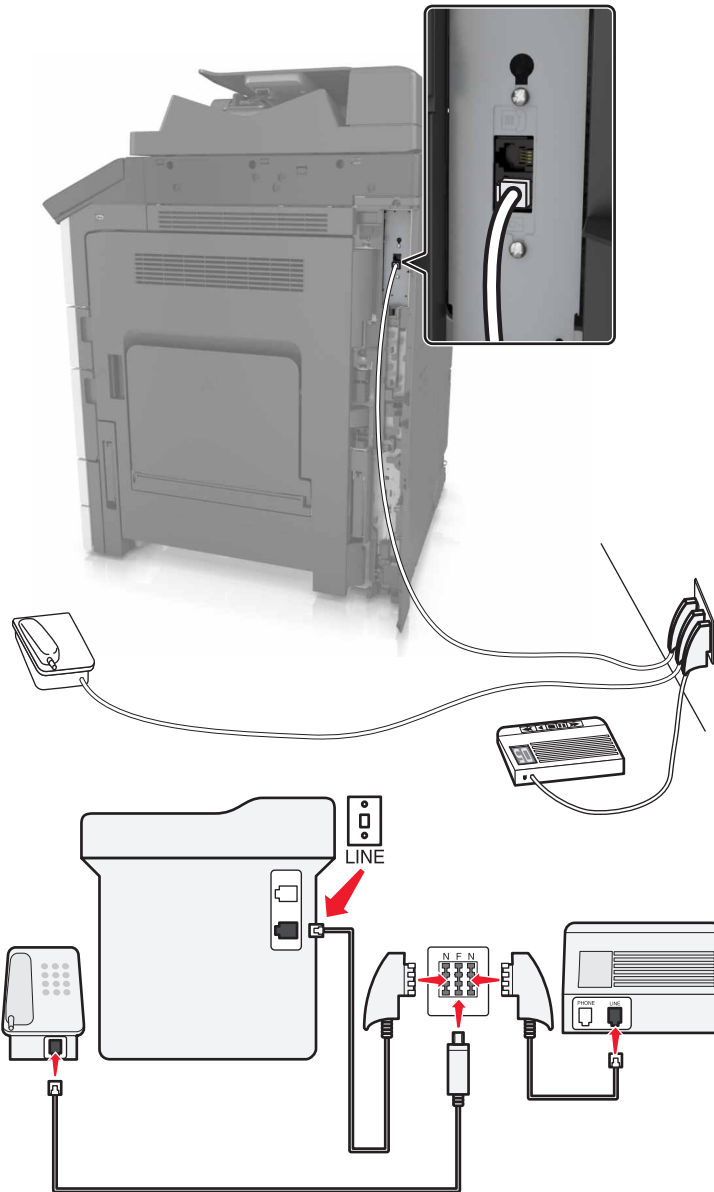

- 1 Connect one end of the telephone cable that came the printer to the  port of the printer.
- 2 Connect the other end of the telephone cable to the RJ-11 adapter, and then connect the adapter to an N port.
- 3 If you want to connect a telephone and answering machine to the same wall jack, then connect the devices as shown.

**Note:** Do *not* remove the adapter plug from the  port of the printer if you are connecting to a serial or cascaded telephone system.

## Connecting to a distinctive ring service

A distinctive ring service may be available from your telephone company. This service lets you have multiple telephone numbers on one telephone line, with each telephone number having a different ring pattern. This may be useful for distinguishing between fax and voice calls. If you subscribe to a distinctive ring service, then follow these steps to connect the equipment:

- 1 Connect one end of the telephone cable that came with the printer to the printer LINE port .
- 2 Connect the other end of the telephone cable to an active analog telephone wall jack.

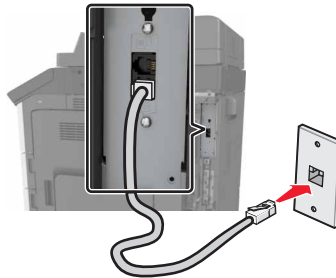

- 3 Change the distinctive rings setting to match the setting you want for the printer to answer.

**Note:** The factory default setting for distinctive rings is On. This sets the printer to answer single, double, and triple ring patterns.

- a From the home screen, navigate to:



> **Settings** > **Fax Settings** > **Analog Fax Setup** > **Answer On**

- b Select the pattern setting you want to change, and then touch **Submit**.

## Setting the outgoing fax name and number

- 1 Open a Web browser, and then type the printer IP address in the address field.

### Notes:

- View the printer IP address on the printer home screen. The IP address appears as four sets of numbers separated by periods, such as 123.123.123.123.
- If you are using a proxy server, then temporarily disable it to load the Web page correctly.

- 2 Click **Settings** > **Fax Settings** > **Analog Fax Setup**.
- 3 In the Fax Name field, type the name to be printed on all outgoing faxes.
- 4 In the Fax Number field, enter the printer fax number.
- 5 Click **Submit**.

## Setting the date and time

You can set the date and time so that they are printed on every fax you send.

- 1 Open a Web browser, and then type the printer IP address in the address field.



**Notes:**

- View the IP address on the home screen. The IP address appears as four sets of numbers separated by periods, such as 123.123.123.123.
- If you are using a proxy server, then temporarily disable it to load the Web page correctly.

**2** Click **Settings > Security > Set Date and Time**.

**3** In the Manually Set Date & Time field, enter the current date and time.

**Note:** The use of network time is recommended.

**4** Click **Submit**.

## Configuring the printer to observe daylight saving time

The printer can be set to automatically adjust for daylight saving time.

**1** Open a Web browser, and then type the printer IP address in the address field.

**Notes:**

- View the printer IP address on the printer home screen. The IP address appears as four sets of numbers separated by periods, such as 123.123.123.123.
- If you are using a proxy server, then temporarily disable it to load the Web page correctly.

**2** Click **Settings > Security > Set Date and Time**.

**3** Click the **Automatically Observe DST** check box.

**4** In the Custom Time Zone Setup section, set the DST start and end dates.

**5** Click **Submit**.

## Sending a fax

### Sending a fax using the control panel

**1** Load an original document into the ADF tray or on the scanner glass.

**2** From the home screen, touch **Fax**, and then enter the fax number.

**Notes:**

- You can also enter the recipient using the shortcut number or address book.
- To add recipients, touch **Next number**.

**3** Touch **Fax It**.

## Sending a fax using the computer

### For Windows users

- 1 With a document open, click **File > Print**.
- 2 Select the printer, and then click **Properties, Preferences, Options, or Setup**.
- 3 Click **Fax > Enable fax**, and then enter the recipient fax number or numbers.
- 4 If necessary, configure other fax settings.
- 5 Apply the changes, and then send the fax job.

### Notes:

- The fax option is available only with the PostScript driver or the Universal Fax Driver. For more information, go to <http://support.lexmark.com>.
- To use the fax option with the PostScript driver, configure and enable it in the Configuration tab.

### For Macintosh users

- 1 With a document open, choose **File > Print**.
- 2 Select the printer.
- 3 Enter the recipient fax number, and then configure other fax settings, if necessary.
- 4 Send the fax job.

## Sending a fax at a scheduled time

- 1 Load an original document faceup, short edge first into the ADF tray or facedown on the scanner glass.

### Notes:

- Do not load postcards, photos, small items, transparencies, photo paper, or thin media (such as magazine clippings) into the ADF tray. Place these items on the scanner glass.
- The ADF indicator light comes on when the paper is loaded properly.

- 2 If you are loading a document into the ADF tray, then adjust the paper guides.
- 3 From the home screen, navigate to:  
**Fax > enter the fax number > Options > Delayed Send**



**Note:** If Fax Mode is set to Fax Server, then the Delayed Send button does not appear. Faxes waiting for transmission are listed in the fax queue.

- 4 Specify the time the fax will be transmitted, and then touch .
- 5 Touch **Fax It**.

**Note:** The document is scanned, and then faxed at the scheduled time.

## Creating shortcuts

### Notes:

- Make sure that Fax Shortcuts is set to Display. From the home screen, touch  > **Settings** > **General Settings** > **Home screen customization** > **Fax Shortcuts** > **Display** > **Submit**.
- To delete a fax shortcut, touch  > **Manage Shortcuts** > **Fax Shortcuts** > the shortcut to delete > **Delete now**.

## Creating a fax destination shortcut using the Embedded Web Server

Assign a shortcut number to a single fax number or a group of fax numbers.

- 1 Open a Web browser, and then type the printer IP address in the address field.

### Notes:

- View the printer IP address on the printer home screen. The IP address appears as four sets of numbers separated by periods, such as 123.123.123.123.
- If you are using a proxy server, then temporarily disable it to load the Web page correctly.

- 2 Click **Settings** > **Manage Shortcuts** > **Fax Shortcut Setup**.

**Note:** A password may be required. If you do not have an ID and password, then contact your system support person.

- 3 Type a name for the shortcut, and then enter the fax number.

### Notes:

- To create a multiple-number shortcut, enter the fax numbers for the group.
- Separate each fax number in the group with a semicolon (;).

- 4 Assign a shortcut number.

**Note:** If you enter a number that is already in use, then you are prompted to select another number.

- 5 Click **Add**.

## Creating a fax destination shortcut using the printer control panel

- 1 From the home screen, touch **Fax**, and then enter the fax number.

**Note:** To create a group of fax numbers, touch **Next number**, and then enter the next fax number.

- 2 Touch .

- 3 Type a unique name for the shortcut, and then touch **Done**.

- 4 Verify that the shortcut name and number are correct, and then touch **OK**.

**Note:** If the name or number is incorrect, then touch **Cancel**, and then reenter the information.

## Customizing fax settings

### Changing the fax resolution

- 1 Load an original document faceup, short edge first into the ADF tray or facedown on the scanner glass.

**Notes:**

- Do not load postcards, photos, small items, transparencies, photo paper, or thin media (such as magazine clippings) into the ADF tray. Place these items on the scanner glass.
- The ADF indicator light comes on when the paper is loaded properly.

- 2 If you are loading a document into the ADF tray, then adjust the paper guides.

- 3 From the home screen, navigate to:

**Fax** > enter the fax number > **Options**

- 4 From the Resolution area, touch the arrows to select the resolution you want.

**Note:** Select a resolution from Standard (fastest speed) to Ultra Fine (best quality at a reduced speed).

- 5 Touch **Fax It**.

### Making a fax lighter or darker

- 1 Load an original document faceup, short edge first into the ADF tray or facedown on the scanner glass.

**Notes:**

- Do not load postcards, photos, small items, transparencies, photo paper, or thin media (such as magazine clippings) into the ADF tray. Place these items on the scanner glass.
- The ADF indicator light comes on when the paper is loaded properly.

- 2 If you are loading a document into the ADF tray, then adjust the paper guides.

- 3 From the home screen, navigate to:

**Fax** > enter the fax number > **Options**

- 4 Adjust the fax darkness, and then touch **Fax It**.

### Viewing a fax log

- 1 Type the printer IP address into the address field of your Web browser.

**Note:** If you do not know the IP address of the printer, then print a network setup page and locate the IP address in the TCP/IP section.

- 2 Click **Reports**.

- 3 Click **Fax Job Log** or **Fax Call Log**.

### Blocking junk faxes

- 1 Open a Web browser, and then type the printer IP address in the address field.

**Notes:**

- View the printer IP address on the printer home screen. The IP address appears as four sets of numbers separated by periods, such as 123.123.123.123.
- If you are using a proxy server, then temporarily disable it to load the Web page correctly.

**2** Click **Settings > Fax Settings > Analog Fax Setup > Block No Name Fax**.

**Notes:**

- This option blocks all incoming faxes that have a private caller ID or have no fax name.
- In the Banned Fax List field, enter the phone numbers or type the fax names of specific fax callers you want to block.

## Canceling a fax job

**1** From the control panel, touch **Cancel Job** or press  on the keypad.

**2** Touch the job you want to cancel, and then touch **Delete Selected Jobs**.

**Note:** If you press  on the keypad, then touch **Resume** to return to the home screen.

## Holding and forwarding faxes

### Holding faxes

This option lets you hold received faxes from printing until they are released. Held faxes can be released manually or at a scheduled day or time.

**1** Open a Web browser, and then type the printer IP address in the address field.

**Notes:**

- View the printer IP address on the printer home screen. The IP address appears as four sets of numbers separated by periods, such as 123.123.123.123.
- If you are using a proxy server, then temporarily disable it to load the Web page correctly.

**2** Click **Settings > Fax Settings > Analog Fax Setup > Holding Faxes**.

**3** From the Held Fax Mode menu, select one of the following:

- **Off**
- **Always On**
- **Manual**
- **Scheduled**

**4** If you selected Scheduled, then continue with the following steps:

- a** Click **Fax Holding Schedule**.
- b** From the Action menu, select **Hold faxes**.

- c From the Time menu, select the time you want the held faxes released.
- d From the Day(s) menu, select the day you want the held faxes released.

5 Click **Add**.

## Forwarding a fax

This option lets you print and forward received faxes to a fax number, e-mail address, FTP site, or LDSS.

1 Open a Web browser, and then type the printer IP address in the address field.

### Notes:

- View the printer IP address on the printer home screen. The IP address appears as four sets of numbers separated by periods, such as 123.123.123.123.
- If you are using a proxy server, then temporarily disable it to load the Web page correctly.

2 Click **Settings > Fax Settings**.

3 From the Fax Forwarding menu, select **Print, Print and Forward, or Forward**.

4 From the “Forward to” menu, select **Fax, E-mail, FTP, LDSS, or eSF**.

5 In the “Forward to Shortcut” field, enter the shortcut number where you want the fax forwarded.

**Note:** The shortcut number must be valid for the setting selected in the “Forward to” menu.

6 Click **Submit**.

## Understanding the fax options

### Resolution

This option lets you adjust the quality of the fax output. Increasing the image resolution increases the file size and the time needed to scan your original document. Decreasing the image resolution reduces the file size.

Select one of the following:

- **Standard**—Use this when faxing most documents.
- **Fine 200 dpi**—Use this when faxing documents with small prints.
- **Super fine 300 dpi**—Use this when faxing documents with fine details.
- **Ultra fine 600 dpi**—Use this when faxing documents with pictures or photos.

### Darkness

This option lets you adjust how light or dark the faxes are in relation to the original document.

## Page Setup

This option lets you change the following settings:

- **Sides (Duplex)**—This specifies if the original document is printed on one side or on both sides of the page (duplex). This also identifies what needs to be scanned for inclusion in the fax.
- **Orientation**—This specifies the orientation of the original document, and then changes the Sides (Duplex) and Binding settings to match the orientation.
- **Binding**—This specifies if the original document is bound on the long-edge or short-edge side.

## Content

This option lets you specify the content type and source of the original document.

## Delayed Send

This option lets you send a fax at a later time or date.

## Color

This option lets you set the output to either color or monochrome for the scanned image.

## Scan Preview

This option lets you view the first page of the image before it is included in the fax. When the first page is scanned, the scanning is paused and a preview image appears.

**Note:** This option appears only when a working printer hard disk is installed.

## Using the advanced options

Select from the following settings:



- **Advanced Imaging**—This adjusts the Background Removal, Color Balance, Color Dropout, Contrast, Mirror Image, Negative Image, Scan Edge to Edge, Shadow Detail, Sharpness, and Temperature settings before you fax the document.
- **Custom Job**—This combines multiple scanning jobs into a single job.  
**Note:** This option appears only when a formatted, working printer hard disk is installed.
- **Edge Erase**—This removes smudges or marks around the edges of a document. You can choose to remove an equal area around all four sides of the paper, or pick a particular edge. Edge Erase erases whatever is within the area selected, leaving nothing on that portion of the scan.
- **Transmission Log**—This prints the transmission log or transmission error log.

# Scanning

## Using Scan to Network



Scan to Network lets you scan your documents to network destinations specified by your system support person. After the destinations (shared network folders) have been established on the network, the setup process for the application involves installing and configuring the application on the appropriate printer using its Embedded Web Server. For more information, see [“Setting up Scan to Network” on page 24.](#)

## Scanning to an FTP address

Automatic document feeder (ADF)	Scanner glass
 <ul style="list-style-type: none"> <li>• Use the ADF for multiple-page or two-sided documents.</li> <li>• Load the original document faceup.</li> </ul>	 <ul style="list-style-type: none"> <li>• Use the scanner glass for single-page documents, book pages, small items (such as postcards or photos), transparencies, photo paper, or thin media (such as magazine clippings).</li> <li>• Place the document facedown in the corner with the arrow.</li> </ul>

## Creating shortcuts

### Notes:

- Make sure that FTP Shortcuts is set to Display. From the home screen, touch  > **Settings** > **General Settings** > **Home screen customization** > **FTP Shortcuts** > **Display** > **Submit**.
- To delete an FTP shortcut, touch  > **Manage Shortcuts** > **FTP Shortcuts** > the shortcut to delete > **Delete now**.

## Creating an FTP shortcut using the Embedded Web Server

- 1 Open a Web browser, and then type the printer IP address in the address field.



**Notes:**

- View the printer IP address on the printer home screen. The IP address appears as four sets of numbers separated by periods, such as 123.123.123.123.
- If you are using a proxy server, then temporarily disable it to load the Web page correctly.

2 Navigate to:

**Settings** > Other Settings area > **Manage Shortcuts** > **FTP Shortcut Setup**

3 Enter the appropriate information.

**Note:** A password may be required. If you do not have an ID and password, then contact your system support person.

4 Enter a shortcut number.

**Note:** If you enter a number that is already in use, then you are prompted to select another number.

5 Click **Add**.

## Creating an FTP shortcut using the printer control panel

1 From the home screen, navigate to:

**FTP** > **FTP** > type the FTP address >  > type a name for the shortcut > **Done**

2 Verify that the shortcut name and number are correct, and then touch **OK**.

**Notes:**

- If the name or number is incorrect, then touch **Cancel**, and then reenter the information.
- If you enter a number that is already in use, then you are prompted to select another number.

## Scanning to an FTP address

### Scanning to an FTP address using the control panel

1 Load an original document into the ADF tray or on the scanner glass.



2 From the home screen, navigate to:

**FTP** > **FTP** > type the FTP address > **Done** > **Send It**

**Notes:**

- You can also enter the recipient using the shortcut number or address book.
- To add recipients, touch **Next Number**.

## Scanning to a computer or flash drive

Automatic document feeder (ADF)	Scanner glass
 <ul style="list-style-type: none"><li>• Use the ADF for multiple-page or two-sided documents.</li><li>• Load the original document faceup.</li></ul>	 <ul style="list-style-type: none"><li>• Use the scanner glass for single-page documents, book pages, small items (such as postcards or photos), transparencies, photo paper, or thin media (such as magazine clippings).</li><li>• Place the document facedown in the corner with the arrow.</li></ul>

### Setting up Scan to Computer

#### Notes:

- This feature is supported only in Windows Vista or later.
- Make sure your computer and printer are connected to the same network.

**1** Open the printers folder, and then select your printer.

**Note:** If your printer is not in the list, then add your printer.

**2** Open the printer properties, and then adjust the settings as necessary.

**3** From the control panel, touch **Scan to Computer** > select the appropriate scan setting > **Send It**.

### Scanning to a flash drive

**1** Load an original document into the ADF tray or on the scanner glass.

**2** Insert the flash drive into the USB port.

**3** Select the destination folder, and then touch **Scan to USB drive**.

**4** Adjust the scan settings, and then touch **Scan It**.

## Understanding the scan options

### FTP

This option lets you enter the IP address for the FTP destination.

**Note:** An IP address appears as four sets of numbers separated by periods, such as 123.123.123.123.

### File Name

This option lets you type a file name for the scan image.

### Save As Shortcut

This option lets you save the current settings as a shortcut by assigning a shortcut name.

**Note:** Selecting this option automatically assigns the next available shortcut number.

### Original Size

This option lets you set the paper size of the documents you are going to scan. When Original Size is set to Mixed Sizes, you can scan an original document that contains mixed paper sizes (letter- and legal-size pages).

### Darkness

This option lets you adjust how light or dark the scanned documents are in relation to the original document.

### Resolution

This option lets you adjust the output quality of your file. Increasing the image resolution increases the file size and the time needed to scan your original document. Decreasing the image resolution reduces the file size.

### Send As

This option lets you set the output type for the scan image.

Select one of the following:

- **PDF**—Use to create a single file with multiple pages. The PDF can be sent as a secured or compressed file.
- **TIFF**—Use to create multiple files or a single file. If Multi-page TIFF is turned off in the Settings menu, then TIFF saves one page in each file. The file size is usually larger than an equivalent JPEG.
- **JPEG**—Use to create and attach a separate file for each page of the original document.
- **XPS**—Use to create a single XPS file with multiple pages.

### Content

This option lets you specify the content type and source of the original document.

## Page Setup

This option lets you change the following settings:

- **Sides (Duplex)**—This specifies if the original document is printed on only one side or on both sides of the paper.
- **Orientation**—This specifies the orientation of the original document, and then changes the Sides (Duplex) and Binding settings to match the orientation.
- **Binding**—This specifies if the original document is bound on the long-edge or short-edge side.

## Scan Preview

This option lets you view the first page of the image before it is included in the file. When the first page is scanned, the scanning is paused and a preview image appears.

**Note:** This option appears only when a formatted, working printer hard disk is installed.

## Using the advanced options

Select from the following settings:

- **Advanced Imaging**—This adjusts the Background Removal, Color Balance, Color Dropout, Contrast, JPEG Quality, Mirror Image, Negative Image, Scan Edge to Edge, Shadow Detail, Sharpness, and Temperature settings before you scan the document.
- **Custom Job**—This combines multiple scanning jobs into a single job.  
**Note:** This option appears only when a formatted, working printer hard disk is installed.
- **Edge Erase**—This removes smudges or marks around the edges of a document. You can choose to remove an equal area around all four sides of the paper, or pick a particular edge. Edge Erase erases whatever is within the area selected, leaving nothing on that portion of the scan.
- **Transmission Log**—This prints the transmission log or transmission error log.

# Understanding the printer menus

## Menus list

### Paper Menu

Default Source  
 Paper Size/Type  
 Configure MP  
 Substitute Size  
 Paper Texture  
 Paper Loading  
 Custom Types  
 Custom Names  
 Custom Scan Sizes  
 Custom Bin Names  
 Universal Setup  
 Bin Setup

### Reports

Menu Settings Page  
 Device Statistics  
 Stapler Test  
 Network Setup Page  
 Network [x] Setup Page  
 Shortcut List  
 Fax Job Log  
 Fax Call Log  
 Copy Shortcuts  
 E-mail Shortcuts  
 Fax Shortcuts  
 FTP Shortcuts  
 Profiles List  
 Print Fonts  
 Print Directory  
 Print Demo  
 Asset Report  
 Event Log Summary

### Network/Ports

Active NIC  
 Standard Network<sup>1</sup>  
 Standard USB  
 Parallel [x]  
 Serial [x]  
 SMTP Setup

### Security

Edit Security Setups  
 Miscellaneous Security Settings  
 Confidential Print  
 Erase Temporary Data Files  
 Security Audit Log  
 Set Date and Time

### Settings

General Settings  
 Copy Settings  
 Fax Settings  
 E-mail Settings  
 FTP Settings  
 Flash Drive Menu  
 Print Settings

### Help

Print All Guides  
 Copy Guide  
 E-mail Guide  
 Fax Guide  
 FTP Guide  
 Print Defects Guide  
 Information Guide  
 Supplies Guide

### Manage Shortcuts

Fax Shortcuts  
 E-mail Shortcuts  
 FTP Shortcuts  
 Copy Shortcuts  
 Profile Shortcuts

### Option Card Menu<sup>2</sup>

A list of installed DLEs (Download Emulators) appears.

<sup>1</sup> Depending on the printer setup, this menu appears as Standard Network or Network [x].

<sup>2</sup> This menu appears only when one or more DLEs are installed.

## Paper menu

### Default Source menu

Use	To
<b>Default Source</b> Tray [x] Multipurpose Feeder Manual Paper Manual Envelope	Set a default paper source for all print jobs.  <b>Notes:</b> <ul style="list-style-type: none"> <li>• Tray 1 (standard tray) is the factory default setting.</li> <li>• From the Paper menu, set Configure MP to "Cassette" for Multipurpose Feeder to appear as a menu setting.</li> <li>• If two trays contain paper of the same size and type, and the trays have the same settings, then the trays are automatically linked. When one tray is empty, the print job continues using the linked tray.</li> </ul>

### Paper Size/Type menu

Use	To
<b>Tray [x] Size</b> A4 A5 A6 JIS-B5 JIS-B4 Letter Legal 12 x 18 11 x 17 SRA3 A3 Executive Oficio (Mexico) Folio Statement Universal	Specify the paper size loaded in each tray.  <b>Notes:</b> <ul style="list-style-type: none"> <li>• Letter is the U.S. factory default setting. A4 is the international factory default setting.</li> <li>• If two trays contain paper of the same size and type, and the trays have the same settings, then the trays are automatically linked. The multipurpose feeder may also be linked. When one tray is empty, the print job continues using the linked tray.</li> </ul>
<b>Note:</b> Only installed trays and feeders are listed in this menu.	

Use	To
<p><b>Tray [x] Type</b></p> <ul style="list-style-type: none"> <li>Plain Paper</li> <li>Card Stock</li> <li>Transparency</li> <li>Recycled</li> <li>Glossy</li> <li>Heavy Glossy</li> <li>Labels</li> <li>Bond</li> <li>Envelope</li> <li>Rough Envelope</li> <li>Letterhead</li> <li>Preprinted</li> <li>Colored Paper</li> <li>Light Paper</li> <li>Heavy Paper</li> <li>Rough/Cotton</li> <li>Custom Type [x]</li> </ul>	<p>Specify the type of paper loaded in each tray.</p> <p><b>Notes:</b></p> <ul style="list-style-type: none"> <li>• Plain Paper is the factory default setting for Tray 1. Custom Type [x] is the factory default setting for all other trays.</li> <li>• If available, a user-defined name appears instead of Custom Type [x].</li> <li>• Use this menu to configure automatic tray linking.</li> </ul>
<p><b>MP Feeder Size</b></p> <ul style="list-style-type: none"> <li>A4</li> <li>A5</li> <li>A6</li> <li>JIS-B5</li> <li>JIS-B4</li> <li>Letter</li> <li>Legal</li> <li>12 x 18</li> <li>11 x 17</li> <li>SRA3</li> <li>A3</li> <li>Executive</li> <li>Oficio (Mexico)</li> <li>Folio</li> <li>Statement</li> <li>Universal</li> </ul>	<p>Specify the paper size loaded in the multipurpose feeder.</p> <p><b>Notes:</b></p> <ul style="list-style-type: none"> <li>• Letter is the U.S. factory default setting. A4 is the international factory default setting.</li> <li>• From the Paper menu, set Configure MP to “Cassette” for MP Feeder Size to appear as a menu.</li> <li>• The multipurpose feeder does not automatically detect paper size. The paper size value must be set.</li> </ul>
<p><b>Note:</b> Only installed trays and feeders are listed in this menu.</p>	

Use	To
<p><b>MP Feeder Type</b></p> <ul style="list-style-type: none"> <li>Plain Paper</li> <li>Card Stock</li> <li>Transparency</li> <li>Recycled</li> <li>Glossy</li> <li>Heavy Glossy</li> <li>Labels</li> <li>Bond</li> <li>Envelope</li> <li>Rough Envelope</li> <li>Letterhead</li> <li>Preprinted</li> <li>Colored Paper</li> <li>Light Paper</li> <li>Heavy Paper</li> <li>Rough/Cotton</li> <li>Custom Type [x]</li> </ul>	<p>Specify the paper type loaded in the multipurpose feeder.</p> <p><b>Notes:</b></p> <ul style="list-style-type: none"> <li>• Plain Paper is the factory default setting.</li> <li>• From the Paper menu, set Configure to “Cassette” for MP Feeder Type to appear as a menu.</li> </ul>
<p><b>Manual Paper Size</b></p> <ul style="list-style-type: none"> <li>A4</li> <li>A5</li> <li>A6</li> <li>JIS B5</li> <li>Letter</li> <li>Legal</li> <li>Executive</li> <li>Oficio (Mexico)</li> <li>JIS B4</li> <li>A3</li> <li>11 x 17</li> <li>Folio</li> <li>Statement</li> <li>Universal</li> <li>SRA3</li> <li>12 x 18</li> </ul>	<p>Specify the size of the paper being manually loaded.</p> <p><b>Note:</b> Letter is the U.S. factory default setting. A4 is the international factory default setting.</p>
<p><b>Note:</b> Only installed trays and feeders are listed in this menu.</p>	



Use	To
<p><b>Manual Paper Type</b></p> <ul style="list-style-type: none"> <li>Plain Paper</li> <li>Card Stock</li> <li>Transparency</li> <li>Recycled</li> <li>Labels</li> <li>Bond</li> <li>Letterhead</li> <li>Preprinted</li> <li>Colored Paper</li> <li>Light Paper</li> <li>Heavy Paper</li> <li>Rough/Cotton</li> <li>Custom Type [x]</li> </ul>	<p>Specify the paper type being manually loaded.</p> <p><b>Notes:</b></p> <ul style="list-style-type: none"> <li>• Plain Paper is the factory default setting.</li> <li>• From the Paper menu, set Configure MP to “Manual” for Manual Paper Type to appear as a menu.</li> </ul>
<p><b>Manual Envelope Size</b></p> <ul style="list-style-type: none"> <li>7 3/4 Envelope</li> <li>9 Envelope</li> <li>10 Envelope</li> <li>DL Envelope</li> <li>C5 Envelope</li> <li>B5 Envelope</li> <li>Other Envelope</li> </ul>	<p>Specify the envelope size being manually loaded.</p> <p><b>Note:</b> 10 Envelope is the U.S. factory default setting. DL Envelope is the international factory default setting.</p>
<p><b>Manual Envelope Type</b></p> <ul style="list-style-type: none"> <li>Envelope</li> <li>Rough Envelope</li> <li>Custom Type [x]</li> </ul>	<p>Specify the envelope type being manually loaded.</p> <p><b>Note:</b> Envelope is the factory default setting.</p>
<p><b>Note:</b> Only installed trays and feeders are listed in this menu.</p>	

### Configure MP menu

Use	To
<p><b>Configure MP</b></p> <ul style="list-style-type: none"> <li>Cassette</li> <li>Manual</li> <li>First</li> </ul>	<p>Determine when the printer selects paper from the multipurpose feeder.</p> <p><b>Notes:</b></p> <ul style="list-style-type: none"> <li>• Cassette is the factory default setting. Cassette configures the multipurpose feeder as the automatic paper source.</li> <li>• Manual sets the multipurpose feeder only for manual-feed print jobs.</li> <li>• First configures the multipurpose feeder as the primary paper source.</li> </ul>

## Substitute Size menu

Use	To
<b>Substitute Size</b> Off Statement/A5 Letter/A4 11 x 17/A3 All Listed	Substitute a specified paper size if the requested paper size is not available.  <b>Notes:</b> <ul style="list-style-type: none"> <li>• All Listed is the factory default setting. All available substitutions are allowed.</li> <li>• Setting a size substitution lets the print job continue without <b>Change Paper</b> appearing.</li> </ul>

## Paper Texture menu

Use	To
<b>Plain Texture</b> Smooth Normal Rough	Specify the relative texture of the plain paper loaded.  <b>Note:</b> Normal is the factory default setting.
<b>Card Stock Texture</b> Smooth Normal Rough	Specify the relative texture of the card stock loaded.  <b>Notes:</b> <ul style="list-style-type: none"> <li>• Normal is the factory default setting.</li> <li>• The options appear only if card stock is supported.</li> </ul>
<b>Transparency Texture</b> Smooth Normal Rough	Specify the relative texture of the transparencies loaded.  <b>Note:</b> Normal is the factory default setting.
<b>Recycled Texture</b> Smooth Normal Rough	Specify the relative texture of the recycled paper loaded.  <b>Note:</b> Normal is the factory default setting.
<b>Labels Texture</b> Smooth Normal Rough	Specify the relative texture of the labels loaded.  <b>Note:</b> Normal is the factory default setting.
<b>Bond Texture</b> Smooth Normal Rough	Specify the relative texture of the bond paper loaded.  <b>Note:</b> Rough is the factory default setting.
<b>Envelope Texture</b> Smooth Normal Rough	Specify the relative texture of the envelopes loaded.  <b>Note:</b> Normal is the factory default setting.

Use	To
<b>Rough Envelope Texture</b> Rough	Specify the relative texture of the rough envelopes loaded.
<b>Letterhead Texture</b> Smooth Normal Rough	Specify the relative texture of the letterhead loaded. <b>Note:</b> Normal is the factory default setting.
<b>Preprinted Texture</b> Smooth Normal Rough	Specify the relative texture of the preprinted paper loaded. <b>Note:</b> Normal is the factory default setting.
<b>Colored Texture</b> Smooth Normal Rough	Specify the relative texture of the colored paper loaded. <b>Note:</b> Normal is the factory default setting.
<b>Light Texture</b> Smooth Normal Rough	Specify the relative texture of the paper loaded. <b>Note:</b> Normal is the factory default setting.
<b>Heavy Texture</b> Smooth Normal Rough	Specify the relative texture of the paper loaded. <b>Note:</b> Normal is the factory default setting.
<b>Rough/Cotton Texture</b> Rough	Specify the relative texture of the cotton paper loaded.
<b>Custom [x] Texture</b> Smooth Normal Rough	Specify the relative texture of the custom paper loaded. <b>Notes:</b> <ul style="list-style-type: none"> <li>• Normal is the factory default setting.</li> <li>• The options appear only if the custom type is supported.</li> </ul>

## Paper Loading menu

Use	To
<b>Card Stock Loading</b> Duplex Off	Determine and set two-sided printing for all print jobs with Card Stock as the paper type.
<b>Notes:</b> <ul style="list-style-type: none"> <li>• Off is the factory default setting for all Paper Loading menu selections.</li> <li>• Duplex sets the printer default to two-sided printing for every print job unless one-sided printing is selected from Print Properties or the print dialog, depending on your operating system.</li> </ul>	

Use	To
<b>Recycled Loading</b> Duplex Off	Determine and set two-sided printing for all print jobs with Recycled as the paper type.
<b>Glossy Loading</b> Duplex Off	Determine and set two-sided printing for all print jobs with Glossy as the paper type.
<b>Heavy Glossy Loading</b> Duplex Off	Determine and set two-sided printing for all print jobs with Heavy Glossy as the paper type.
<b>Labels Loading</b> Duplex Off	Determine and set two-sided printing for all print jobs with Labels as the paper type.
<b>Bond Loading</b> Duplex Off	Determine and set two-sided printing for all print jobs with Bond as the paper type.
<b>Letterhead Loading</b> Duplex Off	Determine and set two-sided printing for all print jobs with Letterhead as the paper type.
<b>Preprinted Loading</b> Duplex Off	Determine and set two-sided printing for all print jobs with Preprinted as the paper type.
<b>Colored Loading</b> Duplex Off	Determine and set two-sided printing for all print jobs with Colored as the paper type.
<b>Light Loading</b> Duplex Off	Determine and set two-sided printing for all print jobs with Light as the paper type.
<b>Heavy Loading</b> Duplex Off	Determine and set two-sided printing for all print jobs with Heavy as the paper type.
<b>Rough/Cotton Loading</b> Duplex Off	Determine and set two-sided printing for all print jobs with Rough or Cotton as the paper type.
<b>Custom [x] Loading</b> Duplex Off	Determine and set two-sided printing for all print jobs with Custom [x] as the paper type.  <b>Note:</b> Custom [x] Loading is available only when the custom type is supported.

**Notes:**

- Off is the factory default setting for all Paper Loading menu selections.
- Duplex sets the printer default to two-sided printing for every print job unless one-sided printing is selected from Print Properties or the print dialog, depending on your operating system.

## Custom Types menu

Use	To
<b>Custom Type [x]</b> Paper Card Stock Transparency Rough/Cotton Labels Envelope	Associate a paper or specialty media type with a factory default custom type name or a user-defined custom name created from the Embedded Web Server or from MarkVision™ Professional.  <b>Notes:</b> <ul style="list-style-type: none"> <li>• Paper is the factory default setting.</li> <li>• The custom media type must be supported by the selected tray or multipurpose feeder in order to print from that source.</li> </ul>
<b>Recycled</b> Paper Card Stock Transparency Rough/Cotton Labels Envelope	Specify a paper type when Recycled is selected in other menus.  <b>Notes:</b> <ul style="list-style-type: none"> <li>• Paper is the factory default setting.</li> <li>• The custom media type must be supported by the selected tray or multipurpose feeder in order to print from that source.</li> </ul>

## Custom Names menu

Use	To
<b>Custom Name [x]</b>	Specify a custom name for a paper type. This name replaces Custom Type [x] in the printer menus.

## Custom Scan Sizes menu

Use	To
<b>Custom Scan Size [x]</b> Scan Size Name Width 1–11.69 inches (25–297 mm) Height 1–17 inches (22–432 mm) Orientation Portrait Landscape 2 scans per side Off On	Specify a custom scan size name, scan sizes, and options. The custom scan size name replaces Custom Scan Size [x] in the printer menus.

## Custom Bin Names menu

Use	To
<b>Standard Bin</b>	Specify a custom name for the standard bin.

Use	To
<b>Bin [x]</b>	Specify a custom name for Bin [x].

## Universal Setup menu

Use	To
<b>Units of Measure</b> Inches Millimeters	Identify the units of measure.  <b>Notes:</b> <ul style="list-style-type: none"> <li>• Inches is the U.S. factory default setting.</li> <li>• Millimeters is the international factory default setting.</li> </ul>
<b>Portrait Width</b> 3.54–48 inches 89.9–1219 mm	Set the portrait width.  <b>Notes:</b> <ul style="list-style-type: none"> <li>• If the width exceeds the maximum, then the printer uses the maximum width allowed.</li> <li>• 12 inches is the U.S. factory default setting. You can increase the width in 0.01-inch increments.</li> <li>• 305 mm is the international factory default setting. You can increase the width in 1-mm increments.</li> </ul>
<b>Portrait Height</b> 5.5–48 inches 139.7–1219 mm	Set the portrait height.  <b>Notes:</b> <ul style="list-style-type: none"> <li>• If the height exceeds the maximum, then the printer uses the maximum height allowed.</li> <li>• 17 inches is the U.S. factory default setting. You can increase the height in 0.01-inch increments.</li> <li>• 432 mm is the international factory default setting. You can increase the height in 1-mm increments.</li> </ul>
<b>Feed Direction</b> Short Edge Long Edge	Specify the feed direction if the paper can be loaded in either direction.  <b>Notes:</b> <ul style="list-style-type: none"> <li>• Short Edge is the factory default setting.</li> <li>• Long Edge appears only when the longest edge is shorter than the maximum width supported in the tray.</li> </ul>

## Bin Setup menu

Use	To
<b>Output Bin</b> Standard Bin Bin [x]*	Specify the default bin.  <b>Note:</b> Standard Bin is the factory default setting.

\* [x] can be any number from 1 to 4 if the appropriate optional bins are installed. If multiple bins are assigned the same name, then the name appears only once in the bin list.

Use	To
<p><b>Configure Bins</b></p> <ul style="list-style-type: none"> <li>Mailbox</li> <li>Link</li> <li>Link Optional</li> <li>Type Assignment</li> </ul>	<p>Specify configuration options for bins.</p> <p><b>Notes:</b></p> <ul style="list-style-type: none"> <li>• Mailbox is the factory default setting. This treats each bin as a separate mailbox.</li> <li>• Link configures all available bins as one large bin.</li> <li>• Link Optional links together all available bins except the standard bin and only appears when at least two optional bins are installed.</li> <li>• Type Assignment assigns each paper type to a bin or linked bin set.</li> </ul>
<p><b>Overflow Bin</b></p> <ul style="list-style-type: none"> <li>Standard Bin</li> <li>Bin [x]*</li> </ul>	<p>Specify an alternative bin when a designated bin is full.</p> <p><b>Notes:</b></p> <ul style="list-style-type: none"> <li>• This menu appears only when optional bins are installed.</li> <li>• Standard Bin is the factory default setting.</li> </ul>
<p><b>Assign Type/Bin</b></p> <ul style="list-style-type: none"> <li>Plain Paper Bin</li> <li>Card Stock Bin</li> <li>Transparency Bin</li> <li>Recycled Bin</li> <li>Glossy Bin</li> <li>Heavy Glossy Bin</li> <li>Labels Bin</li> <li>Bond Bin</li> <li>Envelope Bin</li> <li>Rough Envelope Bin</li> <li>Letterhead Bin</li> <li>Preprinted Bin</li> <li>Colored Bin</li> <li>Light Paper Bin</li> <li>Heavy Paper Bin</li> <li>Rough/Cotton Bin</li> <li>Custom [x] Bin</li> </ul>	<p>Select a bin for each supported paper type.</p> <p>For each type, select from the following options:</p> <ul style="list-style-type: none"> <li>Disabled</li> <li>Standard Bin</li> <li>Bin [x]*</li> </ul> <p><b>Note:</b> Disabled is the factory default setting.</p>
<p>* [x] can be any number from 1 to 4 if the appropriate optional bins are installed. If multiple bins are assigned the same name, then the name appears only once in the bin list.</p>	

## Reports menu

### Reports menu

Use	To
<b>Menu Settings Page</b>	Print a report containing information about the paper loaded in trays, installed memory, total page count, alarm settings, timeouts, control panel language, TCP/IP address, status of supplies, status of the network connection, and other information.
<b>Device Statistics</b>	Print a report containing printer statistics such as supply information and number of printed pages.
<b>Stapler Test</b>	Print a report that confirms that the staple finisher is functioning properly. <b>Note:</b> This menu item appears only when a supported staple finisher is installed.
<b>Network Setup Page</b>	Print a report containing information about the network printer settings, such as the TCP/IP address information. <b>Note:</b> This menu item appears only in network printers or printers connected to print servers.
<b>Network [x] Setup Page</b>	Print a report containing information about the network printer settings, such as the TCP/IP address information. <b>Note:</b> This menu item appears only in network printers or in printers connected to print servers, and when there is more than one network option installed.
<b>Shortcut List</b>	Print a report containing information about configured shortcuts.
<b>Fax Job Log</b>	Print a report containing information about the last 200 completed faxes. <b>Note:</b> This menu item appears only when Enable Job Log in the Fax Settings menu is set to On.
<b>Fax Call Log</b>	Print a report containing information about the last 100 attempted, received, and blocked calls. <b>Note:</b> This menu item appears only when Enable Job Log in the Fax Settings menu is set to On.
<b>Copy Shortcuts</b>	Print a report containing information about copy shortcuts.
<b>E-mail Shortcuts</b>	Print a report containing information about e-mail shortcuts.
<b>Fax Shortcuts</b>	Print a report containing information about fax shortcuts.
<b>FTP Shortcuts</b>	Print a report containing information about FTP shortcuts.
<b>Profiles List</b>	Print a list of profiles stored in the printer.
<b>Print Fonts</b>	Print a report of all the fonts available for the printer language currently set in the printer.



Use	To
<b>Print Directory</b>	Print a list of all the resources stored in an optional flash memory card or printer hard disk.  <b>Notes:</b> <ul style="list-style-type: none"> <li>• Job Buffer Size must be set to 100%.</li> <li>• Make sure that the flash memory or hard disk is working and installed correctly.</li> </ul>
<b>Asset Report</b>	Print a report containing asset information including the printer serial number and model name.

## Network/Ports menu

### Active NIC menu

Use	To
<b>Active NIC</b> Auto [list of available network cards]	Allow the printer to connect to a network.  <b>Notes:</b> <ul style="list-style-type: none"> <li>• Auto is the factory default setting.</li> <li>• This menu item appears only if an optional network adapter is installed.</li> </ul>

### Standard Network or Network [x] menu

**Note:** Only active ports appear in this menu.

Use	To
<b>Energy Efficient Ethernet</b> Enable Disable	Reduce power consumption when the printer receives no data from the Ethernet network.  <b>Note:</b> Enable is the factory default setting.
<b>PCL SmartSwitch</b> On Off	Set the printer to automatically switch to PCL emulation when a print job requires it, regardless of the default printer language.  <b>Notes:</b> <ul style="list-style-type: none"> <li>• On is the factory default setting.</li> <li>• If PCL SmartSwitch is disabled, then the printer does not examine incoming data and it uses the default printer language specified in the Setup menu.</li> </ul>
<b>PS SmartSwitch</b> On Off	Set the printer to automatically switch to PS emulation when a print job requires it, regardless of the default printer language.  <b>Notes:</b> <ul style="list-style-type: none"> <li>• On is the factory default setting.</li> <li>• If PS SmartSwitch is disabled, then the printer does not examine incoming data and it uses the default printer language specified in the Setup menu.</li> </ul>

Use	To
<b>NPA Mode</b> Off Auto	Set the printer to perform the special processing required for bidirectional communication following the conventions defined by the NPA protocol.  <b>Notes:</b> <ul style="list-style-type: none"> <li>• Auto is the factory default setting.</li> <li>• The printer automatically restarts when the setting is changed from the control panel.</li> </ul>
<b>Network Buffer</b> Auto 3KB to [maximum size allowed]	Set the size of the network input buffer.  <b>Notes:</b> <ul style="list-style-type: none"> <li>• Auto is the factory default setting.</li> <li>• The maximum size allowed depends on the amount of memory in the printer, the size of the other link buffers, and whether Resource Save is set to On or Off.</li> <li>• To increase the maximum size range for the Network Buffer, disable or reduce the size of the parallel, serial, and USB buffers.</li> <li>• The printer automatically restarts when the setting is changed from the control panel.</li> </ul>
<b>Job Buffering</b> Off On Auto	Temporarily store print jobs in the printer hard disk before printing. This menu only appears when a formatted disk is installed.  <b>Notes:</b> <ul style="list-style-type: none"> <li>• Off is the factory default setting.</li> <li>• The printer automatically restarts when the setting is changed from the control panel. The menu selection is then updated.</li> </ul>
<b>Mac Binary PS</b> On Off Auto	Set the printer to process Macintosh binary PostScript print jobs.  <b>Note:</b> Auto is the factory default setting.
<b>Standard Network Setup OR Network [x] Setup</b> Reports Network Card TCP/IP IPv6 Wireless AppleTalk	Show and set the printer network settings.  <b>Note:</b> The Wireless menu appears only when the printer is connected to a wireless network.

## Reports menu

To access the menu, navigate to either of the following:

- **Network/Ports > Standard Network > Standard Network Setup > Reports**
- **Network/Ports > Network [x] > Network [x] Setup > Reports**

Use	To
<b>Print Setup Page</b>	Print a report containing information about the network printer settings, such as the TCP/IP address.

## Network Card menu

To access the menu, navigate to either of the following:

- **Network/Ports > Standard Network > Standard Network Setup > Network Card**
- **Network/Ports > Network [x] > Network [x] Setup > Network Card**

Use	To
<b>View Card Status</b> Connected Disconnected	View the connection status of the wireless network adapter.
<b>View Card Speed</b>	View the speed of an active wireless network adapter.
<b>Network Address</b> UAA LAA	View the network addresses.
<b>Job Timeout</b> 0, 10–225 seconds	Set the amount of time it takes for a network print job to be canceled. <b>Notes:</b> <ul style="list-style-type: none"> <li>• “90 seconds” is the factory default setting.</li> <li>• A setting value of 0 disables the timeout.</li> <li>• If a value between 1 and 9 is selected, then <b>Invalid</b> appears on the display, and the value is not saved.</li> </ul>
<b>Banner Page</b> Off On	Allow the printer to print a banner page. <b>Note:</b> Off is the factory default setting.

## TCP/IP menu

To access the menu, navigate to either of the following:

- **Network/Ports > Standard Network > Standard Network Setup > TCP/IP**
- **Network/Ports > Network [x] > Network [x] Setup > TCP/IP**

**Note:** This menu is available only in network printers or printers attached to print servers.

Use	To
<b>Set Hostname</b>	Set the current TCP/IP host name. <b>Note:</b> This can be changed only from the Embedded Web Server.
<b>IP Address</b>	View or change the current TCP/IP address. <b>Note:</b> Manually setting the IP address sets the Enable DHCP and Enable Auto IP settings to Off. It also sets Enable BOOTP and Enable RARP to Off on systems that support BOOTP and RARP.
<b>Netmask</b>	View or change the current TCP/IP netmask.

Use	To
<b>Gateway</b>	View or change the current TCP/IP gateway.
<b>Enable DHCP</b> On Off	Specify the DHCP address and parameter assignment. <b>Note:</b> On is the factory default setting.
<b>Enable RARP</b> On Off	Specify the RARP address assignment setting. <b>Note:</b> Off is the factory default setting.
<b>Enable BOOTP</b> On Off	Specify the BOOTP address assignment setting. <b>Note:</b> On is the factory default setting.
<b>Enable AutoIP</b> Yes No	Specify the Zero Configuration Networking setting. <b>Note:</b> Yes is the factory default setting.
<b>Enable FTP/TFTP</b> Yes No	Enable the built-in FTP server, which lets you send files to the printer using File Transfer Protocol. <b>Note:</b> Yes is the factory default setting.
<b>Enable HTTP Server</b> Yes No	Enable the built-in Web server (Embedded Web Server). When enabled, the printer can be monitored and managed remotely using a Web browser. <b>Note:</b> Yes is the factory default setting.
<b>WINS Server Address</b>	View or change the current WINS server address.
<b>Enable DDNS</b> Yes No	View or change the current DDNS setting. <b>Note:</b> Yes is the factory default setting.
<b>Enable mDNS</b> Yes No	View or change the current mDNS setting. <b>Note:</b> Yes is the factory default setting.
<b>DNS Server Address</b>	View or change the current DNS server address.
<b>Backup DNS Server Address</b>	View or change the backup DNS server addresses.
<b>Backup DNS Server Address 2</b>	
<b>Backup DNS Server Address 3</b>	
<b>Enable HTTPS</b> Yes No	View or change the current HTTPS setting. <b>Note:</b> Yes is the factory default setting.

## IPv6 menu

To access the menu, navigate to any of the following:

- **Network/Ports menu > Standard Network > Standard Network Setup > IPv6**
- **Network/Ports menu > Network [x] > Network [x] Setup > IPv6**

**Note:** This menu is available only in network printers or printers that are attached to print servers.

Use	To
<b>Enable IPv6</b> On Off	Enable IPv6 in the printer. <b>Note:</b> On is the factory default setting.
<b>Auto Configuration</b> On Off	Specify whether or not the network adapter accepts the automatic IPv6 address configuration entries provided by a router. <b>Note:</b> On is the factory default setting.
<b>Set Hostname</b>	Set the host name.
<b>View Address</b>	<b>Note:</b> These settings can be changed only from the Embedded Web Server.
<b>View Router Address</b>	
<b>Enable DHCPv6</b> On Off	Enable DHCPv6 in the printer. <b>Note:</b> On is the factory default setting.

## Wireless menu

**Note:** This menu is available only in printers connected to a wireless network or printer models that have a wireless network adapter.

To access the menu, navigate to:

**Network/Ports > Network [x] > Network [x] Setup > Wireless**

Use	To
<b>Wi-Fi Protected Setup</b> Start Push Button Method Start PIN Method	Establish a wireless network and enable network security. <b>Notes:</b> <ul style="list-style-type: none"> <li>Start Push Button Method connects the printer to a wireless network when buttons on both the printer and the access point (wireless router) are pressed within a given period of time.</li> <li>Start PIN Method connects the printer to a wireless network when a PIN on the printer is entered into the wireless settings of the access point.</li> </ul>
<b>Enable/Disable WPS Auto-detection</b> Enable Disable	Automatically detect the connection method that an access point with WPS uses—Start Push Button Method or Start PIN Method. <b>Note:</b> Disable is the factory default setting.
<b>Network Mode</b> BSS Type Infrastructure Ad hoc	Specify the network mode. <b>Notes:</b> <ul style="list-style-type: none"> <li>Infrastructure is the factory default setting. This lets the printer access a network using an access point.</li> <li>Ad hoc configures wireless connection directly between the printer and a computer.</li> </ul>
<b>Compatibility</b> 802.11b/g 802.11b/g/n	Specify the wireless standard for the wireless network. <b>Note:</b> 802.11b/g/n is the factory default setting.

Use	To
<b>Choose Network</b>	Select an available network for the printer to use.
<b>View Signal Quality</b>	View the quality of the wireless connection.
<b>View Security Mode</b>	View the encryption method for the wireless network.

## AppleTalk menu

To access the menu, navigate to either of the following:

- **Network/Ports > Standard Network > Standard Network Setup > AppleTalk**
- **Network/Ports > Network [x] > Network [x] Setup > AppleTalk**

Use	To
<b>Activate</b> Yes No	Enable or disable AppleTalk support. <b>Note:</b> No is the factory default setting.
<b>View Name</b>	Show the assigned AppleTalk name. <b>Note:</b> The AppleTalk name can be changed only from the Embedded Web Server.
<b>View Address</b>	Show the assigned AppleTalk address. <b>Note:</b> The AppleTalk address can be changed only from the Embedded Web Server.
<b>Set Zone</b> [list of zones available on the network]	Provide a list of AppleTalk zones available on the network. <b>Note:</b> The default zone for the network is the factory default setting.

## Standard USB menu

Use	To
<b>PCL SmartSwitch</b> On Off	Set the printer to automatically switch to PCL emulation when a print job received through a USB port requires it, regardless of the default printer language. <b>Notes:</b> <ul style="list-style-type: none"> <li>• On is the factory default setting.</li> <li>• When set to Off, the printer does not examine incoming data. The printer uses PostScript emulation if the PS SmartSwitch is set to On. It uses the default printer language specified in the Setup menu if the PS SmartSwitch is set to Off.</li> </ul>
<b>PS SmartSwitch</b> On Off	Set the printer to automatically switch to PS emulation when a print job received through a USB port requires it, regardless of the default printer language. <b>Notes:</b> <ul style="list-style-type: none"> <li>• On is the factory default setting.</li> <li>• When set to Off, the printer does not examine incoming data. The printer uses PCL emulation if the PCL SmartSwitch is set to On. It uses the default printer language specified in the Setup menu if the PCL SmartSwitch is set to Off.</li> </ul>

Use	To
<b>NPA Mode</b> On Off Auto	Set the printer to perform the special processing required for bidirectional communication following the conventions defined by the NPA protocol.  <b>Notes:</b> <ul style="list-style-type: none"> <li>• Auto is the factory default setting. Auto sets the printer to examine data, determine the format, and then process it appropriately.</li> <li>• The printer automatically restarts when changing the setting from the printer control panel. The menu selection is then updated.</li> </ul>
<b>USB Buffer</b> Disabled Auto 3K to [maximum size allowed]	Set the size of the USB input buffer.  <b>Notes:</b> <ul style="list-style-type: none"> <li>• Auto is the factory default setting.</li> <li>• Disabled turns off job buffering. Any jobs already buffered on the printer hard disk are printed before normal processing resumes.</li> <li>• The USB buffer size value can be changed in 1-K increments.</li> <li>• The maximum size allowed depends on the amount of memory in the printer, the size of the other link buffers, and whether Resource Save is set to On or Off.</li> <li>• To increase the maximum size range for the USB Buffer, disable or reduce the size of the parallel, serial, and network buffers.</li> <li>• The printer automatically restarts when the setting is changed from the printer control panel. The menu selection is then updated.</li> </ul>
<b>Job Buffering</b> Off On Auto	Temporarily store print jobs in the printer hard disk before printing.  <b>Notes:</b> <ul style="list-style-type: none"> <li>• Off is the factory default setting.</li> <li>• On buffers jobs on the printer hard disk.</li> <li>• Auto buffers print jobs only if the printer is busy processing data from another input port.</li> <li>• Changing this setting from the printer control panel and then exiting the menus causes the printer to restart. The menu selection is then updated.</li> </ul>
<b>Mac Binary PS</b> On Off Auto	Set the printer to process Macintosh binary PostScript print jobs.  <b>Notes:</b> <ul style="list-style-type: none"> <li>• Auto is the factory default setting.</li> <li>• On processes raw binary PostScript print jobs.</li> <li>• Off filters print jobs using the standard protocol.</li> </ul>
<b>ENA Address</b> YYY.YYY.YYY.YYY	Set the network address information for an external print server.  <b>Note:</b> This menu is available only when the printer is attached to an external print server through the USB port.
<b>ENA Netmask</b> YYY.YYY.YYY.YYY	Set the netmask information for an external print server.  <b>Note:</b> This menu is available only when the printer is attached to an external print server through the USB port.

Use	To
<b>ENA Gateway</b> YYY.YYY.YYY.YYY	Set the gateway information for an external print server. <b>Note:</b> This menu is available only when the printer is attached to an external print server through the USB port.

## Parallel [x] menu

**Note:** This menu appears only when an optional parallel card is installed.

Use	To
<b>PCL SmartSwitch</b> On Off	Set the printer to automatically switch to PCL emulation when a print job received through a serial port requires it, regardless of the default printer language. <b>Notes:</b> <ul style="list-style-type: none"> <li>• On is the factory default setting.</li> <li>• When set to Off, the printer does not examine incoming data. The printer uses PostScript emulation if PS SmartSwitch is set to On. It uses the default printer language specified in the Setup menu if PS SmartSwitch is set to Off.</li> </ul>
<b>PS SmartSwitch</b> On Off	Set the printer to automatically switch to PS emulation when a print job received through a serial port requires it, regardless of the default printer language. <b>Notes:</b> <ul style="list-style-type: none"> <li>• On is the factory default setting.</li> <li>• When set to Off, the printer does not examine incoming data. The printer uses PCL emulation if PCL SmartSwitch is set to On. It uses the default printer language specified in the Setup menu if PCL SmartSwitch is set to Off.</li> </ul>
<b>NPA Mode</b> On Off Auto	Set the printer to perform the special processing required for bidirectional communication following the conventions defined by the NPA protocol. <b>Notes:</b> <ul style="list-style-type: none"> <li>• Auto is the factory default setting.</li> <li>• Changing this setting from the printer control panel and then exiting the menus causes the printer to restart. The menu selection is then updated.</li> </ul>
<b>Parallel Buffer</b> Disabled Auto 3K to [maximum size allowed]	Set the size of the parallel input buffer. <b>Notes:</b> <ul style="list-style-type: none"> <li>• Auto is the factory default setting.</li> <li>• Disabled turns off job buffering. Any print jobs already buffered on the printer hard disk are printed before normal processing resumes.</li> <li>• The parallel buffer size setting can be changed in 1-KB increments.</li> <li>• The maximum size allowed depends on the amount of memory in the printer, the size of the other link buffers, and whether Resource Save is set to On or Off.</li> <li>• To increase the maximum size range for the Parallel Buffer, disable or reduce the size of the USB, serial, and network buffers.</li> <li>• Changing this setting from the printer control panel and then exiting the menus causes the printer to restart. The menu selection is then updated.</li> </ul>



Use	To
<b>Job Buffering</b> Off On Auto	Temporarily store print jobs on the printer hard disk before printing. <b>Notes:</b> <ul style="list-style-type: none"> <li>• Off is the factory default setting.</li> <li>• On buffers print jobs on the printer hard disk.</li> <li>• Auto buffers print jobs only if the printer is busy processing data from another input port.</li> <li>• Changing this setting from the printer control panel and then exiting the menus causes the printer to restart. The menu selection is then updated.</li> </ul>
<b>Advanced Status</b> On Off	Enable bidirectional communication through the parallel port. <b>Notes:</b> <ul style="list-style-type: none"> <li>• On is the factory default setting.</li> <li>• Off disables parallel port negotiation.</li> </ul>
<b>Protocol</b> Standard Fastbytes	Specify the parallel port protocol. <b>Notes:</b> <ul style="list-style-type: none"> <li>• Fastbytes is the factory default setting. It provides compatibility with most existing parallel ports and is the recommended setting.</li> <li>• Standard tries to resolve parallel port communication problems.</li> </ul>
<b>Honor Init</b> On Off	Determine if the printer honors printer hardware initialization requests from the computer. <b>Notes:</b> <ul style="list-style-type: none"> <li>• Off is the factory default setting.</li> <li>• The computer requests initialization by activating the Init signal from the parallel port. Many personal computers activate the Init signal each time the computer is turned on.</li> </ul>
<b>Parallel Mode 2</b> On Off	Determine if the parallel port data is sampled on the leading or trailing edge of a strobe. <b>Note:</b> On is the factory default setting.
<b>Mac Binary PS</b> On Off Auto	Set the printer to process Macintosh binary PostScript print jobs. <b>Notes:</b> <ul style="list-style-type: none"> <li>• Auto is the factory default setting.</li> <li>• Off filters print jobs using the standard protocol.</li> <li>• On processes raw binary PostScript print jobs.</li> </ul>
<b>ENA Address</b> YYY·YYY·YYY·YYY	Set the network address information for an external print server. <b>Note:</b> This menu item is available only if the printer is attached to an external print server through the USB port.
<b>ENA Netmask</b> YYY·YYY·YYY·YYY	Set the netmask information for an external print server. <b>Note:</b> This menu item is available only if the printer is attached to an external print server through the USB port.

Use	To
<b>ENA Gateway</b> YYY.YYY.YYY.YYY	Set the gateway information for an external print server. <b>Note:</b> This menu item is available only if the printer is attached to an external print server through the USB port.

## Serial [x] menu

**Note:** This menu appears only when an optional serial card is installed.

Use	To
<b>PCL SmartSwitch</b> On Off	Set the printer to automatically switch to PCL emulation when a print job received through a serial port requires it, regardless of the default printer language. <b>Notes:</b> <ul style="list-style-type: none"> <li>• On is the factory default setting.</li> <li>• When set to Off, the printer does not examine incoming data. The printer uses PostScript emulation if PS SmartSwitch is set to On. It uses the default printer language specified in the Setup menu if PS SmartSwitch is set to Off.</li> </ul>
<b>PS SmartSwitch</b> On Off	Set the printer to automatically switch to PS emulation when a print job received through a serial port requires it, regardless of the default printer language. <b>Notes:</b> <ul style="list-style-type: none"> <li>• On is the factory default setting.</li> <li>• When set to Off, the printer does not examine incoming data. The printer uses PCL emulation if PCL SmartSwitch is set to On. It uses the default printer language specified in the Setup menu if PCL SmartSwitch is set to Off.</li> </ul>
<b>NPA Mode</b> On Off Auto	Set the printer to perform the special processing required for bidirectional communication following the conventions defined by the NPA protocol. <b>Notes:</b> <ul style="list-style-type: none"> <li>• Auto is the factory default setting. Auto sets the printer to examine data, determine the format, and then processes it appropriately.</li> <li>• When set to On, the printer performs NPA processing. If the data is not in NPA format, it is rejected as bad data.</li> <li>• When set to Off, the printer does not perform NPA processing.</li> <li>• Changing this setting from the printer control panel and then exiting the menus causes the printer to restart. The menu selection is then updated.</li> </ul>

Use	To
<b>Serial Buffer</b> Disabled Auto 3K to [maximum size allowed]	Set the size of the serial input buffer. <b>Notes:</b> <ul style="list-style-type: none"> <li>• Auto is the factory default setting.</li> <li>• Disabled turns off job buffering. Any jobs already buffered on the disk are printed before normal processing is resumed.</li> <li>• The serial buffer size setting can be changed in 1-KB increments.</li> <li>• The maximum size allowed depends on the amount of memory in the printer, the size of the other link buffers, and whether Resource Save is set to On or Off.</li> <li>• To increase the maximum size range for the Serial Buffer, disable or reduce the size of the parallel, serial, and network buffers.</li> <li>• Changing this setting from the printer control panel and then exiting the menus causes the printer to restart. The menu selection is then updated.</li> </ul>
<b>Job Buffering</b> Off On Auto	Temporarily store print jobs on the printer hard disk before printing. <b>Notes:</b> <ul style="list-style-type: none"> <li>• Off is the factory default setting. The printer does not buffer print jobs on the printer hard disk.</li> <li>• On buffers print jobs on the printer hard disk.</li> <li>• Auto buffers print jobs only if the printer is busy processing data from another input port.</li> <li>• Changing this setting from the printer control panel and then exiting the menus causes the printer to restart. The menu selection is then updated.</li> </ul>
<b>Protocol</b> DTR DTR/DSR XON/XOFF XON/XOFF/DTR XONXOFF/DTRDSR	Select the hardware and software handshaking settings for the serial port. <b>Notes:</b> <ul style="list-style-type: none"> <li>• DTR is the factory default setting.</li> <li>• DTR/DSR is a hardware handshaking setting.</li> <li>• XON/XOFF is a software handshaking setting.</li> <li>• XON/XOFF/DTR and XON/XOFF/DTR/DSR are combined hardware and software handshaking settings.</li> </ul>
<b>Robust XON</b> On Off	Determine whether the printer communicates availability to the computer. <b>Notes:</b> <ul style="list-style-type: none"> <li>• Off is the factory default setting.</li> <li>• This menu item applies only to the serial port if Serial Protocol is set to XON/XOFF.</li> </ul>

Use	To
<b>Baud</b> 1200 2400 4800 9600 19200 38400 57600 115200 138200 172800 230400 345600	Specify the rate at which data can be received through the serial port.  <b>Notes:</b> <ul style="list-style-type: none"> <li>• 9600 is the factory default setting.</li> <li>• 138200, 172800, 230400, and 345600 baud rates are only displayed in the Standard Serial menu. These settings do not appear in the Serial Option 1, Serial Option 2, or Serial Option 3 menus.</li> </ul>
<b>Data Bits</b> 7 8	Specify the number of data bits sent in each transmission frame.  <b>Note:</b> 8 is the factory default setting.
<b>Parity</b> Even Odd None Ignore	Set the parity for serial input and output data frames.  <b>Note:</b> None is the factory default setting.
<b>Honor DSR</b> On Off	Determine whether the printer uses the DSR Signal.  <b>Notes:</b> <ul style="list-style-type: none"> <li>• Off is the factory default setting.</li> <li>• DSR is a handshaking signal used by most serial cables. The serial port uses DSR to distinguish data sent by the computer from data created by electrical noise in the serial cable. The electrical noise can cause stray characters to print. Set this to On to prevent stray characters from printing.</li> </ul>

## SMTP Setup menu

Use	To
<b>Primary SMTP Gateway</b>	Specify SMTP server gateway and port information.  <b>Note:</b> 25 is the default SMTP gateway port.
<b>Primary SMTP Gateway Port</b>	
<b>Secondary SMTP Gateway</b>	
<b>Secondary SMTP Gateway Port</b>	
<b>SMTP Timeout</b> 5–30	Specify the amount of time in seconds before the server stops trying to send an e-mail.  <b>Note:</b> 30 seconds is the factory default setting.
<b>Reply Address</b>	Specify a reply address of up to 128 characters in the e-mail sent by the printer.

Use	To
<b>Use SSL</b> Disabled Negotiate Required	Set the printer to use SSL for increased security when connecting to the SMTP server.  <b>Notes:</b> <ul style="list-style-type: none"> <li>• Disabled is the factory default setting.</li> <li>• When the Negotiate setting is used, the SMTP server determines if SSL will be used.</li> </ul>
<b>SMTP Server Authentication</b> No authentication required Login/Plain CRAM-MD5 Digest-MD5 NTLM Kerberos 5	Specify the type of user authentication required for scan-to e-mail privileges.  <b>Note:</b> “No authentication required” is the factory default setting.
<b>Device-Initiated E-mail</b> None Use Device SMTP Credentials	Specify what credentials will be used when communicating to the SMTP server. Some SMTP servers require credentials to send an e-mail.  <b>Notes:</b> <ul style="list-style-type: none"> <li>• None is the factory default setting for Device-Initiated E-mail and User-Initiated E-mail.</li> <li>• Device Userid and Device Password are used to log in to the SMTP server when Use Device SMTP Credentials is selected.</li> </ul>
<b>User-Initiated E-mail*</b> None Use Device SMTP Credentials Use Session User ID & Password Use Session E-mail address & Password Prompt User	
<b>Device Userid</b>	
<b>Device Password</b>	
<b>Kerberos 5 Realm</b>	
<b>NTLM Domain</b>	

## Security menu

### Edit Security Setups menu

Use	To
<b>Edit Backup Password</b> Use Backup Password Off On Password	Create a backup password.  <b>Notes:</b> <ul style="list-style-type: none"> <li>• Off is the factory default setting for Use Backup Password.</li> <li>• This menu item appears only if a backup password exists.</li> </ul>

Use	To
<p><b>Edit Building Blocks</b></p> <ul style="list-style-type: none"> <li>Internal Accounts</li> <li>NTLM</li> <li>Simple Kerberos Setup</li> <li>Kerberos Setup</li> <li>Active Directory</li> <li>LDAP</li> <li>LDAP+GSSAPI</li> <li>Password</li> <li>PIN</li> </ul>	<p>Edit settings for Internal Accounts, NTLM, Simple Kerberos Setup, Kerberos Setup, Active Directory, LDAP, Password, and PIN.</p>
<p><b>Edit Security Templates</b></p> <p>[list of available templates]</p>	<p>Add or edit a security template.</p>
<p><b>Edit Access Controls</b></p> <ul style="list-style-type: none"> <li>Administrative Menus</li> <li>Function Access</li> <li>Apps Configuration</li> <li>Management</li> <li>Solutions</li> <li>Cancel jobs at the Device</li> </ul>	<p>Control access to printer menus, firmware updates, held jobs, and other access points.</p>

### Miscellaneous Security Settings menu

Use	To
<p><b>Login Restrictions</b></p> <ul style="list-style-type: none"> <li>Login failures</li> <li>Failure time frame</li> <li>Lockout time</li> <li>Panel Login Timeout</li> <li>Remote Login Timeout</li> </ul>	<p>Limit the number and time frames of failed login attempts from the printer control panel before <i>all</i> users are locked out.</p> <p><b>Notes:</b></p> <ul style="list-style-type: none"> <li>• “Login failures” specifies the number of failed login attempts before users are locked out. Settings range from 1 to 10 attempts. “3 attempts” is the factory default setting.</li> <li>• “Failure time frame” specifies the time frame during which failed login attempts can be made before users are locked out. Settings range from 1 to 60 minutes. “5 minutes” is the factory default setting.</li> <li>• “Lockout time” specifies how long users are locked out after exceeding the login failures limit. Settings range from 1 to 60 minutes. “5 minutes” is the factory default setting. 1 indicates that the printer does not impose a lockout time.</li> <li>• Panel Login Timeout specifies how long the printer remains idle on the home screen before automatically logging off the user. Settings range from 1 to 900 seconds. “30 seconds” is the factory default setting.</li> <li>• Remote Login Timeout specifies how long a remote interface remains idle before automatically logging off the user. Settings range from 1 to 120 minutes. “10 minutes” is the factory default setting.</li> </ul>

Use	To
<b>Security Reset Jumper</b> No Effect Access controls="No Security" Reset factory security defaults	Adjust the security settings. <b>Notes:</b> <ul style="list-style-type: none"> <li>• No Effect means the reset has no effect on the printer security configuration.</li> <li>• Access controls='No Security' retains all the security information that the user has defined. No Security is the factory default setting.</li> <li>• "Reset factory security defaults" deletes all security information that the user has defined, and restores the factory default settings in the Miscellaneous Security menu.</li> </ul>
<b>LDAP Certificate Verification</b> Demand Try Allow Never	Allow the user to request a server certificate. <b>Notes:</b> <ul style="list-style-type: none"> <li>• "Demand" is the factory default setting. This means a server certificate is requested. If a bad certificate is provided or if no certificate is provided, then the session is terminated immediately.</li> <li>• "Try" means a server certificate is requested. If no certificate is provided, then the session proceeds normally. If a bad certificate is provided, then the session is terminated immediately.</li> <li>• "Allow" means a server certificate is requested. If no certificate is provided, then the session proceeds normally. If a bad certificate is provided, then it will be ignored and the session proceeds normally.</li> <li>• "Never" means no server certificate is requested.</li> </ul>
<b>Minimum PIN Length</b> 1–16	Limit the digit length of the personal identification number (PIN). <b>Note:</b> 4 is the factory default setting.

## Confidential Print menu

Use	To
<b>Max Invalid PIN</b> Off 2–10	Set a limit on the number of times an invalid PIN can be entered. <b>Notes:</b> <ul style="list-style-type: none"> <li>• This menu item appears only when a formatted, working printer hard disk is installed.</li> <li>• When the limit is reached, the print jobs for that user name and PIN are deleted.</li> </ul>
<b>Confidential Job Expiration</b> Off 1 hour 4 hours 24 hours 1 week	Set a limit on how long the printer stores confidential print jobs. <b>Notes:</b> <ul style="list-style-type: none"> <li>• If the "Confidential Job Expiration" setting is changed while confidential print jobs reside in the printer memory or printer hard disk, then the expiration time for those print jobs does not change to the new default value.</li> <li>• If the printer is turned off, then all confidential jobs held in the printer memory are deleted.</li> </ul>
<b>Note:</b> Off is the factory default setting.	

Use	To
<b>Repeat Job Expiration</b> Off 1 hour 4 hours 24 hours 1 week	Set a limit on how long the printer stores print jobs.
<b>Verify Job Expiration</b> Off 1 hour 4 hours 24 hours 1 week	Set a limit on how long the printer stores print jobs needing verification.
<b>Reserve Job Expiration</b> Off 1 hour 4 hours 24 hours 1 week	Set a limit on how long the printer stores print jobs for printing at a later time.
<b>Note:</b> Off is the factory default setting.	

## Erase Temporary Data Files menu

Erase Temporary Data Files deletes *only* print job data on the printer hard disk that *are not* currently in use by the file system. All permanent data on the printer hard disk are preserved, such as downloaded fonts, macros, and held jobs.

**Note:** This menu appears only when a formatted, working printer hard disk is installed.

Use	To
<b>Wiping Mode</b> Auto	Specify the mode for erasing temporary data files.
<b>Automatic Method</b> Single pass Multiple pass	Mark all disk space used by a previous print job. This method does not permit the file system to reuse this space until it has been cleared.  <b>Notes:</b> <ul style="list-style-type: none"> <li>• “Single pass” is the factory default setting.</li> <li>• Only automatic wiping enables users to erase temporary data files without having to turn off the printer for an extended amount of time.</li> <li>• Highly confidential information should be erased using <i>only</i> the Multiple pass method.</li> </ul>



## Security Audit Log menu

Use	To
<b>Export Log</b>	Enable an authorized user to export the security log.  <b>Notes:</b> <ul style="list-style-type: none"> <li>• To export the log from the printer control panel, attach a flash drive to the printer.</li> <li>• To export the log from the Embedded Web Server, download the log to a computer.</li> </ul>
<b>Delete Log</b> Yes No	Specify whether audit logs are deleted.
<b>Configure Log</b> Enable Audit Yes No Enable Remote Syslog No Yes Remote Syslog Server [256 character string] Remote Syslog Port 1–65535 Remote Syslog Method Normal UDP Stunnel Remote Syslog Facility 0–23 Log full behavior Wrap over oldest entries E-mail log then delete all entries	Specify how audit logs are configured.  <b>Notes:</b> <ul style="list-style-type: none"> <li>• Enable Audit determines if events are recorded in the secure audit log and remote syslog. No is the factory default setting.</li> <li>• Enable Remote Syslog determines if logs are sent to a remote server. No is the factory default setting.</li> <li>• Remote Syslog Server determines the value used to send logs to the remote syslog server.</li> <li>• Remote Syslog Port identifies the port over which the printer transmits logged events to a remote server.</li> <li>• Remote Syslog Method identifies the protocol used by the printer to transmit logged events to a remote server. Normal UDP is the factory default setting.</li> <li>• Remote Syslog Facility determines the Facility value that the printer uses when sending events to the remote syslog server. 4 is the factory default setting.</li> <li>• “Log full behavior” determines how the printer resolves if the log entirely fills its allotted memory. “Wrap over oldest entries” is the factory default setting.</li> </ul>

Use	To
<p><b>Configure Log (continued)</b></p> <p>Admin’s e-mail address [256 character string]</p> <p>Digitally sign exports Off On</p> <p>Severity of events to log 0–7</p> <p>Remote Syslog non-logged events No Yes</p> <p>E-mail log cleared alert No Yes</p> <p>E-mail log wrapped alert No Yes</p> <p>E-mail % full alert No Yes</p> <p>% full alert level 1–99</p> <p>E-mail log exported alert No Yes</p> <p>E-mail log settings changed alert No Yes</p> <p>Log line endings LF (\n) CR (\r) CRLF (\r\n)</p>	<p>Specify how audit logs are configured.</p> <p><b>Notes:</b></p> <ul style="list-style-type: none"> <li>• “Admin’s e-mail address” determines if administrators are automatically notified of certain log events. This setting can have one or more e-mail addresses (separated by commas).</li> <li>• “Digitally sign exports” determines if the printer automatically signs each exported security log. Off is the factory default setting.</li> <li>• “Severity of events to log” records the severity value of each event. 4 is the factory default setting.</li> <li>• “Remote Syslog non-logged events” determines if the printer sends events to the remote server that have a severity level greater than the value of the “Severity of events to log” setting. No is the factory default setting.</li> <li>• “E-mail log cleared alert” determines if the printer sends an e-mail to the administrator every time a log is deleted through the printer control panel or EWS. No is the factory default setting.</li> <li>• “E-mail log wrapped alert” determines if the printer sends the administrator an e-mail when log entries are wrapping. No is the factory default setting.</li> <li>• “E-mail % full alert” determines if the printer sends the administrator an e-mail when the log fills a certain amount of its allotted space. No is the factory default setting.</li> <li>• “% full alert level” determines if the space occupied by log equals or exceeds the value of the full alert level. 90 is the factory default setting.</li> <li>• “E-mail log exported alert” determines if the printer sends the administrator an e-mail when there is a log exported. No is the factory default setting.</li> <li>• “E-mail log settings changed alert” determines if the printer sends the administrator an e-mail when the value of the Enable Audit Log setting is toggled. No is the factory default setting.</li> <li>• “Log line endings” specifies how line endings will be handled in the log file, depending on the operating system in which the file will be parsed or viewed. “LF (\n)” is the factory default setting.</li> </ul>

### Set Date and Time menu

Use	To
<b>Current Date and Time</b>	View the current date and time settings for the scanner.
<b>Manually Set Date and Time</b>	Enter the date and time. <b>Note:</b> Date/Time is set in YYYY-MM-DD HH:MM:SS format.
<b>Time Zone</b>	Select the time zone. <b>Note:</b> GMT is the factory default setting.

Use	To
<b>Automatically Observe DST</b> On Off	Set the scanner to use the applicable daylight saving time (DST) start and end times associated with the scanner Time Zone setting. <b>Note:</b> On is the factory default setting and uses the applicable Daylight Saving Time associated with the Time Zone setting.
<b>Custom Time Zone Setup</b> DST Start Week DST Start Day DST Start Month DST Start Time DST End Week DST End Day DST End Month DST End Time DST Offset	Enable the user to set up the time zone.
<b>Enable NTP</b> On Off	Enable Network Time Protocol, which synchronizes the clocks of devices on a network. <b>Note:</b> On is the factory default setting.
<b>NTP Server</b>	View the NTP server address.
<b>Enable Authentication</b> On Off	Enable the authentication setting. <b>Note:</b> Off is the factory default setting.

# Settings menu

## General Settings menu

Use	To
<p><b>Display Language</b></p> <ul style="list-style-type: none"> <li>English</li> <li>Francais</li> <li>Deutsch</li> <li>Italiano</li> <li>Espanol</li> <li>Dansk</li> <li>Norsk</li> <li>Nederlands</li> <li>Svenska</li> <li>Portuguese</li> <li>Suomi</li> <li>Russian</li> <li>Polski</li> <li>Greek</li> <li>Magyar</li> <li>Turkce</li> <li>Cesky</li> <li>Simplified Chinese</li> <li>Traditional Chinese</li> <li>Korean</li> <li>Japanese</li> </ul>	<p>Set the language of the text appearing on the printer display.</p> <p><b>Note:</b> Not all languages are available for all printers, and you may need to install special hardware for those languages to appear.</p>
<p><b>Eco-Mode</b></p> <ul style="list-style-type: none"> <li>Off</li> <li>Energy</li> <li>Energy/Paper</li> <li>Paper</li> </ul>	<p>Minimize the use of energy, paper, or specialty media.</p> <p><b>Notes:</b></p> <ul style="list-style-type: none"> <li>• Off is the factory default setting. This resets the printer to its factory default settings.</li> <li>• Energy minimizes the power used by the printer. Performance may be affected, but print quality is not.</li> <li>• Energy/Paper minimizes the use of power and paper specialty media.</li> <li>• Paper minimizes the amount of paper and specialty media needed for a print job. Performance may be affected, but print quality is not.</li> </ul>
<p><b>ADF Loaded Beep</b></p> <ul style="list-style-type: none"> <li>Enabled</li> <li>Disabled</li> </ul>	<p>Specify whether the ADF sounds a beep when paper is loaded.</p> <p><b>Note:</b> Enabled is the factory default setting.</p>

Use	To
<p><b>Quiet Mode</b></p> <ul style="list-style-type: none"> <li>Off</li> <li>On</li> </ul>	<p>Reduce the amount of noise produced by the printer.</p> <p><b>Notes:</b></p> <ul style="list-style-type: none"> <li>• Off is the factory default setting. This supports the performance specifications for your printer.</li> <li>• On configures the printer to produce as little noise as possible. This is best suited for printing text and line art.</li> <li>• For optimal printing of color-rich documents, set Quiet Mode to Off.</li> <li>• Selecting Photo from the print driver may disable Quiet Mode and provide better print quality and full speed printing.</li> </ul>
<p><b>Run Initial setup</b></p> <ul style="list-style-type: none"> <li>Yes</li> <li>No</li> </ul>	<p>Set the printer to run the setup wizard.</p> <p><b>Note:</b> Yes is the factory default setting. After completing the setup wizard, the default becomes No.</p>
<p><b>Keyboard</b></p> <ul style="list-style-type: none"> <li>Keyboard Type</li> <li>English</li> <li>Francais</li> <li>Francais Canadien</li> <li>Deutsch</li> <li>Italiano</li> <li>Espanol</li> <li>Greek</li> <li>Dansk</li> <li>Norsk</li> <li>Nederlands</li> <li>Svenska</li> <li>Suomi</li> <li>Portuguese</li> <li>Russian</li> <li>Polski</li> <li>Swiss German</li> <li>Swiss French</li> <li>Korean</li> <li>Magyar</li> <li>Turkce</li> <li>Cesky</li> <li>Simplified Chinese</li> <li>Traditional Chinese</li> <li>Japanese</li> <li>Custom Key [x]</li> </ul>	<p>Specify a language and custom key information for the printer keyboard. The additional tabs enable access to accent marks and symbols from the keyboard.</p>

Use	To
<p><b>Paper Sizes</b></p> <p>US</p> <p>Metric</p>	<p>Specify the default paper measurement.</p> <p><b>Notes:</b></p> <ul style="list-style-type: none"> <li>• US is the factory default setting.</li> <li>• The initial setting is determined by your country or region selection in the initial setup wizard.</li> <li>• Changing this setting also changes the default setting for each input source in the Paper Size/Type menu.</li> </ul>
<p><b>Scan to PC Port Range</b></p> <p>[port range]</p>	<p>Specify a valid port range for printers behind a port blocking firewall.</p> <p><b>Note:</b> 9751:12000 is the factory default setting.</p>
<p><b>Displayed Information</b></p> <p>Left side</p> <p>Right side</p> <p>Custom Text [x]</p>	<p>Specify what is displayed on the upper left and right corners of the home screen.</p> <p>For the Left side and Right side menus, select from the following options:</p> <ul style="list-style-type: none"> <li>None</li> <li>IP Address</li> <li>Hostname</li> <li>Contact Name</li> <li>Location</li> <li>Date/Time</li> <li>mDNS/DDNS Service Name</li> <li>Zero Configuration Name</li> <li>Custom Text [x]</li> <li>Model Name</li> </ul> <p><b>Notes:</b></p> <ul style="list-style-type: none"> <li>• IP Address is the factory default setting for Left side.</li> <li>• Date/Time is the factory default setting for Right side.</li> </ul>

Use	To
<p><b>Displayed Information (continued)</b>                      Black Toner</p>	<p>Customize the displayed information for Black Toner.                      Select from the following options:</p> <ul style="list-style-type: none"> <li>When to display                             <ul style="list-style-type: none"> <li>Do not display</li> <li>Display</li> </ul> </li> <li>Message to Display                             <ul style="list-style-type: none"> <li>Default</li> <li>Alternate</li> </ul> </li> <li>Default                             <ul style="list-style-type: none"> <li>[text entry]</li> <li>Alternate                                     <ul style="list-style-type: none"> <li>[text entry]</li> </ul> </li> </ul> </li> </ul> <p><b>Notes:</b></p> <ul style="list-style-type: none"> <li>• Do not display is the factory default setting for When to display.</li> <li>• Default is the factory default setting for Message to Display.</li> </ul>
<p><b>Displayed Information (continued)</b>                      Waste Toner Bottle                      Paper Jam                      Load Paper                      Service Errors</p>	<p>Customize the displayed information for Waste Toner Bottle, Paper Jam, Load Paper, and Service Errors.                      Select from the following options:</p> <ul style="list-style-type: none"> <li>Display                             <ul style="list-style-type: none"> <li>Yes</li> <li>No</li> </ul> </li> <li>Message to display                             <ul style="list-style-type: none"> <li>Default</li> <li>Alternate</li> </ul> </li> <li>Default                             <ul style="list-style-type: none"> <li>[text entry]</li> <li>Alternate                                     <ul style="list-style-type: none"> <li>[text entry]</li> </ul> </li> </ul> </li> </ul> <p><b>Notes:</b></p> <ul style="list-style-type: none"> <li>• No is the factory default setting for Display.</li> <li>• Default is the factory default setting for Message to Display.</li> </ul>

Use	To
<p><b>Home screen customization</b></p> <ul style="list-style-type: none"> <li>Change Language</li> <li>Copy</li> <li>Copy Shortcuts</li> <li>Fax</li> <li>Fax Shortcuts</li> <li>E-mail</li> <li>E-mail Shortcuts</li> <li>FTP</li> <li>FTP Shortcuts</li> <li>Search Held Jobs</li> <li>Held Jobs</li> <li>USB Drive</li> <li>Profiles and Apps</li> <li>Bookmarks</li> <li>Jobs by user</li> <li>Forms and Favorites</li> <li>Card Copy</li> <li>Scan to Network</li> <li>MyShortcut</li> <li>Multi Send</li> </ul>	<p>Change the icons that appear on the home screen.</p> <p>For each icon, select from the following options:</p> <ul style="list-style-type: none"> <li>Display</li> <li>Do Not display</li> </ul> <p><b>Notes:</b></p> <ul style="list-style-type: none"> <li>• Display is the factory default setting for Copy, Fax, E-mail, FTP, Search Held Jobs, Held Jobs, USB Drive, Forms and Favorites, Card Copy, Scan to Network, MyShortcut, and Multisend.</li> <li>• Do not display is the factory default setting for Change Language, Copy Shortcuts, Fax Shortcuts, E-mail Shortcuts, FTP Shortcuts, Profiles and Apps, Bookmarks, and Jobs by user.</li> </ul>
<p><b>Date Format</b></p> <ul style="list-style-type: none"> <li>MM-DD-YYYY</li> <li>DD-MM-YYYY</li> <li>YYYY-MM-DD</li> </ul>	<p>Format the printer date.</p> <p><b>Notes:</b></p> <ul style="list-style-type: none"> <li>• MM-DD-YYYY is the U.S. factory default setting.</li> <li>• DD-MM-YYYY is the international factory default setting.</li> </ul>
<p><b>Time Format</b></p> <ul style="list-style-type: none"> <li>12 hour A.M./P.M.</li> <li>24 hour clock</li> </ul>	<p>Format the printer time.</p> <p><b>Note:</b> 12 hour A.M./P.M. is the factory default setting.</p>
<p><b>Screen Brightness</b></p> <ul style="list-style-type: none"> <li>20–100</li> </ul>	<p>Specify the brightness of the control panel screen.</p> <p><b>Note:</b> 100 is the factory default setting.</p>
<p><b>One Page Copy</b></p> <ul style="list-style-type: none"> <li>Off</li> <li>On</li> </ul>	<p>Set copies from the scanner glass to only one page at a time.</p> <p><b>Note:</b> Off is the factory default setting.</p>
<p><b>Output Lighting</b></p> <ul style="list-style-type: none"> <li>Normal/Standby Mode</li> <li>Off</li> <li>Dim</li> <li>Bright</li> </ul>	<p>Set the amount of light from the standard bin.</p> <p><b>Notes:</b></p> <ul style="list-style-type: none"> <li>• Dim is the factory default setting if Eco-Mode is set to Energy or Energy/Paper.</li> <li>• Bright is the factory default setting if Eco-Mode is set to Paper or Off.</li> </ul>



Use	To
<b>Audio Feedback</b> Button Feedback On Off Volume 1–10	Set the audio volume for the buttons. <b>Notes:</b> <ul style="list-style-type: none"> <li>• On is the factory default setting for Button Feedback.</li> <li>• 5 is the factory default setting for Volume.</li> </ul>
<b>Show Bookmarks</b> Yes No	Specify whether bookmarks are displayed from the Held Jobs area. <b>Note:</b> Yes is the factory default setting.
<b>Allow Background Removal</b> On Off	Specify whether image background removal is allowed in copy, fax, e-mail, FTP, or scan-to-USB jobs. <b>Note:</b> On is the factory default setting. The background of the image is removed.
<b>Allow Custom Job Scans</b> On Off	Scan multiple jobs to one file. <b>Note:</b> On is the factory default setting. If On is selected, then the Allow Custom Job Scans setting can be enabled for specific jobs.
<b>Scanner Jam Recovery</b> Job level Page level	Specify how a scanned job should be reloaded if a paper jam occurs in the ADF. <b>Notes:</b> <ul style="list-style-type: none"> <li>• Job level is the factory default setting. If selected, then the entire job must be rescanned if any pages jam.</li> <li>• If Page level is selected, then rescan from the jammed page forward.</li> </ul>
<b>Web Page Refresh Rate</b> 30–300	Specify the number of seconds between Embedded Web Server refreshes. <b>Note:</b> 120 is the factory default setting.
<b>Contact Name</b>	Specify a contact name for the printer. <b>Note:</b> The contact name is stored on the Embedded Web Server.
<b>Location</b>	Specify the location of the printer. <b>Note:</b> The location is stored on the Embedded Web Server.
<b>Alarms</b> Alarm Control Cartridge Alarm Staple Alarm Hole Punch Alarm	Set an alarm when the printer requires user intervention. For each alarm type, select from the following options: Off Single Continuous <b>Notes:</b> <ul style="list-style-type: none"> <li>• Single is the factory default setting for Alarm Control. Single sounds three quick beeps.</li> <li>• Off is the factory default setting for Cartridge Alarm, Staple Alarm, and Hole Punch Alarm.</li> <li>• Continuous repeats three beeps every 10 seconds.</li> </ul>

Use	To
<b>Timeouts</b> Standby Mode Disabled 1–240	Specify the number of minutes of inactivity before the printer enters a lower power state. <b>Note:</b> 15 is the factory default setting.
<b>Timeouts</b> Sleep Mode Disabled 1–120	Set the amount of time in minutes the printer waits after a job is printed before it goes into a reduced power state. <b>Notes:</b> <ul style="list-style-type: none"> <li>• 20 is the factory default setting.</li> <li>• Disabled appears only when Energy Conserve is set to Off.</li> <li>• Lower settings conserve more energy, but may require longer warm-up times.</li> <li>• Select a high setting if the printer is in constant use. Under most circumstances, this keeps the printer ready to print with minimum warm-up time.</li> </ul>
<b>Timeouts</b> Print with Display off Allow printing with display off Display on when printing	Allow the printer to print even when the display is off. <b>Note:</b> Allow printing with display off is the factory default setting.
<b>Timeouts</b> Hibernate Timeout Disabled 1 hour 2 hours 3 hours 6 hours 1 day 2 days 3 days 1 week 2 weeks 1 month	Set the amount of time before the printer enters Hibernate mode. <b>Note:</b> 3 days is the factory default setting.
<b>Timeouts</b> Hibernate Timeout on Connection Do Not Hibernate Hibernate	Set the printer to Hibernate Timeout even when there is an active Ethernet connection. <b>Note:</b> Hibernate is the factory default setting.
<b>Timeouts</b> Screen Timeout 15–300	Set the amount of time in seconds the printer waits before returning to Ready state. <b>Note:</b> 30 is the factory default setting.
<b>Timeouts</b> Prolong Screen Timeout On Off	Set the printer to continue a specified job without returning to the home screen when the screen timeout timer expires. <b>Note:</b> Off is the factory default setting.

Use	To
<p><b>Timeouts</b></p> <p>Print Timeout</p> <p>Disabled</p> <p>1–255</p>	<p>Set the amount of time in seconds the printer waits to receive an end-of-job message before canceling the rest of the print job.</p> <p><b>Notes:</b></p> <ul style="list-style-type: none"> <li>• 90 is the factory default setting.</li> <li>• When the timer expires, any partially printed page still in the printer is printed, and then the printer checks to see if any new print jobs are waiting.</li> <li>• Print Timeout is available only when using PCL emulation. This has no effect on PostScript emulation print jobs.</li> </ul>
<p><b>Timeouts</b></p> <p>Wait Timeout</p> <p>Disabled</p> <p>15–65535</p>	<p>Set the amount of time in seconds the printer waits for additional data before canceling a print job.</p> <p><b>Notes:</b></p> <ul style="list-style-type: none"> <li>• 40 is the factory default setting.</li> <li>• Wait Timeout is available only when the printer is using PostScript emulation. This has no effect on PCL emulation print jobs.</li> </ul>
<p><b>Timeouts</b></p> <p>Job Hold Timeout</p> <p>5–255</p>	<p>Set the amount of time the printer waits for user intervention before it holds jobs that require unavailable resources and continues to print other jobs in the print queue.</p> <p><b>Notes:</b></p> <ul style="list-style-type: none"> <li>• 30 is the factory default setting.</li> <li>• This menu appears only when a formatted printer hard disk is installed.</li> </ul>
<p><b>Error Recovery</b></p> <p>Auto Reboot</p> <p>Reboot when idle</p> <p>Reboot always</p> <p>Reboot never</p>	<p>Set the printer to restart when an error is encountered.</p> <p><b>Note:</b> Reboot always is the factory default setting.</p>
<p><b>Error Recovery</b></p> <p>Max Auto Reboots</p> <p>1–20</p>	<p>Determine the number of automatic reboots the printer can perform.</p> <p><b>Note:</b> 2 is the factory default setting.</p>
<p><b>Print Recovery</b></p> <p>Auto Continue</p> <p>Disabled</p> <p>5–255</p>	<p>Let the printer automatically continue printing from certain offline situations when not resolved within the specified time period.</p> <p><b>Note:</b> Disabled is the factory default setting.</p>

Use	To
<p><b>Print Recovery</b></p> <p>Jam Recovery</p> <ul style="list-style-type: none"> <li>On</li> <li>Off</li> <li>Auto</li> </ul>	<p>Specify whether the printer reprints jammed pages.</p> <p><b>Notes:</b></p> <ul style="list-style-type: none"> <li>• Auto is the factory default setting. The printer reprints jammed pages unless the memory required to hold the pages is needed for other printer tasks.</li> <li>• On sets the printer to always reprint jammed pages.</li> <li>• Off sets the printer to never reprint jammed pages.</li> </ul>
<p><b>Print Recovery</b></p> <p>Jam Assist</p> <ul style="list-style-type: none"> <li>On</li> <li>Off</li> </ul>	<p>Set the printer to automatically check for jammed paper.</p> <p><b>Note:</b> On is the factory default setting.</p>
<p><b>Print Recovery</b></p> <p>Page Protect</p> <ul style="list-style-type: none"> <li>Off</li> <li>On</li> </ul>	<p>Let the printer successfully print a page that may not have printed otherwise.</p> <p><b>Notes:</b></p> <ul style="list-style-type: none"> <li>• Off is the factory default setting. This prints a partial page when there is not enough memory to print the whole page.</li> <li>• On sets the printer to process the whole page so that the entire page prints.</li> </ul>
<p><b>Press Sleep Button</b></p> <ul style="list-style-type: none"> <li>Do Nothing</li> <li>Sleep</li> <li>Hibernate</li> </ul>	<p>Determine how the printer responds when pressing the Sleep button while the printer is idle.</p> <p><b>Notes:</b></p> <ul style="list-style-type: none"> <li>• Sleep is the factory default setting.</li> <li>• Sleep or Hibernate sets the printer to operate at a lower power configuration.</li> <li>• If the printer is in Sleep mode, then the display appears off and the Sleep button turns amber. Touch anywhere on the display or press a button on the control panel to wake the printer from Sleep mode.</li> <li>• If the printer is in Hibernate mode, then the display is completely off and the Sleep button turns amber and is blinking.</li> </ul>
<p><b>Press and Hold Sleep Button</b></p> <ul style="list-style-type: none"> <li>Do Nothing</li> <li>Sleep</li> <li>Hibernate</li> </ul>	<p>Determine how the printer responds when pressing the Sleep button for 3 seconds or longer while the printer is idle.</p> <p><b>Notes:</b></p> <ul style="list-style-type: none"> <li>• Do Nothing is the factory default setting.</li> <li>• Sleep or Hibernate sets the printer to operate at a lower power configuration.</li> <li>• If the printer is in Sleep mode, then the display appears off and the Sleep button turns amber. Touch anywhere on the display or press a button on the control panel to wake the printer from Sleep mode.</li> </ul>

Use	To
<b>Factory Defaults</b> Do Not Restore Restore Now	Restore the printer settings to the factory default settings. <b>Notes:</b> <ul style="list-style-type: none"> <li>• Do Not Restore is the factory default setting. This keeps the user-defined settings.</li> <li>• Restore Now returns all printer settings to the factory default settings except Network/Ports menu settings. All downloads stored in RAM are deleted. Downloads stored in flash memory or on a printer hard disk are not affected.</li> </ul>
<b>Export Configuration Package</b> Export	Export the printer configuration file to a flash drive.

## Copy Settings menu

Use	To
<b>Content Type</b> Text Graphics Text/Photo Photo	Specify the content of the original document. <b>Note:</b> Text/Photo is the factory default setting.
<b>Content Source</b> Black/White Laser Color Laser Inkjet Photo/Film Magazine Newspaper Press Other	Specify how the original document was produced. <b>Note:</b> Black/White Laser is the factory default setting.
<b>Sides (Duplex)</b> 1 sided to 1 sided 1 sided to 2 sided 2 sided to 1 sided 2 sided to 2 sided	Specify whether an original document is two-sided or one-sided, and then to specify whether the copy should be two-sided or one-sided. <b>Notes:</b> <ul style="list-style-type: none"> <li>• <b>1 sided to 1 sided</b>—The original document has print on one side and the copy will also have print on one side.</li> <li>• <b>1 sided to 2 sided</b>—The original document has print on one side, while the copy will have print on both sides.</li> <li>• <b>2 sided to 1 sided</b>—The original document has print on both sides, while the copy will have print on just one side.</li> <li>• <b>2 sided to 2 sided</b>—The original document has print on both sides, and the copy will also have print on both sides.</li> </ul>

Use	To
<b>Paper Saver</b> Off 2-up Portrait 2-up Landscape 4-up Portrait 4-up Landscape	Copy two or four sheets of a document on one page. <b>Note:</b> Off is the factory default setting.
<b>Print Page Borders</b> On Off	Specify whether a border is printed. <b>Note:</b> Off is the factory default setting.
<b>Collate</b> (1,1,1) (2,2,2) (1,2,3) (1,2,3)	Keep the pages of a print job stacked in sequence when printing multiple copies. <b>Note:</b> (1,2,3) (1,2,3) is the factory default setting.
<b>Punch</b> Off 2 holes 3 holes 4 holes	Specify the type of hole punch finishing to be used in a print or copy job. <b>Notes:</b> <ul style="list-style-type: none"> <li>• Off is the factory default setting.</li> <li>• This menu item appears only when a staple, hole punch finisher is installed.</li> </ul>
<b>Staple</b> Off 1 staple 2 staples	Enable or disable the staple finisher. <b>Notes:</b> <ul style="list-style-type: none"> <li>• Off is the factory default setting.</li> <li>• This menu item appears only when a staple finisher is installed.</li> </ul>

Use	To
<p><b>Original Size</b></p> <ul style="list-style-type: none"> <li>Letter</li> <li>Legal</li> <li>Executive</li> <li>Tabloid</li> <li>Folio</li> <li>Statement</li> <li>Oficio (Mexico)</li> <li>Universal</li> <li>Auto Size Sense</li> <li>Mixed Sizes</li> <li>A3</li> <li>A4</li> <li>A5</li> <li>A6</li> <li>JIS B4</li> <li>JIS B5</li> <li>Custom Scan Size [x]</li> <li>Book Original</li> <li>Business Card</li> <li>3 x 5 in.</li> <li>4 x 6 in.</li> <li>ID Card</li> </ul>	<p>Specify the paper size of the original document.</p> <p><b>Note:</b> Letter is the U.S. factory default setting. A4 is the international factory default setting.</p>
<p><b>Copy To Source</b></p> <ul style="list-style-type: none"> <li>Tray [x]</li> <li>Auto Size Match</li> <li>Multipurpose Feeder</li> </ul>	<p>Specify the paper source for copy jobs.</p> <p><b>Note:</b> Tray 1 is the factory default setting.</p>
<p><b>Transparency Separators</b></p> <ul style="list-style-type: none"> <li>On</li> <li>Off</li> </ul>	<p>Place a sheet of paper between transparencies.</p> <p><b>Notes:</b></p> <ul style="list-style-type: none"> <li>• On is the factory default setting.</li> <li>• When set to On, a blank page is placed between transparencies.</li> </ul>
<p><b>Separator Sheets</b></p> <ul style="list-style-type: none"> <li>Off</li> <li>Between Copies</li> <li>Between Jobs</li> <li>Between Pages</li> </ul>	<p>Place a sheet of paper between pages, copies, or jobs.</p> <p><b>Note:</b> Off is the factory default setting.</p>
<p><b>Separator Sheet Source</b></p> <ul style="list-style-type: none"> <li>Tray [x]</li> <li>Multipurpose Feeder</li> </ul>	<p>Specify the paper source for the separator sheet.</p> <p><b>Note:</b> Tray 1 is the factory default setting.</p>
<p><b>Darkness</b></p> <ul style="list-style-type: none"> <li>1–9</li> </ul>	<p>Lighten or darken the print for the copy job.</p> <p><b>Note:</b> 5 is the factory default setting.</p>

Use	To
<b>Output Bin</b> Standard Bin Bin [x]	Specify the bin to be used for the copy job. <b>Notes:</b> <ul style="list-style-type: none"> <li>• Standard Bin is the factory default setting.</li> <li>• Bin [x] appears only when at least one optional bin is installed.</li> </ul>
<b>Number of Copies</b> 1–9999	Specify the number of copies for the copy job. <b>Note:</b> 1 is the factory default setting.
<b>Header/Footer</b> [Location] Off Date/Time Page number Custom text Print on All pages First page only All but first page Custom text	Specify header and footer information and its location on the page. For the location, select from the following options: <ul style="list-style-type: none"> <li>• Top left</li> <li>• Top middle</li> <li>• Top right</li> <li>• Bottom left</li> <li>• Bottom middle</li> <li>• Bottom right</li> </ul> <b>Notes:</b> <ul style="list-style-type: none"> <li>• Off is the factory default setting for the location.</li> <li>• All pages is the factory default setting for “Print on.”</li> </ul>
<b>Overlay</b> Confidential Copy Draft Urgent Custom Off	Specify the overlay text printed on each page of the copy job. <b>Note:</b> Off is the factory default setting.
<b>Custom Overlay</b>	Specify the custom overlay text. <b>Note:</b> A maximum of 64 characters is allowed.
<b>Allow priority copies</b> On Off	Allow interruption of a print job to copy a page or document. <b>Note:</b> On is the factory default setting.
<b>Custom Job scanning</b> On Off	Copy a document that contains mixed paper sizes into a single copy job. <b>Notes:</b> <ul style="list-style-type: none"> <li>• Off is the factory default setting.</li> <li>• This menu item appears only when a formatted, working printer hard disk is installed.</li> </ul>
<b>Allow Save as Shortcut</b> On Off	Save custom copy settings as shortcuts. <b>Note:</b> On is the factory default setting.
<b>Background Removal</b> -4 to 4	Adjust the amount of background visible on a copy. <b>Note:</b> 0 is the factory default setting.



Use	To
<b>Auto Center</b> Off On	Automatically center the content on the page. <b>Note:</b> Off is the factory default setting.
<b>Color Dropout</b> Color Dropout None Red Green Blue Default Red Threshold 0–255 Default Green Threshold 0–255 Default Blue Threshold 0–255	Specify which color to drop during scanning and to adjust the dropout setting for each color threshold. <b>Notes:</b> <ul style="list-style-type: none"> <li>• None is the factory default setting for Color Dropout.</li> <li>• 128 is the factory default setting for each color threshold.</li> </ul>
<b>Contrast</b> 0–5 Best for content	Specify the contrast used for the copy job. <b>Note:</b> Best for content is the factory default setting.
<b>Mirror Image</b> Off On	Create a mirror image of the original document. <b>Note:</b> Off is the factory default setting.
<b>Negative Image</b> Off On	Create a negative image of the original document. <b>Note:</b> Off is the factory default setting.
<b>Shadow Detail</b> -4 to 4	Adjust the amount of shadow detail visible on a copy. <b>Note:</b> 0 is the factory default setting.
<b>Scan edge to edge</b> Off On	Allow edge-to-edge scanning of the original document. <b>Note:</b> Off is the factory default setting.
<b>Sharpness</b> 1–5	Adjust the amount of sharpness of a copy. <b>Note:</b> 3 is the factory default setting.
<b>Sample Copy</b> Off On	Create a sample copy of the original document. <b>Notes:</b> <ul style="list-style-type: none"> <li>• Off is the factory default setting.</li> <li>• This menu item appears only when a formatted, working printer hard disk is installed.</li> </ul>

## Fax Settings menu

### Fax Mode (Analog Fax Setup) menu

Analog Fax Setup mode sends the fax job through a telephone line.

#### General Fax Settings

Use	To
<b>Fax Name</b>	Specify the name of the fax in the printer.
<b>Fax Number</b>	Specify the number assigned to the fax.
<b>Fax ID</b> Fax Name Fax Number	Specify how the fax is identified. <b>Note:</b> Fax Number is the factory default setting.
<b>Enable Manual Fax</b> On Off	Set the printer to fax manually, which requires a line splitter and a telephone handset. <b>Notes:</b> <ul style="list-style-type: none"> <li>• Use a regular telephone to answer an incoming fax job and to dial a fax number.</li> <li>• Touch # 0 on the numeric keypad to go directly to the Manual Fax function.</li> <li>• Off is the factory default setting.</li> </ul>
<b>Memory Use</b> All receive Mostly receive Equal Mostly send All send	Define the allocation of non-volatile memory between sending and receiving fax jobs. <b>Notes:</b> <ul style="list-style-type: none"> <li>• Equal is the factory default setting. Equal splits the memory for sending and receiving fax jobs into equal amounts.</li> <li>• Mostly send specifies that most of the memory is set to send fax jobs.</li> <li>• All send specifies that all the memory is set to send fax jobs.</li> <li>• All receive specifies that all the memory is set to receive fax jobs.</li> <li>• Mostly receive specifies that most of the memory is set to receive fax jobs.</li> </ul>
<b>Cancel Faxes</b> Allow Don't Allow	Specify whether the printer cancels fax jobs. <b>Note:</b> Allow is the factory default setting.
<b>Caller ID</b> Off Primary Alternate	Specify the type of caller ID being used.
<b>Fax number masking</b> Off From left From right	Specify the direction from where digits are masked in an outgoing fax number. <b>Notes:</b> <ul style="list-style-type: none"> <li>• The number of characters masked is determined by the Digits to Mask setting.</li> <li>• Off is the factory default setting.</li> </ul>
<b>Digits to Mask</b> 0–58	Specify the number of digits to mask in an outgoing fax number. <b>Note:</b> 0 is the factory default setting.

Use	To
<p><b>Fax Cover Page</b></p> <ul style="list-style-type: none"> <li>Fax Cover Page                             <ul style="list-style-type: none"> <li>Off by default</li> <li>On by default</li> <li>Never use</li> <li>Always use</li> </ul> </li> <li>Include to Field                             <ul style="list-style-type: none"> <li>On</li> <li>Off</li> </ul> </li> <li>Include from Field                             <ul style="list-style-type: none"> <li>On</li> <li>Off</li> </ul> </li> <li>From                             <ul style="list-style-type: none"> <li>Include Message Field                                     <ul style="list-style-type: none"> <li>On</li> <li>Off</li> </ul> </li> </ul> </li> <li>Message                             <ul style="list-style-type: none"> <li>Include Logo                                     <ul style="list-style-type: none"> <li>On</li> <li>Off</li> </ul> </li> </ul> </li> <li>Include Footer [x]                             <ul style="list-style-type: none"> <li>On</li> <li>Off</li> </ul> </li> <li>Footer [x]</li> </ul>	<p>Configure the fax cover page.</p> <p><b>Notes:</b></p> <ul style="list-style-type: none"> <li>Off by default is the factory default setting for Fax Cover Page.</li> <li>Off is the factory default setting for all other menu items.</li> </ul>

**Fax Send Settings**

Use	To
<p><b>Resolution</b></p> <ul style="list-style-type: none"> <li>Standard</li> <li>Fine 200 dpi</li> <li>Super Fine 300 dpi</li> <li>Ultra Fine 600 dpi</li> </ul>	<p>Specify quality in dots per inch (dpi). A higher resolution gives better print quality, but increases the fax transmission time for outgoing faxes.</p> <p><b>Note:</b> Standard is the factory default setting.</p>

Use	To
<p><b>Original Size</b></p> <ul style="list-style-type: none"> <li>Letter</li> <li>Legal</li> <li>Executive</li> <li>Tabloid</li> <li>Folio</li> <li>Statement</li> <li>Oficio (Mexico)</li> <li>Universal</li> <li>Auto Size Sense</li> <li>Mixed Sizes</li> <li>A3</li> <li>A4</li> <li>A5</li> <li>A6</li> <li>JIS B4</li> <li>JIS B5</li> <li>Custom Scan Size [x]</li> <li>Book Original</li> <li>Business Card</li> <li>3 x 5 in.</li> <li>4 x 6 in.</li> </ul>	<p>Specify the size of the original document.</p> <p><b>Note:</b> Mixed Sizes is the U.S. factory default setting. A4 is the international factory default setting.</p>
<p><b>Sides (Duplex)</b></p> <ul style="list-style-type: none"> <li>Off</li> <li>Long edge</li> <li>Short edge</li> </ul>	<p>Specify how text and graphics are oriented on a page.</p> <p><b>Notes:</b></p> <ul style="list-style-type: none"> <li>• Off is the factory default setting.</li> <li>• Long edge assumes binding along the long edge of the page (left edge for portrait and top edge for landscape).</li> <li>• Short edge assumes binding along the short edge of the page (top edge for portrait and left edge for landscape).</li> </ul>
<p><b>Content Type</b></p> <ul style="list-style-type: none"> <li>Text</li> <li>Graphics</li> <li>Text/Photo</li> <li>Photo</li> </ul>	<p>Specify the content of the original document.</p> <p><b>Note:</b> Text is the factory default setting.</p>
<p><b>Content Source</b></p> <ul style="list-style-type: none"> <li>Black/White Laser</li> <li>Color Laser</li> <li>Inkjet</li> <li>Photo/Film</li> <li>Magazine</li> <li>Newspaper</li> <li>Press</li> <li>Other</li> </ul>	<p>Specify how the original document was produced.</p> <p><b>Note:</b> Black/White Laser is the factory default setting.</p>

Use	To
<b>Darkness</b> 1–9	Lighten or darken the output. <b>Note:</b> 5 is the factory default setting.
<b>Dial Prefix</b>	Enter a dialing prefix, such as 99. A numeric entry field is provided.
<b>Dialing Prefix Rules</b> Prefix Rule [x]	Establish a dialing prefix rule.
<b>Automatic Redial</b> 0–9	Specify the number of times the printer tries to send the fax to a specified number. <b>Note:</b> 5 is the factory default setting.
<b>Redial frequency</b> 1–200	Specify the number of minutes between redials. <b>Note:</b> 3 is the factory default setting.
<b>Behind a PABX</b> Yes No	Enable or disable switchboard blind dialing without a dial tone. <b>Note:</b> No is the factory default setting.
<b>Enable ECM</b> Yes No	Enable or disable Error Correction Mode for fax jobs. <b>Note:</b> Yes is the factory default setting.
<b>Enable Fax Scans</b> On Off	Fax files that are scanned at the printer. <b>Note:</b> On is the factory default setting.
<b>Driver to fax</b> Yes No	Allow the print driver to send fax jobs. <b>Note:</b> Yes is the factory default setting.
<b>Allow Save as Shortcut</b> On Off	Save fax numbers as shortcuts in the printer. <b>Note:</b> On is the factory default setting.
<b>Dial Mode</b> Tone Pulse	Specify a dialing sound. <b>Note:</b> Tone is the factory default setting.
<b>Max Speed</b> 2400 4800 9600 14400 33600	Specify the maximum speed in baud at which faxes are sent. <b>Note:</b> 33600 is the factory default setting.
<b>Custom Job scanning</b> On Off	Scan a document that contains mixed paper sizes into a single file. <b>Notes:</b> <ul style="list-style-type: none"> <li>• Off is the factory default setting.</li> <li>• This menu item appears only when a formatted, working printer hard disk is installed.</li> </ul>

Use	To
<b>Scan Preview</b> On Off	Specify whether a preview appears on the display for scan jobs. <b>Notes:</b> <ul style="list-style-type: none"> <li>• Off is the factory default setting.</li> <li>• This menu item appears only when a formatted, working printer hard disk is installed.</li> </ul>
<b>Background Removal</b> -4 to 4	Adjust the amount of background visible on a scanned image. <b>Note:</b> 0 is the factory default setting.
<b>Color Balance</b> Cyan - Red Magenta - Green Yellow - Blue	Enable an equal balance of colors in the scanned image.
<b>Color Dropout</b> Color Dropout None Red Green Blue Default Red Threshold 0–255 Default Green Threshold 0–255 Default Blue Threshold 0–255	Specify which color to drop during scanning and to adjust the dropout setting for each color threshold. <b>Notes:</b> <ul style="list-style-type: none"> <li>• None is the factory default setting for Color Dropout.</li> <li>• 128 is the factory default setting for each color threshold.</li> </ul>
<b>Contrast</b> 0–5 Best for content	Specify the contrast in the scanned image. <b>Note:</b> Best for content is the factory default setting.
<b>Mirror Image</b> Off On	Create a mirror image of the original document. <b>Note:</b> Off is the factory default setting.
<b>Negative Image</b> Off On	Create a negative image of the original document. <b>Note:</b> Off is the factory default setting.
<b>Shadow Detail</b> -4 to 4	Adjust the amount of shadow detail visible. <b>Note:</b> 0 is the factory default setting.
<b>Scan edge to edge</b> Off On	Specify if the original document is scanned edge-to-edge prior to faxing. <b>Note:</b> Off is the factory default setting.
<b>Sharpness</b> 1–5	Adjust the sharpness of a fax. <b>Note:</b> 3 is the factory default setting.

Use	To
<b>Temperature</b> -4 to 4	Specify warm or cool outputs. Cool values generate a bluer output than the default while warm values generate a redder output than the default. <b>Note:</b> 0 is the factory default setting.
<b>Enable Color Fax Scans</b> Off by default On by default Never use Always use	Enable color faxing. <b>Note:</b> Off by default is the factory default setting.
<b>Auto Convert Color Faxes to Mono Faxes</b> On Off	Convert all outgoing faxes to black and white. <b>Note:</b> On is the factory default setting.

### Fax Receive Settings

Use	To
<b>Enable Fax Receive</b> On Off	Allow the printer to receive fax jobs. <b>Note:</b> On is the factory default setting.
<b>Fax Job Waiting</b> None Toner Toner and Supplies	Remove fax jobs from the print queue when the job requires specific unavailable resources. <b>Note:</b> None is the factory default setting.
<b>Rings to Answer</b> 1–25	Specify the number of rings before answering an incoming fax job. <b>Note:</b> 3 is the factory default setting.
<b>Auto Answer</b> Yes No	Allow the printer to answer an incoming fax job. <b>Note:</b> Yes is the factory default setting.
<b>Manual Answer Code</b> 0–9	Enter a code on the telephone number pad to begin receiving a fax. <b>Notes:</b> <ul style="list-style-type: none"> <li>• *9* is the factory default setting.</li> <li>• This menu item is used when the printer shares a line with a telephone.</li> </ul>
<b>Auto Reduction</b> On Off	Scale an incoming fax job so that it fits the size of the paper loaded in the designated fax source. <b>Note:</b> On is the factory default setting.
<b>Paper Source</b> Auto Tray [x] Multipurpose Feeder	Specify the paper source for printing incoming fax jobs. <b>Note:</b> Auto is the factory default setting.
<b>Sides (Duplex)</b> Off On	Enable two-sided printing for incoming fax jobs. <b>Note:</b> Off is the factory default setting.

Use	To
<b>Separator Sheets</b> Off Before Job After Job	Enable the printer to include separator sheets for incoming fax jobs. <b>Note:</b> Off is the factory default setting.
<b>Separator Sheet Source</b> Tray [x] Multipurpose Feeder	Specify the paper source for the separator sheet. <b>Note:</b> Tray 1 is the factory default setting.
<b>Output Bin</b> Standard Bin Bin [x]	Specify a bin for received faxes. <b>Note:</b> Standard Bin is the factory default setting.
<b>Fax Footer</b> On Off	Print the transmission information at the bottom of each page from a received fax. <b>Note:</b> Off is the factory default setting.
<b>Max Speed</b> 2400 4800 9600 14400 33600	Specify the maximum speed in baud at which faxes are received. <b>Note:</b> 33600 is the factory default setting.
<b>Fax Forwarding</b> Print Print and Forward Forward	Enable forwarding of received faxes to another recipient. <b>Note:</b> Print is the factory default setting.
<b>Forward to</b> Fax E-mail FTP LDSS eSF	Specify the type of recipient to which faxes are forwarded. <b>Notes:</b> <ul style="list-style-type: none"> <li>• Fax is the factory default setting.</li> <li>• This menu is available only from the printer Embedded Web Server.</li> </ul>
<b>Forward to Shortcut</b>	Enter the shortcut number which matches the recipient type (Fax, E-mail, FTP, LDSS, or eSF).
<b>Block No Name Fax</b> Off On	Enable blocking of incoming faxes sent from devices with no station ID or fax ID specified. <b>Note:</b> Off is the factory default setting.
<b>Banned Fax List</b>	Enable the list of blocked fax numbers stored in the printer.
<b>Holding Faxes</b> Held Fax Mode Off Always On Manual Scheduled Fax Holding Schedule	Enable fax holding all of the time or according to set schedule. <b>Note:</b> Off is the factory default setting.



Use	To
<b>Punch</b> Off On	Specify whether prints are punched. <b>Notes:</b> <ul style="list-style-type: none"> <li>Off is the factory default setting.</li> <li>This menu item appears only when a staple, hole punch finisher is installed.</li> </ul>
<b>Staple</b> Off 1 staple 2 staples 4 staples	Specify whether prints are stapled. <b>Notes:</b> <ul style="list-style-type: none"> <li>Off is the factory default setting.</li> <li>This menu item appears only when a staple finisher is installed.</li> </ul>
<b>Enable Color Fax Receive</b> On Off	Enable the printer to receive fax in color and print it in grayscale. <b>Note:</b> On is the factory default setting.

### Fax Log Settings

Use	To
<b>Transmission Log</b> Print log Do not print log Print only for error	Enable printing of a transmission log after each fax job. <b>Note:</b> Print log is the factory default setting.
<b>Receive Error Log</b> Print Never Print on Error	Enable printing of a receive error log following a receive error. <b>Note:</b> Print Never is the factory default setting.
<b>Auto Print Logs</b> On Off	Enable automatic printing of fax logs. <b>Notes:</b> <ul style="list-style-type: none"> <li>On is the factory default setting.</li> <li>Logs print after every 200 fax jobs.</li> </ul>
<b>Log Paper Source</b> Tray [x] Multipurpose Feeder	Specify the source of the paper used for printing logs. <b>Note:</b> Tray 1 is the factory default setting.
<b>Logs Display</b> Remote Station Name Dialed Number	Specify whether printed logs display the dialed number or the station name or fax name returned. <b>Note:</b> Remote Station Name is the factory default setting.
<b>Enable Job Log</b> On Off	Enable access to the Fax Job log. <b>Note:</b> On is the factory default setting.
<b>Enable Call Log</b> On Off	Enable access to the Fax Call log. <b>Note:</b> On is the factory default setting.

Use	To
<b>Log Output Bin</b> Standard Bin Bin [x]	Specify the bin for the printed fax logs. <b>Note:</b> Standard Bin is the factory default setting.

### Speaker Settings

Use	To
<b>Speaker Mode</b> Always Off On until Connected Always On	Specify the mode of the speaker. <b>Note:</b> On until Connected is the factory default setting. A sound is issued until the fax connection is made.
<b>Speaker Volume</b> High Low	Control the volume setting. <b>Note:</b> High is the factory default setting.
<b>Ringer Volume</b> Off On	Control the fax speaker ringer volume. <b>Note:</b> On is the factory default setting.

### Answer On

Use	To
All Rings Single Ring Only Double Ring Only Triple Ring Only Single or Double Rings Only Single or Triple Rings Only Double or Triple Rings Only	Specify ring patterns when the printer is answering calls. <b>Note:</b> All Rings is the factory default setting.

### E-mail Settings menu

Use	To
<b>E-mail Server Setup</b> Subject Message File Name Send me a copy Max e-mail size Size Error Message Limit destinations Web Link Setup	Specify e-mail server information.

Use	To
<b>Format</b> PDF (.pdf) Secure PDF TIFF (.tif) JPEG (.jpg) XPS (.xps)	Specify the format of the scanned file. <b>Note:</b> PDF (.pdf) is the factory default setting.
<b>PDF Version</b> 1.2–1.7 A–1a	Set the version of the PDF file that is scanned for e-mailing. <b>Note:</b> 1.5 is the factory default setting.
<b>Content Type</b> Text Graphics Text/Photo Photo	Specify the content of the original document. <b>Note:</b> Text/Photo is the factory default setting.
<b>Content Source</b> Black/White Laser Color Laser Inkjet Photo/Film Magazine Newspaper Press Other	Specify how the original document was produced. <b>Note:</b> Black/White Laser is the factory default setting.
<b>Color</b> Off On	Specify whether the printer captures and transmits content in color or in black and white. <b>Note:</b> On is the factory default setting.
<b>Resolution</b> 75 dpi 150 dpi 200 dpi 300 dpi 400 dpi 600 dpi	Specify the resolution of the scan in dots per inch. <b>Note:</b> 150 dpi is the factory default setting.
<b>Darkness</b> 1–9	Lighten or darken the output. <b>Note:</b> 5 is the factory default setting.
<b>Orientation</b> Portrait Landscape	Specify the orientation of the scanned image. <b>Note:</b> Portrait is the factory default setting.

Use	To
<p><b>Original Size</b></p> <ul style="list-style-type: none"> <li>Letter</li> <li>Legal</li> <li>Executive</li> <li>Tabloid</li> <li>Folio</li> <li>Statement</li> <li>Oficio (Mexico)</li> <li>Universal</li> <li>Auto Size Sense</li> <li>Mixed Sizes</li> <li>A3</li> <li>A4</li> <li>A5</li> <li>A6</li> <li>JIS B4</li> <li>JIS B5</li> <li>Custom Scan Size [x]</li> <li>Book Original</li> <li>Business Card</li> <li>3 x 5 in.</li> <li>4 x 6 in.</li> </ul>	<p>Specify the size of the document being scanned.</p> <p><b>Note:</b> Letter is the U.S. factory default setting. A4 is the international factory default setting.</p>
<p><b>Sides (Duplex)</b></p> <ul style="list-style-type: none"> <li>Off</li> <li>Long edge</li> <li>Short edge</li> </ul>	<p>Specify how text and graphics are oriented on the page.</p> <p><b>Notes:</b></p> <ul style="list-style-type: none"> <li>• Off is the factory default setting.</li> <li>• Long edge assumes binding along the long edge of the page (left edge for portrait and top edge for landscape).</li> <li>• Short edge assumes binding along the short edge of the page (top edge for portrait and left edge for landscape).</li> </ul>
<p><b>JPEG Quality</b></p> <ul style="list-style-type: none"> <li>Best for content</li> <li>5–90</li> </ul>	<p>Set the quality of a JPEG photo image in relation to file size and quality of the image.</p> <p><b>Notes:</b></p> <ul style="list-style-type: none"> <li>• Best for content is the factory default setting.</li> <li>• 5 reduces the file size and quality of the image.</li> <li>• 90 provides the best image quality, but the file size is very large.</li> <li>• This menu setting applies to all scan functions.</li> </ul>
<p><b>Text Default</b></p> <ul style="list-style-type: none"> <li>5–90</li> </ul>	<p>Set the quality of a text image in relation to file size and quality of the image.</p> <p><b>Note:</b> 75 is the factory default setting.</p>
<p><b>Text/Photo Default</b></p> <ul style="list-style-type: none"> <li>5–90</li> </ul>	<p>Set the quality of a text or photo image in relation to file size and the quality of the image.</p> <p><b>Note:</b> 75 is the factory default setting.</p>
<p><b>Photo Default</b></p> <ul style="list-style-type: none"> <li>5–90</li> </ul>	<p>Set the quality of a photo image in relation to file size and the quality of the image.</p> <p><b>Note:</b> 50 is the factory default setting.</p>

Use	To
<b>E-mail images sent as</b> Attachment Web Link	Specify how the images are sent. <b>Note:</b> Attachment is the factory default setting.
<b>Use Multi-Page Tiff</b> On Off	Choose between single-page TIFF files and multiple-page TIFF files. For a multiple-page scan-to-e-mail job, either one TIFF file is created containing all the pages, or multiple TIFF files are created with one file for each page of the job. <b>Notes:</b> <ul style="list-style-type: none"> <li>• On is the factory default setting.</li> <li>• This menu setting applies to all scan functions.</li> </ul>
<b>Transmission Log</b> Print log Do not print log Print only for error	Specify whether to print the transmission log. <b>Note:</b> Print log is the factory default setting.
<b>Log Paper Source</b> Tray [x] Multipurpose Feeder	Specify the paper source for printing e-mail logs. <b>Note:</b> Tray 1 is the factory default setting.
<b>Log Output Bin</b> Standard Bin Bin [x]	Specify the bin for FTP logs. <b>Notes:</b> <ul style="list-style-type: none"> <li>• Standard Bin is the factory default setting.</li> <li>• Bin [x] appears only when at least one optional bin is installed.</li> </ul>
<b>E-mail Bit Depth</b> 1 bit 8 bit	Enable the Text/Photo mode to produce smaller file sizes by using 1-bit images when Color is set to Off. <b>Note:</b> 8 bit is the factory default setting.
<b>Custom Job scanning</b> On Off	Copy a document that contains mixed paper sizes. <b>Notes:</b> <ul style="list-style-type: none"> <li>• Off is the factory default setting.</li> <li>• This menu item appears only when a formatted, working printer hard disk is installed.</li> </ul>
<b>Scan Preview</b> On Off	Specify whether a preview appears on the display for scan jobs. <b>Notes:</b> <ul style="list-style-type: none"> <li>• Off is the factory default setting.</li> <li>• This menu item appears only when a formatted, working printer hard disk is installed.</li> </ul>
<b>Allow Save as Shortcut</b> On Off	Save e-mail addresses as shortcuts. <b>Notes:</b> <ul style="list-style-type: none"> <li>• On is the factory default setting.</li> <li>• When set to Off, the Save As Shortcut button does not appear on the e-mail Destination screen.</li> </ul>

Use	To
<b>Background Removal</b> -4 to 4	Adjust the amount of background visible on a scanned image. <b>Note:</b> 0 is the factory default setting.
<b>Color Balance</b> Cyan - Red Magenta - Green Yellow - Blue	Enable an equal balance of colors in the scanned image.
<b>Color Dropout</b> Color Dropout None Red Green Blue Default Red Threshold 0–255 Default Green Threshold 0–255 Default Blue Threshold 0–255	Specify which color to drop during scanning and to adjust the dropout setting for each color threshold. <b>Notes:</b> <ul style="list-style-type: none"> <li>• None is the factory default setting for Color Dropout.</li> <li>• 128 is the factory default setting for each color threshold.</li> </ul>
<b>Contrast</b> 0–5 Best for content	Specify the contrast of the output. <b>Note:</b> Best for content is the factory default setting.
<b>Mirror Image</b> Off On	Create a mirror image of the original document. <b>Note:</b> Off is the factory default setting.
<b>Negative Image</b> Off On	Create a negative image of the original document. <b>Note:</b> Off is the factory default setting.
<b>Shadow Detail</b> -4 to 4	Adjust the amount of shadow detail visible on a scanned image. <b>Note:</b> 0 is the factory default setting.
<b>Scan edge to edge</b> Off On	Specify whether the original document is scanned edge-to-edge. <b>Note:</b> Off is the factory default setting.
<b>Sharpness</b> 1–5	Adjust the amount of sharpness on a scanned image. <b>Note:</b> 3 is the factory default setting.
<b>Temperature</b> -4 to 4	Specify warm or cool outputs. Cool values generate a bluer output than the default while warm values generate a redder output than the default. <b>Note:</b> 0 is the factory default setting.
<b>Use cc:/bcc:</b> Off On	Enable the use of the “cc:” and “bcc:” fields. <b>Note:</b> Off is the factory default setting.

## FTP Settings menu

Use	To
<b>Format</b> PDF (.pdf) Secure PDF (.pdf) TIFF (.tif) JPEG (.jpg) XPS (.xps)	Specify the format of the file for FTP sending. <b>Note:</b> PDF (.pdf) is the factory default setting.
<b>PDF Version</b> 1.2–1.7 A–1a	Set the version level of the PDF file for FTP sending. <b>Note:</b> 1.5 is the factory default setting.
<b>Content Type</b> Text Graphics Text/Photo Photo	Specify the content of the original document. <b>Note:</b> Text/Photo is the factory default setting.
<b>Content Source</b> Black/White Laser Color Laser Inkjet Photo/Film Magazine Newspaper Press Other	Specify how the original document was produced. <b>Note:</b> Black/White Laser is the factory default setting.
<b>Color</b> Off On	Specify whether the printer captures and transmits content in color or in black and white. <b>Note:</b> On is the factory default setting.
<b>Resolution</b> 75 dpi 150 dpi 200 dpi 300 dpi 400 dpi 600 dpi	Specify the quality of the scan in dots per inch (dpi). <b>Note:</b> 150 dpi is the factory default setting.
<b>Darkness</b> 1–9	Lighten or darken the output. <b>Note:</b> 5 is the factory default setting.
<b>Orientation</b> Portrait Landscape	Specify the page orientation of the scanned image. <b>Note:</b> Portrait is the factory default setting.

Use	To
<p><b>Original Size</b></p> <ul style="list-style-type: none"> <li>Letter</li> <li>Legal</li> <li>Executive</li> <li>Folio</li> <li>Statement</li> <li>Oficio (Mexico)</li> <li>Universal</li> <li>Auto Size Sense</li> <li>Mixed Sizes</li> <li>A3</li> <li>A4</li> <li>A5</li> <li>A6</li> <li>JIS B4</li> <li>JIS B5</li> <li>Custom Scan Size [x]</li> <li>Book Original</li> <li>Business Card</li> <li>3 x 5 in.</li> <li>4 x 6 in.</li> </ul>	<p>Specify the size of the original document.</p> <p><b>Note:</b> Letter is the U.S. factory default setting. A4 is the international factory default setting.</p>
<p><b>Sides (Duplex)</b></p> <ul style="list-style-type: none"> <li>Off</li> <li>Long edge</li> <li>Short edge</li> </ul>	<p>Specify the page orientation of text and graphics.</p> <p><b>Notes:</b></p> <ul style="list-style-type: none"> <li>• Off is the factory default setting.</li> <li>• Long edge assumes binding along the long edge of the page (left edge for portrait and top edge for landscape).</li> <li>• Short edge assumes binding along the short edge of the page (top edge for portrait and left edge for landscape).</li> </ul>
<p><b>JPEG Quality</b></p> <ul style="list-style-type: none"> <li>Best for content</li> <li>5–90</li> </ul>	<p>Set the quality of a JPEG photo image in relation to the file size and quality of the image.</p> <p><b>Notes:</b></p> <ul style="list-style-type: none"> <li>• Best for content is the factory default setting.</li> <li>• 5 reduces the file size, but the quality of the image is lessened.</li> <li>• 90 provides the best image quality, but the file size is very large.</li> <li>• This menu setting applies to all scan functions.</li> </ul>
<p><b>Text Default</b></p> <ul style="list-style-type: none"> <li>5–90</li> </ul>	<p>Set the quality of the text in relation to the file size and quality of the image.</p> <p><b>Note:</b> 75 is the factory default setting.</p>
<p><b>Text/Photo Default</b></p> <ul style="list-style-type: none"> <li>5–90</li> </ul>	<p>Set the quality of a text/photo image in relation to the file size and quality of the image.</p> <p><b>Note:</b> 75 is the factory default setting.</p>
<p><b>Photo Default</b></p> <ul style="list-style-type: none"> <li>5–90</li> </ul>	<p>Set the quality of a photo image in relation to the file size and quality of the image.</p> <p><b>Note:</b> 50 is the factory default setting.</p>



Use	To
<b>Use Multi-Page TIFF</b> On Off	Provide a choice between single-page TIFF files and multiple-page TIFF files. For a multiple-page scan-to-FTP job, either one TIFF file is created containing all the pages, or multiple TIFF files are created with one file for each page of the job.  <b>Notes:</b> <ul style="list-style-type: none"> <li>• On is the factory default setting.</li> <li>• This menu setting applies to all scan functions.</li> </ul>
<b>Transmission Log</b> Print log Do not print log Print only for error	Specify whether to print the transmission log.  <b>Note:</b> Print log is the factory default setting.
<b>Log Paper Source</b> Tray [x] Multipurpose Feeder	Specify a paper source when printing FTP logs.  <b>Note:</b> Tray 1 is the factory default setting.
<b>Log Output Bin</b> Standard Bin Bin [x]	Specify the bin for FTP logs.  <b>Notes:</b> <ul style="list-style-type: none"> <li>• Standard Bin is the factory default setting.</li> <li>• Bin [x] appears only when an optional bin is installed.</li> </ul>
<b>FTP bit Depth</b> 1 bit 8 bit	Enable the Text/Photo mode to have smaller file sizes by using 1-bit images when Color is set to Off.  <b>Note:</b> 8 bit is the factory default setting.
<b>File Name</b>	Enter a base file name.
<b>Custom Job Scanning</b> On Off	Copy a document that contains mixed paper sizes into a single scan job.  <b>Notes:</b> <ul style="list-style-type: none"> <li>• Off is the factory default setting.</li> <li>• This menu item appears only when a formatted, working printer hard disk is installed.</li> </ul>
<b>Scan Preview</b> On Off	Specify whether a preview appears on the display for scan jobs.  <b>Notes:</b> <ul style="list-style-type: none"> <li>• Off is the factory default setting.</li> <li>• This menu item appears only when a formatted, working printer hard disk is installed.</li> </ul>
<b>Allow Save as Shortcut</b> On Off	Enable shortcut creation for FTP addresses.  <b>Note:</b> On is the factory default setting.
<b>Background Removal</b> -4 to 4	Adjust the amount of background visible on a copy.  <b>Note:</b> 0 is the factory default setting.

Use	To
<b>Color Balance</b> Cyan - Red Magenta - Green Yellow - Blue	Enable an equal balance of colors in the scanned image.
<b>Color Dropout</b> Color Dropout None Red Green Blue Default Red Threshold 0–255 Default Green Threshold 0–255 Default Blue Threshold 0–255	Specify which color to drop during scanning and to adjust the dropout setting for each color threshold.  <b>Notes:</b> <ul style="list-style-type: none"> <li>• None is the factory default setting for Color Dropout.</li> <li>• 128 is the factory default setting for each color threshold.</li> </ul>
<b>Contrast</b> 0–5 Best for content	Specify the contrast of the output.  <b>Note:</b> Best for content is the factory default setting.
<b>Mirror Image</b> Off On	Create a mirror image of the original document.  <b>Note:</b> Off is the factory default setting.
<b>Negative Image</b> Off On	Create a negative image of the original document.  <b>Note:</b> Off is the factory default setting.
<b>Shadow Detail</b> -4 to 4	Adjust the amount of shadow detail visible on a scanned image.  <b>Note:</b> 0 is the factory default setting.
<b>Scan edge to edge</b> Off On	Specify whether the original document is scanned edge-to-edge.  <b>Note:</b> Off is the factory default setting.
<b>Sharpness</b> 1–5	Adjust the amount of sharpness of a scanned image.  <b>Note:</b> 3 is the factory default setting.
<b>Temperature</b> -4 to 4	Specify warm or cool outputs. Cool values generate a bluer output than the default while warm values generate a redder output than the default.  <b>Note:</b> 0 is the factory default setting.

## Flash Drive menu

### Scan Settings

Use	To
<b>Format</b> PDF (.pdf) Secure PDF TIFF (.tif) JPEG (.jpg) XPS (.xps)	Specify the format of the file to be sent through FTP. <b>Note:</b> PDF (.pdf) is the factory default setting.
<b>PDF Version</b> 1.2–1.7 A–1a	Set the version of the PDF file to be sent through FTP. <b>Note:</b> 1.5 is the factory default setting.
<b>Content Type</b> Text Graphics Text/Photo Photo	Specify the content of the original document. <b>Note:</b> Text/Photo is the factory default setting.
<b>Content Source</b> Black/White Laser Color Laser Inkjet Photo/Film Magazine Newspaper Press Other	Specify how the original document was produced. <b>Note:</b> Black/White Laser is the factory default setting.
<b>Color</b> On Off	Specify whether the printer captures and transmits content in color or in black and white. <b>Note:</b> On is the factory default setting.
<b>Resolution</b> 75 dpi 150 dpi 200 dpi 300 dpi 400 dpi 600 dpi	Specify the resolution of the scan in dots per inch (dpi). <b>Note:</b> 150 dpi is the factory default setting.
<b>Darkness</b> 1–9	Lighten or darken the output. <b>Note:</b> 5 is the factory default setting.
<b>Orientation</b> Portrait Landscape	Specify the orientation of the scanned image. <b>Note:</b> Portrait is the factory default setting.

Use	To
<p><b>Original Size</b></p> <ul style="list-style-type: none"> <li>Letter</li> <li>Legal</li> <li>Executive</li> <li>Folio</li> <li>Statement</li> <li>Oficio (Mexico)</li> <li>Universal</li> <li>Auto Size Sense</li> <li>Mixed Sizes</li> <li>A3</li> <li>A4</li> <li>A5</li> <li>A6</li> <li>JIS B4</li> <li>JIS B5</li> <li>Custom Scan Size [x]</li> <li>Book Original</li> <li>Business Card</li> <li>3 x 5 in.</li> <li>4 x 6 in.</li> </ul>	<p>Specify the size of the original document.</p> <p><b>Note:</b> Letter is the U.S. factory default setting. A4 is the international factory default setting.</p>
<p><b>Sides (Duplex)</b></p> <ul style="list-style-type: none"> <li>Off</li> <li>Long edge</li> <li>Short edge</li> </ul>	<p>Specify the page orientation of text and graphics.</p> <p><b>Notes:</b></p> <ul style="list-style-type: none"> <li>• Off is the factory default setting.</li> <li>• Long edge assumes binding along the long edge of the page (left edge for portrait and top edge for landscape).</li> <li>• Short edge assumes binding along the short edge of the page (top edge for portrait and left edge for landscape).</li> </ul>
<p><b>JPEG Quality</b></p> <ul style="list-style-type: none"> <li>Best for content</li> <li>5–90</li> </ul>	<p>Set the quality of a JPEG photo image in relation to file size and quality.</p> <p><b>Notes:</b></p> <ul style="list-style-type: none"> <li>• Best for content is the factory default setting.</li> <li>• 5 reduces the file size, but the quality of the image is lessened.</li> <li>• 90 provides the best image quality, but the file size is very large.</li> <li>• This menu applies to all scan functions.</li> </ul>
<p><b>Text Default</b></p> <ul style="list-style-type: none"> <li>5–90</li> </ul>	<p>Set the quality of the text in relation to file size and the quality of the image.</p> <p><b>Note:</b> 75 is the factory default setting.</p>
<p><b>Text/Photo Default</b></p> <ul style="list-style-type: none"> <li>5–90</li> </ul>	<p>Set the quality of a text/photo image in relation to file size and quality.</p> <p><b>Note:</b> 75 is the factory default setting.</p>
<p><b>Photo Default</b></p> <ul style="list-style-type: none"> <li>5–90</li> </ul>	<p>Set the quality of a photo image in relation to file size and quality.</p> <p><b>Note:</b> 50 is the factory default setting.</p>

Use	To
<b>Use Multi-Page TIFF</b> On Off	Provide a choice between single-page TIFF files and multiple-page TIFF files. For a multiple-page scan to FTP job, either one TIFF file is created containing all the pages, or multiple TIFF files are created with one file for each page.  <b>Notes:</b> <ul style="list-style-type: none"> <li>• On is the factory default setting.</li> <li>• This menu applies to all scan functions.</li> </ul>
<b>Scan Bit Depth</b> 1 bit 8 bit	Enable the Text/Photo mode to have smaller file sizes by using 1-bit images when Color is set to Off.  <b>Note:</b> 8 bit is the factory default setting.
<b>File Name</b>	Enter a base file name.  <b>Note:</b> A maximum of 53 characters is allowed.
<b>Custom Job Scanning</b> On Off	Copy a document containing mixed paper sizes in a single copy job.  <b>Notes:</b> <ul style="list-style-type: none"> <li>• Off is the factory default setting.</li> <li>• This menu item appears only when a formatted, working printer hard disk is installed.</li> </ul>
<b>Scan Preview</b> On Off	Specify whether a preview appears on the display for scan jobs.  <b>Notes:</b> <ul style="list-style-type: none"> <li>• Off is the factory default setting.</li> <li>• This menu item appears only when a formatted, working printer hard disk is installed.</li> </ul>
<b>Background Removal</b> -4 to 4	Adjust the amount of background visible on a copy.  <b>Note:</b> 0 is the factory default setting.
<b>Color Balance</b> Cyan - Red Magenta - Green Yellow - Blue	Enable an equal balance of colors in the scanned image.
<b>Color Dropout</b> Color Dropout None Red Green Blue Default Red Threshold 0–255 Default Green Threshold 0–255 Default Blue Threshold 0–255	Specify which color to drop during scanning and to adjust the dropout setting for each color threshold.  <b>Notes:</b> <ul style="list-style-type: none"> <li>• None is the factory default setting for Color Dropout.</li> <li>• 128 is the factory default setting for each color threshold.</li> </ul>

Use	To
<b>Contrast</b> 0–5 Best for content	Specify the contrast of the scanned image. <b>Note:</b> Best for content is the factory default setting.
<b>Mirror Image</b> Off On	Create a mirror image of the original document. <b>Note:</b> Off is the factory default setting.
<b>Negative Image</b> Off On	Create a negative image of the original document. <b>Note:</b> Off is the factory default setting.
<b>Shadow Detail</b> -4 to 4	Adjust the amount of shadow detail visible on a scanned image. <b>Note:</b> 0 is the factory default setting.
<b>Scan edge to edge</b> Off On	Specify whether the original document is scanned edge-to-edge. <b>Note:</b> Off is the factory default setting.
<b>Sharpness</b> 1–5	Adjust the amount of sharpness on a scanned image. <b>Note:</b> 3 is the factory default setting.
<b>Temperature</b> -4 to 4	Specify warm or cool outputs. Cool values generate a bluer output than the default while warm values generate a redder output than the default. <b>Note:</b> 0 is the factory default setting.

## Print Settings

<b>Copies</b> 1–999	Specify a default number of copies for each print job. <b>Note:</b> 1 is the factory default setting.
<b>Paper Source</b> Tray [x] Multipurpose Feeder Manual Paper Manual Envelope	Set a default paper source for all print jobs. <b>Note:</b> Tray 1 is the factory default setting.
<b>Collate</b> (1,1,1) (2,2,2) (1,2,3) (1,2,3)	Stack the pages of a print job in sequence when printing multiple copies. <b>Note:</b> (1,2,3) (1,2,3) is the factory default setting.
<b>Sides (Duplex)</b> 1 sided 2 sided	Specify whether prints are on one side or on both sides of the page. <b>Note:</b> 1 sided is the factory default setting.
<b>Staple</b> Off On	Specify whether prints are stapled. <b>Notes:</b> <ul style="list-style-type: none"> <li>Off is the factory default setting.</li> <li>This menu item appears only when a staple finisher is installed.</li> </ul>

<b>Hole Punch</b> Off On	Specify whether prints have punched holes. <b>Notes:</b> <ul style="list-style-type: none"> <li>Off is the factory default setting.</li> <li>This menu item appears only when a supported staple, hole punch finisher is installed.</li> </ul>
<b>Hole Punch Mode</b> 2 holes 3 holes 4 holes	Specify the number of holes to be made on the prints. <b>Notes:</b> <ul style="list-style-type: none"> <li>3 holes is the U.S. factory default setting. 4 holes is the international factory default setting.</li> <li>This menu item appears only when a supported staple, hole punch finisher is installed.</li> </ul>
<b>Duplex Binding</b> Long edge Short edge	Define binding for two-sided pages in relation to the page orientation of the printed document. <b>Notes:</b> <ul style="list-style-type: none"> <li>Long edge assumes binding along the long edge of the page (left edge for portrait and top edge for landscape).</li> <li>Short edge assumes binding along the short edge of the page (top edge for portrait and left edge for landscape).</li> </ul>
<b>Paper Saver Orientation</b> Auto Landscape Portrait	Specify the orientation of a multiple-page document. <b>Note:</b> Auto is the factory default setting. The printer chooses between portrait and landscape.
<b>Paper Saver</b> Off 2-Up 3-Up 4-Up 6-Up 9-Up 12-Up 16-Up	Specify that multiple-page images be printed on one side of a paper. <b>Notes:</b> <ul style="list-style-type: none"> <li>Off is the factory default setting.</li> <li>The number selected is the number of page images that are printed per side.</li> </ul>
<b>Paper Saver Border</b> None Solid	Print a border on each page image. <b>Note:</b> None is the factory default setting.
<b>Paper Saver Ordering</b> Horizontal Reverse Horizontal Reverse Vertical Vertical	Specify the positioning of multiple-page images. <b>Notes:</b> <ul style="list-style-type: none"> <li>Horizontal is the factory default setting.</li> <li>Positioning depends on the number of page images and whether they are in portrait or landscape orientation.</li> </ul>

<p><b>Separator Sheets</b> Off Between Copies Between Jobs Between Pages</p>	<p>Specify whether blank separator sheets are inserted.</p> <p><b>Notes:</b></p> <ul style="list-style-type: none"> <li>• Off is the factory default setting.</li> <li>• Between Copies inserts a blank sheet between each copy of a print job if Collate is set to (1,2,3) (1,2,3). If Collate is set to (1,1,1) (2,2,2), then a blank page is inserted between each set of printed pages, such as after all page 1's and after all page 2's.</li> <li>• Between Jobs inserts a blank sheet between print jobs.</li> <li>• Between Pages inserts a blank sheet between each page of the print job. This setting is useful when printing transparencies or when inserting blank pages in a document .</li> </ul>
<p><b>Separator Sheet Source</b> Tray [x] Multipurpose Feeder</p>	<p>Specify the paper source for the separator sheet.</p> <p><b>Note:</b> Tray 1 is the factory default setting.</p>
<p><b>Blank Pages</b> Do Not Print Print</p>	<p>Specify whether blank pages are inserted in a print job.</p> <p><b>Note:</b> Do Not Print is the factory default setting.</p>

## Print Settings

### Setup menu

Use	To
<p><b>Printer Language</b> PCL Emulation PS Emulation</p>	<p>Set the default printer language.</p> <p><b>Notes:</b></p> <ul style="list-style-type: none"> <li>• PCL Emulation is the factory default setting.</li> <li>• PostScript emulation uses a PostScript interpreter for processing print jobs.</li> <li>• PCL Emulation uses a PCL interpreter for processing print jobs.</li> <li>• Setting a printer language default does not prevent a software program from sending print jobs that use another printer language.</li> </ul>
<p><b>Job Waiting</b> On Off</p>	<p>Determine if print jobs are removed from the print queue when they require unavailable printer options or custom settings. These print jobs are stored in a separate print queue, so other jobs print normally. When the missing information or options, or both are obtained, the stored jobs print.</p> <p><b>Notes:</b></p> <ul style="list-style-type: none"> <li>• Off is the factory default setting.</li> <li>• This menu appears only if a non-read-only printer hard disk is installed. This requirement ensures that stored jobs are not deleted if the printer loses power.</li> </ul>



Use	To
<p><b>Print Area</b></p> <ul style="list-style-type: none"> <li>Normal</li> <li>Whole Page</li> </ul>	<p>Set the logical and physical printable area.</p> <p><b>Notes:</b></p> <ul style="list-style-type: none"> <li>• Normal is the factory default setting. When attempting to print data in the non-printable area defined by the Normal setting, the printer clips the image at the boundary.</li> <li>• Whole Page allows the image to be moved into the non-printable area defined by the Normal setting, but the printer clips the image at the Normal setting boundary. This setting affects only pages printed using a PCL 5e interpreter and has no effect on pages printed using the PCL XL or PostScript interpreter.</li> </ul>
<p><b>Download Target</b></p> <ul style="list-style-type: none"> <li>RAM</li> <li>Flash</li> <li>Disk</li> </ul>	<p>Set the storage location for downloads.</p> <p><b>Notes:</b></p> <ul style="list-style-type: none"> <li>• RAM is the factory default setting. Storing downloads in the RAM is temporary.</li> <li>• Storing downloads in a flash memory or in a printer hard disk places them in permanent storage. Downloads remain in the flash memory or printer hard disk even when the printer is turned off.</li> <li>• This menu item appears only if an optional flash memory or printer hard disk is installed.</li> </ul>
<p><b>Resource Save</b></p> <ul style="list-style-type: none"> <li>On</li> <li>Off</li> </ul>	<p>Specify how the printer handles temporary downloads, such as fonts and macros stored in the RAM, when the printer receives a print job that requires more than the available memory.</p> <p><b>Notes:</b></p> <ul style="list-style-type: none"> <li>• Off is the factory default setting. Off sets the printer to retain downloads only until memory is needed. Downloads are deleted in order to process print jobs.</li> <li>• On sets the printer to retain downloads during language changes and printer resets. If the printer runs out of memory, then <b>Memory Full [38]</b> appears on the printer display, but downloads are not deleted.</li> </ul>
<p><b>Print All Order</b></p> <ul style="list-style-type: none"> <li>Alphabetical</li> <li>Oldest First</li> <li>Newest First</li> </ul>	<p>Specify the order in which held and confidential jobs are printed when Print All is selected.</p> <p><b>Note:</b> Alphabetical is the factory default setting</p>

## Finishing menu

Use	To
<b>Sides (Duplex)</b> 1 sided 2 sided	Specify whether two-sided printing is set as the default for all print jobs.  <b>Notes:</b> <ul style="list-style-type: none"> <li>• 1 sided is the factory default setting.</li> <li>• You can set two-sided printing from the printer software.</li> </ul>
<b>Duplex Binding</b> Long Edge Short Edge	Define the way two-sided pages are bound and printed.  <b>Notes:</b> <ul style="list-style-type: none"> <li>• Long Edge is the factory default setting. This assumes binding along the long edge of the page (left edge for portrait and top edge for landscape).</li> <li>• Short Edge assumes binding along the short edge of the page (top edge for portrait and left edge for landscape).</li> </ul>
<b>Copies</b> 1–999	Specify the default number of copies for each print job.  <b>Note:</b> 1 is the factory default setting.
<b>Blank Pages</b> Do Not Print Print	Specify whether blank pages are inserted in a print job.  <b>Note:</b> Do Not Print is the factory default setting.
<b>Collate</b> (1,1,1) (2,2,2) (1,2,3) (1,2,3)	Stack the pages of a print job in sequence when printing multiple copies.  <b>Note:</b> (1,2,3) (1,2,3) is the factory default setting.
<b>Separator Sheets</b> Off Between Copies Between Jobs Between Pages	Specify whether blank separator sheets are inserted.  <b>Notes:</b> <ul style="list-style-type: none"> <li>• Off is the factory default setting.</li> <li>• Between Copies inserts a blank sheet between each copy of a print job if Collate is set to (1,2,3) (1,2,3). If Collate is set to (1,1,1) (2,2,2), then a blank page is inserted between each set of printed pages, such as after all page 1's and after all page 2's.</li> <li>• Between Jobs inserts a blank sheet between print jobs.</li> <li>• Between Pages inserts a blank sheet between each page of a print job. This setting is useful when printing transparencies or when inserting blank pages in a document.</li> </ul>
<b>Separator Source</b> Tray [x] Multipurpose Feeder	Specify the paper source for the separator sheet.  <b>Notes:</b> <ul style="list-style-type: none"> <li>• Tray 1 (standard tray) is the factory default setting.</li> <li>• From the Paper menu, set Configure MP to "Cassette" for Multipurpose Feeder to appear as a menu setting.</li> </ul>

Use	To
<b>Paper Saver</b> Off 2-Up 3-Up 4-Up 6-Up 9-Up 12-Up 16-Up	Print multiple-page images on one side of a paper. <b>Notes:</b> <ul style="list-style-type: none"> <li>• Off is the factory default setting.</li> <li>• The number selected is the number of page images that are printed per side.</li> </ul>
<b>Paper Saver Ordering</b> Horizontal Reverse Horizontal Reverse Vertical Vertical	Specify the positioning of multiple-page images when using Paper Saver. <b>Notes:</b> <ul style="list-style-type: none"> <li>• Horizontal is the factory default setting.</li> <li>• Positioning depends on the number of page images and whether they are in portrait or landscape orientation.</li> </ul>
<b>Paper Saver Orientation</b> Auto Landscape Portrait	Specify the orientation of a multiple-page document. <b>Note:</b> Auto is the factory default setting. The printer chooses between portrait and landscape.
<b>Paper Saver Border</b> None Solid	Print a border when using Paper Saver. <b>Note:</b> None is the factory default setting.
<b>Staple Job</b> Auto Back Dual Front Off	Specify whether printed output is stapled. <b>Notes:</b> <ul style="list-style-type: none"> <li>• Off is the factory default setting.</li> <li>• This menu appears only when a supported staple finisher is installed.</li> </ul>
<b>Run Stapler Test</b>	Print a report that confirms that the staple finisher is functioning properly. <b>Note:</b> This menu appears only when a supported staple finisher is installed.
<b>Hole Punch</b> On Off	Specify whether holes are created on printed outputs for the purpose of collecting the sheets in a binder or folder. <b>Notes:</b> <ul style="list-style-type: none"> <li>• Off is the factory default setting.</li> <li>• This menu appears only when a supported staple, hole punch finisher is installed.</li> </ul>

Use	To
<b>Hole Punch Mode</b> 2 holes 3 holes 4 holes	Specify the number of holes to be created on printed outputs for the purpose of collecting the sheets in a binder or folder.  <b>Notes:</b> <ul style="list-style-type: none"> <li>• 3 holes is the U.S. factory default setting. 4 holes is the international factory default setting.</li> <li>• This menu appears only when a supported staple, hole punch finisher is installed.</li> </ul>
<b>Offset Pages</b> None Between Copies Between Jobs	Offset pages at certain instances.  <b>Notes:</b> <ul style="list-style-type: none"> <li>• None is the factory default setting.</li> <li>• Between Copies offsets each copy of a print job if Collate is set to (1,2,3) (1,2,3). If Collate is set to (1,1,1) (2,2,2), then each set of printed pages are offset, such as all page 1's and all page 2's.</li> <li>• Between Jobs sets the same offset position for the entire print job regardless of the number of copies printed.</li> <li>• This menu appears only when a supported staple finisher is installed.</li> </ul>

## Quality menu

Use	To
<b>Print Resolution</b> 300 dpi 600 dpi 1200 dpi 1200 Image Q 2400 Image Q	Specify the printed output resolution in dots per inch.  <b>Note:</b> 600 dpi is the factory default setting.
<b>Pixel Boost</b> Off Fonts Horizontally Vertically Both directions	Enable more pixels to print in clusters for clarity, in order to enhance images horizontally or vertically, or to enhance fonts.  <b>Note:</b> Off is the factory default setting.
<b>Toner Darkness</b> 1–10	Lighten or darken the printed output.  <b>Notes:</b> <ul style="list-style-type: none"> <li>• 8 is the factory default setting.</li> <li>• Selecting a smaller number can help conserve toner.</li> </ul>

Use	To
<b>Enhance Fine Lines</b> On Off	Enable a print mode preferable for files such as architectural drawings, maps, electrical circuit diagrams, and flow charts. <b>Notes:</b> <ul style="list-style-type: none"> <li>• Off is the factory default setting.</li> <li>• You can set this option from the printer software. For Windows users, click <b>File &gt; Print</b>, and then click <b>Properties, Preferences, Options, or Setup</b>. For Macintosh users, choose <b>File &gt; Print</b>, and then adjust the settings from the Print dialog and context menus.</li> <li>• To set this option using the Embedded Web Server, type the network printer IP address in the Web browser address field.</li> </ul>
<b>Gray Correction</b> Auto Off	Automatically adjust the contrast enhancement applied to images. <b>Note:</b> Auto is the factory default setting.
<b>Brightness</b> -6 to 6	Adjust the printed output either by lightening or darkening it. You can conserve toner by lightening the output. <b>Note:</b> 0 is the factory default setting.
<b>Contrast</b> 0–5	Adjust the contrast of printed objects. <b>Note:</b> 0 is the factory default setting.

## Job Accounting menu

**Note:** This menu item appears only when a formatted, working printer hard disk is installed.

Use	To
<b>Job Accounting Log</b> Off On	Determine and set if the printer creates a log of the print jobs it receives. <b>Note:</b> Off is the factory default setting.
<b>Job Accounting Utilities</b>	Print and delete log files or export them to a flash drive.
<b>Accounting Log Frequency</b> Daily Weekly Monthly	Determine and set how often a log file is created. <b>Note:</b> Monthly is the factory default setting.
<b>Log Action at End of Frequency</b> None E-mail Current Log E-mail & Delete Current Log Post Current Log Post & Delete Current Log	Determine and set how the printer responds when the frequency threshold expires. <b>Note:</b> None is the factory default setting.
<b>Log Near Full Level</b> Off 1–99	Specify the maximum size of the log file before the printer executes the Log Action at Near Full. <b>Note:</b> 5 is the factory default setting.

Use	To
<b>Log Action at Near Full</b> None E-mail Current Log E-mail & Delete Current Log E-mail & Delete Oldest Log Post Current Log Post & Delete Current Log Post & Delete Oldest Log Delete Current Log Delete Oldest Log Delete All Logs Delete All But Current	Determine and set how the printer responds when the hard disk is nearly full.  <b>Notes:</b> <ul style="list-style-type: none"> <li>• None is the factory default setting.</li> <li>• The value defined in Log Near Full Level determines when this action is triggered.</li> </ul>
<b>Log Action at Full</b> None E-mail & Delete Current Log E-mail & Delete Oldest Log Post & Delete Current Log Post & Delete Oldest Log Delete Current Log Delete Oldest Log Delete All Logs Delete All But Current	Determine and set how the printer responds when disk usage reaches the maximum limit (100MB).  <b>Note:</b> None is the factory default setting.
<b>URL to Post Logs</b>	Determine and set where the printer posts job accounting logs.
<b>E-mail Address to Send Logs</b>	Specify the e-mail address to which the printer sends job accounting logs.
<b>Log File Prefix</b>	Specify the prefix you want for the log file name.  <b>Note:</b> The current host name defined in the TCP/IP menu is used as the default log file prefix.

## Utilities menu

Use	To
<b>Remove Held Jobs</b> Confidential Held Not Restored All	Delete confidential and held jobs from the printer hard disk.  <b>Notes:</b> <ul style="list-style-type: none"> <li>• Selecting a setting affects only print jobs that are resident in the printer. Bookmarks, print jobs on flash drives, and other types of held jobs are not affected.</li> <li>• Not Restored removes all Print and Hold jobs that are <i>not</i> restored from the printer hard disk or memory.</li> </ul>

Use	To
<b>Format Flash</b> Yes No	Format the flash memory. <b>Warning—Potential Damage:</b> Do not turn off the printer while the flash memory is being formatted. <b>Notes:</b> <ul style="list-style-type: none"> <li>• Yes deletes all data stored in flash memory.</li> <li>• No cancels the format request.</li> <li>• Flash memory refers to the memory added by installing a flash memory card in the printer.</li> <li>• The flash memory option card must not be read/write- or write-protected.</li> <li>• This menu item appears only when a non-defective flash memory card is installed.</li> </ul>
<b>Delete Downloads on Disk</b> Delete Now Do Not Delete	Delete downloads from the printer hard disk, including all held jobs, buffered jobs, and parked jobs. <b>Notes:</b> <ul style="list-style-type: none"> <li>• Delete Now sets the printer to delete the downloads and allows the display to return to the originating screen after the deletion.</li> <li>• Do Not Delete sets the printer to return to the originating screen after the deletion.</li> </ul>
<b>Activate Hex Trace</b>	Assist in isolating the source of a print job problem. <b>Notes:</b> <ul style="list-style-type: none"> <li>• When activated, all data sent to the printer is printed in hexadecimal and character representation, and control codes are not executed.</li> <li>• To exit or deactivate Hex Trace, turn off or reset the printer.</li> </ul>
<b>Coverage Estimator</b> Off On	Provide an estimate of the percentage coverage of toner on a page. The estimate is printed on a separate page at the end of each print job. <b>Note:</b> Off is the factory default setting.

### XPS menu

Use	To
<b>Print Error Pages</b> Off On	Print a page containing information on errors, including XML markup errors. <b>Note:</b> Off is the factory default setting.

### PDF menu

Use	To
<b>Scale to Fit</b> Yes No	Scale page content to fit the selected paper size. <b>Note:</b> No is the factory default setting.

Use	To
<b>Annotations</b> Do Not Print Print	Print annotations in a PDF. <b>Note:</b> Do Not Print is the factory default setting.

## PostScript menu

Use	To
<b>Print PS Error</b> On Off	Print a page containing the PostScript error. <b>Note:</b> Off is the factory default setting.
<b>Lock PS Startup Mode</b> On Off	Disable the SysStart file. <b>Note:</b> Off is the factory default setting.
<b>Font Priority</b> Resident Flash/Disk	Establish the font search order. <b>Notes:</b> <ul style="list-style-type: none"> <li>• Resident is the factory default setting.</li> <li>• This menu item is available only when a formatted flash memory option card or printer hard disk is installed and operating properly.</li> <li>• Make sure the flash memory option or printer hard disk is not read/write-, write-, or password-protected.</li> <li>• Job Buffer Size must not be set to 100%.</li> </ul>

## PCL Emul menu

Use	To
<b>Font Source</b> Resident Disk Download Flash All	Specify the set of fonts used by the Font Name menu. <b>Notes:</b> <ul style="list-style-type: none"> <li>• “Resident” is the factory default setting. Resident shows the factory default set of fonts downloaded in the RAM.</li> <li>• “Flash” and “Disk” settings show all fonts resident in that option.</li> <li>• The flash option must be properly formatted and cannot be read/write-, write-, or password-protected.</li> <li>• “Download” shows all the fonts downloaded in the RAM.</li> <li>• “All” shows all fonts available to any option.</li> </ul>
<b>Font Name</b> Courier 10	Identify a specific font and the option where it is stored. <b>Note:</b> Courier 10 is the factory default setting. Courier 10 shows the font name, font ID, and the storage location in the printer. The font source abbreviation is R for Resident, F for Flash, K for Disk, and D for Download.



Use	To
<b>Symbol Set</b> 10U PC-8 12U PC-850	Specify the symbol set for each font name.  <b>Notes:</b> <ul style="list-style-type: none"> <li>• 10U PC-8 is the US factory default setting. 12U PC-850 is the international factory default setting.</li> <li>• A symbol set is a set of alphabetic and numeric characters, punctuation, and special symbols. Symbol sets support the different languages or specific programs such as math symbols for scientific text. Only the supported symbol sets are shown.</li> </ul>
<b>PCL Emulation Settings</b> Point Size 1.00–1008.00	Change the point size for scalable typographic fonts.  <b>Notes:</b> <ul style="list-style-type: none"> <li>• 12 is the factory default setting.</li> <li>• Point size refers to the height of the characters in the font. One point equals approximately 0.014 inch.</li> <li>• Point sizes can be increased or decreased in 0.25-point increments.</li> </ul>
<b>PCL Emulation Settings</b> Pitch 0.08–100	Specify the font pitch for scalable monospaced fonts.  <b>Notes:</b> <ul style="list-style-type: none"> <li>• 10 is the factory default setting.</li> <li>• Pitch refers to the number of fixed-space characters per inch (cpi).</li> <li>• Pitch can be increased or decreased in 0.01-cpi increments.</li> <li>• For nonscalable monospaced fonts, the pitch appears on the display but it cannot be changed.</li> </ul>
<b>PCL Emulation Settings</b> Orientation Portrait Landscape	Specify the orientation of text and graphics on the page.  <b>Notes:</b> <ul style="list-style-type: none"> <li>• Portrait is the factory default setting. Portrait prints text and graphics parallel to the short edge of the page.</li> <li>• Landscape prints text and graphics parallel to the long edge of the page.</li> </ul>
<b>PCL Emulation Settings</b> Lines per Page 1–255	Specify the number of lines that print on each page.  <b>Notes:</b> <ul style="list-style-type: none"> <li>• 60 is the US factory default setting. 64 is the international default setting.</li> <li>• The printer sets the amount of space between each line based on the Lines per Page, Paper Size, and Orientation settings. Select the Paper Size and Orientation you want before setting Lines per Page.</li> </ul>
<b>PCL Emulation Settings</b> A4 Width 198 mm 203 mm	Set the printer to print on A4-size paper.  <b>Notes:</b> <ul style="list-style-type: none"> <li>• “198 mm” is the factory default setting.</li> <li>• The 203-mm setting sets the width of the page to allow printing of eighty 10-pitch characters.</li> </ul>

Use	To
<b>PCL Emulation Settings</b> Auto CR after LF On Off	Specify whether the printer automatically performs a carriage return (CR) after a line feed (LF) control command. <b>Note:</b> Off is the factory default setting.
<b>PCL Emulation Settings</b> Auto LF after CR On Off	Specify whether the printer automatically performs a line feed (LF) after a carriage return (CR) control command. <b>Note:</b> Off is the factory default setting.
<b>Tray Renumber</b> Assign MP Feeder Off None 0–199 Assign Tray [x] Off None 0–199 Assign Manual Paper Off None 0–199 Assign Manual Env Off None 0–199	Configure the printer to work with printer software or programs that use different source assignments for trays and feeders. <b>Notes:</b> <ul style="list-style-type: none"> <li>• “Off” is the factory default setting.</li> <li>• “None” ignores the Select Paper Feed command. This option appears only when it is selected by the PCL 5 interpreter.</li> <li>• “0–199” allows a custom setting to be assigned.</li> </ul>
<b>Tray Renumber</b> View Factory Defaults MPF Default = 8 T1 Default = 1 T1 Default = 4 T1 Default = 5 T1 Default = 20 T1 Default = 21 Env Default = 6 MPaper Default = 2 MEnv Default = 3	Display the factory default setting assigned to each tray or feeder.
<b>Tray Renumber</b> Restore Defaults Yes No	Restore all tray and feeder assignments to the factory default settings.

### HTML menu

Use		To
<b>Font Name</b> Albertus MT Antique Olive Apple Chancery Arial MT Avant Garde Bodoni Bookman Chicago Clarendon Cooper Black Copperplate Coronet Courier Eurostile Garamond Geneva Gill Sans Goudy Helvetica Hoefler Text Intl CG Times Intl Courier Intl Univers	Joanna MT Letter Gothic Lubalin Graph Marigold MonaLisa Recut Monaco New CenturySbk New York Optima Oxford Palatino StempelGaramond Taffy Times TimesNewRoman Univers Zapf Chancery NewSansMTJA NewSansMTCS NewSansMTCT NewSansMTKO	Set the default font for HTML documents.  <b>Note:</b> The Times font is used in HTML documents that do not specify a font.

Use	To
<b>Font Size</b> 1–255 pt	Set the default font size for HTML documents.  <b>Notes:</b> <ul style="list-style-type: none"> <li>• 12 pt is the factory default setting.</li> <li>• Font size can be increased in 1-point increments.</li> </ul>
<b>Scale</b> 1–400%	Scale the default font for HTML documents.  <b>Notes:</b> <ul style="list-style-type: none"> <li>• 100% is the factory default setting.</li> <li>• Scaling can be increased in 1% increments.</li> </ul>
<b>Orientation</b> Portrait Landscape	Set the page orientation for HTML documents.  <b>Note:</b> Portrait is the factory default setting.

Use	To
<b>Margin Size</b> 8–255 mm	Set the page margin for HTML documents.  <b>Notes:</b> <ul style="list-style-type: none"> <li>• 19 mm is the factory default setting.</li> <li>• Margin size can be increased in 1-mm increments.</li> </ul>
<b>Backgrounds</b> Do Not Print Print	Specify whether to print backgrounds on HTML documents.  <b>Note:</b> Print is the factory default setting.

## Image menu

Use	To
<b>Auto Fit</b> On Off	Select the optimal paper size, scaling, and orientation.  <b>Note:</b> On is the factory default setting. It overrides scaling and orientation settings for some images.
<b>Invert</b> On Off	Invert bitonal monochrome images.  <b>Notes:</b> <ul style="list-style-type: none"> <li>• Off is the factory default setting.</li> <li>• This setting does not apply to GIF or JPEG images.</li> </ul>
<b>Scaling</b> Anchor Top Left Best Fit Anchor Center Fit Height/Width Fit Height Fit Width	Scale the image to fit the selected paper size.  <b>Notes:</b> <ul style="list-style-type: none"> <li>• Best Fit is the factory default setting.</li> <li>• When Auto Fit is set to On, Scaling is automatically set to Best Fit.</li> </ul>
<b>Orientation</b> Portrait Landscape Reverse Portrait Reverse Landscape	Set the image orientation.  <b>Note:</b> Portrait is the factory default setting.

## Help menu

Menu item	Description
Print All Guides	Prints all the guides
Copy Guide	Provides information about making copies and configuring the settings
E-mail Guide	Provides information about sending e-mails and configuring the settings
Fax Guide	Provides information about sending faxes and configuring the settings
FTP Guide	Provides information about scanning documents and configuring the settings

Menu item	Description
Print Defects Guide	Provides a template for determining the cause of repeating print quality defects, and lists settings that can be used to adjust print quality
Information Guide	Provides help in locating additional information
Supplies Guide	Provides information about ordering supplies

# Saving money and the environment

Lexmark is committed to environmental sustainability and is continually improving its printers to reduce their impact on the environment. We design with the environment in mind, engineer our packaging to reduce materials, and provide collection and recycling programs. For more information, see:

- The Notices chapter
- The Environmental Sustainability section of the Lexmark Web site at [www.lexmark.com/environment](http://www.lexmark.com/environment)
- The Lexmark recycling program at [www.lexmark.com/recycle](http://www.lexmark.com/recycle)

By selecting certain printer settings or tasks, you may be able to reduce your printer's impact even further. This chapter outlines the settings and tasks that may yield a greater environmental benefit.

## Saving paper and toner

Studies show that as much as 80% of the carbon footprint of a printer is related to paper usage. You can significantly reduce your carbon footprint by using recycled paper and the following printing suggestions, such as printing on both sides of the paper and printing multiple pages on one side of a single sheet of paper.

### Using recycled paper

As an environmentally conscious company, Lexmark supports the use of recycled office paper produced specifically for use in laser printers. For more information on recycled papers that work well with your printer, see [“Using recycled paper and other office papers” on page 61](#).

### Conserving supplies

#### Use both sides of the paper

If your printer model supports two-sided printing, then you can control whether print appears on one or two sides of the paper.

#### Notes:

- Two-sided printing is the default setting in the print driver.
- For a complete list of supported products and countries, go to <http://support.lexmark.com>.

#### Place multiple pages on one sheet of paper

You can print up to 16 consecutive pages of a multiple-page document onto one side of a single sheet of paper by setting multiple page printing (N-Up) for the print job.

#### Check your first draft for accuracy

Before printing or making multiple copies of a document:

- Use the preview feature to see how the document looks like before you print it.
- Print one copy of the document to check its content and format for accuracy.

## Avoid paper jams

Correctly set the paper type and size to avoid paper jams. For more information, see [“Avoiding jams” on page 242](#).

## Saving energy

### Using Hibernate mode

Hibernate is an ultra-low-power operating mode.

#### Notes:

- Three days is the default amount of time before the printer enters Hibernate mode.
- Make sure to wake the printer from Hibernate mode before sending a print job. A hard reset or a long press of the Sleep button wakes the printer from Hibernate mode.
- If the printer is in Hibernate mode, then the Embedded Web Server is disabled.

1 From the home screen, navigate to:



> **Settings** > **General Settings**

2 From the “Press Sleep Button” or “Press and Hold Sleep Button” menu, select **Hibernate**, and then touch **Submit**.

### Using Eco-Mode

1 Open a Web browser, and then type the printer IP address in the address field.

#### Notes:

- View the printer IP address on the printer home screen. The IP address appears as four sets of numbers separated by periods, such as 123.123.123.123.
- If you are using a proxy server, then temporarily disable it to load the Web page correctly.

2 Click **Settings** > **General Settings** > **Eco-Mode** > select a setting

Use	To
Off	Use the factory default settings for all settings associated with Eco-Mode. Off supports the performance specifications of the printer.
Energy	Reduce energy use, especially when the printer is idle. <ul style="list-style-type: none"> <li>• Printer engine motors do not start until it is ready to print. You may notice a short delay before the first page is printed.</li> <li>• The printer enters Sleep mode after one minute of inactivity.</li> </ul>
Energy/Paper	Use all the settings associated with Energy and Paper modes.
Plain Paper	<ul style="list-style-type: none"> <li>• Enable the automatic two-sided (duplex) feature.</li> <li>• Turn off print log features.</li> </ul>

3 Click **Submit**.

## Adjusting Sleep mode

1 From the home screen, navigate to:

 > **Settings** > **General Settings** > **Timeouts** > **Sleep Mode**

2 In the Sleep Mode field, select the number of minutes the printer is idle before it enters Sleep mode.

3 Apply the changes.

## Adjusting the brightness of the printer display

To save energy, or if you have trouble reading the display, adjust its brightness settings.

### Using the Embedded Web Server

1 Open a Web browser, and then type the printer IP address in the address field.

**Notes:**

- View the printer IP address in the TCP/IP section in the Network/Ports menu. The IP address appears as four sets of numbers separated by periods, such as 123.123.123.123.
- If you are using a proxy server, then temporarily disable it to load the Web page correctly.

2 Click **Settings** > **General Settings**.

3 In the Screen Brightness field, enter the brightness percentage you want for the display.

4 Click **Submit**.

## Recycling

Lexmark provides collection programs and environmentally progressive approaches to recycling. For more information, see:

- The Notices chapter
- The Environmental Sustainability section of the Lexmark Web site at [www.lexmark.com/environment](http://www.lexmark.com/environment)
- The Lexmark recycling program at [www.lexmark.com/recycle](http://www.lexmark.com/recycle)

### Recycling Lexmark products

To return Lexmark products for recycling:

1 Go to [www.lexmark.com/recycle](http://www.lexmark.com/recycle).

2 Find the product type you want to recycle, and then select your country or region from the list.

3 Follow the instructions on the computer screen.

**Note:** Printer supplies and hardware not listed in the Lexmark collection program may be recycled through your local recycling center. Contact your local recycling center to determine the items they accept.



## Recycling Lexmark packaging

Lexmark continually strives to minimize packaging. Less packaging helps to ensure that Lexmark printers are transported in the most efficient and environmentally sensitive manner and that there is less packaging to dispose of. These efficiencies result in fewer greenhouse emissions, energy savings, and natural resource savings.

Lexmark cartons are 100% recyclable where corrugated recycling facilities exist. Facilities may not exist in your area.

The foam used in Lexmark packaging is recyclable where foam recycling facilities exist. Facilities may not exist in your area.

When you return a cartridge to Lexmark, you can reuse the box that the cartridge came in. Lexmark will recycle the box.

## Returning Lexmark cartridges for reuse or recycling

Lexmark Cartridge Collection Program diverts millions of Lexmark cartridges from landfills annually by making it both easy and free for Lexmark customers to return used cartridges to Lexmark for reuse or recycling. One hundred percent of the empty cartridges returned to Lexmark are either reused or demanufactured for recycling. Boxes used to return the cartridges are also recycled.

To return Lexmark cartridges for reuse or recycling, follow the instructions that came with your printer or cartridge and use the prepaid shipping label. You can also do the following:

- 1 Go to [www.lexmark.com/recycle](http://www.lexmark.com/recycle).
- 2 From the Toner Cartridges section, select your country or region.
- 3 Follow the instructions on the computer screen.

## Securing the printer

### Using the security lock feature

The printer is equipped with a security lock feature. When a lock compatible with most laptop computers is attached, the printer is locked. When locked, the controller board shield and the controller board cannot be removed. Attach a security lock to the printer in the location shown.

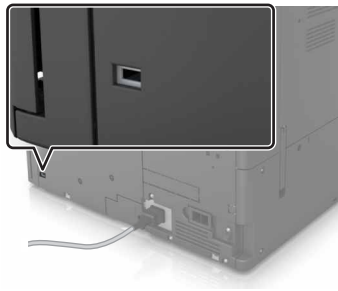

### Statement of Volatility

Your printer contains various types of memory that can store device and network settings, and user data.

Type of memory	Description
Volatile memory	Your printer uses standard <i>random access memory</i> (RAM) to temporarily buffer user data during simple print jobs.
Non-volatile memory	Your printer may use two forms of non-volatile memory: EEPROM and NAND (flash memory). Both types are used to store the operating system, device settings, network information, bookmark settings, and embedded solutions.
Hard disk memory	Some printers have a hard disk drive installed. The printer hard disk is designed for device-specific functionality. This lets the device retain buffered user data from complex print jobs, as well as form data, and font data.

Erase the content of any installed printer memory in the following circumstances:

- The printer is being decommissioned.
- The printer hard disk is being replaced.
- The printer is being moved to a different department or location.
- The printer is being serviced by someone from outside your organization.
- The printer is being removed from your premises for service.
- The printer is being sold to another organization.

#### Disposing of a printer hard disk

**Note:** Some printer models may not have a printer hard disk installed.

In high-security environments, it may be necessary to take additional steps to make sure that confidential data stored in the printer hard disk cannot be accessed when the printer—or its hard disk—is removed from your premises.

- **Degaussing**—Flushes the hard disk with a magnetic field that erases stored data
- **Crushing**—Physically compresses the hard disk to break component parts and render them unreadable
- **Milling**—Physically shreds the hard disk into small metal bits

**Note:** Most data can be erased electronically, but the only way to guarantee that all data is completely erased is to physically destroy each hard disk where data is stored.

## Erasing volatile memory

The volatile memory (RAM) installed in your printer requires a power source to retain information. To erase the buffered data, simply turn off the printer.

## Erasing non-volatile memory

Erase individual settings, device and network settings, security settings, and embedded solutions by following these steps:

- 1 Turn off the printer.
- 2 From the control panel, hold down **2** and **6** while turning the printer on. Release the buttons when the screen with the progress bar appears.
- 3 From the Configuration menu, navigate to:  
**Restore Factory Defaults > Erase Printer Memory > Yes**  
The printer restarts several times during this process.
- 4 Touch **Back**, and then exit the Configuration menu.

**Note:** The printer performs a power-on reset, and then returns to normal operating mode.

## Erasing printer hard disk memory

- 1 Turn off the printer.
- 2 From the control panel, hold down **2** and **6** while turning the printer on. Release the buttons when the screen with the progress bar appears.
- 3 From the Configuration menu, navigate to:  
**Restore Factory Defaults > Erase Hard Disk > select the method to erase the hard disk memory > Yes**  
**Note:** This process can take from several minutes to more than an hour, during which the printer is unavailable for other user tasks.
- 4 Touch **Back**, and then exit the Configuration menu.

**Note:** The printer performs a power-on reset, and then returns to normal operating mode.

## Configuring printer hard disk encryption

Enable hard disk encryption to prevent loss of sensitive data in the event the printer or its hard disk is stolen.

**Note:** Some printer models may not have a hard disk installed.

- 1 Turn off the printer.
- 2 From the control panel, hold down **2** and **6** while turning the printer on. Release the buttons only when the screen with the progress bar appears.
- 3 Touch **Disk Encryption > Enable**.

**Note:** Enabling disk encryption erases the contents of the hard disk.

- 4 Touch **Yes** to proceed with disk wiping.

**Notes:**

- Do not turn off the printer during the encryption process. Doing so may result in loss of data.
- Disk encryption can take from several minutes to more than an hour, during which the printer is unavailable for other user tasks.
- A status bar indicates the progress of the disk wiping task. After the disk is encrypted, the printer returns to the Enable/Disable screen.

- 5 Touch **Back**, and then exit the Configuration menu.

**Note:** The printer performs a power-on reset, and then returns to normal operating mode.

## Finding printer security information

In high-security environments, it may be necessary to take additional steps to make sure that confidential data stored in the printer cannot be accessed by unauthorized persons. For more information, go to the [Lexmark security Web page](#) or see the *Embedded Web Server—Security: Administrator's Guide* at <http://support.lexmark.com>.

# Maintaining the printer

**Warning—Potential Damage:** Failure to maintain optimum printer performance, or to replace parts and supplies, may cause damage to your printer.

## Cleaning printer parts

### Cleaning the printer

**Note:** You may need to perform this task after every few months.

**Warning—Potential Damage:** Damage to the printer caused by improper handling is not covered by the printer warranty.

- 1 Make sure that the printer is turned off and unplugged from the electrical outlet.



**CAUTION—SHOCK HAZARD:** To avoid the risk of electrical shock when cleaning the exterior of the printer, unplug the power cord from the electrical outlet and disconnect all cables from the printer before proceeding.

- 2 Remove paper from the standard bin and multipurpose feeder.
- 3 Remove any dust, lint, and pieces of paper around the printer using a soft brush or vacuum.
- 4 Dampen a clean, lint-free cloth with water, and use it to wipe the outside of the printer.

**Warning—Potential Damage:** Do not use household cleaners or detergents to prevent damage to the exterior of the printer.

- 5 Make sure all areas of the printer are dry before sending a new print job.

### Cleaning the scanner glass

Clean the scanner glass if you encounter print quality problems, such as streaks on copied or scanned images.

- 1 Open the scanner cover.

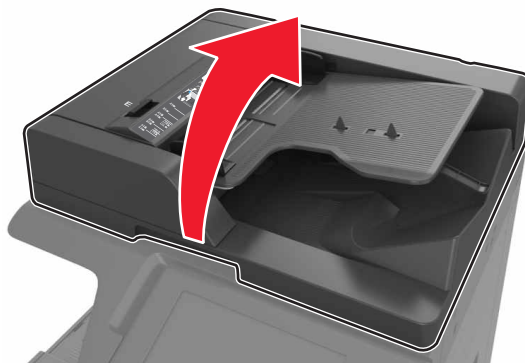

2 Wipe the areas shown with a soft or lint-free cloth.



1	White underside of the scanner cover
2	Scanner glass
3	ADF glass
4	White underside of the ADF cover

3 Close the scanner cover.

### Cleaning the charger and the printhead lens

1 Open the bottom front door.

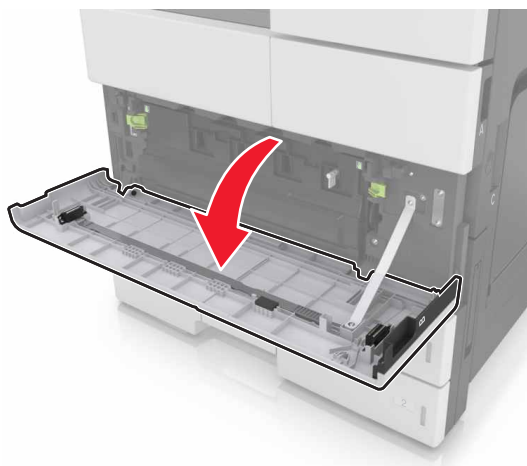

**2** Remove the waste toner bottle.

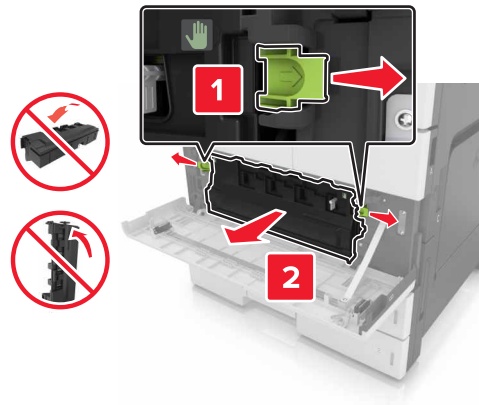

**3** Locate the white tab.

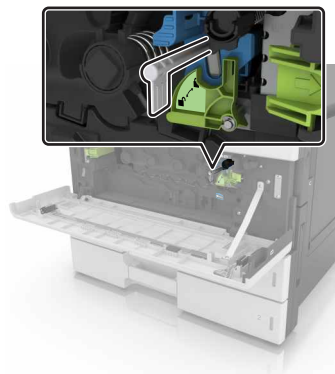

**4** Gently pull the tab until it stops, and then slowly slide it back into place. Repeat three times.

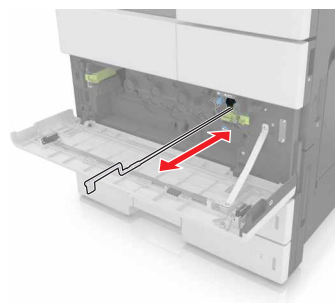

5 Remove the printhead wiper.

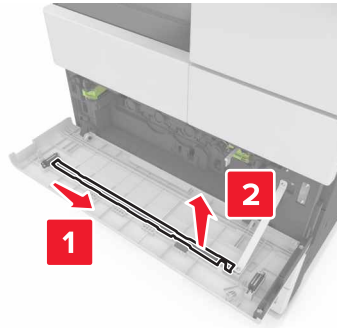

6 Insert the wiper into the hole until it stops, and then slide it out. Repeat three times.

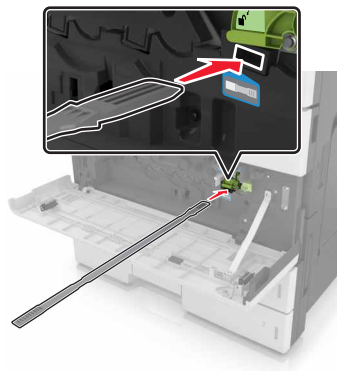

7 Put the wiper back to its holder.

8 Reinstall the waste toner bottle.

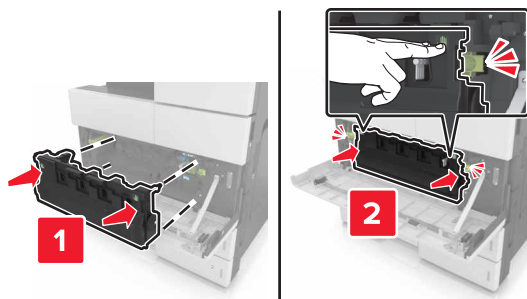

9 Close the bottom front door.



## Emptying the hole punch box

- 1 Open door H.

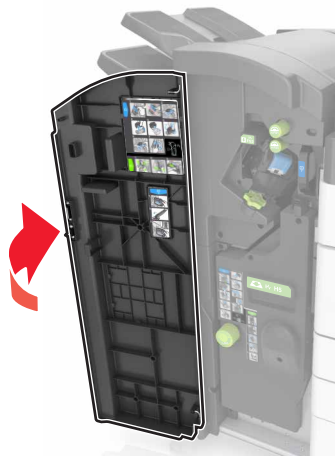

- 2 Remove and empty the hole punch box.

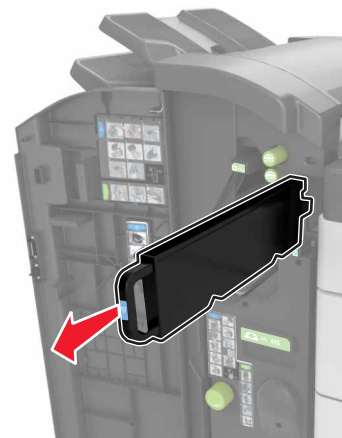

- 3 Reinstall the hole punch box.

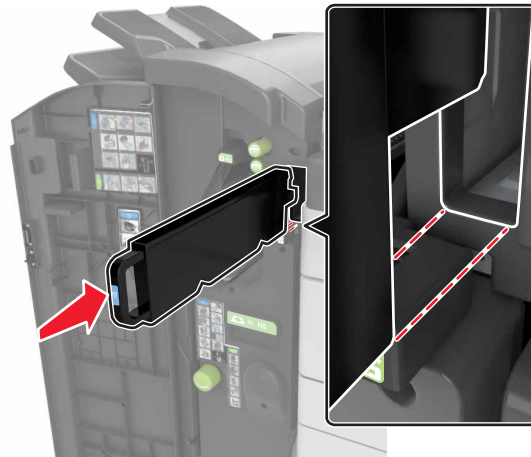

- 4 Close door H.

## Checking the status of parts and supplies

A message appears on the display when a replacement supply item is needed or when maintenance is required.

### Checking the status of parts and supplies on the printer control panel

From the home screen, touch **Status/Supplies** > **View Supplies**.

### Checking the status of parts and supplies from the Embedded Web Server

**Note:** Make sure the computer and the printer are connected to the same network.

- 1 Open a Web browser, and then type the printer IP address in the address field.

**Notes:**

- View the printer IP address on the home screen. The IP address appears as four sets of numbers separated by periods, such as 123.123.123.123.
- If you are using a proxy server, then temporarily disable it to load the Web page correctly.

- 2 Click **Device Status** > **More Details**.

## Estimated number of remaining pages

The estimated number of remaining pages is based on the recent printing history of the printer. Its accuracy may vary significantly and is dependent on many factors, such as actual document content, print quality settings, and other printer settings.

The accuracy of the estimated number of remaining pages may decrease when the actual printing consumption is different from the historical printing consumption. Consider the variable level of accuracy before purchasing or replacing supplies based on the estimate. Until an adequate print history is obtained on the printer, initial estimates assume future supplies consumption based on the International Organization for Standardization\* test methods and page content.

\* Average continuous black declared cartridge yield in accordance with ISO/IEC 19752.

## Ordering supplies

To order parts and supplies in the U.S., contact Lexmark at 1-800-539-6275 for information about Lexmark Authorized Supplies Dealers in your area. In other countries or regions, go to the Lexmark Web site at [www.lexmark.com](http://www.lexmark.com) or contact the place where you purchased the printer.

**Note:** All life estimates for printer supplies assume printing on letter- or A4-size plain paper.

## Using genuine Lexmark parts and supplies

Your Lexmark printer is designed to function best with genuine Lexmark supplies and parts. Use of third-party supplies or parts may affect the performance, reliability, or life of the printer and its imaging components. Use of third-party supplies or parts can affect warranty coverage. Damage caused by the use of third-party supplies or parts is not covered by the warranty. All life indicators are designed to function with Lexmark supplies and parts, and may deliver unpredictable results if third-party supplies or parts are used. Imaging component usage beyond the intended life may damage your Lexmark printer or its associated components.

## Ordering a toner cartridge

### Notes:

- The estimated cartridge yield is based on the ISO/IEC 19752 standard.
- Extremely low print coverage for extended periods of time may negatively affect actual yield.

Part name	Part number
High Yield Toner Cartridge	64G0H00

## Ordering a photoconductor unit

Extremely low print coverage for extended periods of time may cause photoconductor unit parts to fail prior to exhaustion of toner.

Item	Part number
Photoconductor unit	54G0P00

## Ordering a waste toner bottle

Item	Part number
Waste toner bottle	54G0W00

## Ordering staple cartridges

Item	Part number
Staple cartridges	25A0013

## Ordering a 300K maintenance kit

**Note:** To replace the parts included in the maintenance kit, see the instruction sheet that came with each part.

Item	Part number
Maintenance kit	40X9669

## Storing parts and supplies

### Storing supplies

Choose a cool, clean storage area for the printer supplies. Store supplies right side up in their original packing until you are ready to use them.

Do not expose supplies to:

- Direct sunlight
- Temperatures above 35°C (95°F)
- High humidity above 80%
- Salty air
- Corrosive gases
- Heavy dust

### Storing the rollers

Your printer comes with replacement rollers stored in the compartment inside the standard trays. After you purchase new rollers, make sure to store them in the compartments inside the trays.

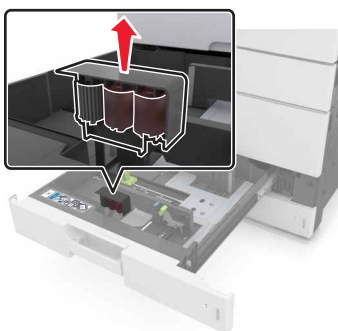

**Note:** For proper disposal of parts and supplies, see [“Recycling” on page 200](#).

## Replacing supplies

### Replacing a photoconductor unit

- 1 Open the bottom front door.



- 2 Remove the waste toner bottle.

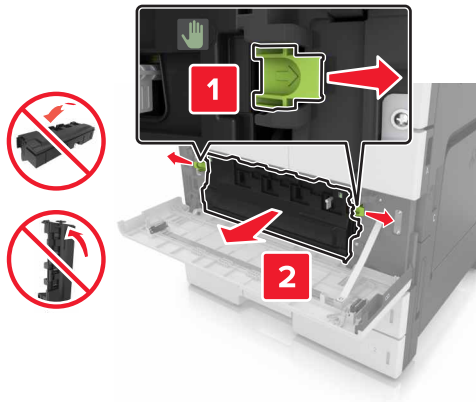

3 Unlock the photoconductor unit.

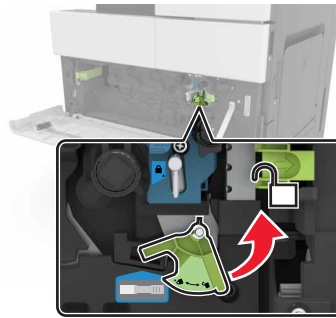

4 Remove the photoconductor unit.

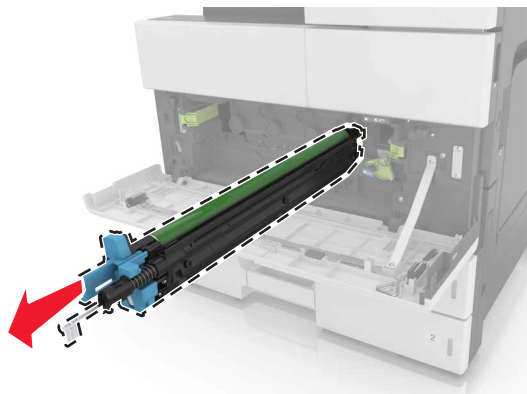

5 Unpack the new photoconductor unit.

**Warning—Potential Damage:** Do not expose the photoconductor unit to direct light for more than 10 minutes. Extended exposure to light may cause print quality problems.

**Warning—Potential Damage:** Do not touch the photoconductor drum. Doing so may affect the print quality of future print jobs.

6 Install the photoconductor unit.

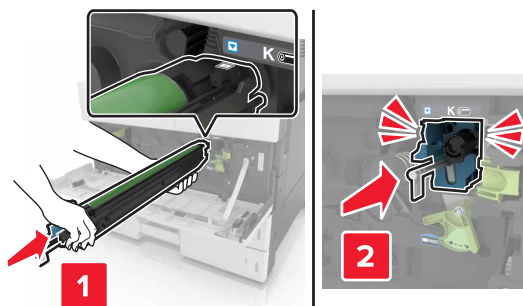

7 Lock the photoconductor unit.

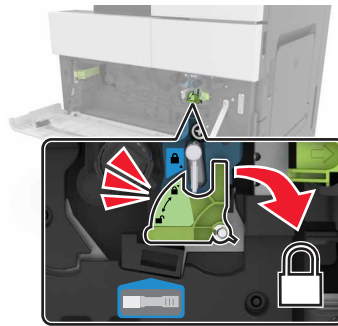

8 Reinstall the waste toner bottle.

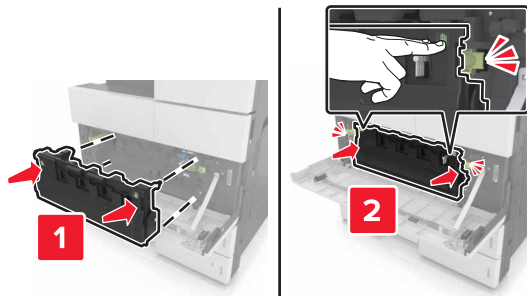

9 Close the bottom front door.

## Replacing the staple cartridge

### Replacing the staple cartridge in the staple finisher

**Note:** The staple finisher is supported only in select printer models.

1 Press the latch on the staple finisher, and then slide the finisher to the left.

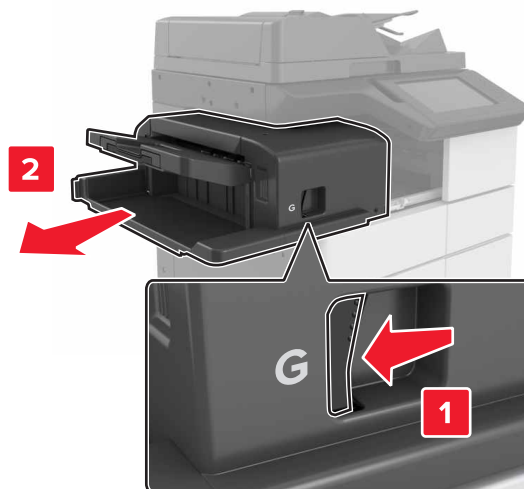

2 Remove the staple cartridge holder.



3 Remove the empty staple cartridge from the cartridge holder.

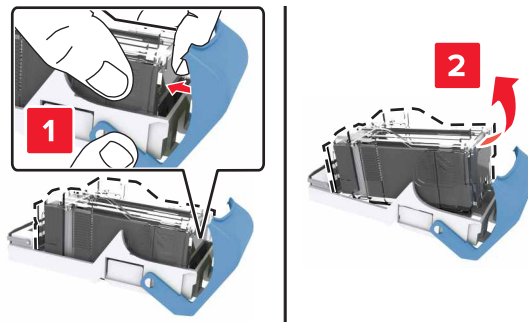

4 Insert the new cartridge into the cartridge holder.

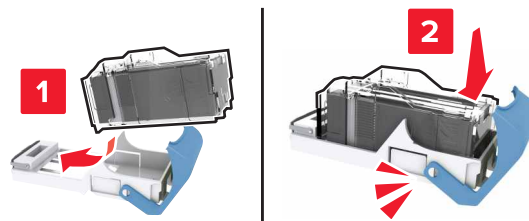



5 Push the cartridge holder into the finisher until the holder *clicks* into place.

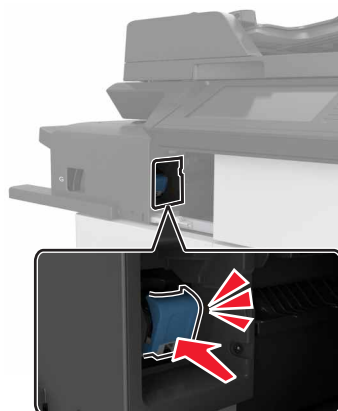

6 Slide the finisher back into place.

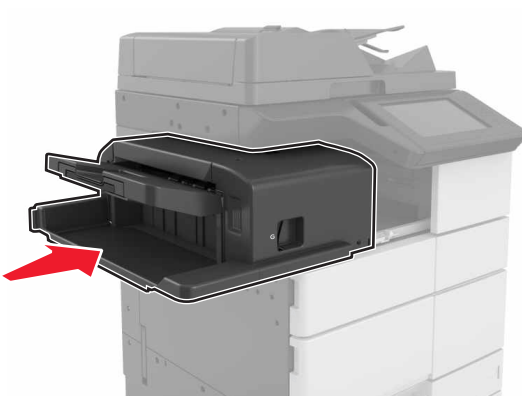

## Replacing the staple cartridge in the booklet finisher

- 1 Open door H, and then pull out the booklet maker.



- 2 Remove the staple cartridge holder.

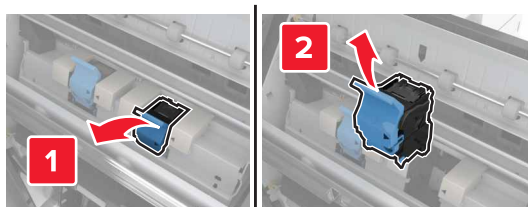

**3** Remove the empty staple cartridge from the cartridge holder.

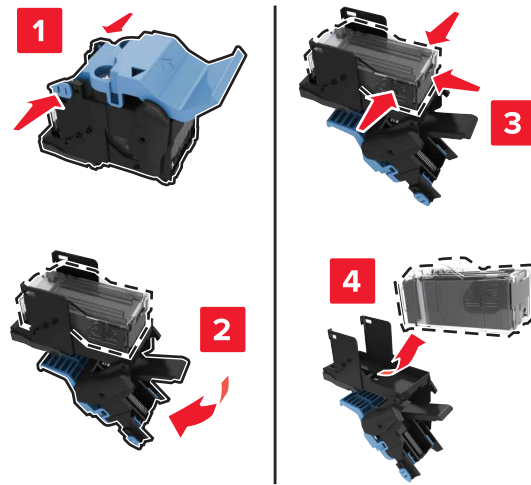

**4** Insert the new cartridge into the cartridge holder.

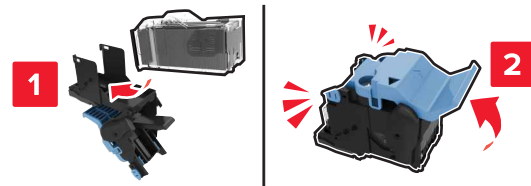

**5** Push the cartridge holder into the booklet maker until the holder *clicks* into place.

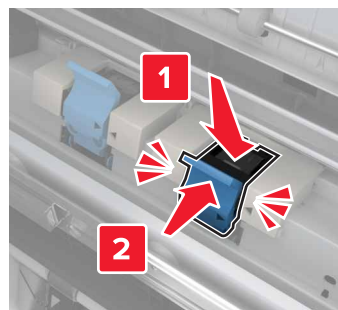

**6** Push the booklet maker back into place, and then close the door.

## Replacing the staple cartridge in the staple, hole punch finisher

- 1 Open door H.

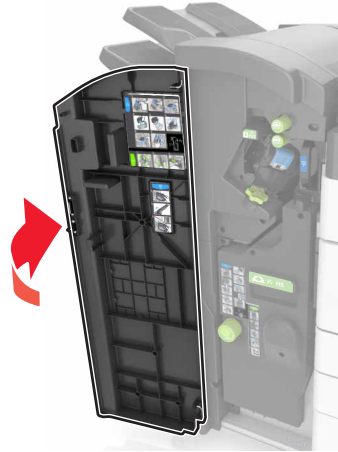

- 2 Remove the staple cartridge holder.

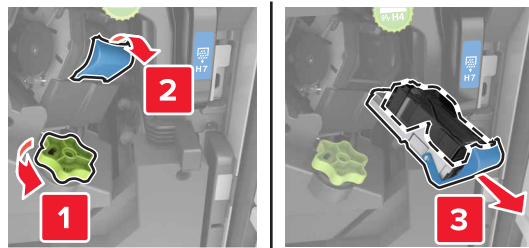

- 3 Remove the empty staple cartridge from the cartridge holder.

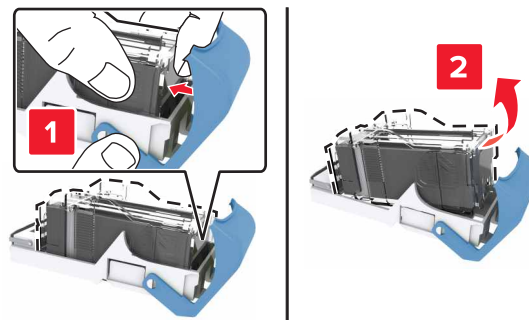

4 Insert the new cartridge into the cartridge holder.

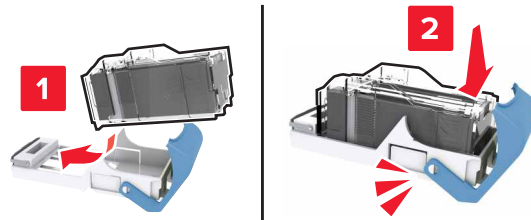

5 Push the cartridge holder into the finisher until the holder *clicks* into place.



6 Close door H.

## Replacing the toner cartridge

1 Open the top front door.



2 Rotate the toner cartridge counterclockwise, and then pull it out.



- 3 Unpack the new toner cartridge, remove the packing material, and then shake the cartridge to redistribute the toner.

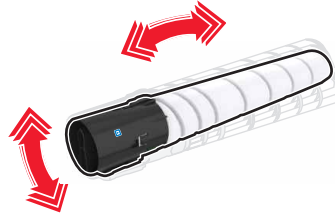

- 4 Insert the toner cartridge into the printer.



- 5 Rotate the cartridge clockwise to lock it into place.

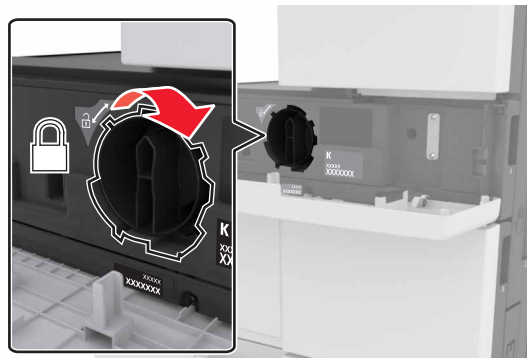

- 6 Close the top front door.



- 7 Clean the charger and the printhead lens. For more information, see [“Cleaning the charger and the printhead lens” on page 206](#).

## Replacing the waste toner bottle

- 1 Open the bottom front door.



- 2 Remove the waste toner bottle.

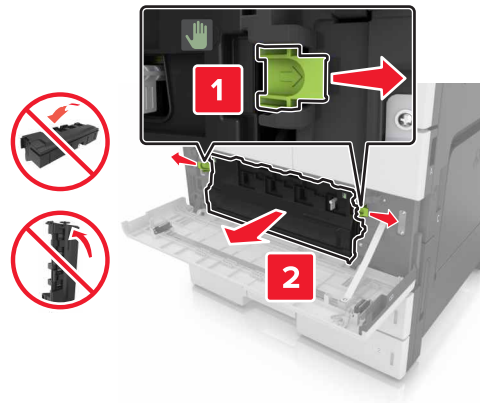

- 3 Clean the charger and the printhead lens. For more information, see steps 3–7 of [“Cleaning the charger and the printhead lens”](#) on page 206.
- 4 Unpack the new waste toner bottle.
- 5 Insert the new waste toner bottle into the printer until it *clicks* into place.

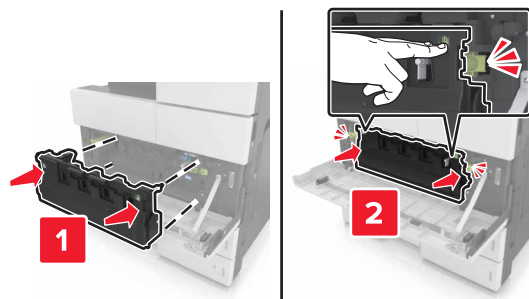

- 6 Close the bottom front door.



# Replacing the 300K maintenance kit

## Replacing the exhaust and ozone filters

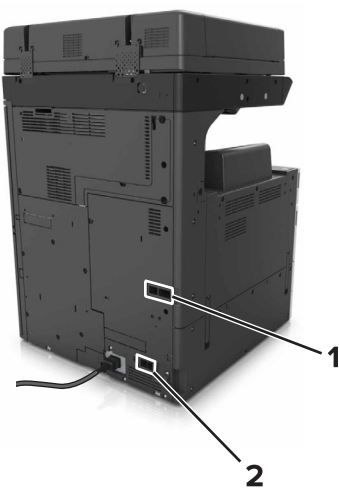

1	Exhaust filter
2	Ozone filter

### Replacing the exhaust filter

1 Pull out the exhaust filter.

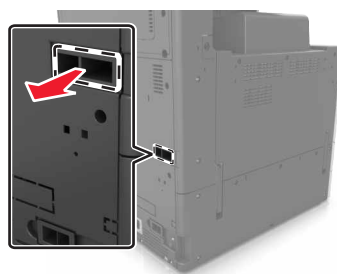

2 Unpack the new exhaust filter.

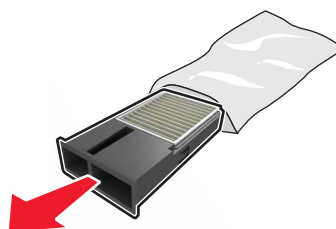

**3** Insert the new filter.



### Replacing the ozone filter

**1** Pull out the ozone filter.

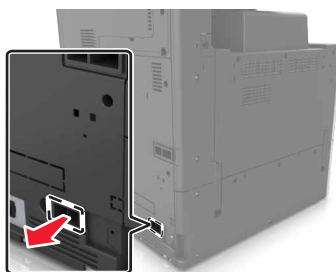

**2** Unpack the new ozone filter.

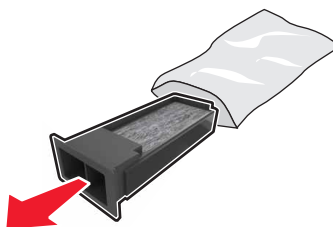

**3** Insert the new filter.

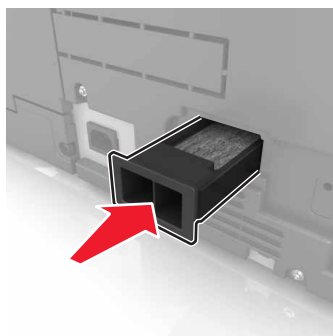

## Replacing the pick, feed, and separator rollers

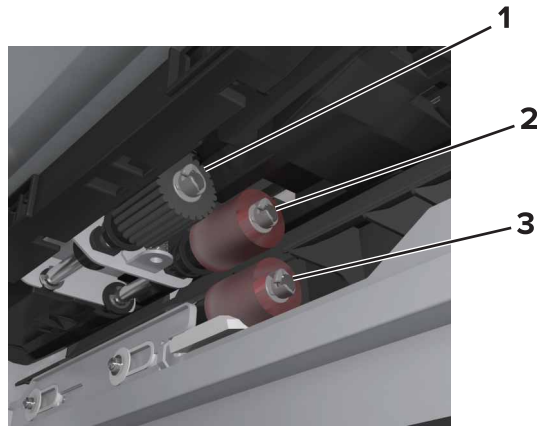

1	Pick roller
2	Feed roller
3	Separator roller

**Note:** You can use the rollers stored in the compartment inside the standard trays. For more information, see [“Storing the rollers” on page 212](#).

- 1 Turn off the printer.

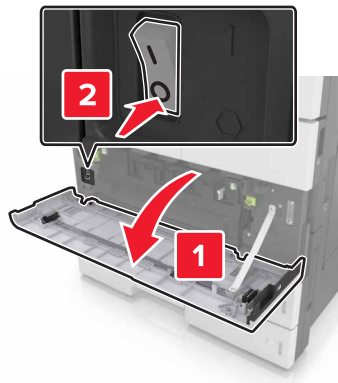

2 Remove all trays.

- Standard tray

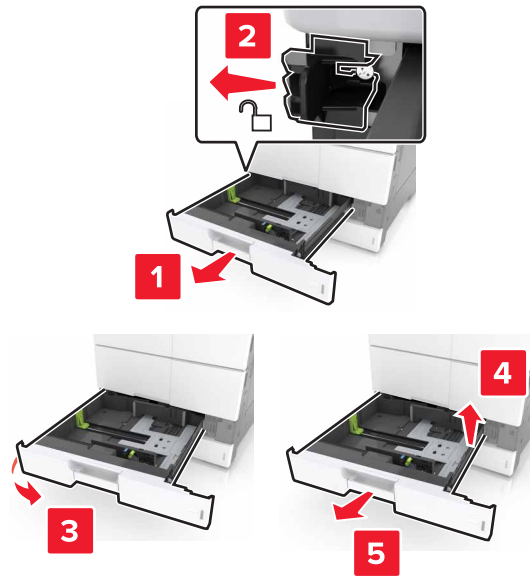

- Optional 2 x 500- or 2500-sheet tray

**Note:** To remove the optional 2 x 500-sheet tray, follow the procedure in removing the standard tray.

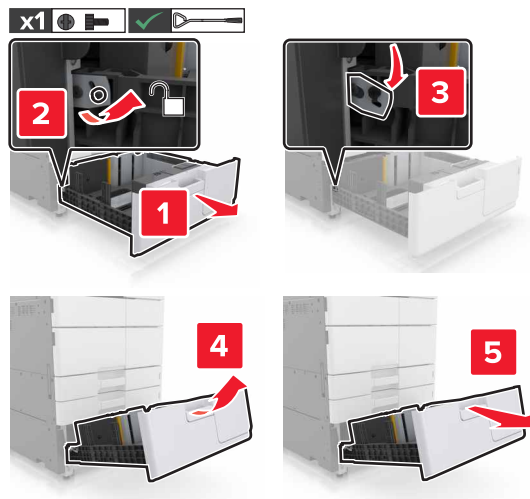

3 Open door C. Make sure that it does not hit any cable attached to the printer.

**Note:** If the 3000-sheet tray is installed, slide the tray to open the door.

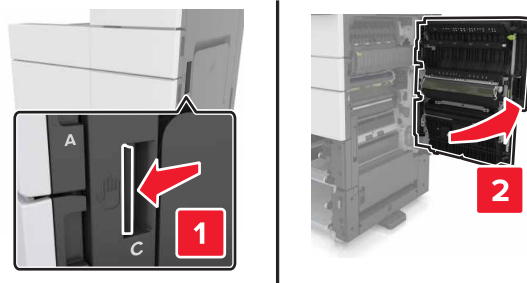

4 Open door D.

**Notes:**

- You can only open door D if the optional 2 x 500- or 2500-sheet tray is installed.
- If the 3000-sheet tray is installed, slide the tray to open the door.

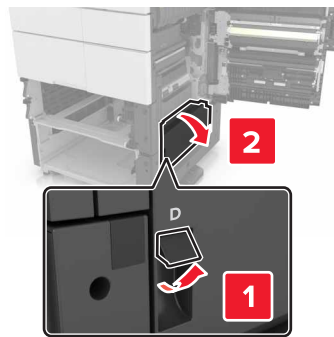

5 Locate the rollers.

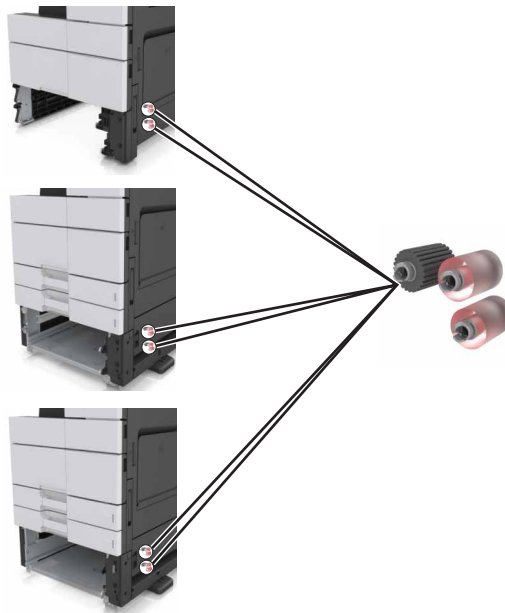

6 Remove the rollers.

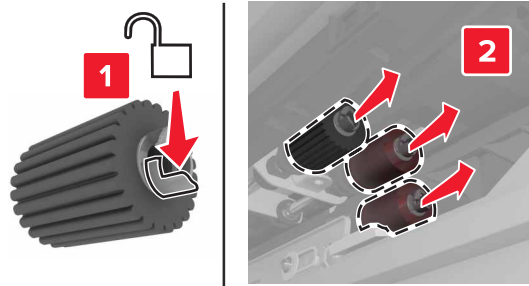

7 Insert the new rollers until they *click* into place.

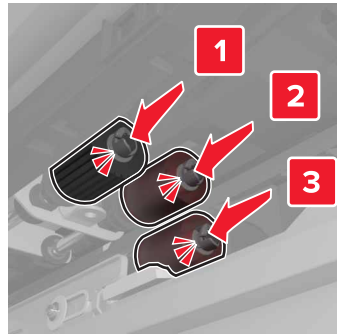

**Note:** Make sure to insert the rollers to their right places.

8 Close doors C and D.

9 Insert the trays.

## Replacing the transfer module

**Note:** Use the screwdriver located inside the bottom front door of the printer.

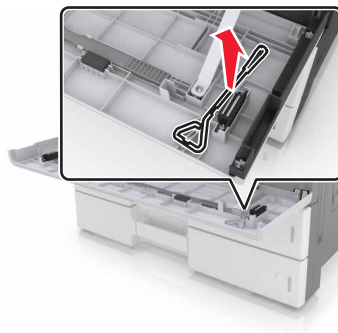

- 1 Turn off the printer.

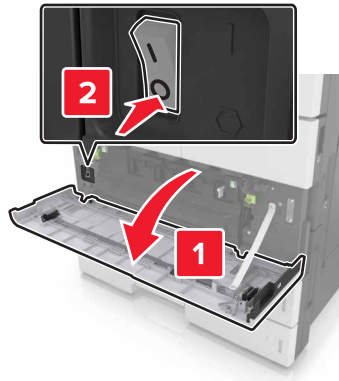

- 2 Open door C. Make sure that it does not hit any cable attached to the printer.

**CAUTION—HOT SURFACE:** The inside of the printer might be hot. To reduce the risk of injury from a hot component, allow the surface to cool before touching it.

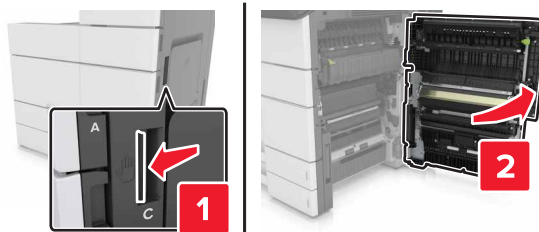

**Note:** If the 3000-sheet tray is installed, then slide the tray to the right to open the door.

- 3 Remove the door stopper.

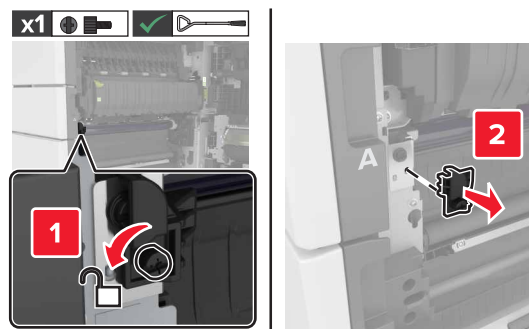

4 Loosen the screws of the transfer module lock.

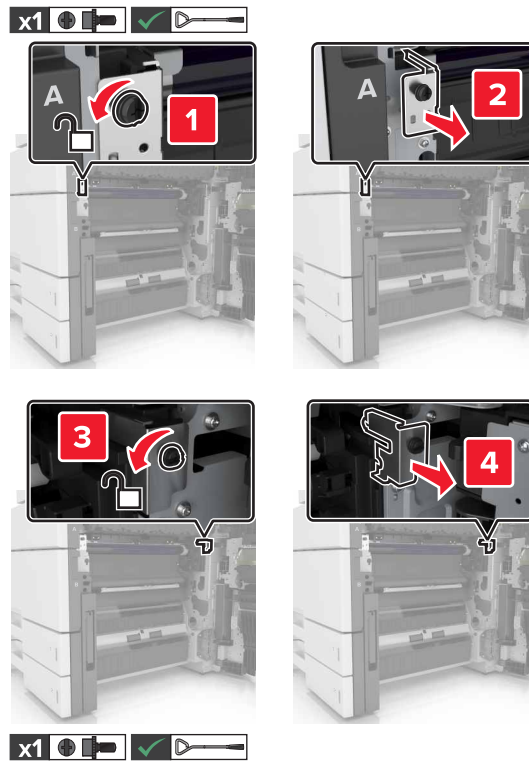

5 Remove the paper guide.

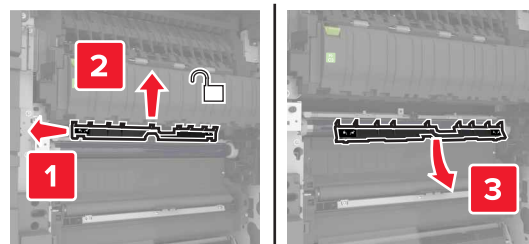

6 Lift the transfer module using the handles, and then pull it out completely.

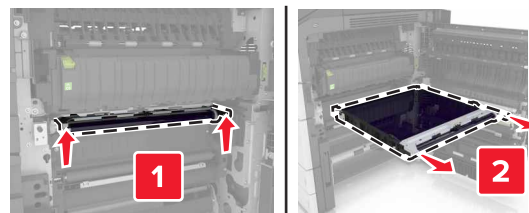

7 Unpack the new transfer module.

**Warning—Potential Damage:** Do not expose the transfer belt to direct light for more than 10 minutes. Extended exposure to light may cause print quality problems.



**Warning—Potential Damage:** Do not touch the transfer belt. Doing so may affect the print quality of future print jobs.



**8** Insert the new transfer module until it *clicks* into place.

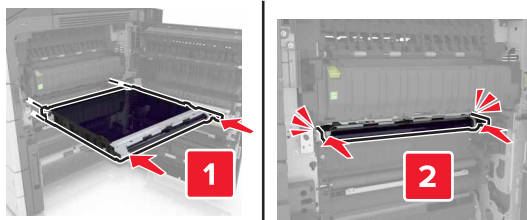

**9** Place the paper guide back into place.

**10** Tighten the screws of the transfer module lock.

**11** Reinstall the door stopper.

**12** Close door C.

## Replacing the transfer roller

**1** Open door C. Make sure that it does not hit any cable attached to the printer.

**Note:** If the 3000-sheet tray is installed, then slide the tray to the right to open the door.

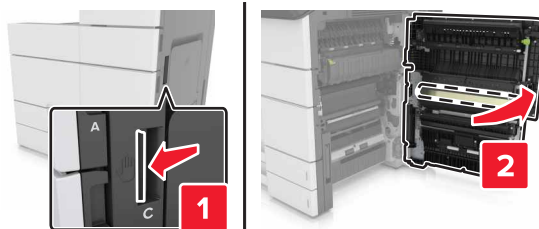

- 2 Pull out the transfer roller.

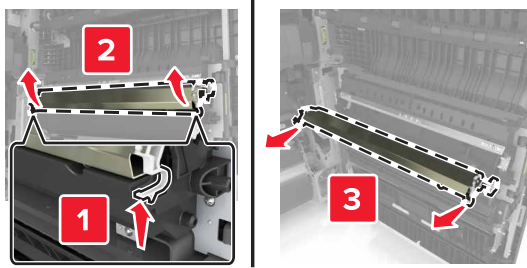

- 3 Unpack the new transfer roller.
- 4 Insert the new transfer roller until it *clicks* into place.

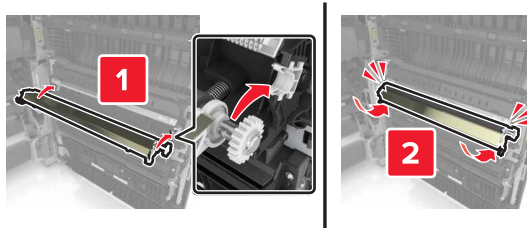

- 5 Close door C.

## Resetting the maintenance counter

- 1 Turn off the printer.
- 2 From the control panel, hold down **2** and **6** while turning the printer on. Release the buttons when the screen with the progress bar appears.
- 3 From the Configuration menu, navigate to:  
**Reset Maintenance Counter > Reset 300K Maintenance Kit**
- 4 Touch **Back**, and then exit the Configuration menu.

**Note:** The printer performs a power-on reset, and then returns to normal operating mode.

## Replacing the ADF scan pad

- 1 Open the scanner cover.

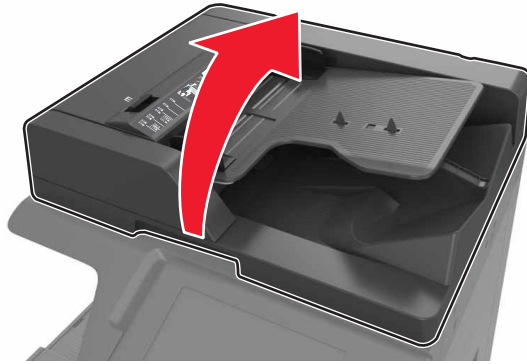

- 2 Remove the ADF scan pad.

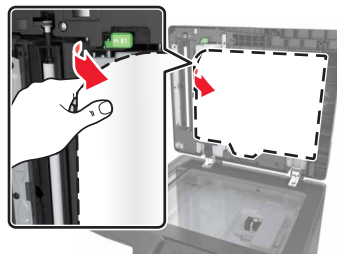

- 3 Unpack the new ADF scan pad, and then remove the packing materials.

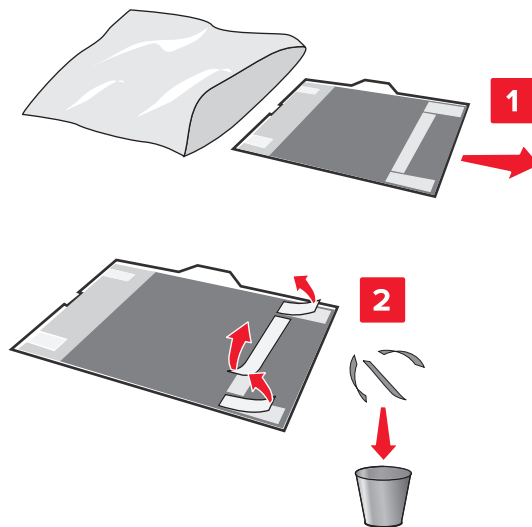

- 4** Lay the ADF scan pad flat on the scanner glass with the white area facedown.

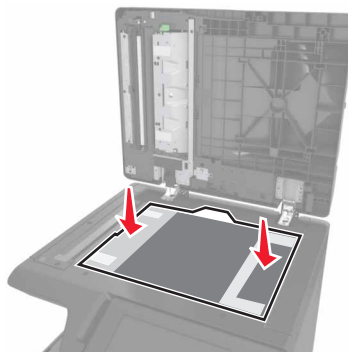

- 5** Close the scanner cover to stick the ADF scan pad to the cover, and then open the cover.



- 6** Push the corners of the ADF scan pad to secure it into place.

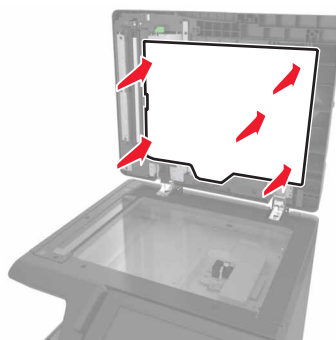

- 7** Close the scanner cover.

## Moving the printer

**⚠ CAUTION—POTENTIAL INJURY:** The printer weight is greater than 18 kg (40 lb) and requires two or more trained personnel to lift it safely.

### Before moving the printer

**⚠ CAUTION—POTENTIAL INJURY:** Before moving the printer, follow these guidelines to avoid personal injury or printer damage:

- Turn off the printer, and then unplug the power cord from the electrical outlet.
- Disconnect all cords and cables from the printer.
- If the printer does not have a caster base but is configured with optional trays, then remove the trays.
- Use the handholds located on both sides of the printer to lift it.
- Make sure your fingers are not under the printer when you set it down.
- Make sure there is adequate clearance around the printer.
- Use only the power cord provided with this product or the manufacturer's authorized replacement.

**Warning—Potential Damage:** Damage to the printer caused by improper moving is not covered by the printer warranty.

### Moving the printer to another location

- Using a flat-head screwdriver, reinstall the screws to lock the scanner bed in place.

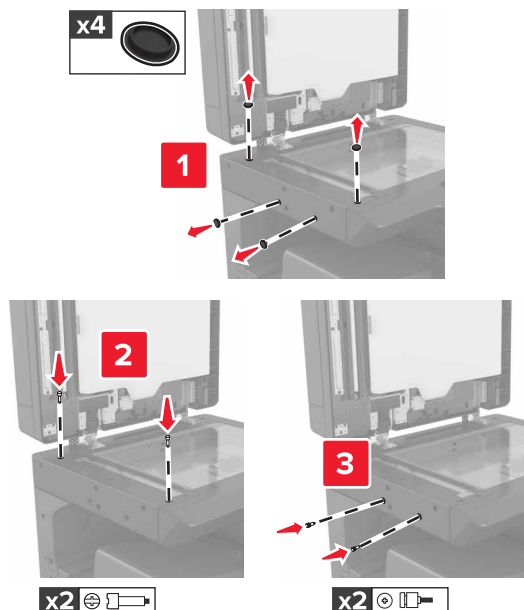

**Note:** Remove the screws after setting up the printer in another location.

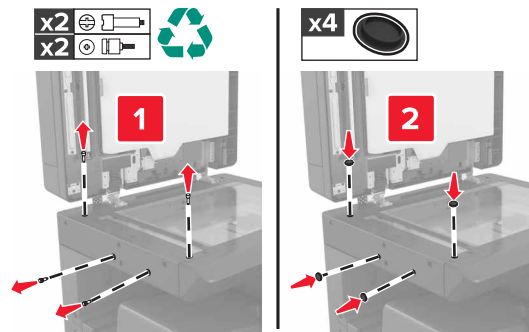

- If necessary, use a cart with a surface large enough to support the full dimensions of the printer.
- Keep the printer in an upright position.
- Avoid jarring movements.

## Shipping the printer

When shipping the printer, use the original packaging.

# Managing the printer

## Checking the virtual display

- 1 Open a Web browser, and then type the printer IP address in the address field.

**Notes:**

- View the printer IP address on the printer home screen. The IP address appears as four sets of numbers separated by periods, such as 123.123.123.123.
- If you are using a proxy server, then temporarily disable it to load the Web page correctly.

- 2 Check the virtual display that appears in the top left corner of the screen.

The virtual display works as an actual display would work on a printer control panel.

## Setting up e-mail alerts

Configure the printer to send you e-mail alerts when the supplies are getting low or when the paper needs to be changed or added, or when there is a paper jam.

- 1 Open a Web browser, and then type the printer IP address in the address field.

**Notes:**

- View the printer IP address on the printer home screen. The IP address appears as four sets of numbers separated by periods, such as 123.123.123.123.
- If you are using a proxy server, then temporarily disable it to load the Web page correctly.

- 2 Click **Settings**.

- 3 From the Other Settings menu, click **E-mail Alert Setup**.

- 4 Select the items you want to be notified on, and then type the e-mail addresses.

- 5 Click **Submit**.

**Note:** For information on setting up the e-mail server, contact your system support person.

## Viewing reports

You can view some reports from the Embedded Web Server. These reports are useful for assessing the status of the printer, network, and supplies.

- 1 Open a Web browser, and then type the printer IP address in the address field.

**Notes:**

- View the printer IP address on the printer home screen. The IP address appears as four sets of numbers separated by periods, such as 123.123.123.123.
- If you are using a proxy server, then temporarily disable it to load the Web page correctly.

- 2 Click **Reports**, and then click the type of report you want to view.

## Copying printer settings to other printers

**Note:** This feature is available only in network printers.

- 1 Open a Web browser, and then type the printer IP address in the address field.

**Notes:**

- View the printer IP address in the TCP/IP section in the Network/Ports menu. The IP address appears as four sets of numbers separated by periods, such as 123.123.123.123.
- If you are using a proxy server, then temporarily disable it to load the Web page correctly.

- 2 Click the **Copy Printer Settings**.
- 3 To change the language, select a language from the drop-down menu, and then click **Click here to submit language**.
- 4 Click **Printer Settings**.
- 5 Type the IP addresses of the source and target printers in their appropriate fields.

**Note:** If you want to add or remove a target printer, then click **Add Target IP** or **Remove Target IP**.

- 6 Click **Copy Printer Settings**.

## Configuring supply notifications from the Embedded Web Server

You can determine how you would like to be notified when supplies run nearly low, low, near end-of-life, or reach their end-of-life by setting the selectable alerts.

**Note:** The percentage of estimated remaining supply that prompts the alert can be set on some supplies for some supply conditions.

- 1 Open a Web browser, and then type the printer IP address.
- 2 Click **Settings > Print Settings > Supply Notifications**.
- 3 From the drop-down menu, select one of the following notification options:

Notification	Description
Off	The normal printer behavior for all supplies occurs.
SNMP Only	The printer generates a Simple Network Management Protocol (SNMP) alert when the supply condition is reached. The status of the supply appears on the menus page and status page.
E-mail	The printer generates an e-mail when the supply condition is reached. The status of the supply appears on the menus page and status page.
Warning	The printer displays the warning message and generates an e-mail about the status of the supply. The printer does not stop when the supply condition is reached.
Continuable Stop <sup>1</sup>	The printer stops processing jobs when the supply condition is reached, and the user needs to press a button to continue printing.

<sup>1</sup> The printer generates an e-mail about the status of the supply when supply notification is enabled.

<sup>2</sup> The printer stops when some supplies become empty to prevent damage.



Notification	Description
Non Continuable Stop <sup>1,2</sup>	The printer stops processing jobs when the supply condition is reached. The supply must be replaced to continue printing.
<sup>1</sup> The printer generates an e-mail about the status of the supply when supply notification is enabled.	
<sup>2</sup> The printer stops when some supplies become empty to prevent damage.	

4 Click **Submit**.

## Restoring factory default settings

If you want to keep a list of the current menu settings for reference, then print a menu settings page before restoring the factory default settings. For more information, see [“Printing a menu settings page” on page 50](#).

For a more comprehensive method of restoring the printer factory default settings, see [“Erasing non-volatile memory” on page 203](#).

**Warning—Potential Damage:** Restoring factory defaults returns most printer settings to the original factory default settings. Exceptions include the display language, custom sizes and messages, and network/port menu settings. All downloads stored in the RAM are deleted. Downloads stored in the flash memory or in a printer hard disk are not affected.

1 From the home screen, navigate to:



> **Settings** > **General Settings** > **Factory Defaults** > **Restore Now**

2 Apply the changes.

## Clearing jams

Carefully select paper and specialty media, and then load them properly to avoid most jams. If jams occur, then follow the steps outlined in this chapter.

**Note:** Jam Recovery is set to Auto by default. The printer reprints jammed pages unless the memory required to hold the pages is needed for other printer tasks.

## Avoiding jams

### Load paper properly

- Make sure paper lies flat in the tray.

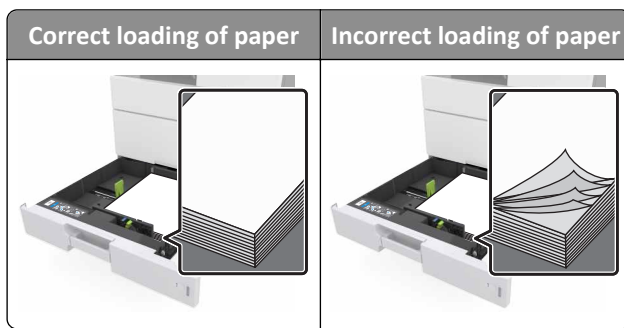

- Do not remove a tray while the printer is printing.
- Do not load a tray while the printer is printing. Load it before printing, or wait for a prompt to load it.
- Do not load too much paper. Make sure the stack height is below the maximum paper fill indicator.
- Do not slide the paper into the tray. Load paper as shown in the illustration.



- Make sure the guides in the tray or the multipurpose feeder are properly positioned and are not pressing tightly against the paper or envelopes.
- Push the tray firmly into the printer after loading paper.

### Use recommended paper

- Use only recommended paper or specialty media.
- Do not load wrinkled, creased, damp, bent, or curled paper.

- Flex, fan, and straighten paper before loading it.

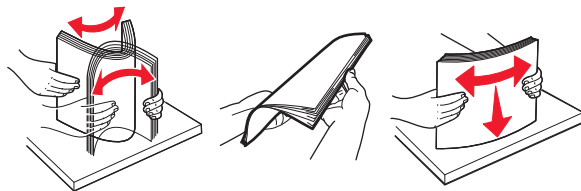

- Do not use paper that has been cut or trimmed by hand.
- Do not mix paper sizes, weights, or types in the same tray.
- Make sure the paper size and type are set correctly on the computer or printer control panel.
- Store paper according to manufacturer recommendations.

## Understanding jam messages and locations

When a jam occurs, a message indicating the jam location and information to clear the jam appears on the printer display. Open the doors, covers, and trays indicated on the display to remove the jam.

### Notes:

- When Jam Assist is set to On, the printer flushes blank pages or pages with partial prints after a jammed page has been cleared. Check your printed output for blank pages.
- When Jam Recovery is set to On or Auto, the printer reprints jammed pages. However, the Auto setting reprints jammed pages only if adequate printer memory is available.

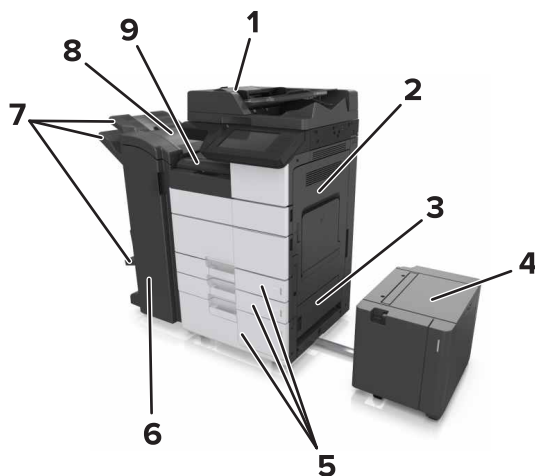

	Area name
1	Automatic document feeder (ADF)
2	Door C
3	Door D
4	Door F
5	Trays

	Area name
6	Door H
7	Finisher bins
8	Door J
9	Area G

Area name	Control panel message	What to do
ADF	[x]-page jam, press latch at area E to open ADF's top cover. [28y.xx]	Open the ADF top door, and then remove the jammed paper.
Multipurpose feeder	[x]-page jam, clear jammed paper from the multipurpose feeder. [200.xx]	Remove the jammed paper from the feeder.
Door C, trays	[x]-page jam, open door C and clear all jammed paper. [2yy.xx]	Open door C, and then remove the jammed paper.
	[x]-page jam, slide the 3000-sheet tray and open door C. [2yy.xx]	Pull out the tray, and then remove the jammed paper.
Door D, trays	[x]-page jam, open door D and clear all jammed paper. [24y.xx]	Open door D, and then remove the jammed paper.
	[x]-page jam, slide the 3000-sheet tray and open door D. [24y.xx]	Pull out the tray, and then remove the jammed paper.
Doors C and F	[x]-page jam, slide the 3000-sheet tray and open door F. [24y.xx]	Pull the 3000-sheet tray, and then remove the jammed paper from the side of the tray. Open door F, and then remove the jammed paper.
Area G, doors C, J, and H, finisher bin	[x] page jam, open doors G, H, and J and clear jammed paper. [4yy.xx]	Open door G, and then remove the jammed paper. Open door H, and then remove the jammed paper.
Doors C and G, finisher bin	[x]-page jam, press latch beside door G and slide finisher to the left. Leave paper in bin. [40y.xx]	Slide the staple finisher to the left, and then remove the jammed paper.
Area G, doors C, J, and H, finisher bin	[x]-page jam, open door H and rotate knob SD3 clockwise. Leave paper in bin. [426.xx–428.xx]	Open door H, and then remove the jammed paper.

## [x]-page jam, clear jammed paper from multipurpose feeder. [200.xx]

- 1 Remove all paper from the multipurpose feeder.
- 2 Remove the jammed paper.



- 3 Open door C to remove any paper fragments.

**Note:** Make sure that door C does not hit any cable attached to the printer.

- 4 Close door C.
- 5 Flex the sheets back and forth to loosen them, and then fan them. Do not fold or crease the paper. Straighten the edges on a level surface.

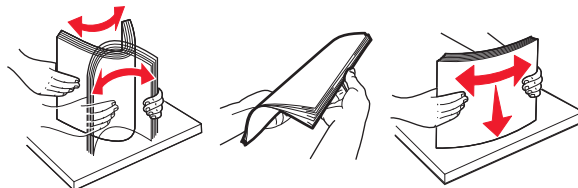

- 6 Reload the paper.

## [x]-page jam, open door C and clear all jammed paper. [2yy.xx]

- 1 Open door C. Make sure that it does not hit any cable attached to the printer.

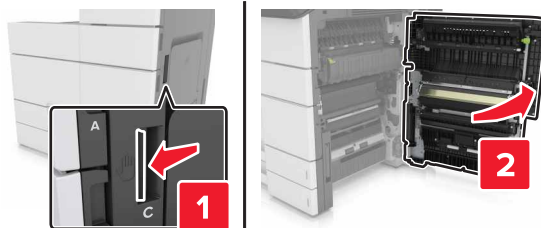

- 2 Remove the jammed paper from any of the following locations:

**Note:** Make sure that all paper fragments are removed.



**CAUTION—HOT SURFACE:** The inside of the printer might be hot. To reduce the risk of injury from a hot component, allow the surface to cool before touching it.

- Fuser area

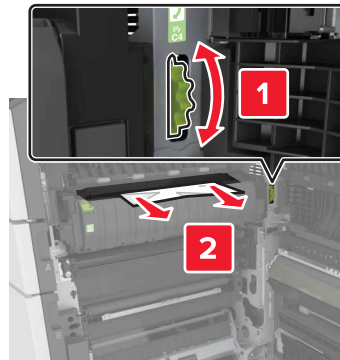

- Below the fuser area

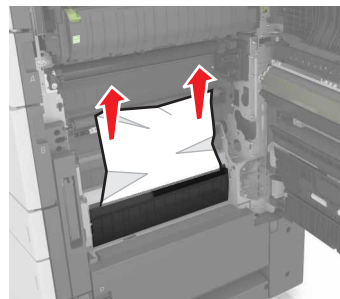

- Duplex area

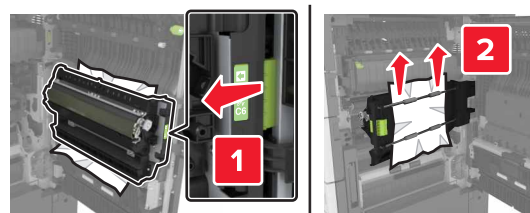

- Above the duplex area

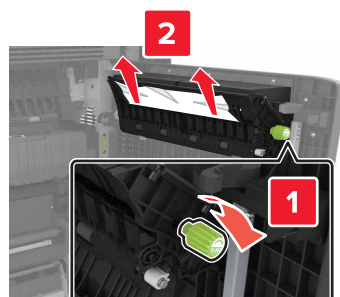

- 3 Open the standard trays, and then locate the jammed paper.

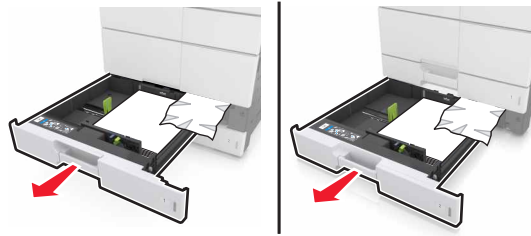

- 4 Remove the jammed paper.

**Note:** Make sure that all paper fragments are removed.



- 5 Close the trays and door C.

## [x]-page jam, slide the 3000-sheet tray and open door C. [2yy.xx]

- 1 Slide the 3000-sheet tray.

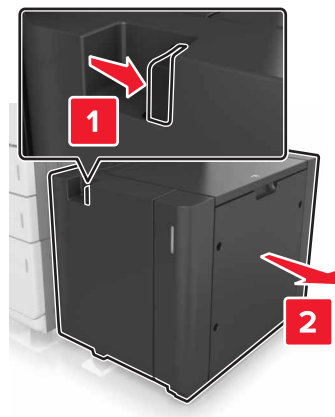

- 2 Open door C. Make sure that it does not hit any cable attached to the printer.



- 3 Remove the jammed paper from any of the following locations:

**Note:** Make sure that all paper fragments are removed.



**CAUTION—HOT SURFACE:** The inside of the printer might be hot. To reduce the risk of injury from a hot component, allow the surface to cool before touching it.

- Fuser area

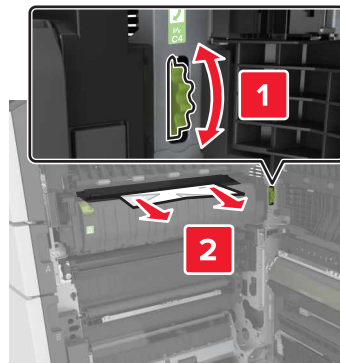

- Below the fuser area

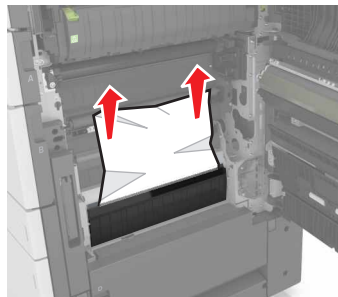



- Duplex area

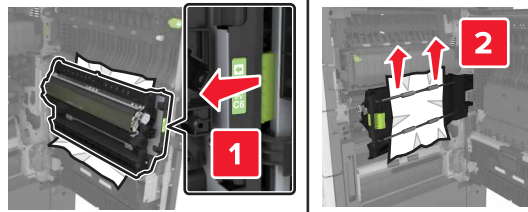

- Above the duplex area

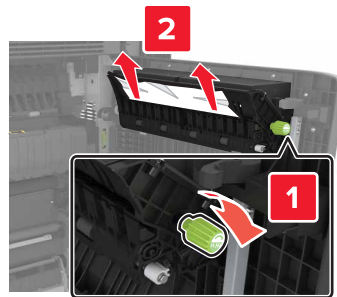

4 Open the standard trays, and then locate the jammed paper.



5 Remove the jammed paper.

**Note:** Make sure that all paper fragments are removed.



6 Close the trays and door C.

7 Slide the 3000-sheet tray back into place.

## [x]-page jam, open door D and clear all jammed paper. [24y.xx]

1 Open door D, and then remove the jammed paper.

**Note:** Make sure that all paper fragments are removed.

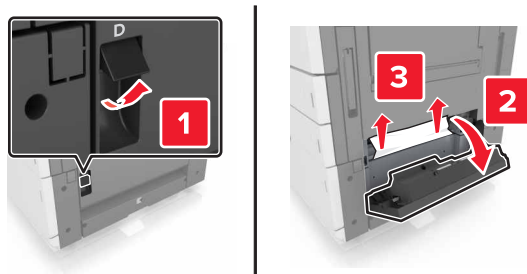

**2** Open the optional tray, and then locate the jammed paper.

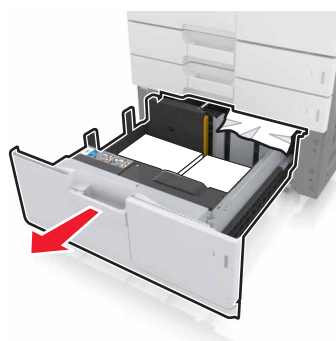

**3** Remove the jammed paper.

**Note:** Make sure that all paper fragments are removed.

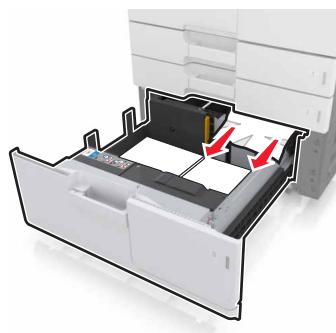

**4** Close the tray and door D.

## [x]-page jam, slide the 3000-sheet tray and open door D. [24y.xx]

- 1 Slide the 3000-sheet tray.

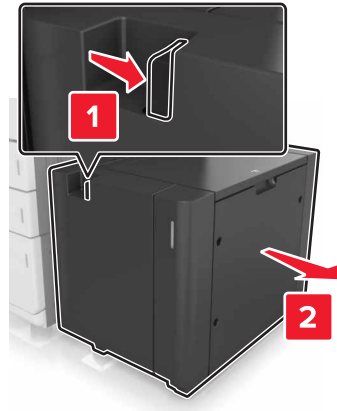

- 2 Open door D, and then remove the jammed paper.

**Note:** Make sure that all paper fragments are removed.

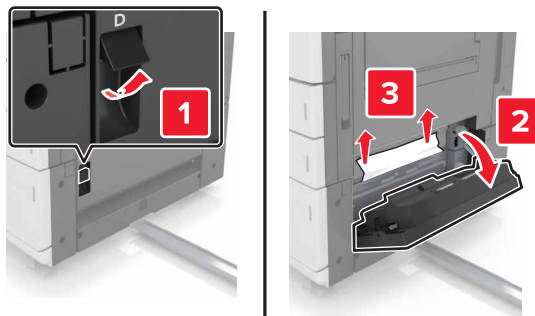

- 3 Open the optional tray, and then locate the jammed paper.

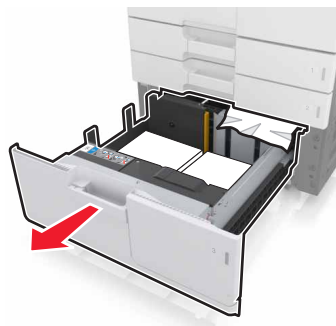

- 4 Remove the jammed paper.

**Note:** Make sure that all paper fragments are removed.

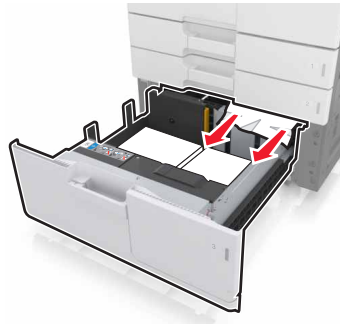

- 5 Close the tray and door D.
- 6 Slide the 3000-sheet tray back into place.

## [x]-page jam, slide the 3000-sheet tray and open door F. [24y.xx]

- 1 Slide the 3000-sheet tray.

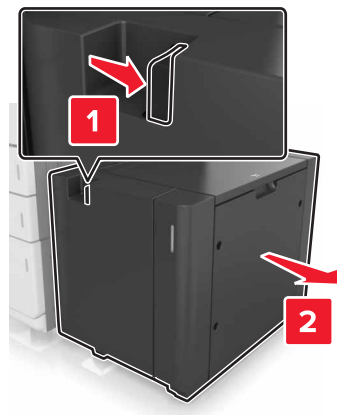

- 2 Remove the jammed paper.

**Note:** Make sure that all paper fragments are removed.

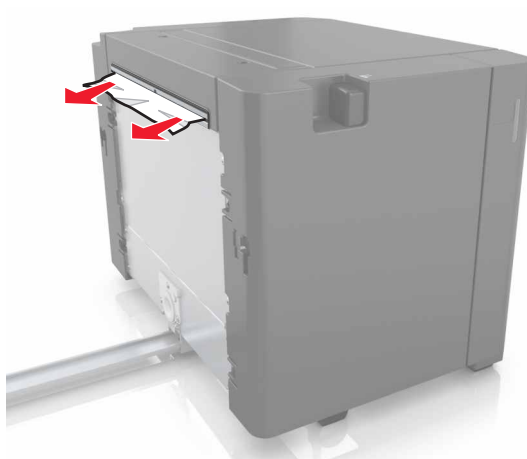

3 Open door F, and then remove the jammed paper.

**Note:** Make sure that all paper fragments are removed.

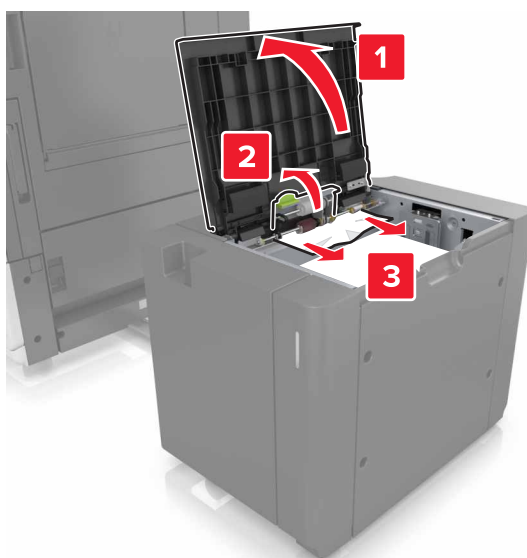

4 Close door F.

5 Open door C. Make sure that it does not hit any cable attached to the printer.



6 Remove the jammed paper from any of the following locations:

**Note:** Make sure that all paper fragments are removed.

**CAUTION—HOT SURFACE:** The inside of the printer might be hot. To reduce the risk of injury from a hot component, allow the surface to cool before touching it.

- Fuser area

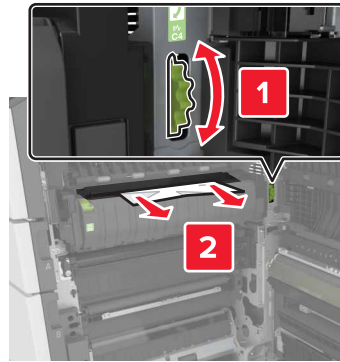

- Below the fuser area

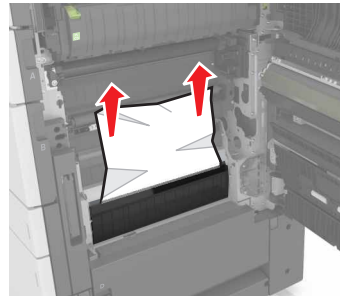

- Duplex area

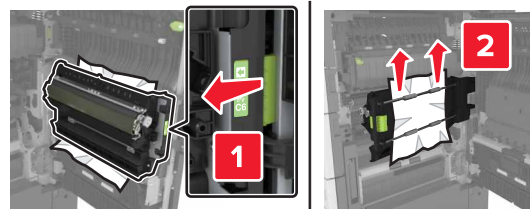

- Above the duplex area

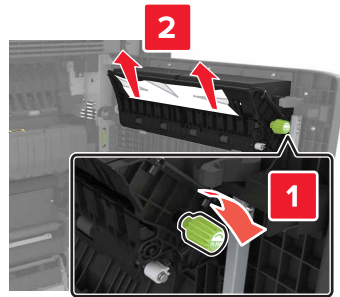

7 Close door C, and then slide the 3000-sheet tray back into place.

## [x]-page jam, open doors G, H, and J and clear jammed paper. Leave paper in bin. [4yy.xx]

1 Open door G, and then remove the jammed paper.

**Note:** Make sure that all paper fragments are removed.

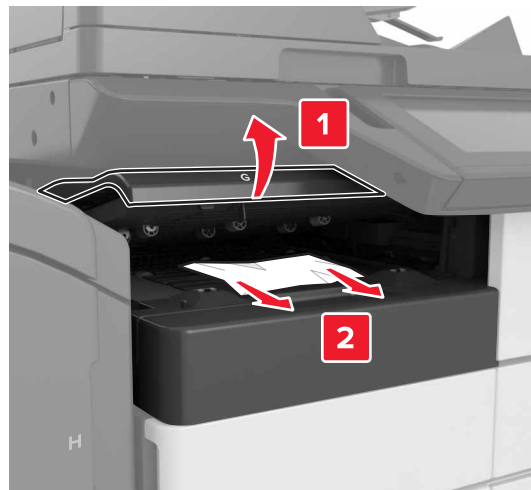

2 Open door J, and then lift handle J1 to its upright position.

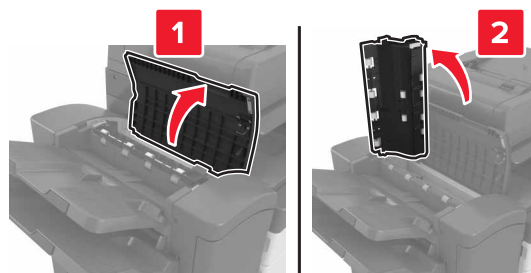

3 Open door H.



4 Remove the jammed paper from any of the following locations:

**Note:** Make sure that all paper fragments are removed.

- Door J

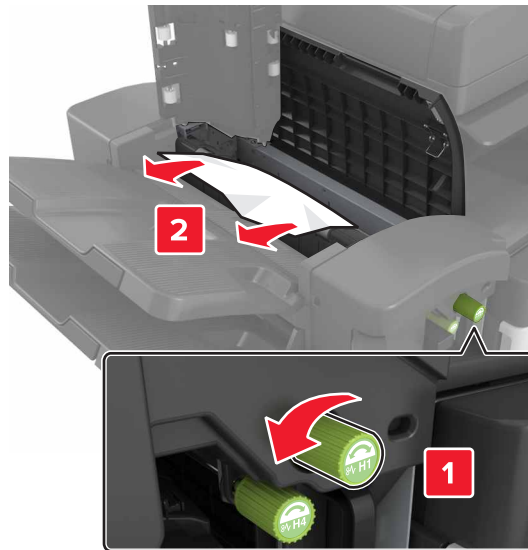

**Note:** If there is a jammed paper between the finisher bins, then remove the paper.

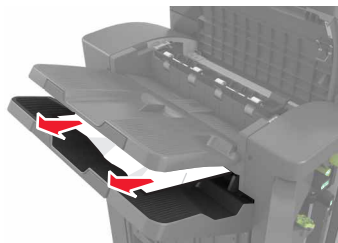



- Areas H1 and H2

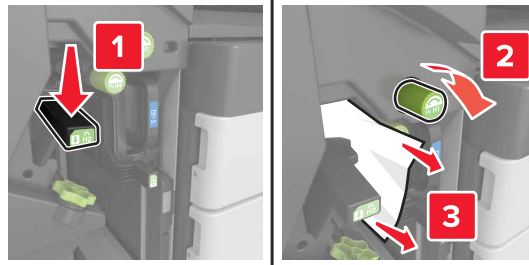

- Areas H3 and H4

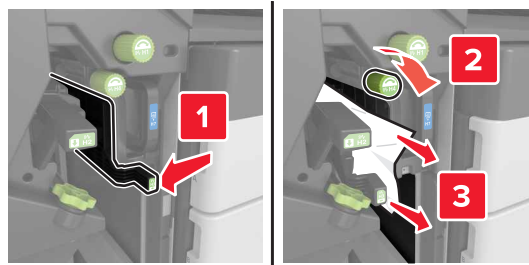

- Area H6

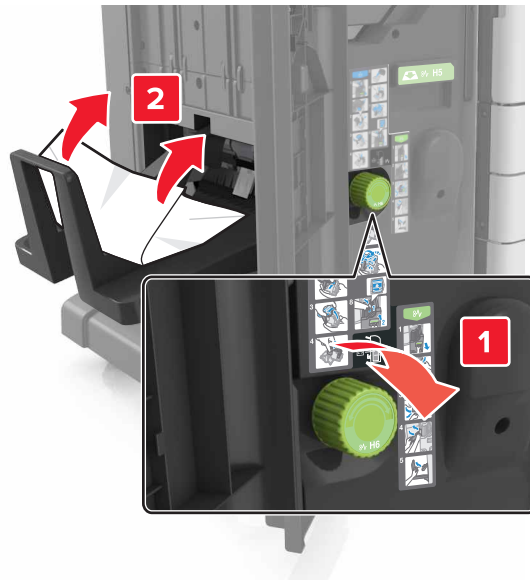

5 Close Door H.

6 Open door C, and then remove the jammed paper.

**Note:** Make sure that door C does not hit any cable attached to the printer.

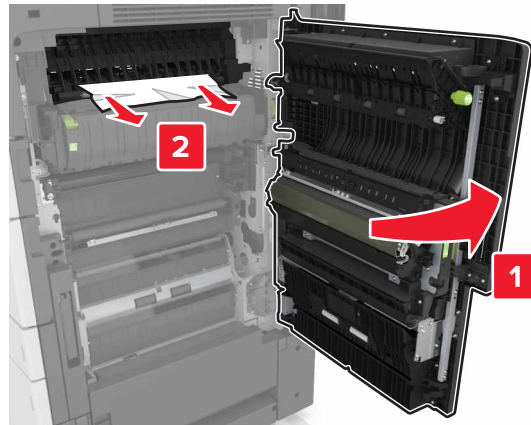
**Notes:**

- Make sure that all paper fragments are removed.
- If the 3000-sheet tray is installed, then slide the tray to the right to open the door.

7 Close door C.

## [x]-page jam, press latch to access area G. Leave paper in bin. [40y.xx]

1 Remove all paper from the staple finisher bin.

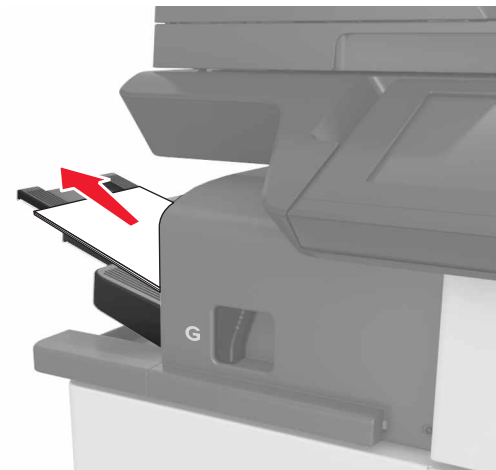

2 Press the latch and slide the stapler finisher to the left, and then remove the jammed paper.

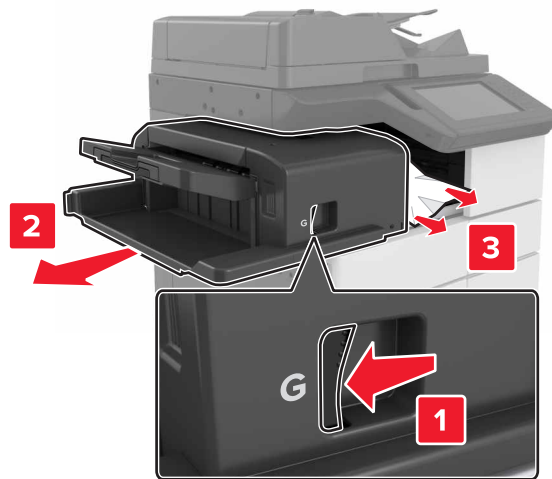

**Notes:**

- Make sure that all paper fragments are removed.
- If necessary, turn spinner wheel G1 downward to feed jammed paper into the finisher bin, and then remove the paper.

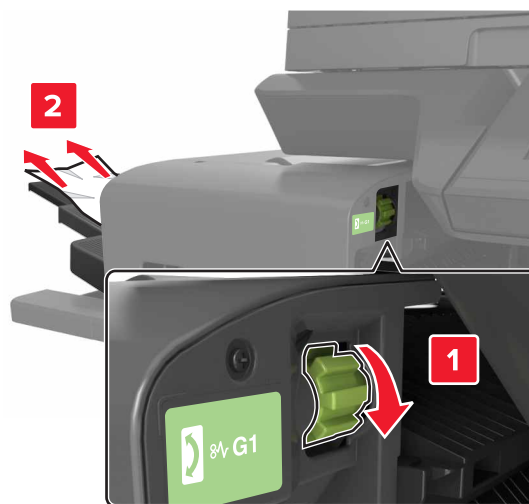

3 Slide the finisher back into place.

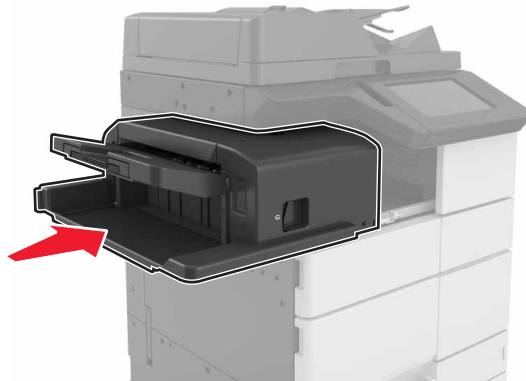

4 Open door C, and then remove the jammed paper.

 **CAUTION—HOT SURFACE:** The inside of the printer might be hot. To reduce the risk of injury from a hot component, allow the surface to cool before touching it.

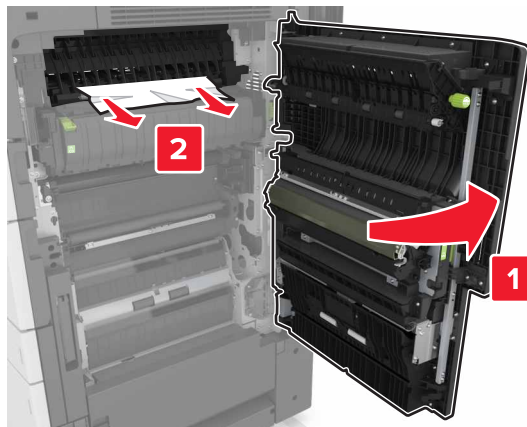

**Notes:**

- Make sure that door C does not hit any cable attached to the printer.
- Make sure that all paper fragments are removed.
- If the 3000-sheet tray is installed, then slide the tray to the right to open the door.

5 Close door C.

## [x]-page jam, press latch to access area G and clear jammed staples. Leave paper in bin. [402.93]

- 1 Remove all paper from the staple finisher bin.

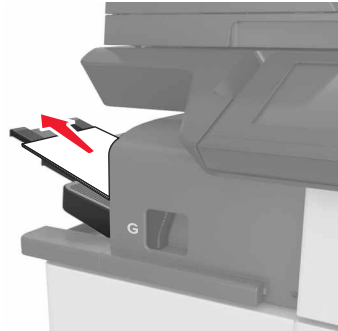

- 2 Press the latch on the staple finisher, and then slide the finisher to the left.

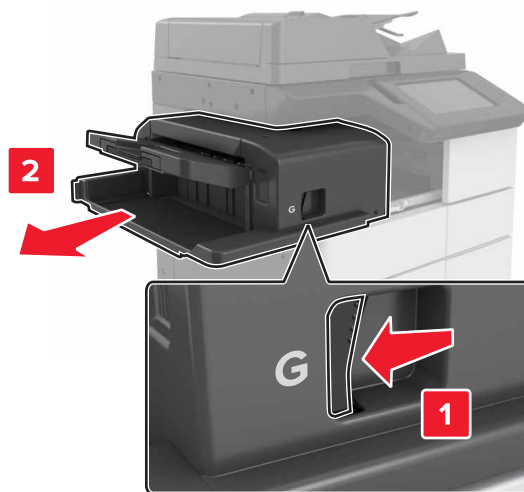

- 3 Remove the staple cartridge holder.



- 4 Use the metal tab to lift the staple guard, and then remove any loose staples.

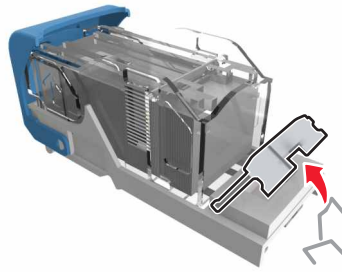

- 5 Press the staple guard down until it *clicks* into place.

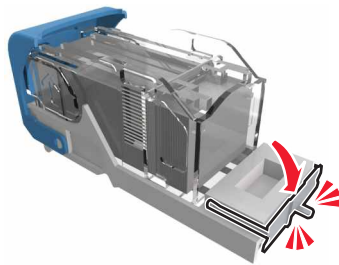

- 6 Press the staples against the metal bracket.

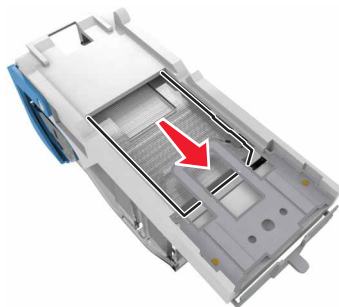

**Note:** If the staples are at the rear of the cartridge, then shake the cartridge downward to bring the staples near the metal bracket.

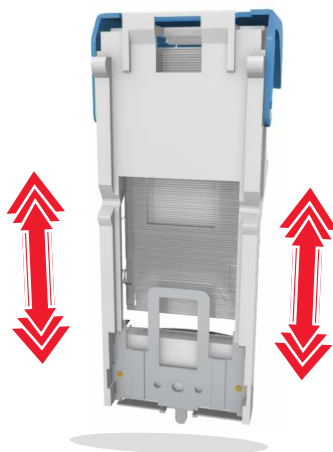

**7** Push the cartridge holder into the finisher until the holder *clicks* into place.

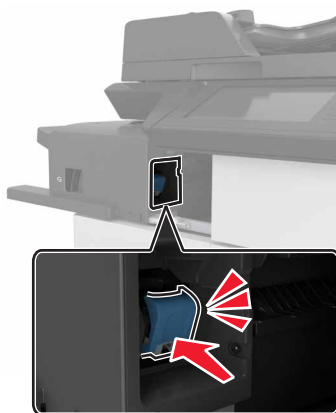

**8** Slide the finisher back into place.

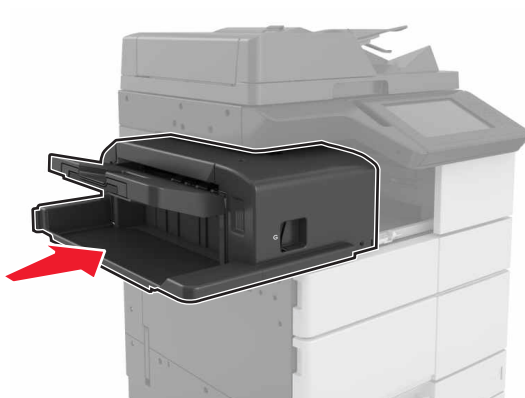

## [x]-page jam, open door H and rotate knob H6 clockwise. Leave paper in bin. [426.xx–428.xx]

If the jammed paper is located under door G, then open the door and remove the paper.

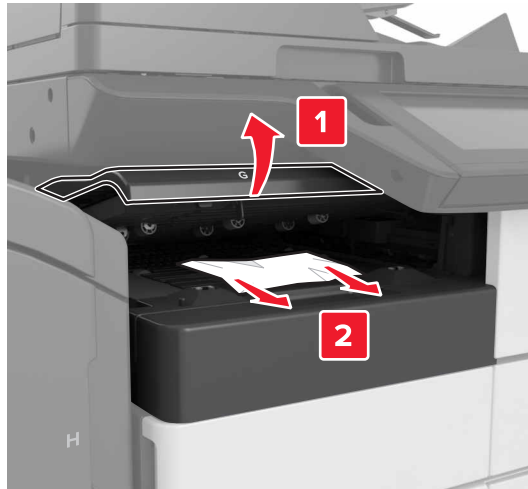

1 Open door J, and then lift handle J1.

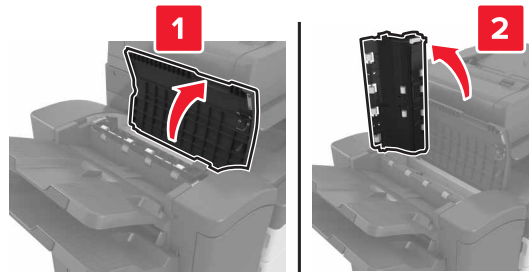

2 Open door H.





**3** Remove the jammed paper from any of the following locations:

**Note:** Make sure that all paper fragments are removed.

- Door J



**Note:** If there is a jammed paper between the finisher bins, then remove the paper.

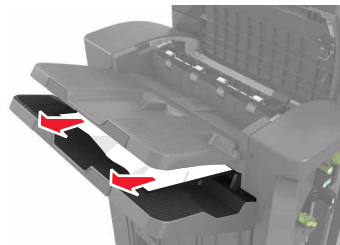

- Areas H1 and H2

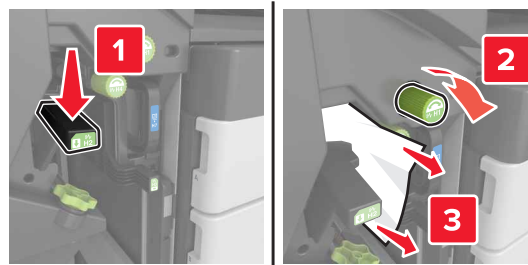

- Areas H3 and H4

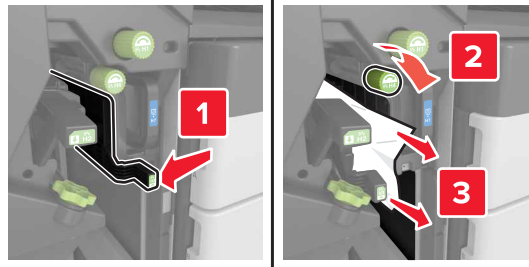

- Area H6

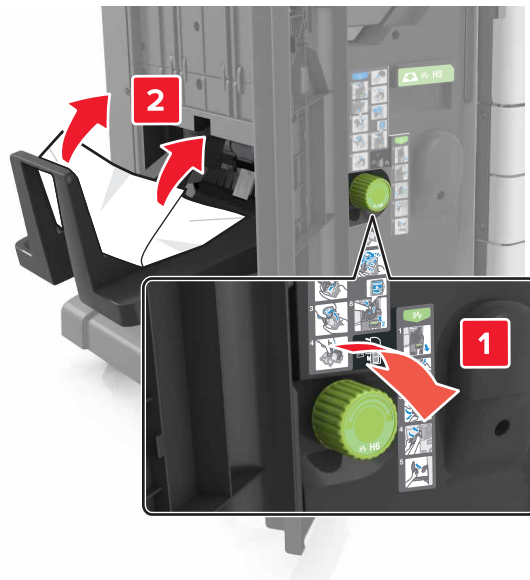

4 Using handle H5, pull out the booklet maker.



5 Remove the jammed paper from any of the following locations:

**Note:** Make sure that all paper fragments are removed.

- Area H8

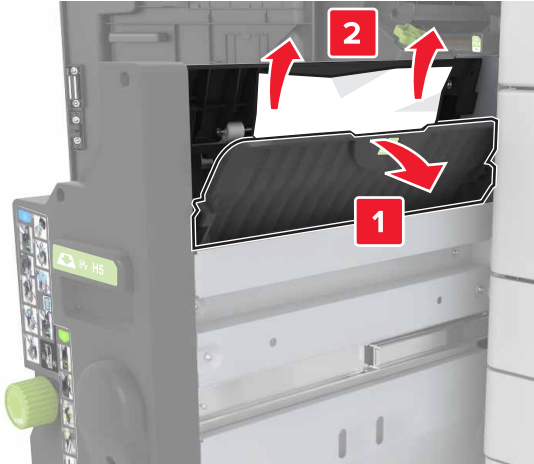

- Area H9

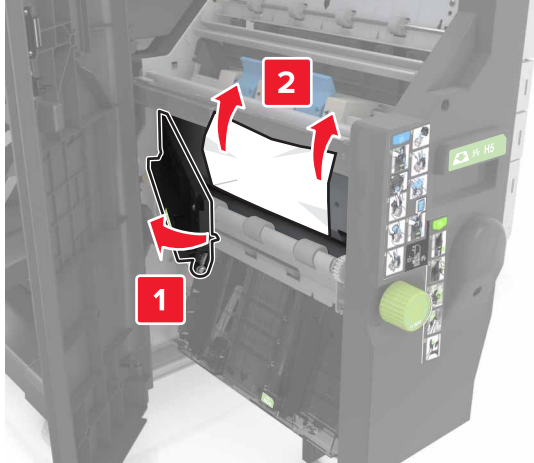

- Area H10

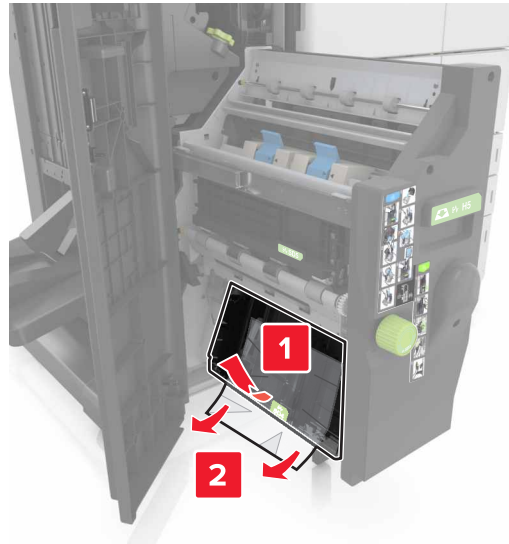

- 6 Push the booklet maker back into place.
- 7 Close door H.
- 8 Open door C, and then remove the jammed paper.

**CAUTION—HOT SURFACE:** The inside of the printer might be hot. To reduce the risk of injury from a hot component, allow the surface to cool before touching it.

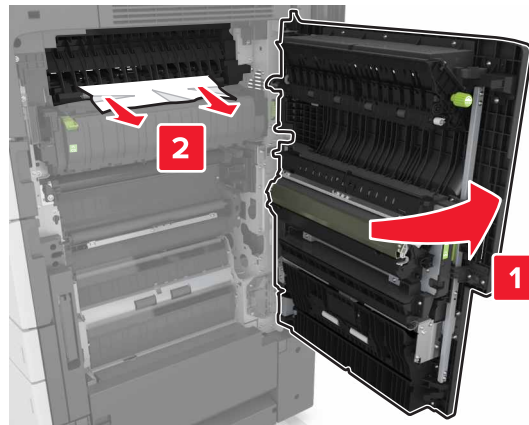

**Notes:**

- Make sure that door C does not hit any cable attached to the printer.
- Make sure that all paper fragments are removed.
- If the 3000-sheet tray is installed, then slide the tray to the right to open the door.

- 9 Close door C.

## [x]-page jam, press latch at area E to open ADF's top cover. [28y.xx]

- 1 Remove all original documents from the ADF tray.
- 2 Open the top ADF top cover.

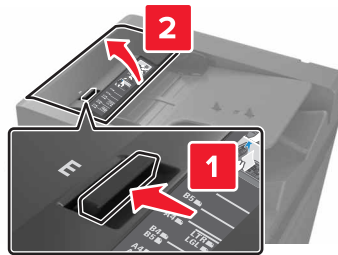

- 3 Remove jammed paper.

**Note:** Make sure that all paper fragments are removed.

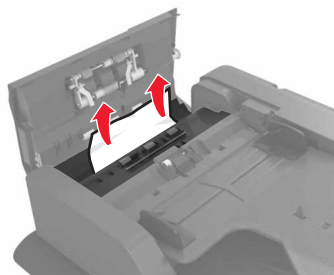

- 4 Close the cover.
- 5 Open the scanner cover, and then open the bottom ADF door.

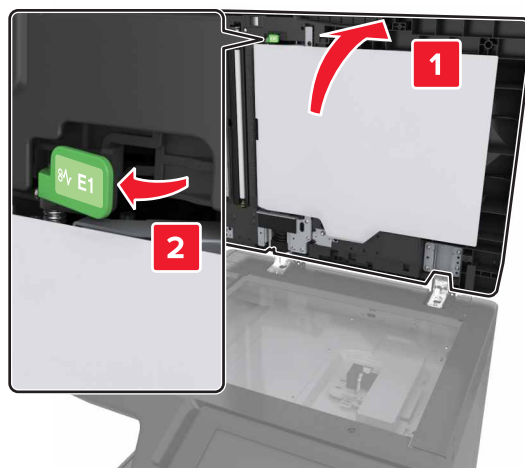

- 6 Remove jammed paper.

**Note:** Make sure that all paper fragments are removed.

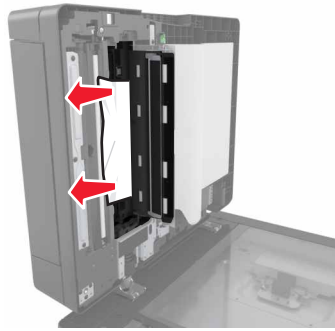

**7** Close the door.

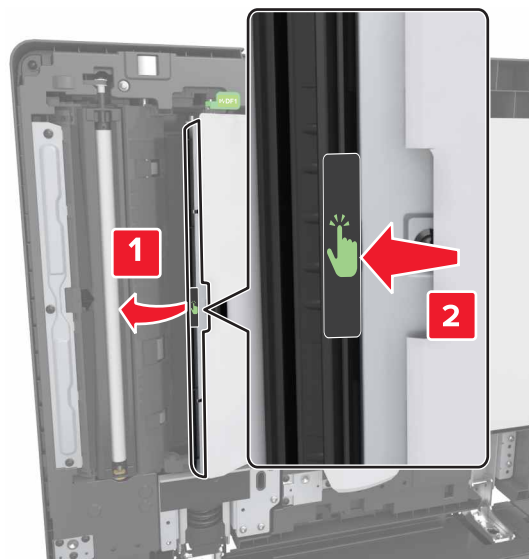

**8** Close the scanner cover.

# Troubleshooting

## Understanding the printer messages

### Cartridge low [88.xy]

You may need to order a replacement toner cartridge. If necessary, touch **Continue** on the printer control panel to clear the message and continue printing.

### Cartridge nearly low [88.xy]

If necessary, touch **Continue** on the printer control panel to clear the message and continue printing.

### Cartridge very low [88.xy]

You may need to replace the toner cartridge very soon. For more information, see [“Replacing the toner cartridge” on page 221](#).

If necessary, touch **Continue** on the control panel to clear the message and continue printing.

### Change [paper source] to [custom string] load [orientation]

Try one or more of the following:

- Load the correct size and type of paper in the tray, specify the paper size and type in the Paper menu on the control panel, and then touch **Finished changing paper**.
- Touch **Use current [paper source]** to use the available paper size and type in the tray.
- Touch **Reset active bin** to reset the active bin for a linked set of bins.
- Cancel the print job.

### Change [paper source] to [custom type name] load [orientation]

Try one or more of the following:

- Load the correct size and type of paper in the tray or feeder, specify the paper size and type in the Paper menu on the printer control panel, and then touch **Finished changing paper**.
- Touch **Reset active bin** to reset the active bin for a linked set of bins.
- Cancel the print job.

### Change [paper source] to [paper size] load [orientation]

Try one or more of the following:

- Load the correct size and type of paper in the tray or feeder, specify the size and type of paper in the Paper menu on the control panel, and then touch **Finished changing paper**.
- Touch **Use current [paper source]** to use the available size and type of paper in the current tray or feeder.

- Touch **Reset active bin** to reset the active bin for a linked set of bins.
- Cancel the print job.

## Change [paper source] to [paper type] [paper size] load [orientation]

Try one or more of the following:

- Load the correct size and type of paper in the tray or feeder, specify the paper size and type in the Paper menu on the control panel, and then touch **Finished changing paper**.
- Touch **Use current [paper source]** to use the available paper size and type in the tray.
- Touch **Reset active bin** to reset the active bin for a linked set of bins.
- Cancel the print job.

## Close door [x]

Close the specified door.

## Complex page, some data may not have printed [39]

Try one or more of the following:

- From the control panel, touch **Continue** to clear the message and continue printing.
- Touch **Reset active bin** to reset the active bin for a linked set of bins.
- Cancel the print job.
- Install additional printer memory.

## Configuration change, some held jobs were not restored [57]

Held jobs are invalidated because of the following possible changes in the printer:

- The printer firmware has been updated.
- The tray for the print job has been removed.
- The print job is sent from a flash drive that is no longer attached to the USB port.
- The printer hard disk contains print jobs that were stored when the hard disk was installed in a different printer model.

From the printer control panel, touch **Continue** to clear the message.

## Defective flash detected [51]

Try one or more of the following:

- Replace the defective flash memory card.
- From the printer control panel, touch **Continue** to ignore the message and continue printing.
- Cancel the current print job.



## Disk full [62]

Try one or more of the following:

- From the control panel, touch **Continue** to clear the message and continue printing.
- Touch **Reset active bin** to reset the active bin for a linked set of bins.
- Delete fonts, macros, and other data stored in the printer hard disk.
- Install a hard disk with larger capacity.

## Disk full, scan job canceled

Try one or more of the following:

- Touch **Continue** to clear the message and continue scanning.
- Delete fonts, macros, and other data stored in the printer hard disk.
- Install a hard disk with higher capacity.

## Disk must be formatted for use in this device

From the printer control panel, touch **Format disk** to format the printer hard disk and clear the message.

**Note:** Formatting deletes all the files stored in the printer hard disk.

## Disk near full. Securely clearing disk space.

Try one or more of the following:

- Touch **Continue** to clear the message and continue printing.
- Delete fonts, macros, and other data stored on the printer hard disk.
- Install a hard disk with higher capacity.

## Empty the hole punch box

Try one or more of the following:

- Empty the hole punch box.
- Select **Continue** on the printer control panel to clear the message and continue printing.
- Cancel the print job.

## Error reading USB drive. Remove USB.

An unsupported USB device is inserted. Remove the USB device, and then insert a supported one.

## Error reading USB hub. Remove hub.

An unsupported USB hub has been inserted. Remove the USB hub, and then install a supported one.

## Fax memory full

From the printer control panel, touch **Continue** to clear the message.

## Fax partition inoperative. Contact system administrator.

Try one or more of the following:

- From the printer control panel, touch **Continue** to clear the message.
- Turn off the printer, and then turn it back on. If the message appears again, then contact your system support person.

## Fax server 'To Format' not set up. Contact system administrator.

Try one or more of the following:

- From the printer control panel, touch **Continue** to clear the message.
- Complete the Fax Server setup. If the message appears again, then contact your system support person.

## Fax Station Name not set up. Contact system administrator.

Try either of the following:

- From the printer control panel, touch **Continue** to clear the message.
- Complete the Analog Fax setup. If the message appears again after completing the setup, then contact your system support person.

## Fax Station Number not set up. Contact system administrator.

Try one or more of the following:

- From the printer control panel, touch **Continue** to clear the message.
- Complete the Analog Fax setup. If the message appears again after completing the setup, then contact your system support person.

## Incorrect paper size, open [paper source] [34]

Try one or more of the following:

- Load the correct paper size and type in the tray or feeder, and then specify the paper size and type in the Paper menu on the control panel.
- Make sure that the correct paper size and type are specified in Print Properties or the Print dialog settings.
- Check the length and width guides and make sure that the paper is loaded properly in the tray or feeder.
- From the control panel, touch **Continue** to clear the message and then print using a different tray.
- Touch **Reset active bin** to reset the active bin for a linked set of bins.
- Cancel the print job.

## Insert hole punch box

Insert the hole punch box into the finisher, and then touch **Continue** to clear the message.

## Insert Tray [x]

Try one or more of the following:

- Insert the specified tray into the printer.
- Cancel the print job.
- Reset the active bin for a linked set of bins by selecting **Reset active bin** on the printer control panel.

## Insufficient memory for Flash Memory Defragment operation [37]

Try one or more of the following:

- From the printer control panel, touch **Continue** to stop the defragmentation and continue printing.
- Delete fonts, macros, and other data in the printer memory.
- Install additional printer memory.

## Insufficient memory to collate job [37]

Try one or more of the following:

- From the printer control panel, touch **Continue** to print the part of the job already stored and begin collating the rest of the print job.
- Cancel the current print job.

## Insufficient memory to support Resource Save feature [35]

Install additional printer memory or touch **Continue** to disable Resource Save, clear the message, and continue printing.

## Insufficient memory, some Held Jobs were deleted [37]

From the printer control panel, touch **Continue** to clear the message.

## Insufficient memory, some held jobs will not be restored [37]

Try one or more of the following:

- From the printer control panel, touch **Continue** to clear the message.
- Delete other held jobs to free up additional printer memory.

## Insufficient space between paper stacks in Tray 3

Move the paper stacks apart, and then touch **Continue** on the control panel to clear the message and continue printing.

## Load [paper source] with [custom string] [paper orientation]

Try one or more of the following:

- Load the tray or feeder with the correct size and type of paper, and then touch **Finished loading paper** on the control panel.
- Touch **Reset active bin** to reset the active bin for a linked set of bins.
- Cancel the current job.

## Load [paper source] with [custom type name] [paper orientation]

Try one or more of the following:

- Load the tray or feeder with the correct size and type of paper, and then touch **Finished loading paper** on the control panel.
- Touch **Reset active bin** to reset the active bin for a linked set of bins.
- Cancel the print job.

## Load [paper source] with [paper size] [paper orientation]

Try one or more of the following:

- Load the tray or feeder with the correct size of paper, and then touch **Finished loading paper** on the control panel.
- Touch **Reset active bin** to reset the active bin for a linked set of bins.
- Cancel the current job.

## Load [paper source] with [paper type] [paper size] [paper orientation]

Try one or more of the following:

- Load the specified tray or feeder with the correct size and type of paper, and then touch **Finished loading paper** on the control panel.
- Touch **Reset active bin** to reset the active bin for a linked set of bins.
- Cancel the current job.

## Load Multipurpose Feeder with [custom string] [paper orientation]

Try one or more of the following:

- Load the feeder with the correct size and type of paper.
- From the control panel, touch one of the following:
  - **Prompt each page, paper loaded** or **Do not prompt, paper loaded**—To clear the message and continue printing.
  - **Automatically select paper**—To use the paper loaded in the tray.
  - **Reset active bin**—To reset the active bin for a linked set of bins.
- Cancel the print job.

## Load Multipurpose Feeder with [custom type name] [paper orientation]

Try one or more of the following:

- Load the feeder with the correct size and type of paper.
- From the control panel, touch one of the following:
  - **Prompt each page, paper loaded** or **Do not prompt, paper loaded**—To clear the message and continue printing.
  - **Automatically select paper**—To use the paper loaded in the tray.
  - **Reset active bin**—To reset the active bin for a linked set of bins.
- Cancel the print job.

## Load Multipurpose Feeder with [paper size] [paper orientation]

Try one or more of the following:

- Load the feeder with the correct size of paper.
- From the control panel, touch one of the following:
  - **Prompt each page, paper loaded** or **Do not prompt, paper loaded**—To clear the message and continue printing.
  - **Automatically select paper**—To use the paper loaded in the tray.
  - **Reset active bin**—To reset the active bin for a linked set of bins.
- Cancel the print job.

## Load Multipurpose Feeder with [paper type] [paper size] [paper orientation]

Try one or more of the following:

- Load the feeder with the correct size and type of paper.
- From the control panel, touch one of the following:
  - **Prompt each page, paper loaded** or **Do not prompt, paper loaded**—To clear the message and continue printing.
  - **Automatically select paper**—To use the paper loaded in the tray.
  - **Reset active bin**—To reset the active bin for a linked set of bins.
- Cancel the print job.

## Load staples

Try one or more of the following:

- Replace or insert the staple cartridge in the finisher.  
For instructions on inserting or replacing a staple cartridge in the finisher, touch **More information** on the printer control panel.
- From the printer control panel, touch **Continue** to clear the message and continue printing.
- From the printer control panel, touch **Cancel job** to cancel the print job.

## Load staples [G11, G12]

Try one or more of the following:

- Replace or insert the staple cartridge into the finisher.  
For instructions on replacing or inserting the staple cartridge into the finisher, touch **More information** on the control panel.
- From the control panel, touch **Continue** to clear the message and continue printing.
- Cancel the print job.

## [x] maintenance kit very low [80.xy]

You may need to replace the maintenance kit very soon. For more information, go to the Lexmark support Web site at <http://support.lexmark.com> or contact customer support, and then report the message.

If necessary, touch **Continue** to clear the message and continue printing.

## Memory full [38]

Try one or more of the following:

- From the control panel, touch **Cancel job** to clear the message.
- Touch **Reset active bin** to reset the active bin for a linked set of bins.
- Install additional printer memory.

## Memory full, cannot print faxes

From the printer control panel, touch **Continue** to clear the message without printing. Held faxes attempt to print after the printer is restarted.

## Memory full, cannot send faxes

- 1 From the printer control panel, touch **Continue** to clear the message and cancel the fax job.
- 2 Try one or more of the following:
  - Reduce the fax resolution, and then resend the fax job.
  - Reduce the number of pages in the fax, and then resend the fax job.

## No analog phone line connected to modem, fax is disabled.

Connect the printer to an analog phone line.

## Network [x] software error [54]

Try one or more of the following:

- From the printer control panel, touch **Continue** to continue printing.
- Turn off the printer, wait for about 10 seconds, and then turn the printer back on.

- Update the network firmware in the printer or print server. For more information, visit the Lexmark support Web site at <http://support.lexmark.com>.

## Not enough free space in flash memory for resources [52]

Try one or more of the following:

- From the control panel, touch **Continue** to clear the message and continue printing.
- Touch **Reset active bin** to reset the active bin for a linked set of bins.
- Delete fonts, macros, and other data stored in the flash memory.
- Install a flash memory card with larger capacity.

**Note:** Downloaded fonts and macros not previously stored in the flash memory are deleted.

## Open door H and remove paper from beneath area H10

Remove the paper from the specified area.

## Paper changes needed

Try one or more of the following:

- Touch **Use current supplies** to clear the message and continue printing.
- Cancel the current print job.

## Parallel port [x] disabled [56]

Try one or more of the following:

- From the printer control panel, touch **Continue** to clear the message.
- Enable the parallel port. From the printer control panel, navigate to:  
**Network/Ports > Parallel [x] > Parallel Buffer > Auto**

**Note:** The printer discards any data received through the parallel port.

## Photoconductor low [84.xy]

You may need to order a replacement photoconductor. If necessary, select **Continue** on the control panel to clear the message and continue printing.

## Photoconductor very low [84.xy]

You may need to replace the photoconductor unit very soon. For more information, see [“Replacing a photoconductor unit” on page 213](#).

If necessary, touch **Continue** on the control panel to clear the message and continue printing.

## Printer had to restart. Last job may be incomplete.

From the printer control panel, touch **Continue** to clear the message and continue printing.

For more information, visit <http://support.lexmark.com> or contact customer support.

## Reinstall missing or unresponsive cartridge [31.xy]

Try one or more of the following:

- Check if the toner cartridge is missing. If missing, install the toner cartridge.  
For information on installing the cartridge, see the “Replacing supplies” section of the *User’s Guide*.
- If the toner cartridge is installed, then remove the unresponsive toner cartridge, and then reinstall it.  
**Note:** If the message appears after reinstalling the supply, then the cartridge is defective. Replace the toner cartridge.

## Reinstall missing or unresponsive photoconductor [31.xy]

Try one or more of the following:

- If the photoconductor unit is missing, then install it. For more information, see [“Replacing a photoconductor unit” on page 213](#).
- If the photoconductor unit is installed, then remove and then reinstall it.  
**Note:** If the message appears after reinstalling the supply, then replace the defective photoconductor unit.

## Remove defective disk [61]

Remove and replace the defective printer hard disk.

## Remove packaging material, [area name]

Remove any remaining packaging material from the specified location.

## Remove packaging material, open door C, remove metal clips, remove all screws from scanner carriage

Open door C and the scanner cover, and then remove any remaining packaging material.

**Note:** Make sure door C does not hit any cable attached to the printer.

## Remove paper from all bins

Remove the paper from all of the bins. The printer automatically senses paper removal and resumes printing.

If removing the paper does not clear the message, then touch **Continue**.



### Remove paper from bin [x]

Remove the paper from the specified bin. The printer automatically senses paper removal and resumes printing. If removing the paper does not clear the message, then touch **Continue**.

### Remove paper from [linked set bin name]

Remove paper from the specified bin. The printer automatically detects paper removal and resumes printing. If removing the paper does not clear the message, then touch **Continue**.

### Remove paper from standard output bin

Remove the paper stack from the standard bin.

### Replace all originals if restarting job.

Try one or more of the following:

- Touch **Cancel job** to clear the message and cancel the scan job.
- Touch **Scan from automatic feeder** to continue scanning from the ADF immediately after the last successful scan job.
- Touch **Scan from flatbed** to continue scanning from the scanner immediately after the last successful scan job.
- Touch **Finish job without further scanning** to end the last successful scan job.
- Touch **Restart job** to restart the scan job with the same settings from the previous scan job.

### Replace cartridge, 0 estimated pages remain [88.xy]

Replace the toner cartridge to clear the message and continue printing. For more information, see the instruction sheet that came with the supply or see the “Replacing supplies” section of the *User’s Guide*.

**Note:** If you do not have a replacement cartridge, then see the “Ordering supplies” section of the *User’s Guide* or visit [www.lexmark.com](http://www.lexmark.com).

### Replace cartridge, printer region mismatch [42.xy]

Install a toner cartridge that matches the region number of the printer. x indicates the value of the printer region. y indicates the value of the cartridge region. x and y can have the following values:

#### Printer and toner cartridge regions

Region number	Region
0	Global
1	United States, Canada
2	European Economic Area (EEA), Switzerland
3	Asia Pacific, Australia, New Zealand
4	Latin America

Region number	Region
5	Africa, Middle East, rest of Europe
9	Invalid

**Notes:**

- The x and y values represent **.xy** in the code that appears on the printer control panel.
- The x and y values must match for printing to continue.

**Replace jammed originals if restarting job.**

Try one or more of the following:

- Touch **Cancel job** to clear the message and cancel the scan job.
- Touch **Scan from automatic feeder** to continue scanning from the ADF immediately after the last successful scan job.
- Touch **Scan from flatbed** to continue scanning from the scanner immediately after the last successful scan job.
- Touch **Finish job without further scanning** to end the last successful scan job.
- Touch **Restart job** to restart the scan job with the same settings from the previous scan job.

**Replace [x] maintenance kit, 0 estimated pages remain [80.xy]**

The printer is scheduled for maintenance. For more information, go to the Lexmark support Web site at <http://support.lexmark.com> or contact your service representative, and then report the message.

**Replace missing photoconductor [31.xy]**

Install the missing photoconductor unit to clear the message. For more information, see [“Replacing a photoconductor unit” on page 213](#).

**Replace missing waste toner bottle [82.xy]**

Install the missing waste toner bottle to clear the message. For more information, see the instruction sheet that came with the supply.

**Replace missing cartridge [31.xy]**

Install the missing cartridge to clear the message. For more information, see [“Replacing the toner cartridge” on page 221](#).

## Replace paper pick rollers in [paper source], use parts and instructions in tray 1 or tray 2 compartment [80]

Try one or more of the following:

- Replace the pick rollers, and then touch **Rollers replaced** on the control panel to clear the message and continue printing.
- Touch **Continue and replace later (Jams may continue to occur)** to ignore the message and continue printing.

## Replace photoconductor, 0 pages remain [84.xy]

Replace the photoconductor unit to clear the message and continue printing. For more information, see the instruction sheet that came with the supply or see [“Replacing a photoconductor unit” on page 213](#).

**Note:** If you do not have a replacement photoconductor unit, then see [“Ordering supplies” on page 211](#) or go to [www.lexmark.com](http://www.lexmark.com).

## Replace unsupported cartridge [32.xy]

Remove the toner cartridge, and then install a supported one to clear the message and continue printing. For more information, see the instruction sheet that came with the supply or see the “Replacing supplies” section of the *User’s Guide*.

**Note:** If you do not have a replacement cartridge, then see the “Ordering supplies” section of the *User’s Guide* or visit [www.lexmark.com](http://www.lexmark.com).

## Replace unsupported photoconductor [32.xy]

Remove the photoconductor unit, and then install a supported one to clear the message and continue printing. For more information, see the instruction sheet that came with the supply or see [“Replacing a photoconductor unit” on page 213](#).

**Note:** If you do not have a replacement photoconductor unit, then see [“Ordering supplies” on page 211](#) or go to [www.lexmark.com](http://www.lexmark.com).

## Replace waste toner bottle [82.xy]

Replace the waste toner bottle to clear the message.

## Restore held jobs?

Try one or more of the following:

- From the printer control panel, touch **Restore** to restore all held jobs stored in the printer hard disk.
- From the printer control panel, touch **Do not restore** if you do not want to restore any of the print jobs.

## Scanner disabled by admin [840.01]

Print without the scanner, or contact your system support person.

## Scanner disabled. Contact system administrator if problem persists. [840.02]

Try one or more of the following:

- Touch **Continue with scanner disabled** to return to the home screen, and then contact your system support person.
- Touch **Reboot and automatically enable scanner** to cancel the job.

**Note:** This attempts to enable the scanner.

## Scanner jam, remove jammed originals from the scanner [2yy.xx]

Remove the jammed paper from the scanner.

## Scanner maintenance required, use ADF Kit [80]

The printer is scheduled for maintenance. For more information, go to the Lexmark support Web site at <http://support.lexmark.com> or contact your service representative, and then report the message.

## Scanner maintenance required soon, use ADF Kit [80]

Contact customer support, and then report the message. The printer is scheduled for maintenance.

## Serial port [x] disabled [56]

Try one or more of the following:

- From the printer control panel, touch **Continue** to clear the message.  
The printer discards any data received through the specified serial port.
- Make sure Serial Buffer is not set to Disabled.
- From the printer control panel, set Serial Buffer to Auto in the Serial [x] menu.

## Some held jobs were not restored

From the printer control panel, touch **Continue** to delete the indicated job.

**Note:** Held jobs that are not restored remain in the printer hard disk and are inaccessible.

## SMTP server not set up. Contact system administrator.

From the printer control panel, touch **Continue** to clear the message.

**Note:** If the message appears again, then contact your system support person.

## Standard network software error [54]

Try one or more of the following:

- From the printer control panel, touch **Continue** to continue printing.
- Turn off the printer, and then turn it back on.

- Update the network firmware in the printer or print server. For more information, visit the Lexmark support Web site at <http://support.lexmark.com> or contact customer support, and then report the message.

## Standard USB port disabled [56]

Try one or more of the following:

- From the printer control panel, touch **Continue** to clear the message.
- Enable the USB port. From the printer control panel, navigate to:  
**Network/Ports > USB Buffer > Auto**

**Note:** The printer discards any data received through the USB port.

## Supply needed to complete job

Do either of the following:

- Install the missing supply to complete the job.
- Cancel the current job.

## The device is operating in Safe Mode. Some print options may be disabled or provide unexpected results.

Touch **Continue** on the control panel to clear the message and continue printing.

## Too many flash options installed [58]

Try one or more of the following:

- Touch **Continue** on the control panel to continue printing.
- Remove the extra flash memory:
  - 1 Turn off the printer.
  - 2 Unplug the power cord from the electrical outlet.
  - 3 Remove the extra flash memory.
  - 4 Connect the power cord to a properly grounded electrical outlet.
  - 5 Turn the printer back on.

## Too many trays attached [58]

- 1 Turn off the printer.
- 2 Unplug the power cord from the electrical outlet.
- 3 Remove the extra trays.
- 4 Connect the power cord to a properly grounded electrical outlet.
- 5 Turn the printer back on.

## Tray [x] paper size unsupported

Replace with a supported paper size.

## Unformatted flash detected [53]

Try one or more of the following:

- From the printer control panel, touch **Continue** to stop the defragmentation and continue printing.
- Format the flash memory.

**Note:** If the error message remains, then the flash memory may be defective and needs to be replaced.

## Unsupported disk

Remove the unsupported printer hard disk, and then insert a supported one.

## Unsupported option in slot [x] [55]

- 1 Turn off the printer.
- 2 Unplug the power cord from the electrical outlet.
- 3 Remove the unsupported option card from the printer controller board, and then replace it with a supported card.
- 4 Connect the power cord to a properly grounded electrical outlet.
- 5 Turn the printer back on.

## Waste toner bottle nearly full [82.xy]

You may need to order a waste toner bottle. If necessary, touch **Continue** on the printer control panel to clear the message and continue printing.

## Weblink server not set up. Contact system administrator.

From the printer control panel, touch **Continue** to clear the message.

**Note:** If the message appears again, then contact your system support person.

# Solving printer problems

## Basic printer problems

### The printer is not responding

Action	Yes	No
<p><b>Step 1</b> Make sure the printer is turned on.</p> <p>Is the printer turned on?</p>	Go to step 2.	Turn on the printer.
<p><b>Step 2</b> Check if the printer is in Sleep mode or Hibernate mode.</p> <p>Is the printer in Sleep mode or Hibernate mode?</p>	Press the Sleep button to wake the printer from Sleep mode or Hibernate mode.	Go to step 3.
<p><b>Step 3</b> Check if one end of the power cord is plugged into the printer and the other to a properly grounded electrical outlet.</p> <p>Is the power cord plugged into the printer and a properly grounded electrical outlet?</p>	Go to step 4.	Plug one end of the power cord into the printer and the other to a properly grounded electrical outlet.
<p><b>Step 4</b> Check other electrical equipment plugged into the electrical outlet.</p> <p>Does other electrical equipment work?</p>	Unplug the other electrical equipment, and then turn on the printer. If the printer does not work, then reconnect the other electrical equipment.	Go to step 5.
<p><b>Step 5</b> Check if the cables connecting the printer and the computer are inserted in the correct ports.</p> <p>Are the cables inserted in the correct ports?</p>	Go to step 6.	<p>Make sure to match the following:</p> <ul style="list-style-type: none"> <li>• The USB symbol on the cable with the USB symbol on the printer</li> <li>• The appropriate Ethernet cable with the Ethernet port</li> </ul>
<p><b>Step 6</b> Make sure the electrical outlet is not turned off by a switch or breaker.</p> <p>Is the electrical outlet turned off by a switch or breaker?</p>	Turn on the switch or reset the breaker.	Go to step 7.

Action	Yes	No
<p><b>Step 7</b> Check if the printer is plugged into any surge protectors, uninterruptible power supplies, or extension cords.</p> <p>Is the printer plugged into any surge protectors, uninterruptible power supplies, or extension cords?</p>	<p>Connect the printer power cord directly to a properly grounded electrical outlet.</p>	<p>Go to step 8.</p>
<p><b>Step 8</b> Check if one end of the printer cable is plugged into a port on the printer and the other to the computer, print server, option, or other network device.</p> <p>Is the printer cable securely attached to the printer and the computer, print server, option, or other network device?</p>	<p>Go to step 9.</p>	<p>Connect the printer cable securely to the printer and the computer, print server, option, or other network device.</p>
<p><b>Step 9</b> Make sure to install all hardware options properly and remove any packing material.</p> <p>Are all hardware options properly installed and all packing material removed?</p>	<p>Go to step 10.</p>	<p>Turn off the printer, remove all packing materials, then reinstall the hardware options, and then turn on the printer.</p>
<p><b>Step 10</b> Check if you have selected the correct port settings in the printer driver.</p> <p>Are the port settings correct?</p>	<p>Go to step 11.</p>	<p>Use correct printer driver settings.</p>
<p><b>Step 11</b> Check the installed printer driver.</p> <p>Is the correct printer driver installed?</p>	<p>Go to step 12.</p>	<p>Install the correct printer driver.</p>
<p><b>Step 12</b> Turn off the printer, then wait for about 10 seconds, and then turn the printer back on.</p> <p>Is the printer working?</p>	<p>The problem is solved.</p>	<p>Contact <a href="#">customer support</a>.</p>



### Printer display is blank

Action	Yes	No
<p><b>Step 1</b> Press the Sleep button on the printer control panel.</p> <p>Does <b>Ready</b> appear on the printer display?</p>	The problem is solved.	Go to step 2.
<p><b>Step 2</b> Turn off the printer, then wait for about 10 seconds, and then turn the printer back on.</p> <p>Do <b>Please wait</b> and <b>Ready</b> appear on the printer display?</p>	The problem is solved.	Turn off the printer, and then contact <a href="#">customer support</a> .

### Hardware and internal option problems

#### Cannot detect internal option

Action	Yes	No
<p><b>Step 1</b> Turn off the printer, then wait for about 10 seconds, and then turn on the printer.</p> <p>Does the internal option operate correctly?</p>	The problem is solved.	Go to step 2.
<p><b>Step 2</b> Check if the internal option is properly installed in the controller board.</p> <ul style="list-style-type: none"> <li><b>a</b> Turn off the printer using the power switch, and then unplug the power cord from the electrical outlet.</li> <li><b>b</b> Make sure the internal option is installed in the appropriate connector in the controller board.</li> <li><b>c</b> Connect the power cord to the printer, then to a properly grounded electrical outlet, and then turn on the printer.</li> </ul> <p>Is the internal option properly installed in the controller board?</p>	Go to step 3.	Connect the internal option to the controller board.
<p><b>Step 3</b> Print a menu settings page, and then check to see if the internal option is listed in the Installed Features list.</p> <p>Is the internal option listed in the menu settings page?</p>	Go to step 4.	Reinstall the internal option.

Action	Yes	No
<p><b>Step 4</b></p> <p><b>a</b> Check if the internal option is selected. It may be necessary to manually add the internal option in the printer driver to make it available for print jobs. For more information, see <a href="#">“Adding available options in the print driver” on page 45.</a></p> <p><b>b</b> Resend the print job.</p> <p>Does the internal option operate correctly?</p>	<p>The problem is solved.</p>	<p>Contact <a href="#">customer support</a>.</p>

### Internal print server does not operate correctly

Action	Yes	No
<p><b>Step 1</b></p> <p>Reinstall the internal print server.</p> <p><b>a</b> Remove, and then install the internal print server. For more information, see <a href="#">“Installing an Internal Solutions Port” on page 32.</a></p> <p><b>b</b> Print a menu settings page, and then check if the internal print server is listed in the Installed Features list.</p> <p>Is the internal print server listed in the Installed Features list?</p>	<p>Go to step 2.</p>	<p>Check if the internal print server is supported by the printer.</p> <p><b>Note:</b> An internal print server from another printer may not work with this printer.</p>
<p><b>Step 2</b></p> <p>Check the cable and the internal print server connection.</p> <p>Use the correct cable, and then check if it is securely connected to the internal print server.</p> <p>Does the internal print server operate correctly?</p>	<p>The problem is solved.</p>	<p>Contact <a href="#">customer support</a>.</p>

### Internal Solutions Port does not operate correctly

Action	Yes	No
<p><b>Step 1</b></p> <p>Make sure the Internal Solutions Port (ISP) is installed.</p> <p><b>a</b> Install the ISP. For more information, see <a href="#">“Installing an Internal Solutions Port” on page 32.</a></p> <p><b>b</b> Print a menu settings page, and then check if the ISP is listed in the Installed Features list.</p> <p>Is the ISP listed in the Installed Features list?</p>	<p>Go to step 2.</p>	<p>Check if you have a supported ISP.</p> <p><b>Note:</b> An ISP from another printer may not work on this printer.</p>

Action	Yes	No
<p><b>Step 2</b>                      Check the cable and the ISP connection.</p> <p><b>a</b> Use the correct cable, and then make sure it is securely connected to the ISP.</p> <p><b>b</b> Check if the ISP solution interface cable is securely connected into the receptacle of the controller board.</p> <p><b>Note:</b> The ISP solution interface cable and the receptacle on the controller board are color-coded.</p> <p>Does the Internal Solutions Port operate correctly?</p>	<p>The problem is solved.</p>	<p>Contact <a href="#">customer support</a>.</p>

### Tray problems

Action	Yes	No
<p><b>Step 1</b></p> <p><b>a</b> Pull out the tray, and then do one or more of the following:</p> <ul style="list-style-type: none"> <li>• Check for paper jams or misfeeds.</li> <li>• Check if the paper size indicators on the paper guides are aligned with the paper size indicators on the tray.</li> <li>• If you are printing on custom-size paper, then make sure that the paper guides rest against the edges of the paper.</li> <li>• Make sure the paper is below the maximum paper fill indicator.</li> <li>• Make sure paper lies flat in the tray.</li> </ul> <p><b>b</b> Check if the tray closes properly.</p> <p>Is the tray working?</p>	<p>The problem is solved.</p>	<p>Go to step 2.</p>
<p><b>Step 2</b></p> <p><b>a</b> Turn off the printer, then wait about 10 seconds, and then turn the printer back on.</p> <p><b>b</b> Resend the print job.</p> <p>Is the tray working?</p>	<p>The problem is solved.</p>	<p>Go to step 3.</p>
<p><b>Step 3</b></p> <p>Check if the tray is installed and recognized by the printer.                      Print a menu settings page, and then check if the tray is listed in the Installed Features list.</p> <p>Is the tray listed in the menu settings page?</p>	<p>Go to step 4.</p>	<p>Reinstall the tray. For more information, see the setup documentation that came with the tray.</p>

Action	Yes	No
<p><b>Step 4</b> Check if the tray is available in the printer driver.</p> <p><b>Note:</b> If necessary, manually add the tray in the printer driver to make it available for print jobs. For more information, see <a href="#">“Adding available options in the print driver” on page 45.</a></p> <p>Is the tray available in the printer driver?</p>	The problem is solved.	Contact <a href="#">customer support</a> .

### USB/parallel interface card does not operate correctly

Action	Yes	No
<p><b>Step 1</b> Make sure the USB or parallel interface card is installed.</p> <p><b>a</b> Install the USB or parallel interface card. For more information, see <a href="#">“Installing an Internal Solutions Port” on page 32.</a></p> <p><b>b</b> Print a menu settings page, and then check if the USB or parallel interface card is listed in the Installed Features list.</p> <p>Is the USB or parallel interface card listed in the Installed Features list?</p>	Go to step 2.	Check if you have a supported USB or parallel interface card. <b>Note:</b> A USB or parallel interface card from another printer may not work on this printer.
<p><b>Step 2</b> Check the cable and the USB or parallel interface card connection. Use the correct cable, and then make sure it is securely connected to the USB or parallel interface card.</p> <p>Does the USB or parallel interface card operate correctly?</p>	The problem is solved.	Contact <a href="#">customer support</a> .

### Paper feed problems

#### Jammed pages are not reprinted

Action	Yes	No
<p>Turn on Jam Recovery.</p> <p><b>a</b> From the home screen, navigate to:</p> <p> &gt; <b>Settings</b> &gt; <b>General Settings</b> &gt; <b>Print Recovery</b></p> <p><b>b</b> From the Jam Recovery menu, select <b>On</b> or <b>Auto</b>.</p> <p><b>c</b> Save your changes.</p> <p>Do pages reprint after a jam?</p>	The problem is solved.	Contact <a href="#">customer support</a> .

### Paper frequently jams

Action	Yes	No
<p><b>Step 1</b></p> <p><b>a</b> Pull out the tray, and then do one or more of the following:</p> <ul style="list-style-type: none"> <li>• Make sure paper lies flat in the tray.</li> <li>• Check if the paper size indicators on the paper guides are aligned with the paper size indicators on the tray.</li> <li>• Check if the paper guides are aligned against the edges of the paper.</li> <li>• Make sure the paper is below the maximum paper fill indicator.</li> <li>• Check if you are printing on a recommended paper size and type.</li> </ul> <p><b>b</b> Insert the tray properly.</p> <p>If jam recovery is enabled, then the print jobs will reprint automatically.</p> <p>Do paper jams still occur frequently?</p>	Go to step 2.	The problem is solved.
<p><b>Step 2</b></p> <p><b>a</b> Load paper from a fresh package.</p> <p><b>Note:</b> Paper absorbs moisture due to high humidity. Store paper in its original wrapper until you use it.</p> <p><b>b</b> Resend the print job.</p> <p>Do paper jams still occur frequently?</p>	Go to step 3.	The problem is solved.
<p><b>Step 3</b></p> <p><b>a</b> Review the tips on avoiding jams. For more information, see <a href="#">“Avoiding jams” on page 242</a>.</p> <p><b>b</b> Follow the recommendations, and then resend the print job.</p> <p>Do paper jams still occur frequently?</p>	Contact <a href="#">customer support</a> .	The problem is solved.

### Paper jam message remains after jam is cleared

Action	Yes	No
<p>Check the entire paper path for jammed paper.</p> <p><b>a</b> Remove any jammed paper.</p> <p><b>b</b> From the printer control panel, touch <b>Continue</b> to clear the message.</p> <p>Does the paper jam message remain?</p>	Contact <a href="#">customer support</a> .	The problem is solved.

# Solving print problems

## Printing problems

### Confidential and other held jobs do not print

**Note:** Confidential, Verify, Reserve, and Repeat print jobs may be deleted if the printer requires extra memory to process additional held jobs.

Action	Yes	No
<p><b>Step 1</b></p> <p>Open the held jobs folder on the printer display, and then verify that your print job is listed.</p> <p>Is your print job listed in the held jobs folder?</p>	Go to step 2.	Select one of the Print and Hold options, and then resend the print job. For more information, see <a href="#">“Printing confidential and other held jobs” on page 73.</a>
<p><b>Step 2</b></p> <p>The print job may contain a formatting error or invalid data.</p> <ul style="list-style-type: none"> <li>• Delete the print job, and then send it again.</li> <li>• For PDF files, generate a new PDF, and then print it again.</li> </ul> <p>If you are printing from the Internet, then the printer may be reading multiple job titles as duplicates and deleting all jobs except the first one.</p> <p><b>For Windows users</b></p> <ol style="list-style-type: none"> <li>Open the Print Properties folder.</li> <li>From the Print and Hold dialog, select the “Keep duplicate documents” check box.</li> <li>Enter a PIN number.</li> </ol> <p><b>For Macintosh users</b></p> <p>Save each print job, name each job differently, and then send the individual jobs to the printer.</p> <p>Does the job print?</p>	The problem is solved.	Go to step 3.
<p><b>Step 3</b></p> <p>Free up additional printer memory by deleting some of the held jobs.</p> <p>Does the job print?</p>	The problem is solved.	Add additional printer memory.

### Envelope seals when printing

Action	Yes	No
<p><b>a</b> Use envelopes that have been stored in a dry environment.</p> <p><b>Note:</b> Printing on envelopes with high moisture content can seal the flaps.</p> <p><b>b</b> Resend the print job.</p> <p>Does the envelope seal when printing?</p>	Contact <a href="#">customer support</a> .	The problem is solved.

### Error message about reading the flash drive appears

Action	Yes	No
<p><b>Step 1</b></p> <p>Check if the flash drive is inserted into the front USB port.</p> <p><b>Note:</b> The flash drive will not work if it is inserted into the rear USB port.</p> <p>Is the flash drive inserted into the front USB port?</p>	Go to step 2.	Insert the flash drive into the front USB port.
<p><b>Step 2</b></p> <p>Check if the indicator light on the printer control panel is blinking green.</p> <p><b>Note:</b> A green blinking light indicates that the printer is busy.</p> <p>Is the indicator light blinking green?</p>	Wait until the printer is ready, then view the held jobs list, and then print the documents.	Go to step 3.
<p><b>Step 3</b></p> <p><b>a</b> Check for an error message on the display.</p> <p><b>b</b> Clear the message.</p> <p>Does the error message still appear?</p>	Go to step 4.	The problem is solved.
<p><b>Step 4</b></p> <p>Check if the flash drive is supported.</p> <p>For more information on tested and approved USB flash drives, see <a href="#">“Supported flash drives and file types” on page 72</a>.</p> <p>Does the error message still appear?</p>	Go to step 5.	The problem is solved.
<p><b>Step 5</b></p> <p>Check if the USB port is disabled by the system support person.</p> <p>Does the error message still appear?</p>	Contact <a href="#">customer support</a> .	The problem is solved.

### Incorrect characters print

Action	Yes	No
<p><b>Step 1</b> Make sure that the printer is not in Hex Trace mode.</p> <p><b>Note:</b> If <b>Ready Hex</b> appears on the display, then turn off the printer, and then turn it back on to deactivate Hex Trace mode.</p> <p>Is the printer in Hex Trace mode?</p>	Deactivate Hex Trace mode.	Go to step 2.
<p><b>Step 2</b></p> <p><b>a</b> From the control panel, select <b>Standard Network</b> or <b>Network [x]</b>, and then set PCL SmartSwitch or PS SmartSwitch to On.</p> <p><b>b</b> Resend the print job.</p> <p>Do incorrect characters print?</p>	Contact <a href="#">customer support</a> .	The problem is solved.

### Job prints from the wrong tray or on the wrong paper

Action	Yes	No
<p><b>Step 1</b></p> <p><b>a</b> Check if you are printing on paper that is supported by the tray.</p> <p><b>b</b> Resend the print job.</p> <p>Did the job print from the correct tray or on the correct paper?</p>	The problem is solved.	Go to step 2.
<p><b>Step 2</b></p> <p><b>a</b> From the Paper menu on the printer control panel, set the paper size and type to match the paper loaded in the tray.</p> <p><b>b</b> Resend the print job.</p> <p>Did the job print from the correct tray or on the correct paper?</p>	The problem is solved.	Go to step 3.
<p><b>Step 3</b></p> <p><b>a</b> Depending on your operating system, open Printing Preferences or the Print dialog, and then specify the paper type.</p> <p><b>b</b> Resend the print job.</p> <p>Did the job print from the correct tray or on the correct paper?</p>	The problem is solved.	Go to step 4.
<p><b>Step 4</b></p> <p><b>a</b> Check if the trays are not linked.</p> <p><b>b</b> Resend the print job.</p> <p>Did the job print from the correct tray or on the correct paper?</p>	The problem is solved.	Contact <a href="#">customer support</a> .



### Large jobs do not collate

Action	Yes	No
<p><b>Step 1</b></p> <p><b>a</b> From the Finishing menu on the printer control panel, set Collate to (1,2,3) (1,2,3).</p> <p><b>b</b> Resend the print job.</p> <p>Did the job print and collate correctly?</p>	The problem is solved.	Go to step 2.
<p><b>Step 2</b></p> <p><b>a</b> From the printer software, set Collate to (1,2,3) (1,2,3).</p> <p><b>Note:</b> Setting Collate to (1,1,1) (2,2,2) in the software overrides the setting in the Finishing menu.</p> <p><b>b</b> Resend the print job.</p> <p>Did the job print and collate correctly?</p>	The problem is solved.	Go to step 3.
<p><b>Step 3</b></p> <p>Reduce the complexity of the print job by eliminating the number and size of fonts, the number and complexity of images, and the number of pages in the job.</p> <p>Did the job print and collate correctly?</p>	The problem is solved.	Contact <a href="#">customer support</a> .

### Multiple-language PDF files do not print

Action	Yes	No
<p><b>Step 1</b></p> <p><b>a</b> Check if the print options for the PDF output are set to embed all fonts. For more information, see the documentation that came with Adobe Acrobat.</p> <p><b>b</b> Generate a new PDF file, and then resend the print job.</p> <p>Do the files print?</p>	The problem is solved.	Go to step 2.
<p><b>Step 2</b></p> <p><b>a</b> Open the document you want to print in Adobe Acrobat.</p> <p><b>b</b> Click <b>File &gt; Print &gt; Advanced &gt; Print As Image &gt; OK &gt; OK</b>.</p> <p>Do the files print?</p>	The problem is solved.	Contact <a href="#">customer support</a> .

### Print job takes longer than expected

Action	Yes	No
<p><b>Step 1</b></p> <p><b>a</b> Disable Eco-Mode. From the control panel, navigate to: <b>Settings &gt; General Settings &gt; Eco-Mode &gt; Off</b></p> <p><b>Note:</b> Disabling Eco-Mode may increase the consumption of energy or paper, or both.</p> <p><b>b</b> Resend the print job.</p> <p>Did the job print?</p>	The problem is solved.	Go to step 2.
<p><b>Step 2</b></p> <p>Reduce the number and size of fonts, the number and complexity of images, and the number of pages in the print job, and then resend the job.</p> <p>Did the job print?</p>	The problem is solved.	Go to step 3.
<p><b>Step 3</b></p> <p><b>a</b> Remove held jobs stored in the printer memory.</p> <p><b>b</b> Resend the print job.</p> <p>Did the job print?</p>	The problem is solved.	Go to step 4.
<p><b>Step 4</b></p> <p><b>a</b> Disable the Page Protect feature. From the control panel, navigate to: <b>Settings &gt; General Settings &gt; Print Recovery &gt; Page Protect &gt; Off</b></p> <p><b>b</b> Resend the print job.</p> <p>Did the job print?</p>	The problem is solved.	Go to step 5.
<p><b>Step 5</b></p> <p><b>a</b> Check if the cable connections to the printer and print server are secure. For more information, see the setup documentation that came with the printer.</p> <p><b>b</b> Resend the print job.</p> <p>Did the job print?</p>	The problem is solved.	Go to step 6.
<p><b>Step 6</b></p> <p>Install additional printer memory, and then resend the print job.</p> <p>Did the job print?</p>	The problem is solved.	Contact <a href="#">customer support</a> .

### Print jobs do not print

Action	Yes	No
<p><b>Step 1</b></p> <p><b>a</b> From the document you are trying to print, open the Print dialog and check if you have selected the correct printer.</p> <p><b>Note:</b> If the printer is not the default printer, then you must select the printer for each document that you want to print.</p> <p><b>b</b> Resend the print job.</p> <p>Do the jobs print?</p>	The problem is solved.	Go to step 2.
<p><b>Step 2</b></p> <p><b>a</b> Check if the printer is plugged in and turned on, and if <b>Ready</b> appears on the printer display.</p> <p><b>b</b> Resend the print job.</p> <p>Do the jobs print?</p>	The problem is solved.	Go to step 3.
<p><b>Step 3</b></p> <p>If an error message appears on the printer display, then clear the message.</p> <p><b>Note:</b> The printer continues to print after clearing the message.</p> <p>Do the jobs print?</p>	The problem is solved.	Go to step 4.
<p><b>Step 4</b></p> <p><b>a</b> Check if the ports (USB, serial, or Ethernet) are working and if the cables are securely connected to the computer and the printer.</p> <p><b>Note:</b> For more information, see the setup documentation that came with the printer.</p> <p><b>b</b> Resend the print job.</p> <p>Do the jobs print?</p>	The problem is solved.	Go to step 5.
<p><b>Step 5</b></p> <p><b>a</b> Turn off the printer, then wait for about 10 seconds, and then turn the printer back on.</p> <p><b>b</b> Resend the print job.</p> <p>Do the jobs print?</p>	The problem is solved.	Go to step 6.
<p><b>Step 6</b></p> <p><b>a</b> Remove, and then reinstall the printer software. For more information, see <a href="#">“Installing the printer” on page 45</a>.</p> <p><b>Note:</b> The printer software is available at <a href="http://support.lexmark.com">http://support.lexmark.com</a>.</p> <p><b>b</b> Resend the print job.</p> <p>Do the jobs print?</p>	The problem is solved.	Contact <a href="#">customer support</a> .

## Tray linking does not work

### Notes:

- The trays can detect paper length.
- The multipurpose feeder does not automatically detect the paper size. You must set the size from the Paper Size/Type menu.

Action	Yes	No
<p><b>Step 1</b></p> <p><b>a</b> Open the trays, and then check if they contain paper of the same size and type.</p> <ul style="list-style-type: none"> <li>• Check if the paper guides are in the correct positions for the size of the paper loaded in each tray.</li> <li>• Check if the paper size indicators on the paper guides are aligned with the paper size indicators on the tray.</li> </ul> <p><b>b</b> Resend the print job.</p> <p>Do the trays link correctly?</p>	The problem is solved.	Go to step 2.
<p><b>Step 2</b></p> <p><b>a</b> From the printer control panel, set the paper size and type in the Paper menu to match the paper loaded in the trays to be linked.</p> <p><b>Note:</b> The paper size and type must match for trays to be linked.</p> <p><b>b</b> Resend the print job.</p> <p>Do the trays link correctly?</p>	The problem is solved.	Contact <a href="#">customer support</a> .

## Unexpected page breaks occur

Action	Yes	No
<p>Increase the printing timeout.</p> <p><b>a</b> From the home screen, navigate to:</p> <p> &gt; <b>Settings</b> &gt; <b>General Settings</b> &gt; <b>Timeouts</b></p> <p><b>b</b> Increase the Print Timeout setting, and then touch <b>Submit</b>.</p> <p><b>c</b> Resend the print job.</p> <p>Did the file print correctly?</p>	The problem is solved.	Check the original file for manual page breaks.

## Print quality problems

### Characters have jagged or uneven edges

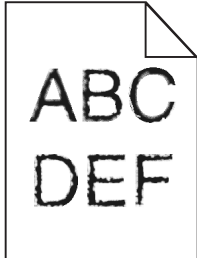

Action	Yes	No
<p><b>Step 1</b></p> <p><b>a</b> Print a font sample list to check if the fonts you are using are supported by the printer.</p> <p><b>1</b> From the printer control panel, navigate to:</p> <p> &gt; <b>Reports &gt; Print Fonts</b></p> <p><b>2</b> Touch <b>PCL Fonts</b> or <b>PostScript Fonts</b>.</p> <p><b>b</b> Use a font that is supported by the printer or install the font that you want to use. For more information, contact your system support person.</p> <p><b>c</b> Resend the print job.</p> <p>Do prints still contain characters that have jagged or uneven edges?</p>	Go to step 2.	The problem is solved.
<p><b>Step 2</b></p> <p><b>a</b> Use a font that is supported by the printer or install the font that you want to use on your computer. For more information, contact your system support person.</p> <p><b>b</b> Resend the print job.</p> <p>Do prints still contain characters that have jagged or uneven edges?</p>	Contact <a href="#">customer support</a> .	The problem is solved.

### Clipped pages or images

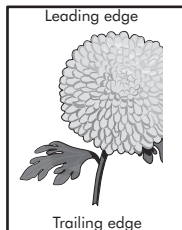
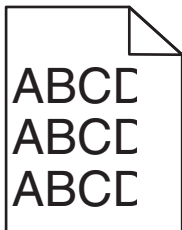

Action	Yes	No
<p><b>Step 1</b></p> <p><b>a</b> Move the paper guides in the tray to the correct positions for the paper loaded.</p> <p><b>b</b> Resend the print job.</p> <p>Is the page or image clipped?</p>	<p>Go to step 2.</p>	<p>The problem is solved.</p>
<p><b>Step 2</b></p> <p>From the control panel, set the paper size and type in the Paper menu to match the paper loaded in the tray.</p> <p>Do the paper size and type match the paper loaded in the tray?</p>	<p>Go to step 3.</p>	<p>Do one or more of the following:</p> <ul style="list-style-type: none"> <li>• Specify the paper size from the tray settings to match the paper loaded in the tray.</li> <li>• Change the paper loaded in the tray to match the paper size specified in the tray settings.</li> </ul>
<p><b>Step 3</b></p> <p><b>a</b> Depending on your operating system, specify the paper size from Printing Preferences or from the Print dialog.</p> <p><b>b</b> Resend the print job.</p> <p>Is the page or image clipped?</p>	<p>Go to step 4.</p>	<p>The problem is solved.</p>
<p><b>Step 4</b></p> <p><b>a</b> Clean the charger and the printhead lens.</p> <p><b>b</b> Resend the print job.</p> <p>Is the page or image clipped?</p>	<p>Go to step 5.</p>	<p>The problem is solved.</p>
<p><b>Step 5</b></p> <p><b>a</b> Remove, and then reinstall the photoconductor unit.</p> <p><b>Warning—Potential Damage:</b> Do not expose the photoconductor unit to direct light for more than 10 minutes. Extended exposure to light may cause print quality problems.</p> <p><b>b</b> Resend the print job.</p> <p>Is the page or image clipped?</p>	<p>Contact <a href="#">customer support</a>.</p>	<p>The problem is solved.</p>

### Gray background on prints

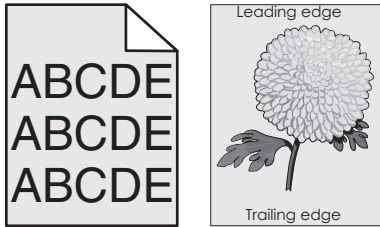

Action	Yes	No
<p><b>Step 1</b></p> <p><b>a</b> From the Quality menu on the control panel, decrease the toner darkness.</p> <p><b>b</b> Resend the print job.</p> <p>Did the gray background disappear from the prints?</p>	The problem is solved.	Go to step 2.
<p><b>Step 2</b></p> <p><b>a</b> Remove, and then reinstall the photoconductor unit and the toner cartridge.</p> <p><b>Warning—Potential Damage:</b> Do not expose the photoconductor unit to direct light for more than 10 minutes. Extended exposure to light can cause print quality problems.</p> <p><b>b</b> Resend the print job.</p> <p>Did the gray background disappear from the prints?</p>	The problem is solved.	Go to step 3.
<p><b>Step 3</b></p> <p><b>a</b> Clean the charger and the printhead lens.</p> <p><b>b</b> Resend the print job.</p> <p>Did the gray background disappear from the prints?</p>	The problem is solved.	Go to step 4.
<p><b>Step 4</b></p> <p>Replace the photoconductor unit, and then resend the print job.</p> <p>Did the gray background disappear from the prints?</p>	The problem is solved.	Contact <a href="#">customer support</a> .

### Horizontal voids appear on prints

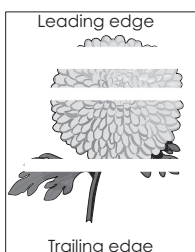

Action	Yes	No
<p><b>Step 1</b></p> <ul style="list-style-type: none"> <li>a Make sure that your software program is using a correct fill pattern.</li> <li>b Resend the print job.</li> </ul> <p>Do horizontal voids appear on prints?</p>	Go to step 2.	The problem is solved.
<p><b>Step 2</b></p> <ul style="list-style-type: none"> <li>a Load the specified tray or feeder with a recommended type of paper.</li> <li>b Resend the print job.</li> </ul> <p>Do horizontal voids appear on prints?</p>	Go to step 3.	The problem is solved.
<p><b>Step 3</b></p> <ul style="list-style-type: none"> <li>a Remove, and then reinstall the photoconductor unit.</li> </ul> <p><b>Warning—Potential Damage:</b> Do not expose the photoconductor unit to direct light for more than 10 minutes. Extended exposure to light can cause print quality problems.</p> <ul style="list-style-type: none"> <li>b Resend the print job.</li> </ul> <p>Do horizontal voids appear on prints?</p>	Go to step 4.	The problem is solved.
<p><b>Step 4</b></p> <ul style="list-style-type: none"> <li>a Clean the charger and the printhead lens.</li> <li>b Resend the print job.</li> </ul> <p>Do horizontal voids appear on prints?</p>	Go to step 5.	The problem is solved.
<p><b>Step 5</b></p> <p>Replace the photoconductor unit, and then resend the print job.</p> <p>Do horizontal voids appear on prints?</p>	Contact <a href="#">customer support</a> .	The problem is solved.

**Incorrect margins on prints**

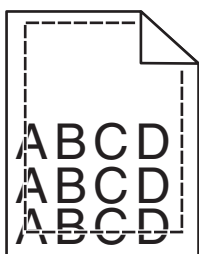



Action	Yes	No
<p><b>Step 1</b></p> <p><b>a</b> Move the width and length guides in the tray to the correct positions for the paper size loaded.</p> <p><b>b</b> Resend the print job.</p> <p>Are the margins correct?</p>	The problem is solved.	Go to step 2.
<p><b>Step 2</b></p> <p>From the printer control panel, set the paper size in the Paper menu to match the paper loaded in the tray.</p> <p>Does the paper size match the paper loaded in the tray?</p>	Go to step 3.	<p>Do one or more of the following:</p> <ul style="list-style-type: none"> <li>Specify the paper size from the tray settings to match the paper loaded in the tray.</li> <li>Change the paper loaded in the tray to match the paper size specified in the tray settings.</li> </ul>
<p><b>Step 3</b></p> <p><b>a</b> Depending on your operating system, specify the paper size from Printing Preferences or from the Print dialog.</p> <p><b>b</b> Resend the print job.</p> <p>Are the margins correct?</p>	The problem is solved.	Contact <a href="#">customer support</a> .

### Paper curl

Action	Yes	No
<p><b>Step 1</b></p> <p>Move the width and length guides in the tray to the correct positions for the size of the paper loaded.</p> <p>Are the width and length guides positioned correctly?</p>	Go to step 2.	Adjust the width and length guides.
<p><b>Step 2</b></p> <p>From the printer control panel, set the paper type and weight in the Paper menu to match the paper loaded in the tray.</p> <p>Do the paper type and weight match the type and weight of the paper in the tray?</p>	Go to step 3.	Specify the paper type and weight from the tray settings to match the paper loaded in the tray.
<p><b>Step 3</b></p> <p><b>a</b> Depending on your operating system, specify the paper type and weight from Printing Preferences or from the Print dialog.</p> <p><b>b</b> Resend the print job.</p> <p>Is the paper still curled?</p>	Go to step 4.	The problem is solved.

Action	Yes	No
<p><b>Step 4</b></p> <p><b>a</b> Remove the paper from the tray, and then turn it over.</p> <p><b>b</b> Resend the print job.</p> <p>Is the paper still curled?</p>	Go to step 5.	The problem is solved.
<p><b>Step 5</b></p> <p><b>a</b> Load paper from a fresh package.</p> <p><b>Note:</b> Paper absorbs moisture due to high humidity. Store paper in its original wrapper until you use it.</p> <p><b>b</b> Resend the print job.</p> <p>Is the paper still curled?</p>	Contact <a href="#">customer support</a> .	The problem is solved.

### Printer is printing blank pages

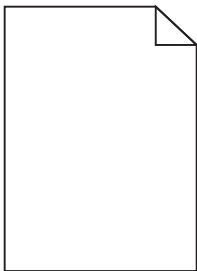

Action	Yes	No
<p><b>Step 1</b></p> <p><b>a</b> Check if there is a packing material left on the photoconductor unit.</p> <ol style="list-style-type: none"> <li><b>1</b> Remove the photoconductor unit.</li> <li><b>2</b> Check if the packing material is properly removed from the photoconductor unit.</li> </ol> <p><b>Warning—Potential Damage:</b> Do not expose the photoconductor unit to direct light for more than 10 minutes. Extended exposure to light may cause print quality problems.</p> <ol style="list-style-type: none"> <li><b>3</b> Reinstall the photoconductor unit.</li> </ol> <p><b>b</b> Resend the print job.</p> <p>Is the printer still printing blank pages?</p>	Go to step 2.	The problem is solved.
<p><b>Step 2</b></p> <p><b>a</b> Clean the charger and the printhead lens.</p> <p><b>b</b> Resend the print job.</p> <p>Is the printer still printing blank pages?</p>	Go to step 3.	The problem is solved.

Action	Yes	No
<p><b>Step 3</b>                      Replace the photoconductor unit, and then resend the print job.</p> <p>Is the printer still printing blank pages?</p>	<p>Contact <a href="#">customer support</a>.</p>	<p>The problem is solved.</p>

**Printer is printing solid black pages**



Action	Yes	No
<p><b>Step 1</b>                      a Reinstall the photoconductor unit.  <b>Warning—Potential Damage:</b> Do not expose the photoconductor unit to direct light for more than 10 minutes. Extended exposure to light may cause print quality problems.                      b Resend the print job.</p> <p>Is the printer printing solid black pages?</p>	<p>Go to step 2.</p>	<p>The problem is solved.</p>
<p><b>Step 2</b>                      a Clean the charger and the printhead lens.                      b Resend the print job.</p> <p>Is the printer printing solid black pages?</p>	<p>Go to step 3.</p>	<p>The problem is solved.</p>
<p><b>Step 3</b>                      Replace the photoconductor unit, and then resend the print job.</p> <p>Is the printer printing solid black pages?</p>	<p>Contact <a href="#">customer support</a>.</p>	<p>The problem is solved.</p>

**Print irregularities**

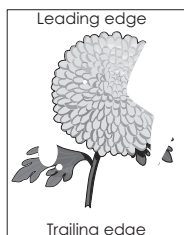
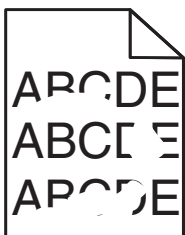

Action	Yes	No
<p><b>Step 1</b></p> <p><b>a</b> Move the paper guides in the tray to the correct positions for the paper size loaded in the tray.</p> <p><b>b</b> Resend the print job.</p> <p>Do print irregularities still appear?</p>	Go to step 2.	The problem is solved.
<p><b>Step 2</b></p> <p>From the control panel, set the paper size and type in the Paper menu to match the paper loaded in the tray.</p> <p>Do the printer settings match the size and type of the paper loaded in the tray?</p>	Go to step 3.	Specify the paper size and type in the tray settings to match the paper loaded in the tray.
<p><b>Step 3</b></p> <p><b>a</b> Depending on your operating system, specify the paper type and weight in Printing Preferences or in the Print dialog.</p> <p><b>b</b> Resend the print job.</p> <p>Do print irregularities still appear?</p>	Go to step 4.	The problem is solved.
<p><b>Step 4</b></p> <p>Check if the paper loaded in the tray has texture or rough finishes.</p> <p>Are you printing on textured or rough paper?</p>	From the control panel, set the paper texture in the Paper menu to match the paper loaded in the tray.	Go to step 5.
<p><b>Step 5</b></p> <p><b>a</b> Load paper from a fresh package.</p> <p><b>Note:</b> Paper absorbs moisture due to high humidity. Store paper in its original wrapper until you use it.</p> <p><b>b</b> Resend the print job.</p> <p>Do print irregularities still appear?</p>	Go to step 6.	The problem is solved.
<p><b>Step 6</b></p> <p><b>a</b> Clean the charger and the printhead lens.</p> <p><b>b</b> Resend the print job.</p> <p>Do print irregularities still appear?</p>	Go to step 7.	The problem is solved.
<p><b>Step 7</b></p> <p>Replace the photoconductor unit, and then resend the print job.</p> <p><b>Warning—Potential Damage:</b> Do not expose the photoconductor unit to direct light for more than 10 minutes. Extended exposure to light can cause print quality problems.</p> <p>Do print irregularities still appear?</p>	Contact <a href="#">customer support</a> or your service representative.	The problem is solved.

**Print is too dark**

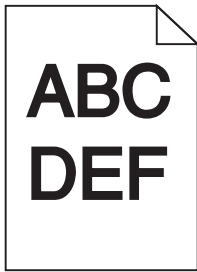

Action	Yes	No
<p><b>Step 1</b></p> <p><b>a</b> From the Quality menu on the control panel, reduce the toner darkness.</p> <p><b>Note:</b> 8 is the factory default setting.</p> <p><b>b</b> Resend the print job.</p> <p>Is the print still too dark?</p>	<p>Go to step 2.</p>	<p>The problem is solved.</p>
<p><b>Step 2</b></p> <p><b>a</b> From the control panel, set the paper type, texture, and weight in the Paper menu to match the paper loaded in the tray.</p> <p><b>b</b> Resend the print job.</p> <p>Is the tray set to the type, texture, and weight of the paper loaded?</p>	<p>Go to step 3.</p>	<p>Do one or more of the following:</p> <ul style="list-style-type: none"> <li>• Specify the paper type, texture, and weight from the tray settings to match the paper loaded in the tray.</li> <li>• Change the paper loaded in the tray to match the paper type, texture, and weight specified in the tray settings.</li> </ul>
<p><b>Step 3</b></p> <p><b>a</b> Depending on your operating system, specify the paper type, texture, and weight from Printing Preferences or from the Print dialog.</p> <p><b>b</b> Resend the print job.</p> <p>Is the print still too dark?</p>	<p>Go to step 4.</p>	<p>The problem is solved.</p>
<p><b>Step 4</b></p> <p>Check if the paper loaded in the tray has texture or rough finishes.</p> <p>Are you printing on textured or rough paper?</p>	<p>From the control panel, change the texture settings in the Paper Texture menu to match the paper you are printing on.</p>	<p>Go to step 5.</p>

Action	Yes	No
<p><b>Step 5</b></p> <p><b>a</b> Load paper from a fresh package.</p> <p><b>Note:</b> Paper absorbs moisture due to high humidity. Store paper in its original wrapper until you use it.</p> <p><b>b</b> Resend the print job.</p> <p>Is the print still too dark?</p>	Go to step 6.	The problem is solved.
<p><b>Step 6</b></p> <p><b>a</b> Clean the charger and the printhead lens.</p> <p><b>b</b> Resend the print job.</p> <p>Is the print still too dark?</p>	Go to step 7.	The problem is solved.
<p><b>Step 7</b></p> <p>Replace the photoconductor unit, and then resend the print job.</p> <p><b>Warning—Potential Damage:</b> Do not expose the photoconductor unit to direct light for more than 10 minutes. Extended exposure to light can cause print quality problems.</p> <p>Is the print still too dark?</p>	Contact <a href="#">customer support</a> .	The problem is solved.

**Print is too light**



Action	Yes	No
<p><b>Step 1</b></p> <p><b>a</b> From the Quality menu on the control panel, increase the toner darkness.</p> <p><b>Note:</b> 8 is the factory default setting.</p> <p><b>b</b> Resend the print job.</p> <p>Is the print still too light?</p>	Go to step 2.	The problem is solved.
<p><b>Step 2</b></p> <p>From the control panel, set the paper type, texture, and weight in the Paper menu to match the paper loaded in the tray.</p> <p>Is the tray set to the type, texture, and weight of the paper loaded?</p>	Go to step 3.	Change the paper type, texture, and weight to match the paper loaded in the tray.

Action	Yes	No
<p><b>Step 3</b></p> <p><b>a</b> Depending on your operating system, specify the paper type, texture, and weight from Printing Preferences or from the Print dialog.</p> <p><b>b</b> Resend the print job.</p> <p>Is the print still too light?</p>	Go to step 4.	The problem is solved.
<p><b>Step 4</b></p> <p>Make sure that the paper has no texture or rough finishes.</p> <p>Are you printing on textured or rough paper?</p>	From the control panel, change the texture settings in the Paper Texture menu to match the paper you are printing on.	Go to step 5.
<p><b>Step 5</b></p> <p><b>a</b> Load paper from a fresh package.</p> <p><b>Note:</b> Paper absorbs moisture due to high humidity. Store paper in its original wrapper until you use it.</p> <p><b>b</b> Resend the print job.</p> <p>Is the print still too light?</p>	Go to step 6.	The problem is solved.
<p><b>Step 6</b></p> <p><b>a</b> Clean the charger and the printhead lens.</p> <p><b>b</b> Resend the print job.</p> <p>Is the print still too light?</p>	Go to step 7.	The problem is solved.
<p><b>Step 7</b></p> <p>Replace the photoconductor unit, and then resend the print job.</p> <p><b>Warning—Potential Damage:</b> Do not expose the photoconductor unit to direct light for more than 10 minutes. Extended exposure to light can cause print quality problems.</p> <p>Is the print still too light?</p>	Contact <a href="#">customer support</a> .	The problem is solved.

**Repeating defects appear on prints**

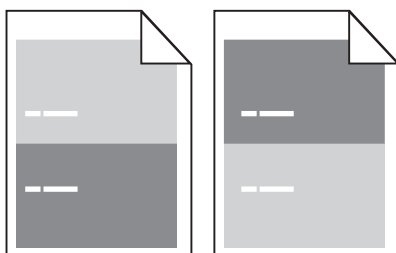

Action	Yes	No
<p><b>Step 1</b></p> <p><b>a</b> Clean the charger and the printhead lens.</p> <p><b>b</b> Resend the print job.</p> <p>Do repeating defects still appear on prints?</p>	Go to step 2.	The problem is solved.
<p><b>Step 2</b></p> <p><b>a</b> Replace the photoconductor unit if the distance between the defects is equal to 95.8 mm (3.77 in.).</p> <p><b>b</b> Resend the print job.</p> <p>Do repeating defects still appear on prints?</p>	Go to step 3.	The problem is solved.
<p><b>Step 3</b></p> <p><b>a</b> Replace the 300K maintenance kit if the distance between the defects is equal to either of the following:</p> <ul style="list-style-type: none"> <li>• 62.65 mm (2.47 in.)</li> <li>• 75.85 mm (2.99 in.)</li> </ul> <p><b>b</b> Resend the print job.</p> <p>Do repeating defects still appear on prints?</p>	Contact <a href="#">customer support</a> .	The problem is solved.

**Shadow images appear on prints**

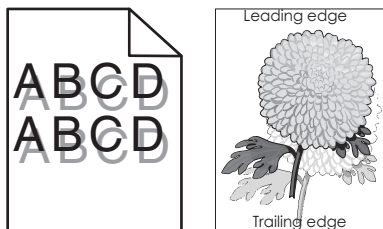

Action	Yes	No
<p><b>Step 1</b></p> <p>Load paper with the correct paper type and weight in the tray.</p> <p>Is paper with the correct paper type and weight loaded in the tray?</p>	Go to step 2.	Load paper with the correct paper type and weight in the tray.
<p><b>Step 2</b></p> <p>From the control panel, set the paper type and weight in the Paper menu to match the paper loaded in the tray.</p> <p>Is the tray set to the type and weight of the paper loaded?</p>	Go to step 3.	Change the paper loaded in the tray to match the paper type and weight specified in the tray settings.



Action	Yes	No
<p><b>Step 3</b></p> <p><b>a</b> Depending on your operating system, specify the paper type and weight from Printing Preferences or from the Print dialog.</p> <p><b>b</b> Resend the print job.</p> <p>Do shadow images still appear on prints?</p>	Go to step 4.	The problem is solved.
<p><b>Step 4</b></p> <p><b>a</b> Clean the charger and the printhead lens.</p> <p><b>b</b> Resend the print job.</p> <p>Do shadow images still appear on prints?</p>	Go to step 5.	The problem is solved.
<p><b>Step 5</b></p> <p>Replace the photoconductor unit, and then resend the print job.</p> <p><b>Warning—Potential Damage:</b> Do not expose the photoconductor unit to direct light for more than 10 minutes. Extended exposure to light can cause print quality problems.</p> <p>Do shadow images still appear on prints?</p>	Contact <a href="#">customer support</a> .	The problem is solved.

**Skewed print**

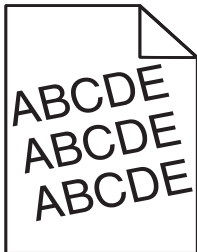

Action	Yes	No
<p><b>Step 1</b></p> <p><b>a</b> Move the width and length guides in the tray to the correct positions for the size of the paper loaded.</p> <p><b>b</b> Resend the print job.</p> <p>Is the print still skewed?</p>	Go to step 2.	The problem is solved.
<p><b>Step 2</b></p> <p><b>a</b> Check if you are printing on a paper that is supported by the tray.</p> <p><b>b</b> Resend the print job.</p> <p>Is the print still skewed?</p>	Contact <a href="#">customer support</a> .	The problem is solved.

### Streaked horizontal lines appear on prints

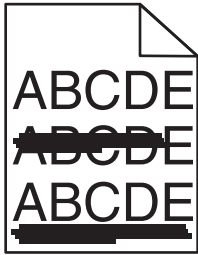

Action	Yes	No
<p><b>Step 1</b></p> <ul style="list-style-type: none"> <li><b>a</b> Depending on your operating system, specify the tray or feeder from Printing Preferences or the Print dialog.</li> <li><b>b</b> Resend the print job.</li> </ul> <p>Do streaked horizontal lines appear on prints?</p>	Go to step 2.	The problem is solved.
<p><b>Step 2</b></p> <p>From the control panel, set the paper type and weight in the Paper menu to match the paper loaded in the tray.</p> <p>Do the paper type and weight match the type and weight of the paper in the tray?</p>	Go to step 3.	Change the paper type and weight to match the paper loaded in the tray.
<p><b>Step 3</b></p> <ul style="list-style-type: none"> <li><b>a</b> Load paper from a fresh package.</li> </ul> <p><b>Note:</b> Paper absorbs moisture due to high humidity. Store paper in its original wrapper until you use it.</p> <ul style="list-style-type: none"> <li><b>b</b> Resend the print job.</li> </ul> <p>Do streaked horizontal lines appear on prints?</p>	Go to step 4.	The problem is solved.
<p><b>Step 4</b></p> <ul style="list-style-type: none"> <li><b>a</b> Remove, and then reinstall the photoconductor unit.</li> </ul> <p><b>Warning—Potential Damage:</b> Do not expose the photoconductor unit to direct light for more than 10 minutes. Extended exposure to light may cause print quality problems.</p> <ul style="list-style-type: none"> <li><b>b</b> Resend the print job.</li> </ul> <p>Do streaked horizontal lines appear on prints?</p>	Go to step 5.	The problem is solved.
<p><b>Step 5</b></p> <ul style="list-style-type: none"> <li><b>a</b> Clean the charger and the printhead lens.</li> <li><b>b</b> Resend the print job.</li> </ul> <p>Do streaked horizontal lines appear on prints?</p>	Go to step 6.	The problem is solved.

Action	Yes	No
<p><b>Step 6</b>                      Replace the photoconductor unit, and then resend the print job.</p> <p>Do streaked horizontal lines appear on prints?</p>	Contact <a href="#">customer support</a> .	The problem is solved.

**Streaked vertical lines appear on prints**

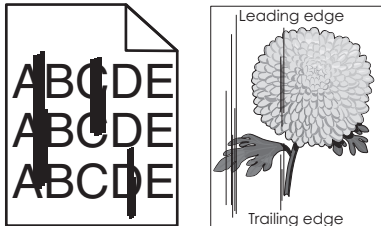

Action	Yes	No
<p><b>Step 1</b></p> <p><b>a</b> Depending on your operating system, specify the paper type, texture, and weight from Printing Preferences or from the Print dialog.</p> <p><b>b</b> Resend the print job.</p> <p>Do streaked vertical lines appear on prints?</p>	Go to step 2.	The problem is solved.
<p><b>Step 2</b></p> <p>From the control panel, set the paper texture, type, and weight in the Paper menu to match the paper loaded in the tray.</p> <p>Do the paper texture, type, and weight match the paper in the tray?</p>	Go to step 3.	Do one or more of the following: <ul style="list-style-type: none"> <li>Specify the paper texture, type, and weight from the tray settings to match the paper loaded in the tray.</li> <li>Change the paper loaded in the tray to match the paper texture, type, and weight specified in the tray settings.</li> </ul>
<p><b>Step 3</b></p> <p><b>a</b> Load paper from a fresh package.</p> <p><b>Note:</b> Paper absorbs moisture due to high humidity. Store paper in its original wrapper until you use it.</p> <p><b>b</b> Resend the print job.</p> <p>Do streaked vertical lines appear on prints?</p>	Go to step 4.	The problem is solved.

Action	Yes	No
<p><b>Step 4</b></p> <p><b>a</b> Remove, and then reinstall the photoconductor unit.</p> <p><b>1</b> Remove the photoconductor unit.</p> <p><b>Warning—Potential Damage:</b> Do not expose the photoconductor unit to direct light for more than 10 minutes. Extended exposure to light may cause print quality problems.</p> <p><b>2</b> Install the photoconductor unit.</p> <p><b>b</b> Resend the print job.</p> <p>Do streaked vertical lines appear on prints?</p>	Go to step 5.	The problem is solved.
<p><b>Step 5</b></p> <p><b>a</b> Clean the charger and the printhead lens.</p> <p><b>b</b> Resend the print job.</p> <p>Do streaked vertical lines appear on prints?</p>	Go to step 6.	The problem is solved.
<p><b>Step 6</b></p> <p>Replace the photoconductor unit, and then resend the print job.</p> <p>Do streaked vertical lines appear on prints?</p>	Contact <a href="#">customer support</a> .	The problem is solved.

**Toner fog or background shading appears on prints**

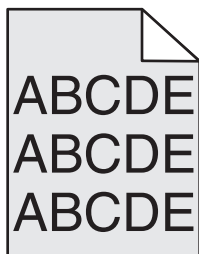

Action	Yes	No
<p><b>Step 1</b></p> <p><b>a</b> Clean the charger and the printhead lens.</p> <p><b>b</b> Resend the print job.</p> <p>Did the toner fog or background shading disappear from the prints?</p>	Go to step 2.	The problem is solved.
<p><b>Step 2</b></p> <p><b>a</b> Reinstall the photoconductor unit.</p> <p><b>Warning—Potential Damage:</b> Do not expose the photoconductor unit to direct light for more than 10 minutes. Extended exposure to light may cause print quality problems.</p> <p><b>b</b> Resend the print job.</p> <p>Did the toner fog or background shading disappear from the prints?</p>	The problem is solved.	Go to step 3.

Action	Yes	No
<p><b>Step 3</b> Replace the photoconductor unit, and then resend the print job.</p> <p>Did the toner fog or background shading disappear from the prints?</p>	The problem is solved.	Contact <a href="#">customer support</a> .

**Toner rubs off**

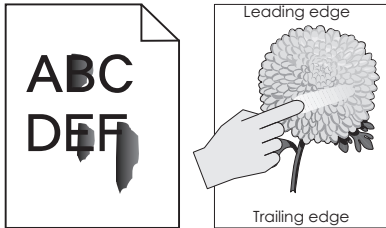

Action	Yes	No
<p><b>Step 1</b> From the Paper menu on the printer control panel, check the paper type, texture, and weight.</p> <p>Do the paper type, texture, and weight match the paper loaded in the tray?</p>	Go to step 2.	Specify the paper type, texture, and weight from the tray settings to match the paper loaded in the tray.
<p><b>Step 2</b> Resend the print job.</p> <p>Does the toner still rub off?</p>	Contact <a href="#">customer support</a> .	The problem is solved.

**Toner specks appear on prints**

Action	Yes	No
<p><b>Step 1</b></p> <ul style="list-style-type: none"> <li>a Clean the charger and the printhead lens.</li> <li>b Resend the print job.</li> </ul> <p>Do toner specks appear on prints?</p>	Go to step 2.	The problem is solved.
<p><b>Step 2</b> Replace the photoconductor unit, and then resend the print job.</p> <p>Do toner specks appear on prints?</p>	Contact <a href="#">customer support</a> .	The problem is solved.

### Transparency print quality is poor

Action	Yes	No
<p><b>Step 1</b> From the printer control panel, set the paper type in the Paper menu to match the paper loaded in the tray.</p> <p>Is the paper type for the tray set to Transparency?</p>	Go to step 2.	Set the paper type to Transparency.
<p><b>Step 2</b> a Check if you are using a recommended type of transparency. b Resend the print job.</p> <p>Is the print quality still poor?</p>	Contact <a href="#">customer support</a> .	The problem is solved.

### Uneven print density

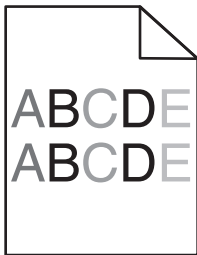

Action	Yes	No
<p><b>Step 1</b> a Clean the charger and the printhead lens. b Resend the print job.</p> <p>Is the print density uneven?</p>	Go to step 2.	The problem is solved.
<p><b>Step 2</b> Replace the photoconductor unit, and then resend the print job.</p> <p>Is the print density uneven?</p>	Contact <a href="#">customer support</a> .	The problem is solved.

### Vertical voids appear on prints

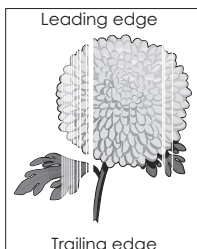

Action	Yes	No
<p><b>Step 1</b></p> <p><b>a</b> Make sure your software program is using a correct fill pattern.</p> <p><b>b</b> Resend the print job.</p> <p>Do vertical voids appear on prints?</p>	Go to step 2.	The problem is solved.
<p><b>Step 2</b></p> <p><b>a</b> From the control panel, set the paper type and weight in the Paper menu to match the paper loaded in the tray.</p> <p><b>b</b> Resend the print job.</p> <p>Do vertical voids appear on prints?</p>	Go to step 3.	The problem is solved.
<p><b>Step 3</b></p> <p>Check if you are using a recommended type of paper.</p> <p><b>a</b> Load the specified tray or feeder with a recommended type of paper.</p> <p><b>b</b> Resend the print job.</p> <p>Do vertical voids appear on prints?</p>	Go to step 4.	The problem is solved.
<p><b>Step 4</b></p> <p><b>a</b> Remove the photoconductor unit, and then reinstall it.</p> <p><b>Warning—Potential Damage:</b> Do not expose the photoconductor unit to direct light for more than 10 minutes. Extended exposure to light may cause print quality problems.</p> <p><b>b</b> Resend the print job.</p> <p>Do vertical voids appear on prints?</p>	Go to step 5.	The problem is solved.
<p><b>Step 5</b></p> <p><b>a</b> Clean the charger and the printhead lens.</p> <p><b>b</b> Resend the print job.</p> <p>Do vertical voids appear on prints?</p>	Go to step 6.	The problem is solved.
<p><b>Step 6</b></p> <p>Replace the photoconductor unit, and then resend the print job.</p> <p>Do vertical voids appear on prints?</p>	Contact <a href="#">customer support</a> .	The problem is solved.

## Solving copy problems

### Copier does not respond

Action	Yes	No
<p><b>Step 1</b> Check if an error or status message appears on the display.</p> <p>Does an error or status message appear?</p>	Clear the error or status message.	Go to step 2.
<p><b>Step 2</b> Check if the power cord is plugged into the printer and a properly grounded electrical outlet.</p> <p>Is the power cord plugged into the printer and a properly grounded electrical outlet?</p>	Go to step 3.	Connect the power cord to the printer and a properly grounded electrical outlet.
<p><b>Step 3</b> Turn off the printer, then wait for about 10 seconds, and then turn it back on.</p> <p>Did <b>Performing Self Test and Ready</b> appear?</p>	The problem is solved.	Contact <a href="#">customer support</a> .

### Partial document or photo copies

Action	Yes	No
<p><b>Step 1</b> Check the placement of the document or photo.</p> <p>Make sure the document or photo is loaded facedown on the scanner glass in the upper left corner.</p> <p>Is the document or photo loaded correctly?</p>	Go to step 2.	Place the document or photo facedown on the scanner glass in the upper left corner.
<p><b>Step 2</b> Check if the paper size setting matches the size of the paper loaded in the tray.</p> <p>From the Paper menu on the printer control panel, check the Paper Size setting.</p> <p>Does the paper size setting match the size of the paper loaded in the tray.</p>	Go to step 3.	Change the paper size setting to match the paper loaded in the tray, or load the tray with paper that matches the paper size setting.
<p><b>Step 3</b></p> <p><b>a</b> Specify the paper size. Depending on your operating system, specify the paper size in Printing Preferences or the Print dialog.</p> <p><b>b</b> Resend the print job.</p> <p>Do copies print properly?</p>	The problem is solved.	Contact <a href="#">customer support</a> .



## Poor copy quality

Action	Yes	No
<p><b>Step 1</b> Check if an error or status message appears on the display.</p> <p>Does an error or status message appear?</p>	Clear the error or status message.	Go to step 2.
<p><b>Step 2</b> Check the quality of the original document.</p> <p>Is the quality of the original document satisfactory?</p>	Go to step 3.	Increase the scan resolution setting for a higher-quality output.
<p><b>Step 3</b> If dark marks appear on prints, then clean the scanner glass and the ADF glass using a clean, lint-free cloth dampened with water.</p> <p>Is the scanner glass clean?</p>	Go to step 4.	See <a href="#">“Cleaning the scanner glass” on page 205.</a>
<p><b>Step 4</b> Send a print job, and then check for print quality problems.</p> <ul style="list-style-type: none"> <li><b>a</b> From the Copy menu, adjust the toner darkness.</li> <li><b>b</b> If the print remains faded, then replace the toner cartridge.</li> </ul> <p>Is the print quality satisfactory?</p>	Go to step 5.	See <a href="#">“Print quality problems” on page 301.</a>
<p><b>Step 5</b> Check the placement of the document or photo.</p> <p>Make sure that the document or photo is loaded facedown on the scanner glass in the upper left corner.</p> <p>Is the document or photo loaded correctly?</p>	Go to step 6.	Place the document or photo facedown on the scanner glass in the upper left corner.
<p><b>Step 6</b> Check the copy settings.</p> <p>From the Copy screen, check if the Content Type and Content Source settings are correct for the document being scanned.</p> <p>Are the Content Type and Content Source settings correct for the document being scanned?</p>	Go to step 7.	Change the Content Type and Content Source settings to match the document being scanned.
<p><b>Step 7</b> Check for patterns on prints.</p> <ul style="list-style-type: none"> <li><b>a</b> From the Copy screen, navigate to: <b>Advanced Options &gt; Advanced Imaging &gt; Sharpness</b> &gt; select a lower setting</li> <li><b>Note:</b> Make sure that no scaling is being selected.</li> <li><b>b</b> Resend the copy job.</li> </ul> <p>Do patterns appear on prints?</p>	Go to step 8.	The problem is solved.

Action	Yes	No
<p><b>Step 8</b>                      Check for missing or faded text on prints.</p> <p><b>a</b> From the Copy screen, navigate to:  <b>Advanced Options &gt; Advanced Imaging</b></p> <p><b>b</b> Adjust the settings:</p> <ul style="list-style-type: none"> <li>• <b>Sharpness</b>—Increase the current setting.</li> <li>• <b>Contrast</b>—Increase the current setting.</li> </ul> <p><b>c</b> Resend the copy job.</p> <p>Do prints have missing or faded text?</p>	<p>Go to step 9.</p>	<p>The problem is solved.</p>
<p><b>Step 9</b>                      Check for washed-out or overexposed output.</p> <p><b>a</b> From the Copy screen, navigate to:  <b>Advanced Options &gt; Advanced Imaging</b></p> <p><b>b</b> Adjust the settings of the following:</p> <ul style="list-style-type: none"> <li>• <b>Background Removal</b>—Reduce the current setting.</li> <li>• <b>Shadow Detail</b>—Reduce the current setting.</li> </ul> <p><b>c</b> Resend the copy job.</p> <p>Do pages show washed-out or overexposed prints?</p>	<p>Contact <a href="#">customer support</a>.</p>	<p>The problem is solved.</p>

## Solving fax problems

### Caller ID is not shown

Action	Yes	No
<p>Contact your telephone company to check if your telephone line is subscribed to the caller ID service.</p> <p><b>Notes:</b></p> <ul style="list-style-type: none"> <li>• If your region supports multiple caller ID patterns, then you may have to change the default setting. There are two settings available: FSK (pattern 1) and DTMF (pattern 2).</li> <li>• The availability of these settings in the Fax menu depends on whether your country or region supports multiple caller ID patterns.</li> <li>• Contact your telephone company to determine which pattern or switch setting to use.</li> </ul> <p>Does the caller ID appear?</p>	<p>The problem is solved.</p>	<p>Contact <a href="#">customer support</a>.</p>

## Cannot send or receive a fax

Action	Yes	No
<p><b>Step 1</b> Check if an error or status message appears on the display.</p> <p>Is there an error or status message on the display?</p>	Clear the error or status message.	Go to step 2.
<p><b>Step 2</b> Check if the power cord is plugged into the printer and a properly grounded electrical outlet.</p> <p>Is the power cord plugged into the printer and a properly grounded electrical outlet?</p>	Go to step 3.	Connect the power cord to the printer and a properly grounded electrical outlet.
<p><b>Step 3</b> Check the power. Check if the printer is plugged in and turned on, and if <b>Ready</b> appears on the display.</p> <p>Is the printer turned on, and does <b>Ready</b> appear on the display?</p>	Go to step 4.	Turn on the printer, and then wait until <b>Ready</b> appears on the display.
<p><b>Step 4</b> Check the printer connections. If applicable, check if the cable connections for the following equipment are secure:</p> <ul style="list-style-type: none"> <li>• Telephone</li> <li>• Handset</li> <li>• Answering machine</li> </ul> <p>Are the cable connections secure?</p>	Go to step 5.	Securely connect the cables.
<p><b>Step 5</b></p> <p><b>a</b> Check the telephone wall jack.</p> <ol style="list-style-type: none"> <li><b>1</b> Plug the telephone cable into the wall jack.</li> <li><b>2</b> Listen for a dial tone.</li> <li><b>3</b> If you do not hear a dial tone, then plug a different telephone cable into the wall jack.</li> <li><b>4</b> If you still do not hear a dial tone, then plug the telephone cable into a different wall jack.</li> <li><b>5</b> If you hear a dial tone, then connect the printer to that wall jack.</li> </ol> <p><b>b</b> Try sending or receiving a fax.</p> <p>Can you send or receive a fax?</p>	The problem is solved.	Go to step 6.

Action	Yes	No
<p><b>Step 6</b>                      Check if the printer is connected to an analog phone service or the correct digital connector.</p> <p>The fax modem is an analog device. Certain devices can be connected to the printer so that digital telephone services can be used.</p> <ul style="list-style-type: none"> <li>• If you are using an ISDN telephone service, then connect the printer to an analog telephone port (an R-interface port) on an ISDN terminal adapter. For more information and to request an R-interface port, contact your ISDN provider.</li> <li>• If you are using DSL, then connect to a DSL filter or router that will support analog use. For more information, contact your DSL provider.</li> <li>• If you are using a PBX telephone service, then make sure you are connecting to an analog connection on the PBX. If none exists, then consider installing an analog telephone line for the fax machine.</li> </ul> <p>Is the printer connected to an analog phone service or the correct digital connector?</p>	<p>Go to step 7.</p>	<p>Connect the printer to an analog phone service or the correct digital connector.</p>
<p><b>Step 7</b>                      Check for a dial tone.</p> <p>Did you hear a dial tone?</p>	<p>Go to step 8.</p>	<ul style="list-style-type: none"> <li>• Try calling the fax number to make sure that it is working properly.</li> <li>• If the telephone line is being used by another device, then wait until the other device is finished before sending a fax.</li> <li>• If you are using the On Hook Dial feature, then turn up the volume to check if you hear a dial tone.</li> </ul>
<p><b>Step 8</b>                      Temporarily disconnect other equipment (such as answering machines, computers with modems, or telephone line splitters) between the printer and the telephone line, and then try sending or receiving a fax.</p> <p>Can you send or receive a fax?</p>	<p>The problem is solved.</p>	<p>Go to step 9.</p>
<p><b>Step 9</b></p> <ol style="list-style-type: none"> <li>Temporarily disable call waiting. Contact your telephone company to obtain the keypad sequence for temporarily disabling call waiting.</li> <li>Try sending or receiving a fax.</li> </ol> <p>Can you send or receive a fax?</p>	<p>The problem is solved.</p>	<p>Go to step 10.</p>

Action	Yes	No
<p><b>Step 10</b></p> <p><b>a</b> Temporarily disable voice mail service. For more information, contact your telephone company.</p> <p><b>Note:</b> If you want to use both voice mail and the printer, then consider adding a second telephone line for the printer.</p> <p><b>b</b> Try sending or receiving a fax.</p> <p>Can you send or receive a fax?</p>	The problem is solved.	Go to step 11.
<p><b>Step 11</b></p> <p>Scan the original document one page at a time.</p> <p><b>a</b> Dial the fax number.</p> <p><b>b</b> Scan the document one page at a time.</p> <p>Can you send or receive a fax?</p>	The problem is solved.	Contact <a href="#">customer support</a> .

### Can receive but not send faxes

Action	Yes	No
<p><b>Step 1</b></p> <p>Check if the printer is in Fax mode.</p> <p>From the home screen, touch <b>Fax</b> to put the printer in Fax mode, and then send the fax.</p> <p>Can you send faxes?</p>	The problem is solved.	Go to step 2.
<p><b>Step 2</b></p> <p>Load the original document properly into the ADF tray or on the scanner glass.</p> <p>Can you send faxes?</p>	The problem is solved.	Go to step 3.
<p><b>Step 3</b></p> <p>Set up the shortcut number properly.</p> <ul style="list-style-type: none"> <li>• Check if the shortcut number has been set for the telephone number that you want to dial.</li> <li>• Dial the telephone number manually.</li> </ul> <p>Can you send faxes?</p>	The problem is solved.	Contact <a href="#">customer support</a> .



## Can send but not receive faxes

Action	Yes	No
<p><b>Step 1</b></p> <p>Check the tray or feeder. If empty, then load paper in the tray or feeder.</p> <p>Can you receive faxes?</p>	The problem is solved.	Go to step 2.
<p><b>Step 2</b></p> <p>Check the ring count delay settings.</p> <p><b>a</b> Open a Web browser, and then type the printer IP address in the address field.</p> <p><b>Notes:</b></p> <ul style="list-style-type: none"> <li>View the printer IP address on the printer home screen. The IP address appears as four sets of numbers separated by periods, such as 123.123.123.123.</li> <li>If you are using a proxy server, then temporarily disable it to load the Web page correctly.</li> </ul> <p><b>b</b> Click <b>Settings</b> &gt; <b>Fax Settings</b> &gt; <b>Analog Fax Setup</b>.</p> <p><b>c</b> In the “Rings to Answer” field, enter the number of times you want the phone to ring before the printer answers.</p> <p><b>d</b> Click <b>Submit</b>.</p> <p>Can you receive faxes?</p>	The problem is solved.	Go to step 3.
<p><b>Step 3</b></p> <p>Replace the toner cartridge. For more information, see the instruction sheet that came with the supply.</p> <p>Can you receive faxes?</p>	The problem is solved.	Contact <a href="#">customer support</a> .

## Fax and e-mail functions are not set up

**Notes:**

- Before you troubleshoot, check if the fax cables are connected.
- The indicator light is blinking red until you set up fax and e-mail.

Action	Yes	No
<p><b>a</b> From the home screen, navigate to:</p> <p> &gt; <b>Settings</b> &gt; <b>General Settings</b> &gt; <b>Run initial setup</b> &gt; <b>Yes</b> &gt; <b>Submit</b></p> <p><b>b</b> Turn off the printer, and then turn it back on. The “Select your language” screen appears on the printer display.</p> <p><b>c</b> Select a language, and then touch .</p> <p><b>d</b> Select a country or region, and then touch <b>Next</b>.</p> <p><b>e</b> Select a time zone, and then touch <b>Next</b>.</p> <p><b>f</b> Select <b>Fax</b> and <b>E-mail</b>, and then touch <b>Next</b>.</p> <p>Are fax and e-mail functions set up?</p>	<p>The problem is solved.</p>	<p>Contact <a href="#">customer support</a>.</p>

### Received fax has poor print quality

Action	Yes	No
<p><b>Step 1</b></p> <p>Ask the person who sent you the fax to:</p> <p><b>a</b> Check if the quality of the original document is satisfactory.</p> <p><b>b</b> Increase the fax scan resolution, if possible.</p> <p><b>c</b> Resend the fax.</p> <p>Is the fax print quality satisfactory?</p>	<p>The problem is solved.</p>	<p>Go to step 2.</p>

Action	Yes	No
<p><b>Step 2</b> Decrease the incoming fax transmission speed.</p> <p><b>a</b> Open a Web browser, and then type the printer IP address in the address field.</p> <p><b>Notes:</b></p> <ul style="list-style-type: none"> <li>• View the printer IP address on the printer home screen. The IP address appears as four sets of numbers separated by periods, such as 123.123.123.123.</li> <li>• If you are using a proxy server, then temporarily disable it to load the Web page correctly.</li> <li>• Print a network setup page or menu settings page, and then locate the IP address in the TCP/IP section.</li> </ul> <p><b>b</b> Click <b>Settings &gt; Fax Settings &gt; Analog Fax Setup</b>.</p> <p><b>c</b> In the Max Speed menu, click one of the following:</p> <ul style="list-style-type: none"> <li>• 2400</li> <li>• 4800</li> <li>• 9600</li> <li>• 14400</li> <li>• 33600</li> </ul> <p><b>d</b> Click <b>Submit</b>, and then resend the fax.</p> <p>Is the fax print quality satisfactory?</p>	<p>The problem is solved.</p>	<p>Go to step 3.</p>
<p><b>Step 3</b> Replace the toner cartridge.</p> <p>When <b>Cartridge low [88.xy]</b> appears, replace the cartridge, and then resend the fax.</p> <p>Is the fax print quality satisfactory?</p>	<p>The problem is solved.</p>	<p>Contact <a href="#">customer support</a>.</p>



## Solving scanner problems

### Cannot scan from a computer

Action	Yes	No
<p><b>Step 1</b> Make sure the printer is turned on and that <b>Ready</b> appears on the printer display before scanning a job.</p> <p>Does <b>Ready</b> appear before scanning the job?</p>	Go to step 3.	Go to step 2.
<p><b>Step 2</b> Turn off the printer, then wait for about 10 seconds, and then turn the printer back on.</p> <p>Is there an error message on the printer display?</p>	Clear the error message.	Go to step 3.
<p><b>Step 3</b> Check the cable connections between the printer and the print server to make sure they are secure. For more information, see the setup documentation that came with the printer.</p> <p>Are the cable connections between the printer and the print server secure?</p>	Contact <a href="#">customer support</a> .	Tighten the cable connections.

### Partial document or photo scans

Action	Yes	No
<p>Check the placement of the document or photo. Make sure the document or photo is loaded facedown on the scanner glass in the upper left corner.</p> <p>Is the document or photo loaded correctly?</p>	Contact <a href="#">customer support</a> .	Load the document or photo facedown on the scanner glass in the upper left corner.

### Poor scanned image quality

Action	Yes	No
<p><b>Step 1</b> Check if an error message appears on the display.</p> <p>Is there an error message on the printer display?</p>	Clear the error message.	Go to step 2.
<p><b>Step 2</b> Check the quality of the original document.</p> <p>Is the quality of the original document satisfactory?</p>	Go to step 3.	Increase the scan resolution settings for a higher-quality output.

Action	Yes	No
<p><b>Step 3</b></p> <p>Clean the scanner glass and the ADF glass using a clean, lint-free cloth dampened with water.</p> <p>Is the scanner glass clean?</p>	Go to step 4.	See <a href="#">“Cleaning the scanner glass” on page 205.</a>
<p><b>Step 4</b></p> <p>Check the placement of the document or photo.</p> <p>Make sure that the document or photo is loaded facedown on the scanner glass in the upper left corner.</p> <p>Is the document or photo loaded correctly?</p>	Go to step 5.	Place the document or photo facedown on the scanner glass in the upper left corner.
<p><b>Step 5</b></p> <p>Send a print job, and then check for print quality problems.</p> <ul style="list-style-type: none"> <li>From the Copy menu, adjust the toner darkness.</li> <li>When the print becomes faded, replace the toner cartridge.</li> </ul> <p>Is the print quality satisfactory?</p>	Go to step 6.	See <a href="#">“Print quality problems” on page 301.</a>
<p><b>Step 6</b></p> <p>Check the scan settings.</p> <p>From the Scan screen, make sure that the Content Type and Content Source settings are correct for the document being scanned.</p> <p>Are the Content Type and Content Source settings correct for the document being scanned?</p>	Go to step 7.	Change the Content Type and Content Source settings to match the document being scanned.
<p><b>Step 7</b></p> <p>Increase the scan resolution settings for a higher-quality output.</p> <p>Did the increased resolution produce a higher-quality output?</p>	Problem solved.	Contact <a href="#">customer support.</a>

## Scan job was not successful

Action	Yes	No
<p><b>Step 1</b></p> <p>Check the cable connections.</p> <p>Make sure the Ethernet or USB cable is securely connected to the computer and the printer.</p> <p>Are the cables securely connected?</p>	Go to step 2.	Connect the cables properly.
<p><b>Step 2</b></p> <p>Check if the file name is already in use.</p> <p>Is the file name already in use?</p>	Change the file name.	Go to step 3.

Action	Yes	No
<p><b>Step 3</b> Check if the document or photo you want to scan is open in another application or being used by another user.</p> <p>Is the file you want to scan open by another application or user?</p>	Close the file you are scanning.	Go to step 4.
<p><b>Step 4</b> Check if either the <b>Append time stamp</b> or the <b>Overwrite existing file</b> check box is selected in the destination configuration settings.</p> <p>Is the <b>Append time stamp</b> or <b>Overwrite existing file</b> check box selected in the destination configuration settings?</p>	Contact <a href="#">customer support</a> .	Select the <b>Append time stamp</b> or <b>Overwrite existing file</b> check box in the destination configuration settings.

### Scanner unit does not close

Action	Yes	No
<p>Check if there are obstructions in the scanner unit.</p> <ul style="list-style-type: none"> <li>a Lift the scanner unit.</li> <li>b Remove any obstruction keeping the scanner unit open.</li> <li>c Lower the scanner unit.</li> </ul> <p>Did the scanner unit close correctly?</p>	The problem is solved.	Contact <a href="#">customer support</a> .

### Scanning takes too long or freezes the computer

Action	Yes	No
<p><b>Step 1</b> Check if other applications are interfering with the scan. Close all applications that are not being used.</p> <p>Does scanning still take too long or freeze the computer?</p>	Go to step 2.	The problem is solved.
<p><b>Step 2</b> Select a lower scan resolution.</p> <p>Does scanning still take too long or freeze the computer?</p>	Contact <a href="#">customer support</a> .	The problem is solved.

## The scanner does not respond

Action	Yes	No
<p><b>Step 1</b> Check if the printer is turned on.</p> <p>Is the printer turned on?</p>	Go to step 2.	Turn on the printer.
<p><b>Step 2</b> Check if the printer cable is securely attached to the printer and the computer, print server, option, or other network device.</p> <p>Is the printer cable securely attached to the printer and the computer, print server, option, or other network device?</p>	Go to step 3.	Connect the printer cable securely to the printer and the computer, print server, option, or other network device.
<p><b>Step 3</b> Check if the power cord is plugged into the printer and a properly grounded electrical outlet.</p> <p>Is the power cord plugged into the printer and a properly grounded electrical outlet?</p>	Go to step 4.	Connect the power cord to the printer and a properly grounded electrical outlet.
<p><b>Step 4</b> Check if the electrical outlet is turned off by a switch or breaker.</p> <p>Is the electrical outlet turned off by a switch or breaker?</p>	Turn on the switch or reset the breaker.	Go to step 5.
<p><b>Step 5</b> Check if the printer is plugged into any surge protectors, uninterruptible power supplies, or extension cords.</p> <p>Is the printer plugged into any surge protectors, uninterruptible power supplies, or extension cords?</p>	Connect the printer power cord directly to a properly grounded electrical outlet.	Go to step 6.
<p><b>Step 6</b> Check other electrical equipment plugged into the outlet.</p> <p>Are the other electrical equipment working?</p>	Unplug the other electrical equipment and turn on the printer. If the printer does not work, then reconnect the other electrical equipment and then go to step 6.	Go to step 7.
<p><b>Step 7</b> Turn off the printer, then wait for about 10 seconds, and then turn the printer back on.</p> <p>Are the printer and scanner working?</p>	The problem is solved.	Contact <a href="#">customer support</a> .

## Solving home screen application problems

### An application error has occurred

Action	Yes	No
<p><b>Step 1</b></p> <p>Check the system log for relevant details.</p> <p><b>a</b> Open a Web browser, and then type the printer IP address in the address field.</p> <p>If you do not know the IP address of the printer, then you can:</p> <ul style="list-style-type: none"> <li>• View the IP address on the printer home screen.</li> <li>• Print a network setup page or the menu settings pages, and then locate the IP address in the TCP/IP section.</li> </ul> <p><b>Note:</b> An IP address appears as four sets of numbers separated by periods, such as 123.123.123.123.</p> <p><b>b</b> Click <b>Settings &gt; Apps &gt; Apps Management &gt; System tab &gt; Log</b>.</p> <p><b>c</b> From the Filter menu, select an application status.</p> <p><b>d</b> From the Application menu, select an application, and then click <b>Submit</b>.</p> <p>Does an error message appear in the log?</p>	Go to step 2.	Contact <a href="#">customer support</a> .
<p><b>Step 2</b></p> <p>Resolve the error.</p> <p>Is the application working now?</p>	The problem is solved.	Contact <a href="#">customer support</a> .

### Embedded Web Server does not open

Action	Yes	No
<p><b>Step 1</b></p> <p>Make sure the printer IP address is correct.</p> <p>View the printer IP address:</p> <ul style="list-style-type: none"> <li>• From the printer home screen</li> <li>• From the TCP/IP section in the Network/Ports menu</li> <li>• By printing a network setup page or menu settings page, and then finding the TCP/IP section</li> </ul> <p><b>Note:</b> An IP address appears as four sets of numbers separated by periods, such as 123.123.123.123.</p> <p>Is the printer IP address correct?</p>	Go to step 2.	Type the correct printer IP address in the address field of your Web browser. <p><b>Note:</b> Depending on the network settings, you may need to type “<b>https://</b>” instead of “<b>http://</b>” before the printer IP address to access the Embedded Web Server.</p>
<p><b>Step 2</b></p> <p>Check if the printer is turned on.</p> <p>Is the printer turned on?</p>	Go to step 3.	Turn on the printer.

Action	Yes	No
<p><b>Step 3</b> Check if the network connection is working.</p> <p>Is the network connection working?</p>	Go to step 4.	Contact your system support person.
<p><b>Step 4</b> Make sure the cable connections to the printer and print server are secure. For more information, see the setup documentation that came with the printer.</p> <p>Are the cable connections to the printer and print server secure?</p>	Go to step 5.	Tighten the cable connection.
<p><b>Step 5</b> Temporarily disable the Web proxy servers.</p> <p><b>Note:</b> Proxy servers may block or restrict you from accessing certain Web sites including the Embedded Web Server.</p> <p>Are the Web proxy servers disabled?</p>	Go to step 6.	Contact your system support person.
<p><b>Step 6</b> Access the Embedded Web Server again by typing the correct IP address in the address field.</p> <p>Did the Embedded Web Server open?</p>	The problem is solved.	Contact <a href="#">customer support</a> .

## Contacting customer support

When you contact customer support, you will need to be able to describe the problem you are experiencing, the message on the printer display, and the troubleshooting steps you have already taken to find a solution.

You need to know your printer model type and serial number. For more information, see the label at the back of the printer. The serial number is also listed on the menu settings page.

Lexmark has various ways to help you solve your printing problem. Visit the Lexmark Web site at <http://support.lexmark.com>, and then select one of the following:

<b>Tech Library</b>	You can browse our library of manuals, support documentation, drivers, and other downloads to help you solve common problems.
<b>E-mail</b>	You can send an e-mail to the Lexmark team, describing your problem. A service representative will respond and provide you with information to solve your problem.
<b>Live chat</b>	You can chat directly with a service representative. They can work with you to solve your printer problem or provide assistance through Assisted Service where the service representative can remotely connect to your computer through the Internet to troubleshoot problems, install updates, or complete other tasks to help you successfully use your Lexmark product.

Telephone support is also available. In the U.S. or Canada, call 1-800-539-6275. For other countries or regions, visit <http://support.lexmark.com>.

# Notices

## Product information

Product name:

Lexmark MX910de, MX911dte, MX912dxe

Machine type:

7421

Model(s):

036, 236, 436

## Edition notice

June 2014

**The following paragraph does not apply to any country where such provisions are inconsistent with local law:**

LEXMARK INTERNATIONAL, INC., PROVIDES THIS PUBLICATION "AS IS" WITHOUT WARRANTY OF ANY KIND, EITHER EXPRESS OR IMPLIED, INCLUDING, BUT NOT LIMITED TO, THE IMPLIED WARRANTIES OF MERCHANTABILITY OR FITNESS FOR A PARTICULAR PURPOSE. Some states do not allow disclaimer of express or implied warranties in certain transactions; therefore, this statement may not apply to you.

This publication could include technical inaccuracies or typographical errors. Changes are periodically made to the information herein; these changes will be incorporated in later editions. Improvements or changes in the products or the programs described may be made at any time.

References in this publication to products, programs, or services do not imply that the manufacturer intends to make these available in all countries in which it operates. Any reference to a product, program, or service is not intended to state or imply that only that product, program, or service may be used. Any functionally equivalent product, program, or service that does not infringe any existing intellectual property right may be used instead. Evaluation and verification of operation in conjunction with other products, programs, or services, except those expressly designated by the manufacturer, are the user's responsibility.

For Lexmark technical support, visit <http://support.lexmark.com>.

For information on supplies and downloads, visit [www.lexmark.com](http://www.lexmark.com).

© 2014 Lexmark International, Inc.

All rights reserved.

## GOVERNMENT END USERS

The Software Program and any related documentation are "Commercial Items," as that term is defined in 48 C.F.R. 2.101, "Computer Software" and "Commercial Computer Software Documentation," as such terms are used in 48 C.F.R. 12.212 or 48 C.F.R. 227.7202, as applicable. Consistent with 48 C.F.R. 12.212 or 48 C.F.R. 227.7202-1 through 227.7202-4, as applicable, the Commercial Computer Software and Commercial Software Documentation are licensed to the U.S. Government end users (a) only as Commercial Items and (b) with only those rights as are granted to all other end users pursuant to the terms and conditions herein.

## Trademarks

Lexmark, Lexmark with diamond design, MarkNet, and MarkVision are trademarks of Lexmark International, Inc., registered in the United States and/or other countries.

ScanBack is a trademark of Lexmark International, Inc.

Mac and the Mac logo are trademarks of Apple Inc., registered in the U.S. and other countries.

PCL® is a registered trademark of the Hewlett-Packard Company. PCL is Hewlett-Packard Company’s designation of a set of printer commands (language) and functions included in its printer products. This printer is intended to be compatible with the PCL language. This means the printer recognizes PCL commands used in various application programs, and that the printer emulates the functions corresponding to the commands.

The following terms are trademarks or registered trademarks of these companies:

Albertus	The Monotype Corporation plc
Antique Olive	Monsieur Marcel OLIVE
Apple-Chancery	Apple Computer, Inc.
Arial	The Monotype Corporation plc
CG Times	Based on Times New Roman under license from The Monotype Corporation plc, is a product of Agfa Corporation
Chicago	Apple Computer, Inc.
Clarendon	Linotype-Hell AG and/or its subsidiaries
Eurostile	Nebiolo
Geneva	Apple Computer, Inc.
Gillsans	The Monotype Corporation plc
Helvetica	Linotype-Hell AG and/or its subsidiaries
Hoefler	Jonathan Hoefler Type Foundry
ITC Avant Garde Gothic	International Typeface Corporation
ITC Bookman	International Typeface Corporation
ITC Mona Lisa	International Typeface Corporation
ITC Zapf Chancery	International Typeface Corporation
Joanna	The Monotype Corporation plc
Marigold	Arthur Baker
Monaco	Apple Computer, Inc.
New York	Apple Computer, Inc.
Oxford	Arthur Baker
Palatino	Linotype-Hell AG and/or its subsidiaries
Stempel Garamond	Linotype-Hell AG and/or its subsidiaries
Taffy	Agfa Corporation
Times New Roman	The Monotype Corporation plc



Univers	Linotype-Hell AG and/or its subsidiaries
---------	--

All other trademarks are the property of their respective owners.

AirPrint and the AirPrint logo are trademarks of Apple, Inc.

## Federal Communications Commission (FCC) compliance information statement

This product has been tested and found to comply with the limits for a Class A digital device, pursuant to Part 15 of the FCC Rules. Operation is subject to the following two conditions: (1) this device may not cause harmful interference, and (2) this device must accept any interference received, including interference that may cause undesired operation.

The FCC Class A limits are designed to provide reasonable protection against harmful interference when the equipment is operated in a commercial environment. This equipment generates, uses, and can radiate radio frequency energy and, if not installed and used in accordance with the instruction manual, may cause harmful interference to radio communications. Operation of this equipment in a residential area is likely to cause harmful interference, in which case the user will be required to correct the interference at his own expense.

The manufacturer is not responsible for any radio or television interference caused by using other than recommended cables or by unauthorized changes or modifications to this equipment. Unauthorized changes or modifications could void the user's authority to operate this equipment.

**Note:** To assure compliance with FCC regulations on electromagnetic interference for a Class A computing device, use a properly shielded and grounded cable such as Lexmark part number 1021231 for parallel attach or 1021294 for USB attach. Use of a substitute cable not properly shielded and grounded may result in a violation of FCC regulations.

## Licensing notices

All licensing notices associated with this product can be viewed from the CD:\NOTICES directory of the installation software CD.

## Noise emission levels

The following measurements were made in accordance with ISO 7779 and reported in conformance with ISO 9296.

**Note:** Some modes may not apply to your product.

1-meter average sound pressure, dBA	
Printing	One-sided: 52 (MX910de), 53 (MX911de, MX911dte), 55 (MX912de, MX912dxe); Two-sided: 55 (MX910de, MX911de, MX911dte), 56 (MX912de, MX912dxe)
Scanning	57 (MX910de); 56 (MX911de, MX911dte, MX912de, MX912dxe)
Copying	53 (MX910de); 54 (MX911de, MX911dte); 55 (MX911de, MX911dte)
Ready	29 (MX910de); 31 (MX911de, MX911dte, MX912de, MX912dxe)

Values are subject to change. See [www.lexmark.com](http://www.lexmark.com) for current values.

## Waste from Electrical and Electronic Equipment (WEEE) directive



The WEEE logo signifies specific recycling programs and procedures for electronic products in countries of the European Union. We encourage the recycling of our products.

If you have further questions about recycling options, visit the Lexmark Web site at [www.lexmark.com](http://www.lexmark.com) for your local sales office phone number.

## India E-Waste notice

This product complies with the India E-Waste (Management and Handling) Rules, 2011, which prohibit use of lead, mercury, hexavalent chromium, polybrominated biphenyls, or polybrominated diphenyl ethers in concentrations exceeding 0.1% by weight and 0.01% by weight for cadmium, except for the exemption set in Schedule II of the Rules.

## Product disposal

Do not dispose of the printer or supplies in the same manner as normal household waste. Consult your local authorities for disposal and recycling options.

## Static sensitivity notice



This symbol identifies static-sensitive parts. Do not touch in the areas near these symbols without first touching the metal frame of the printer.

## ENERGY STAR

Any Lexmark product bearing the ENERGY STAR emblem on the product or on a start-up screen is certified to comply with Environmental Protection Agency (EPA) ENERGY STAR requirements as configured when shipped by Lexmark.



### Temperature information

Ambient operating temperature	10 to 30°C (50 to 86°F)
Shipping temperature	-10 to 40°C (14 to 104°F)
Storage temperature and relative humidity	-10 to 40°C (14 to 104°F) 15 to 85% RH

### Laser notice

The printer is certified in the U.S. to conform to the requirements of DHHS 21 CFR Chapter I, Subchapter J for Class I (1) laser products, and elsewhere is certified as a Class I laser product conforming to the requirements of IEC 60825-1.

Class I laser products are not considered to be hazardous. The printer contains internally a Class IIIb (3b) laser that is nominally a 10 milliwatt gallium arsenide laser operating in the wavelength of 787-800 nanometers. The laser system and printer are designed so there is never any human access to laser radiation above a Class I level during normal operation, user maintenance, or prescribed service condition.

### Laser advisory label

A laser notice label may be affixed to this printer as shown:

DANGER - Invisible laser radiation when cartridges are removed and interlock defeated. Avoid exposure to laser beam.

PERIGO - Radiação a laser invisível será liberada se os cartuchos forem removidos e o lacre rompido. Evite a exposição aos feixes de laser.

Opasnost - Nevidljivo lasersko zračenje kada su kasete uklonjene i poništena sigurnosna veza. Izbjegavati izlaganje zracima.

NEBEZPEČÍ - Když jsou vyjmuty kazety a je odblokována pojistka, ze zařízení je vysíláno neviditelné laserové záření. Nevystavujte se působení laserového paprsku.

FARE - Usynlig laserstråling, når patroner fjernes, og spærreanordningen er slået fra. Undgå at blive udsat for laserstrålen.

GEVAAR - Onzichtbare laserstraling wanneer cartridges worden verwijderd en een vergrendeling wordt genegeerd. Voorkom blootstelling aan de laser.

DANGER - Rayonnements laser invisibles lors du retrait des cartouches et du déverrouillage des loquets. Eviter toute exposition au rayon laser.

VAARA - Näkymätöntä lasersäteilyä on varottava, kun värikasetit on poistettu ja lukitus on auki. Vältä lasersäteelle altistumista.

GEFAHR - Unsichtbare Laserstrahlung beim Herausnehmen von Druckkassetten und offener Sicherheitssperre. Laserstrahl meiden.

ΚΙΝΔΥΝΟΣ - Εκκυσση αόρατης ακτινοβολίας laser κατά την αφαίρεση των κασετών και την απασφάλιση της μανδάλωσης. Αποφεύγετε την έκθεση στην ακτινοβολία laser.

VESZÉLY - Nem látható lézersugárzás fordulhat elő a patronok eltávolításakor és a zárószervezet felbontásakor. Kerülje a lézersugárnak való kitettséget.

PERICOLO - Emissioni di radiazioni laser invisibili durante la rimozione delle cartucce e del blocco. Evitare l'esposizione al raggio laser.

FARE - Usynlig laserstråling når kassetene tas ut og sperren er satt ut av spill. Unngå eksponering for laserstrålen.

NIEBEZPIECZEŃSTWO - niewidzialne promieniowanie laserowe podczas usuwania kaset i blokady. Należy unikać naświetlenia promieniami lasera.

ОПАСНО! Невидимое лазерное излучение при извлеченных картриджах и снятии блокировки. Избегайте воздействия лазерных лучей.

Pozor - Nebezpečnostvo neviditeľného laserového žiarenia pri odobratých kazetách a odblokovanej poistke. Nevystavujte sa lúčom.

PELIGRO: Se producen radiaciones láser invisibles al extraer los cartuchos con el interbloqueo desactivado. Evite la exposición al haz de láser.

FARA - Osynlig laserstrålning när patroner tas ur och spärrmekanismen är upphävd. Undvik exponering för laserstrålen.

危険 - 当移除碳粉盒及互锁失效时会产生看不见的激光辐射, 请避免暴露在激光光束下。

危険 - 移除碳粉匣與安全連續開關失效時會產生看不見的雷射輻射。請避免曝露在雷射光束下。

危険 - カートリッジが取り外され、内部ロックが無効になると、見えないレーザー光が放射されます。このレーザー光に当たらないようにしてください。

## Power consumption

### Product power consumption

The following table documents the power consumption characteristics of the product.

**Note:** Some modes may not apply to your product.

Mode	Description	Power consumption (Watts)
Printing	The product is generating hard-copy output from electronic inputs.	One-sided: 865 (MX910de), 925 (MX911de, MX911dte), 985 (MX912de, MX912dxe); Two-sided: 790 (MX910de), 850 (MX911de, MX911dte), 890 (MX912de, MX912dxe)
Copy	The product is generating hard-copy output from hard-copy original documents.	880 (MX910de); 950 ( MX911de, MX911dte); 1000 (MX912de, MX912dxe)
Scan	The product is scanning hard-copy documents.	230
Ready	The product is waiting for a print job.	220
Sleep Mode	The product is in a high-level energy-saving mode.	3.6
Hibernate	The product is in a low-level energy-saving mode.	0.6
Off	The product is plugged into an electrical outlet, but the power switch is turned off.	0

The power consumption levels listed in the previous table represent time-averaged measurements. Instantaneous power draws may be substantially higher than the average.

Values are subject to change. See [www.lexmark.com](http://www.lexmark.com) for current values.

## Sleep Mode

This product is designed with an energy-saving mode called *Sleep Mode*. The Sleep Mode saves energy by lowering power consumption during extended periods of inactivity. The Sleep Mode is automatically engaged after this product is not used for a specified period of time, called the *Sleep Mode Timeout*.

Factory default Sleep Mode Timeout for this product (in minutes):
---

20
----

By using the configuration menus, the Sleep Mode Timeout can be modified between 1 minute and 120 minutes. Setting the Sleep Mode Timeout to a low value reduces energy consumption, but may increase the response time of the product. Setting the Sleep Mode Timeout to a high value maintains a fast response, but uses more energy.

## Hibernate Mode

This product is designed with an ultra-low power operating mode called *Hibernate mode*. When operating in Hibernate Mode, all other systems and devices are powered down safely.

The Hibernate mode can be entered in any of the following methods:

- Using the Hibernate Timeout
- Using the Schedule Power modes
- Using the Sleep/Hibernate button

Factory default Hibernate Timeout for this product in all countries or regions
--

3 days
--------

The amount of time the printer waits after a job is printed before it enters Hibernate mode can be modified between one hour and one month.

## Off mode

If this product has an off mode which still consumes a small amount of power, then to completely stop product power consumption, disconnect the power supply cord from the electrical outlet.

## Total energy usage

It is sometimes helpful to calculate the total product energy usage. Since power consumption claims are provided in power units of Watts, the power consumption should be multiplied by the time the product spends in each mode in order to calculate energy usage. The total product energy usage is the sum of each mode's energy usage.

## Industry Canada compliance statement

This Class A digital apparatus meets all requirements of the Canadian Interference-Causing Equipment Standard ICES-003.

## Avis de conformité aux normes de l'industrie du Canada

Cet appareil numérique de classe A est conforme aux exigences de la norme canadienne relative aux équipements pouvant causer des interférences NMB-003.

## Japanese VCCI notice

製品にこのラベルが表示されている場合、次の要件を満たしています。

この装置は、クラス A 情報技術装置です。この装置を家庭環境で使用すると電波妨害を引き起こすことがあります。この場合には使用者が適切な対策を講ずるよう要求されることがあります。 VCCI-A

この装置は、クラスA情報技術装置です。この装置を家庭環境で使用すると電波妨害を引き起こすことがあります。この場合には使用者が適切な対策を講ずるよう要求されることがあります。 VCCI-A

## European Community (EC) directives conformity

This product is in conformity with the protection requirements of EC Council directives 2004/108/EC, 2006/95/EC, and 2011/65/EU on the approximation and harmonization of the laws of the Member States relating to electromagnetic compatibility, safety of electrical equipment designed for use within certain voltage limits, and on the restrictions of use of certain hazardous substances in electrical and electronic equipment.

The manufacturer of this product is: Lexmark International, Inc., 740 West New Circle Road, Lexington, KY, 40550 USA. The authorized representative is: Lexmark International Technology Hungária Kft., 8 Lechner Ödön fasor, Millennium Tower III, 1095 Budapest HUNGARY, A declaration of conformity to the requirements of the Directives is available upon request from the Authorized Representative.

This product satisfies the Class A limits of EN 55022 and safety requirements of EN 60950-1.

## Radio interference notice

### Warning

This is a product that complies with the emission requirements of EN55022 Class A limits and immunity requirements of EN55024. This product is not intended to be used in residential/domestic environments.

This is a Class A product. In a domestic environment, this product may cause radio interference, in which case the user may be required to take adequate measures.

## Regulatory notices for telecommunication terminal equipment

This section contains regulatory information pertaining to products that contain telecommunication terminal equipment such as facsimile.

## Notice to users of the US telephone network: FCC requirements

This equipment complies with Part 68 of the FCC rules and the requirements adopted by the Administrative Council for Terminal Attachments (ACTA). On the back of this equipment is a label that contains, among other information, a product identifier in the format US:AAAEQ##TXXXX. If requested, this number must be provided to your telephone company.

This equipment uses the RJ-11C Universal Service Order Code (USOC) jack.

A plug and jack used to connect this equipment to the premises' wiring and telephone network must comply with the applicable FCC Part 68 rules and requirements adopted by the ACTA. A compliant telephone cord and modular plug is provided with this product. It is designed to be connected to a compatible modular jack that is also compliant. See your setup documentation for more information.

The Ringer Equivalence Number (REN) is used to determine the number of devices that may be connected to a telephone line. Excessive RENs on a telephone line may result in the devices not ringing in response to an incoming call. In most but not all areas, the sum of RENs should not exceed five (5.0). To be certain of the number of devices that may be connected to a line, as determined by the total RENs, contact your local telephone company. For products approved after July 23, 2001, the REN for this product is part of the product identifier that has the format US:AAAEQ##TXXXX. The digits represented by ## are the REN without a decimal point (for example, 03 is a REN of 0.3). For earlier products, the REN is shown separately on the label.

If this equipment causes harm to the telephone network, the telephone company will notify you in advance that temporary discontinuance of service may be required. If advance notice is not practical, the telephone company will notify the customer as soon as possible. You will also be advised of your right to file a complaint with the FCC.

The telephone company may make changes in its facilities, equipment, operations or procedures that could affect the operation of this equipment. If this happens, the telephone company will provide advance notice in order for you to make necessary modifications to maintain uninterrupted service.

If you experience trouble with this equipment, for repair or warranty information, contact Lexmark International, Inc. at [www.lexmark.com](http://www.lexmark.com) or your Lexmark representative. If the equipment is causing harm to the telephone network, the telephone company may request that you disconnect the equipment until the problem is resolved.

This equipment contains no user serviceable parts. For repair and warranty information, contact Lexmark International, Inc. See the previous paragraph for contact information.

Connection to party line service is subject to state tariffs. Contact the state public utility commission, public service commission, or corporation commission for information.

If your home has specially wired alarm equipment connected to the telephone line, ensure the installation of this equipment does not disable your alarm equipment. If you have questions about what will disable alarm equipment, consult your telephone company or a qualified installer.

Telephone companies report that electrical surges, typically lightning transients, are very destructive to customer terminal equipment connected to AC power sources. This has been identified as a major nationwide problem. It is recommended that the customer install an appropriate AC surge arrester in the AC outlet to which this device is connected. An appropriate AC surge arrester is defined as one that is suitably rated, and certified by UL (Underwriter's Laboratories), another NRTL (Nationally Recognized Testing Laboratory), or a recognized safety certification body in the country/region of use. This is to avoid damage to the equipment caused by local lightning strikes and other electrical surges.

The Telephone Consumer Protection Act of 1991 makes it unlawful for any person to use a computer or other electronic device, including fax machines, to send any message unless said message clearly contains in a margin at the top or bottom of each transmitted page or on the first page of the transmission, the date and time it is sent and an identification of the business or other entity, or other individual sending the message, and the telephone number of the sending machine or such business, other entity, or individual. (The telephone number provided may not be a 900 number or any other number for which charges exceed local or long-distance transmission charges.)

See your user documentation in order to program this information into your fax machine.

## Notice to users of the Canadian telephone network

This product meets the applicable Industry Canada technical specifications. The Ringer Equivalence Number (REN) is an indication of the maximum number of terminals allowed to be connected to a telephone interface. The terminus of

an interface may consist of any combination of devices, subject only to the requirement that the sum of the RENs of all the devices does not exceed five. The modem REN is located on the rear of the equipment on the product labeling.

Telephone companies report that electrical surges, typically lightning transients, are very destructive to customer terminal equipment connected to AC power sources. This has been identified as a major nationwide problem. It is recommended that the customer install an appropriate AC surge arrester in the AC outlet to which this device is connected. An appropriate AC surge arrester is defined as one that is suitably rated, and certified by UL (Underwriter's Laboratories), another NRTL (Nationally Recognized Testing Laboratory), or a recognized safety certification body in the country/region of use. This is to avoid damage to the equipment caused by local lightning strikes and other electrical surges.

This equipment uses CA11A telephone jacks.

### **Avis réservé aux utilisateurs du réseau téléphonique du Canada**

Ce produit est conforme aux spécifications techniques d'Industrie Canada. Le numéro REN (ringer equivalence number : numéro d'équivalence de sonnerie) fournit une indication du nombre maximum de terminaux pouvant être connectés à l'interface téléphonique. En bout de ligne, le nombre d'appareils qui peuvent être connectés n'est pas directement limité, mais la somme des REN de ces appareils ne doit pas dépasser cinq. Le numéro REN du modem est indiqué sur l'étiquette produit située à l'arrière de l'équipement.

Les compagnies de téléphone constatent que les surtensions électriques, en particulier celles dues à la foudre, entraînent d'importants dégâts sur les terminaux privés connectés à des sources d'alimentation CA. Il s'agit-là d'un problème majeur d'échelle nationale. En conséquence, il vous est recommandé de brancher un parasurtenseur dans la prise de courant à laquelle l'équipement est connecté. Utilisez un parasurtenseur répondant à des caractéristiques nominales satisfaisantes et certifié par le laboratoire d'assureurs UL (Underwriter's Laboratories), un autre laboratoire agréé de type NRTL (Nationally Recognized Testing Laboratory) ou un organisme de certification agréé dans votre région ou pays. Ceci prévient tout endommagement de l'équipement causé par les orages et autres surtensions électriques.

Cet équipement utilise des prises de téléphone CA11A.

### **Notice to users of the New Zealand telephone network**

The following are special conditions for the Facsimile User Instructions. The grant of a telepermit for any item of terminal equipment indicates only that Telecom has accepted that the item complies with minimum conditions for connection to its network. It indicates no endorsement of the product by Telecom, nor does it provide any sort of warranty. Above all, it provides no assurance that any item will work correctly in all respects with another item of telepermitted equipment of a different make or model, nor does it imply that any product is compatible with all of Telecom's network services.

This equipment shall not be set up to make automatic calls to the Telecom's 111 Emergency Service.

This equipment may not provide for the effective hand-over of a call to another device connected to the same line.

This equipment should not be used under any circumstances that may constitute a nuisance to other Telecom customers.

Some parameters required for compliance with Telecom's telepermit requirements are dependent on the equipment associated with this device. The associated equipment shall be set to operate within the following limits for compliance to Telecom's specifications:

- There shall be no more than 10 call attempts to the same number within any 30 minute period for any single manual call initiation, and
- The equipment shall go on-hook for a period of not less than 30 seconds between the end of one attempt and the beginning of the next call attempt.



- The equipment shall be set to ensure that automatic calls to different numbers are spaced such that there is not less than 5 seconds between the end of one call attempt and the beginning of another.

## Japanese telecom notice

The installed optional modem is in compliance with Japanese Telecommunication Law and has been Certified by JATE, with Certification Number A11-0160001.

	Lexmark International, Inc.
	LEX-M03-002
	A11-0160001JP

## Using this product in Switzerland

This product requires a Swiss billing tone filter (Lexmark part number 80D1877) to be installed on any line which receives metering pulses in Switzerland. The filter must be used, as metering pulses are present on all analog telephone lines in Switzerland.

## Utilisation de ce produit en Suisse

Cet appareil nécessite l'utilisation d'un filtre de tonalité de facturation suisse (n° de référence Lexmark : 80D1877) devant être installé sur toute ligne recevant des impulsions de comptage en Suisse. Ce filtre doit être utilisé pour toute installation car ces impulsions existent sur toutes les lignes téléphoniques suisses.

## Verwendung dieses Produkts in der Schweiz

Für dieses Produkt muss ein schweizerischer Billing Tone Filter zur Zählzeichenübertragung (Lexmark Teilenummer 80D1877) für jede Leitung installiert werden, über die in der Schweiz Zeitsteuertakte übertragen werden. Die Verwendung des Filters ist obligatorisch, da in allen analogen Telefonleitungen in der Schweiz Zeitsteuertakte vorhanden sind.

## Uso del prodotto in Svizzera

Questo prodotto richiede un filtro toni Billing svizzero, (codice Lexmark 80D1877) da installare su tutte le linee che ricevono impulsi remoti in Svizzera. È necessario utilizzare il filtro poiché gli impulsi remoti sono presenti su tutte le linee analogiche in Svizzera.

## Notice to Users in the European Union

Products bearing the CE mark are in conformity with the protection requirements of EC Council directives 2004/108/EC, 2006/95/EC, 1999/5/EC, and 2011/65/EU on the approximation and harmonization of the laws of the Member States

relating to electromagnetic compatibility, safety of electrical equipment designed for use within certain voltage limits, radio equipment and telecommunications terminal equipment, and on the restrictions of use of certain hazardous substances in electrical and electronic equipment.

Compliance is indicated by the CE marking.



The manufacturer of this product is: Lexmark International, Inc., 740 West New Circle Road, Lexington, KY, 40550 USA. The authorized representative is: Lexmark International Technology Hungária Kft., 8 Lechner Ödön fasor, Millennium Tower III, 1095 Budapest HUNGARY. A declaration of conformity to the requirements of the Directives is available upon request from the Authorized Representative.

This product satisfies the Class A limits of EN 55022 and safety requirements of EN 60950-1.

Refer to the table at the end of the Notices section for further compliance information.

## Regulatory notices for wireless products

This section contains the following regulatory information pertaining to wireless products that contain transmitters, for example, but not limited to, wireless network cards or proximity card readers.

## Modular component notice

This product may contain the following modular component(s):

Lexmark Regulatory Type/Model LEX-M01-005; FCC ID:IYLLEXM01005; IC:2376A-M01005

## Exposure to radio frequency radiation

The radiated output power of this device is far below the radio frequency exposure limits of the FCC and other regulatory agencies. A minimum separation of 20 cm (8 inches) must be maintained between the antenna and any persons for this device to satisfy the RF exposure requirements of the FCC and other regulatory agencies.

## Industry Canada (Canada)

Under Industry Canada regulations, this radio transmitter may only operate using an antenna of a type and maximum (or lesser) gain approved for the transmitter by Industry Canada. To reduce potential radio interference to other users, the antenna type and its gain should be so chosen that the equivalent isotropically radiated power (EIRP) is not more than that necessary for successful communication.

This device complies with Industry Canada license-exempt RSS standards. Operation is subject to the following two conditions: (1) this device may not cause interference, and (2) this device must accept any interference, including interference that may cause undesired operation of the device.

To prevent radio interference to the licensed service, this device is intended to be operated indoors and away from windows to provide maximum shielding.

## Industrie Canada (Canada)

Selon la réglementation d'Industrie Canada, l'émetteur radio ne fonctionner qu'avec une antenne dont le type et le gain maximal (ou inférieur) ont été approuvés par Industrie Canada. Pour réduire les interférences radio potentielles auprès d'autres utilisateurs, le type d'antenne et son gain doivent être choisis de telle sorte que la puissance isotrope rayonnée équivalente (PIRE) ne soit pas supérieure à ce qui est nécessaire pour assurer la réussite de la communication.

Cet appareil est conforme aux normes RSS exemptes de licence d'Industrie Canada. Son fonctionnement est soumis aux deux conditions suivantes : (1) cet appareil ne doit pas causer d'interférences et (2) il doit accepter toutes les interférences, y compris les interférences pouvant entraîner un fonctionnement indésirable.

Pour éviter toute interférence radio au service sous licence, cet appareil est destiné à être utilisé à l'intérieur et à l'écart des fenêtres afin d'assurer une protection maximale.

## Notice to users in the European Union

Products bearing the CE mark are in conformity with the protection requirements of EC Council directives 2004/108/EC, 2006/95/EC, 1999/5/EC, and 2011/65/EU on the approximation and harmonization of the laws of the Member States relating to electromagnetic compatibility, safety of electrical equipment designed for use within certain voltage limits, radio equipment and telecommunications terminal equipment, and on the restrictions of use of certain hazardous substances in electrical and electronic equipment.

Compliance is indicated by the CE marking.



The manufacturer of this product is: Lexmark International, Inc., 740 West New Circle Road, Lexington, KY, 40550 USA. The authorized representative is: Lexmark International Technology Hungária Kft., 8 Lechner Ödön fasor, Millennium Tower III, 1095 Budapest HUNGARY, A declaration of conformity to the requirements of the Directives is available upon request from the Authorized Representative.

This product satisfies the Class A limits of EN 55022 and safety requirements of EN 60950-1.

Products equipped with 2.4GHz Wireless LAN option are in conformity with the protection requirements of EC Council directives 2004/108/EC, 2006/95/EC, and 1999/5/EC on the approximation and harmonization of the laws of the Member States relating to electromagnetic compatibility, safety of electrical equipment designed for use within certain voltage limits and on radio equipment and telecommunications terminal equipment.

Compliance is indicated by the CE marking.



Operation is allowed in all EU and EFTA countries, but is restricted to indoor use only.

The manufacturer of this product is: Lexmark International, Inc., 740 West New Circle Road, Lexington, KY, 40550 USA. The authorized representative is: Lexmark International Technology Hungária Kft., 8 Lechner Ödön fasor, Millennium Tower III, 1095 Budapest HUNGARY, A declaration of conformity to the requirements of the Directives is available upon request from the Authorized Representative.

This product may be used in the countries indicated in the table below.

AT	BE	BG	CH	CY	CZ	DE	DK	EE
EL	ES	FI	FR	HR	HU	IE	IS	IT
LI	LT	LU	LV	MT	NL	NO	PL	PT
RO	SE	SI	SK	TR	UK			

Česky	Společnost Lexmark International, Inc. tímto prohlašuje, že výrobek tento výrobek je ve shodě se základními požadavky a dalšími příslušnými ustanoveními směrnice 1999/5/ES.
Dansk	Lexmark International, Inc. erklærer herved, at dette produkt overholder de væsentlige krav og øvrige relevante krav i direktiv 1999/5/EF.
Deutsch	Hiermit erklärt Lexmark International, Inc., dass sich das Gerät dieses Gerät in Übereinstimmung mit den grundlegenden Anforderungen und den übrigen einschlägigen Bestimmungen der Richtlinie 1999/5/EG befindet.
Ελληνική	ΜΕ ΤΗΝ ΠΑΡΟΥΣΑ Η LEXMARK INTERNATIONAL, INC. ΔΗΛΩΝΕΙ ΟΤΙ ΑΥΤΟ ΤΟ ΠΡΟΪΟΝ ΣΥΜΜΟΡΦΩΝΕΤΑΙ ΠΡΟΣ ΤΙΣ ΟΥΣΙΩΔΕΙΣ ΑΠΑΙΤΗΣΕΙΣ ΚΑΙ ΤΙΣ ΛΟΙΠΕΣ ΣΧΕΤΙΚΕΣ ΔΙΑΤΑΞΕΙΣ ΤΗΣ ΟΔΗΓΙΑΣ 1999/5/ΕΚ.
English	Hereby, Lexmark International, Inc., declares that this type of equipment is in compliance with the essential requirements and other relevant provisions of Directive 1999/5/EC.
Español	Por medio de la presente, Lexmark International, Inc. declara que este producto cumple con los requisitos esenciales y cualesquiera otras disposiciones aplicables o exigibles de la Directiva 1999/5/CE.
Eesti	Käesolevaga kinnitab Lexmark International, Inc., et seade see toode vastab direktiivi 1999/5/EÜ põhinõuetele ja nimetatud direktiivist tulenevatele muudele asjakohastele sätetele.
Suomi	Lexmark International, Inc. vakuuttaa täten, että tämä tuote on direktiivin 1999/5/EY oleellisten vaatimusten ja muiden sitä koskevien direktiivin ehtojen mukainen.
Français	Par la présente, Lexmark International, Inc. déclare que l'appareil ce produit est conforme aux exigences fondamentales et autres dispositions pertinentes de la directive 1999/5/CE.
Magyar	Alulírott, Lexmark International, Inc. nyilatkozom, hogy a termék megfelel a vonatkozó alapvető követelményeknek és az 1999/5/EC irányelv egyéb előírásainak.
Íslenska	Hér með lýsir Lexmark International, Inc. yfir því að þessi vara er í samræmi við grunnkröfur og aðrar kröfur, sem gerðar eru í tilskipun 1999/5/EC.
Italiano	Con la presente Lexmark International, Inc. dichiara che questo questo prodotto è conforme ai requisiti essenziali ed alle altre disposizioni pertinenti stabilite dalla direttiva 1999/5/CE.
Latviski	Ar šo Lexmark International, Inc. deklarē, ka šis izstrādājums atbilst Direktīvas 1999/5/EK būtiskajām prasībām un citiem ar to saistītajiem noteikumiem.
Lietuvių	Šiuo Lexmark International, Inc. deklaruoja, kad šis produktas atitinka esminius reikalavimus ir kitas 1999/5/EB direktyvos nuostatas.
Malti	Bil-preżenti, Lexmark International, Inc., jiddikjara li dan il-prodott huwa konformi mal-ftigijiet essenzjali u ma dispożizzjonijiet oħrajn relevanti li jinsabu fid-Direttiva 1999/5/KE.
Nederlands	Hierbij verklaart Lexmark International, Inc. dat het toestel dit product in overeenstemming is met de essentiële eisen en de andere relevante bepalingen van richtlijn 1999/5/EG.
Norsk	Lexmark International, Inc. erklærer herved at dette produktet er i samsvar med de grunnleggende krav og øvrige relevante krav i direktiv 1999/5/EF.

Polski	Niniejszym Lexmark International, Inc. oświadcza, że niniejszy produkt jest zgodny z zasadniczymi wymogami oraz pozostałymi stosownymi postanowieniami Dyrektywy 1999/5/EC.
Português	A Lexmark International Inc. declara que este produto está conforme com os requisitos essenciais e outras disposições da Diretiva 1999/5/CE.
Slovensky	Lexmark International, Inc. týmto vyhlasuje, že tento produkt spĺňa základné požiadavky a všetky príslušné ustanovenia smernice 1999/5/ES.
Slovensko	Lexmark International, Inc. izjavlja, da je ta izdelek v skladu z bistvenimi zahtevami in ostalimi relevantnimi določili direktive 1999/5/ES.
Svenska	Härmed intygar Lexmark International, Inc. att denna produkt står i överensstämmelse med de väsentliga egenskapskrav och övriga relevanta bestämmelser som framgår av direktiv 1999/5/EG.

## STATEMENT OF LIMITED WARRANTY FOR LEXMARK LASER PRINTERS, LEXMARK LED PRINTERS, AND LEXMARK MULTIFUNCTION LASER PRINTERS

### Lexmark International, Inc., Lexington, KY

This limited warranty applies to the United States and Canada. For customers outside the U.S., refer to the country-specific warranty information that came with your product.

This limited warranty applies to this product only if it was originally purchased for your use, and not for resale, from Lexmark or a Lexmark Remarketer, referred to in this statement as “Remarketer.”

### Limited warranty

Lexmark warrants that this product:

- Is manufactured from new parts, or new and serviceable used parts, which perform like new parts
- Is, during normal use, free from defects in material and workmanship

If this product does not function as warranted during the warranty period, contact a Remarketer or Lexmark for repair or replacement (at Lexmark's option).

If this product is a feature or option, this statement applies only when that feature or option is used with the product for which it was intended. To obtain warranty service, you may be required to present the feature or option with the product.

If you transfer this product to another user, warranty service under the terms of this statement is available to that user for the remainder of the warranty period. You should transfer proof of original purchase and this statement to that user.

### Limited warranty service

The warranty period starts on the date of original purchase as shown on the purchase receipt and ends 12 months later provided that the warranty period for any supplies and for any maintenance items included with the printer shall end earlier if it, or its original contents, are substantially used up, depleted, or consumed. Fuser Units, Transfer/Transport Units, Paper Feed items, if any, and any other items for which a Maintenance Kit is available are substantially consumed when the printer displays a “Life Warning” or “Scheduled Maintenance” message for such item.

To obtain warranty service you may be required to present proof of original purchase. You may be required to deliver your product to the Remarketer or Lexmark, or ship it prepaid and suitably packaged to a Lexmark designated location. You are responsible for loss of, or damage to, a product in transit to the Remarketer or the Lexmark designated location.

When warranty service involves the exchange of a product or part, the item replaced becomes the property of the Remarketer or Lexmark. The replacement may be a new or repaired item.

The replacement item assumes the remaining warranty period of the original product.

Replacement is not available to you if the product you present for exchange is defaced, altered, in need of a repair not included in warranty service, damaged beyond repair, or if the product is not free of all legal obligations, restrictions, liens, and encumbrances.

As part of your warranty service and/or replacement, Lexmark may update the firmware in your printer to the latest version. Firmware updates may modify printer settings and cause counterfeit and/or unauthorized products, supplies, parts, materials (such as toners and inks), software, or interfaces to stop working. Authorized use of genuine Lexmark products will not be impacted.

Before you present this product for warranty service, remove all print cartridges, programs, data, and removable storage media (unless directed otherwise by Lexmark).

For further explanation of your warranty alternatives and the nearest Lexmark authorized servicer in your area contact Lexmark on the World Wide Web.

Remote technical support is provided for this product throughout its warranty period. For products no longer covered by a Lexmark warranty, technical support may not be available or only be available for a fee.

### **Extent of limited warranty**

Lexmark does not warrant uninterrupted or error-free operation of any product or the durability or longevity of prints produced by any product.

Warranty service does not include repair of failures caused by:

- Modification or unauthorized attachments
- Accidents, misuse, abuse or use inconsistent with Lexmark user's guides, manuals, instructions or guidance
- Unsuitable physical or operating environment
- Maintenance by anyone other than Lexmark or a Lexmark authorized servicer
- Operation of a product beyond the limit of its duty cycle
- Use of printing media outside of Lexmark specifications
- Refurbishment, repair, refilling or remanufacture by a third party of products, supplies or parts
- Products, supplies, parts, materials (such as toners and inks), software, or interfaces not furnished by Lexmark

**TO THE EXTENT PERMITTED BY APPLICABLE LAW, NEITHER LEXMARK NOR ITS THIRD PARTY SUPPLIERS OR REMARKETERS MAKE ANY OTHER WARRANTY OR CONDITION OF ANY KIND, WHETHER EXPRESS OR IMPLIED, WITH RESPECT TO THIS PRODUCT, AND SPECIFICALLY DISCLAIM THE IMPLIED WARRANTIES OR CONDITIONS OF MERCHANTABILITY, FITNESS FOR A PARTICULAR PURPOSE, AND SATISFACTORY QUALITY. ANY WARRANTIES THAT MAY NOT BE DISCLAIMED UNDER APPLICABLE LAW ARE LIMITED IN DURATION TO THE WARRANTY PERIOD. NO WARRANTIES, EXPRESS OR IMPLIED, WILL APPLY AFTER THIS PERIOD. ALL INFORMATION, SPECIFICATIONS, PRICES, AND SERVICES ARE SUBJECT TO CHANGE AT ANY TIME WITHOUT NOTICE.**

## Limitation of liability

Your sole remedy under this limited warranty is set forth in this document. For any claim concerning performance or nonperformance of Lexmark or a Remarketer for this product under this limited warranty, you may recover actual damages up to the limit set forth in the following paragraph.

Lexmark's liability for actual damages from any cause whatsoever will be limited to the amount you paid for the product that caused the damages. This limitation of liability will not apply to claims by you for bodily injury or damage to real property or tangible personal property for which Lexmark is legally liable. **IN NO EVENT WILL LEXMARK BE LIABLE FOR ANY LOST PROFITS, LOST SAVINGS, INCIDENTAL DAMAGE, OR OTHER ECONOMIC OR CONSEQUENTIAL DAMAGES.** This is true even if you advise Lexmark or a Remarketer of the possibility of such damages. Lexmark is not liable for any claim by you based on a third party claim.

This limitation of remedies also applies to claims against any Suppliers and Remarketers of Lexmark. Lexmark's and its Suppliers' and Remarketers' limitations of remedies are not cumulative. Such Suppliers and Remarketers are intended beneficiaries of this limitation.

## Additional rights

Some states do not allow limitations on how long an implied warranty lasts, or do not allow the exclusion or limitation of incidental or consequential damages, so the limitations or exclusions contained above may not apply to you.

This limited warranty gives you specific legal rights. You may also have other rights that vary from state to state.

## Patent acknowledgment

The use of this product or service is subject to the reasonable, non-discriminatory terms in the Intellectual Property Rights (IPR) Disclosure of Certicom Corp. at the IETF for Elliptic Curve Cryptography (ECC) Cipher Suites for Transport Layer Security (TLS) implemented in the product or service.

The use of this product or service is subject to the reasonable, non-discriminatory terms in the Intellectual Property Rights (IPR) Disclosure of Certicom Corp. at the IETF for TLS Elliptic Curve Cipher Suites with SHA-256/382 and AES Galois Counter Mode (GCM) implemented in the product or service.

The use of this product or service is subject to the reasonable, non-discriminatory terms in the Intellectual Property Rights (IPR) Disclosure of Certicom Corp. at the IETF for TLS Suite B Profile for Transport Layer Security (TLS) implemented in the product or service.

The use of this product or service is subject to the reasonable, non-discriminatory terms in the Intellectual Property Rights (IPR) Disclosure of Certicom Corp. at the IETF for Addition of the Camellia Cipher Suites to Transport Layer Security (TLS) implemented in the product or service.

The use of certain patents in this product or service is subject to the reasonable, non-discriminatory terms in the Intellectual Property Rights (IPR) Disclosure of Certicom Corp. at the IETF for AES-CCM ECC Cipher Suites for TLS implemented in the product or service.

The use of this product or service is subject to the reasonable, non-discriminatory terms in the Intellectual Property Rights (IPR) Disclosure of Certicom Corp. at the IETF for IKE and IKEv2 Authentication Using the Elliptic Curve Digital Signature Algorithm (ECDSA) implemented in the product or service.

The use of this product or service is subject to the reasonable, non-discriminatory terms in the Intellectual Property Rights (IPR) Disclosure of Certicom Corp. at the IETF for Suite B Cryptographic Suites for IPsec implemented in the product or service.

The use of this product or service is subject to the reasonable, non-discriminatory terms in the Intellectual Property Rights (IPR) Disclosure of Certicom Corp. at the IETF for Algorithms for Internet Key Exchange version 1 (IKEv1) implemented in the product or service.



# Index

## Numerics

300K maintenance kit  
ordering 212

## Symbols

[x] maintenance kit very low  
[80.xy] 278  
[x]-page jam, clear manual feeder.  
[200.xx] 245  
[x]-page jam, detach the  
3000-sheet tray and open door F.  
[24y.xx] 252  
[x]-page jam, open door C and clear  
all jammed media. [2yy.xx] 245  
[x]-page jam, open door D and clear  
all jammed media. [24y.xx] 249  
[x]-page jam, open door H and  
rotate knob H6 clockwise. Leave  
paper in bin. [426.xx–428.xx] 264  
[x]-page jam, open doors G, H, and J  
and clear jammed paper. Leave  
paper in bin. [400–402] 255  
[x]-page jam, press latch at area E  
to open ADF's top cover. [28y.xx]  
printer messages 269  
[x]-page jam, press latch to access  
area G and clear jammed  
staples. Leave paper in bin.  
[402.93] 261  
[x]-page jam, press latch to access  
area G. Leave paper in bin.  
[40y.xx] 258  
[x]-page jam, slide the 3000-sheet  
tray and open door C. [2yy.xx] 247  
[x]-page jam, slide the 3000-sheet  
tray and open door D. [24y.xx] 251

## A

accessing the controller board 27  
accessing the Embedded Web  
Server 20  
Active NIC menu 129  
adapter plug 99  
adding hardware options  
print driver 45  
ADF scan pad  
replacing 235

adjusting copy quality 79  
adjusting printer display  
brightness 200  
adjusting Sleep mode 200  
adjusting toner darkness 71  
advanced options, touch-screen  
copy 83  
e-mail 88  
fax 111  
FTP 116  
answering machine  
setting up 91  
AppleTalk menu 134  
applications  
home screen 22  
understanding 21  
attaching cables 44  
automatic document feeder (ADF)  
using 14  
available internal options 27  
avoiding jams 63  
avoiding paper jams 242

## B

Bin Setup menu 126  
blocking junk faxes 108  
buttons, control panel 15  
buttons, touch screen  
using 18

## C

cables  
Ethernet 44  
USB 44  
canceling a fax job 109  
canceling a print job  
from a computer 75  
from the printer control panel 75  
canceling an e-mail 86  
cannot open Embedded Web  
Server 333  
Card Copy  
setting up 23  
card stock  
tips 58  
Cartridge low [88.xy] 271  
Cartridge nearly low [88.xy] 271  
Cartridge very low [88.xy] 271

Change [paper source] to [custom  
string] load [orientation] 271  
Change [paper source] to [custom  
type name] load [orientation] 271  
Change [paper source] to [paper  
size] load [orientation] 271  
Change [paper source] to [paper  
type] [paper size] load  
[orientation] 272  
changing output file type  
e-mailing 86  
charger  
cleaning 206  
checking an unresponsive  
printer 287  
checking status of parts and  
supplies 210  
checking the status of parts and  
supplies 210  
checking the virtual display  
using the Embedded Web  
Server 239  
checking virtual display  
using the Embedded Web  
Server 239  
cleaning  
exterior of the printer 205  
scanner glass 205  
cleaning the charger 206  
cleaning the printer 205  
cleaning the printhead lens 206  
Close door [x] 272  
collate  
copy options 82  
collating copies  
copying 79  
Complex page, some data may not  
have printed [39] 272  
confidential data  
information on securing 204  
confidential jobs  
modifying print settings 74  
confidential print jobs 73  
printing from a Macintosh  
computer 73  
printing from Windows 73  
Confidential Print menu 143

- Configuration change, some held jobs were not restored [57] 272
  - configuration information
    - wireless network 46
  - Configure MP menu 121
  - configuring
    - multiple printers 240
  - configuring e-mail settings 84
  - configuring port settings 49
  - configuring supply notifications 240
  - connecting printer to distinctive ring service 104
  - connecting the printer to an outlet 10
  - connecting to a wireless network
    - using PIN (Personal Identification Number) method 48
    - using Push Button Configuration method 48
    - using the Embedded Web Server 49
    - using wireless setup wizard 47
  - conservation settings
    - brightness, adjusting 200
    - conserving supplies 198
    - Eco-Mode 199
    - Hibernate mode 199
    - Sleep Mode 200
  - conserving supplies 198
  - contacting customer support 334
  - content
    - e-mail settings 87
  - content source
    - e-mail settings 87
    - fax options 111
  - content type
    - e-mail settings 87
    - fax options 111
  - control panel 15
    - factory defaults, restoring 241
  - control panel, printer
    - indicator light 15
    - Sleep button light 15
  - controller board
    - accessing 27
  - copies
    - copy options 82
  - copy options
    - collate 82
    - copies 82
    - darkness 82
    - Save As Shortcut 82
    - sides (duplex) 82
  - copy quality
    - adjusting 79
  - copy screen
    - advanced options 83
    - content source 82
    - content type 82
    - options 81, 82
  - Copy Settings menu 157
  - copy troubleshooting
    - copier does not respond 320
    - partial document or photo copies 320
    - poor copy quality 321
    - poor scanned image quality 329
    - scanner unit does not close 331
  - copying
    - canceling a copy job 81
    - creating shortcuts using the printer control panel 77
    - on both sides of the paper (two-sided) 79
  - copying different paper sizes 78
  - copying from
    - selected tray 78
  - copying multiple pages on one sheet 80
  - copying on both sides of the paper (two-sided) 79
  - copying on letterhead 77
  - copying on transparencies 77
  - copying photos 76
  - copying to a different size 78
- creating a fax destination shortcut
    - using the Embedded Web Server 107
  - creating an e-mail shortcut
    - using the control panel 85
  - creating an FTP shortcut
    - using the Embedded Web Server 112
  - Custom Bin Names menu 125
  - custom job
    - copying 80
  - Custom Names menu 125
  - custom paper type
    - assigning 57
  - custom paper type name
    - creating 57
  - Custom Scan Sizes menu 125
  - Custom Types menu 125
- customer support
    - contacting 334
- ## D
- darkness
    - copy options 82
    - e-mail options 87
    - fax options 110
    - scan options 115
  - date and time, fax
    - setting 104
  - daylight saving time, faxing 105
  - Default Source menu 118
  - Defective flash detected [51] 272
  - delayed send
    - fax options 111
  - device and network settings information
    - erasing 203
  - different paper sizes, copying 78
  - different size
    - copying to 78
  - Digital Subscriber Line (DSL)
    - fax setup 95
  - digital telephone service
    - fax setup 98
  - directory list
    - printing 75
  - Disk full [62] 273
  - Disk full, scan job canceled 273
  - Disk must be formatted for use in this device 273
  - display troubleshooting
    - printer display is blank 289
  - display, control panel 15
  - display, printer control panel
    - adjusting brightness 200
  - disposing of printer hard disk 202
  - distinctive ring service, fax
    - connecting to 104
  - documents, printing
    - from Macintosh 70
    - from Windows 70
  - door C
    - paper jams, clearing 245, 247
  - door D
    - paper jams, clearing 249, 251
  - DSL filter 95
- ## E
- Eco-Mode setting 199

- Edit Security Setups menu 141
- embedded solutions information
  - erasing 203
- Embedded Web Server
  - accessing 20
  - adjusting brightness 200
  - checking the status of parts 210
  - checking the status of supplies 210
  - copying settings to other printers 240
  - creating a fax destination shortcut 107
  - creating an FTP shortcut 112
  - creating e-mail shortcuts 85
  - initial fax setup 90
  - modifying confidential print settings 74
  - problem accessing 333
  - setting up e-mail alerts 239
- Embedded Web Server—Security: Administrator's Guide
  - where to find 204
- emission
- notices 337, 341, 342, 346, 347
- Empty the hole punch box 273
- emptying the hole punch box 209
- encrypting the printer hard disk 204
- enlarging a copy 79
- envelopes
  - tips on using 58
- environmental settings
  - conserving supplies 198
  - Eco-Mode 199
  - Hibernate mode 199
  - printer display brightness, adjusting 200
  - Sleep Mode 200
- Erase Temporary Data Files menu 144
- erasing hard disk memory 203
- erasing non-volatile memory 203
- erasing volatile memory 203
- Error reading USB drive. Remove USB. 273
- Error reading USB hub. Remove hub. 273
- Ethernet network
  - preparing to set up for Ethernet printing 46
- Ethernet port 44
- Ethernet setup
  - preparing for an 46
- exhaust filter
  - replacing 225
- exporting a configuration using the Embedded Web Server 26
- EXT port 44
- exterior of the printer
  - cleaning 205
- e-mail
  - canceling 86
- e-mail alerts
  - low supply levels 239
  - paper jam 239
  - setting up 239
- e-mail options
  - darkness 87
  - message 87
  - original size 87
  - page setup 88
  - recipient(s) 86
  - resolution 87
  - Save As Shortcut 87
  - Send As 87
  - subject 86
- e-mail screen
  - advanced options 88
  - options 87, 88
- E-mail Settings menu 170
- e-mail shortcut, creating using the control panel 85
- e-mail shortcuts, creating using the Embedded Web Server 85
- e-mail, sending
  - using a shortcut number 86
- e-mailing
  - configuring e-mail settings 84
  - creating shortcuts using the Embedded Web Server 85
  - using a shortcut number 86
  - using the address book 86
- e-mailing a document
  - using the control panel 85
- F**
- factory defaults
  - restoring 241
- fax
  - sending at a scheduled time 106
- fax and e-mail functions
  - setting up 326
- fax and e-mail functions are not set up 326
- fax job
  - canceling 109
- Fax memory full 274
- Fax Mode (Analog Fax Setup) menu 162
- fax name, setting 104
- fax number, setting 104
- fax options
  - content source 111
  - content type 111
  - darkness 110
  - delayed send 111
  - page setup 111
  - resolution 110
  - scan preview 111
- Fax partition inoperative. Contact system administrator. 274
- fax port 44
- fax screen
  - advanced options 111
  - options 111
- Fax server 'To Format' not set up. Contact system administrator. 274
- fax setup
  - country- or region-specific 99
  - digital telephone service 98
  - DSL connection 95
  - standard telephone line connection 91
  - VoIP 96
- Fax Station Name not set up. Contact system administrator. 274
- Fax Station Number not set up. Contact system administrator. 274
- fax troubleshooting
  - caller ID is not shown 322
  - can receive but not send faxes 325
  - can send but not receive faxes 326
  - cannot send or receive a fax 323
  - received fax has poor print quality 327
- faxing
  - blocking junk faxes 108
  - changing resolution 108
  - configuring the printer to observe daylight saving time 105

- creating shortcuts using the Embedded Web Server 107
  - creating shortcuts using the printer control panel 107
  - distinctive ring service 104
  - fax setup 90
  - forwarding faxes 110
  - holding faxes 109
  - making a fax lighter or darker 108
  - sending a fax at a scheduled time 106
  - setting the date and time 104
  - setting the fax number 104
  - setting the outgoing fax name 104
  - viewing a fax log 108
  - FCC notices 337, 342, 346
  - feet
    - stabilizing 38
  - file name
    - scan options 115
  - finding more information about the printer 9
  - finding printer IP address 20
  - finisher
    - supported paper sizes 67
    - supported paper types 67
    - supported paper weights 67
  - Finishing menu 186
  - firmware card 27
  - flash drive
    - printing from 71
    - scanning 114
  - Flash Drive menu 179
  - flash drives
    - supported file types 72
  - font sample list
    - printing 74
  - Forms and Favorites
    - setting up 22
  - forwarding faxes 110
  - FTP
    - FTP options 115
  - FTP address
    - creating shortcuts using the printer control panel 113
  - FTP address, scanning to using the control panel 113
  - FTP options
    - FTP 115
  - FTP screen
    - advanced options 116
  - FTP Settings menu 175
- G**
- General Settings menu 148
  - green settings
    - Eco-Mode 199
    - Hibernate mode 199
- H**
- hardware options, adding
    - print driver 45
  - held jobs 73
    - printing from a Macintosh computer 73
    - printing from Windows 73
  - Help menu 196
  - Hibernate mode
    - using 199
  - hiding icons on the home screen 21
  - holding faxes 109
  - hole punch 82
  - hole punch box
    - emptying 209
  - home screen
    - customizing 21
    - hiding icons 21
    - showing icons 21
  - home screen applications
    - configuring 22
    - finding information 22
  - home screen buttons and icons
    - description 16
  - HTML menu 195
- I**
- icons on the home screen
    - hiding 21
    - showing 21
  - Image menu 196
  - importing a configuration using the Embedded Web Server 26
  - Incorrect paper size, open [paper source] [34] 274
  - indicator light 15
  - individual settings information
    - erasing 203
  - initial fax setup 90
    - using the Embedded Web Server 90
  - Insert hole punch box 275
  - Insert Tray [x] 275
- inserting a header or footer
    - copying 81
  - installing a memory card 30
  - installing an optional card 31
  - installing hardware options
    - order of installation 38
  - installing printer 45
  - installing the optional trays 38
  - Insufficient memory for Flash Memory Defragment operation [37] 275
  - Insufficient memory to collate job [37] 275
  - Insufficient memory to support Resource Save feature [35] 275
  - Insufficient memory, some Held Jobs were deleted [37] 275
  - Insufficient memory, some held jobs will not be restored [37] 275
  - Insufficient space between paper stacks in Tray 3 275
  - internal options 27
  - internal print server
    - troubleshooting 290
  - Internal Solutions Port
    - changing port settings 49
    - troubleshooting 290
  - Internal Solutions Port (ISP)
    - installing 32
  - IP address of computer
    - finding 20
  - IP address, printer
    - finding 20
  - IPv6 menu 132
- J**
- jams
    - avoiding 242
    - locating jam areas 243
    - locations 243
    - numbers 243
  - jams, clearing
    - in 3000-sheet tray 252
    - in door C 252
    - in door F 252
    - in multipurpose feeder 245
    - in top ADF door 269
  - Job Accounting menu 189

**L**

- labels, paper
  - tips 59
- letterhead
  - copying on 77
  - loading, multipurpose feeder 59
  - loading, trays 59
- line filter 95
- LINE port 44
- linking trays 56, 57
- Load [paper source] with [custom string] [paper orientation] 276
- Load [paper source] with [custom type name] [paper orientation] 276
- Load [paper source] with [paper size] [paper orientation] 276
- Load [paper source] with [paper type] [paper size] [paper orientation] 276
- Load Multipurpose Feeder with [custom string] [paper orientation] 276
- Load Multipurpose Feeder with [custom type name] [paper orientation] 277
- Load Multipurpose Feeder with [paper size] [paper orientation] 277
- Load Multipurpose Feeder with [paper type] [paper size] [paper orientation] 277
- Load staples 277
- Load staples [G11, G12] 278
- loading letterhead
  - paper orientation 59
- loading the multipurpose feeder 53
- loading trays 51
- lock, security 202

**M**

- maintenance counter,
  - resetting 234
- making copies using paper from selected tray 78
- memory
  - types installed on printer 202
- memory card 27
  - installing 30
- Memory full [38] 278
- Memory full, cannot print
  - faxes 278

- Memory full, cannot send
  - faxes 278
- menu settings
  - loading on multiple printers 240
- menu settings page
  - printing 50
- menus
  - Active NIC 129
  - AppleTalk 134
  - Bin Setup 126
  - Confidential Print 143
  - Configure MP 121
  - Copy Settings 157
  - Custom Bin Names 125
  - Custom Names 125
  - Custom Scan Sizes 125
  - Custom Types 125
  - Default Source 118
  - diagram of 117
  - Edit Security Setups 141
  - Erase Temporary Data Files 144
  - E-mail Settings 170
  - Fax Mode (Analog Fax Setup) 162
  - Finishing 186
  - Flash Drive 179
  - FTP Settings 175
  - General Settings 148
  - Help 196
  - HTML 195
  - Image 196
  - IPv6 132
  - Job Accounting 189
  - Miscellaneous Security Settings 142
  - Network [x] 129
  - Network Card 131
  - Network Reports 130
  - Paper Loading 123
  - Paper Size/Type 118
  - Paper Texture 122
  - Parallel [x] 136
  - PCL Emul 192
  - PDF 191
  - PostScript 192
  - Quality 188
  - Reports 128
  - Security Audit Log 145
  - Serial [x] 138
  - Set Date and Time 146
  - Setup 184
  - SMTP Setup 140
  - Standard Network 129

- Standard USB 134
- Substitute Size 122
- TCP/IP 131
- Universal Setup 126
- Utilities 190
- Wireless 133
- XPS 191
- menus diagram 117
- message
  - e-mail options 87
- Miscellaneous Security Settings menu 142
- mobile device
  - printing from 72
- moving the printer 10, 237
- Multi Send
  - adding a profile 24
  - setting up 24
- multipurpose feeder
  - loading 53
- MyShortcut
  - about 23

**N**

- Network [x] menu 129
- Network [x] software error [54] 278
- Network Card menu 131
- Network Reports menu 130
- network setup page
  - printing 50
- No analog phone line connected to modem, fax is disabled. 278
- noise emission levels 337
- non-volatile memory 202
  - erasing 203
- Not enough free space in flash memory for resources [52] 279
- notices 336, 337, 338, 339, 340, 341, 342, 343, 344, 345, 346, 347
- number of remaining pages
  - estimate 210

**O**

- Open door H and remove paper from beneath area H10 279
- optional 2 x 500-sheet tray
  - installing 38
- optional 2500-sheet tray
  - installing 38

- optional card
  - installing 31
- optional trays
  - installing 38
- options
  - firmware cards 27
  - Internal Solutions Port (ISP) 32
  - memory card 27, 30
  - printer hard disk, removing 36
- options, copy screen
  - copy from 81
  - scale 82
- options, touch-screen
  - copy 81
  - e-mail 87, 88
  - fax 111
- ordering
  - 300K maintenance kit 212
  - photoconductor unit 211
  - staple cartridges 212
- ordering supplies
  - toner cartridge 211
  - waste toner bottle 211
- organizing cables 44
- original size
  - e-mail options 87
  - scan options 115
- output file type
  - changing 86
  - scan image 115
- ozone filter
  - replacing 225
- P**
- page setup
  - e-mail options 88
  - fax options 111
  - scan options 116
- paper
  - characteristics 60
  - different sizes, copying 78
  - letterhead 61
  - preprinted forms 61
  - recycled 61
  - saving 80
  - selecting 61
  - storing 60, 63
  - unacceptable 61
  - using recycled 198
- Paper changes needed 279
- paper characteristics 60
  - paper feed troubleshooting
    - message remains after jam is cleared 293
  - paper jams
    - avoiding 242
  - paper jams, clearing
    - door C 245, 247
    - door D 249, 251
    - in 3000-sheet tray 252
    - in bottom ADF door 269
    - in door C 252
    - in door F 252
    - in multipurpose feeder 245
  - Paper Loading menu 123
  - paper size
    - setting 51
  - Paper Size/Type menu 118
  - paper sizes
    - supported 63
  - Paper Texture menu 122
  - paper type
    - setting 51
  - paper types
    - supported by printer 66
  - paper weights
    - supported by printer 66
  - Parallel [x] menu 136
  - Parallel port [x] disabled [56] 279
  - parts
    - checking status 210
    - checking, from printer control panel 210
    - checking, using the Embedded Web Server 210
    - storing 212
    - using genuine Lexmark 211
  - parts, ordering
    - 300K maintenance kit 212
  - PCL Emul menu 192
  - PDF menu 191
  - Personal Identification Number method
    - using 48
  - phone splitter 96
  - Photoconductor low [84.xy] 279
  - photoconductor unit
    - ordering 211
    - replacing 213
  - Photoconductor very low [84.xy] 279
  - photos
    - copying 76
  - placing separator sheets between copies
    - copying 80
  - port settings
    - configuring 49
  - PostScript menu 192
  - power cord socket 44
  - power switch
    - printer 227
  - preparing to set up the printer on an Ethernet network 46
  - print driver
    - hardware options, adding 45
  - print irregularities 307
  - print job
    - canceling, from computer 75
  - print quality
    - cleaning the scanner glass 205
    - replacing a photoconductor unit 213
  - print quality troubleshooting
    - blank pages 306
    - characters have jagged edges 301
    - clipped pages or images 301
    - gray background on prints 303
    - horizontal voids appear on prints 303
    - print irregularities 307
    - print is too dark 309
    - print is too light 310
    - printer is printing solid black pages 307
    - repeating defects appear on prints 311
    - shadow images appear on prints 312
    - skewed print 313
    - streaked horizontal lines appear on prints 314
    - streaked vertical lines 315
    - toner fog or background shading appears on prints 316
    - toner rubs off 317
    - toner specks appear on prints 317
    - transparency print quality is poor 318
    - uneven print density 318
    - white streaks 318
  - print quality, troubleshooting
    - cleaning the charger 206
    - cleaning the printhead lens 206

- print troubleshooting
  - envelope seals when printing 295
  - error reading flash drive 295
  - held jobs do not print 294
  - incorrect characters print 296
  - incorrect margins on prints 304
  - jammed pages are not reprinted 292
  - job prints from wrong tray 296
  - job prints on wrong paper 296
  - jobs do not print 299
  - Large jobs do not collate 297
  - multiple-language PDF files do not print 297
  - paper curl 305
  - paper frequently jams 293
  - print job takes longer than expected 298
  - tray linking does not work 300
  - unexpected page breaks occur 300
- printer 45
  - basic model 11
  - connecting to an outlet 10
  - fully configured 11
  - minimum clearances 10
  - moving 10, 237
  - selecting a location 10
  - shipping 238
- printer configurations 11
- printer control panel
  - adjusting brightness 200
  - indicator light 15
  - Sleep button light 15
- Printer had to restart. Last job may be incomplete. 280
- printer hard disk
  - disposing of 202
  - encrypting 204
  - removing 36
- printer hard disk encryption 204
- printer hard disk memory
  - erasing 203
- printer information
  - where to find 9
- printer IP address
  - finding 20
- printer is printing blank pages 306
- printer messages
  - [x] maintenance kit very low [80.xy] 278
  - [x]-page jam, clear manual feeder. [200.xx] 245
  - [x]-page jam, detach the 3000-sheet tray and open door F. [24y.xx] 252
  - [x]-page jam, open door C and clear all jammed media. [2yy.xx] 245
  - [x]-page jam, open door D and clear all jammed media. [24y.xx] 249
  - [x]-page jam, open door H and rotate knob H6 clockwise. Leave paper in bin. [426.xx–428.xx] 264
  - [x]-page jam, open doors G, H, and J and clear jammed paper. Leave paper in bin. [400–402] 255
  - [x]-page jam, press latch at area E to open ADF's top cover. [28y.xx] 269
  - [x]-page jam, press latch to access area G and clear jammed staples. Leave paper in bin. [402.93] 261
  - [x]-page jam, press latch to access area G. Leave paper in bin. [40y.xx] 258
  - [x]-page jam, slide the 3000-sheet tray and open door C. [2yy.xx] 247
  - [x]-page jam, slide the 3000-sheet tray and open door D. [24y.xx] 251
  - Cartridge low [88.xy] 271
  - Cartridge nearly low [88.xy] 271
  - Cartridge very low [88.xy] 271
  - Change [paper source] to [custom string] load [orientation] 271
  - Change [paper source] to [custom type name] load [orientation] 271
  - Change [paper source] to [paper size] load [orientation] 271
  - Change [paper source] to [paper type] [paper size] load [orientation] 272
  - Close door [x] 272
  - Complex page, some data may not have printed [39] 272
  - Configuration change, some held jobs were not restored [57] 272
  - Defective flash detected [51] 272
  - Disk full [62] 273
  - Disk full, scan job canceled 273
  - Disk must be formatted for use in this device 273
  - Disk near full. Securely clearing disk space. 273
  - Empty the hole punch box 273
  - Error reading USB drive. Remove USB. 273
  - Error reading USB hub. Remove hub. 273
  - Fax memory full 274
  - Fax partition inoperative. Contact system administrator. 274
  - Fax server 'To Format' not set up. Contact system administrator. 274
  - Fax Station Name not set up. Contact system administrator. 274
  - Fax Station Number not set up. Contact system administrator. 274
  - Incorrect paper size, open [paper source] [34] 274
  - Insert hole punch box 275
  - Insert Tray [x] 275
  - Insufficient memory for Flash Memory Defragment operation [37] 275
  - Insufficient memory to collate job [37] 275
  - Insufficient memory to support Resource Save feature [35] 275
  - Insufficient memory, some Held Jobs were deleted [37] 275
  - Insufficient memory, some held jobs will not be restored [37] 275
  - Insufficient space between paper stacks in Tray 3 275
  - Load [paper source] with [custom string] [paper orientation] 276
  - Load [paper source] with [custom type name] [paper orientation] 276
  - Load [paper source] with [paper size] [paper orientation] 276
  - Load [paper source] with [paper type] [paper size] [paper orientation] 276

- Load Multipurpose Feeder with [custom string] [paper orientation] 276
- Load Multipurpose Feeder with [custom type name] [paper orientation] 277
- Load Multipurpose Feeder with [paper size] [paper orientation] 277
- Load Multipurpose Feeder with [paper type] [paper size] [paper orientation] 277
- Load staples 277
- Load staples [G11, G12] 278
- Memory full [38] 278
- Memory full, cannot print faxes 278
- Memory full, cannot send faxes 278
- Network [x] software error [54] 278
- No analog phone line connected to modem, fax is disabled. 278
- Not enough free space in flash memory for resources [52] 279
- Open door H and remove paper from beneath area H10 279
- Paper changes needed 279
- Parallel port [x] disabled [56] 279
- Photoconductor low [84.xy] 279
- Photoconductor very low [84.xy] 279
- Printer had to restart. Last job may be incomplete. 280
- Reinstall missing or unresponsive cartridge [31.xy] 280
- Reinstall missing or unresponsive photoconductor [31.xy] 280
- Remove defective disk [61] 280
- Remove packaging material, [area name] 280
- Remove packaging material, open door C, remove metal clips, remove all screws from scanner carriage 280
- Remove paper from [linked set bin name] 281
- Remove paper from all bins 280
- Remove paper from bin [x] 281
- Remove paper from standard output bin 281
- Replace [x] maintenance kit, 0 estimated pages remain [80.xy] 282
- Replace all originals if restarting job. 281
- Replace cartridge, 0 estimated pages remain [88.xy] 281
- Replace cartridge, printer region mismatch [42.xy] 281
- Replace jammed originals if restarting job. 282
- Replace missing cartridge [31.xy] 282
- Replace missing photoconductor [31.xy] 282
- Replace missing waste toner bottle [82.xy] 282
- Replace paper pick rollers in [paper source], use parts and instructions in tray 1 or tray 2 compartment [80] 283
- Replace photoconductor, 0 pages remain [84.xy] 283
- Replace unsupported cartridge [32.xy] 283
- Replace unsupported photoconductor [32.xy] 283
- Replace waste toner bottle [82.xy] 283
- Restore held jobs? 283
- Scanner disabled by admin [840.01] 283
- Scanner disabled. Contact system administrator if problem persists. [840.02] 284
- Scanner jam, remove jammed originals from the scanner [2yy.xx] 284
- Scanner maintenance required soon, use ADF Kit [80] 284
- Scanner maintenance required, use ADF Kit [80] 284
- Serial port [x] disabled [56] 284
- SMTP server not set up. Contact system administrator. 284
- Some held jobs were not restored 284
- Standard network software error [54] 284
- Standard USB port disabled [56] 285
- Supply needed to complete job 285
- The device is operating in safe mode. Some print options may be disabled or provide unexpected results. 285
- Too many flash options installed [58] 285
- Too many trays attached [58] 285
- Tray [x] paper size unsupported 286
- Unformatted flash detected [53] 286
- Unsupported disk 286
- Unsupported option in slot [x] [55] 286
- Unsupported USB hub, please remove 273
- Waste toner bottle nearly full [82.xy] 286
- Weblink server not set up. Contact system administrator. 286
- printer options troubleshooting
  - internal option is not detected 289
  - internal print server 290
  - Internal Solutions Port 290
  - tray problems 291
  - USB/parallel interface card 292
- printer power switch 227
- printer problems, solving basic 287
- printer security
  - information on 204
- printhead lens
  - cleaning 206
- printing
  - canceling, from the printer control panel 75
  - directory list 75
  - font sample list 74
  - forms 70
  - from a mobile device 72
  - from flash drive 71
  - from Macintosh 70
  - from Windows 70
  - menu settings page 50
  - network setup page 50
  - printing a directory list 75
  - printing a document 70
  - printing a font sample list 74
  - printing a menu settings page 50
  - printing a network setup page 50



printing confidential and other held jobs  
 from a Macintosh computer 73  
 from Windows 73  
 printing forms 70  
 printing from a flash drive 71  
 printing from a mobile device 72  
 publications  
 where to find 9  
 Push Button Configuration method  
 using 48

## Q

Quality menu 188

## R

recipient(s)  
 e-mail options 86  
 recycled paper  
 using 61, 198  
 recycling  
 Lexmark packaging 201  
 Lexmark products 200  
 toner cartridges 201  
 reducing a copy 79  
 Reinstall missing or unresponsive cartridge [31.xy] 280  
 Reinstall missing or unresponsive photoconductor [31.xy] 280  
 Remote Operator Panel  
 setting up 25  
 Remove defective disk [61] 280  
 Remove packaging material, [area name] 280  
 Remove packaging material, open door C, remove metal clips, remove all screws from scanner carriage 280  
 Remove paper from [linked set bin name] 281  
 Remove paper from all bins 280  
 Remove paper from bin [x] 281  
 Remove paper from standard output bin 281  
 removing printer hard disk 36  
 repeat print jobs 73  
 printing from a Macintosh computer 73  
 printing from Windows 73  
 repeating defects appear on prints 311

Replace [x] maintenance kit, 0 estimated pages remain [80.xy] 282  
 Replace all originals if restarting job. 281  
 Replace cartridge, 0 estimated pages remain [88.xy] 281  
 Replace cartridge, printer region mismatch [42.xy] 281  
 Replace jammed originals if restarting job. 282  
 Replace missing cartridge [31.xy] 282  
 Replace missing photoconductor [31.xy] 282  
 Replace missing waste toner bottle [82.xy] 282  
 Replace paper pick rollers in [paper source], use parts and instructions in tray 1 or tray 2 compartment [80] 283  
 Replace photoconductor, 0 pages remain [84.xy] 283  
 Replace unsupported cartridge [32.xy] 283  
 Replace unsupported photoconductor [32.xy] 283  
 Replace waste toner bottle [82.xy] 283  
 replacing parts  
 pick, feed, separator rollers 227  
 transfer module 230  
 transfer roller 233  
 replacing supplies  
 staple cartridge in booklet finisher 218  
 staple cartridge in staple finisher 215  
 staple cartridge in staple, hole punch finisher 220  
 toner cartridge 221  
 waste toner bottle 223  
 replacing the ADF scan pad 235  
 replacing the exhaust filter 225  
 replacing the ozone filter 225  
 replacing the pick, feed, and separator rollers 227  
 replacing the staple cartridge in the booklet finisher 218  
 replacing the staple cartridge in the staple finisher 215

replacing the staple cartridge in the staple, hole punch finisher 220  
 replacing the toner cartridge 221  
 replacing the transfer module 230  
 replacing the transfer roller 233  
 replacing the waste toner bottle 223  
 reports  
 viewing 239  
 Reports menu 128  
 reserve print jobs 73  
 printing from a Macintosh computer 73  
 printing from Windows 73  
 resetting the maintenance counter 234  
 resolution  
 e-mail options 87  
 fax options 110  
 scan options 115  
 resolution, fax  
 changing 108  
 Restore held jobs? 283  
 restoring factory default settings 241  
 RJ-11 adapter 99  
 rollers  
 replacing 227

## S

safety information 7, 8  
 Save As Shortcut  
 copy options 82  
 e-mail options 87  
 scan options 115  
 saving paper 80  
 scan image  
 output file type 115  
 scan options  
 darkness 115  
 file name 115  
 original size 115  
 page setup 116  
 resolution 115  
 Save As Shortcut 115  
 Scan Preview 116  
 Send As 115  
 Scan Preview  
 scan options 116  
 scan preview  
 fax options 111

- scan screen
  - content source 115
  - content type 115
- Scan to Computer
  - setting up 114
- Scan to Network
  - setting up 24
  - using 112
- scan troubleshooting
  - cannot scan from a computer 329
  - partial document or photo scans 329
  - scan job was not successful 330
  - scanner unit does not close 331
  - scanning takes too long or freezes the computer 331
- scanner
  - functions 13
- Scanner disabled by admin [840.01] 283
- Scanner disabled. Contact system administrator if problem persists. [840.02] 284
- scanner glass
  - cleaning 205
  - using 14
- Scanner jam, remove jammed originals from the scanner [2yy.xx] 284
- Scanner maintenance required soon, use ADF Kit [80] 284
- Scanner maintenance required, use ADF Kit [80] 284
- scanning
  - to an FTP address 113
- scanning to a computer 114
- scanning to a flash drive 114
- scanning to an FTP address
  - creating shortcuts using the computer 112
  - using the control panel 113
- scanning to network destinations 112
- security
  - modifying confidential print settings 74
- Security Audit Log menu 145
- security lock 202
- security settings information
  - erasing 203
- security Web page
  - printer security information 204
- selecting a location for the printer 10
- selecting paper 61
- Send As
  - e-mail options 87
  - scan options 115
- sending a fax using the computer 106
- sending a fax using the control panel 105
- sending an e-mail using the control panel 85
- sending fax at a scheduled time 106
- Serial [x] menu 138
- Serial port [x] disabled [56] 284
- serial printing
  - setting up 50
- Set Date and Time menu 146
- setting
  - paper size 51
  - paper type 51
  - TCP/IP address 131
- setting the fax number 104
- setting the outgoing fax name 104
- setting the Universal paper size 51
- setting up e-mail alerts 239
- setting up fax
  - country- or region-specific 99
  - digital telephone service 98
  - DSL connection 95
  - standard telephone line connection 91
  - VoIP connection 96
- setting up fax and e-mail functions 326
- setting up serial printing 50
- Setup menu 184
- shipping the printer 238
- shortcuts, creating
  - copy screen 77
  - e-mail 85
  - fax destination 107
  - FTP address 113
  - FTP destination 112
- showing icons on the home screen 21
- sides (duplex)
  - copy options 82
- Sleep Mode
  - adjusting 200
- SMTP server not set up. Contact system administrator. 284
- SMTP Setup menu 140
- Some held jobs were not restored 284
- stabilizing feet 38
- Standard Network menu 129
- Standard network software error [54] 284
- Standard USB menu 134
- Standard USB port disabled [56] 285
- staple 82
- staple cartridge in booklet finisher
  - replacing 218
- staple cartridge in staple finisher
  - replacing 215
- staple cartridge in staple, hole punch finisher
  - replacing 220
- staple cartridges
  - ordering 212
- statement of volatility 202
- status of parts
  - checking 210
- status of supplies
  - checking 210
- storing
  - paper 63
  - parts 212
  - supplies 212
- storing print jobs 73
- streaked horizontal lines appear on prints 314
- streaked vertical lines appear on prints 315
- streaks appear 318
- Substitute Size menu 122
- supplies
  - checking status 210
  - checking, from printer control panel 210
  - checking, using the Embedded Web Server 210
  - conserving 198
  - storing 212
  - using genuine Lexmark 211
  - using recycled paper 198
- supplies, ordering
  - photoconductor unit 211
  - staple cartridges 212
  - toner cartridge 211

- waste toner bottle 211
- Supply needed to complete job 285
- supply notifications
  - configuring 240
- supported flash drives 72
- supported paper sizes 63
  - finisher 67
- supported paper types 66
  - finisher 67
- supported paper weights 66
  - finisher 67
- switch
  - printer 227

## T

- TCP/IP menu 131
- telecommunication
  - notices 342, 343, 344, 345
- The device is operating in safe mode. Some print options may be disabled or provide unexpected results. 285
- the scanner does not respond 332
- tips
  - card stock 58
  - labels, paper 59
  - on using envelopes 58
  - transparencies 60
- tips on using envelopes 58
- tips on using letterhead 59
- toner cartridge
  - ordering 211
  - replacing 221
- toner cartridges
  - recycling 201
- toner darkness
  - adjusting 71
- Too many flash options installed [58] 285
- Too many trays attached [58] 285
- touch screen
  - buttons 18
- transfer module
  - replacing 230
- transfer roller
  - replacing 233
- transparencies
  - copying on 77
  - tips 60
- Tray [x] paper size
  - unsupported 286

- trays
  - linking 56, 57
  - loading 51
  - unlinking 56, 57
- troubleshooting
  - an application error has occurred 333
  - cannot open Embedded Web Server 333
  - checking an unresponsive printer 287
  - contacting customer support 334
  - fax and e-mail functions are not set up 326
  - solving basic printer problems 287
  - the scanner does not respond 332
- troubleshooting, copy
  - copier does not respond 320
  - partial document or photo copies 320
  - poor copy quality 321
  - poor scanned image quality 329
  - scanner unit does not close 331
- troubleshooting, display
  - printer display is blank 289
- troubleshooting, fax
  - caller ID is not shown 322
  - can receive but not send faxes 325
  - can send but not receive faxes 326
  - cannot send or receive a fax 323
  - received fax has poor print quality 327
- troubleshooting, paper feed
  - message remains after jam is cleared 293
- troubleshooting, print
  - envelope seals when printing 295
  - error reading flash drive 295
  - held jobs do not print 294
  - incorrect characters print 296
  - incorrect margins on prints 304
  - jammed pages are not reprinted 292
  - job prints from wrong tray 296
  - job prints on wrong paper 296
  - jobs do not print 299
  - Large jobs do not collate 297
  - multiple-language PDF files do not print 297

- paper curl 305
- paper frequently jams 293
- print job takes longer than expected 298
- tray linking does not work 300
- unexpected page breaks occur 300
- troubleshooting, print quality
  - blank pages 306
  - characters have jagged edges 301
  - clipped pages or images 301
  - gray background on prints 303
  - horizontal voids appear on prints 303
  - print irregularities 307
  - print is too dark 309
  - print is too light 310
  - printer is printing solid black pages 307
  - repeating defects appear on prints 311
  - shadow images appear on prints 312
  - skewed print 313
  - streaked horizontal lines appear on prints 314
  - streaked vertical lines 315
  - toner fog or background shading appears on prints 316
  - toner rubs off 317
  - toner specks appear on prints 317
  - transparency print quality is poor 318
  - uneven print density 318
  - white streaks on a page 318
- troubleshooting, printer options
  - internal option is not detected 289
  - internal print server 290
  - Internal Solutions Port 290
  - tray problems 291
  - USB/parallel interface card 292
- troubleshooting, scan
  - cannot scan from a computer 329
  - partial document or photo scans 329
  - scan job was not successful 330
  - scanner unit does not close 331
  - scanning takes too long or freezes the computer 331
- two-sided copying 79

**U**

- understanding the home screen
- buttons and icons 16
- uneven print density 318
- Unformatted flash detected [53] 286
- Universal paper size
  - setting 51
- Universal Setup menu 126
- unlinking trays 56, 57
- Unsupported option in slot [x] [55] 286
- Unsupported USB hub, please remove 273
- USB port 44
- USB/parallel interface card
  - troubleshooting 292
- using Forms and Favorites 70
- using Hibernate mode 199
- using recycled paper 198
- using the address book
  - e-mailing 86
- using the ADF
  - copying 76
- using the automatic document feeder (ADF) 14
- using the scanner glass 14
  - copying 76
- using the touch-screen buttons 18
- Utilities menu 190

**V**

- verify print jobs 73
  - printing from a Macintosh computer 73
  - printing from Windows 73
- vertical voids appear 318
- viewing
  - reports 239
- virtual display
  - checking, using Embedded Web Server 239
- voice mail
  - setting up 91
- Voice over Internet Protocol (VoIP)
  - fax setup 96
- voids appear 318
- VoIP adapter 96
- volatile memory 202
  - erasing 203

- volatility

- statement of 202

**W**

- waste toner bottle
  - ordering 211
  - replacing 223
- Waste toner bottle nearly full [82.xy] 286
- Weblink server not set up. Contact system administrator. 286
- Wireless menu 133
- wireless network
  - configuration information 46
- wireless network setup
  - using the Embedded Web Server 49
- wireless setup wizard
  - using 47

**X**

- XPS menu 191