

KanexPro®

4K Video Tiler & Presentation Scaler Switcher

Supports both models:

- HDBT-VTSC72-4K
- HDVTSC72-4K



All rights reserved 2016

User Manual V0.5

Intro to HDBT-VTSC72-4K & HD-VTSC72-4K

The KanexPro HDBT-VTSC72-4K is a 7-input, 2-mirrored (HDMI & HDBaseT) output presentation scaler- switcher engineered to upscale HDMI / DisplayPort and VGA devices such as laptops, Blu-ray players and desktops to a true 4K@30Hz resolution and creating a Quad Window Tiling experience in any collaboration space. Inputs include 4 HDMI, 2 DisplayPort and 1 VGA with mirrored HDMI and HDBaseT output supporting distances over CAT6 up to 70 meters with PoC. This Quad-Viewer can also be controlled via RS-232 and TCP/IP. It supports native 4K inputs and outputs with breakaway audio switching to support unbalanced stereo. Ideally used in collaboration, meeting rooms, classrooms and video conferencing applications.

Features

- Multiple inputs: 4 x HDMI, 2 x DisplayPort, 1 x RGB/YPbPr
- HDMI, DisplayPort source input with 4Kx2K@30Hz support
- Supports MHL in the four HDMI input ports.
- Supports Auto Scaler in each source input.
- Supports different multiple-window modes of quadruple windows, triple windows, double windows and a single window, outputting to a display device through one HDMI output.
- Supports a lot of pre-defined multiple-window mode
- HDCP compliant
- Fast switch between input ports.
- Supports audio 7 x 1
- Supports multiple-channel HDMI, DisplayPort audio extraction, optical fiber and eight-channel analog outputs.
- Supports one button fast switch Cable Controller.
- Chooses from four control methods – Panel, IR, LAN (Web GUI, Telnet & UDP) and RS232
- On-site firmware upgrading through LAN, RS232 or USB ports (reserved for some devices).
- 1 U Height, 19” width standard enclosure, rack mountable design
- HDBaseT output may be optional depending on the model

Table of Contents

Getting Started.....	5
Panel Layout.....	5
Front Panel.....	5
Rear Panel	6
IR Remote Control Unit.....	7
Button layout	7
HDMI/DP Cable Switcher	8
Installation	8
How to Connect the Multiviewer Switcher	8
Application Diagram.....	9
Operating Instructions	10
Standby Mode and Work Mode.....	10
Screen layout Configuration.....	11
Single Window	13
Double Windows.....	14
Triple Windows	15
Quadruple Windows	16
Output Resolutions	18
Audio Settings	19
Audio Input Select.....	19
Audio Output Instructions.....	20
OSD Setting Instructions	20
Advanced Settings.....	23
RS232 Settings.....	23
IP Setting	24
General Control.....	25
Advanced Control.....	28
Basis EDID Management	32
Advanced EDID management.....	42
EDID Assign	43

EDID upload and Download	44
EDID Names.....	45
EDID commands list	45
WEB Setting.....	52
General Settings	53
Advanced Settings.....	56
EDID.....	62
Network	64
Other	65
Factory Reset Button.....	65
F/W Update Guide	65
Electrical Parameters	65

Getting Started

Panel Layout

Front Panel

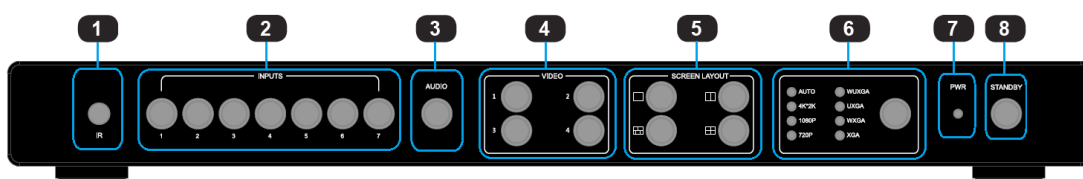

ID	Name	Description
1	IR receive window	IR receive sensor, receives the IR signals from the IR remote.
2	Input Buttons and Indicator	Press the buttons 1~7 to select the corresponding video or audio input. The indicators mean the corresponding status of the video or audio input.
3	Audio Selection Button and Indicator	Press this button, then the indicator lights up, meaning switching between audio outputs.
4	Video Input Button and Indicator	Press the buttons 1~4, indicating the corresponding windows are selected. The indicators mean whether this window is effective.
5	Video Window Mode Button and Indicator	Video window mode selection: single window, double windows, triple windows and quadruple windows. The indicators mean whether this window is effective.
6	Output Resolution Button and Indicator	Selects the related resolutions, then the indicators light up.
7	Power Indicator	Indicates when the units have power.
8	Standby button and indicator	<ul style="list-style-type: none"> ● Switches between standby and working mode. ● When this device is switched to the standby mode, the indicator lights up. ● When this device is switched to

working mode, the indicator doesn't lights up.

Rear Panel

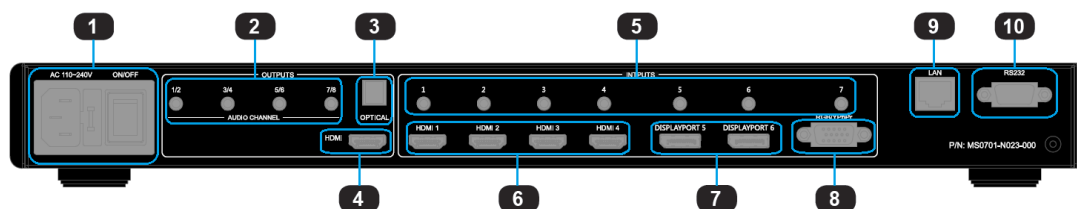

ID	Name	Description
1	Power Switch and 110/220 AC Power Receptacle	Turn the power ON or OFF using this switch, Connect the included AC power cord to this receptacle and connect the plug to an available electrical outlet.
2	Analog audio output	8 channel analog audio output, Connect a 3.5mm mini-stereo cable from this jack to the Line In jack of a multimedia system.
3	Optical output	Connect the optical output port to the digital audio input port of your amplifier
4	HDMI output	Connect an HDMI cable from this port to an HD or 4K displays.
5	Analog audio input 1~7	7 channel stereo analog audio input, Connect a 3.5mm mini-stereo cable from the Line Out jack on the audio source to this jack.
6	HDMI input 1 ~ 4	Connect up to four Hi-Def. sources to these inputs using HDMI cables.
7	DisplayPort input 1 ~ 2	Connect up to two Hi-Def. sources to these inputs using DisplayPort cables.
8	RGB/YPbPr input	Connect up to Hi-Def. sources to this input using DB-15 cable or YPbPr-VGA cable.
9	IP Cont.	Connect an Ethernet cable between this jack and a LAN to use IP control. Refer to RS-232 and IP Configuration for more information on setting up IP control.
10	RS-232	Connect an RS-232 cable from this port to an RS-232 device. See RS-232 and IP Configuration for more information on setting up RS-232 control.

IR Remote Control Unit

Button layout

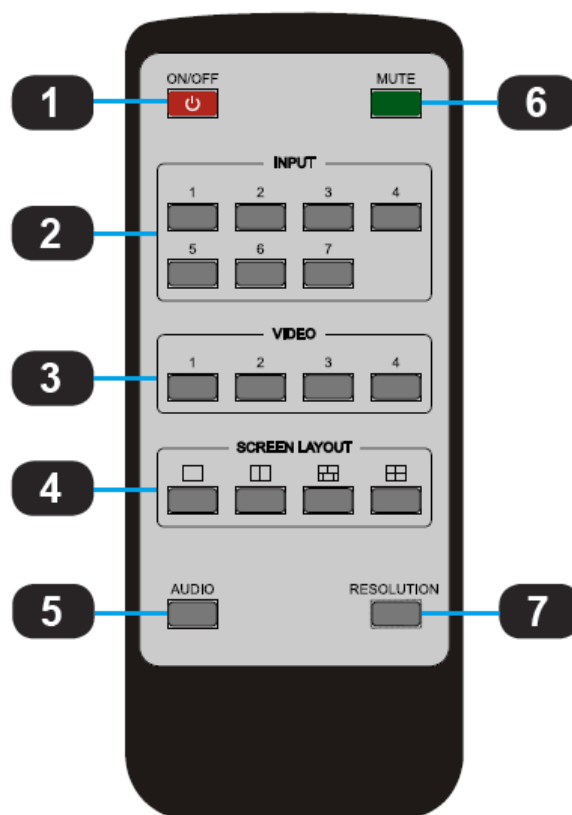

ID	Name	Description
1	Power	Press this button to power-ON or power-OFF the Multiviewer Switcher
2	Input 1-7	Press "1-7" buttons to select the corresponding video input or audio input
3	Windows 1-4	Press "1-7" buttons to select the corresponding window for select video input
4	Screen Layout	Press this buttons to select Single mode, Double mode, TRIPLE mode and Quadruple mode
5	Audio	Press this button and then press the "1-7" buttons to select the corresponding audio input
6	Mute	Press this button to Mute or Unmute the Multiviewer Switcher audio output
7	Resolution	Press this button to change the Multiviewer Switcher HDMI output resolution

HDMI/DP Cable Switcher

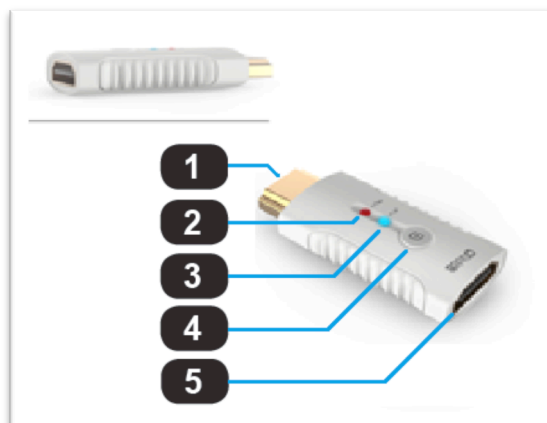

ID	Name	Description
1	HDMI/DP Output	Connect up to 4K or Hi-Def. HDMI/DP sources
2	Power Indicator	Indicates the power indicator.
3	Link Indicator	Indicates the connection status indicator.
4	Switch Button	Presses this button Multiviewer Switcher to switch to this signal port.
5	HDMI/DP Input	Connects to the HDMI or DisplayPort ports of Multiviewer Switcher using the HDMI cables.

Installation

How to Connect the Multiviewer Switcher

1. Connect up to four 4K or HD HDMI sources to the input ports (**HDMI 1 - HDMI 4**), Connect up to two 4K or HD DisplayPort sources to the input ports (**DISPLAYPORT 5 - DISPLAYPORT 6**), Connect up to one Hi-Def. VGA or YPbPr sources to the input ports (**RGB/YPbPr**) on the Multiviewer Switcher
2. Connect an 4K or HD display to the **HDMI Output** port on the Multiviewer Switcher
3. OPTIONAL: Connect up seven stereo analog audio sources to audio input ports (**1-7**) on the Multiviewer Switcher.
4. OPTIONAL: Connect the HDMI/DP input port of **HDMI/DP cable switcher** to the 4K or HD source device. Connects the HDMI/DP input port of Multiviewer Switcher to the HDMI/DP output port of HDMI/DP cable switcher using HDMI or DP cables.

5. OPTIONAL: Connect four 3.5mm **mini-stereo** cables from the jacks on the Multiviewer Switcher to the Line In jack of a multimedia system, or Connect an optical cables from the **OPTICAL** on the Multiviewer Switcher to the Optical In of a multimedia system.
6. OPTIONAL: Connect an RS-232 cable from the **RS-232** port on the Multiviewer Switcher to the RS-232 connector on the serial controller.
7. OPTIONAL: Connect an Ethernet cable from the **LAN** port on the Multiviewer Switcher to a Local Area Network (LAN).
8. Connect the AC **power cord** to the Multiviewer Switcher and connect the plug to an available electrical outlet.

Application Diagram

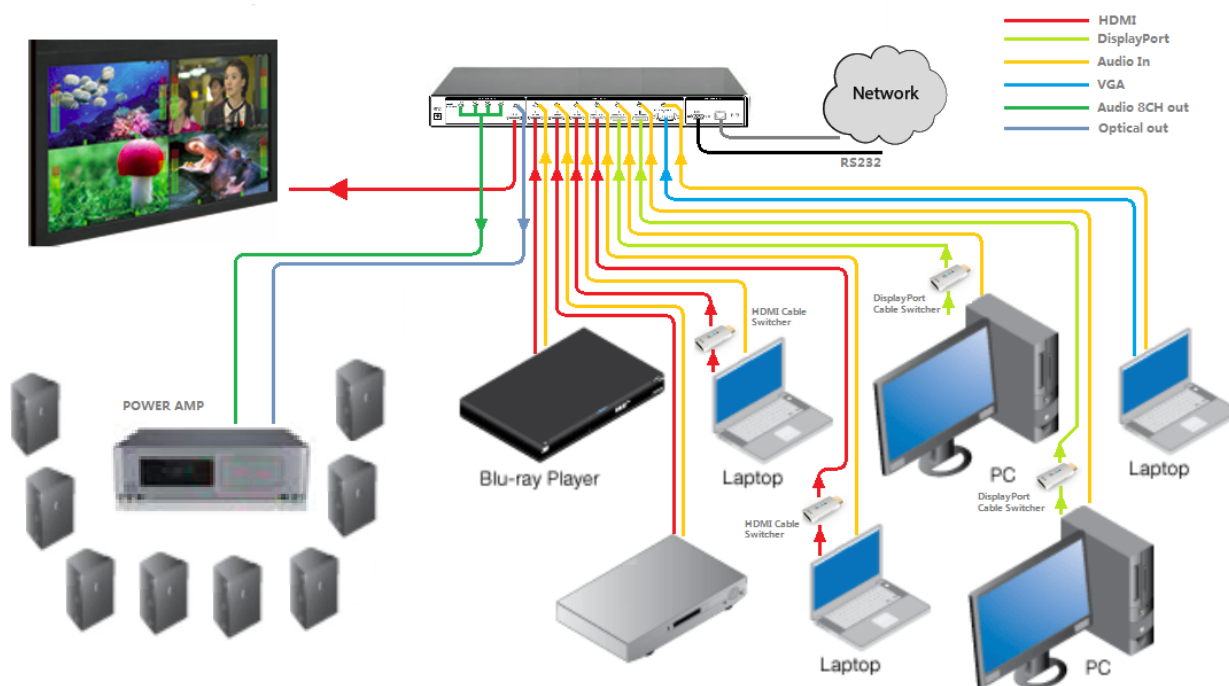

Operating Instructions

Standby Mode and Work Mode

The “PWR” LED next to the Power button, on the front panel, indicates the power state of the Multiviewer Switcher. This indicator will be red and remain illuminated as long as power is being supplied to the Multiviewer Switcher. If this indicator does not illuminate, check the connection between the power receptacle on the Multiviewer Switcher and the AC outlet.

If the Standby mode is accessed, the Standby indicator lights up until Multiviewer Switcher is waken up. When the normal work mode is accessed, the Standby indicator is off. There are three methods to wake up the device: pressing Standby button, pressing ON/OFF button in the IR remote, or using LAN or RS232 commands.



Screen layout Configuration

This Multiviewer Switcher offers quadruple window configurations: quadruple windows, triple windows, double windows and single window. The screen configuration is shown as follows.

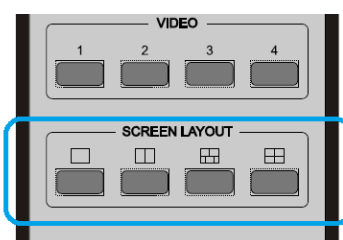
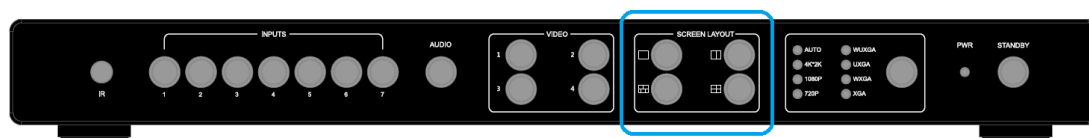
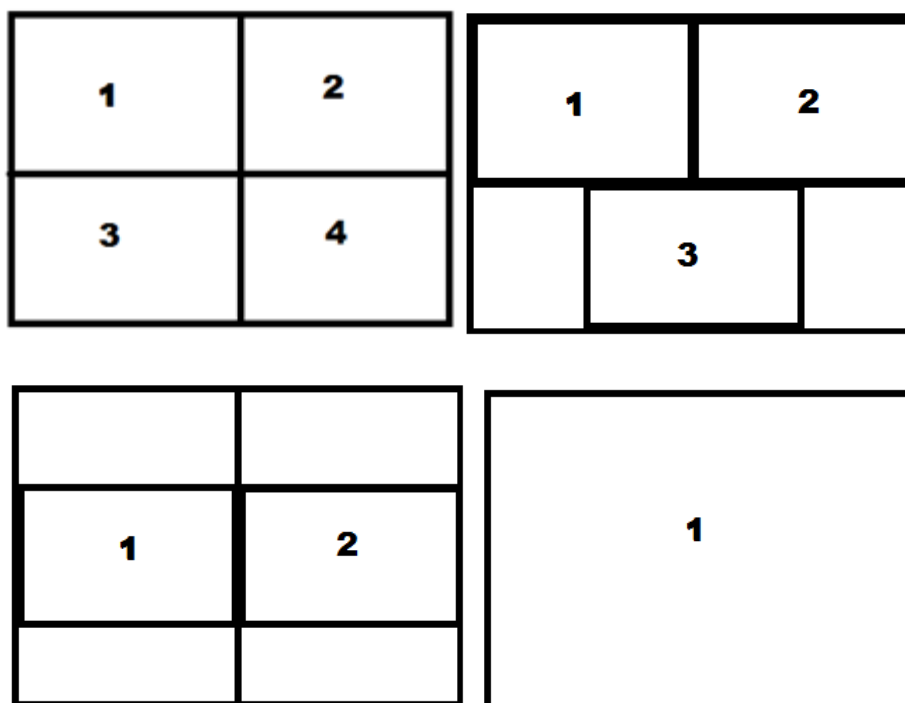

Press the four buttons in the Screen Layout of the Multiviewer Switcher, corresponding to the four modes above. For example, if you want to use the mode of quadruple windows, press the button to which  is displayed or the button in the remote, the button indicator on the panel lights up, the picture output to the display device through HDMI shows quadruple windows, meanwhile, video 1~4 indicators will light up.

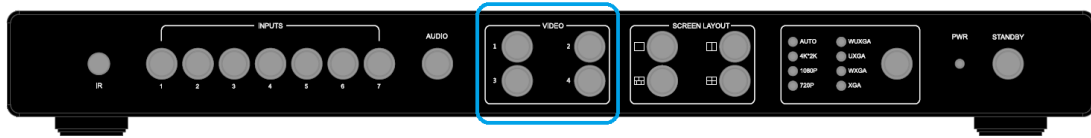

This Multiviewer Switcher can display up to four sources. When multiple sources are displayed on the screen, each source is regarded as a single window, and each window is defined as an input. However, we want to define the operation in the single window to introduce the basic operation before introduction to the operation in multiple windows. In the following example, seven HD sources (each of them is displayed as a single picture) are connected to Multiviewer Switcher. When Multiviewer Switcher is delivered from the factory, the default boot settings are loaded automatically. (See below)

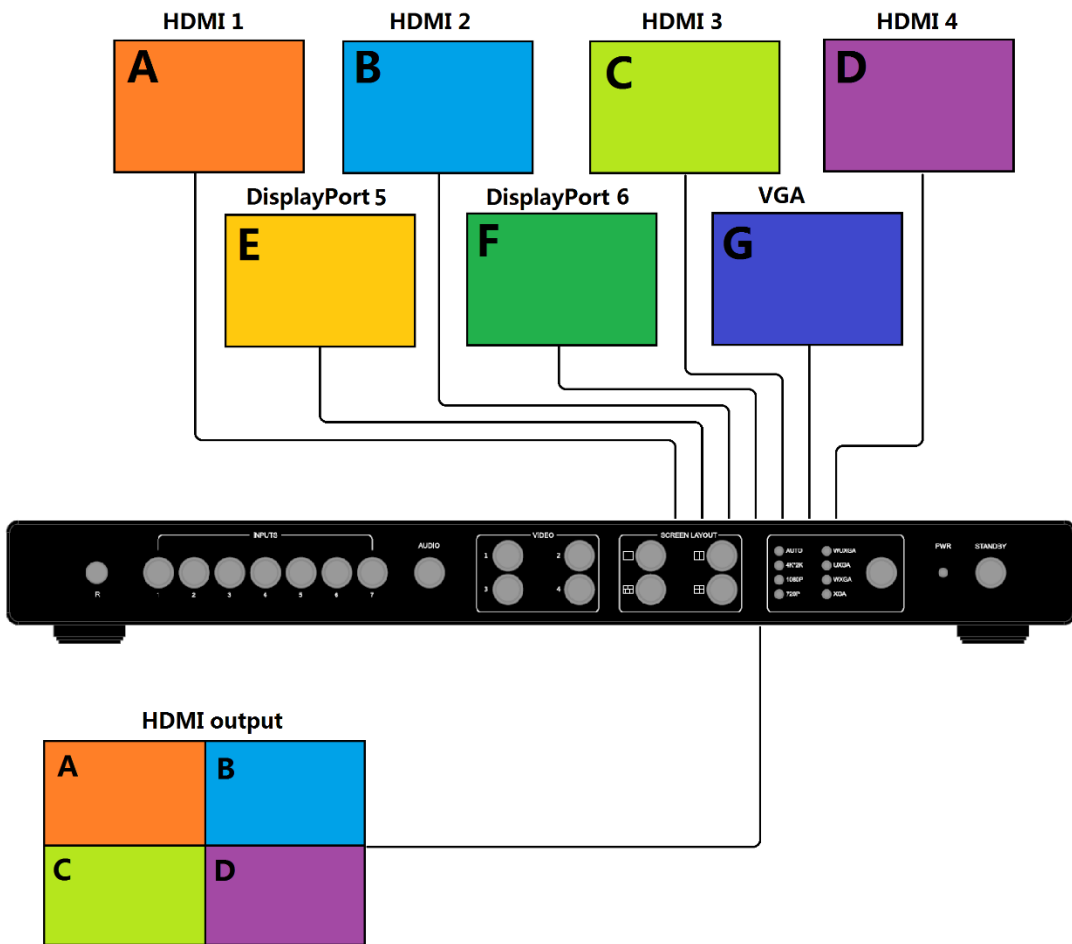

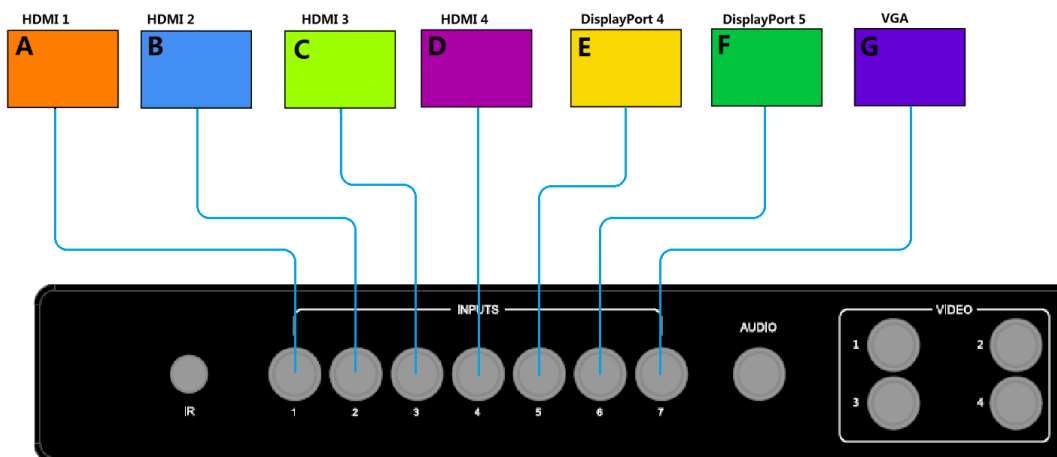

Single Window

- 1) Use button on the front panel or in the remote to set to the single window mode, Video 1 button indicator lights up, and Input 1 indicator lights up.



- 2) HDMI output configures the HDMI 1 input; the window is shown as follows.



- 3) If you want to switch to the signal of DisplayPort5.

Method 1: directly press the INPUTS 5 button on the front panel or in the remote.

Method 2: first press Video 1 button on the front panel or in the remote, the 1 button indicator on the panel turns solid on, 2~7 button indicators are blinking (If an indicator is solid on, it means the source currently selected; If an indicator is blinking, it means the source which can be selected), press the INPUTS 1 button on the front panel or in the remote.

- 4) The 5 button indicator lights up, the panel status is shown as follows.



5) HDMI output picture is changed to the signal of DisplayPort5.



Double Windows

1) Use the  button on the front panel or in the remote to set to the mode of double windows, Video 1 and 2 button indicators on the front panel light on.



2) HDMI output port outputs the mode of double windows. Window 1 is configured to HDMI 1 input (HDMI1 is the factory default. If any changes are made, use the last configuration); Window 2 is configured to HDMI2 input (HDMI2 is the factory default. If any changes are made, use the last configuration). The windows are shown as follows.

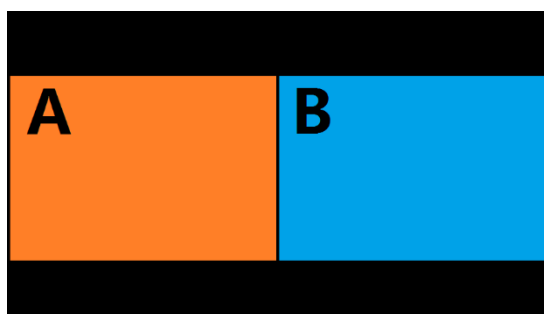

3) For example, if you want to switch to Window 1, and if you want to switch the signal of DisplayPort5.

Method 1: directly press the INPUTS 5 button on the front panel or in the remote, the Video 1 and 2 button indicators blink (indicates that the two buttons can be selected), press the Video 1

button on the front panel or in the remote to select Window 1.

Method 2: first press the Video 1 button on the front panel or in the remote, the 1 button indicator on the panel turns solid on, 2~7 button indicators are blinking (If an indicator is solid on, it means the source currently selected; If an indicator is blinking, it means this source can be selected), press the INPUTS 1 button on the front panel or in the remote.

- 4) Windows 2 can select DisplayPort6 using the same method.
- 5) When the INPUTS indicators are off, the panel status is shown as follows.



- 6) HDMI output picture is changed to the status below.



Triple Windows

- 1) Use the triple window button on the front panel or in the remote to set to the mode of triple windows, Video 1, 2 and 3 button indicators on the front panel light up.



- 2) HDMI output port outputs the mode of triple windows. Window 1 is configured to HDMI1 input (HDMI1 is the factory default. If any changes are made, use the last configuration); Window 2 is configured to HDMI2 input (HDMI2 is the factory default. If any changes are made, use the last configuration); Window 3 is configured to HDMI3 input (HDMI3 is the factory default. If any changes are made, use the last configuration). The windows are shown as follows.

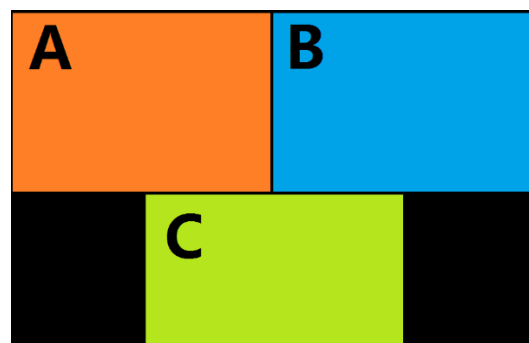

- 3) For example, if you want to switch to Window 1, and if you want to switch the signal of DisplayPort5.

Method 1: directly press the INPUTS 5 button on the front panel or in the remote, the Video 1 and 2 button indicators blink (indicates the two buttons can be selected), press the Video 1 button on the front panel or in the remote to select Window 1.

Method 2: first press the Video 1 button on the front panel or in the remote, the 1 button indicator on the panel turns solid on, 2~7 button indicators are blinking (If an indicator is solid on, it means the source currently selected; If an indicator is blinking, it means this source can be selected), press the INPUTS 1 button on the front panel or in the remote.

- 4) In the same methods, Window 2 can select DisplayPort6, and Window 3 can select RGB/YPbPr.
 5) When the INPUTS indicators are off, the panel status is shown as follows.



- 6) HDMI output picture is changed to the following status.

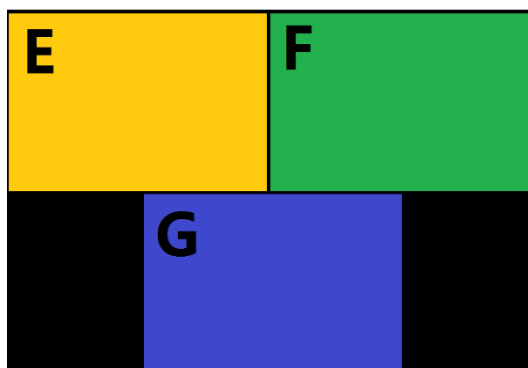

Quadruple Windows

- 1) Use the  button on the front panel or in the remote to set quadruple windows, Video 1, 2, 3 and 4 button indicators on the front panel light up.



- 2) HDMI output port outputs the mode of quadruple windows. Window 1 is configured to HDMI1 input (HDMI1 is the factory default. If any changes are made, use the last configuration); Window

2 is configured to HDMI2 input (HDMI2 is the factory default. If any changes are made, use the last configuration); Window 3 is configured to HDMI3 input (HDMI3 is the factory default. If any changes are made, use the last configuration); Window 4 is configured to HDMI4 input (HDMI4 is the factory default. If any changes are made, use the last configuration). The windows are shown as follows.

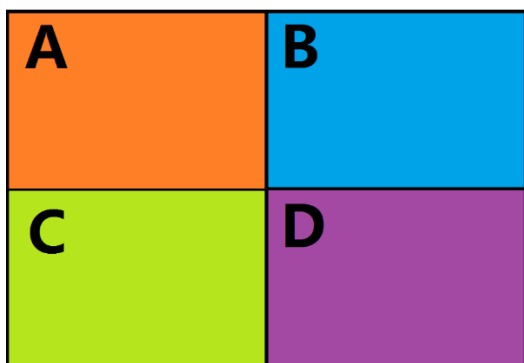

- 3) For example, if you want to switch to Window 1, and if you want to switch the input of DisplayPort5.

Method 1: directly press the INPUTS 5 button on the front panel or in the remote, the Video 1 and 2 button indicators blink (indicates the two buttons can be selected), press the Video 1 button on the front panel or in the remote to select Window 1.

Method 2: first press the Video 1 button on the front panel or in the remote, the 1 button indicator on the panel turns solid on, 2~7 button indicators are blinking (If an indicator is solid on, it means the source currently selected; If an indicator is blinking, it means this source can be selected), press the INPUTS 1 button on the front panel or in the remote.

- 4) In the same methods, Window 2 can select DisplayPort6, and Window 3 can select RGB/YPbPr.
 5) When the INPUTS indicators are off, the panel status is shown as follows.



- 6) HDMI output picture is changed to the following status.

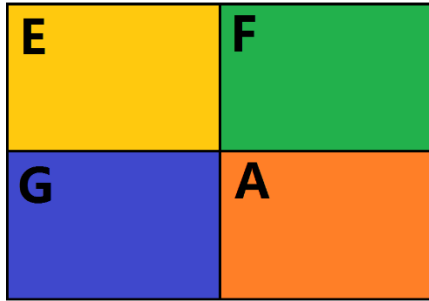

Output Resolutions

HDMI output resolutions support multiple modes with the indicator indication.

- 1) Auto
- 2) 4K x 2K (3840 x 2160 @30Hz)
- 3) 1080P (1920 x 1080 @ 60Hz)
- 4) 720P (1280 x720 @ 60Hz)
- 5) WUXGA (1900 x1200 @ 60Hz)
- 6) UXGA (1600 x1200 @ 60HZ)
- 7) WXGA (1280 x 800 @ 60Hz)
- 8) XGA (1024 x768 @60Hz)

Auto means that it outputs the HDMI resolutions based on the EDID information read from the display device.

Operation method: press the Resolution buttons on the panel or in the remote to switch between different HDMI output resolutions. The switching sequence is: Auto -> 4K x 2K -> 1080P -> 720P -> WUXGA -> UXGA -> WXGA -> XGA -> Auto. When a resolution is selected, the corresponding indicator lights up.



When selecting a resolution, HDMI output is switched to this resolution.

Audio Settings

Audio Input Select

When selecting the video input, the audio also has seven inputs. When the video input is selected as HDMI or DisplayPort, the audio can be input from HDMI or DP. If the HDMI or DP input has no audio, the audio input will be from the corresponding 3.5 mm earphone jack. For example, if the DVI signal is transmitted through HDMI1, the audio can be input from the 3.5mm earphone jack of the audio input 1 (above the HDMI1 port). VGA video corresponds to the 3.5mm earphone jack of the audio output 7.

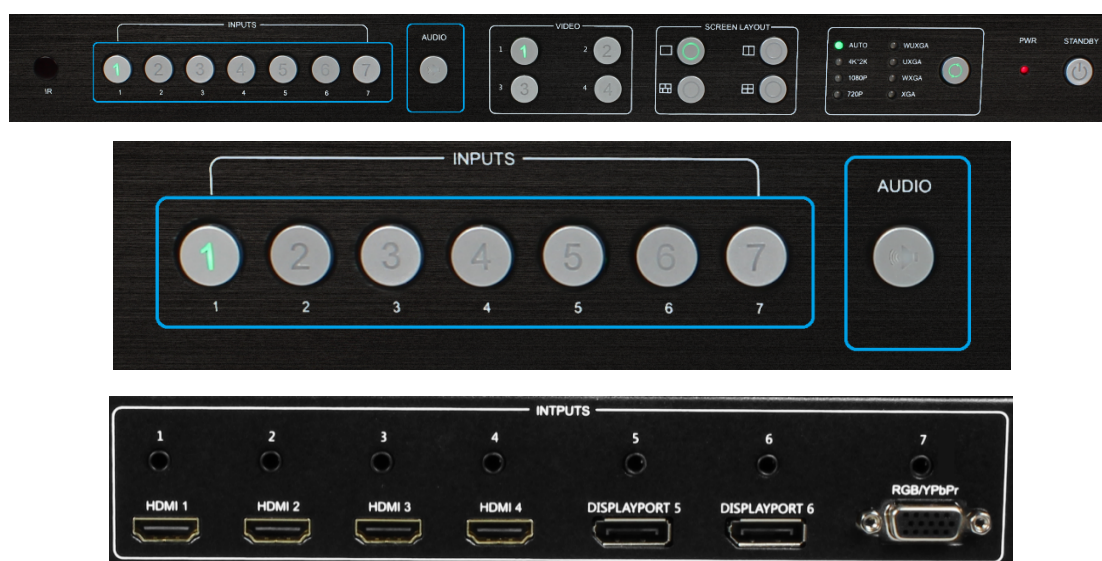

Operations for audio switching:

Method 1:

- (1). Press “Audio Selection Button” (ID #3 in front buttons), the corresponding button backlight indicator lights up, which means the audio output, is selected. The Inputs indicator of the corresponding audio source turns solid on, the other indicators blink.
- (2). Press “Inputs Button” (ID#2 in front buttons), the audio is switched to this channel. At the same time, other inputs indicator is off.
- (3). In the status mentioned in Step (2), if no further operation is performed within 5 seconds, it exists from this status.

Method 2:

- (1). Press “Inputs Button” (ID #2 in front buttons), the corresponding indicator lights up, which means the audio input, is selected. The “Audio Selection Button” blinks to be ready for selecting.
- (2). Press “Audio Selection Button” (ID#3 in front buttons), the input selected audio in step#1 is switched to program audio output channel. At the same time, Inputs indicator and audio indicator are off.

(3). In the status mentioned in Step (2), if no further operation is performed within 5 seconds, it exists from this status.

Notes:

(1). Press audio button, the Inputs indicator of the corresponding audio source turns solid on, the other indicators blink. Can confirm the current audio selected channel

(2). HDMI and DisplayPort have a 3.5mm earphone jack of stereo audio, if HDMI or DisplayPort input signal with audio format, voice output is the digital audio signal, if the signal without audio format, then automatically switch to 3.5 stereo input analog stereo.

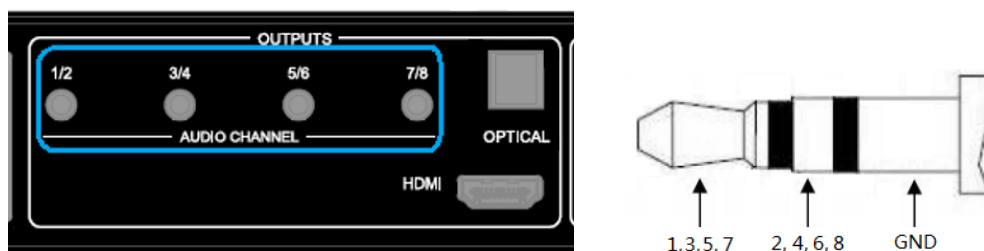

Audio Format	Channel							
	1	2	3	4	5	6	7	8
2.0	L	R						
2.1	L	R	LFE					
5.1	FL	FR	LFE	FC	RL	RR		
7.1	FL	FR	LFE	FC	RL	RR	RLC	RRC

Audio Output Instructions

There are three methods of audio output:

- (1). HDMI output
- (2). Optical output
- (3). Analog output, 8 channels for audio output

If the input audio format is 2 Ch., 1 Ch. and 2 Ch. of the 8 channels output the audio. If 5.1 Ch., channels from 1 to 6 output the audio.

OSD Setting Instructions

- 1) Boot logo

2) Each window displays input source, the resolution of the input signal, No HDMI Cable, No HDMI Signal and HDMI/DisplayPort/VGA.

A. When the single window is displayed:

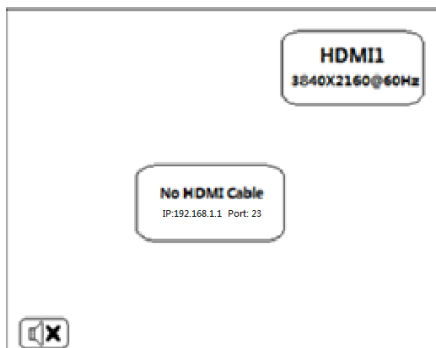

B. When the double windows are displayed:

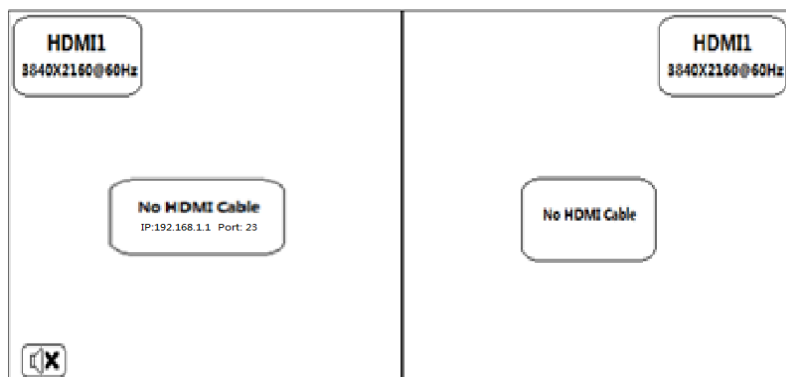

C. When the triple windows are displayed:

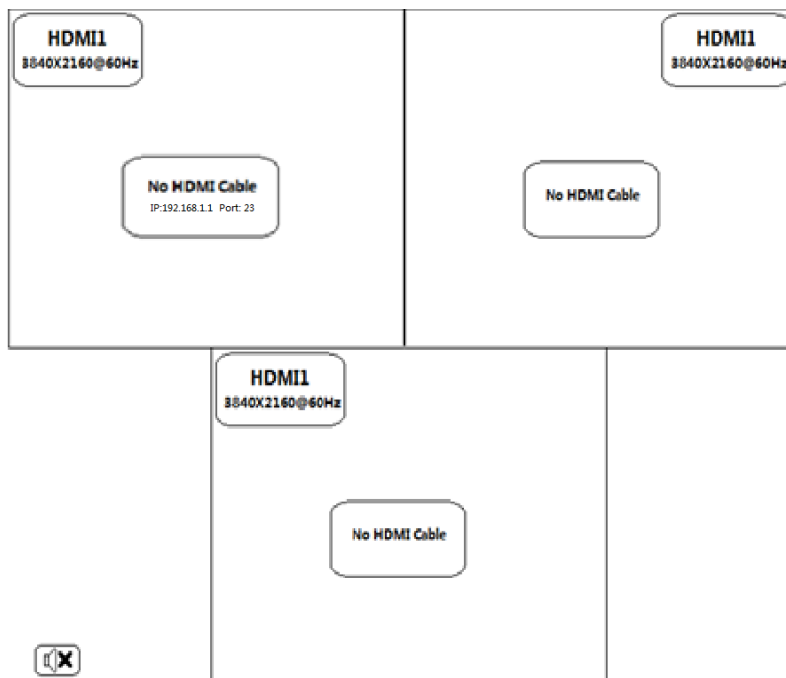

D. When the quadruple windows are displayed:



3) Audio Mute indicates:



4) Volume adjustment:

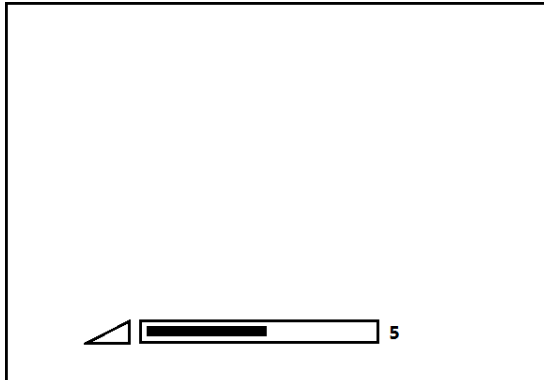

5) VGA Auto Menu:

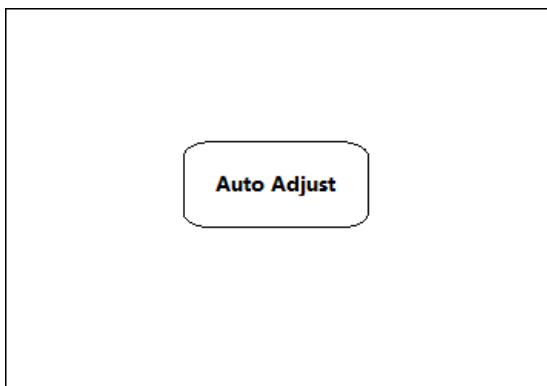

6) IP address is displayed:

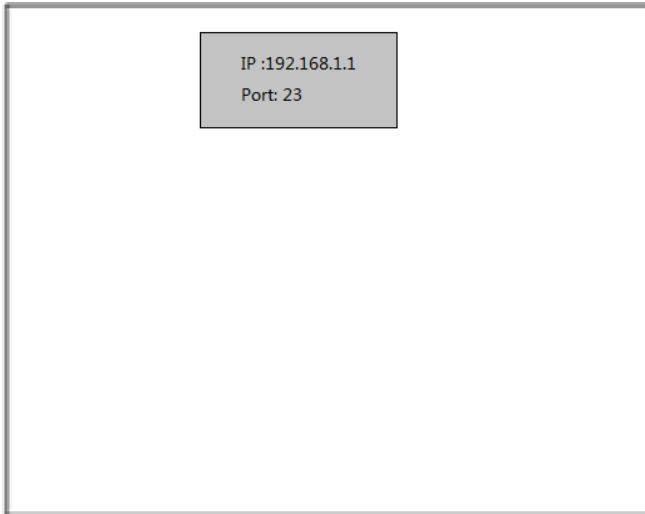

Advanced Settings

RS232 Settings

RS-232 port:

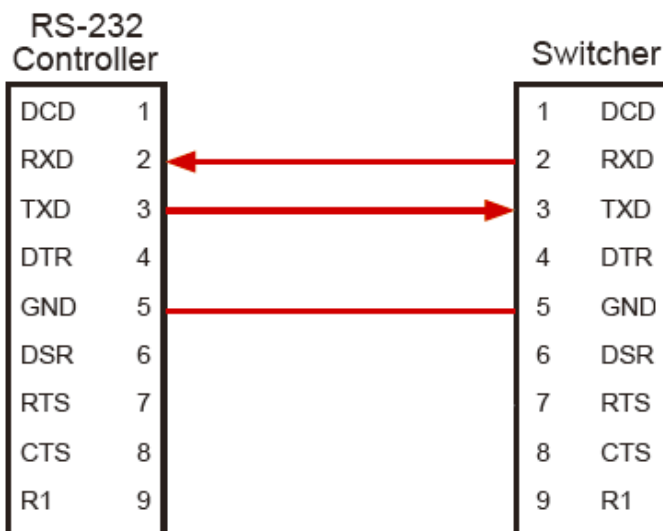
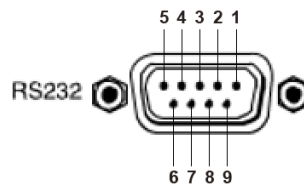

Connect to RXD, TXD, and GND only

RS-232 Settings:

Description	Setting
Baud rate	9600
Data bits	8
Parity	None
Stop bits	1
Hardware flow control	None

Notes: For more information about serial command lines, see the chapter of commands.

IP Settings

The switcher supports IP control, Telnet, UTP and so on. In order to obtain the IP address, The IP address and port number shows up right away via the information from the on-screen display (OSD) when connected to a LAN network

Get the IP address and port number via the information from the OSD.

Whether the switcher is in single-window mode or in multiple window modes, IP address and port number can always be obtained from Window 1. When there is no signal, the following OSD in the window is displayed:

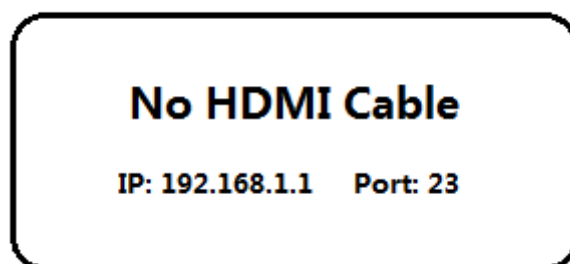

Or when the picture is displayed, the IP information is displayed in the area above the middle of the window.

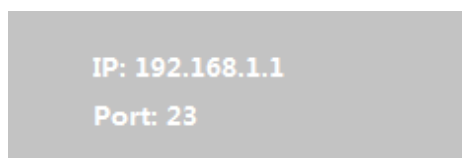

The IP address is 192.168.1.1 and the port number is 23.

RS-232 / IP Command List

The switcher can be controlled or operated through the commands from RS232 or IP. The command contains two parts: General Control and Advanced Control.

Command head: ATM

Length: <=255

Command: xxxxxxx

Read/Write: W/R

Parameter data: xx (N byte)

General Control

Function	Item	Command	Feedback	Description
Screen Layout:	Single Viewer	ATM 09 SCR_LYT W 1	09 SCR_LYT W 1	Switch to the single window.
	Double Viewer	ATM 09 SCR_LYT W 2	09 SCR_LYT W 2	Switch to the double windows.
	Triple Viewer	ATM 09 SCR_LYT W 3	09 SCR_LYT W 3	Switch to the triple windows.
	Quadruple Viewer	ATM 09 SCR_LYT W 4	09 SCR_LYT W 4	Switch to the quadruple windows.

Video Set				
Viewer 1:	Select input #1	ATM 0A VDO_IPT W 1 1	0A VDO_IPT W 1 1	Video input of Window 1 is set to 1.
	Select input #2	ATM 0A VDO_IPT W 1 2	0A VDO_IPT W 1 2	Video input of Window 1 is set to 2.
	Select input #3	ATM 0A VDO_IPT W 1 3	0A VDO_IPT W 1 3	Video input of Window 1 is set to 3.
	Select input #4	ATM 0A VDO_IPT W 1 4	0A VDO_IPT W 1 4	Video input of Window 1 is set to 4.
	Select input #5	ATM 0A VDO_IPT W 1 5	0A VDO_IPT W 1 5	Video input of Window 1 is set to 5.
	Select input #6	ATM 0A VDO_IPT W 1 6	0A VDO_IPT W 1 6	Video input of Window 1 is set to 6.
	Select input #7	ATM 0A VDO_IPT W 1 7	0A VDO_IPT W 1 7	Video input of Window 1 is set to 7.
Viewer 2:	Select input #1	ATM 0A VDO_IPT W 2 1	0A VDO_IPT W 2 1	Video input of Window 2 is set to 1.
	Select input #2	ATM 0A VDO_IPT W 2 2	0A VDO_IPT W 2 2	Video input of Window 2 is set to 2.
	Select input #3	ATM 0A VDO_IPT W 2 3	0A VDO_IPT W 2 3	Video input of Window 2 is set to 3.
	Select input #4	ATM 0A VDO_IPT W 2 4	0A VDO_IPT W 2 4	Video input of Window 2 is set to 4.
	Select input #5	ATM 0A VDO_IPT W 2 5	0A VDO_IPT W 2 5	Video input of Window 2 is set to 5.
	Select input #6	ATM 0A VDO_IPT W 2 6	0A VDO_IPT W 2 6	Video input of Window 2 is set to 6.
	Select input #7	ATM 0A VDO_IPT W 2 7	0A VDO_IPT W 2 7	Video input of Window 2 is set to 7.
Viewer 3:	Select input #1	ATM 0A VDO_IPT W 3 1	0A VDO_IPT W 3 1	Video input of Window 3 is set to 1.
	Select input #2	ATM 0A VDO_IPT W 3 2	0A VDO_IPT W 3 2	Video input of Window 3 is set to 2.
	Select input #3	ATM 0A VDO_IPT W 3 3	0A VDO_IPT W 3 3	Video input of Window 3 is set to 3.
	Select input #4	ATM 0A VDO_IPT W 3 4	0A VDO_IPT W 3 4	Video input of Window 3 is set to 4.
	Select input #5	ATM 0A VDO_IPT W 3 5	0A VDO_IPT W 3 5	Video input of Window 3 is set to 5.
	Select input #6	ATM 0A VDO_IPT W 3 6	0A VDO_IPT W 3 6	Video input of Window 3 is set to 6.
	Select input #7	ATM 0A VDO_IPT W 3 7	0A VDO_IPT W 3 7	Video input of Window 3 is set to 7.
Viewer 4:	Select input #1	ATM 0A VDO_IPT W 4 1	0A VDO_IPT W 4 1	Video input of Window 4 is set to 1.
	Select input #2	ATM 0A VDO_IPT W 4 2	0A VDO_IPT W 4 2	Video input of Window 4 is set to 2.

Select input #3	ATM 0A VDO_IPT W 4 3	0A VDO_IPT W 4 3	Video input of Window 4 is set to 3.
Select input #4	ATM 0A VDO_IPT W 4 4	0A VDO_IPT W 4 4	Video input of Window 4 is set to 4.
Select input #5	ATM 0A VDO_IPT W 4 5	0A VDO_IPT W 4 5	Video input of Window 4 is set to 5.
Select input #6	ATM 0A VDO_IPT W 4 6	0A VDO_IPT W 4 6	Video input of Window 4 is set to 6.
Select input #7	ATM 0A VDO_IPT W 4 7	0A VDO_IPT W 4 7	Video input of Window 4 is set to 7.

Audio Set:				
Audio input select:	Select input #1	ATM 09 ADO_IPT W 1	09 ADO_IPT W 1	Audio output is set to audio input 1
	Select input #2	ATM 09 ADO_IPT W 2	09 ADO_IPT W 2	Audio output is set to audio input 2
	Select input #3	ATM 09 ADO_IPT W 3	09 ADO_IPT W 3	Audio output is set to audio input 3
	Select input #4	ATM 09 ADO_IPT W 4	09 ADO_IPT W 4	Audio output is set to audio input 4
	Select input #5	ATM 09 ADO_IPT W 5	09 ADO_IPT W 5	Audio output is set to audio input 5
	Select input #6	ATM 09 ADO_IPT W 6	09 ADO_IPT W 6	Audio output is set to audio input 6
	Select input #7	ATM 09 ADO_IPT W 7	09 ADO_IPT W 7	Audio output is set to audio input 7
Audio Input Config:	Select ext. audio on input #1	ATM 0A AUD_MOD W 1 1	0A AUD_MOD W 1 1	ATM 0A AUD_MOD W M N M : input number; N : 0/1, 0-HDMI auto audio, 1-external audio E.g. This item is "Set external audio on input No. 1"
	Select ext. audio on input #2	ATM 0A AUD_MOD W 2 1	0A AUD_MOD W 2 1	Set external audio on input No. 2
	Select ext. audio on input #3	ATM 0A AUD_MOD W 3 1	0A AUD_MOD W 3 1	Set external audio on input No. 3
	Select ext. audio on input #4	ATM 0A AUD_MOD W 4 1	0A AUD_MOD W 4 1	Set external audio on input No. 4
	Select ext. audio on input #5	ATM 0A AUD_MOD W 5 1	0A AUD_MOD W 5 1	Set external audio on input No. 5
	Select ext. audio on input #6	ATM 0A AUD_MOD W 6 1	0A AUD_MOD W 6 1	Set external audio on input No. 6
Get Audio Input Config. State:	Check audio set on input #1	ATM 09 AUD_MOD R 1	Port1 Audio: 0 (Auto) / 1 (External)	ATM 09 AUD_MOD R M M : input number; E.g. This item is "Check audio input configuration set on input No. 1"
	Check audio set on input #2	ATM 09 AUD_MOD R 2	Port2 Audio: 0 (Auto) / 1 (External)	Check audio input configuration set on input No. 2
	Check audio set on input #3	ATM 09 AUD_MOD R 3	Port3 Audio: 0 (Auto) / 1 (External)	Check audio input configuration set on input No. 3
	Check audio set on input #4	ATM 09 AUD_MOD R 4	Port4 Audio: 0 (Auto) / 1 (External)	Check audio input configuration set on input No. 4
	Check audio set on input #5	ATM 09 AUD_MOD R 5	Port5 Audio: 0 (Auto) / 1 (External)	Check audio input configuration set on input No. 5
	Check audio set on input #6	ATM 09 AUD_MOD R 6	Port6 Audio: 0 (Auto) / 1 (External)	Check audio input configuration set on input No. 6

Audio volume control:	Set audio Mute	ATM 09 VOL_CRL W 0	09 VOL_CRL W 0	Set the program audio to MUTE
	Set audio volume value at "1"	ATM 09 VOL_CRL W 1	09 VOL_CRL W 1	Set program audio output volume value at 1
	Set audio volume value at "2"	ATM 09 VOL_CRL W 2	09 VOL_CRL W 2	Set program audio output volume value at 2
	Set audio volume value at "3"	ATM 09 VOL_CRL W 3	09 VOL_CRL W 3	Set program audio output volume value at 3
	Set audio volume value at "4"	ATM 09 VOL_CRL W 4	09 VOL_CRL W 4	Set program audio output volume value at 4
	Set audio volume value at "5"	ATM 09 VOL_CRL W 5	09 VOL_CRL W 5	Set program audio output volume value at 5
	Set audio volume value at "6"	ATM 09 VOL_CRL W 6	09 VOL_CRL W 6	Set program audio output volume value at 6
	Set audio volume value at "7"	ATM 09 VOL_CRL W 7	09 VOL_CRL W 7	Set program audio output volume value at 7
	Set audio volume value at "8"	ATM 09 VOL_CRL W 8	09 VOL_CRL W 8	Set program audio output volume value at 8
	Set audio volume value at "9"	ATM 09 VOL_CRL W 9	09 VOL_CRL W 9	Set program audio output volume value at 9
	Set audio volume value at "10"	ATM 09 VOL_CRL W A	09 VOL_CRL W A	Set program audio output volume value at 10
	Increase audio volume by one value	ATM 09 VOL_CRL W E	09 VOL_CRL W E	Increase program audio output by a increment of 1 value
	Decrease audio volume by one value	ATM 09 VOL_CRL W F	09 VOL_CRL W F	Decrease program audio output by a increment of 1 value

Ratio Set				
Viewer 1:	Set viewer#1 input as "NORMAL" ratio	ATM 0A WIN_RAT W 1 1	0A WIN_RAT W 1 1	Set the picture in Window 1 as the original aspect ratio
	Set viewer#1 input as "FULL" ratio	ATM 0A WIN_RAT W 1 2	0A WIN_RAT W 1 2	Set the picture in Window 1 to fill the entire window
	Set viewer#1 input as "16:9" ratio	ATM 0A WIN_RAT W 1 3	0A WIN_RAT W 1 3	Set the picture in Window 1 as the 16:9 aspect ratio
	Set viewer#1 input as "4:3" ratio	ATM 0A WIN_RAT W 1 4	0A WIN_RAT W 1 4	Set the picture in Window 1 as the 4:3 aspect ratio
Viewer 2:	Set viewer#2 input as "NORMAL" ratio	ATM 0A WIN_RAT W 2 1	0A WIN_RAT W 2 1	Set the picture in Window 2 as the original aspect ratio
	Set viewer#2 input as "FULL" ratio	ATM 0A WIN_RAT W 2 2	0A WIN_RAT W 2 2	Set the picture in Window 2 to fill the entire window
	Set viewer#2 input as "16:9" ratio	ATM 0A WIN_RAT W 2 3	0A WIN_RAT W 2 3	Set the picture in Window 2 as the 16:9 aspect ratio
	Set viewer#2 input as "4:3" ratio	ATM 0A WIN_RAT W 2 4	0A WIN_RAT W 2 4	Set the picture in Window 2 as the 4:3 aspect ratio
Viewer 3:	Set viewer#3 input as	ATM 0A WIN_RAT W 3 1	0A WIN_RAT W 3 1	Set the picture in Window 3 as the original

	"NORMAL" ratio			aspect ratio
	Set viewer#3 input as "FULL" ratio	ATM 0A WIN_RAT W 3 2	0A WIN_RAT W 3 2	Set the picture in Window 3 to fill the entire window
	Set viewer#3 input as "16:9" ratio	ATM 0A WIN_RAT W 3 3	0A WIN_RAT W 3 3	Set the picture in Window 3 as the 16:9 aspect ratio
	Set viewer#3 input as "4:3" ratio	ATM 0A WIN_RAT W 3 4	0A WIN_RAT W 3 4	Set the picture in Window 3 as the 4:3 aspect ratio
Viewer 4:	Set viewer#4 input as "NORMAL" ratio	ATM 0A WIN_RAT W 4 1	0A WIN_RAT W 4 1	Set the picture in Window 4 as the original aspect ratio
	Set viewer#4 input as "FULL" ratio	ATM 0A WIN_RAT W 4 2	0A WIN_RAT W 4 2	Set the picture in Window 4 to fill the entire window
	Set viewer#4 input as "16:9" ratio	ATM 0A WIN_RAT W 4 3	0A WIN_RAT W 4 3	Set the picture in Window 4 as the 16:9 aspect ratio
	Set viewer#4 input as "4:3" ratio	ATM 0A WIN_RAT W 4 4	0A WIN_RAT W 4 4	Set the picture in Window 4 as the 4:3 aspect ratio

Timing Set				
Output Timing:	AUTO	ATM 09 OPT_TIM W 1	09 OPT_TIM W 1	Set the HDMI output as AUTO, outputting the resolutions based on the EDID information of the display device.
	4Kx2K@30Hz UHD	ATM 09 OPT_TIM W 2	09 OPT_TIM W 2	Sets the HDMI output resolution as 4Kx2K@30Hz UHD
	1920X1080@60Hz 1080P FHD	ATM 09 OPT_TIM W 3	09 OPT_TIM W 3	Sets the HDMI output resolution as 1920X1080@60Hz 1080P FHD
	1280X720@60Hz 720P	ATM 09 OPT_TIM W 4	09 OPT_TIM W 4	Sets the HDMI output resolution as 1280X720@60Hz 720P
	1920X1200@60Hz WUXGA	ATM 09 OPT_TIM W 5	09 OPT_TIM W 5	Sets the HDMI output resolution as 1920X1200@60Hz WUXGA
	1600X1200@60Hz UXGA	ATM 09 OPT_TIM W 6	09 OPT_TIM W 6	Sets the HDMI output resolution as 1600X1200@60Hz UXGA
	1280X800@60Hz WXGA	ATM 09 OPT_TIM W 7	09 OPT_TIM W 7	Sets the HDMI output resolution as 1280X800@60Hz WXGA
	1024X768@60Hz XGA	ATM 09 OPT_TIM W 8	09 OPT_TIM W 8	Sets the HDMI output resolution as 1024X768@60Hz XGA

Advanced Control

Function	Item	Command	Feedback	Description
Power control:	Set unit to be waked up	ATM 09 POW_CRL W 0	09 POW_CRL W 0	When it's Power Off, set the device to power on. (please note it's hex "0", not letter "O")

	Set unit to power-saving standby	ATM 09 POW_CRL W F	09 POW_CRL W F	When it's Power On, set the device to stand by.
--	---	--------------------	----------------	---

Power saving	Set duration time before "power-saving" as 0m	ATM 0A POW_SAV W 00	0A POW_SAV W 00	Set Power Saving disable
	Set duration time before "power-saving" as 5m	ATM 0A POW_SAV W 05	0A POW_SAV W 05	Set the duration time before automatically go into Power Saving status as 5 minutes.
	Set duration time before "power-saving" as 10m	ATM 0A POW_SAV W 0A	0A POW_SAV W 0A	Set the duration time before automatically go into Power Saving status as 10 minutes.
	Set duration time before "power-saving" as 15m	ATM 0A POW_SAV W 0F	0A POW_SAV W 0A	Set the duration time before automatically go into Power Saving status as 15 minutes.
	Set duration time before "power-saving" as 30m	ATM 0A POW_SAV W 1E	0A POW_SAV W 1E	Set the duration time before automatically go into Power Saving status as 30 minutes.
	Set duration time before "power-saving" as 60m	ATM 0A POW_SAV W 3C	0A POW_SAV W 3C	Set the duration time before automatically go into Power Saving status as 60 minutes.

Audio Mute:	Set audio mute "ON"	ATM 09 AUD_MUT W 0	09 AUD_MUT W 0	Set the audio output as mute
	Set audio mute "OFF"	ATM 09 AUD_MUT W F	09 AUD_MUT W F	Cancel the mute setting for the audio output

Audio delay:	Set audio delay time as 0ms	ATM 09 AUD_DLY W 0	09 AUD_DLY W 0	Set the time-delay of audio output as Off.
	Set audio delay time as 40ms	ATM 09 AUD_DLY W 1	09 AUD_DLY W 1	Set the time-delay of audio output as 1 step (40ms)
	Set audio delay time as 80ms	ATM 09 AUD_DLY W 2	09 AUD_DLY W 2	Set the time-delay of audio output as 2 step (80ms)
	Set audio delay time as 120ms	ATM 09 AUD_DLY W 3	09 AUD_DLY W 3	Set the time-delay of audio output as 3 step (120ms)
	Set audio delay time as 160ms	ATM 09 AUD_DLY W 4	09 AUD_DLY W 4	Set the time-delay of audio output as 4 step (160ms)

	Set audio delay time as 200ms	ATM 09 AUD_DLY W 5	09 AUD_DLY W 5	Set the time-delay of audio output as 5 step (200ms)
	Set audio delay time as 240ms	ATM 09 AUD_DLY W 6	09 AUD_DLY W 6	Set the time-delay of audio output as 6 step (240ms)
	Set audio delay time as 280ms	ATM 09 AUD_DLY W 7	09 AUD_DLY W 7	Set the time-delay of audio output as 7 step (300ms)
	Set audio delay time as 320ms	ATM 09 AUD_DLY W 8	09 AUD_DLY W 8	Set the time-delay of audio output as 8 step (340ms)
	Set audio delay time as 360ms	ATM 09 AUD_DLY W 9	09 AUD_DLY W 9	Set the time-delay of audio output as 9 step (380ms)
	Set audio delay time as 400ms	ATM 09 AUD_DLY W A	09 AUD_DLY W A	Set the time-delay of audio output as 10 step (400ms)

VGA input Auto Position:	AUTO-adjust on VGA input	ATM 08 VGA_AUT W	08 VGA_AUT W	When it's VGA, it adjusts image position automatically.
--------------------------------	-------------------------------------	------------------	--------------	---

OSD control:	Audio OSD on/off	ATM 09 AUD_OSD W 0	09 AUD_OSD W 0	Turn on/off the audio volume and mute OSD. 0: audio OSD on; 1: audio OSD off
	Video OSD on/off	ATM 09 VDO_OSD W 0	09 VDO_OSD W 0	Turn on/off the video source and IP address OSD. 0: video OSD on, 1: video OSD off

HDMI output audio control	HDMI Output audio Mute / Unmute	ATM 09 AUD_OPT W 1	09 AUD_OPT W 1	Mute/Unmute HDMI embedded audio. 0: Mute, 1: Unmute
------------------------------------	--	--------------------	----------------	--

Restore Default Setting	Restore unit to default factory set	ATM 08 RST_SET W	08 RST_SET W	Reset to factory default settings.
-------------------------------	--	------------------	--------------	------------------------------------

Set Baud Rate:	9600	ATM 09 BAU_RAT W 1	09 BAU_RAT W 1	Set the window baud rate as 9600
	14400	ATM 09 BAU_RAT W 2	09 BAU_RAT W 2	Set the window baud rate as 14400
	19200	ATM 09 BAU_RAT W 3	09 BAU_RAT W 3	Set the window baud rate as 19200
	38400	ATM 09 BAU_RAT W 4	09 BAU_RAT W 4	Set the window baud rate as 38400
	56000	ATM 09 BAU_RAT W 5	09 BAU_RAT W 5	Set the window baud rate as 56000
	57600	ATM 09 BAU_RAT W 6	09 BAU_RAT W 6	Set the window baud rate as 57600
	115200	ATM 09 BAU_RAT W 7	09 BAU_RAT W 7	Set the window baud rate as 115200

HDCP	Enable HDCP on HDMI output	ATM 0A HDO_HDP W 1 0	0A HDO_HDP W 1 0	Enable the HDCP "Switch-ON" on the HDMI output port
------	---------------------------------------	----------------------	------------------	---

	Disable HDCP on HDMI output	ATM 0A HDO_HDP W 1 F	0A HDO_HDP W 1 F	Disable the HDCP “Switch-ON” on the HDMI output port
	Enable HDCP on HDBaseT-T output	ATM 0A HDO_HDP W 2 0	0A HDO_HDP W 2 0	Enable the HDCP “Switch-ON” on the HDBaseT-T output port
	Disable HDCP on HDBaseT-T output	ATM 0A HDO_HDP W 2 F	0A HDO_HDP W 2 F	Disable the HDCP “Switch-ON” on the HDBaseT-T output port
	Check HDCP status on HDMI output	ATM 08 HDO_HDP R	08 HDO_HDP R	Read/Check the HDCP switch status on the HDMI output port

Set priority EDID when Auto-scaler and mirror output:	Set HDMI as priority EDID	ATM 09 HDO_EDID W 1	09 HDO_EDID W 1	When Auto-scaler output and mirror HDMI &HDBaseT-T output, set HDMI output as the priority EDID for optimized resolution output
	Set HDBT as priority EDID	ATM 09 HDO_EDID W 2	09 HDO_EDID W 2	When Auto-scaler output and mirror HDMI &HDBaseT-T output, set HDBaseT-T output as the priority EDID for optimized resolution output

Others	Get SW Version:	ATM 08 CSW_VER W	08 CSW_VER W	Read/Check the software version
	Enable input HDCP KEY	ATM 09 IPT_DCP W 1	09 IPT_DCP W 1	Enable the HDMI input HDCP “Switch-ON”
	Set input HDMI/DP embedded audio to “MUTE”	ATM 09 AUD_OPT W 1	09 AUD_OPT W 1	Set the HDMI/DP embedded audio to “MUTE”
	Activate system update by USB disk	ATM 09 SYS_UPT W 1	09 SYS_UPT W 1	Start the upgrading progress through USB connected with upgrading file stored inside

Audio Configuration:

Audio Config. Set:

Set the input audio port to be auto HDMI audio or external analog audio

Send: ATM 0A AUD_MOD W **M** **N**

M: 1, 2, 3, 4, 5, 6, (input audio No. 1-6)

N: 0, 1 (0: Auto; 1: External)

Feedback: 0A AUD_MOD W **M** **N**

Read Audio Input Config. State:

Read the audio input configuration of each input audio channel

Send: ATM 09 AUD_MOD R **M**

M: 1, 2, 3, 4, 5, 6 (input audio No.1-6)

Feedback: Port2 Audio: 0 (Auto)

Port2 Audio: 1 (External)

Basic EDID Management

The EDID management includes two methods: Basic EDID Management and Advance EDID Management.

Basic EDID management:

Inner EDID procedure schematic diagram :

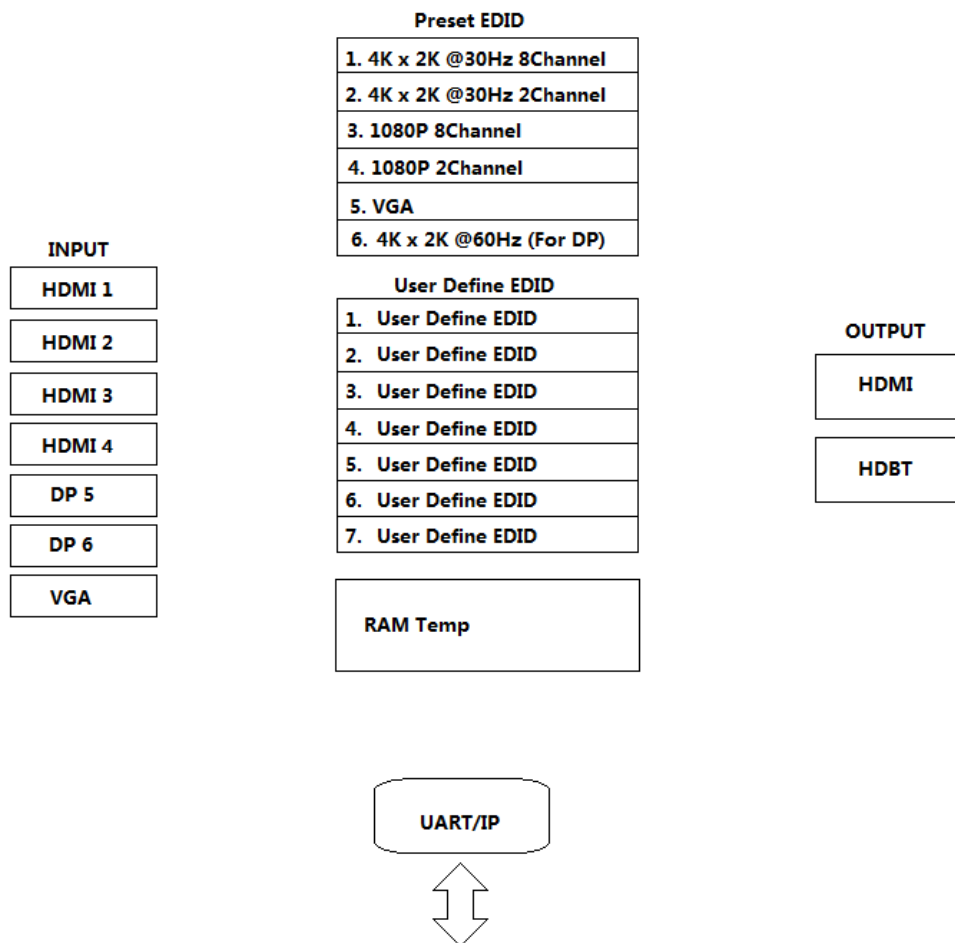

Software introduction

Please run the software "UartAssist". Which is opened with main interface as below:

Attention: Main software menu is pull down menu, as below. If user wants to change the language, please change the language option to be in English.

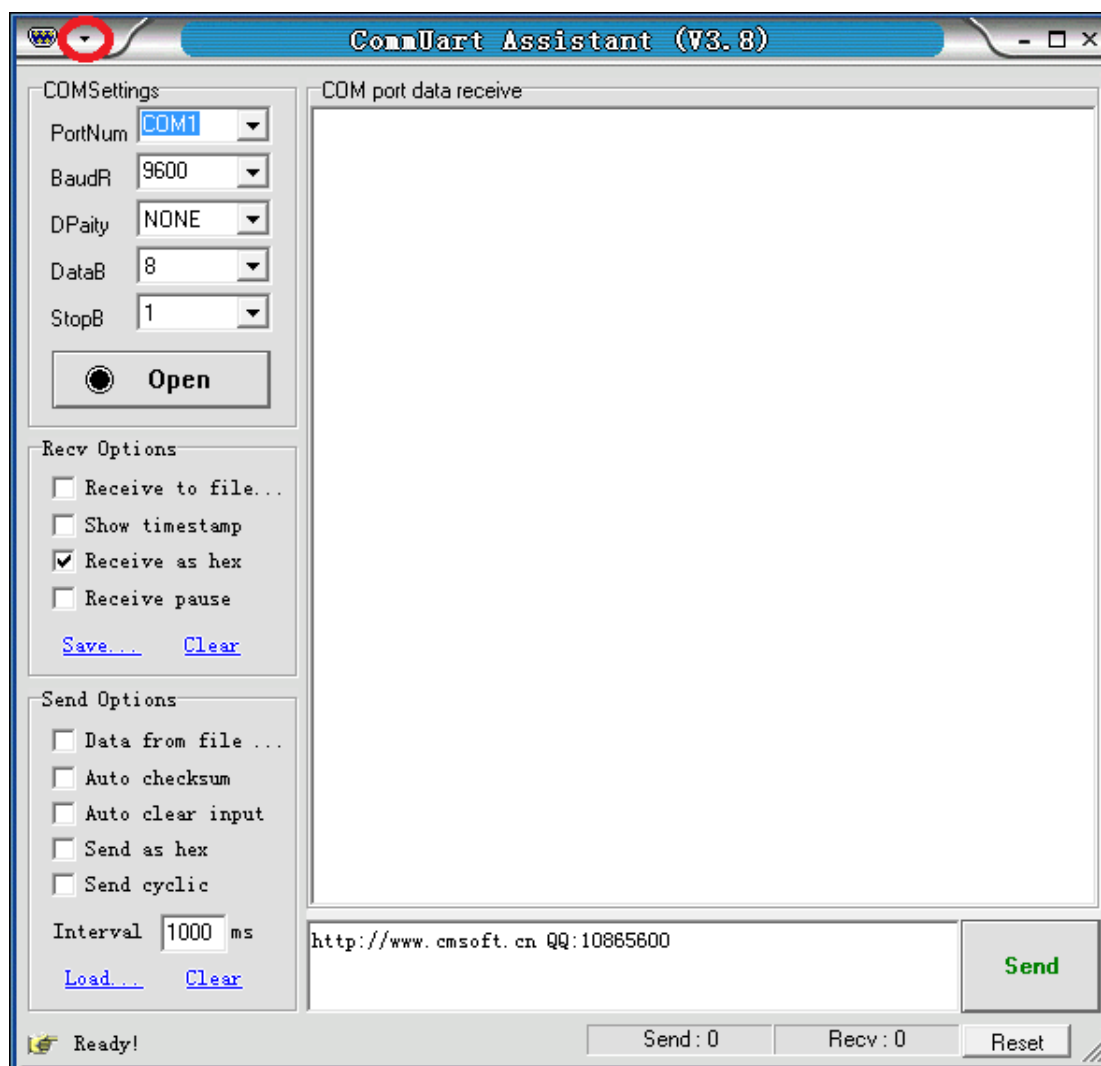

Copy the EDID of output to assign it to the EDID of input:

Send: ATM 09 EDI_CPY N M

N: 1, 2 (output No. 1-2)

M: 1, 2, 3, 4, 5, 6, 7 (input No. 1-7)

Feedback: 09 EDI_CPY N M

Example: Copy the output port No.1, of which EDID from connected display device to assign to the input port No.

1

Send: ATM 09 EDI_CPY 1 1

Feedback: 09 EDI_CPY 1 1

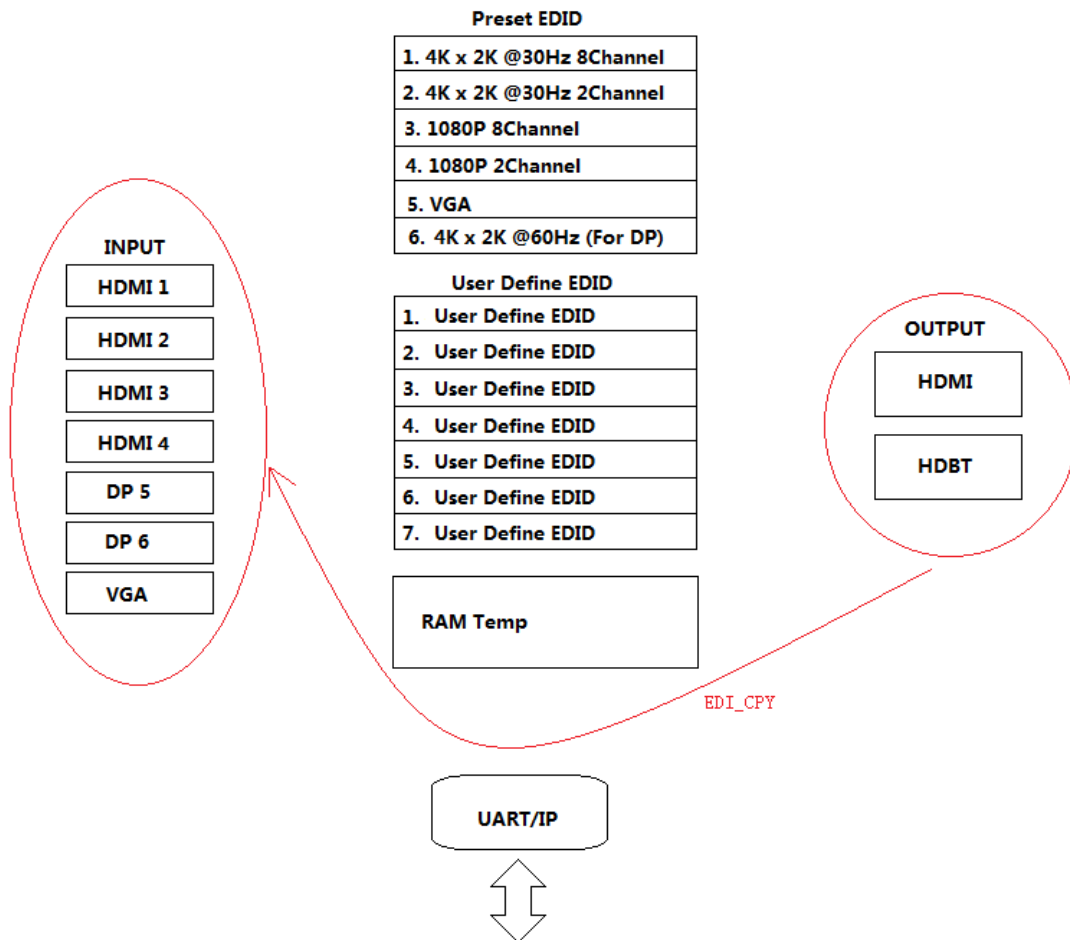

Read the EDID data:

Send: ATM 09 EDI_POR R **M**

M: 1, 2, 3, 4, 5, 6, 7 (input No. 1-7)

Feedback: (receive the EDID data as below)

```
00 FF FF FF FF FF FF 00 1E 74 01 00 01 00 00 00 01 18 01 03 80 79 44 78 0A EE 91 A3 54 4C 99 26 0F 50 54 BD EF 80
71 4F 81 C0 81 00 81 80 95 00 A9 C0 B3 00 01 01 04 74 00 30 F2 70 5A 80 B0 58 8A 00 50 1D 74 00 00 1E 02 3A 80 18 71 38 2D
40 58 2C 45 00 50 1D 74 00 00 1E 00 00 00 FD 00 18 4B 0F 87 3C 00 0A 20 20 20 20 20 20 00 00 00 FC 00 4D 53 30 37 30 31 0A
20 20 20 20 20 20 01 AE 02 03 3A F1 57 61 10 1F 04 13 05 14 20 21 22 5D 5E 5F 60 65 66 62 63 64 07 16 03 12 23 0F 5F 07 E2
00 0F 76 03 0C 00 10 00 B8 78 20 00 80 01 02 03 04 00 00 00 00 00 00 00 02 3A 80 18 71 38 2D 40 58 2C 45 00 50 1D 74 00
00 1F 66 21 56 AA 51 00 1E 30 46 8F 33 00 50 1D 74 00 00 1F 00 00 00 00 00 00 00 00 00 00 00 00 00 00 00 00 00 00 00
00 00 00 00 00 00 00 00 00 00 00 00 DD
```

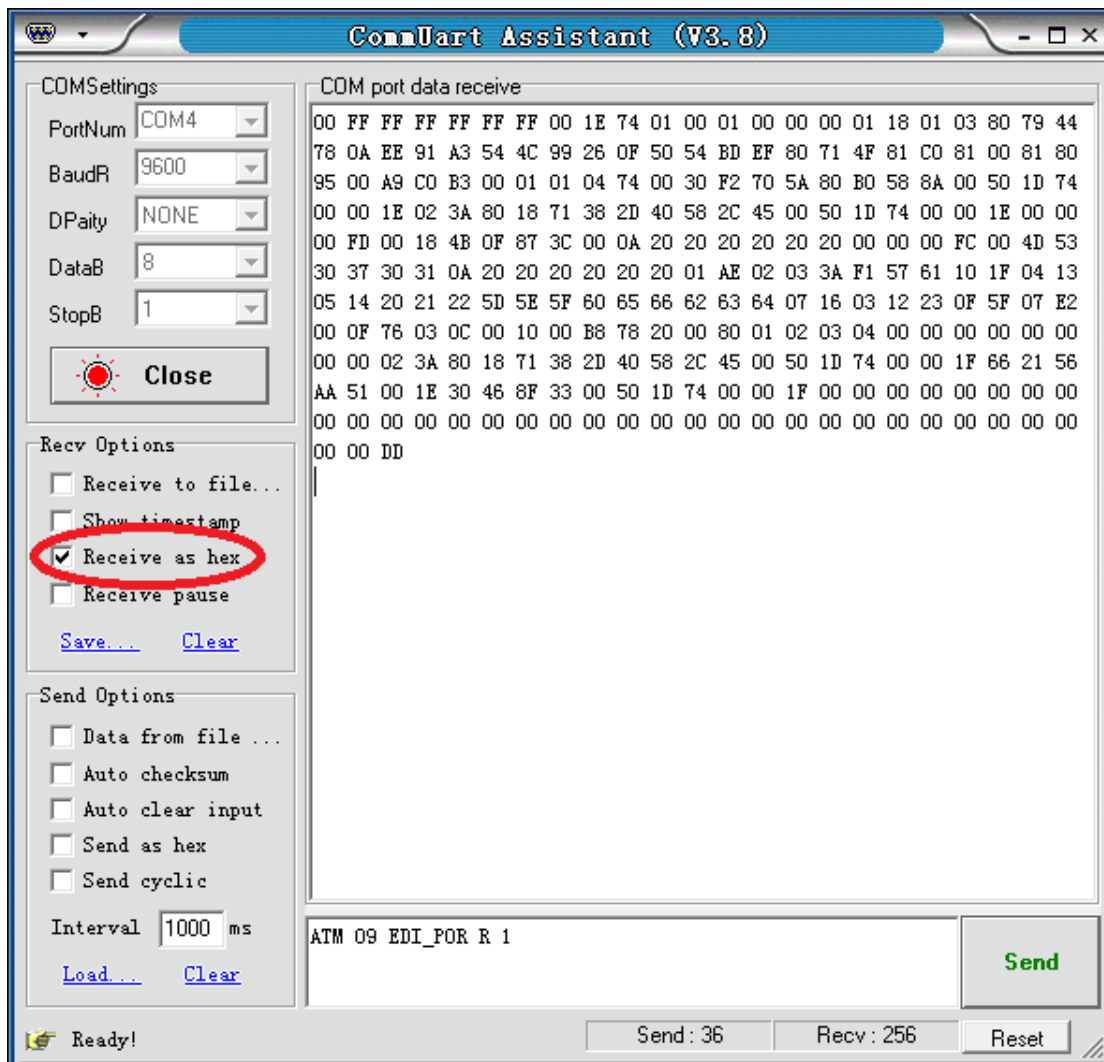

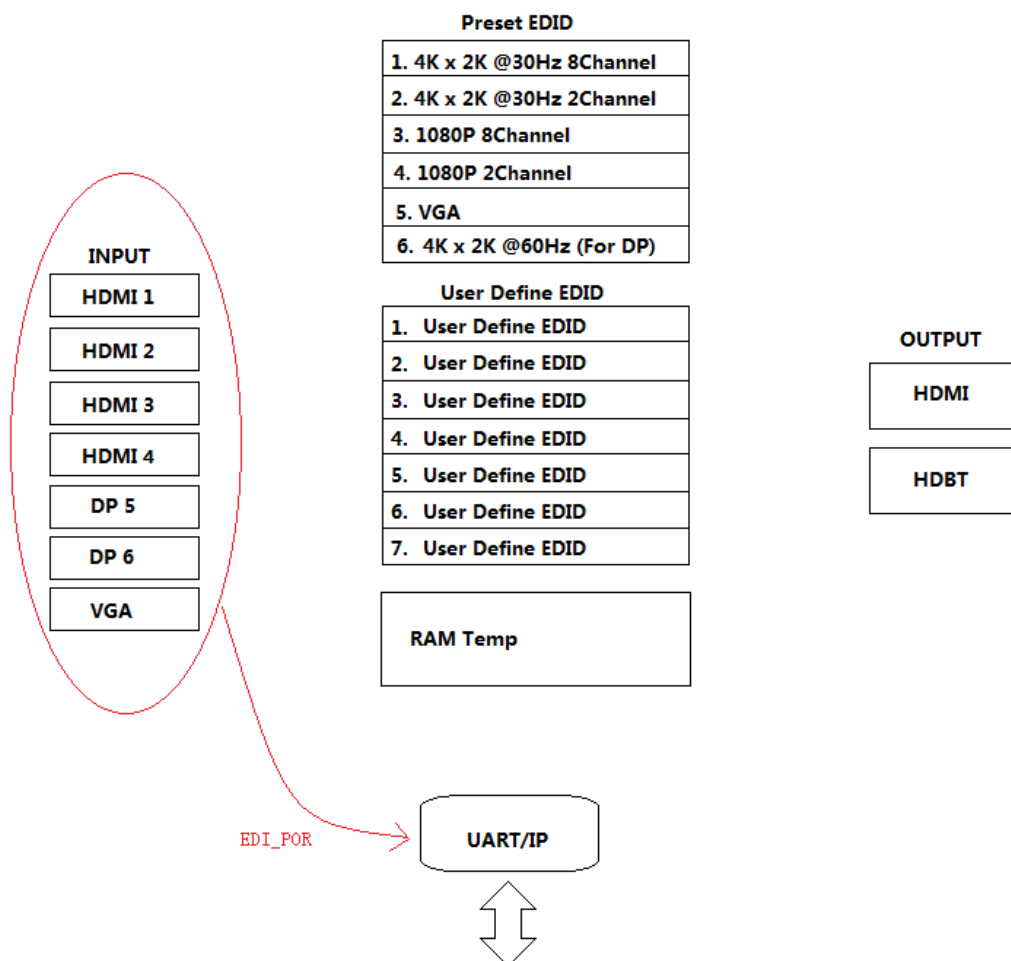

Assign the inner EDID to appointed port:

Inner EDID consists of two parts, Preset EDID and User Define EDID

Assign preset EDID to certain port:

Send: ATM 0B EDI_POR W M C N

M: 1, 2, 3, 4, 5, 6, 7 (input No. 1-7)

N: 1, 2, 3, 4, 5, 6 (Inner preset EDID value No. 1-6)

Preset EDID

1. 4K x 2K @30Hz 8Channel
2. 4K x 2K @30Hz 2Channel
3. 1080P 8Channel
4. 1080P 2Channel
5. VGA
6. 4K x 2K @60Hz (For DP)

Feedback: 0B EDI_POR W M C N

Assign user define EDID to certain input port:

Send: ATM 0B EDI_POR W M E N

M: 1, 2, 3, 4, 5, 6, 7 (input port No. 1-7)

N: 1, 2, 3, 4, 5, 6, 7 (uploaded user define EDID No.1-7)

Feedback: 0B EDI_POR W M E N

User Define EDID

1. User Define EDID
2. User Define EDID
3. User Define EDID
4. User Define EDID
5. User Define EDID
6. User Define EDID
7. User Define EDID

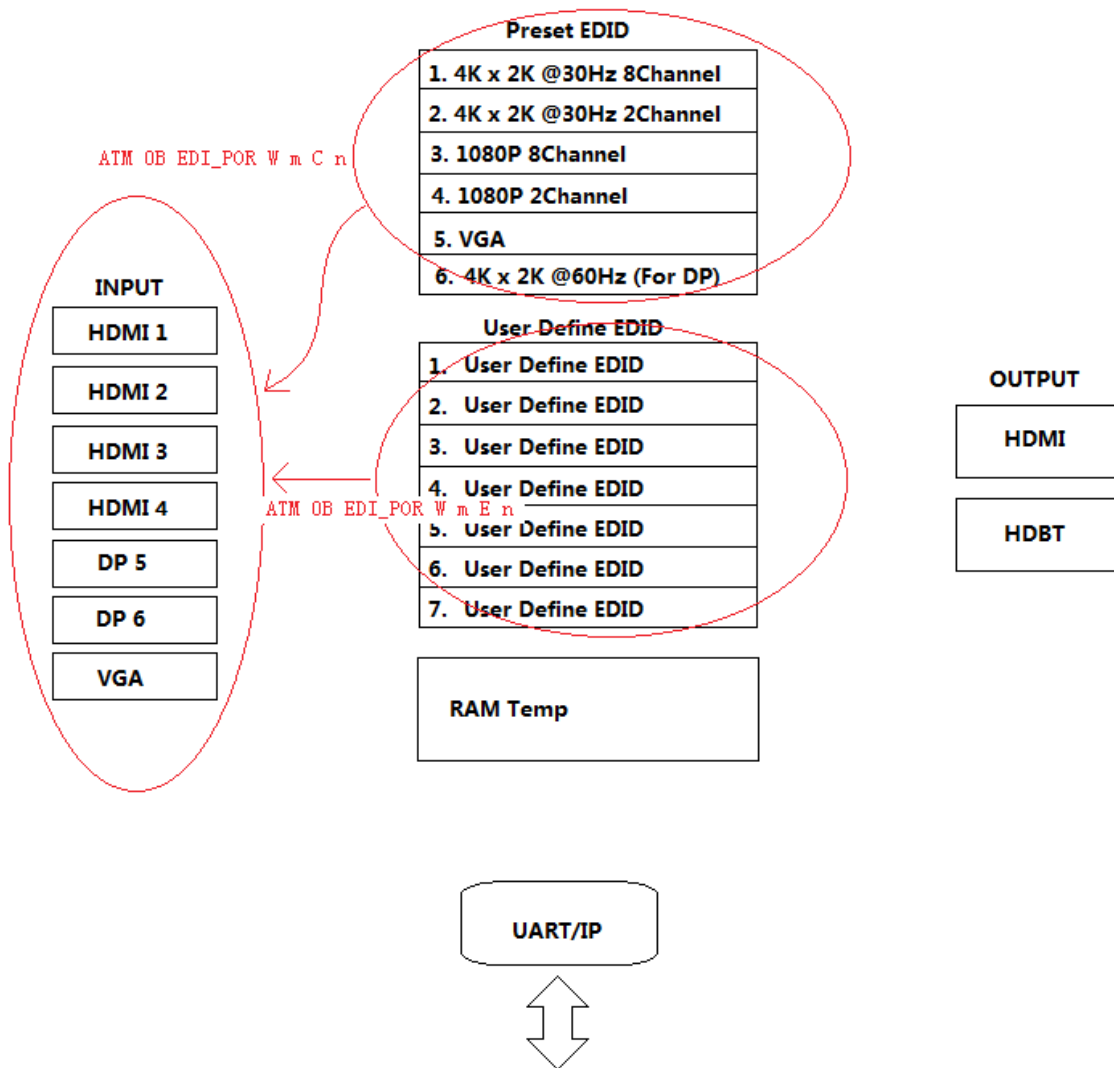

Upload EDID by RS232, LAN:

- Steps: 1. Upload EDID to TEMP RAM
- Steps: 2. Copy TEMP RAM EDID to the user define EDID
- Steps: 3. Assign user define EDID to the input

The whole EDID upload process procedure diagram is as below:

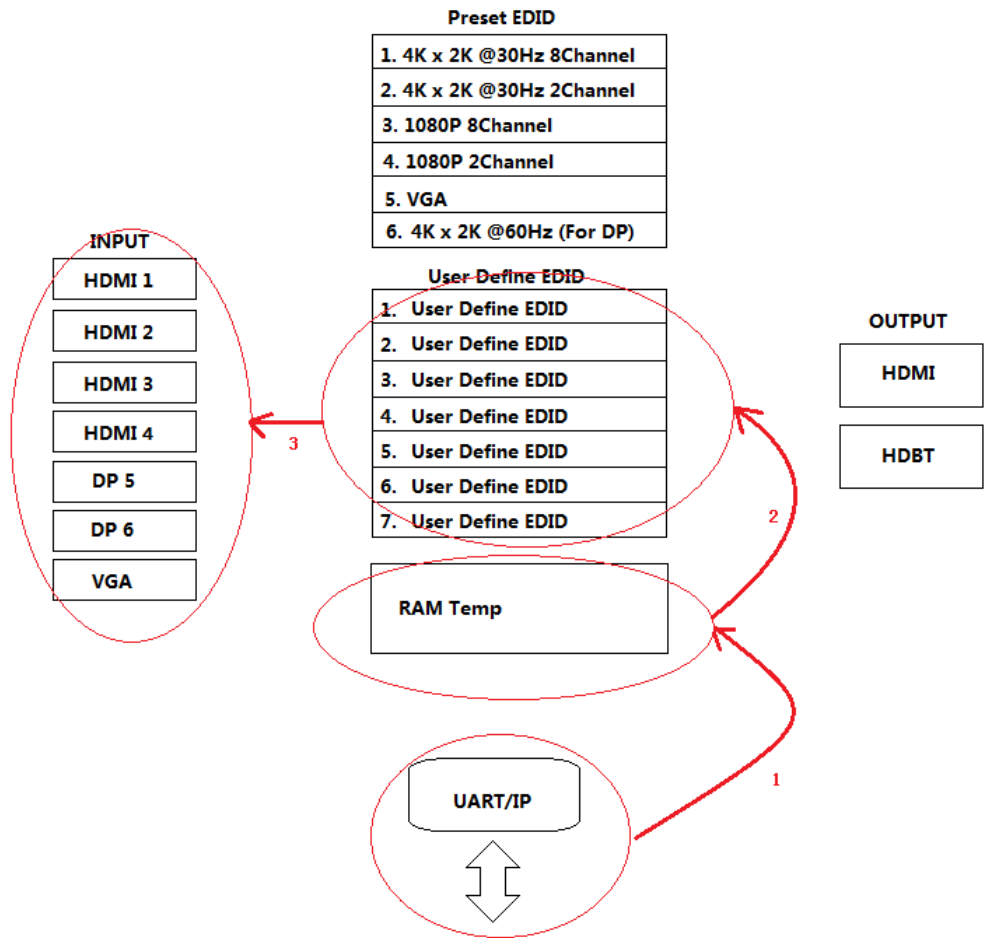

step1: Upload EDID to TEMP RAM

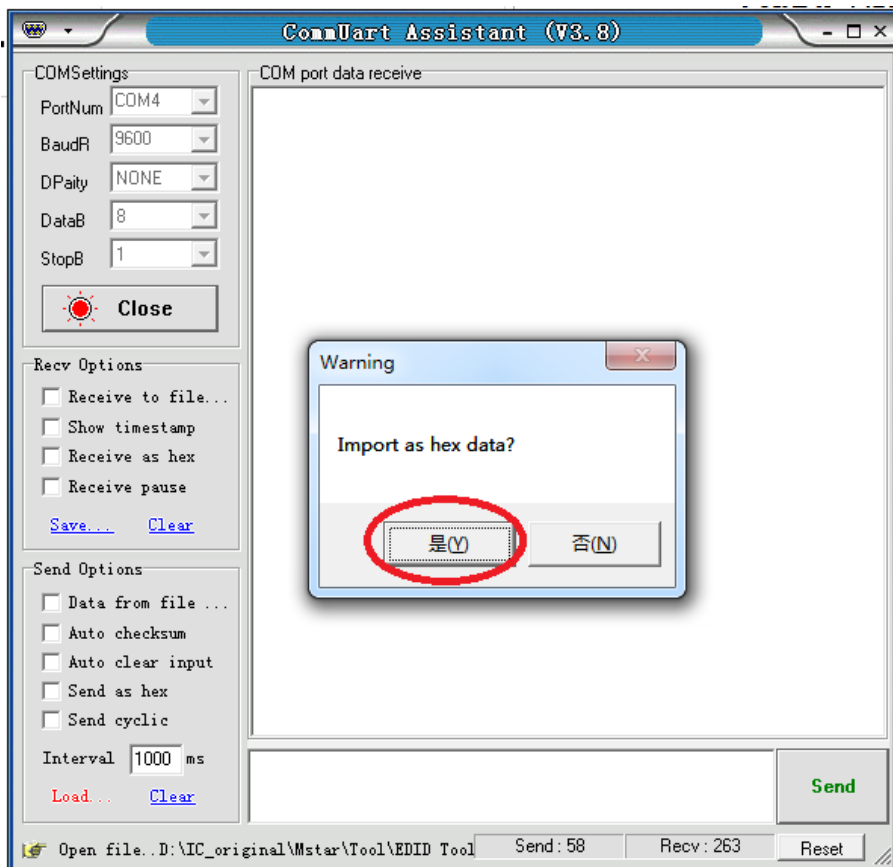
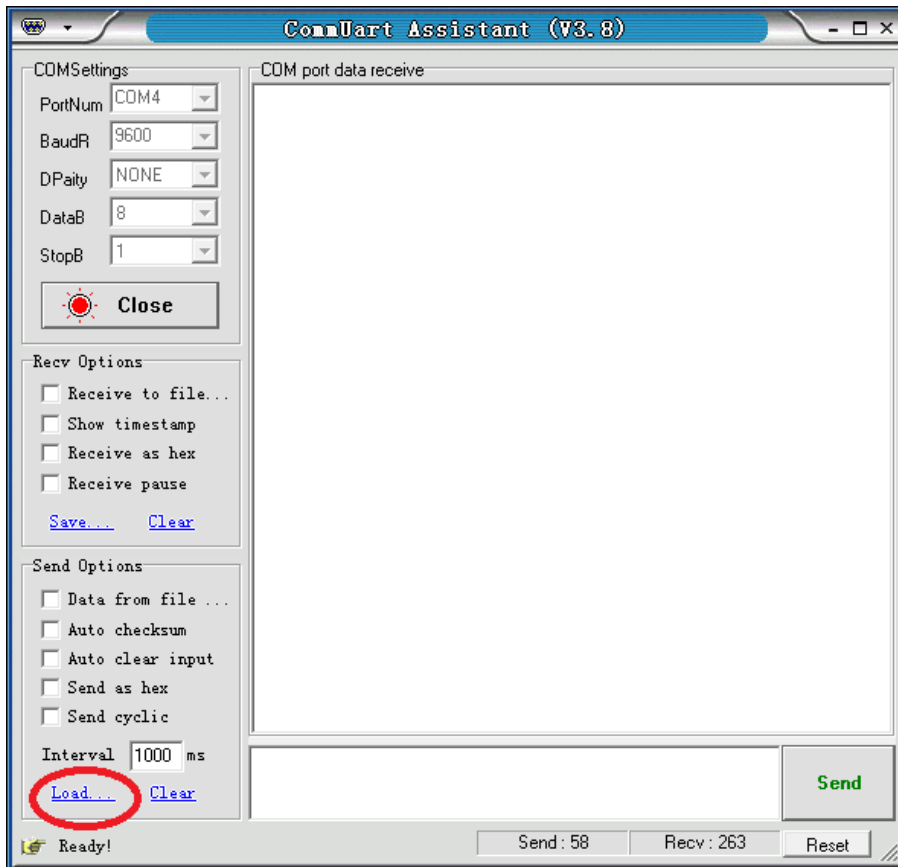

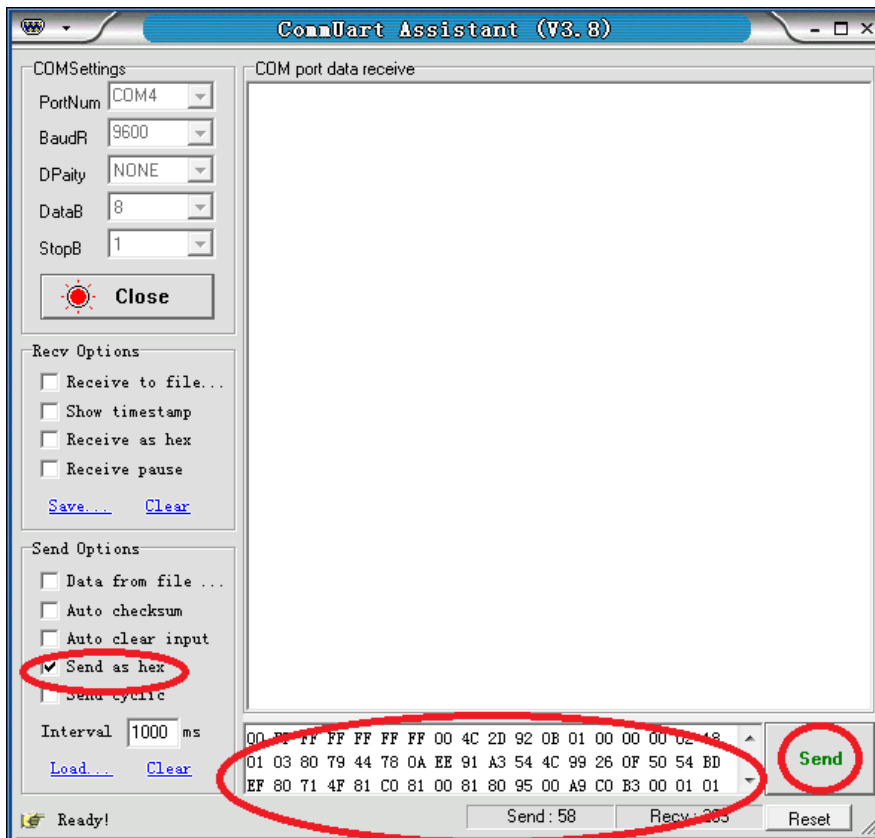

After Step 1 upload, Feedback: EDID 256B

Setp2: Copy TEMP RAM EDID to the user define EDID。

Send: ATM 09 EDI_EEP W M

M: 1,2,3,4,5,6,7 (uploaded user define EDID No.1-7)

Feedback: 09 EDI_EEP W M

Notice: Please don't click the "send as hex", as below

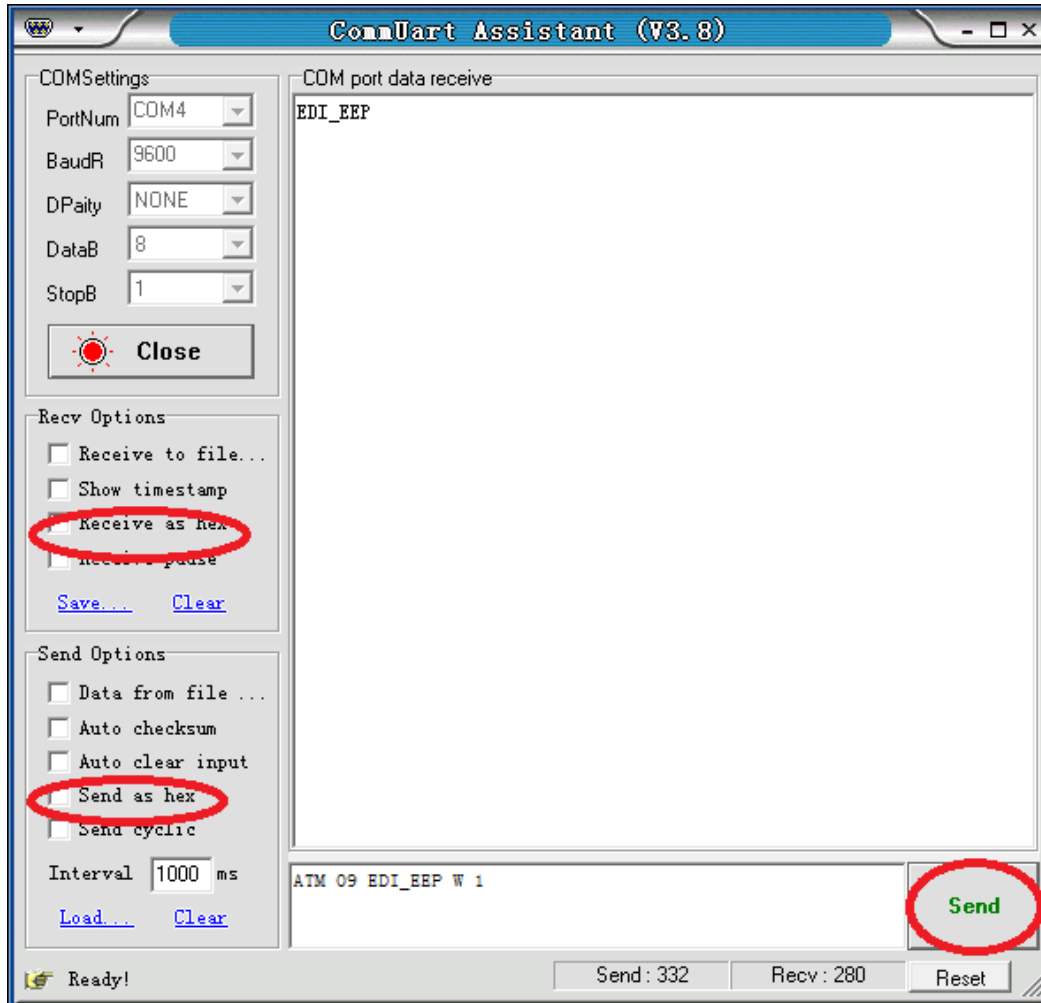

Advanced EDID management

The HDBT-VTSC72-4K's advanced EDID management contains EDID assign, EDID upload and Download and EDID commands for managing the EDID from the seven input ports.

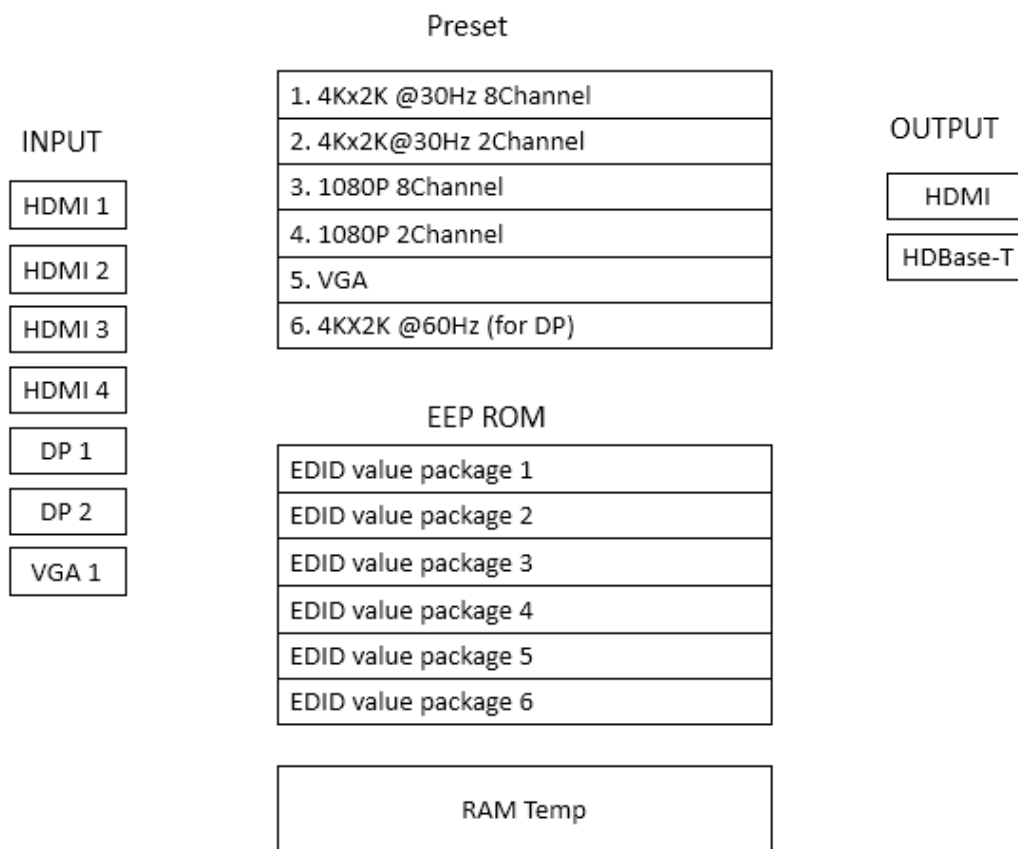

EDID Assign

The HDBT-VTSC72-4K has built in six groups of fixed EDID and seven groups of user-defined EDID. These groups of EDID can be assigned to each input port.

The current six groups of embedded EDID

1. 4K_8CH
2. 4K_2CH
3. 1080P_2CH
4. 1080P_8CH
5. VGA
6. 4K@60Hz (for DP)

Therefore, the data for assigning EDID has two groups of commands:

1. Copy Built-in EDID to Port M: `ATM 0B EDI_POR W M C N`

Copy the preset EDID **N** data in the program to the port **M**.

2. Copy EEPROM EDID to Port M: ATM 0B EDI_POR W M E N

Copy the EDID data of the EEPROM N to the port M.

For example:

Send: ATM 0B EDI_POR W 1 C 1

Feedback: 0B EDI_POR W 1 C 1

Send: ATM 0B EDI_POR W 2 E 2

Feedback: 0B EDI_POR W 2 E 2

EDID upload and Download

There is only one method for EDID uploading. The steps are shown as follows.

1. Send the 256 or 128 bytes of EDID data in hexadecimal format to the switcher via the serial or LAN ports, the switcher checks the data based on the format of EDID after receiving the data, and it responds EDID_256 or EDID_128 if no errors.
2. Send the following command to store the received EDID data in the EEPROM.

Write EDID (EEPROM): ATM 09 EDI_EEP W n

For example:

Send: ATM 09 EDI_EEP W 1

Feedback: 09 EDI_EEP W 1

3. Copy the EDID data to the related ports via the EDID assigning method.

There are two methods to download the EDID data. One is to read the EDID data from the seven groups of data in the EEPROM. The other is to directly read the EDID data from the ports.

1. Read from the seven groups of data in the EEPROM.

Read EDID(EEPROM): ATM 09 EDI_EEP R n

For example:

Send: ATM 09 EDI_EEP R 1

Feedback: 09 EDI_EEP R 1

2. Read the EDID data from the seven ports

Read EDID from Port: ATM 09 EDI_POR R m

For example:

Send: ATM 09 EDI_POR R 1

Feedback: 09 EDI_POR R 1

256 bytes of EDID data will be sent back to the controller via RS232 or LAN ports.

EDID Names

There is a management method for EDID names. You can name the uploaded seven groups of EDID data in the EERPOM. They are EDID names write and read.

1. EDID Names Write

Write EDID name (EEPROM): ATM 13 EDI_NAE W n XXXXXXXXXXXX

Interior EDID n names write, the maximum length is 10 bytes. (If the names are less than 10 bytes, use the spaces). The characters include 'A'~'Z', 'a'~'z', '0'~'9', '_', '-'.

For example:

Send: ATM 13 EDI_NAE W 1 4K_8CH---1

Feedback: 13 EDI_NAE W 1 4K_8CH---1

2. EDID Names Read

Read EDID Name (EEPROM): ATM 09 EDI_NAE R n

Interior EDID n names read

For example:

Send: ATM 09 EDI_NAE R 1

Feedback: 4K_8CH---1

EDID commands list

Function	Items	Command	Feedback	Description
Write EDID Name (EEPROM)	1	ATM 13 EDI_NAE W 1 4K2K_8CH_1	13 EDI_NAE W 1 4K2K_8CH_1	Interior EDID 1 name write
	2	ATM 13 EDI_NAE W 2 4K2K_8CH_2	13 EDI_NAE W 2 4K2K_8CH_2	Interior EDID 2 name write
	3	ATM 13 EDI_NAE W 3 4K2K_8CH_3	13 EDI_NAE W 3 4K2K_8CH_3	Interior EDID 3 name write
	4	ATM 13 EDI_NAE W 4 4K2K_8CH_4	13 EDI_NAE W 4 4K2K_8CH_4	Interior EDID 4 name write
	5	ATM 13 EDI_NAE W 5	13 EDI_NAE W 5 4K2K_8CH_5	Interior EDID 5 name write

		4K2K_8CH_5		
	6	ATM 13 EDI_NAE W 6 4K2K_8CH_6	13 EDI_NAE W 6 4K2K_8CH_6	Interior EDID 6 name write
	7	ATM 13 EDI_NAE W 7 4K2K_8CH_7	EDI_NAE W 7 4K2K_8CH_7	Interior EDID 7 name write

Read EDID Name (EEPROM)	1	ATM 09 EDI_NAE R 1	09 EDI_NAE R 1	Interior EDID 1 name read
	2	ATM 09 EDI_NAE R 2	09 EDI_NAE R 2	Interior EDID 2 name read
	3	ATM 09 EDI_NAE R 3	09 EDI_NAE R 3	Interior EDID 3 name read
	4	ATM 09 EDI_NAE R 4	09 EDI_NAE R 4	Interior EDID 4 name read
	5	ATM 09 EDI_NAE R 5	09 EDI_NAE R 5	Interior EDID 5 name read
	6	ATM 09 EDI_NAE R 6	09 EDI_NAE R 6	Interior EDID 6 name read
	7	ATM 09 EDI_NAE R 7	09 EDI_NAE R 7	Interior EDID 7 name read

Write EDID (EEPROM)	1	ATM 09 EDI_EEP W 1	09 EDI_EEP W 1	Write EDID of the RAM into the EEPROM 1
	2	ATM 09 EDI_EEP W 2	09 EDI_EEP W 2	Write EDID of the RAM into the EEPROM 2
	3	ATM 09 EDI_EEP W 3	09 EDI_EEP W 3	Write EDID of the RAM into the EEPROM 3
	4	ATM 09 EDI_EEP W 4	09 EDI_EEP W 4	Write EDID of the RAM into the EEPROM 4
	5	ATM 09 EDI_EEP W 5	09 EDI_EEP W 5	Write EDID of the RAM into the EEPROM 5
	6	ATM 09 EDI_EEP W 6	09 EDI_EEP W 6	Write EDID of the RAM into the EEPROM 6
	7	ATM 09 EDI_EEP W 7	09 EDI_EEP W 7	Write EDID of the RAM into the EEPROM 7

Read EDID (EEPROM)	1	ATM 09 EDI_EEP R 1		Read EDID of the EEPROM 1
	2	ATM 09 EDI_EEP R 2		Read EDID of the EEPROM 2
	3	ATM 09 EDI_EEP R 3		Read EDID of the EEPROM 3
	4	ATM 09 EDI_EEP R 4		Read EDID of the EEPROM 4
	5	ATM 09 EDI_EEP R 5		Read EDID of the EEPROM 5
	6	ATM 09 EDI_EEP R 6		Read EDID of the EEPROM 6
	7	ATM 09 EDI_EEP R 7		Read EDID of the EEPROM 7

Copy Preset EDID to Port_1	1	ATM 0B EDI_POR W 1 C 1	0B EDI_POR W 1 C 1	Copy the preset EDID 1 in the program to port 1
	2	ATM 0B EDI_POR W 1 C 2	0B EDI_POR W 1 C 2	Copy the preset EDID 2 in the program to port 1
	3	ATM 0B EDI_POR W 1 C 3	0B EDI_POR W 1 C 3	Copy the preset EDID 3 in the program to port 1
	4	ATM 0B EDI_POR W 1 C 4	0B EDI_POR W 1 C 4	Copy the preset EDID 4 in the

				program to port 1
	5	ATM 0B EDI_POR W 1 C 5	0B EDI_POR W 1 C 5	Copy the preset EDID 5 in the program to port 1
	6	ATM 0B EDI_POR W 1 C 6	0B EDI_POR W 1 C 6	Copy the preset EDID 6 in the program to port 1

Copy EEPROM EDID to Port_1	1	ATM 0B EDI_POR W 1 E 1	0B EDI_POR W 1 E 1	Copy the EDID of the EEPROM 1 to port 1
	2	ATM 0B EDI_POR W 1 E 2	0B EDI_POR W 1 E 2	Copy the EDID of the EEPROM 2 to port 1
	3	ATM 0B EDI_POR W 1 E 3	0B EDI_POR W 1 E 3	Copy the EDID of the EEPROM 3 to port 1
	4	ATM 0B EDI_POR W 1 E 4	0B EDI_POR W 1 E 4	Copy the EDID of the EEPROM 4 to port 1
	5	ATM 0B EDI_POR W 1 E 5	0B EDI_POR W 1 E 5	Copy the EDID of the EEPROM 5 to port 1
	6	ATM 0B EDI_POR W 1 E 6	0B EDI_POR W 1 E 6	Copy the EDID of the EEPROM 6 to port 1
	7	ATM 0B EDI_POR W 1 E 7	0B EDI_POR W 1 E 7	Copy the EDID of the EEPROM 7 to port 1

Copy Preset EDID to Port_2	1	ATM 0B EDI_POR W 2 C 1	0B EDI_POR W 2 C 1	Copy the preset EDID 1 in the program to port 2
	2	ATM 0B EDI_POR W 2 C 2	0B EDI_POR W 2 C 2	Copy the preset EDID 2 in the program to port 2
	3	ATM 0B EDI_POR W 2 C 3	0B EDI_POR W 2 C 3	Copy the preset EDID 3 in the program to port 2
	4	ATM 0B EDI_POR W 2 C 4	0B EDI_POR W 2 C 4	Copy the preset EDID 4 in the program to port 2
	5	ATM 0B EDI_POR W 2 C 5	0B EDI_POR W 2 C 5	Copy the preset EDID 5 in the program to port 2
	6	ATM 0B EDI_POR W 2 C 6	0B EDI_POR W 2 C 6	Copy the preset EDID 6 in the program to port 2

Copy EEPROM EDID to Port_2	1	ATM 0B EDI_POR W 2 E 1	0B EDI_POR W 2 E 1	Copy the EDID of the EEPROM 1 to port 2
	2	ATM 0B EDI_POR W 2 E 2	0B EDI_POR W 2 E 2	Copy the EDID of the EEPROM 2 to port 2
	3	ATM 0B EDI_POR W 2 E 3	0B EDI_POR W 2 E 3	Copy the EDID of the EEPROM 3 to port 2
	4	ATM 0B EDI_POR W 2 E 4	0B EDI_POR W 2 E 4	Copy the EDID of the EEPROM 4 to port 2
	5	ATM 0B EDI_POR W 2 E 5	0B EDI_POR W 2 E 5	Copy the EDID of the EEPROM 5 to port 2

	6	ATM 0B EDI_POR W 2 E 6	0B EDI_POR W 2 E 6	Copy the EDID of the EEPROM 6 to port 2
	7	ATM 0B EDI_POR W 2 E 7	0B EDI_POR W 2 E 7	Copy the EDID of the EEPROM 7 to port 2

Copy Preset EDID to Port_3	1	ATM 0B EDI_POR W 3 C 1	0B EDI_POR W 3 C 1	Copy the preset EDID 1 in the program to port 3
	2	ATM 0B EDI_POR W 3 C 2	0B EDI_POR W 3 C 2	Copy the preset EDID 2 in the program to port 3
	3	ATM 0B EDI_POR W 3 C 3	0B EDI_POR W 3 C 3	Copy the preset EDID 3 in the program to port 3
	4	ATM 0B EDI_POR W 3 C 4	0B EDI_POR W 3 C 4	Copy the preset EDID 4 in the program to port 3
	5	ATM 0B EDI_POR W 3 C 5	0B EDI_POR W 3 C 5	Copy the preset EDID 5 in the program to port 3
	6	ATM 0B EDI_POR W 3 C 6	0B EDI_POR W 3 C 6	Copy the preset EDID 6 in the program to port 3

Copy EEPROM EDID to Port_3	1	ATM 0B EDI_POR W 3 E 1	0B EDI_POR W 3 E 1	Copy the EDID of the EEPROM 1 to port 3
	2	ATM 0B EDI_POR W 3 E 2	0B EDI_POR W 3 E 2	Copy the EDID of the EEPROM 2 to port 3
	3	ATM 0B EDI_POR W 3 E 3	0B EDI_POR W 3 E 3	Copy the EDID of the EEPROM 3 to port 3
	4	ATM 0B EDI_POR W 3 E 4	0B EDI_POR W 3 E 4	Copy the EDID of the EEPROM 4 to port 3
	5	ATM 0B EDI_POR W 3 E 5	0B EDI_POR W 3 E 5	Copy the EDID of the EEPROM 5 to port 3
	6	ATM 0B EDI_POR W 3 E 6	0B EDI_POR W 3 E 6	Copy the EDID of the EEPROM 6 to port 3
	7	ATM 0B EDI_POR W 3 E 7	0B EDI_POR W 3 E 7	Copy the EDID of the EEPROM 7 to port 3

Copy Preset EDID to Port_4	1	ATM 0B EDI_POR W 4 C 1	0B EDI_POR W 4 C 1	Copy the preset EDID 1 in the program to port 4
	2	ATM 0B EDI_POR W 4 C 2	0B EDI_POR W 4 C 2	Copy the preset EDID 2 in the program to port 4
	3	ATM 0B EDI_POR W 4 C 3	0B EDI_POR W 4 C 3	Copy the preset EDID 3 in the program to port 4
	4	ATM 0B EDI_POR W 4 C 4	0B EDI_POR W 4 C 4	Copy the preset EDID 4 in the program to port 4
	5	ATM 0B EDI_POR W 4 C 5	0B EDI_POR W 4 C 5	Copy the preset EDID 5 in the program to port 4
	6	ATM 0B EDI_POR W 4 C 6	0B EDI_POR W 4 C 6	Copy the preset EDID 6 in the

				program to port 4
--	--	--	--	-------------------

Copy EEPROM EDID to Port_4	1	ATM 0B EDI_POR W 4 E 1	0B EDI_POR W 4 E 1	Copy the EDID in the EEPROM 1 to port 4
	2	ATM 0B EDI_POR W 4 E 2	0B EDI_POR W 4 E 2	Copy the EDID in the EEPROM 2 to port 4
	3	ATM 0B EDI_POR W 4 E 3	0B EDI_POR W 4 E 3	Copy the EDID in the EEPROM 3 to port 4
	4	ATM 0B EDI_POR W 4 E 4	0B EDI_POR W 4 E 4	Copy the EDID in the EEPROM 4 to port 4
	5	ATM 0B EDI_POR W 4 E 5	0B EDI_POR W 4 E 5	Copy the EDID in the EEPROM 5 to port 4
	6	ATM 0B EDI_POR W 4 E 6	0B EDI_POR W 4 E 6	Copy the EDID in the EEPROM 6 to port 4
	7	ATM 0B EDI_POR W 4 E 7	0B EDI_POR W 4 E 7	Copy the EDID in the EEPROM 7 to port 4

Copy Preset EDID to Port_5	1	ATM 0B EDI_POR W 5 C 1	0B EDI_POR W 5 C 1	Copy the preset EDID 1 in the program to port 5
	2	ATM 0B EDI_POR W 5 C 2	0B EDI_POR W 5 C 2	Copy the preset EDID 2 in the program to port 5
	3	ATM 0B EDI_POR W 5 C 3	0B EDI_POR W 5 C 3	Copy the preset EDID 3 in the program to port 5
	4	ATM 0B EDI_POR W 5 C 4	0B EDI_POR W 5 C 4	Copy the preset EDID 4 in the program to port 5
	5	ATM 0B EDI_POR W 5 C 5	0B EDI_POR W 5 C 5	Copy the preset EDID 5 in the program to port 5
	6	ATM 0B EDI_POR W 5 C 6	0B EDI_POR W 5 C 6	Copy the preset EDID 6 in the program to port 5

Copy EEPROM EDID to Port_5	1	ATM 0B EDI_POR W 5 E 1	0B EDI_POR W 5 E 1	Copy the EDID of the EEPROM 1 to port 5
	2	ATM 0B EDI_POR W 5 E 2	0B EDI_POR W 5 E 2	Copy the EDID of the EEPROM 2 to port 5
	3	ATM 0B EDI_POR W 5 E 3	0B EDI_POR W 5 E 3	Copy the EDID of the EEPROM 3 to port 5
	4	ATM 0B EDI_POR W 5 E 4	0B EDI_POR W 5 E 4	Copy the EDID of the EEPROM 4 to port 5
	5	ATM 0B EDI_POR W 5 E 5	0B EDI_POR W 5 E 5	Copy the EDID of the EEPROM 5 to port 5
	6	ATM 0B EDI_POR W 5 E 6	0B EDI_POR W 5 E 6	Copy the EDID of the EEPROM 6 to port 5
	7	ATM 0B EDI_POR W 5 E 7	0B EDI_POR W 5 E 7	Copy the EDID of the EEPROM 7 to port 5

Copy Preset EDID to Port_6	1	ATM 0B EDI_POR W 6 C 1	0B EDI_POR W 6 C 1	Copy the preset EDID 1 in the program to port 6
	2	ATM 0B EDI_POR W 6 C 2	0B EDI_POR W 6 C 2	Copy the preset EDID 2 in the program to port 6
	3	ATM 0B EDI_POR W 6 C 3	0B EDI_POR W 6 C 3	Copy the preset EDID 3 in the program to port 6
	4	ATM 0B EDI_POR W 6 C 4	0B EDI_POR W 6 C 4	Copy the preset EDID 4 in the program to port 6
	5	ATM 0B EDI_POR W 6 C 5	0B EDI_POR W 6 C 5	Copy the preset EDID 5 in the program to port 6
	6	ATM 0B EDI_POR W 6 C 5	0B EDI_POR W 6 C 6	Copy the preset EDID 6 in the program to port 6

Copy EEPROM EDID to Port_6	1	ATM 0B EDI_POR W 6 E 1	0B EDI_POR W 6 E 1	Copy the EDID of the EEPROM 1 to port 6
	2	ATM 0B EDI_POR W 6 E 2	0B EDI_POR W 6 E 2	Copy the EDID of the EEPROM 2 to port 6
	3	ATM 0B EDI_POR W 6 E 3	0B EDI_POR W 6 E 3	Copy the EDID of the EEPROM 3 to port 6
	4	ATM 0B EDI_POR W 6 E 4	0B EDI_POR W 6 E 4	Copy the EDID of the EEPROM 4 to port 6
	5	ATM 0B EDI_POR W 6 E 5	0B EDI_POR W 6 E 5	Copy the EDID of the EEPROM 5 to port 6
	6	ATM 0B EDI_POR W 6 E 6	0B EDI_POR W 6 E 6	Copy the EDID of the EEPROM 6 to port 6
	7	ATM 0B EDI_POR W 6 E 7	0B EDI_POR W 6 E 7	Copy the EDID of the EEPROM 7 to port 6

Copy Preset EDID to Port_7	1	ATM 0B EDI_POR W 7 C 1	0B EDI_POR W 7 C 1	Copy the preset EDID 1 in the program to port 7
	2	ATM 0B EDI_POR W 7 C 2	0B EDI_POR W 7 C 2	Copy the preset EDID 2 in the program to port 7
	3	ATM 0B EDI_POR W 7 C 3	0B EDI_POR W 7 C 3	Copy the preset EDID 3 in the program to port 7
	4	ATM 0B EDI_POR W 7 C 4	0B EDI_POR W 7 C 4	Copy the preset EDID 4 in the program to port 7
	5	ATM 0B EDI_POR W 7 C 5	0B EDI_POR W 7 C 5	Copy the preset EDID 5 in the program to port 7
	6	ATM 0B EDI_POR W 7 C 6	0B EDI_POR W 7 C 6	Copy the preset EDID 6 in the program to port 7

Copy EEPROM	1	ATM 0B EDI_POR W 7 E 1	0B EDI_POR W 7 E 1	Copy the EDID of the EEPROM 1 to port 7
----------------	---	------------------------	--------------------	---

EDID to Port_7	2	ATM 0B EDI_POR W 7 E 2	0B EDI_POR W 7 E 2	Copy the EDID of the EEPROM 2 to port 7
	3	ATM 0B EDI_POR W 7 E 3	0B EDI_POR W 7 E 3	Copy the EDID of the EEPROM 3 to port 7
	4	ATM 0B EDI_POR W 7 E 4	0B EDI_POR W 7 E 4	Copy the EDID of the EEPROM 4 to port 7
	5	ATM 0B EDI_POR W 7 E 5	0B EDI_POR W 7 E 5	Copy the EDID of the EEPROM 5 to port 7
	6	ATM 0B EDI_POR W 7 E 6	0B EDI_POR W 7 E 6	Copy the EDID of the EEPROM 6 to port 7
	7	ATM 0B EDI_POR W 7 E 7	0B EDI_POR W 7 E 7	Copy the EDID of the EEPROM 7 to port 7

Read EDID from Port	Read EDID of input#1	ATM 09 EDI_POR R 1	09 EDI_POR R 1	Read EDID from input port 1
	Read EDID of input#2	ATM 09 EDI_POR R 2	09 EDI_POR R 2	Read EDID from input port 2
	Read EDID of input#3	ATM 09 EDI_POR R 3	09 EDI_POR R 3	Read EDID from input port 3
	Read EDID of input#4	ATM 09 EDI_POR R 4	09 EDI_POR R 4	Read EDID from input port 4
	Read EDID of input#5	ATM 09 EDI_POR R 5	09 EDI_POR R 5	Read EDID from input port 5
	Read EDID of input#6	ATM 09 EDI_POR R 6	09 EDI_POR R 6	Read EDID from input port 6
	Read EDID of input#7	ATM 09 EDI_POR R 7	09 EDI_POR R 7	Read EDID from input port 7

EDID copy	Copy EDID from output#1 To Input#1	ATM 09 EDI_CPY 1 1	09 EDI_CPY 1 1	copy the EDID of output 1 and assigned it onto the input 1
	Copy EDID from output#1 To Input#2	ATM 09 EDI_CPY 1 2	09 EDI_CPY 1 2	copy the EDID of output 1 and assigned it onto the input 2
	Copy EDID from output#1 To Input#3	ATM 09 EDI_CPY 1 3	09 EDI_CPY 1 3	copy the EDID of output 1 and assigned it onto the input 3
	Copy EDID from output#1 To Input#4	ATM 09 EDI_CPY 1 4	09 EDI_CPY 1 4	copy the EDID of output 1 and assigned it onto the input 4
	Copy EDID from output#1 To Input#5	ATM 09 EDI_CPY 1 5	09 EDI_CPY 1 5	copy the EDID of output 1 and assigned it onto the input 5
	Copy EDID from output#1 To Input#6	ATM 09 EDI_CPY 1 6	09 EDI_CPY 1 6	copy the EDID of output 1 and

output#1 To Input#1			assigned it onto the input 6
Copy EDID from output#1 To Input#1	ATM 09 EDI_CPY 1 7	09 EDI_CPY 1 7	copy the EDID of output 1 and assigned it onto the input 7

WEB Setting

The Switcher can be controlled via Web browser, which contains home screen, general settings and advanced settings. After the cables are connected (to LAN network and to your sources and display), the IP address is obtained as soon as you connect to LAN and will be able to see that on your Display OSD. Please punch in that IP address on your Web browser. You will see a GUI like below. And now the switcher can be controlled. For more information about how to obtain the IP address, see the chapter IP Setting above.

For example, the obtained IP address is 192.168.3.41 and port number is 23.

Input <http://192.168.3.41> in the address bar of the web browser.

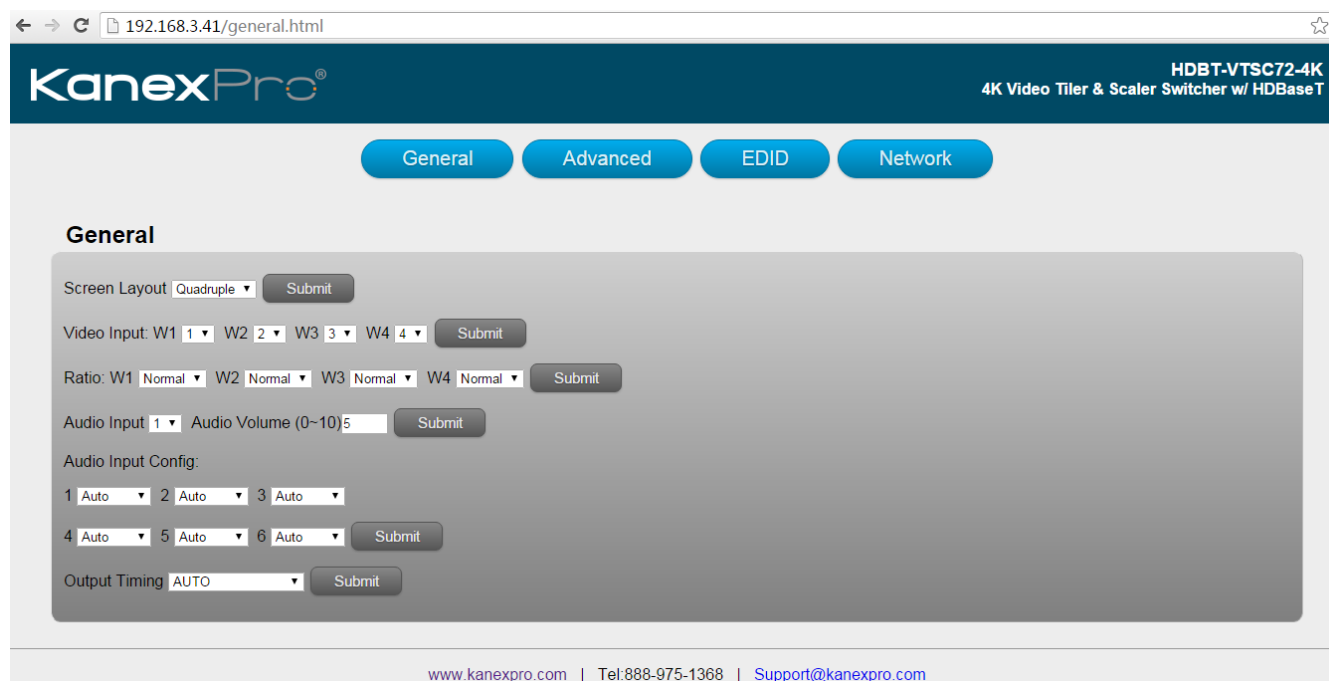

Click **General** and **Advanced** to access their pages.

General Settings

Contain the following options.

1. Screen Layout Selection
2. Video Input Selection
3. Layout/ Ratio
4. Audio Input Selection
5. Audio Volume Setting
6. Audio Input Config.
7. Output Timing

Screen Layout Selection

Single: single window; Double: double windows; TRIPLE: triple windows; Quadruple: quadruple windows.

Select the related parameters, and click **Submit** to make the changes take effect.

Video Input Selection

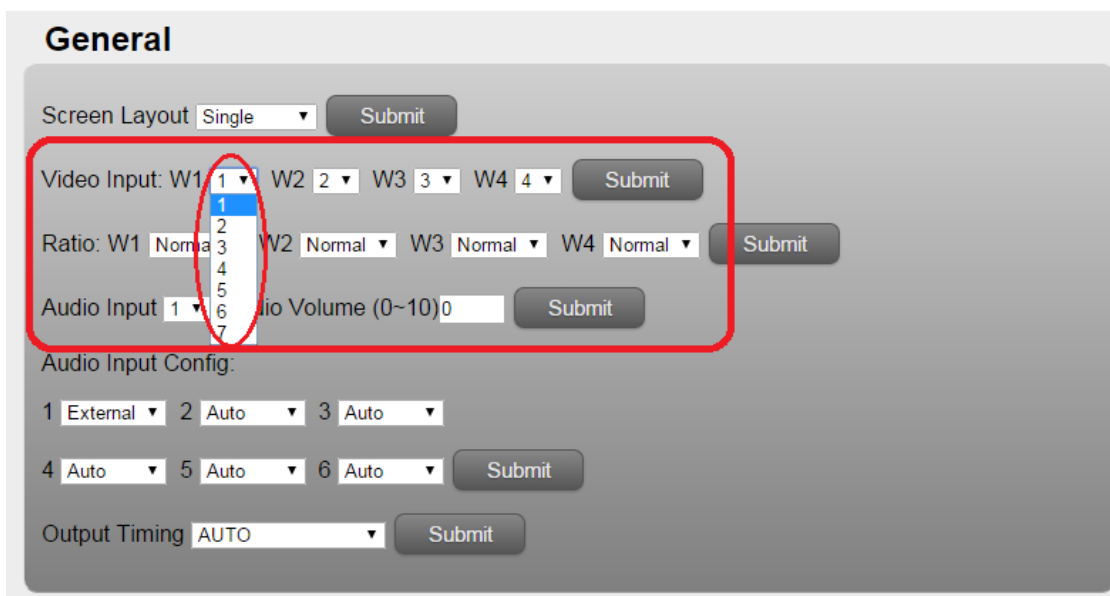

Video inputs W1~W4 correspond to the video inputs of the four windows. Video selection ranges from 1 to 7, corresponding to the seven video inputs. Select the related parameters, and click **Submit** to make the changes take effect.

Ration

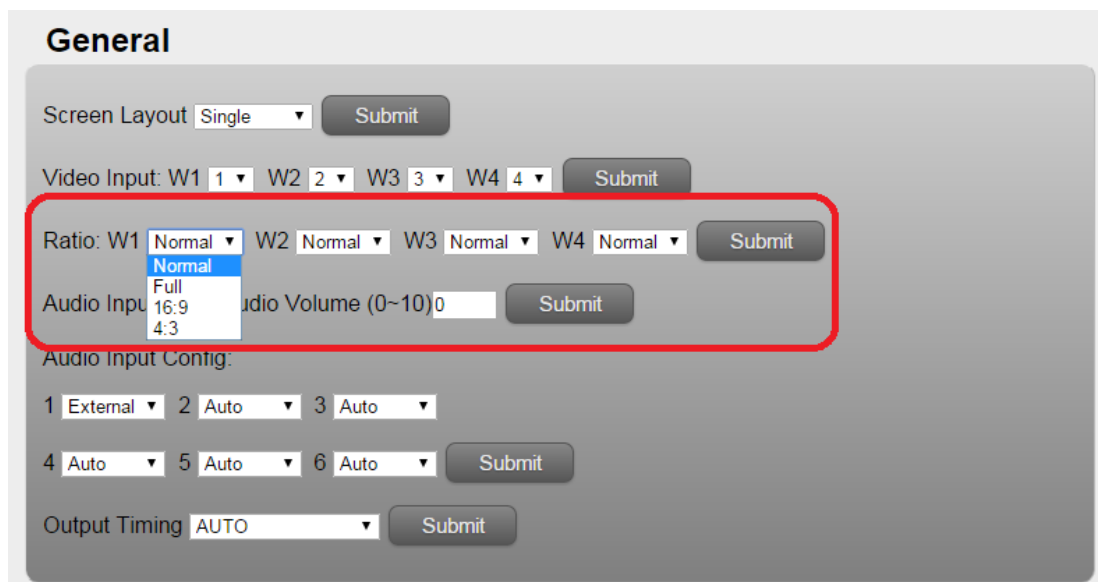

Normal: Set the picture in the window as the original aspect ratio

Full: Set the picture in the window to fill the entire window

16:9: Set the picture in Window 1 as the 16:9 aspect ratio

4:3: Set the picture in Window 1 as the 4:3 aspect ratio

Select the related parameters, and click **Submit** to make the changes take effect.

Audio Input

The screenshot shows the 'General' settings panel. The 'Audio Input' dropdown menu is open, showing options 1 through 7. A red box highlights the dropdown menu and the 'Submit' button next to the 'Audio Volume (0~10)' field.

Audio input selection ranges from 1 to 7, corresponding to the seven audio inputs. Select the related parameters, and click **Submit** to make the changes take effect.

Audio Volume:

The screenshot shows the 'General' settings panel. The 'Audio Volume (0~10)' field is highlighted with a red box, along with the 'Submit' button next to it.

Output volume ranges from 0 to 10. 0 is mute, and 10 is the maximum volume. Select the related parameters, and click **Submit** to make the changes take effect.

Output Timing:

HDMI output resolution selection: AUTO (auto adjustment of the output resolution based on the EDID of the display device), 4Kx2K@30Hz, 1920x1080@60Hz, 1280x720@60Hz, 1920x1200@60Hz, 1600x1200@60Hz, 1280x800@60Hz, and 1024x768@60Hz. Select the related parameters, and click **Submit** to make the changes take effect.

Advanced Settings

Contain the following options:

1. Power Switch Selection
2. Power Saving Selection
3. Audio Mute Selection
4. Audio Delay Selection
5. Auto Position Setting
6. Restore to default Setting
7. Series Baud rate
8. Audio OSD
9. Video OSD
10. FW version information

Power Switch Selection

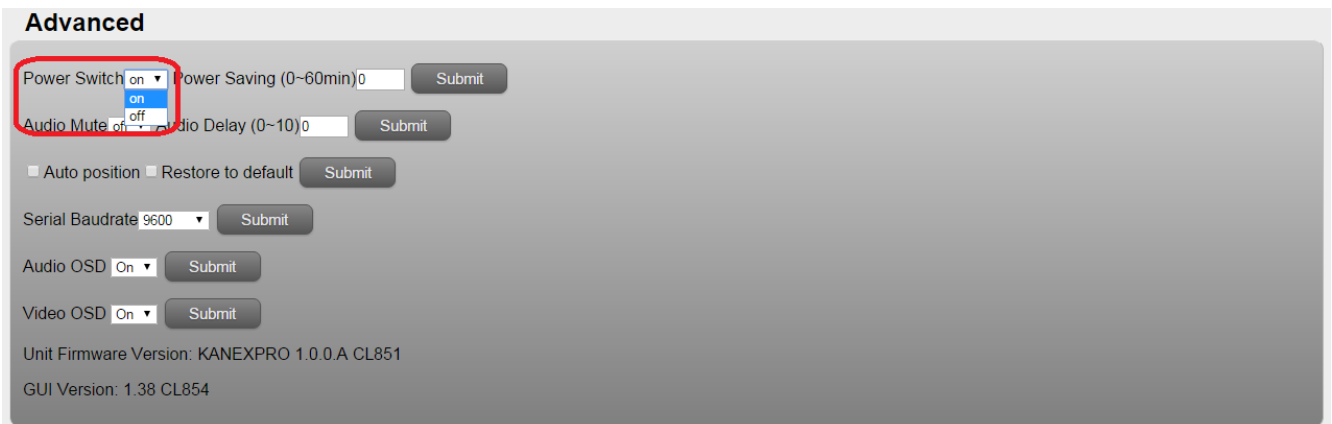

HDBT-VTSC72-4K's power management:

ON: When it's Power Off, set the device to power on.

When it's Power On, set the device to stand by.

Select the related parameters, and click **Submit** to make the changes take effect.

Power Saving Selection

Advanced

Power Switch Power Saving (0~60min)

Audio Mute Audio Delay (0~10)

Auto position Restore to default

Serial Baudrate

Audio OSD

Video OSD

Unit Firmware Version: KANEXPRO 1.0.0.A CL851
 GUI Version: 1.38 CL854

To save power, when no signal is input in all the windows, it enters the status of auto setting the standby time. Time options range from 0 min to 60 min. It's recommended that you use 0 min, 5 min, 10 min, 15 min, 30 min and 60 min. 0 is off, meaning turning off this function. Select the related parameters, and click **Submit** to make the changes take effect.

Audio Mute Selection

Advanced

Power Switch Power Saving (0~60min)

Audio Mute Audio Delay (0~10)

Auto position Restore to default

Serial Baudrate

Audio OSD

Video OSD

Unit Firmware Version: KANEXPRO 1.0.0.A CL851
 GUI Version: 1.38 CL854

Audio output mute setting. OFF is turning off mute, outputting the audio normally. On is enabling the mute without outputting the audio. At the same time, OSD prompts the related icons.



Select the related parameters, and click **Submit** to make the changes take effect.

Audio Delay Selection

Advanced

Power Switch Power Saving (0~60min)

Audio Mute **Audio Delay (0~10)**

Auto position Restore to default

Serial Baudrate

Audio OSD

Video OSD

Unit Firmware Version: KANEXPRO 1.0.0.A CL851
 GUI Version: 1.38 CL854

Audio output time-delay selection: 0~10. 0 is turning off the time-delay function. Select the related parameters, and click **Submit** to make the changes take effect.

Auto Position Setting

Advanced

Power Switch Power Saving (0~60min)

Audio Mute Audio Delay (0~10)

Auto position Restore to default

Serial Baudrate

Audio OSD

Video OSD

Unit Firmware Version: KANEXPRO 1.0.0.A CL851
 GUI Version: 1.38 CL854

When VGA is used as an input, perform this function to automatically adjust the VGA picture.

Adjustment parameters contain Horizontal Position, Vertical Position, Clock and Phase. At the same time, OSD prompts the related information (Auto Adjust). Click **Submit** to perform the settings.

Restore to default Setting

Advanced

Power Switch Power Saving (0~60min)

Audio Mute Audio Delay (0~10)

Auto position Restore to default

Serial Baudrate

Audio OSD

Video OSD

Unit Firmware Version: KANEXPRO 1.0.0.A CL851
GUI Version: 1.38 CL854

Restore to the factory default, and click **Submit** to perform the settings.

Serial Baud Rate Setting

Advanced

Power Switch Power Saving (0~60min)

Audio Mute Audio Delay (0~10)

Auto position Restore to default

Serial Baudrate

Audio OSD

Video OSD

Unit Firmware Version: KANEXPRO 1.0.0.A CL851
GUI Version: 1.38 CL854

For Serial Baud rate setting. It's recommended that you use 9600. Select the related parameters, and click **Submit** to make the changes take effect.

Audio OSD

Advanced

Power Switch Power Saving (0~60min)

Audio Mute Audio Delay (0~10)

Auto position Restore to default

Serial Baudrate

Audio OSD

Video OSD

Unit Firmware Version: KANEXPRO 1.0.0.A CL851
GUI Version: 1.38 CL854

For **Audio OSD**, select on/off and click **Submit** to make the changes take effect. It's possible to turn off all relative audio OSD, including Audio Mute, and Volume etc.

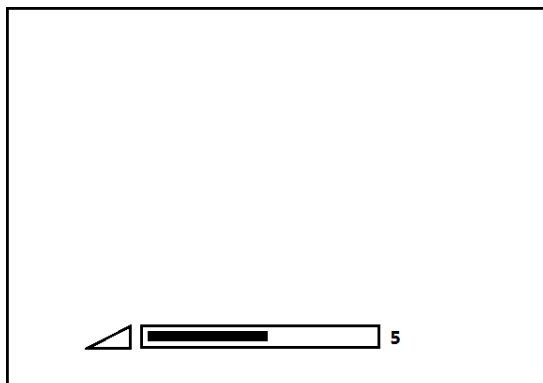

Video OSD

Advanced

Power Switch Power Saving (0~60min)

Audio Mute Audio Delay (0~10)

Auto position Restore to default

Serial Baudrate

Audio OSD

Video OSD

Unit Firmware sion: KANEXPRO 1.0.0.A CL851

GUI Version: 1.38 CL854

For **Video OSD**, select on/off and click **Submit** to make the changes take effect. It's used to turn off all relative video OSD, including source input, source resolution, signal indication, alert indication etc.

FW information

Advanced

Power Switch Power Saving (0~60min)

Audio Mute Audio Delay (0~10)

Auto position Restore to default

Serial Baudrate

Audio OSD

Video OSD

Unit Firmware Version: KANEXPRO 1.0.0.A CL851

GUI Version: 1.38 CL854

It includes the **Unit Firmware version** number, and the **Web GUI version** number.

EDID

General
Advanced
EDID
Network

EDID Management

EDID Copy:

Input Port1 [HDMI 1]: Copy EDID from

Input Port2 [HDMI 2]: Copy EDID from

Input Port3 [HDMI 3]: Copy EDID from

Input Port4 [HDMI 4]: Copy EDID from

Input Port5 [DP 5]: Copy EDID from

Input Port6 [DP 6]: Copy EDID from

Input Port7 [VGA]: Copy EDID from

EDID Upload:

Select EDID File to Upload (*.bin): No file chosen

Select Custom Location:

EDID Download:

Select an EDID file
(Right-click and save target / link as...)

Output:

Input:

Custom:

Contain the following options:

1. EDID Copy
2. EDID Upload
3. EDID Download

EDID Copy

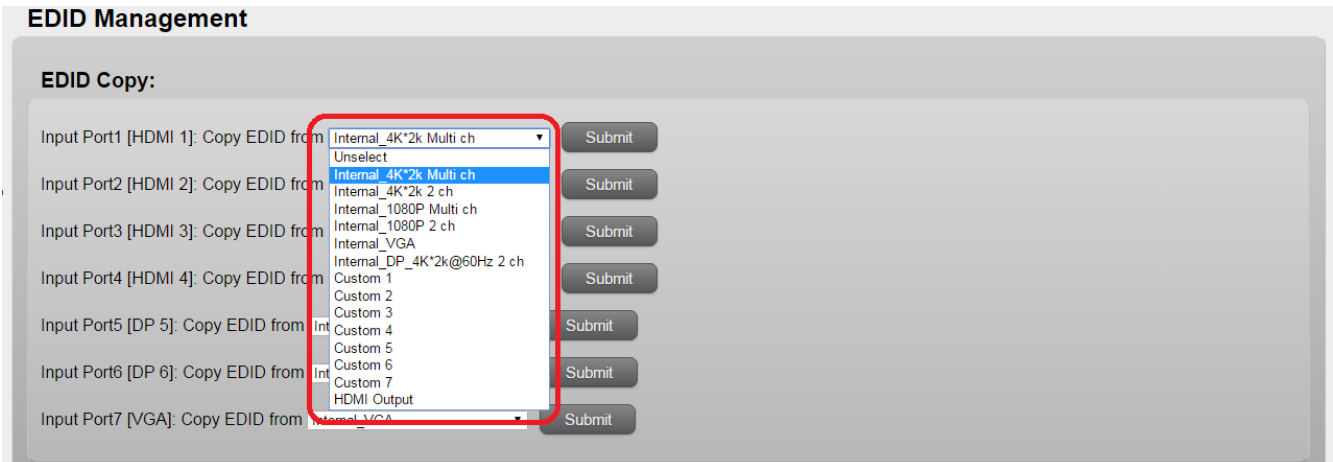

Select the EDID from six factory preset EDID package, seven custom EDID or HDMI output EDID for each input port, and click the **Submit** to take it into effect.

EDID Upload

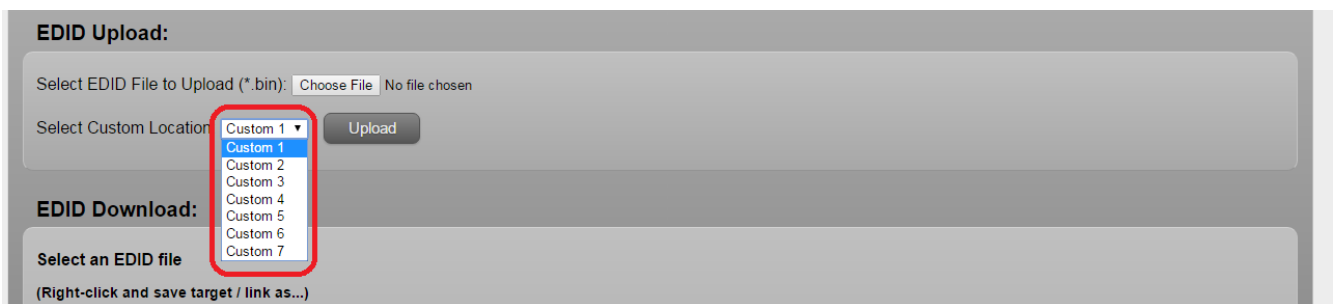

For **EDID Upload**, user could upload a prepared EDID file from local pc. Click the **Choose File** to find a certain EDID file from local PC and select which custom EDID package to upload it. Then click **Submit** to take into effect. Once upload the new EDID file to the same custom EDID package, the old EDID file will be replaced.

EDID Download



Right-click each button and click “save target/link as” to start download the relative stored EDID file, from EDID of HDMI Output (The connected display device), seven input EDID package, or seven custom EDID package.

Network

General Advanced EDID Network

Network Management

Network:

DHCP: Enabled

IP: 192.168.3.41 Mask: 255.255.255.0

Gate: 192.168.3.1 DNS: 106.186.126.126

Sockets:

Socket: TCP Auto

Port: 23

Others:

Network Settings Restore To Default

Contain the following options:

1. Network
2. Socket
3. Others: Network Default Setting

Network

Network:

DHCP: Enabled

IP: 192.168.3.41 Mask: 255.255.255.0

Gate: 192.168.3.1 DNS: 106.186.126.126

Select **DHCP enable** or **DHCP disable** (Static IP) and click the **Submit** to take into effect. When DHCP enable is submitted, the unit will be assigned an IP address from the connecting network. When DHCP display is submitted, user could enter an IP address.

Sockets

Sockets:

Socket: TCP Auto

Port: 23

Select TCP or UDP mode for the network communication, then click **Submit** to take into effect.

Others: Network Default Setting



Click **Reset** to restore all network setting to be factory default, as DHCP enable, and TCP Auto mode.

Other

Factory Reset Button

The Switcher can be set to factory default by the front panel button. The method is

- 1) Press and hold the input 5 button on the front panel
- 2) Press the “Standby” button to wake the unit from standby mode.
- 3) You’ll see all the front panel button LEDs blink to indicate the unit is being set to factory default.

F/W Update Guide

The Switcher can be updated through a USB drive as follows.

- 1) Copy the updating file “MERGE.bin” to the root directory of the USB drive.
- 2) Connect the USB drive to the USB port on the rear of the device.

Attention: The USB port can only support maximum 500ma. Please use a small power U-disk as upgrading USB drive.

- 3) Connect a HDMI display to the switcher.
- 4) Turn on the switcher. The display device displays the HDMI output signal after normal boot of the device.
- 5) Press and hold the INPUTS 1 button for more than five seconds, "System is upgrading..."is displayed in the display device, at the same time, all buttons indicators on the front panel blink.

Attention: The unit can't be power-off until the upgrading progress is finished. Or, the unit firmware will be corrupted.

- 6) After updating, “Upgrading is successful, system will reboot” is displayed in the display device. After seconds, the unit will reboot.
- 7) The unit reboots automatically.
- 8) Till now, the whole upgrading progress is finished.

Electrical Parameters

Specifications

Supported Formats

Resolutions (max.)	<ul style="list-style-type: none"> • 3840x2160 @30Hz (4K x 2K @30Hz)
--------------------	---

Electrical

Screen layout Select Buttons	<ul style="list-style-type: none"> • 4 x Tact-type, green backlight
Video Select Buttons	<ul style="list-style-type: none"> • 4 x Tact-type, green backlight
Inputs Select Buttons	<ul style="list-style-type: none"> • 7 x Tact-type, green backlight
Audio Select Button	<ul style="list-style-type: none"> • 1 x Tact-type, green backlight
Output Resolution Select Button	<ul style="list-style-type: none"> • 1 x Tact-type, green backlight
On / Standby Button	<ul style="list-style-type: none"> • 1 x Tact-type, green backlight
Output Resolution Indicators	<ul style="list-style-type: none"> • 8 x LED, green
Power Indicator	<ul style="list-style-type: none"> • 1 x LED, red

Connectors

Video Input	<ul style="list-style-type: none"> • 4 x HDMI Type A 19-pin, female, • 2 x DisplayPort (Full Size) 20-pin, female, • 1 x VGA DB-15 15-pin, female,
Video Output	<ul style="list-style-type: none"> • 1 x HDMI Type A 19-pin, female
Audio Input	<ul style="list-style-type: none"> • 7 x 3.5mm mini-stereo
Audio Output	<ul style="list-style-type: none"> • 4 x 3.5mm mini-stereo • 1 x Optical
RS-232	<ul style="list-style-type: none"> • 1 x DB-9, female
IP Control (LAN)	<ul style="list-style-type: none"> • 1 x RJ-45
USB (Reserve)	<ul style="list-style-type: none"> • Type A 4-pin, female
AC Power	<ul style="list-style-type: none"> • 1 x 110~240V AC 3-pin

Operational

Power Input	<ul style="list-style-type: none"> • 110~240V AC
Power Consumption	<ul style="list-style-type: none"> • 15W (max.)

Physical

Dimensions (W x H x D)	<ul style="list-style-type: none"> • 17.3" x 1.7" x 10.7" (440mm x 43.5mm x 272mm)
Unit Weight	<ul style="list-style-type: none"> • 7.3 lbs. (3.3 kg)

After-sales Service

If there appear some problems when running Compact Scaler Switcher, please check and deal with the problems referring to this user manual. Any transport costs are borne by the users during the warranty.

- 1) **Product Limited Warranty:** We warrants that its products will be free from defects in materials and workmanship for three years, which starts from the first day you buy this product (The purchase invoice shall prevail).

Proof of purchase in the form of a bill of sale or receipted invoice, which is evidence that the unit is within the Warranty period, must be presented to obtain warranty service.

2) What the warranty does not cover (servicing available for a fee):

- Warranty expiration.
- Factory applied serial number has been altered or removed from the product.
- Damage, deterioration or malfunction caused by:
 - Normal wear and tear
 - Use of supplies or parts not meeting our specifications
 - No certificate or invoice as the proof of warranty.
 - The product model showed on the warranty card does not match with the model of the product for repairing or had been altered.
- Damage caused by force majeure.
- Servicing not authorized.
- Any other causes which does not relate to a product defect
- Delivery, installation or labor charges for installation or setup of the product

3) Technical Support: Email to our after-sales department or make a call, please inform us the following information about your cases.

- Product version and name.
- Detailed failure situations.
- The formation of the cases.

Contact KanexPro directly at 888-975-1368 or email us at support@kanexpro.com.