

Grandstream Networks, Inc.

GVC3200/GVC3202

Video Conference System for Android™

User Guide



COPYRIGHT

©2017 Grandstream Networks, Inc. <http://www.grandstream.com>

All rights reserved. Information in this document is subject to change without notice. Reproduction or transmittal of the entire or any part, in any form or by any means, electronic or print, for any purpose without the express written permission of Grandstream Networks, Inc. is not permitted.

The latest electronic version of this guide is available for download here:

<http://www.grandstream.com/support>

Grandstream is a registered trademark and Grandstream logo is trademark of Grandstream Networks, Inc. in the United States, Europe and other countries.

CAUTION

Changes or modifications to this product not expressly approved by Grandstream, or operation of this product in any way other than as detailed by this guide, could void your manufacturer warranty.

WARNING

Please do not use a different power adaptor with devices as it may cause damage to the products and void the manufacturer warranty.



FCC Caution

Any Changes or modifications not expressly approved by the party responsible for compliance could void the user's authority to operate the equipment.

This device complies with part 15 of the FCC Rules. Operation is subject to the following two conditions: (1) This device may not cause harmful interference, and (2) this device must accept any interference received, including interference that may cause undesired operation.

Note: This equipment has been tested and found to comply with the limits for a Class B digital device, pursuant to part 15 of the FCC Rules. These limits are designed to provide reasonable protection against harmful interference in a residential installation. This equipment generates uses and can radiate radio frequency energy and, if not installed and used in accordance with the instructions, may cause harmful interference to radio communications. However, there is no guarantee that interference will not occur in a particular installation. If this equipment does cause harmful interference to radio or television reception, which can be determined by turning the equipment off and on, the user is encouraged to try to correct the interference by one or more of the following measures:

- Reorient or relocate the receiving antenna.
- Increase the separation between the equipment and receiver.
- Connect the equipment into an outlet on a circuit different from that to which the receiver is connected.
- Consult the dealer or an experienced radio/TV technician for help.

This transmitter must not be co-located or operating in conjunction with any other antenna or transmitter. For operation within 5.15 ~ 5.25GHz / 5.47 ~5.725GHz frequency range, it is restricted to indoor environment. The band from 5600-5650MHz will be disabled by the software during the manufacturing and cannot be changed by the end user. This device meets all the other requirements specified in Part 15E, Section 15.407 of the FCC Rules.

Radiation Exposure Statement:

This equipment complies with FCC radiation exposure limits set forth for an uncontrolled environment. This equipment should be installed and operated with minimum distance 20cm between the radiator & your body.



GNU GPL INFORMATION

GVC3200/GVC3202 firmware contains third-party software licensed under the GNU General Public License (GPL). Grandstream uses software under the specific terms of the GPL. Please see the GNU General Public License (GPL) for the exact terms and conditions of the license.

Grandstream GNU GPL related source code can be downloaded from Grandstream Web site from:
<http://www.grandstream.com/sites/default/files/Resources/gvc32xx-gpl.tar.gz>



Table of Contents

DOCUMENT PURPOSE	16
CHANGE LOG	17
Firmware Version 1.0.3.46	17
Firmware Version 1.0.3.45	17
Firmware Version 1.0.3.38	17
Firmware Version 1.0.3.24	17
Firmware Version 1.0.3.16	17
Firmware Version 1.0.3.8	18
Firmware Version 1.0.1.74	18
Firmware Version 1.0.1.65	18
Firmware Version 1.0.1.58	19
Firmware Version 1.0.1.48	19
Firmware Version 1.0.1.5	19
WELCOME	20
PRODUCT OVERVIEW	21
Safety Compliances	23
Warranty.....	23
INSTALLING GVC3200/GVC3202.....	24
Equipment Package Content	24
Connecting GVC3200/GVC3202	25
Connecting GAC2500 to GVC3200/GVC3202	31
GETTING TO KNOW GVC3200/GVC3202.....	32
Remote Control.....	32
<i>Remote Control Keys and Touchpad.....</i>	<i>32</i>
<i>Capturing Screenshot Using the Remote Control</i>	<i>35</i>
<i>Using the Remote Control</i>	<i>35</i>



Using Mouse & Keyboard	35
OLED Screen	36
Using the LED Indicator	37
Status Icons	37
Using the Onscreen Keyboard.....	38
<i>English Keyboard</i>	38
<i>Numbers and Symbols</i>	39
Home Screen	40
Screen Lock	40
CONNECTING TO NETWORK AND DEVICES	41
Ethernet	41
<i>Using IPv4</i>	41
<i>Using IPv6</i>	42
WI-FI (GVC3200 Only).....	42
<i>Turning WI-FI On / Off</i>	43
Bluetooth	43
<i>Pairing GVC3200/GVC3202 with a Bluetooth Device</i>	44
<i>Connecting to a Bluetooth Device</i>	44
<i>Using Bluetooth Remote Control</i>	45
<i>Transfer Files with Bluetooth</i>	47
<i>Using Bluetooth Headset</i>	47
VPN Settings.....	47
VLAN Settings.....	49
LLDP Settings	49
802.1X Mode.....	49
CAMERA	51
Preset.....	52
<i>Add Preset</i>	52
<i>Edit Preset</i>	52



<i>Delete Preset</i>	53
<i>Apply Preset</i>	53
<i>Initial Position</i>	53
Camera Parameters Configurations	54
PERIPHERAL	56
External USB Device	56
<i>Using USB Mouse/Keyboard</i>	56
<i>Using USB Storage Device</i>	56
SD Card	56
Microphone and Speaker	57
MAKING PHONE CALLS	58
Account	58
Dial Screen	58
<i>Dialing a Number Directly</i>	59
<i>Redial</i>	59
<i>Dialing a Number via Contact</i>	59
<i>Dialing a Number via Call History</i>	60
<i>Direct IP Call</i>	60
<i>Paging/Intercom</i>	61
Answering a Call	61
Call Hold	63
Mute Local Audio	63
Call Recording	63
DND (Do Not Disturb)	63
Missed Call	64
Call Forward	64
Conference	64
<i>Device Layout</i>	64
<i>Initiating Conference</i>	65



<i>Answering an Incoming Call in Conference</i>	65
<i>Conference Management</i>	65
<i>Invite Members to Conference</i>	69
<i>Removing Member from Conference</i>	69
<i>Conference Control</i>	69
<i>Pause Conference</i>	70
<i>Custom PIP</i>	70
<i>Presentation Sharing</i>	71
<i>Conference Recording</i>	72
<i>Participants List</i>	74
<i>Call Details</i>	74
<i>Enabling DND During Conference</i>	75
<i>Conference Lock</i>	75
<i>Open DTMF</i>	76
<i>PIN Code</i>	76
<i>Third Party Applications</i>	78
<i>FECC - Camera Control in Conference</i>	79
<i>End Conference</i>	79
<i>End Meeting Reminder</i>	80
<i>Power Off During a Conference Call</i>	80
Schedule	81
<i>View Conference Details</i>	82
<i>Add Scheduled Conference</i>	82
<i>Edit Scheduled Conference</i>	84
<i>Reschedule Conference</i>	84
<i>Delete Scheduled Conference</i>	84
Voicemail.....	84
Call Features.....	85
ADDITIONAL FUNCTIONS	88
GVC Remote Client Application	88



BlueJeans	90
APPLICATIONS	91
Contacts	91
<i>Add Contact</i>	92
<i>Search Contacts</i>	95
<i>Manage Contacts</i>	95
<i>Groups</i>	96
LDAP contacts	98
<i>LDAP Settings</i>	99
<i>Search LDAP Contacts</i>	103
<i>Add Search Result into Local Contacts</i>	103
Call History	105
<i>Add Contact from Call History</i>	106
<i>Delete Call History</i>	107
<i>Conference Schedule via Call History</i>	107
File Manager	107
<i>Copy File</i>	108
<i>Send File</i>	108
<i>Delete File</i>	108
<i>Rename File</i>	109
Recording	109
<i>Save Path</i>	110
Setup Wizard	110
Backup	112
<i>Backup Data</i>	112
<i>Restore Backup Data</i>	114
<i>Set Backup Path</i>	114
Diagnosis	114
Browser	115
Sync Local Schedule with Google Calendar	115



Custom App on Home Screen	121
Uninstall Application	122
GS MARKET.....	123
Search Apps.....	123
Download and Install Apps	123
Update Apps	123
IPVIDEOTALK	124
Contacts	124
Notices	126
Settings	128
Join an IPVideoTalk Meeting.....	129
Busy Tone Responses	130
Manually Start IPVideoTalk Tip	130
Hand Down/Up in IPVideoTalk Meeting.....	131
Share Local Camera	133
Stop Video Upload	134
Start Cloud Recording.....	134
GVC3200/GVC3202 WEB UI FEATURES.....	136
Accessing GVC3200/GVC3202 Web GUI	136
Saving Changes.....	137
Definitions	137
Toolbar	138
Call Page	138
<i>Making a Call</i>	139
<i>Conference Control</i>	139
Contacts Page	140
<i>Contacts</i>	140
<i>Groups</i>	142
<i>Schedule</i>	143



Call History 144

LDAP 144

Device Control Page 145

Video Control 145

Audio Control 145

FACTORY RESET 148

Reset via LCD 148

Reset via Web UI 149

Reset via Reset Hole 149

EXPERIENCING GVC3200/GVC3202 150



Table of Tables

Table 1: GVC3200/GVC3202 Technical Specifications.....	21
Table 2: GVC3200/GVC3202 Package List	24
Table 3: GVC3200/GVC3202 Front Panel	25
Table 4: GVC3200 Back Panel	26
Table 5: GVC3202 Back Panel	28
Table 6: GVC3200/GVC3202 Optional Equipment List	29
Table 7: GVC3200/GVC3202 Remote Control Keys	32
Table 8: GVC3200/GVC3202 OLED Screen Status Descriptions	36
Table 9: GVC3200/GVC3202 LED Indicator Status Descriptions	37
Table 10: GVC3200/GVC3202 Status Icons Descriptions	38
Table 11: GVC3200/GVC3202 VPN File Parameters	48
Table 12: GVC3200/GVC3202 VLAN Configuration Parameters	49
Table 13: GVC3200/GVC3202 LLDP Configuration Parameters.....	49
Table 14: GVC3200/GVC3202 802.1x Mode Parameters	50
Table 15: GVC3200/GVC3202 Camera Parameters	54
Table 16: GVC3200/GVC3202 Call Screen Bottom Menu Icons	66
Table 17: GVC3200/GVC3202 Conference Member Status Descriptions.....	68
Table 18: GVC3200/GVC3202 Add Conference Parameters	83
Table 19: GVC3200/GVC3202 Feature Code for SIP Account.....	85
Table 20: GVC3200/GVC3202 Import Contacts Parameters.....	93
Table 21: GVC3200/GVC3202 Download Contacts Parameters.....	94
Table 22: GVC3200/GVC3202 Export Contacts Parameters	96
Table 23: GVC3200/GVC3202 LDAP Settings Parameters.....	99
Table 24: GVC3200/GVC3202 Web Access	137
Table 25: GVC3200/GVC3202 Web UI - Audio Control Parameters	145



Table of Figures

Figure 1: GVC3200/GVC3202 Front Panel.....	25
Figure 2: GVC3200 Back Panel.....	26
Figure 3: GVC3202 Back Panel.....	27
Figure 4: GVC3200 Back Panel Connection Diagram.....	30
Figure 5: Deploy GVC3200/GVC3202 with Other Devices.....	31
Figure 6: GVC3200/GVC3202 Remote Control.....	32
Figure 7: GVC3200/GVC3202 Top Status Bar Dropdown Menu.....	37
Figure 8: Soft Keyboard - English Input Method.....	39
Figure 9: English Input Method – Capslock.....	39
Figure 10: Soft Keyboard - Symbols and Numbers.....	39
Figure 11: Soft Keyboard - More Symbols and Numbers.....	39
Figure 12: GVC3200/GVC3202 Home Screen.....	40
Figure 13: Ethernet Settings.....	41
Figure 14: GVC3200 Add Wi-Fi Screen.....	43
Figure 15: GVC3200/GVC3202 Bluetooth - Paired Device.....	45
Figure 16: GVC3200/GVC3202 Add VPN Files Screen.....	47
Figure 17: GVC3200/GVC3202 VPN Validation Screen.....	48
Figure 18: GVC3200/GVC3202 Camera Screen.....	51
Figure 19: GVC3200/GVC3202 Add Preset Screen.....	52
Figure 20: Initial Position.....	53
Figure 21: GVC3200/GVC3202 Camera Parameters Setting Screen.....	54
Figure 22: GVC3200/GVC3202 SIP Account.....	58
Figure 23: GVC3200/GVC3202 Call Screen.....	58
Figure 24: GVC3200/GVC3202 Single Incoming Call Screen.....	61
Figure 25: GVC3200/GVC3202 Single Incoming H.323 Call Screen.....	62
Figure 26: GVC3200/GVC3202 New Incoming Call Screen.....	62
Figure 27: GVC3200/GVC3202 3-Way Conference.....	66
Figure 28: GVC3200/GVC3202 Conference Control Screen.....	69
Figure 29: Select Video Feed.....	70
Figure 30: Choose HDMI Output.....	71
Figure 31: GVC3200/GVC3202 3-Way Conference with Presentation.....	71
Figure 32 : Web UI Conference Recording.....	73
Figure 33: GVC3200/GVC3202 Participants List.....	74
Figure 34: GVC3200/GVC3202 Call Details Screen.....	75
Figure 35: GVC3200/GVC3202 Call Screen→More→PIN Code.....	76
Figure 36: Enter PIN Code to Lock Conference.....	77
Figure 37: Input PIN Code from DTMF to Join Conference.....	77
Figure 38: FECC – Remote Camera Control.....	79



Figure 39: End Conference	80
Figure 40: End Meeting Reminder	80
Figure 41: Power Off During a Call	81
Figure 42: GVC3200/GVC3202 Schedule Screen	81
Figure 43: GVC3200/GVC3202 Conference Details Screen	82
Figure 44: GVC3200/GVC3202 Add Conference Screen	82
Figure 45: GVC3200/GVC3202 Voice Mail Application	85
Figure 46: “GVC Remote” apk in GVC3200/GVC3202 LCD Menu→Settings→Status→Remote Control .	88
Figure 47: GVC3200/GVC3202 Remote Control Application on Android Device	89
Figure 48: GVC3200/GVC3202 Contacts Screen.....	91
Figure 49: GVC3200/GVC3202 Add New Contact Screen	92
Figure 50: GVC3200/GVC3202 Import Contacts Screen	93
Figure 51: GVC3200/GVC3202 Download Contacts Screen	94
Figure 52: GVC3200/GVC3202 Export Contacts Screen	96
Figure 53: GVC3200/GVC3202 Groups Screen	97
Figure 54: GVC3200/GVC3202 Add Group Screen	98
Figure 55: LDAP Contacts Interface	99
Figure 56: LDAP Settings Example in Web UI.....	102
Figure 57: Search LDAP Contacts	103
Figure 58: Add LDAP Search Result to Local Contacts.....	104
Figure 59: Batch Add LDAP Search Results to Local Contacts.....	104
Figure 60: GVC3200/GVC3202 Call History Screen	105
Figure 61: GVC3200/GVC3202 Call History Details.....	106
Figure 62: GVC3200/GVC3202 Add Contact Screen	107
Figure 63: GVC3200/GVC3202 Recording Screen	109
Figure 64: GVC3200/GVC3202 Default Save Path	110
Figure 65: Applications→Setup Wizard	111
Figure 66: Interface Detection.....	111
Figure 67: GVC3200/GVC3202 Backup App.....	112
Figure 68: GVC3200/GVC3202 Automatic Backup Screen	113
Figure 69: Backup Commonly Used Apps	113
Figure 70: GVC3200/GVC3202 Restore Backup Data Screen	114
Figure 71: GVC3200/GVC3202 Diagnosis Screen	115
Figure 72: LCD Menu→Settings→System→Accounts	116
Figure 73: Select the Google Account Used for Sign-In	117
Figure 74: Enable Calendar Sync for the Google Account	117
Figure 75: GVC3200/GVC3202 Schedule→Settings.....	118
Figure 76: Enable Google Account for Schedule and Set Sync Interval	118
Figure 77: Creating New Event in Google Calendar.....	119
Figure 78: Google Calendar Event Synced in Schedule	120
Figure 79: Set “Related Account” to Google Account	120
Figure 80: System→ Apps	121



Figure 81: Move App to SD card	122
Figure 82: Move App to Device Storage	122
Figure 83: GVC3200/GVC3202 GS Market.....	123
Figure 84: GVC3200/GVC3202 IPVideoTalk Application.....	124
Figure 85: IPVideoTalk Application→Enterprise Directory	125
Figure 86: IPVideoTalk Application→Enterprise Directory: Batch Call	126
Figure 87: IPVideoTalk Application→Notices.....	126
Figure 88: IPVideoTalk Application→Notices: Message Prompt	127
Figure 89: Message Indicator for IPVideoTalk Application.....	128
Figure 90: IPVideoTalk Account Settings	129
Figure 91: Manually start Scheduled Meeting.....	131
Figure 92: Reminder prompt for preparation before starting the webinar.....	131
Figure 93: Hand up - IPVideoTalk	132
Figure 94: Participants list.....	132
Figure 95: Hand down/IPVideotalk	132
Figure 96: Hand down by Host - IPVideoTalk.....	132
Figure 97: Require Webcam sharing	133
Figure 98: Sharing Camera Request	133
Figure 99: Stop Camera Sharing	134
Figure 100: Stop Video Uploading	134
Figure 101 : Start Cloud Recording	135
Figure 102 : Recording.....	135
Figure 103 : IPVideoTalk Recordings.....	135
Figure 104: GVC3200/GVC3202 Web GUI - Login	136
Figure 105: GVC3200/GVC3202 Web UI Tool Bar	138
Figure 106: GVC3200/GVC3202 Web UI - Call.....	138
Figure 107: GVC3200/GVC3202 Web UI - Conference Status	139
Figure 108: GVC3200/GVC3202 Web UI - Conference Control.....	140
Figure 109: GVC3200/GVC3202 Web UI - Contacts.....	141
Figure 110: GVC3200/GVC3202 Web UI - Groups	142
Figure 111: GVC3200/GVC3202 Web Page - Schedule.....	143
Figure 112: GVC3200/GVC3202 Web UI - Call History.....	144
Figure 113: GVC3200/GVC3202 Web UI - Video Control	145
Figure 114: Factory Reset via LCD	148
Figure 115: GVC3200/GVC3202 Web UI - Factory Reset.....	149
Figure 116: GVC3200/GVC3202 Web UI - Factory Reset Confirmation	149



DOCUMENT PURPOSE

This User Guide describes the basic concept and tasks necessary to use and configure your GVC3200/GVC3202. This document covers the topics of device installation, making basic conference calls and using basic call features.

To learn the advanced features and configurations, please visit <http://www.grandstream.com/support> to download the latest "GVC3200/GVC3202 Administration Guide".

This guide covers following topics:

- [Product Overview](#)
- [Installing GVC3200/GVC3202](#)
- [Getting to know GVC3200/GVC3202](#)
- [Connecting to Network and Devices](#)
- [Camera](#)
- [Peripheral](#)
- [Making Phone Calls](#)
- [Additional Functions](#)
- [Applications](#)
- [GS Market](#)
- [IPVideoTalk](#)
- [GVC3200/GVC3202 Web UI Features](#)
- [Factory Reset](#)
- [Experiencing GVC3200/GVC3202](#)



CHANGE LOG

This section documents significant changes from previous versions of GVC3200/GVC3202 user manuals. Only major new features or major document updates are listed here. Minor updates for corrections or editing are not documented here.

Firmware Version 1.0.3.46

- Optimized OPUS codec upstream performance.
- Added the option to check the Participants List on GVC320x during an IPVideoTalk meeting. Users could check all participants in the current IPVideoTalk meeting. [Participants List]

Firmware Version 1.0.3.45

- Added the prompt for IPVideoTalk Webinar preparation period before starting the meeting.
- Added the option to join back the existed meeting by one key. In this case, if the GVC320x leaves the meeting, the GVC320x could click to join back the meeting to continue/end the conference.

Firmware Version 1.0.3.38

- Added cloud recording control for IPVideoTalk meetings or webinars [Start Cloud Recording]
- Added an option to allow GVC to leave meeting itself when pressing "End" button [End Conference]
- Added a notification to inform users "The meeting will be ended in 5 minutes" during an IPVT meeting if the subscribed IPVT plan on GVC device is expiring [End Meeting Reminder]

Firmware Version 1.0.3.24

- Added support for GVC to receive, accept and reject request from IPVT WebRTC host to open GVC local camera to share video. [Share Local Camera]
- Added some commonly used apps on system backup settings page, such as scheduled meeting and camera preset. [Backup Commonly Used Apps]
- Added allowing users to choose the main feed in Custom PIP when GVC is connected to multiple monitors. [Custom PIP]

Firmware Version 1.0.3.16

- Added "Hand up/down" feature for IPVideoTalk conference. [Hand Down/Up in IPVideoTalk Meeting]
- Added support for user to power off the device immediately during a call. [Power Off During a Conference Call]
- Added option "Pause uploading" on configure control panel during an IPVideoTalk meeting. [Stop Video Upload]
- Added support for users to move apps to external SD card. [Move App to SD Card]



Firmware Version 1.0.3.8

- Added IPv6 support [Ethernet]
- Added conference preset setting for schedule [Add Scheduled Conference]
- Added interface detection in setup wizard [Setup Wizard]

Firmware Version 1.0.1.74

- Added support to join an IPVideoTalk meeting by dialing meeting ID or host IPVideoTalk ID. [Join an IPVideoTalk Meeting]
- Added prompt message for current IPVideoTalk plan is about to expire or already expired on GVC3200/GVC3202 LCD home screen or menu→Applications→IPVideoTalk application→Notices. [Notices]
- Updated size limitation of each recording file size from 1 G to 1.9 G. [Recording].
- Added support specific failed reasons prompt on dialing screen instead of SIP 486 busy error messages of IPVideoTalk calls [Busy Tone Responses]
- Added A tip for manually starting local scheduled IPVideoTalk meeting from GVC3200/GVC3202 LCD→Schedule page [Manually Start IPVideoTalk Tip]

Firmware Version 1.0.1.65

- Added ability to choose any configured preset as initial position in the drop-down menu in addition to “Default” and “Latest Position”. [Initial Position]
- Added an icon to indicate network unstable condition on the upper left of the call screen, which means current network condition is not good enough for the video call using the selected resolution/bit rate. [Status Icons]
- Added “Record” option on the call screen bottom menu. [GVC3200/GVC3202 Call Screen Bottom Menu Icons]
- Updated the default configurations for Call Recording feature. [Call Recording]
- Added support to record presentation shared by GVC3200/GVC3202 and IPVideoTalk WebRTC clients. [Conference Recording]
- Added recording files limitation that max size of each recording file on SD card or USB storage device is 1 G, GVC3200/GVC3202 will create a new file if size exceed 1 G. [recording size]
- Added Save Path options of Recording files on internal memory, external SD card or USB storage. [Save Path]
- Added video answer and audio answer options on GVC3200/GVC3202 to answer H.323 calls. [H.323]
- Updated the default configurations for IPVideoTalk Contacts. [Contacts]
- Added GVC3200/GVC3202 version control mechanism that IPVideoTalk account will work only if the firmware version is on 1.0.1.62 or later, and IPVideoTalk version information is under Settings.[IPVideoTalk version]



Firmware Version 1.0.1.58

- Added feature code. [Call Features]
- Added ability to view top status bar notifications. [Status Icons] [Figure 7: GVC3200/GVC3202 Top Status Bar Dropdown Menu]
- Added “optional” for step 2 “selecting call mode to IP Call” in making direct IP call from LCD dialing interface. The GVC3200/GVC3202 can dial direct IP as long as a valid format is entered without selecting mode to “IP Call”. [Direct IP Call]
- Added presentation mode “PC” and “Auto”. [Table 16: GVC3200/GVC3202 Call Screen Bottom Menu Icons]
- Added “Layout” option in the call screen bottom menu. [Table 16: GVC3200/GVC3202 Call Screen Bottom Menu Icons]
- Added video mixing feature for Skype downloaded from GS Market. [For Skype application downloaded from GS Market only]
- Added “View contact” option in the GVC3200/GVC3202 menu→Applications→Call History so that users can view contact details if the call history entry already exists in Contacts. [View contact]
- Added Screen Lock feature. [Screen Lock]
- Added support to sync local schedule with Google Calendar. [Sync Local Schedule with Google Calendar]

Firmware Version 1.0.1.48

- Separated Add Preset section and Edit Preset section. Edit Preset section has renamed preset information added. [Add Preset] [Edit Preset]
- Added PIN Code support during conference. [PIN Code]
- Added FECC support during conference. [FECC - Camera Control in Conference]
- Added LDAP contacts support. [LDAP contacts]
- Added options “PIN Code”, “Auto Join Conference for Scheduled Members without PIN Code” and “Repeat” for Schedule. Removed options “Auto Answer for Conference Members” and “Lock” for Schedule. [Schedule] [Schedule]
- Added IPVideoTalk Application. [IPVIDEOTALK]
- Updated Audio Priority information for connected audio devices. [Microphone and Speaker]

Firmware Version 1.0.1.5

- This is the initial version.



WELCOME

Thank you for purchasing Grandstream GVC3200/GVC3202 Android™ Video Conferencing System. This document introduces the LCD settings, web UI settings and advanced configurations of GVC3200/GVC3202. To learn the basic configuration and how to use GVC3200/GVC3202, please visit <http://www.grandstream.com/support> to download the latest "GVC3200/GVC3202 User Guide".

GVC3200/GVC3202 is a ground-breaking solution that offers small-to-medium businesses a revolutionary video conferencing system with unprecedented flexibility and the power of support for multiple popular video conferencing protocols and platforms right out of the box. The SIP-based GVC3200/GVC3202 supports Grandstream's robust IPVideoTalk cloud platform for plug and play video conferencing while also being interoperable with any 3rd party SIP video conferencing platform - thus offering a great option to expand or implement a 3rd party platform. Additionally, since it is based on Android™ 4.4, the GVC3200/GVC3202 offers full access to all video conferencing apps in the Google™ Play Store.

The GVC3200/GVC3202 sports an innovative, patent-pending embedded MCU that supports conferencing with local mixing between SIP, H.323 and Android applications (e.g. Skype, Google Hangouts):

- The GVC3200 supports 9-way conferencing with local mixing between SIP, H.323 and Android applications (e.g. Skype, Google Hangouts).
- The GVC3202 supports 3-way conferencing with local mixing between SIP, H.323 and Android applications (e.g. Skype, Google Hangouts).

In comparison to Grandstream's GVC3200, the GVC3202 offers a slightly lower capacity option for businesses looking for up to 3-way video-conferencing and support for up to 2 Full HD monitors.

The GVC3200/GVC3202 eliminates the traditional barriers to video conferencing and sets a new bar for business-class video conferencing solutions by offering industry-leading flexibility, interoperability, system compatibility, application richness and ease of use.



PRODUCT OVERVIEW

Table 1: GVC3200/GVC3202 Technical Specifications

Specification	Description
Protocols/ Standards	SIP RFC3261, BFCP, TIP (pending), RTP/RTCP, HTTP/HTTPS, ARP, ICMP, DNS (A record, SRV, NAPTR), DHCP, PPPoE, SSH, TFTP, NTP, STUN, LLDP-MED, LDAP, TR-069, 802.1x, TLS, SRTP, TCP/IP/UDP, IPv6, FEC, FECC, H.323, Q.931, H.224, H.281, H.225.0, H.239, H.241, H.245, H.460.18 and H.460.19
Camera	1/3" 2 Megapixel CMOS 1920H x 1080V@30fps
Lens	GVC3200: 12 x optical zoom, +/-23° tilt, +/- 90° pan, 70°(W)*- 6.3° (T) field of view GVC3202: 9 x optical zoom, +/-23° tilt, +/- 90° pan, 70°(W)*- 6.3° (T) field of view
Network Interface	1 x RJ45 10/ 100/ 1000 Mbps port
Wi-Fi	GVC3200 only: Integrated dual-band 802.11 a/b/g/n (2.4GHz & 5GHz)
Bluetooth	Yes, integrated. Bluetooth 4.0 + EDR
Video Outputs	GVC3200: 3 x HDMI up to 1080p with CEC GVC3202: 2 x HDMI up to 1080p with CEC
Video Input	1 x VGA/1 x HDMI with resolution up to 1080p
Microphone/ Speaker	External MIC/Speaker, built-in MIC, cascadable external MIC/speaker (pending)
Remote Control	Bluetooth remote control with multi-touch touchpad
Auxiliary Ports	1 x USB 2.0, SD, external speaker port, reset pin
Graphic Display	OLED with 128x32 resolution
Voice Codecs	G.711μ/a, G.722 (wide-band), G.726-32, iLBC (pending), Opus, G.722.1, G.722.1c, in-band and out-of-band DTMF (In audio, RFC2833, SIP INFO)
Video Codecs	H.264 BP/MP/HP, H.323, video resolution up to 1080p, frame rate up to 30fps, bitrate up to 4Mbps
People Video Resolution	1080p from 512 Kbps, 720p from 384 Kbps, 4SIF/4CIF from 128 Kbps, SIF/CIF/QSIF/QCIF/SQSIF/SQCIF from 64 Kbps
Content Video Resolution	Input: VGA, SVGA, XGA, WXGA, WXGA, SXGA, 1440x900, 720p, 1600x1200, 1080p (HDMI), up to 60fps; Encoding: 1280x720, 1920x1080
Output Resolution	720p, 1080p
Embedded MCU	GVC3200: Up to 4-way 1080p conference, 5-way 720p conference, 9-way VGA conference GVC3202: Up to 2-way 1080p conference, 3-way 720p conference, 3-way VGA conference



Dual-Stream	BFCP, people video (up to 1080p@30fps) + content video (up to 1080p@15fps, 720p@30fps)
Audio Features	AEC, ANS, AGC, PLC, CNG/VAD
Video Features	FEC, dynamic display layout, picture-in-picture, picture-outside-picture, digital caption (pending)
Platform Bridging	Bridge SIP calls with any Android VoIP apps such as Skype, Skype for Business, Google Hangouts and more
Telephony Features	Hold, transfer, forward (unconditional/no-answer/busy), call park/pickup, 9-way audio/video conference for GVC3200 and 3-way audio/video conference for GVC3202, downloadable XML phone book, LDAP, call waiting, call history, flexible dial plan, personalized music ringtones, server redundancy & fail-over
Sample Applications	Skype, Google Hangouts, Skype for Business, Web browser, Facebook, Twitter, YouTube, Google calendar, mobile phone data import/export via Bluetooth, etc. API/SDK available for advanced custom application development
Application Deployment	Allows Android 4.4.2 compliant applications to be deployed in the device with provisioning control
QoS	Layer 2 QoS (802.1Q, 802.1p) and Layer 3 (ToS, DiffServ, MPLS) QoS
Security	User and administrator level passwords, MD5 and MD5-sess based authentication, 256-bit AES encrypted configuration file, TLS, 128/256-bit SRTP, HTTPS, 802.1x media access control
Multi-Language	English, German, Italian, French, Spanish, Portuguese, Russian, Turkish, Polish, Chinese, Korean, Japanese, and more
Upgrade/ Provisioning	Firmware upgrade via TFTP / HTTP / HTTPS or local HTTP upload, mass provisioning using TR-069 or AES encrypted XML configuration file
Power & Green Energy Efficiency	Universal power adapter included: Input 100-240VAC 50-60Hz; Output 12VDC/5A (60W)
Package Content	<p>- GVC3200: GVC3200 video conference system, external USB speaker/MIC (GAC2500), remote control, universal power supply, network cable (1.5 meters), USB extension cable (5 meters), mounting kit, 4 HDMI cables (one 1.5-meter cable, two 3-meter cables and one 5-meter cable), 2 AAA batteries, lens cover, quick installation guide, brochure, GPL license</p> <p>- GVC3202: GVC3202 video conference system, external USB speaker/MIC (GAC2500), remote control, universal power supply, network cable (1.5 meters), USB extension cable (5 meters), mounting kit, 3 HDMI cables (one 1.5-meter cable, one 3-meter cables and one 5-meter cable), 2 AAA batteries, lens cover, quick installation guide, brochure, GPL license</p>



Temperature and Humidity	Operation: 0°C to 40°C, Storage: -10°C to 60°C, Humidity: 10% to 90% Non-condensing
Compliance	FCC: Part 15 (CFR 47) Class B; UL 60950 (power adapter), Part 15C, Part 15E.407, Part 2.1091 CE: EN55022 Class B, EN55024, EN61000-3-2, EN61000-3-3, EN60950-1, EN62479, RoHS, EN301893, EN62311 RCM: AS/NZS CISPR22/24; AS/NZS 60950; AS/NZS 4268

Safety Compliances

GVC3200/GVC3202 complies with FCC/CE and various safety standards. GVC3200/GVC3202 power adapter is compliant with the UL standard. Use the universal power adapter provided with GVC3200/GVC3202 package only. The manufacturer's warranty does not cover damages to the device caused by unsupported power adapters.

Warranty

If GVC3200/GVC3202 is purchased from a reseller, please contact the company where the device is purchased for replacement, repair or refund. If the device is purchased directly from Grandstream, please contact Grandstream Support for a RMA (Return Materials Authorization) number before the product is returned. Grandstream reserves the right to remedy warranty policy without prior notification.



INSTALLING GVC3200/GVC3202

Equipment Package Content

GVC3200/GVC3202 package contains the following items:

Table 2: GVC3200/GVC3202 Package List

Name	For GVC3200	For GVC3202
GVC3200/GVC3202 Main Case	1	1
External USB Speakerphone (GAC2500)	1	1
Remote Control (a pair of AAA batteries)	1	1
12V Universal Power Adapter with power cable	1	1
1.5m Ethernet Cable	1	1
5m USB Extension Cable	1	1
1.5m HDMI Cable	1	1
3m HDMI Cable	2	1
5m HDMI Cable	1	1
Wall Mount Kit, including: Top bracket Bottom bracket Hook & Loop tape	1	1
Screws and bolts: 4 screws and 4 bolts to install bracket to the wall 2 screws to fix bracket 2 screws for bracket	12	12
Lens Cover	1	1
Lens Cleaning Cloth	1	1
Quick Installation Guide	1	1
GPL license	1	1



Connecting GVC3200/GVC3202

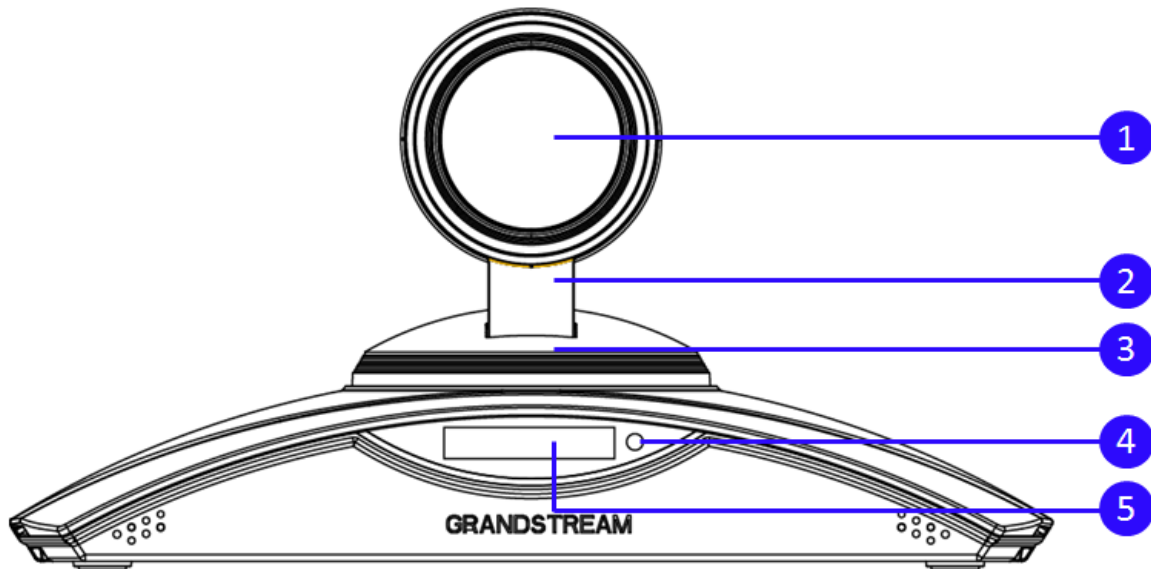

Figure 1: GVC3200/GVC3202 Front Panel

Table 3: GVC3200/GVC3202 Front Panel

NO.	Name	Explanation
1	Camera	70° (W)*- 6.3° (T) field of view
2	Vertical Rotating Stent	+/-23° tilt
3	Horizontal Rotating Platform	+/-90° pan
4	LED Indicator	Power on / Normal Running: Green Standby: Flash red Shutdown: Red Pressing any key on the remote control - Green light flashes once.
5	OLED Display	Graphic display with 128x32 resolution shows device status.

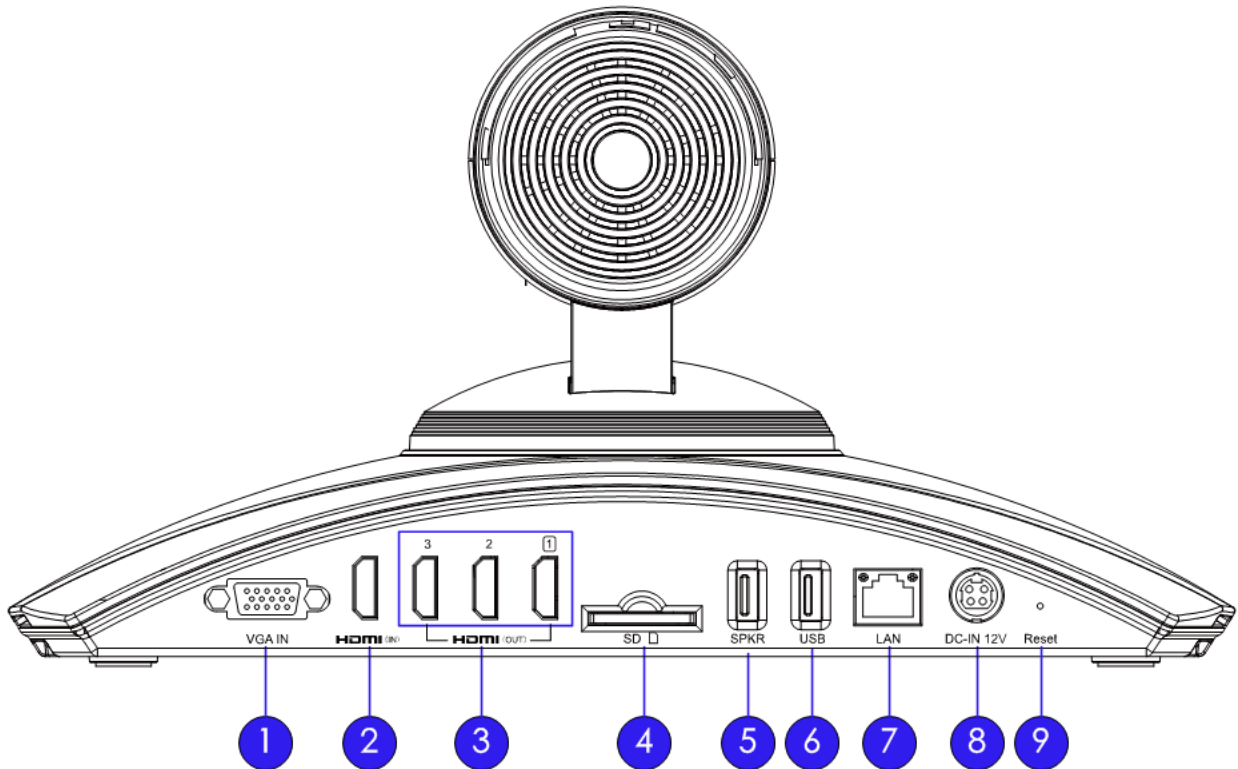

Figure 2: GVC3200 Back Panel

Table 4: GVC3200 Back Panel

NO.	Name	Explanation
1	VGA Input Interface	Connect to VGA input devices.
2	HDMI Input Interface	Connect to HDMI input devices. Note: The HDMI input interface has higher priority than the VGA interface when both interfaces are connected.
3	HDMI Output Interface	Connect to HDMI display devices. Note: There are 3 HDMI output ports. The interface marked with number "1" is the primary interface to output primary video. Please make sure to follow the port order when connecting HDMI port 1, 2 and 3. When there is only 1 HDMI output, it has to use HDMI output 1. Connect HDMI port 2 and then HDMI port 3 if you have additional display devices. GVC3200 will not work correctly if connecting HDMI port 2 or 3 without HDMI port 1 connected.
4	SD Card Slot	Insert SD card to store call recordings and other necessary files.

5	External USB Speaker/MIC Jack	Connect to external speakerphone.
6	USB Interface	Connect to USB cable or USB storage device.
7	Network Interface	Connect to LAN port.
8	Power Interface	Connect to power adapter. The arrow indicator on the power adapter should face upwards when the power adapter is plugged in.
9	Factory Restore	<ul style="list-style-type: none"> When GVC3200 is powered up, use a small pin to press the button one time to reboot. When powering up GVC3200, keep pressing the button with a small pin for more than 10 seconds to restore to factory settings.

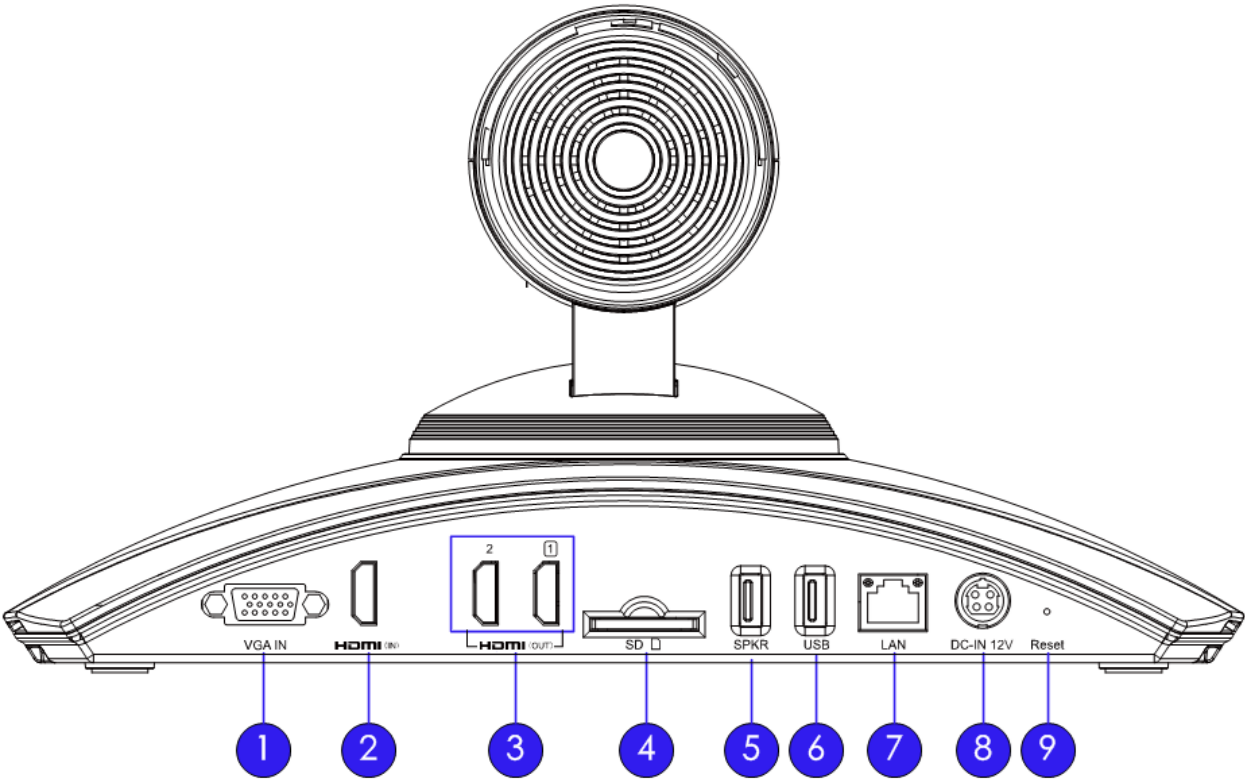

Figure 3: GVC3202 Back Panel

Table 5: GVC3202 Back Panel

NO.	Name	Explanation
1	VGA Input Interface	Connect to VGA input devices.
2	HDMI Input Interface	Connect to HDMI input devices. Note: The HDMI input interface has higher priority than the VGA interface when both interfaces are connected.
3	HDMI Output Interface	Connect to HDMI display devices. Note: There are 2 HDMI output ports. The interface marked with number "1" is the primary interface to output primary video. Please make sure to follow the port order when connecting HDMI port 1 and 2. When there is only 1 HDMI output, it has to use HDMI output 1. Connect HDMI port 2 if you have an additional display device. GVC3202 will not work correctly if connecting HDMI port 2 without HDMI port 1 connected.
4	SD Card Slot	Insert SD card to store call recordings and other necessary files.
5	External USB Speaker/MIC Jack	Connect to external speakerphone.
6	USB Interface	Connect to USB cable or USB storage device.
7	Network Interface	Connect to LAN port.
8	Power Interface	Connect to power adapter. The arrow indicator on the power adapter should face upwards when the power adapter is plugged in.
9	Factory Restore	<ul style="list-style-type: none"> When GVC3202 is powered up, use a small pin to press the button one time to reboot. When powering up GVC3202, keep pressing the button with a small pin for more than 10 seconds to restore to factory settings.

To deploy a working video conferencing system, it is recommended for the users to prepare the following equipment based on your own requirements. The following table is for reference only.



Table 6: GVC3200/GVC3202 Optional Equipment List

Device Name	Number	Explanation
HDMI Display Device	1 (minimum), 2 or 3 (supported on GVC3200)	To display video conference view, for example, high definition TV. The HDMI display device is connected to HDMI output interface 1/2 for GVC3202 or 1/2/3 for GVC3200.
VGA Input	Optional	For presentation
HDMI Input	Optional	For presentation If both HDMI input and VGA input are plugged in, HDMI input has higher priority, it means VGA input will not be displayed.
USB Mouse	Optional	It can be used to help navigate and operate the GVC3200/GVC3202 besides using remote control. For example, when viewing a web page, USB mouse can be used to control the cursor.
USB Keyboard	Optional	It can be used to help input characters when operating GVC3200/GVC3202 besides using remote control. For example, typing in username and password to log in Skype app installed on GVC3200/GVC3202.

Please connect GVC3200/GVC3202 according to the following procedures:

1. Connect the primary video output device (e.g., high-definition TV) to HDMI output interface 1 on GVC3200/GVC3202 with HDMI cable.
2. (Optional) Connect additional video output devices to HDMI output interface 2 and HDMI output interface 3 (supported on GVC3200) with HDMI cable.
3. Connect input device (e.g., a laptop or GXV3275) to GVC3200/GVC3202 VGA IN/HDMI IN port with VGA/HDMI cable.
4. Connect the external speakerphone GAC2500 to the USB speaker interface on GVC3200/GVC3202.
5. Connect to Ethernet or LAN with Ethernet cable for network access. It is recommended to use Gigabit network to assure audio and video quality of video conference.
6. Plug in the power adapter into the power supply interface to power up GVC3200/GVC3202.





Note:

For detailed instructions about installing GVC3200/GVC3202 on wall mount and etc., please refer to the GVC3200/GVC3202 quick installation guide on www.grandstream.com.

A sample of GVC3200 back panel connection is shown below:

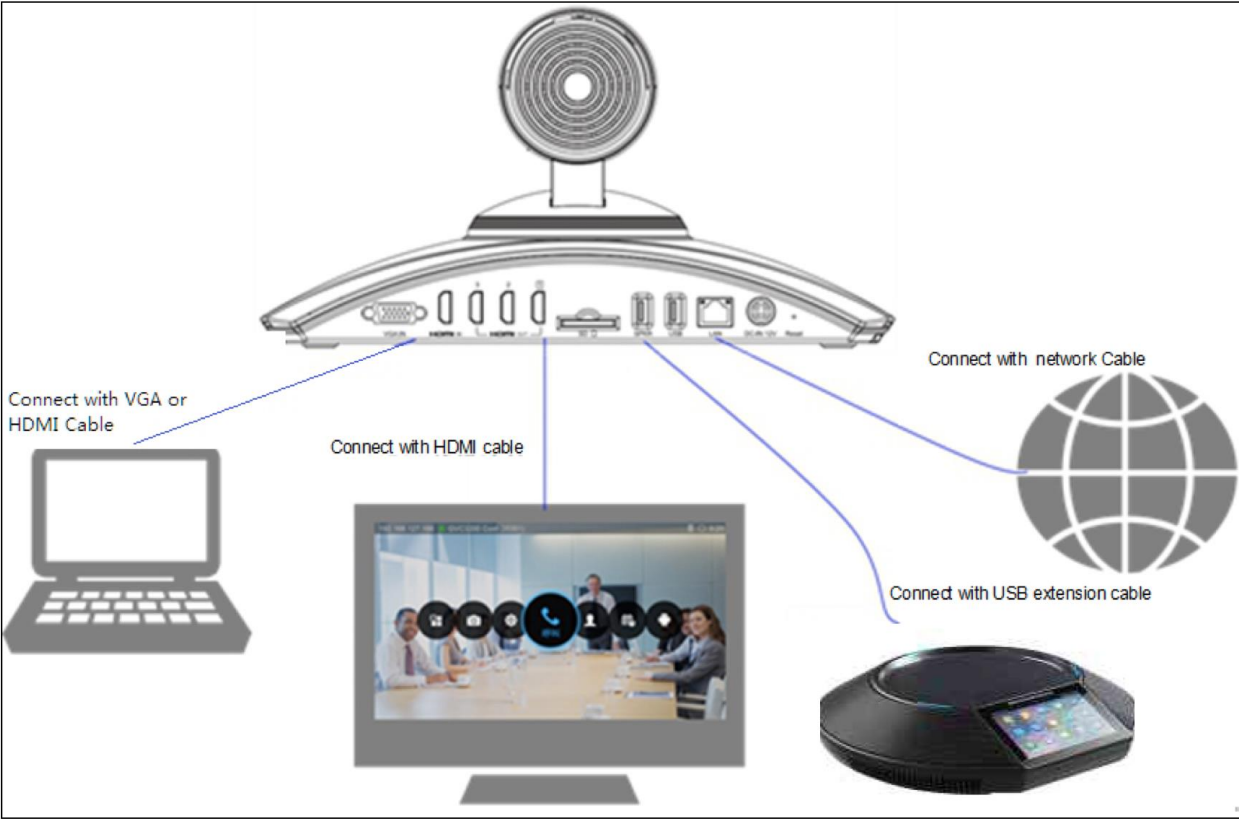

Figure 4: GVC3200 Back Panel Connection Diagram

The following figure shows multiple GVC3200/GVC3202 devices deployed with other VoIP/network devices for video conference and collaboration.

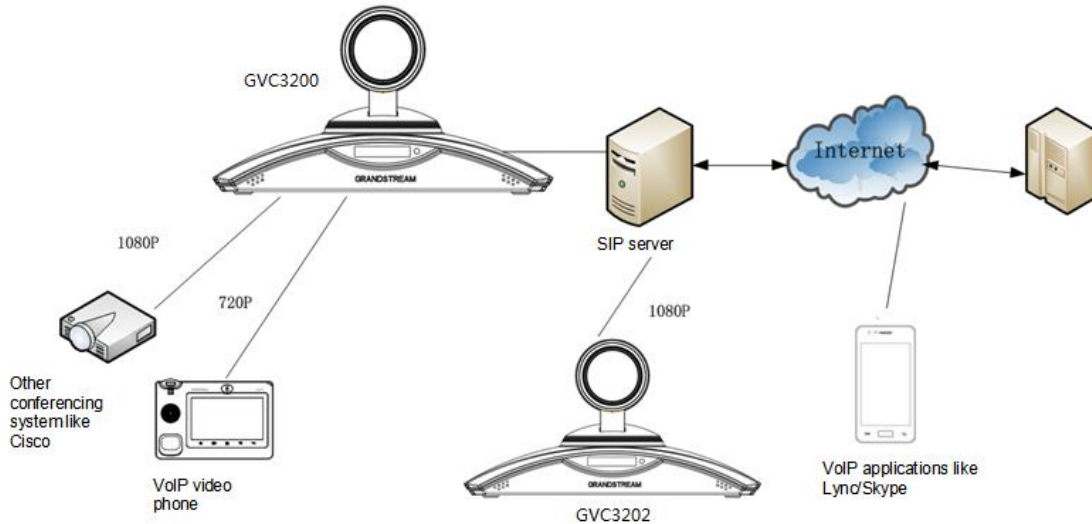

Figure 5: Deploy GVC3200/GVC3202 with Other Devices

Connecting GAC2500 to GVC3200/GVC3202

GAC2500 is included in GVC3200/GVC3202 package to be used as the external speaker. There are two ways to connect the GAC2500 to GVC3200/GVC3202.

- **Via USB Connection**

The GAC2500 comes with a micro-USB cable. The cable should be connected between SPKR port on GVC3200/GVC3202 and Micro-USB port on GAC2500. Once connected successful, the GAC2500 will change to speaker mode, only display volume adjustment, mute, call, hang up and etc.

- **Via Bluetooth Connection**

1. On GAC2500, go to LCD menu→**Settings**→**Bluetooth**, turn on Bluetooth. Then tap on “Bluetooth settings” and tap on the GAC2500 device on the top to make it visible.
2. On GVC3200/GVC3202, Bluetooth is turned on by default. Go to the GVC3200/GVC3202 LCD menu→**Network**→**Bluetooth**, click on the MENU button  and select “Search for Devices”. GAC2500 will be displayed under “Available Devices” list. Click on this GAC2500 to initiate pairing process.
3. On both GVC3200/GVC3202 and GAC2500, a prompt will pop up for the user to confirm PIN. Click on “Pair” to confirm it on both devices.
4. On GAC2500 LCD menu→**Settings**→**Bluetooth**→**Bluetooth settings**, make sure “Enable headset mode” is turned on.
5. On GVC3200/GVC3202 LCD menu→**Settings**→**Bluetooth**→**Paired Devices**, if the GAC2500 is displayed there but not shown as “Connected”, click on this GAC2500 there to complete connection process.
6. The GAC2500 and GVC3200/GVC3202 should be successfully paired and connected. GAC2500 can be used as Bluetooth speaker device for the GVC3200/GVC3202 now.

For more information about GAC2500, please refer to the GAC2500 product page in www.grandstream.com.



GETTING TO KNOW GVC3200/GVC3202

Remote Control

Remote Control Keys and Touchpad

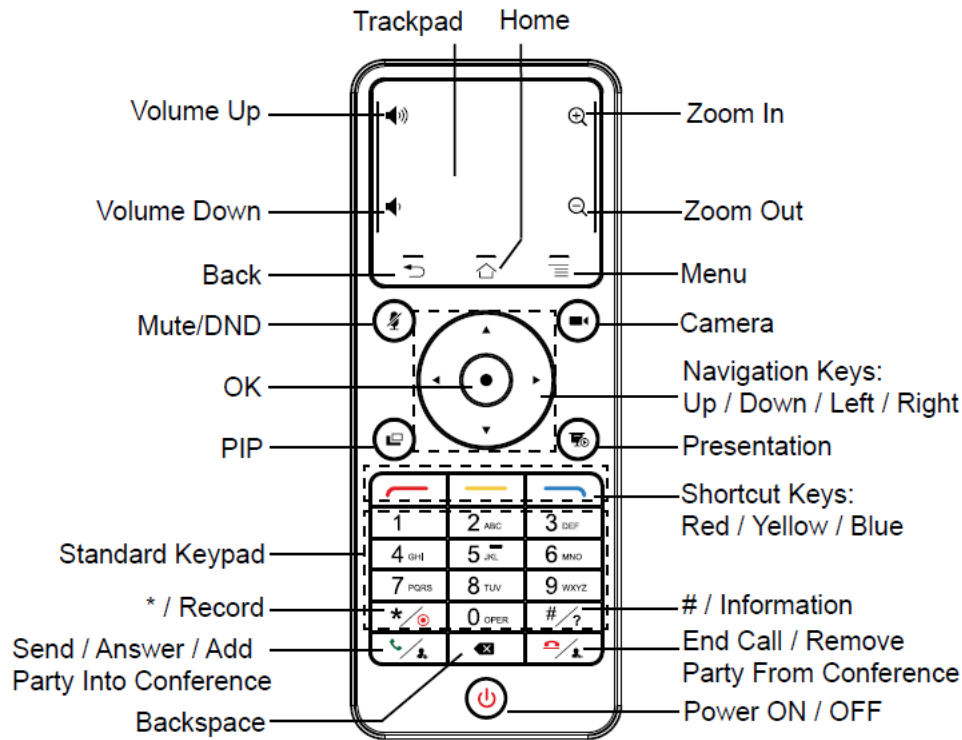























Figure 6: GVC3200/GVC3202 Remote Control



Table 7: GVC3200/GVC3202 Remote Control Keys

Icon	Name	Explanation
1, 2, 3, 4...9	Digital Keys	Input number 1-9 and letters. The letter input using digital keys will not be displayed as letter, but it can be used to search for contacts in Call interface. For example, typing 5 (JKL), 6 (MNO), 4 (GHI), 6 (MNO) can look for John if it exists in GVC3200/GVC3202 contacts list.
	Camera	Switch to PTZ control mode during a call or in idle status.
	PIP	Switch screen layout in conference.

	Mute/DND	<ul style="list-style-type: none"> • Mute GVC3200/GVC3202 in conference. • Press the MUTE key to enable/disable DND mode when GVC3200/GVC3202 is in idle.
	Presentation	<ul style="list-style-type: none"> • Enable/Disable presentation function to send presentation to all members in the conference. • Enable/Disable presentation function to show presentation on displayed device which is connected to HDMI output 1 as projection when GVC3200/GVC3202 is in standby mode.
	Send/Answer/Add Party Into Conference	<ul style="list-style-type: none"> • Access the dial screen by default when GVC3200/GVC3202 is in idle mode. • Enter phone number and press the key to dial out. • Access the invite screen to add members in a conference. • Press the key to bring out the backstage conference. • Press the key to redial the last outgoing call.
	End Call/Remove Party From Conference	<ul style="list-style-type: none"> • Delete members in conference. • Hang up the conference.
	Backspace	Press the key to delete input characters.
	Navigation Keys: Up/Down/Left/Right	<ul style="list-style-type: none"> • Press to adjust cursor movement. • Control PTZ movement in camera mode.
	OK	<ul style="list-style-type: none"> • Press to confirm operations. • Bring up the soft keypad when the cursor is in an input box.
	Power On/Off	LCD prompt shows the following three options after pressing this key: <ul style="list-style-type: none"> • Switch GVC3200/GVC3202 into sleep mode. • Power Off • Reboot

	*/Record	<ul style="list-style-type: none"> • Input * in input field. • Used as "." when dialing direct IP call. For example, 192.168.40.5. • Start/stop recording in camera control mode. • Start/stop recording in a call.
	#/Details	<ul style="list-style-type: none"> • Input "#" in input field. • Used as ":" when dialing direct IP Call e.g., 192.168.40.5:5060. • Input "#" on dialing screen to use it as REDIAL key. • Display call details on call screen during a call.
	Shortcut Key: Red	
	Shortcut Key: Yellow	Press each shortcut key for designated functions on different screen context.
	Shortcut Key: Blue	
	Home	
	Menu	Press the key to view more options.
	Back	Press the key to go back to the previous screen or exit the current screen.
	Volume Down	Turn down the device volume.
	Volume Up	Turn up the device volume.
	Zoom In	Zoom in screen or adjust close focus.
	Zoom Out	Zoom out screen or adjust distant focus.
Trackpad		<ul style="list-style-type: none"> • Slide on the trackpad to move the mouse cursor. • Press the trackpad to confirm operations. • Using two fingers to press on the trackpad and slide up/down for page up/down.

Capturing Screenshot Using the Remote Control

To capture a screenshot on GVC3200/GVC3202, the users can press the red shortcut key  and blue shortcut key  at the same time for about 3 seconds. The screenshot picture will be saved in the internal storage of GVC3200/GVC3202. The users can access the screenshot in GkVC3200/GVC3202 LCD menu→**Applications**→**File Manager**→**Internal Storage**→**Pictures**→**Screenshot**.

Please note the screenshot captured here does not have the image captured from the camera in the background. If you would like the image captured from camera, you can press the CAMERA button on the remote control and then press the blue shortcut key.

Using the Remote Control

GVC3200/GVC3202 remote control is connected to GVC3200/GVC3202 via Bluetooth, and it's already pre-paired when the user receives GVC3200/GVC3202 packages. Before using the remote control, please make sure:

1. A pair of AAA batteries are correctly installed on the back of the remote control.
2. The remote control needs to be placed within the Bluetooth effective range, i.e., 10m from GVC3200/GVC3202.

After powering up GVC3200/GVC3202, pressing "OK" key on the remote control, it will initiate connection and the remote control can be used right away.

If the remote control fails to pair and connect to GVC3200/GVC3202, please follow the steps below to troubleshoot:

- Check the battery polarity when placed into the battery case. Make sure the batteries are placed in the correct direction in the remote control.
- Check the battery power.

If GVC3200/GVC3202 remote control still does not work with the diagnosis above, please try another remote control or contact the device provider.

Using Mouse & Keyboard

When the USB mouse is plugged into GVC3200/GVC3202, users could make the following operations with the mouse.

- Single click the left key of the USB mouse to perform the following operations:
 - Access menu
 - Check in the checkbox or enable/disable an option



- Bring up the drop-down list when clicking on a combo box
- Switch input methods in the input box, tap on the corresponding buttons on the soft keyboard to input characters

- Double left clicks  on the soft keyboard can switch to "Always use upper case" in English input method.
- Single click the right key of the USB mouse to exit the current displayed menu. It will go back to the previous menu without saving the configurations.

OLED Screen

Table 8: GVC3200/GVC3202 OLED Screen Status Descriptions

OLED Screen Status	Descriptions
Booting	Display "BOOTING..." when GVC3200/GVC3202 boots up.
IP	Display GVC3200/GVC3202 IP address. For example, IP: 192.168.40.5.
Call Status	Display "Ringing", "Calling", "Talking", "Call Waiting", "Missed Call", "New Voicemail" and etc.
Upgrade Status	<ul style="list-style-type: none"> • Display "New Version" when a new firmware version is detected. • Display "Upgrading" in the process of upgrading. • Display failure reason when upgrade fails. For example, "Incompatible Hardware", "Insufficient Space", "Same Version", etc.
Sleep Mode	When the device is in sleep mode, the OLED shows "Standby".
Abnormal Status	It is used to display abnormal status information. The hexadecimal error code will be displayed next to the abnormal status.

Using the LED Indicator

GVC3200/GVC3202 LED indicator is located next to the OLED. It can be used to notify the users with current status of the device. Please refer to the status description below.

Table 9: GVC3200/GVC3202 LED Indicator Status Descriptions

LED Indicator Status	Descriptions
Solid Green	Booting or the device is already booted up
Flash Red	Standby (Sleep Mode)
Solid Red	Shut down but powered on (power adapter is connected)
Green Flashing once	Key pressing on the remote control
OFF	Power off

Status Icons

GVC3200/GVC3202 status icons are displayed on the right side of top status bar on GVC3200/GVC3202 LCD display device. The users can view the top status bar notification details in drop-down panel by long-pressing the MENU key on the GVC remote control or pressing DOWN button when the GVC3200/GVC3202 is in home screen.

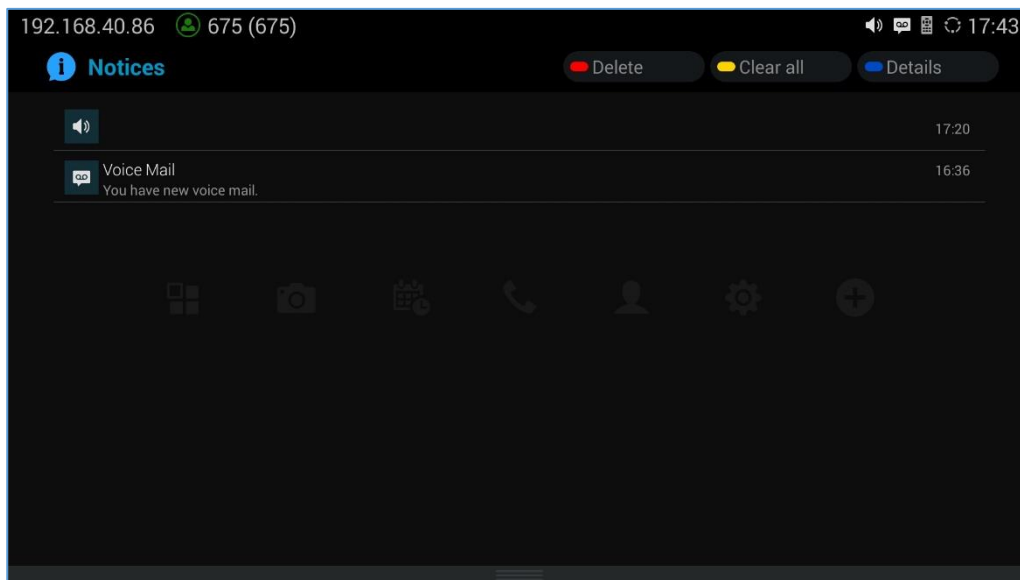



































Figure 7: GVC3200/GVC3202 Top Status Bar Dropdown Menu

For some notifications such as Voice Mail, the users can use the GVC remote control trackpad to select it. It will navigate the users to the corresponding app.

The following table lists the main status icons used on GVC3200/GVC3202.

Table 10: GVC3200/GVC3202 Status Icons Descriptions

Icon	Descriptions	Icon	Descriptions	Icon	Descriptions
	Missed Call		Ongoing call		Auto answer is enabled
	Ethernet is connected		Ethernet is disconnected		Trying to connect to the Ethernet
	PPPoE is connected		PPPoE connection is failed		PPPoE is disconnected
	VLAN is successfully configured		VLAN is being configured		Unread voicemail
	VPN is connected		VPN connection is failed		Using third party applications for mixing calls
	Bluetooth is connected		DND mode is enabled		Remote control Low battery
	Remote control is connected and paired		Remote control is paired but not connected		Remote control is not connected and paired
	SD Card is inserted		USB flash drive is inserted		Speaker is being used
	Call recording storage is full		Contacts storage is full		SD card storage is full
	Wi-Fi is connected.		Wi-Fi is disconnected		Volume is turned to silent
	Call forward is set up	 Wi-Fi signal strength			Unknown Wi-Fi

Using the Onscreen Keyboard

English Keyboard

This is the default keyboard on GVC3200/GVC3202. The English keyboard supports multiple languages input methods. Users could tap on  to switch among different languages. See figure below.





Figure 8: Soft Keyboard - English Input Method

Tap on  to switch Caps Lock:



Figure 9: English Input Method – Capslock

Numbers and Symbols



To input numbers and symbols, tap on button  on the default keyboard to switch to numbers/symbols. Tap on  for more numbers/symbols.



Figure 10: Soft Keyboard - Symbols and Numbers

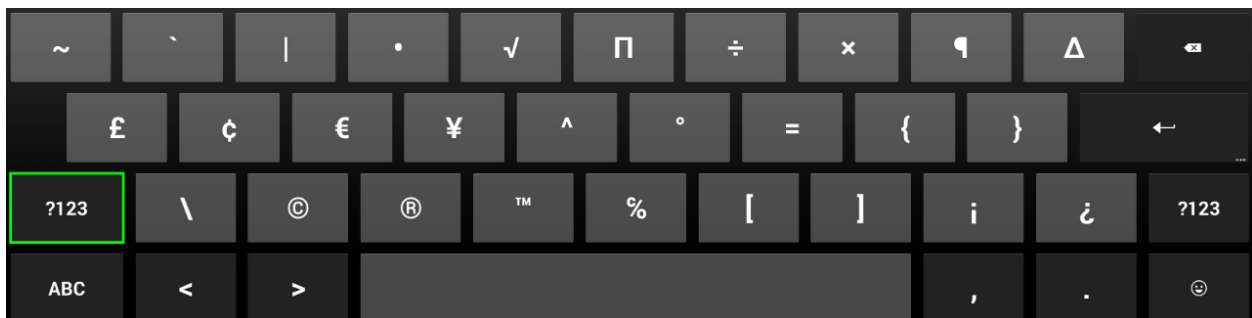

Figure 11: Soft Keyboard - More Symbols and Numbers

Home Screen

GVC3200/GVC3202 Home screen displays the icons for users to easily access applications, camera, schedule, call, contacts, settings and custom applications. Press the Left/Right keys on the GVC3200/GVC3202 remote control to navigate.

If there is no activity on main screen, the icons will be hidden and the video local loopback is displayed. Press OK button on the GVC3200/GVC3202 remote control to bring up the icons to display again.



Figure 12: GVC3200/GVC3202 Home Screen

Screen Lock

The GVC3200/GVC3202 supports screen lock. When it's enabled and configured, the user will be required to enter the lock code to unlock on the home screen.

To use this feature:

1. On GVC3200/GVC3202 LCD menu → Settings → System → Security, select Screen Lock and set Screen Lock code.
2. Reboot, enter sleep mode or power off the GVC3200/GVC3202.
3. When the GVC3200/GVC3202 boots up again, a screen lock code will be required. The user can unlock the screen by entering the code using the GVC remote control.



CONNECTING TO NETWORK AND DEVICES

GVC3200/GVC3202 supports a variety of network connections (Ethernet, Wi-Fi) and device connections, including USB, SD card and Bluetooth devices. When the GVC3200/GVC3202 boots up for the first time, a setup wizard will guide the users to pair and connect the remote control to GVC3200/GVC3202 and get started with the basic configurations.

Ethernet

If the user would like to use Ethernet connection for network access, please plug the Ethernet cable into the LAN port on the back of GVC3200/GVC3202. Ethernet connection is turned on as DHCP by default on both IPv4 and IPv6 protocols.

To configure Ethernet settings on GVC3200/GVC3202, go to LCD menu → **Settings** → **Network** → **Ethernet**.

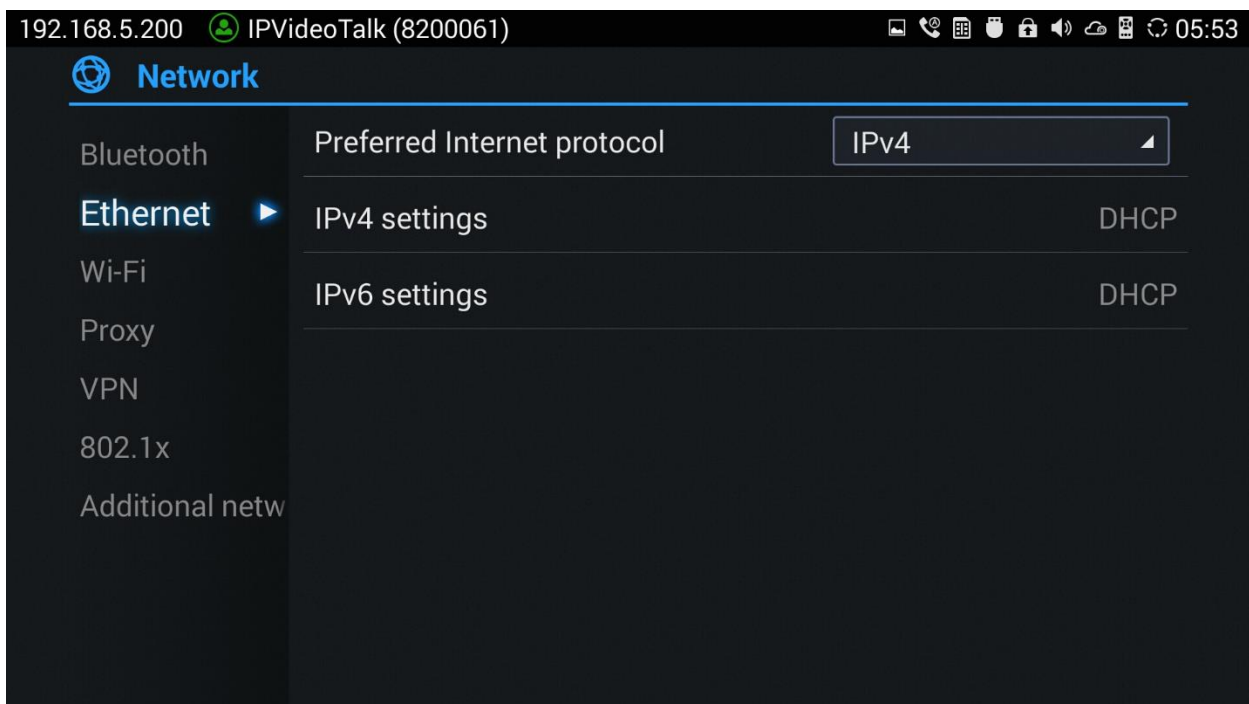

Figure 13: Ethernet Settings

The GVC3200/GVC3202 offers the possibility to prioritize a protocol over another by setting Preferred Internet protocol to IPv4 or IPv6.

Using IPv4

To configure the GVC3200/GVC3202 using IPv4 protocol, follow the below steps:



1. Plug the Ethernet cable into the LAN port on the back of GVC3200/GVC3202.
2. Go to LCD menu→**Settings**→**Network**→**Ethernet**→**IPv4 Settings**.
3. Tap on "Address Type" to select DHCP, Static IP or PPPoE as the address type.
 - For DHCP, save the setting and GVC3200/GVC3202 should be able to get IP address from the DHCP server in the network.
 - For static IP, enter IP Address, Subnet Mask, Default Gateway, DNS Server and Alternative DNS server for GVC3200/GVC3202 to correctly connect to the network.
 - For PPPoE, enter PPPoE account ID and password so that GVC3200/GVC3202 can get IP address from the PPPoE server.

Using IPv6

To configure the GVC3200/GVC3202 using IPv6 protocol, follow the below steps:

1. Plug the Ethernet cable into the LAN port on the back of the GVC3200/GVC3202
2. Go to LCD menu→**Settings**→**Network**→**Ethernet**→**IPv6 Settings**.
3. Tap "Address Type" to select DHCP or Static IP as the address type.
 - For DHCP, save the setting and GVC3200/GVC3202 should be able to get IP address from the DHCP server in the network.
 - For static IP, configure IPv6 address, DNS server 1, DNS server 2 and Preferred DNS server, enter the IPv6 address in the format of 2001:db8:1:2::3.

WI-FI (GVC3200 Only)

Wi-Fi is supported and built-in on GVC3200 only. On the LCD display, go to **Settings**→**Network**→**Wi-Fi** to turn on and configure Wi-Fi.



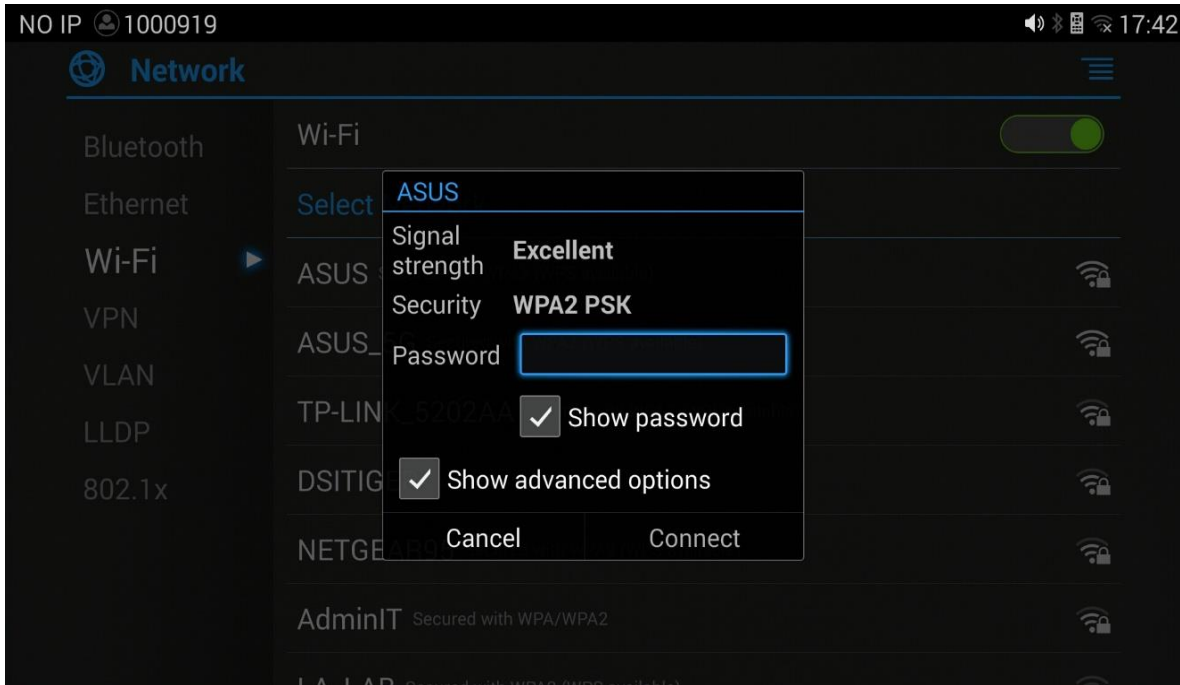

Figure 14: GVC3200 Add Wi-Fi Screen

Turning WI-FI On / Off

Once Wi-Fi is turned on, GVC3200 will automatically start the scanning within the range. A list of Wi-Fi networks will be displayed as scanning result. Tap on the SSID and enter the correct password information to connect to the selected Wi-Fi network.

Follow the steps below for static IP usage under Wi-Fi environment:

1. Tap on one Wi-Fi network in the scanned Wi-Fi list to bring up the dialog that shows signal strength, security, password and option "Show advanced options".
2. Select "Show advanced options". The dialog will show additional option "IP settings".
3. In "IP settings", select Static IP, enter IP Address, Subnet Mask, and Default Gateway for GVC3200 to correctly connect to the network.

Bluetooth

On GVC3200/GVC3202, Bluetooth is enabled by default. Users could connect Bluetooth by remote control, send or receive files to cellphone, or use Bluetooth speaker and etc on GVC3200/GVC3202.



Pairing GVC3200/GVC3202 with a Bluetooth Device

Before connecting GVC3200/GVC3202 with other Bluetooth device, users must pair them first. They will stay paired afterwards unless they are manually unpaired. To pair Bluetooth device:

1. On the LCD display device, go to **Settings**→**Network**→**Bluetooth**.
2. Press  button on the remote control and select "Search for devices".
3. GVC3200/GVC3202 scans and displays the IDs of all available Bluetooth devices in range. Once the Bluetooth device shows up in the result, tap on it to start pairing.
4. Confirm the passkey in the prompted message (if any). Or, if passcode is required, please refer to the device's documentation or contact with the device administrator to obtain the passcode.



Note:

The external speaker provided with GVC3200/GVC3202 is not pre-paired to GVC3200/GVC3202. If the user would like to use external speaker via Bluetooth connection with GVC3200/GVC3202, the user must pair and connect it to GVC3200/GVC3202 manually before using it for audio output.

Connecting to a Bluetooth Device

After pairing successfully, the device will be connected to GVC3200/GVC3202 immediately. Users will see

this device listed under "Paired Devices". Tap on  next to the connected device. Users will see options "Rename", "Unpair" and etc.



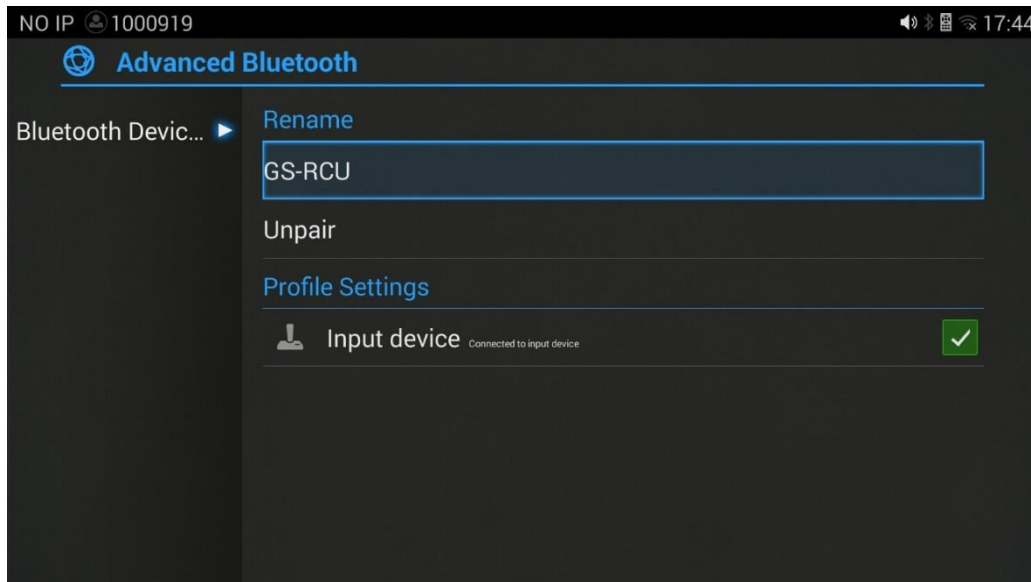



Figure 15: GVC3200/GVC3202 Bluetooth - Paired Device

If the connection is lost between the Bluetooth device and GVC3200/GVC3202, go to LCD menu→**Settings**→**Network**→**Bluetooth** and click on the device name under “Paired devices” again to reconnect.

Using Bluetooth Remote Control

Users could use GVC3200/GVC3202 Bluetooth remote control that comes with the GVC3200/GVC3202 packaging to control and configure a GVC3200/GVC3202. When the GVC3200/GVC3202 boots up for the first time, a setup wizard will guide the users to pair and connect the remote control to the GVC3200/GVC3202.



When the remote control is connected to GVC3200/GVC3202, users will see  icon on the top status bar of the LCD display device.

If the user happens to reset the GVC3200/GVC3202, or unpaired the remote control, the user will need pair and connect remote control to the GVC3200/GVC3202 again. Please follow the steps below:

1. Connect a USB mouse or open the virtual remote control after logging in GVC3200/GVC3202 web UI.
2. On the LCD display device, go to **Settings**→**Network**→**Bluetooth**.
3. Select  and click "Search for devices".
4. On the remote control, you would like to pair with GVC3200/GVC3202, press "OK" and digit 5 keys at the same time for about 5 seconds.
5. The pairing and connection process will be initiated and finished in a few seconds. Please do not press any keys on the remote control or switch screens during this process to avoid connection failure.



If the user needs to pair a different remote control to GVC3200/GVC3202, please follow the methods below:

Method 1: Connect a second remote control to GVC3200/GVC3202 and both remote controls can be used at the same time

1. When remote control A is paired and connected to GVC3200/GVC3202, go to GVC3200/GVC3202

LCD→**Settings**→**Network**→**Bluetooth**, select  and click "Search for devices".

2. On remote control B, press OK + 5 keys at the same time for about 5 seconds to trigger pairing process on remote control B.

3. Use remote control A to navigate and select the detected remote-control B on GVC3200/GVC3202 Bluetooth display interface to pair and connect.

4. Now both remote controls can be used with GVC3200/GVC3202.

5. (Optional) If you wish to use only one remote control, on GVC3200/GVC3202

LCD→**Settings**→**Network**→**Bluetooth**, use the desired remote control, select  on the right side of the other remote control, then click on "Unpair" to disconnect and unpair it from the GVC3200/GVC3202.

Method 2: Replace remote control A with remote control B

1. On GVC3200/GVC3202, go to LCD→**Settings**→**Network**→**Bluetooth**, select  on the right side of the remote-control A, then click on "Unpair".

2. Reboot GVC3200/GVC3202. Make sure there is no USB mouse connected to GVC3200/GVC3202. Also, make sure no other remote control is paired to the GVC3200/GVC3202.

3. After GVC3200/GVC3202 boots up, on remote control B, press OK + 5 keys at the same time for about 5 seconds to trigger pairing process on remote control B.

4. GVC3200/GVC3202 will automatically search for nearby available Bluetooth devices right after it boots up. It will then pair and connect to remote control B



Note:

Please use the proprietary factory remote control that comes with the GVC3200/GVC3202 packaging.



Transfer Files with Bluetooth

Users could transfer files, share contacts information with other Bluetooth portable devices after pairing and connection. A prompt for file transferring will be displayed on GVC3200/GVC3202 LCD display device when it receives the file transferring request. Accept the request to receive the file and it will be stored under LCD→**Applications**→**File Manager**→**Internal Storage**→**Bluetooth** folder.

Using Bluetooth Headset

Once the Bluetooth headset is connected with GVC3200/GVC3202, it will automatically use Bluetooth headset for calls. By default, the ringing tone will be generated in Bluetooth headset when there is an incoming call.

If the user would like to have the ringing tone generated in GVC3200/GVC3202 internal ringer as well, please select enable "Always Ring Internal Ringer" under GVC3200/GVC3202 web UI→**Settings**→**Call Features**.

VPN Settings

Users can add VPN using different protocols (PPTP, L2TP/IPSec PSK, L2TP/IPSec RSA, IPSec Xauth PSK, IPSeXauth RSA and IPSec Hybrid RSA). Follow the steps below to set up VPN:

1. Access GVC3200/GVC3202 home screen, go to **Applications**→**Settings**→**Network**→**VPN**.
2. Tap on "Add VPN file" to access configuration page as shown below:

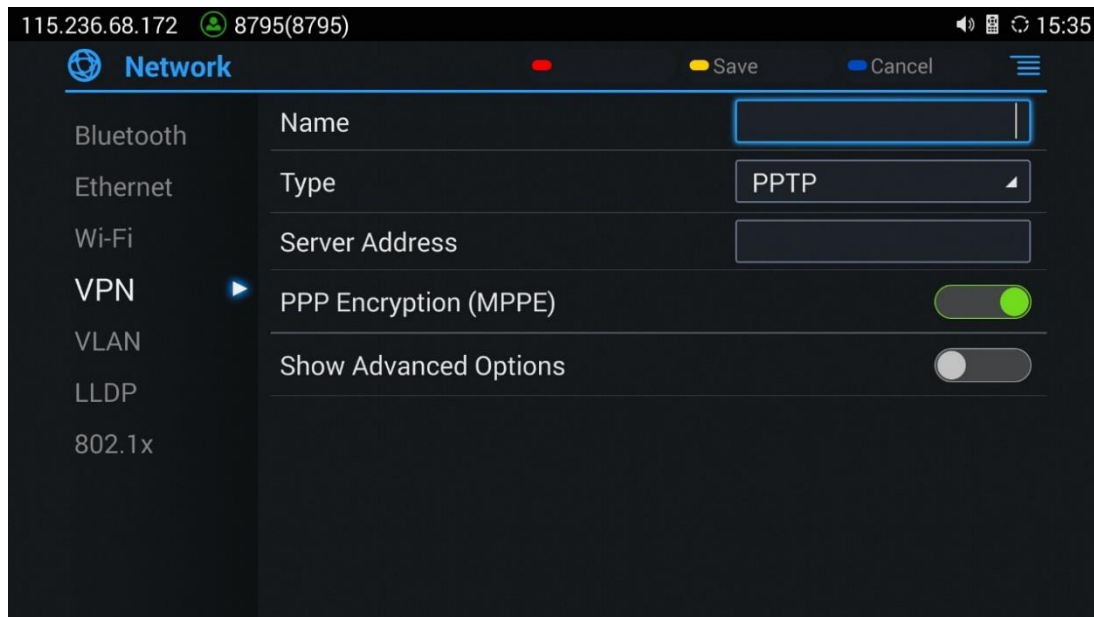

Figure 16: GVC3200/GVC3202 Add VPN Files Screen

3. Fill in and save the configurations, go back to VPN page, you will find the new VPN file you just added.
4. Tap on the VPN file to open the validation page as shown below:



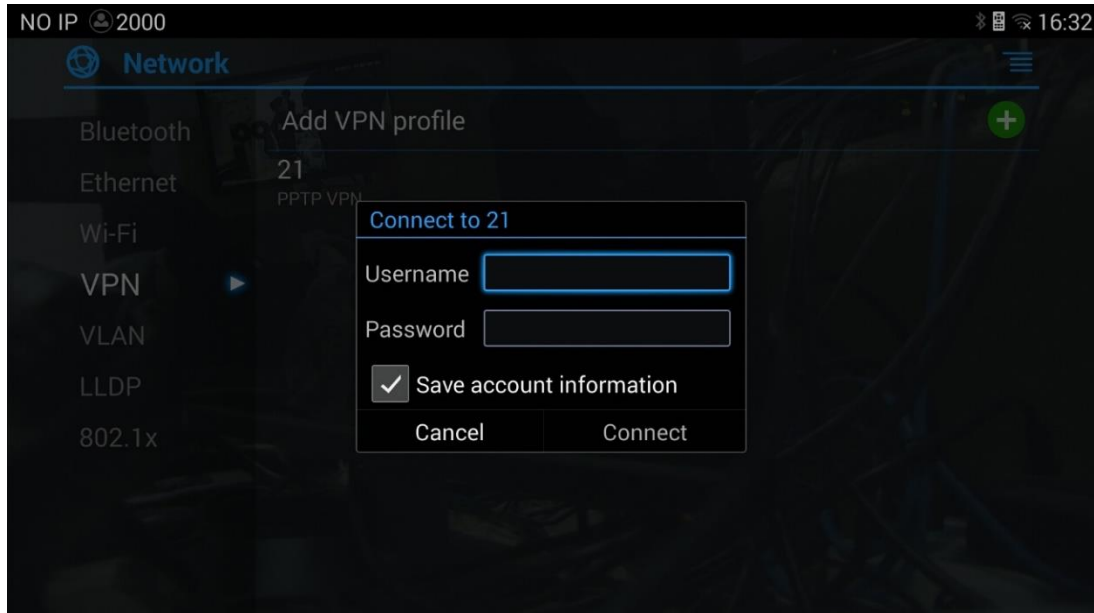

Figure 17: GVC3200/GVC3202 VPN Validation Screen

5. Fill in correct username and password to connect to VPN.



If GVC3200/GVC3202 is connected to VPN successfully, icon  will be shown in the top status bar; if the connection is failed, a prompt box will pop up to remind users whether to reconnect to VPN. If icon  displays in the top status bar, please check whether if your VPN configuration is correct.

Table 11: GVC3200/GVC3202 VPN File Parameters

Parameters	Descriptions
Name	Fill in your company address or the server you are connecting to.
Type	Set to PPTP, L2TP/IPSec PSK, L2TP/IPSec RSA, IPSec Xauth PSK, IPSeXauth RSA or IPSec Hybrid RSA.
Server Address	Fill in the server URL or IP address.
PPP Encryption (MPPE)	Defines whether to use PPP encryption.
Show Advanced Options	Check this option to display more options below.
DNS Search Domains	Enter DNS search domain.
DNS Server	Enter DNS server address.
Forwarding Routes	Enter Forwarding Routes, for example, 10.0.0.0/8.

VLAN Settings

Access GVC3200/GVC3202 home screen, go to **Applications**→**Settings**→**Network**→**VLAN** to configure VLAN settings on GVC3200/GVC3202.

Table 12: GVC3200/GVC3202 VLAN Configuration Parameters

Parameters	Descriptions
Layer 2 QoS 802.1q/VLAN Tag	<p>Assigns the VLAN Tag of the Layer 2 QoS packets for LAN port. The default value is 0.</p> <p>Note: Please do not change the setting before understanding the VLAN's settings or consulting with the network administrator. Otherwise, the device might not be able to get the correct IP address.</p>
Layer 2 QoS 802.1p Priority	Assigns the priority value of the Layer 2 QoS packets. The default value is 0.

LLDP Settings

Access GVC3200/GVC3202 home screen, go to **Applications**→**Settings**→**Network**→**LLDP** to configure LLDP settings on GVC3200/GVC3202.

Table 13: GVC3200/GVC3202 LLDP Configuration Parameters

Parameters	Descriptions
LLDP	Enable or disable LLDP. The default setting is disabled.
Layer 3 QoS for SIP	This field defines the layer 3 QoS parameter for SIP packets. It is the value used for IP Precedence, Diff-Serv or MPLS. The default value is 48.
Layer 3 QoS for Audio	This field defines the layer 3 QoS parameter for audio packets. It is the value used for IP Precedence, Diff-Serv or MPLS. The default value is 48.
Layer 3 QoS for Video	This field defines the layer 3 QoS parameter for video packets. It is the value used for IP Precedence, Diff-Serv or MPLS. The default value is 48.

802.1X Mode

Access GVC3200/GVC3202 home screen, go to **Applications**→**Settings**→**Network**→**802.1x Mode**. By default, 802.1x is disabled. Selecting 802.1x mode to "EAP-MD5", "EAP-TLS5" or "EAP-PEAP" to turn on 802.1x. Once it is enabled, the user will be required to enter the identity and password to be authenticated in the network.







Table 14: GVC3200/GVC3202 802.1x Mode Parameters

Parameters	Descriptions
802.1x Mode	Allows the user to enable/disable 802.1x and configure 802.1x mode. The default setting is disabled.
Identity	Enter the Identity information for 802.1x mode.
MD5 Password	Enter the MD5 Password for 802.1x mode.
CA Certificate	Upload the CA certificate for 802.1x mode.
Client Certificate	Upload the CA certificate for 802.1x mode.
Private Key	Upload the private key for 802.1x mode.

CAMERA

Users could set preset, configure camera parameters, start recording and make screenshots on camera screen. There are 3 ways to access camera screen:

- Click on  icon on home screen.
- Press key  on the remote control.
- Select  on home screen to access Applications, then click on .

GVC3200/GVC3202 camera screen has the following options:

- Press recording button on the remote control to start or stop local recording.
- Press the red shortcut button on the remote control to edit preset.
- Press the yellow shortcut button on the remote control to edit image parameters such as scene, white balance, MF/AF and etc.
- Press the blue shortcut button on the remote control for screenshot.
- Press digit key on the remote control to apply a pre-configured preset.



Figure 18: GVC3200/GVC3202 Camera Screen

Preset

Add Preset

Users can create and save maximum of 24 camera presets, with each preset storing the camera position and focal length. Follow the steps below to add preset:

1. Access camera screen and press the red shortcut key on the remote control to access preset screen.

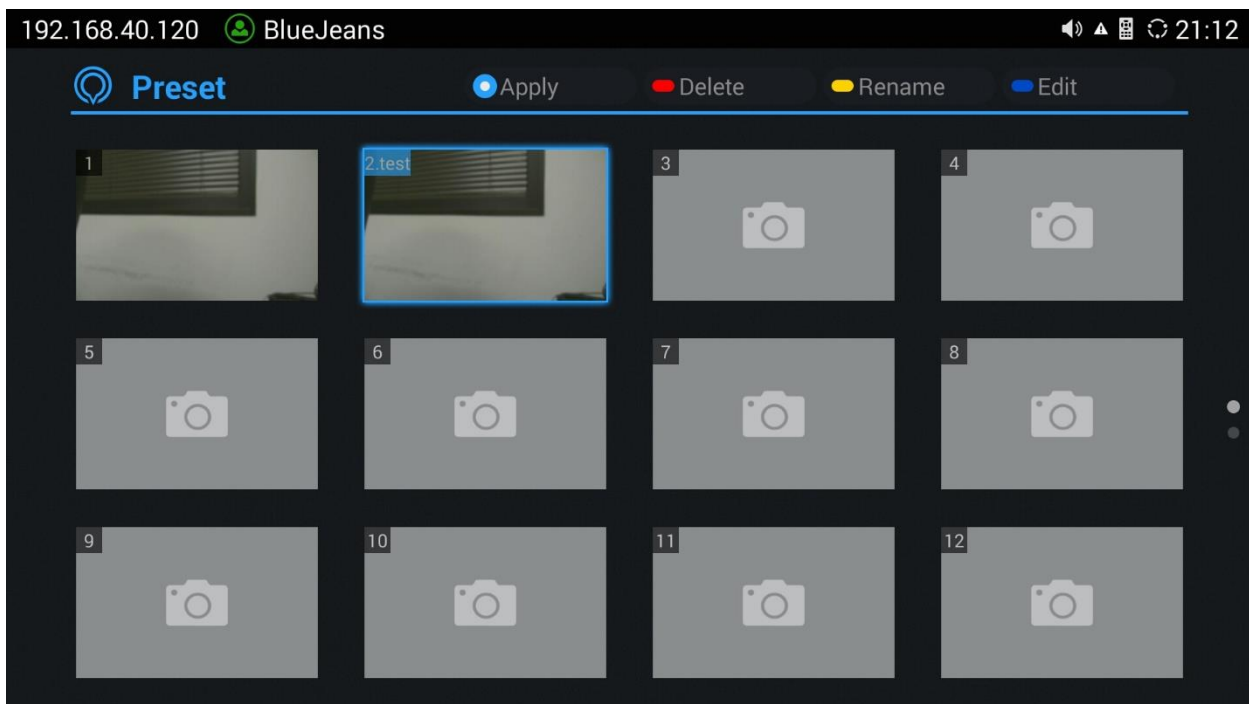



Figure 19: GVC3200/GVC3202 Add Preset Screen

2. Select the preset window and press the blue shortcut key on the remote control to access the editing screen.
3. Adjust camera position and zoom in/zoom out using the remote control.
4. On GVC3200/GVC3202 remote control, press "OK" key to save the preset, or press Back key  to cancel.

Edit Preset

To edit an existing preset, press the blue shortcut key on the remote control to access the editing screen to edit. The created preset can also be renamed by pressing the yellow shortcut key on the remote control for better identification purpose.

Delete Preset

Access the preset editing screen, select preset and press the red shortcut key on GVC3200/GVC3202 remote control to delete it.

Apply Preset

If you have already set preset on camera, you can apply preset via one of the following two ways:

- Access camera screen and press the digital keys on the remote control to adjust camera to the preset.
- Access preset screen and press the digital keys to switch to the corresponding preset, press the yellow shortcut key to apply.

Initial Position

Users can also define a preset as initial position when the GVC3200/GVC3202 boots up from LCD menu → **Settings** → **Peripheral** → **Camera**, three options are available:

- System default position: The GVC320x will boot up at default camera position.
- Position when power off: The GVC320x will return to the last position before power off.
- Custom: The GVC320x will boot up at a custom position. When chosen, users will be redirected to Preset settings page to set a custom preset.

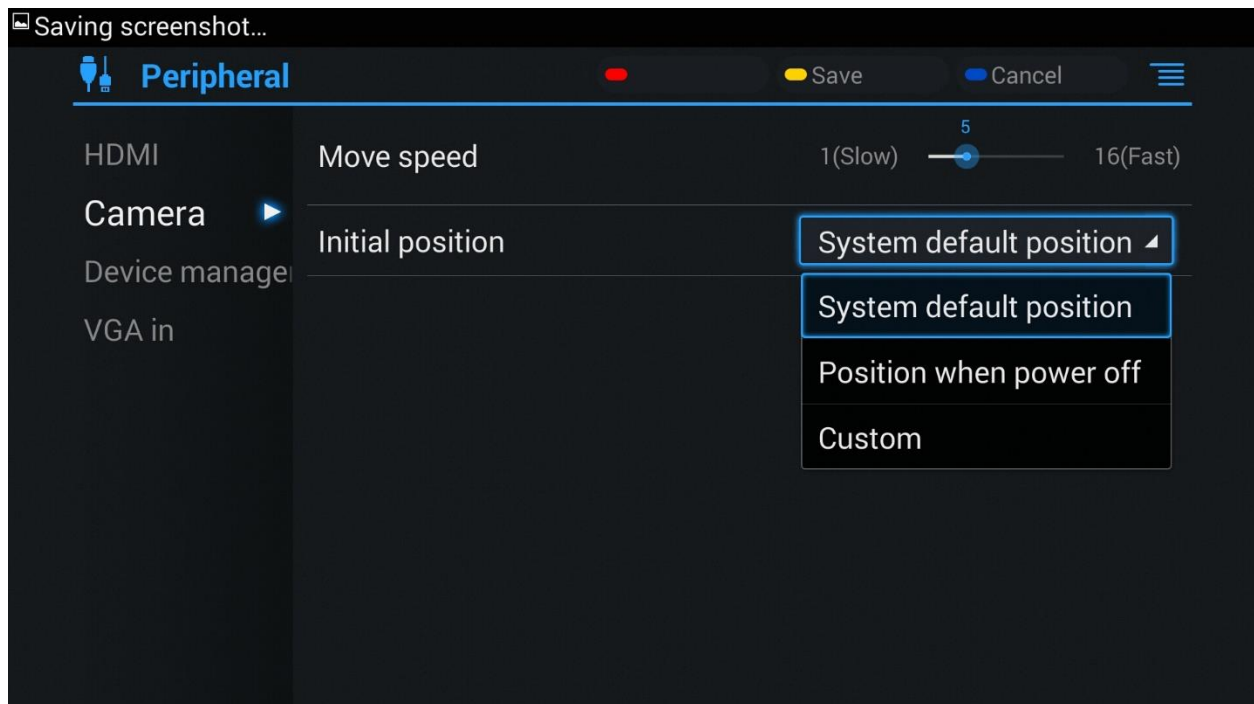

Figure 20: Initial Position

Camera Parameters Configurations

Press the yellow shortcut key on GVC3200/GVC3202 remote control to bring out camera parameters setting screen as shown below. Refer to the table below and configure the parameters using navigation keys on the remote control.

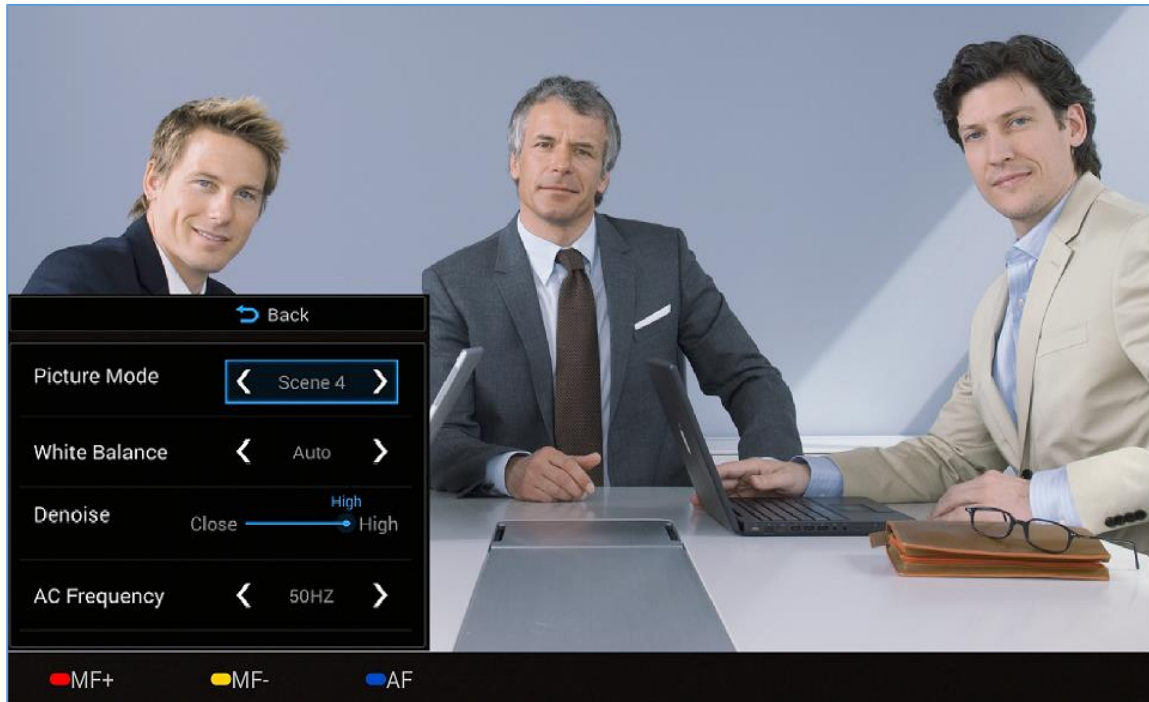

Figure 21: GVC3200/GVC3202 Camera Parameters Setting Screen

Table 15: GVC3200/GVC3202 Camera Parameters

Parameters	Descriptions
Picture Mode	<p>GVC3200/GVC3202 has 4 built-in modes as well as "Manual" for customization. When set to "Manual", press "OK" key to access each setting to configure sharpness, contrast, saturation, and brightness.</p> <ul style="list-style-type: none"> • Sharpness: Higher sharpness brings higher screen clarity. The object displayed on the screen has more sharpen edge. • Contrast: Higher value brings more distinct color contrast. • Saturation: Higher value brings deeper color. • Brightness: Higher value brings brighter color.

White Balance	<p>This is used to display accurate images. Users could set to "Manual" or "Auto".</p> <ul style="list-style-type: none"> • When set to "Auto", the device will adjust parameters automatically according to the current environment. • When set to "Manual", the device will disable "Auto" mode. Press "OK" key to access manual setting screen, and adjust red or blue gain manually for better white balance.
De-noise	Users could set to "off", "low", "medium" or "high". Higher reduction level brings less image noises.
Frequency of A.C.	Users could set to 50HZ or 60HZ.
Red Shortcut Key (MF+)	Manual focus: increase the focal length.
Yellow Shortcut Key (MF-)	Manual focus: decrease the focal length.
Blue Shortcut Key (AF)	Auto focus

PERIPHERAL

External USB Device

GVC3200/GVC3202 USB interface could be connected with a USB mouse, a USB keyboard, or a USB storage device.

Using USB Mouse/Keyboard

When a USB mouse is plugged into GVC3200/GVC3202, users could see the cursor on the screen, move the cursor to perform operations. When a USB keyboard is plugged into GVC3200/GVC3202, users could use GVC3200/GVC3202 remote control to navigate to an input interface, and click on the keys on the keyboard to check if it is installed successfully.

Using USB Storage Device

To connect and access USB storage device:

1. Insert USB storage device into USB port at the back of GVC3200/GVC3202.
2. It will take a few seconds for GVC3200/GVC3202 to prepare the connection.
3. Once it is installed successfully, the USB storage icon will show up on the status bar. Users could go to GVC3200/GVC3202 LCD → **Applications** → **File Manager** → **USB** to access and manage your data.
4. Users could view, copy and paste files by using the USB storage device.

SD Card

1. Insert your SD card into SD card slot at the back of GVC3200/GVC3202. Please make sure the SD card is inserted with right direction on GVC3200/GVC3202.
2. It will take a few seconds for GVC3200/GVC3202 to prepare the connection. Then, the SD card icon will show up on the status bar.
3. To access SD Card, go to GVC3200/GVC3202 LCD → **Applications** → **File Manager** → **sdcard**. Tap on it to access and manage your data.



Note:

The external SD card must be plugged in if the users would like to record calls and the recording files will be automatically saved in the external SD card. It is recommended to use an SD card with large capacity for call recording purpose.



Microphone and Speaker

GVC3200/GVC3202 is equipped with a built-in microphone. Alternatively, you can connect external audio devices to GVC3200/GVC3202 as audio input/output sources. It is recommended to use the external speaker that comes with your GVC3200/GVC3202 package for better compatibility.

If the external speaker supports Bluetooth, users could also pair and connect the speaker to the GVC3200/GVC3202 via Bluetooth. This will provide better mobility and make cabling easier when deploying the GVC3200/GVC3202 conference system in your conference room.

When there are multiple audio devices connected to the GVC3200/GVC3202, the users could configure the audio device priority from LCD **Menu**→**Settings**→**Audio**→**Audio Priority**, or from web UI→**Device Control**→**Audio Control**: “Audio Device”. Please refer to more details in “**Audio Device**” option.



MAKING PHONE CALLS

Account

GVC3200/GVC3202 comes with one IPVideoTalk account, supports one configurable SIP account registration, one H.323 account and one Blue Jeans account. Please enable the IPVideoTalk account, or register SIP account to a SIP server before making calls. The following figure shows the SIP account is registered successfully (account icon is green). This displays on the left side of the top status bar on your LCD display device.

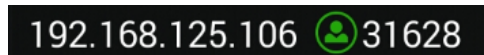





Figure 22: GVC3200/GVC3202 SIP Account

Dial Screen

Once the account is registered successfully, users could use one of the following 3 ways to bring up dial screen to start making calls.

- Press the DIAL icon  in the lower right corner of the remote control.
- On the LCD display device, click on icon  on home screen.
- On the LCD display device, click on Applications and select  to bring up dial screen.

Enter digits in the dial-up box. If the digits or the letters for the digit match contacts and call history in GVC3200/GVC3202, a dropdown list of numbers will be displayed. For example, entering 5 (JKL), 6 (MNO), 4 (GHI) and 6 (MNO) will display “5646” or “john” if contact “john” exists. The matching characters will be highlighted in red.

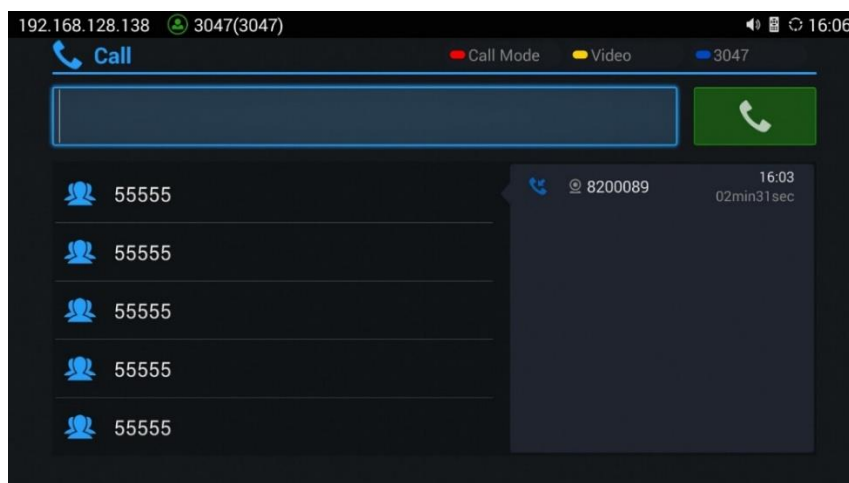





Figure 23: GVC3200/GVC3202 Call Screen



- Press the red shortcut key on the GVC3200/GVC3202 remote control to bring up call mode setting screen, set call mode to Call or IP call.
- Press the yellow shortcut key to set call type to Audio or Video.
- Press the blue shortcut key to switch account among SIP account, H.323 account, IPVideoTalk account and Blue Jeans account.
- Click on "Cancel" icon on the screen, or press  key on the remote control to cancel the call.

Dialing a Number Directly

1. Open the dial screen.
2. Use the remote control keyboard to enter digits, or click the input box to enter digits using the pop out soft keyboard.
3. Press  on the remote control to dial out, or move the cursor to the icon  on dial screen and click it to dial out.



Note:



1. By default, GVC3200/GVC3202 allows users to press # key as SEND key. This behavior can be disabled via option "Use # as Dial Key" in web GUI→**SIP Account**→**Call page**.
2. When entering initials or full spellings of a name that exists in the contact, this contact will show up in the dropdown list. For example, if the user inputs Amy by pressing the corresponding digits "2" (ABC), "6" (MNO), "9" (WXYZ) on the remote control, Amy's name and number will be displayed in the list if it exists in the contact, users can select it to dial out.

Redial

Users can dial out the last dialed number if there is dialed call log. Access the dial screen, and then press "#" key or  on the remote control to dial out.



Dialing a Number via Contact

Follow the steps below to dial a number via Contacts.

1. On the LCD display device, access Contacts by tapping on button  on home screen.
2. Navigate and select in the contacts entries using the remote control navigation keys.
3. Press  on the remote control to dial out.



Dialing a Number via Call History

1. On the LCD display device, access Applications on home screen and access call history by selecting the icon .
2. The LCD will display all call history types. Navigate in the call history list by selecting the call history category. Select the call history entry you would like to dial out.
3. Press  on the remote control to dial out.

Direct IP Call

Direct IP Call allows GVC3200/GVC3202 and another VoIP device to talk to each other in an ad-hoc fashion without a SIP proxy. Direct IP calls can be made if:

- Both GVC3200/GVC3202 and VoIP phone have public IP addresses, Or
- Both GVC3200/GVC3202 and VoIP phone are under the same LAN / VPN using private or public IP addresses, Or
- NAT is disabled or GVC3200/GVC3202 NAT is disabled.

Both devices can be connected through a router using public or private IP addresses (with necessary port forwarding or DMZ).

To make a direct IP call, please follow the steps below:

1. Access the dial screen on GVC3200/GVC3202 LCD.
2. Press the red shortcut key on the remote control to bring up call mode setting screen, set the mode to "IP Call". This step is optional.
3. Input the target IP address. For example, if the target IP address is 192.168.124.123 and the port is 5062, input the following:
192*168*124*123#5062
The * key represents the dot (.) and the # key represents the colon (:).
4. Press the yellow shortcut key on the remote control to select "Audio Call" or "Video Call".
5. Press  on the remote control to dial out.



Paging/Intercom

Before placing paging/intercom, please make sure the callee has paging/intercom enabled so that it can answer the paging/intercom call automatically. To make paging/intercom call:

1. Access the dial screen on GVC3200/GVC3202.
2. Enter the number to dial followed by *74. Please refer to **Call Features** for more details.
3. Press the yellow shortcut key on the remote control to select "Audio Call" or "Video Call".
4. Press  on the remote control to dial out.

Answering a Call

When the device is in idle and there is an incoming video call made by SIP or IPVideoTalk account, the device will show the call screen as below:

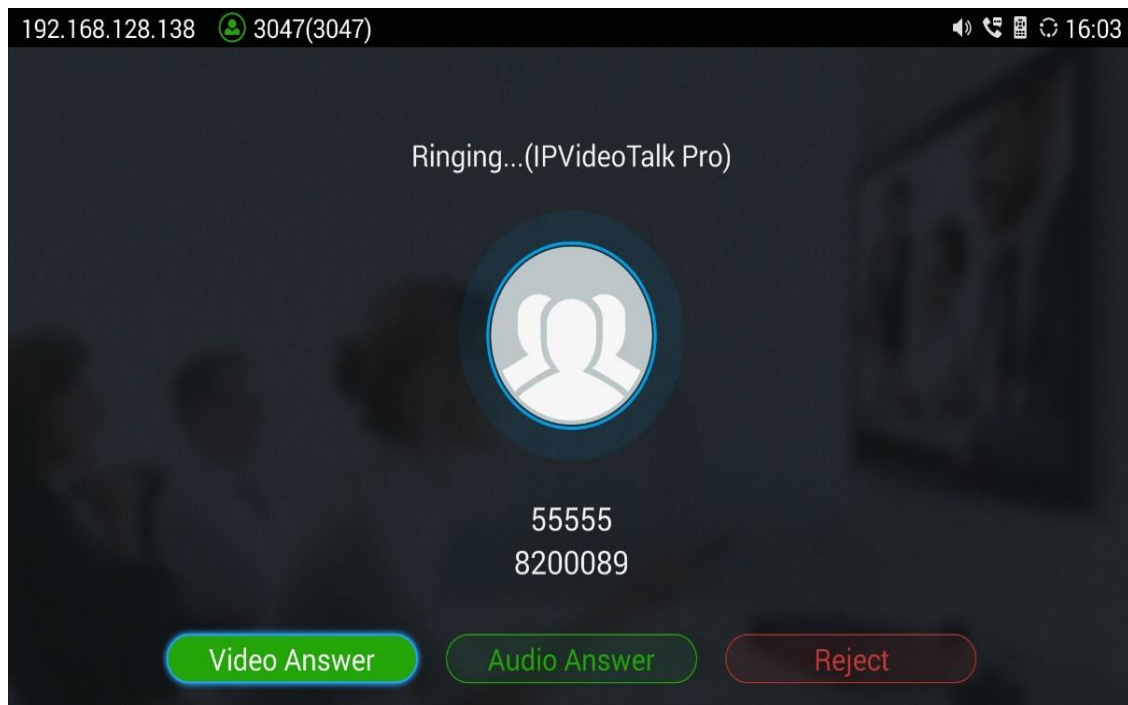

Figure 24: GVC3200/GVC3202 Single Incoming Call Screen

If the incoming video call is made by H.323 account, the call screen will display as below:

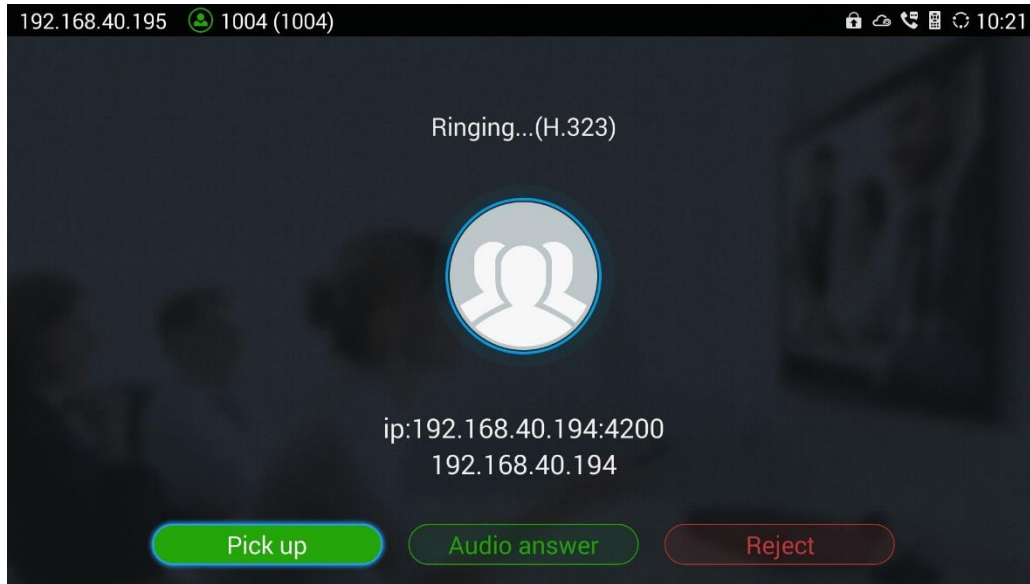

Figure 25: GVC3200/GVC3202 Single Incoming H.323 Call Screen

Select "Video Answer" or "Pick up" to answer the call with both video and audio, "Audio Answer" to answer the call with audio only, or "Reject" to reject the call.

When there is an incoming call during an active call, users will hear a call waiting tone with the LCD displaying the caller name and ID for the incoming call.

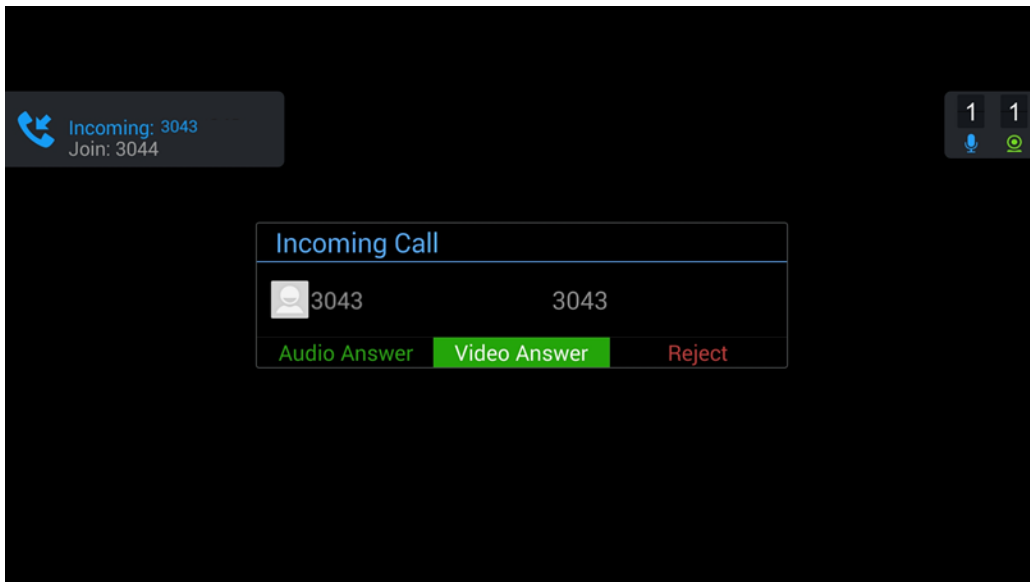



Figure 26: GVC3200/GVC3202 New Incoming Call Screen



Users could select "Audio" to answer with audio only, "Video" to answer with video and audio, or "Reject" to reject the call.

**Note:**

By default, answering a call during an active call will automatically add this party into the conference.

Call Hold

During an active call, press HOLD button  to put the call on hold.

- On the LCD display, click on  to resume the call.
- On the LCD display, click on  or press  on the remote control to end the call.

If the current call is a video call, the screen will not display remote video when the call is on hold.

Mute Local Audio

During an active call, press the MUTE button  to mute the call, press the button again to unmute the call.

Call Recording

During an active call, users could record the video to the external SD card plugged into GVC3200/GVC3202. Once recorded, users can view the recorded video in Recorder application, and download the video from web UI → **Maintenance** → **Recording**. For more details, please refer to the chapter **Recording**.

1. During an active call, press the recording key  on the remote control. A red Rec icon will show up on the upper left of the screen.
2. The recording files will be saved to the configured save path automatically when the call is finished.

Users could also press  on the remote control to stop recording anytime.

DND (Do Not Disturb)

When DND is on, the incoming calls to GVC3200/GVC3202 will be blocked without ringing. Users could see the blocked calls in call history. Once it is enabled, the DND icon  will be displayed in the



status bar on the top of the screen.

- When GVC3200/GVC3202 is in idle screen, users can press  button on the remote control to turn on/off DND.
- When GVC3200/GVC3202 is in an active call, users could turn on/off DND in call screen→MORE options. This will not affect the current call, and it will take effect starting from the next incoming call.
- At any time, users could log in GVC3200/GVC3202 web UI and click on “DND” on the top tool bar of the web page to turn on/turn off DND.

Missed Call



When there is a missed call, the call icon  on home screen will show the number of missed calls. Once accessed the dial screen, the reminder icon will disappear.

Call Forward

Call forward (Unconditional/No Answer/Busy/Time Based) can be set up from web GUI. Log in GVC3200/GVC3202 web GUI and go to **Settings→SIP Account→Call page**. For details, please refer to "GVC3200/GVC3202 Administration Guide".

Conference

Device Layout

GVC3200 supports up to 9-way video conference and GVC3202 supports up to 3-way video conference. GVC3200/GVC3202 can be the host to initiate a conference or join other conferences as a member.



Users can connect multiple HDMI output devices for conference. HDMI 1 interface is the primary output when plugging in multiple HDMI display devices. The device connected to HDMI 1 interface will display local site by default while other devices automatically display remote sites. If the VGA/HDMI IN device is plugged in to GVC3200/GVC3202, the device connected to HDMI 1 interface displays presentation of VGA/HDMI input while other devices will display video view.

During a conference, user can tap on  button on GVC3200/GVC3202 remote control trackpad to go back to HOME screen, with the conference video displayed in the background.



Initiating Conference

The conference can be initiated in multiple ways:

- **From Call Screen:**
 1. Access the call screen, enter the number in the text box or select members from the list below.
 2. Press  on the remote control or click on button  on the screen to dial out.
- **From Schedule:**

For more details, please refer to section **Schedule**.

Answering an Incoming Call in Conference

You can specify how your GVC3200/GVC3202 handles incoming calls. Depending on your configuration, your GVC3200/GVC3202 answers a call automatically or prompts you to answer a call manually:

- Log in GVC3200/GVC3202 web GUI and go to **Settings**→**SIP Account**→**Call page**, and set "Auto-answer" option to "Yes". All incoming calls will be answered automatically. If it is a video call, it will be answered with video as well.
- If "Auto Answer" is set to "No", users will need to select to answer with video manually, audio or reject the call using the remote control on the LCD prompt.
- If the conference host answers the call, the caller will join into the current active conference.

Conference Management

The following figure shows a 3-way conference:

















Figure 27: GVC3200/GVC3202 3-Way Conference

On the bottom of the call screen, users will see a list of icons for menu options. This menu will be automatically hidden if there is no operation in 5 seconds. Press any key to bring up the menu options again. Here are the functions for each icon.

Table 16: GVC3200/GVC3202 Call Screen Bottom Menu Icons

Icons	Name	Definitions
	Add Member	Access dial screen and add more numbers to join conference.
	Delete Member	Select member to remove from the conference.
	Record	Start/Stop recording the ongoing conference. The recording files will be saved to the configured Save Path automatically.
	Conference Control	Control video and audio for conference members. It includes the following options for each party: <ul style="list-style-type: none">  - The selected party will not be heard by other parties.  - The selected party will not hear other parties.  - The video call with the selected party will turn into audio call. If the user clicks on this icon again, a video invitation will be sent to this party. The party has to accept the video request in order to see the video again.

		 - Suspend video from the video party. Click on it again to resume video.
	<p>Layout</p>	<p>Adjust the layout for the video display for video call.</p> <p>The layout options might vary depending on how many video participants are in the call, how many HDMI outputs are connected and whether presentation is turned on or not.</p> <p>For example, in a two-way video call on GVC3200 which has one HDMI output connected, after pressing “Layout” icon, users will see options “Average”, “Remote (Local)”, “Local (Remote)”, “Remote” and “Local”.</p>
	<p>Hold</p>	<p>Pause/resume conference. Once the conference is paused, the device will stop sending local video/audio to the remote parties.</p>
	<p>Presentation</p>	<p>Turn on/off presentation.</p> <p>HDMI IN or VGA IN must be plugged in first. When HDMI IN or VGA IN is plugged in to GVC3200/GVC3202, after the user selects “Presentation”, the user can select mode “Auto” or “PC” to display presentation.</p> <ul style="list-style-type: none"> Presentation Mode: Auto The GVC3200/GVC3202 that shares presentation will send dual stream. The other participants will receive two streams and can select to display both presentation + video at the same time. If the other participants do not support BFCP, the GVC3200/GVC3202 that shares presentation will only send presentation stream and the participant can show presentation. Presentation Mode: PC The GVC3200/GVC3202 that shares presentation will only send presentation stream, no local video stream. The other participants only see presentation.
	<p>More</p>	<p>Bring up more options. The options include:</p> <ul style="list-style-type: none"> DND Enable or disable DND. Call details Display call details such as video packet loss rate, video bit rate, video frame rate, video codec, video resolution, audio packet loss rate, audio bit rate and audio codec for both sending and receiving parties.



		<ul style="list-style-type: none"> • Open DTMF To enter DTMF during the call. • PIN code This is to set a PIN code to lock this conference call. Once the conference call is locked, the caller who wants to join this conference by calling the conference host must enter the PIN code. • Third party application. This option is only available when there is application such as Skype installed on GVC3200/GVC3202.
	End	End conference and go back to home screen.







- If the remote party is also a GVC3200/GVC3202, you can press the camera key  on the remote control to control PTZ device for the remote party.
- Users could press the red/blue/yellow shortcut keys on the remote control to input DTMF, view notifications and view status.
- During an active conference call, if there is a new member joining conference, an outgoing call failed or a member hanging up, there will be a prompt box on the left side of the conference screen showing notifications. The notification prompt will be hidden automatically if there is no new notification in 2 seconds.
- On the right side of the video conference screen, users can see member status such as audio/video calls, or whether if the call is being muted.



Table 17: GVC3200/GVC3202 Conference Member Status Descriptions

Icons	Descriptions
	The current line is in an audio call.
	The current line is in a video call.
	The current line is being muted.
	The current line is not connected.

- On the upper left side of the video conference screen, users can see an icon  to indicate network unstable condition, which means the current network condition is not good enough for the video call using the selected resolution/bit rate.

Invite Members to Conference

Users could use one of the following ways to add members:

- Access the dial screen by clicking on the ADD icon  on conference screen. Then, enter the number to dial out. Once the member answers the call, it will be connected into the conference automatically.
- When GVC3200/GVC3202 is on conference screen, press on  the remote control to access the call screen. Then, enter the number to dial out. Once the member answers the call, it will be connected into the conference automatically.
- The member calls the conference number. If the host answers the call, the member will be added into conference automatically.

Removing Member from Conference

To remove a member from the conference, click on the DELETE icon  on conference screen. Select the member from the member list and press "OK" key to delete it.

Conference Control

Tap on  to make operations such as mute, disable sound, camera control and suspend video. The conference control screen is as shown below:

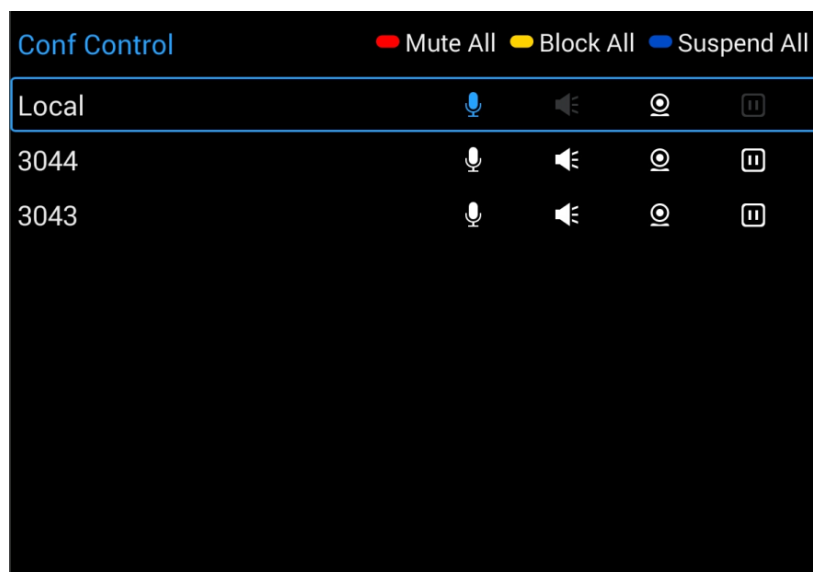



Figure 28: GVC3200/GVC3202 Conference Control Screen

1. Use Up/Down navigation keys on GVC3200/GVC3202 remote control to select conference member.
2. Use Left/Right navigation keys on GVC3200/GVC3202 remote control to make operations, press "OK" key to confirm the operation, press "OK" key again to cancel, e.g. tap on  to mute one member and the icon will turn to  tap on it again to restore.

**Note:**

Users could press the shortcut keys on GVC3200/GVC3202 remote control on conference control screen to mute all, block all or suspend videos.

Pause Conference

The video will be stopped if the conference is paused. You will not see the video view of the members and the other members will not see your video either.

**Note:**

1. The new incoming call will be rejected if the conference is paused.
 2. The presentation will be displayed normally when the conference is paused.
-

Custom PIP

During a video conference, users can customize screen layout when using multiple connected HDMI outputs, to specify particular video feeds to be displayed on each screen.

- Under GVC **Call screen**→**Layout**→**PIP**, users can choose which video feed to be selected.



Figure 29: Select Video Feed

- A selection window for the available monitors will pop up, in order to select which output will display the video streaming for the feed selected in previous step (In this example “Local” feed will be displayed on “HDMI 1 Output Screen”).

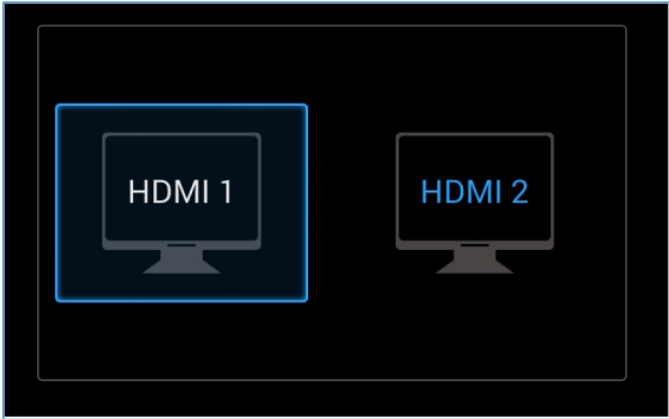

Figure 30: Choose HDMI Output

Presentation Sharing



GVC3200/GVC3202 supports dual stream video, with the presentation sharing function, you can connect VGA/HDMI input devices such as a computer, or a DVD player to GVC3200/GVC3202, and share the VGA/HDMI input sources with remote parties while they can still view the local video.

The following figure shows 3 TVs used for GVC3200/GVC3202. The one on the top shows presentation, the two on the bottom show remote party video.



Figure 31: GVC3200/GVC3202 3-Way Conference with Presentation

**Note:**

1. When both HDMI IN interface and VGA IN interface are connected, GVC3200/GVC3202 will only display the device connected to HDMI IN port.
 2. Users could also press PIP button  on GVC3200/GVC3202 remote control to change video display layout. This will bring up the same options as pressing icon  on the bottom menu.
-

Conference Recording

During a video conference, recording feature is supported on the GVC3200/GVC3202, including video and presentation shared by GVC3200/GVC3202, or IPVideoTalk WebRTC clients. For more details about IPVideoTalk, please refer to the chapter **IPVIDEOTALK**.

- If Auto presentation mode turns on, only the presentation is recorded.
- If PC presentation mode turns on, the presentation and local video stream are recorded.
- If presentation mode turns off, dual video streams are recorded.

During conference, a new option of cloud recording is added to allow users to control recording, the recording can be done from GVC screen or Web UI as shown below:



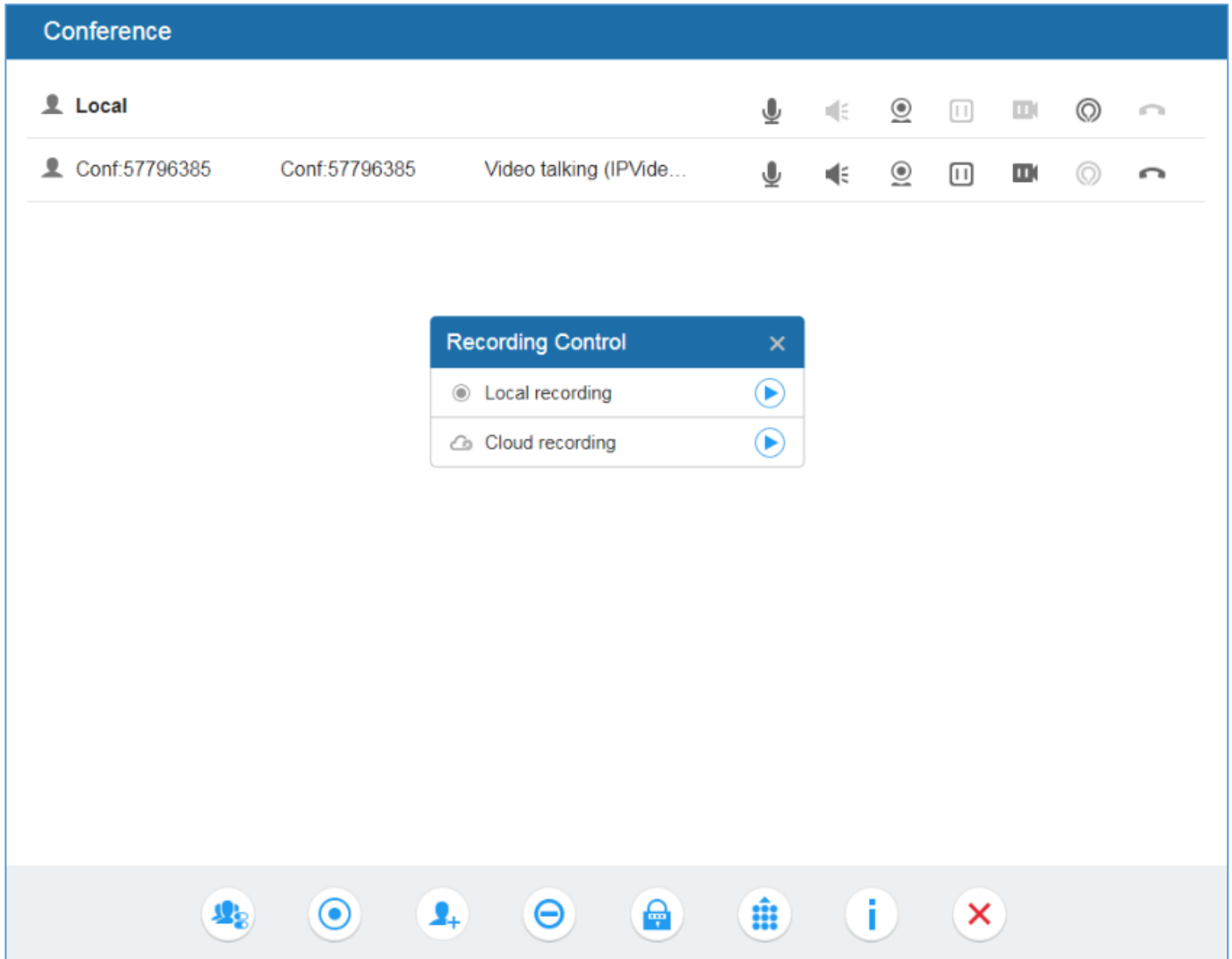





Figure 32 : Web UI Conference Recording

For more details about local recording, please refer to **Recording**.

For more details about cloud / IPVideoTalk recording , please refer to the chapter **IPVIDEOTALK**.

1. Press  on the GVC3200/GVC3202 remote control or the recording icon  on bottom menu to start recording.
2. The recording files will be saved to the configured save path automatically when the call is finished.

Users could also press  on the remote control or the recording icon  on bottom menu to stop recording anytime.

**Note:**

The recording files saved on internal storage have size limitation of 1G, so it is strongly recommended to use an SD card or USB storage device with large capacity for call recording purpose.

Participants List

Users could check all participants in the current IPVideoTalk meeting. If the meeting host does not allow the participants to check all members, the participants cannot see all members in the meeting.

During IPVideoTalk meeting, click on “More”  then click on "Participants List". GVC320x will show all participants in the current IPVideotalk meeting, including all participants with all types of clients.

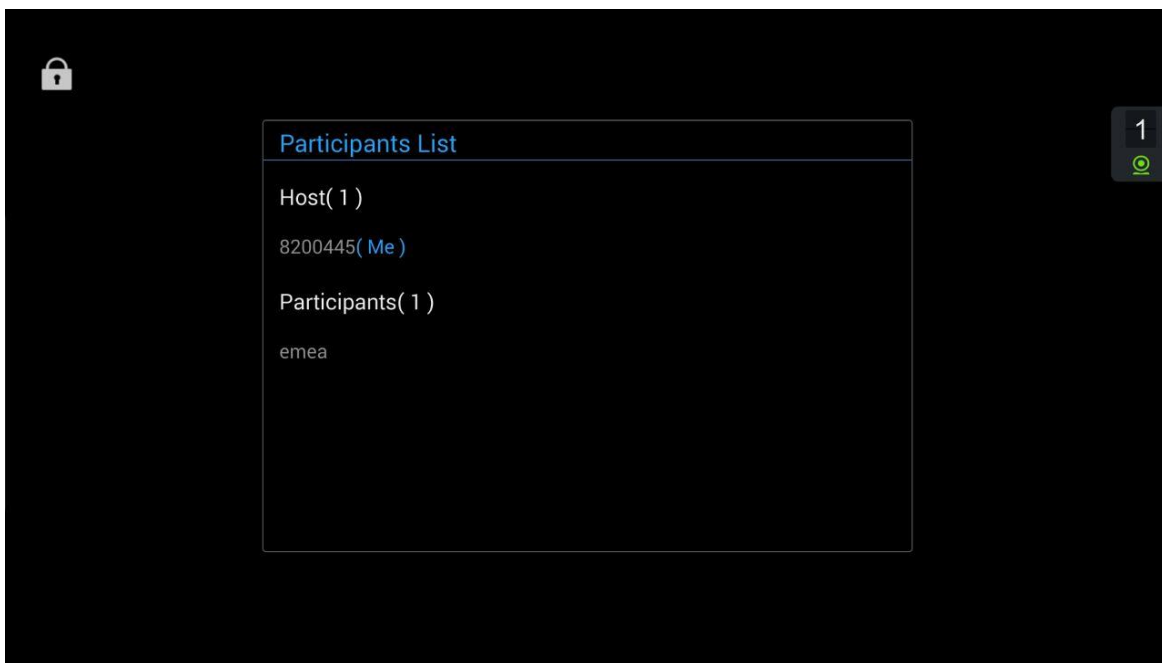

Figure 33: GVC3200/GVC3202 Participants List

Call Details

Users could view audio and video details of the conference members. On the conference screen, click on



and select "Call Details" to check the details.



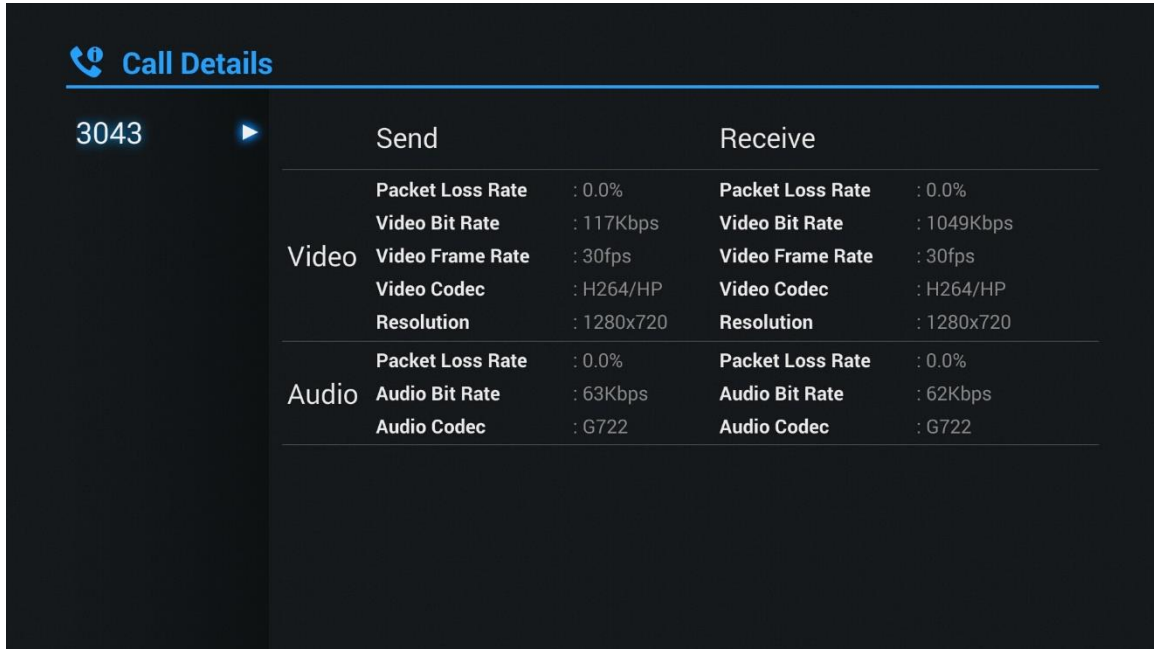



Figure 34: GVC3200/GVC3202 Call Details Screen

Enabling DND During Conference

When DND is enabled during conference, the new incoming calls will be blocked. On the conference screen, use GVC3200/GVC3202 remote control to click on MORE button  and select "DND".

The icon  will be displayed on conference screen if the device is set to DND mode. To disable DND, select DND mode again and press "OK" key to cancel it.



Note:

After enabling DND mode during a conference, the DND mode will remain effective after the conference is over. To disable DND, please press  on GVC3200/GVC3202 remote control when there is no active call.



Conference Lock

Users could lock/unlock the scheduled conference. Once it is locked, the other incoming calls will not be able to join the conference.

The locked scheduled conference will display  icon on the screen.

Open DTMF

Users can dial DTMF during a conference.

1. On GVC3200/GVC3202 remote control, press the red shortcut key, or click on MORE button 
→select "Open DTMF" on the conference screen to bring up the DTMF input screen.
2. Press the digital keys on the remote control to input DTMF. Press  to cancel the operation if needed.

PIN Code

During the conference call, the conference host can set a PIN code to lock the call. Once the conference call is locked, the caller who wants to join this conference by calling the conference host must enter the PIN code.

Here is how to use PIN code to lock the conference call:

1. During the call, in the GVC3200/GVC3202 display LCD call screen bottom menu, select MORE →PIN Code.

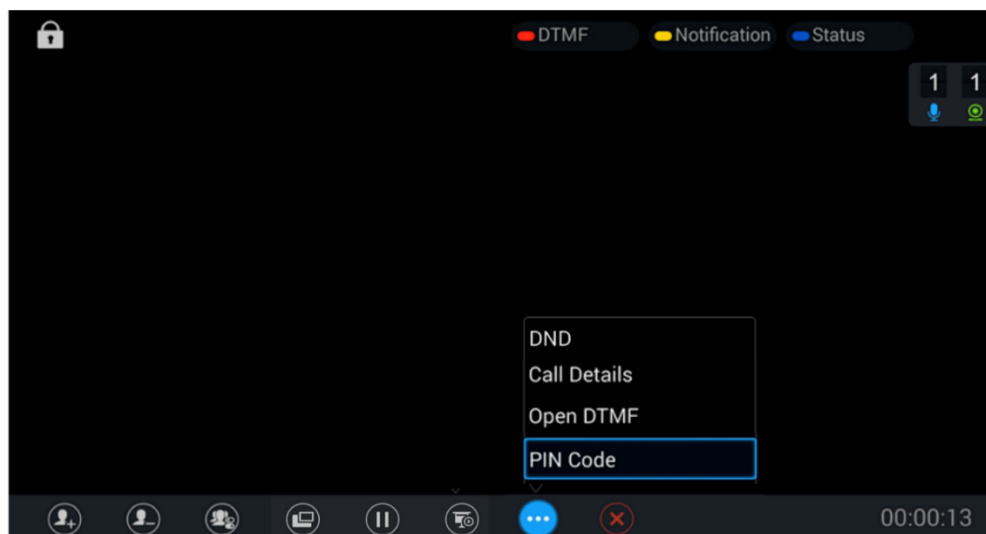

Figure 35: GVC3200/GVC3202 Call Screen→More→PIN Code

2. Enter the PIN Code to lock the conference call. If it's empty, the conference call is not locked. Click on OK to confirm.



Figure 36: Enter PIN Code to Lock Conference

3. Now the conference call is locked. If someone wants to join the conference call by calling this GVC3200/GVC3202, the same PIN code will be required to be entered before the call goes through.

Here is an example on how to use PIN code to enter the locked conference call:

1. Make a video call to the GVC3200/GVC3202 that has locks the conference call from another GVC3200/GVC3202.
2. The GVC3200/GVC3202 caller will show a video windows with voice prompt asking for PIN code.
3. On the GVC3200/GVC3202 caller's call screen bottom menu, select MORE → Open DTMF. Then input the DTMF with PIN code followed by #.

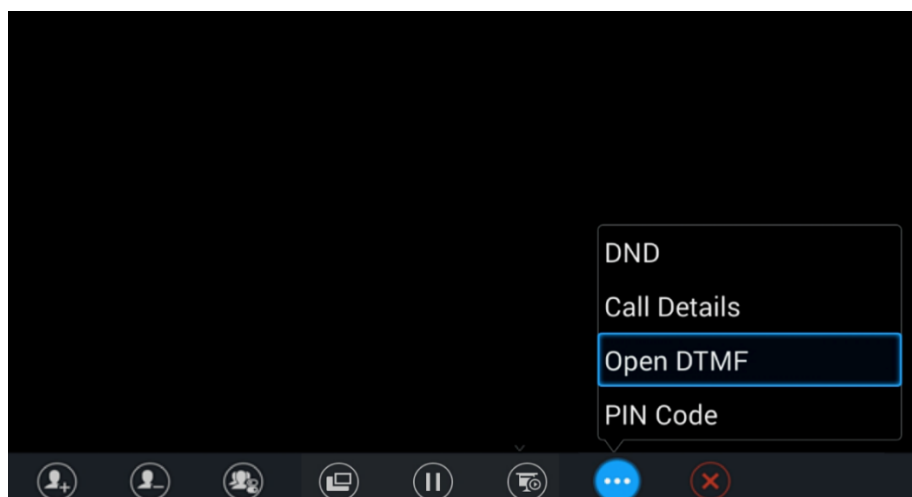



Figure 37: Input PIN Code from DTMF to Join Conference

4. The GVC3200/GVC3202 caller joins the conference call after entering correct PIN code in DTMF.

Third Party Applications

GVC3200/GVC3202 runs Android Operating System and offers full access to the thousands of Android apps in Google Play Store, including Skype for Business, Google Hangouts and etc. The calls using certain apps can be mixed with the SIP call so that they can be brought into the same conference on GVC3200/GVC3202.

For example, to use third party app Skype during a conference:

1. Install Skype and sign in.
2. Establish a conference call on GVC3200/GVC3202.
3. On the conference screen, click on MORE button  and select "Third party applications".
4. Press "OK" key, and select "Skype" in the pop out menu.
5. Search contacts in Skype and dial out.
6. The new call will be added to conference.



Note:

- When the call is mixed, GVC3200/GVC3202 and the remote party using the app can see video from all parties. The remote SIP party can only see video from GVC3200/GVC3202. All parties can hear each other.
- **For Skype application downloaded from GS Market only**
GVC3200/GVC3202 supports video mixing so that the remote SIP party can receive video feed from Skype. This currently only works when there is only one SIP/H.323 line in the call, and the Skype application must be downloaded from GS Market on the GVC3200/GVC3202. Here are the steps to use this feature:
 1. GVC A establishes video call with another GVC B using SIP account.
 2. On GVC A, during the SIP call, select More→Add third party and select Skype app.
 3. On GVC A, establish Skype call with PC Skype client. Now the call is mixed.
 4. If GVC A currently shows Skype app interface, press GVC A's remote control's BACK button to exit this Skype app interface. This will enable Skype video mixing and a message "Skype video mixing is on" will pop up on the screen. The user can then navigate to the normal SIP call interface using the GVC remote control. On the remote party GVC B, the user will see mixed video of both Skype and GVC A.
 5. If going back to the Skype call interface again, it will automatically disable Skype video mixing. The remote party GVC B will see the video from GVC A only, instead of the mixed video.
 6. Navigate as indicated in step 4 to enable Skype video mixing or step 5 to disable it.



FECC - Camera Control in Conference

During the video call, if the local party (GVC3200/GVC3202) and remote party support FECC, the remote camera can be controlled on the GVC3200/GVC3202.

Here is how to use FECC on the GVC3200/GVC3202 to control remote party's camera:

1. Make sure the GVC3200/GVC3202 and the remote party support FECC and it's enabled on both parties. For GVC3200/GVC3202, FECC setting is under web UI→**Settings**→**Account Settings**→**Codec**: "Enable FECC". If the remote party is another vendor's video device, please check the documentation from the vendor to enable FECC.
2. Establish video call between GVC3200/GVC3202 and the remote party.
3. On the GVC3200/GVC3202 remote control, press the camera button  and the following prompt pops up on GVC3200/GVC3202 display device.

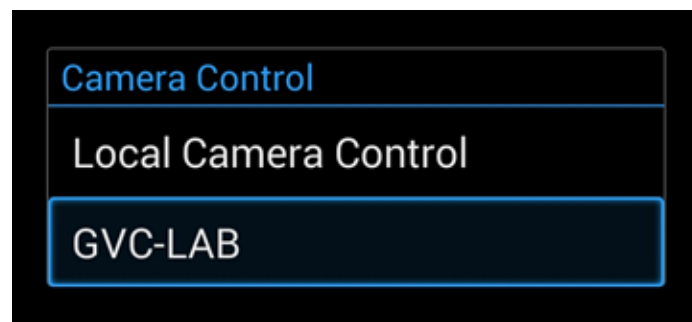





Figure 38: FECC – Remote Camera Control

4. Use UP/DOWN/OK navigation keys on the GVC3200/GVC3202 remote control to select the remote party, e.g., GVC-LAB in the above figure. This will bring up camera control interface.
5. On the GVC3200/GVC3202 remote control, press the navigation keys and zoom in/zoom out buttons on trackpad to adjust remote camera.

End Conference

To end the conference, tap on END button  or press key  on GVC3200/GVC3202 remote control to either "Exit Conference" or "End Conference". If GVC3200/GVC3202 is the conference host:

- Select "Exit conference" so that the GVC host will leave the conference itself while the IPVT conference will still be going on. The GVC host can join back the conference by pressing the remote control's button   in order to continue/end the meeting.

Note: The conference can be ended by WebRTC host or admin through web portal afterwards as well.

- Select "End conference" so that the IPVT conference will be ended and all of the other participants will be disconnected from the IPVT server.



If the conference member hangs up the call, it will be disconnected from the conference, but other parties in the conference will stay in the conference.



Figure 39: End Conference

End Meeting Reminder

The maximum duration of an IPVT meeting is 6 hours, a prompt will be shown during meeting 5 minutes before the server ends the meeting. This is a reminder for customers during the meeting to alarm them that they are exceeding the maximum duration so that they can take necessary actions.

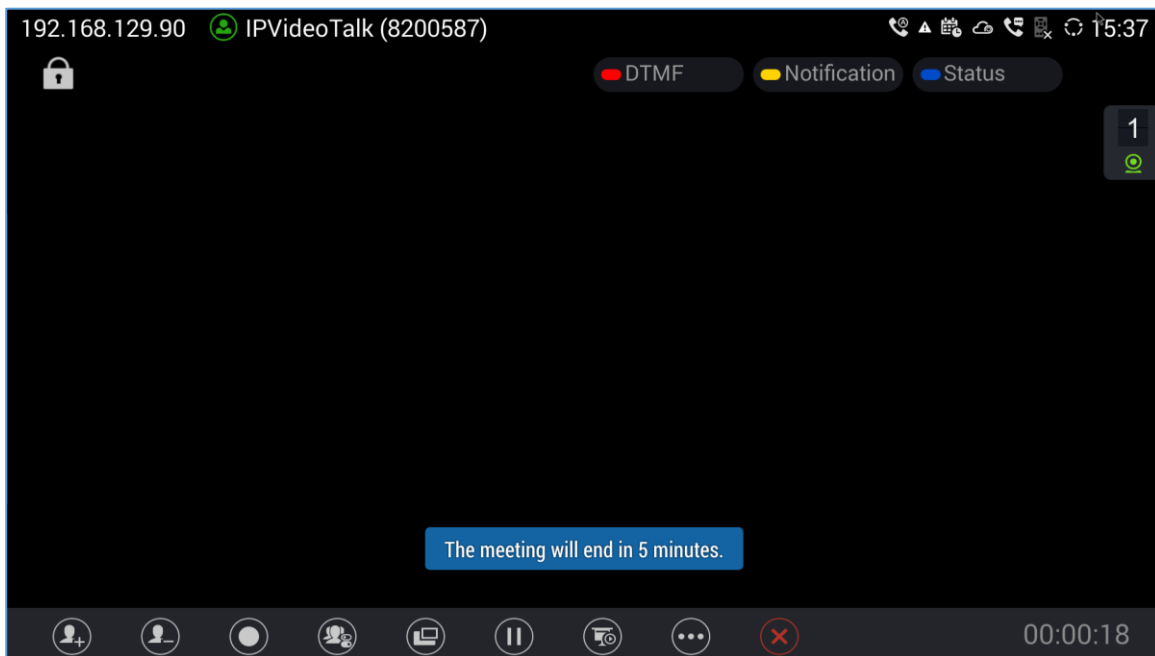

Figure 40: End Meeting Reminder

Power Off During a Conference Call

During the meeting, if the user presses Power ON/OFF button, a new dialog will be prompted that allows user to end the current call and shutdown GVC320x immediately. Choose "Power off" to end the

conference call and power off the GVC320x immediately, or choose “Power off when idle” to shut down the device when the conference call is ended.

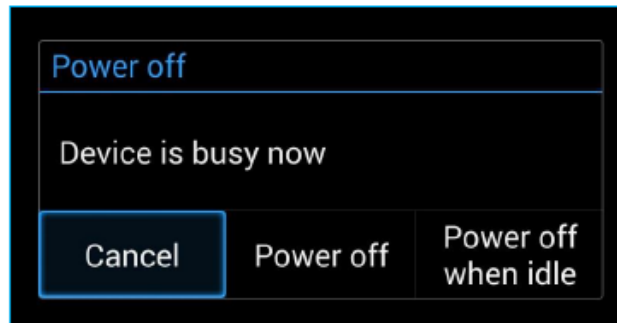

Figure 41: Power Off During a Call

Schedule

Schedule feature allows users to set a specific time to host a conference in advance, with conference reminder and members.

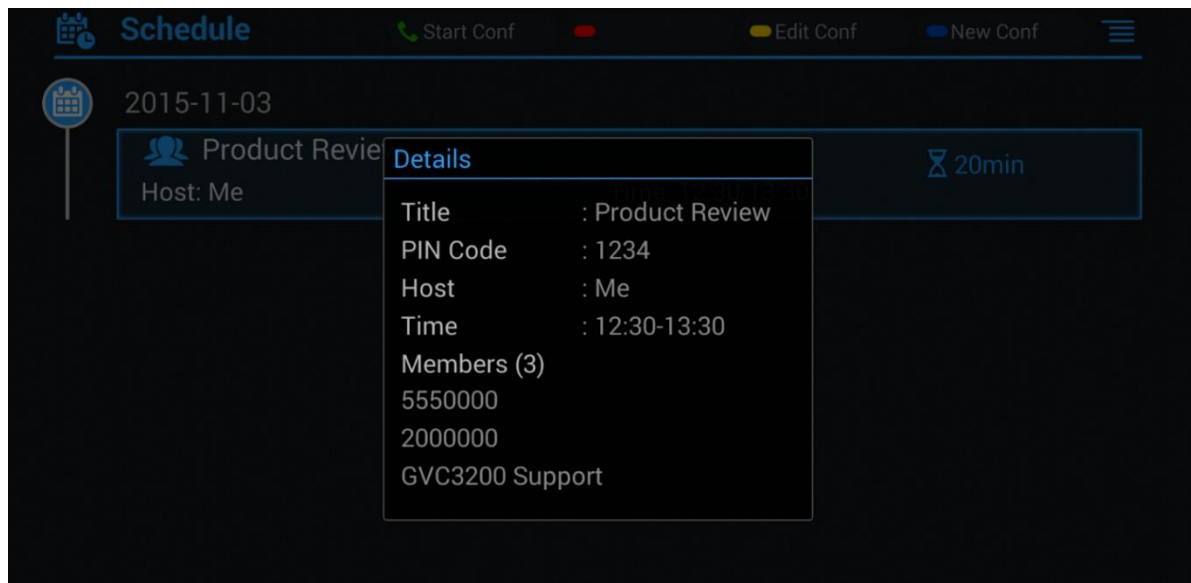





Figure 42: GVC3200/GVC3202 Schedule Screen

Follow one of the ways below to access schedule conference screen:

- On the home screen, click on CONFERENCE button .
- On the home screen, click on APPLICATION button  and select .
- Users will see the scheduled conferences (after the current time) in the schedule screen. Select one conference entry to view details.



Note:

Conferences that have been held in the past will not be displayed in the schedule screen.

View Conference Details

Users could view scheduled conference details after the current time. Select one conference and press "OK" key on GVC3200/GVC3202 remote control to view conference details.

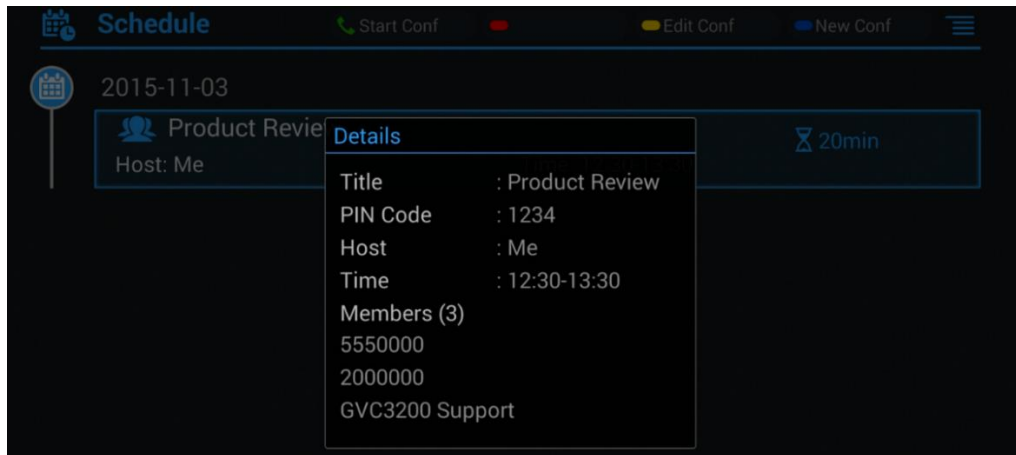



Figure 43: GVC3200/GVC3202 Conference Details Screen

Add Scheduled Conference

Follow the steps below to add a scheduled conference:

1. On the home screen, select  to access schedule screen.
2. On GVC3200/GVC3202 remote control, press the yellow shortcut key to create a new conference.

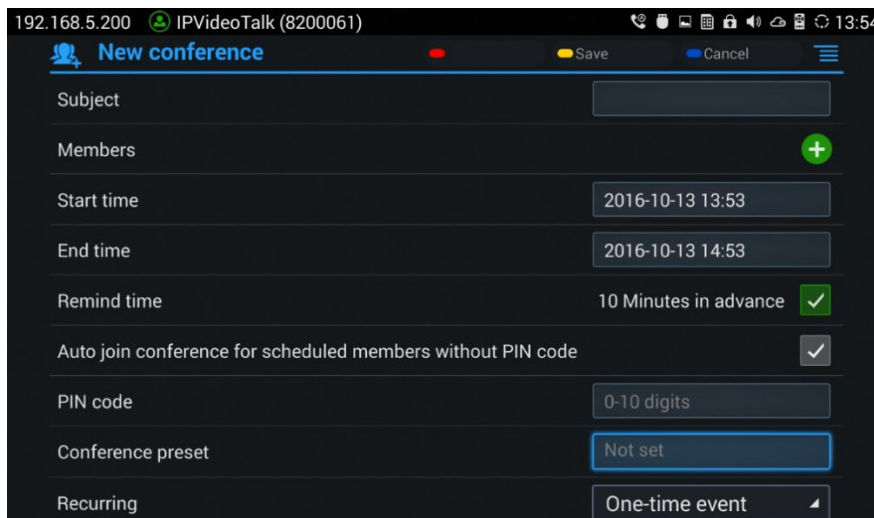



Figure 44: GVC3200/GVC3202 Add Conference Screen



3. Fill in conference name, members, start time, conference duration and etc.
4. Press the yellow shortcut key on the remote control to save the scheduled conference.

Table 18: GVC3200/GVC3202 Add Conference Parameters

Parameters	Descriptions
Subject	It is used to set the conference name to identify this conference.
Members	Click on button  to access the Add Member screen. Users can add one member or a group of members. Press the yellow key on the remote control to save and go back to schedule screen. Up to 8 members can be added.
Start Time	It is used to configure the start time of the conference.
End Time	It is used to configure the end time of the conference.
Reminder Time	It is used to configure whether to remind users in advanced. A prompt dialog box will pop up on GVC3200/GVC3202 screen 10 minutes before the conference starts.
Auto Join Conference for Scheduled Members without PIN Code	It is used to configure whether PIN code is required when the scheduled members join the conference. If enabled and the scheduled conference has PIN code configured, the scheduled members will automatically answer the call without PIN code required.
PIN Code	Configure PIN code for the conference. It can be number 0 – 9 and up to 10 digits can be configured as PIN code.
Conference preset	It is used to select a camera preset when the scheduled conference starts, the GVC3200/GVC3202's camera will be automatically placed to the preset position. Click on Conference preset and select "Custom" to be redirected to preset setting interface to configure and set a preset. Default is "Not set".
Recurring	Users could select recurring for the scheduled conference, to repeat the conference depending on the chosen option. The recurring options are: <ul style="list-style-type: none"> • One-time event • Daily • Every Weekday (Mon-Fri) • Weekly • Monthly (by week) • Monthly (by day) • Yearly • Custom





Edit Scheduled Conference

Follow the steps below to edit scheduled conference:

1. Access conference schedule screen and select the conference entry users would like to edit.
2. Press the blue shortcut key on GVC3200/GVC3202 remote control to access edit screen.
3. Press the yellow shortcut key on the remote control to save changes, and go back to schedule screen.

Reschedule Conference

1. Access schedule screen and select the conference entry users would like to edit.
2. Press the MENU key  on GVC3200/GVC3202 remote control, and select "Reschedule" option.
3. Set new conference start time in the pop out dialog box.
4. Click on SAVE button to save changes. If users would like to cancel the changes, users could press  on the remote control, or click on CANCEL button on the screen.

Delete Scheduled Conference



Follow the steps below to delete the existing scheduled conference:

1. Access schedule screen and select the conference entry users would like to delete.
2. Press the MENU key  on the remote control, and select "Delete".

Voicemail

When there is a new voicemail, voice mail icon  will show up as a notification in the status bar. Users could login the web UI → **Settings** → **Account** → **General Settings** to configure the access number for the voicemail.

Follow the steps below to access voicemail:

1. Access the dial screen and input voicemail access number.
2. Press  on GVC3200/GVC3202 remote control, or click on button  on the call screen to dial into the voicemail box.
3. Follow the Interactive Voice Response (IVR) for the message retrieval process.

Users could also go to **Home screen** → **Applications** and click on "Voice Mail" to access the voicemail box. The number of new voicemail messages will be shown on the voice mail app icon as well. See figure below:



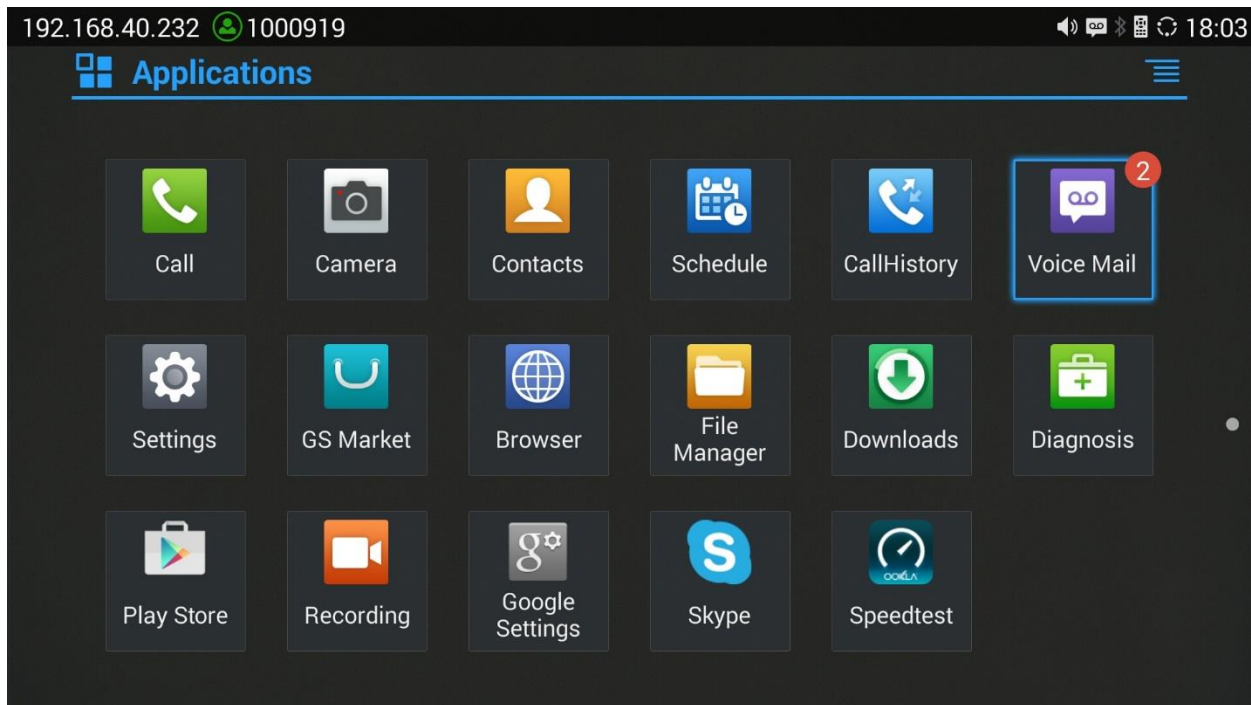

Figure 45: GVC3200/GVC3202 Voice Mail Application

Call Features

The GVC3200/GVC3202 support traditional and advanced telephony features including caller ID, caller ID with caller Name, call waiting, call forward and etc for the SIP account. Before using the following feature code, please make sure "Enable Call Features" option is set to "Yes" under web GUI → **Settings** → **SIP** → **Call page**. Please note this feature doesn't apply to IPVideoTalk account or BlueJeans account.

Table 19: GVC3200/GVC3202 Feature Code for SIP Account

*01	<p>Use Preferred Codec (per call).</p> <ul style="list-style-type: none"> • Dial *01 followed by the preferred codec code and the phone number. • The device will use this codec in the INVITE SDP as the first codec when initiating the call. • Codec code: PCMU: 7110 PCMA: 7111 G722: 722 G722.1: 7206 <p>For example, if the user would like to use PCMA as the preferred codec to call phone number 334455, enter *017111334455. Please note the actual codec being used might be different, which is the negotiation result between the endpoints and SIP server.</p>
------------	---

*02	<p>Force Codec (per call).</p> <ul style="list-style-type: none"> • Dial *02 followed by the preferred codec code and the phone number. • The device will be forced to use this codec during the call. • Codec code: PCMU: 7110 PCMA: 7111 G722: 722 G722.1: 7206 <p>For example, if the user would like to force using PCMA to call phone number 334455, enter *017111334455.</p>
*16	<p>Enable and force SRTP for all subsequent calls.</p>
*17	<p>Disable SRTP for all subsequent calls.</p>
*18	<p>Enable SRTP per call.</p>
*19	<p>Disable SRTP per call.</p>
*30	<p>Block Caller ID (for all subsequent calls).</p> <ul style="list-style-type: none"> • Dial *30.
*31	<p>Send Caller ID (for all subsequent calls).</p> <ul style="list-style-type: none"> • Dial *31.
*50	<p>Disable Call Waiting.</p> <ul style="list-style-type: none"> • Dial *50.
*51	<p>Enable Call Waiting.</p> <ul style="list-style-type: none"> • Dial *51.
*67	<p>Block Caller ID (per call).</p> <ul style="list-style-type: none"> • Dial *67 followed by the phone number.
*82	<p>Send Caller ID (per call).</p> <ul style="list-style-type: none"> • Dial *82 followed by the phone number.
*70	<p>Disable Call Waiting (per Call).</p> <ul style="list-style-type: none"> • Dial *70 followed by the phone number.
*71	<p>Enable Call Waiting (per Call).</p> <ul style="list-style-type: none"> • Dial *71 followed by the phone number.
*72	<p>Unconditional Call Forward. To set up unconditional call forward:</p> <ul style="list-style-type: none"> • Dial *72 followed by the phone number to forward the call.
*73	<p>Cancel Unconditional Call Forward. To cancel the unconditional call forward:</p> <ul style="list-style-type: none"> • Dial *73.



*74	Paging Call. <ul style="list-style-type: none">• Dial *74 followed by the phone number to send the paging call.
*83	Force Audio Calling (per call). <ul style="list-style-type: none">• Dial *83 followed by the phone number to send the audio call.
*84	Force Video Calling (per call). <ul style="list-style-type: none">• Dial *84 followed by the phone number to send the video call.
*90	Busy Call Forward. To set up busy call forward: <ul style="list-style-type: none">• Dial *90 followed by the phone number to forward the call.
*91	Cancel Busy Call Forward. To cancel the “busy call forward”: <ul style="list-style-type: none">• Dial *91.
*92	Enable Call Forward No Answer. To set up Call Forward No Answer: <ul style="list-style-type: none">• Dial *92 followed by the number to forward the call. The default timeout before the call is forwarded is 20 seconds.
*93	Cancel Call Forward No Answer. To cancel Call Forward No Answer: <ul style="list-style-type: none">• Dial *93.



ADDITIONAL FUNCTIONS

GVC Remote Client Application

Besides using GVC3200/GVC3202 Bluetooth remote control in the package, users could also download the Grandstream GVC Remote Client application, and install it on an Android device. GVC3200/GVC3202 remote control application is used via Bluetooth protocol. Follow the steps below to install the remote control application:

1. The GVC Remote apk for Android can be found under **GVC3200/GVC3202 LCD menu→Applications→File Manager→Internal storage→remote firmware**. Users could also directly send the apk file via Bluetooth to your Android device or use the QR code to download to your Android device. Please go to **GVC3200/GVC3202 LCD menu→Settings→Status→Remote control** to send GVC Remote apk to Bluetooth device or scan the QR code.

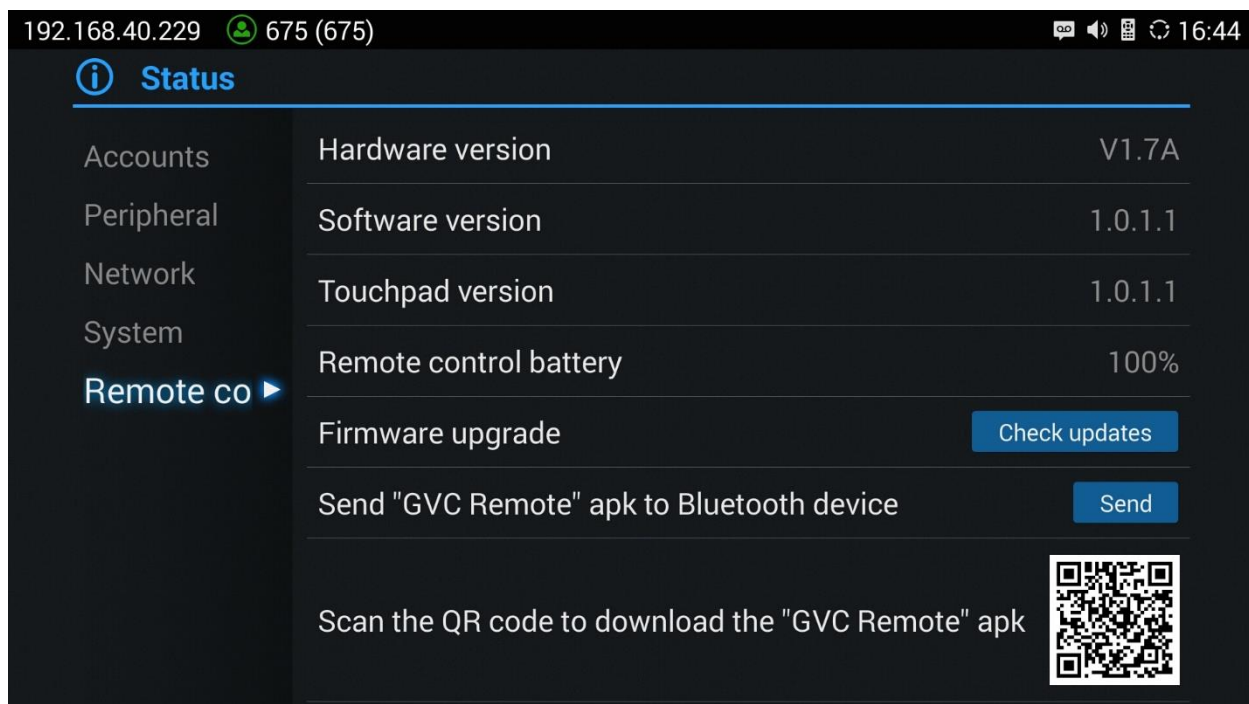

Figure 46: “GVC Remote” apk in GVC3200/GVC3202 LCD Menu→Settings→Status→Remote Control

2. Once GVC Remote app is installed on your Android device, open it and access settings screen.
3. Select the GVC3200/GVC3202 device that users would like to connect to. Each discovered GVC3200/GVC3202 could be distinguished by the last 6 digits of its MAC address.
4. Pair GVC Remote app with GVC3200/GVC3202 via Bluetooth. Users might see prompt on GVC3200/GVC3202, and Android device to confirm the passcode during pairing and connection process.



- After pairing and connecting the remote control application, users can use the keys and options on the Android device touch screen to control GVC3200/GVC3202.

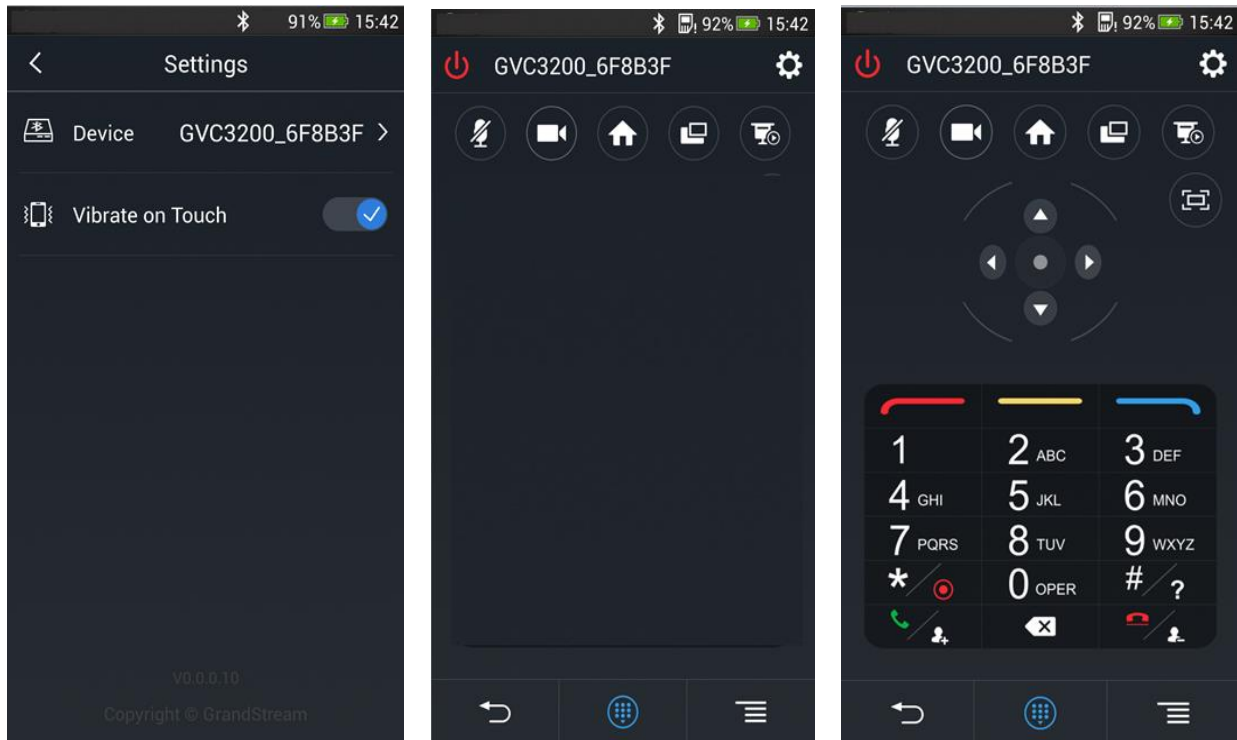





Figure 47: GVC3200/GVC3202 Remote Control Application on Android Device



- Tap on button  at the upper right corner to access settings screen as the left figure shows above.
- Tap on button  to go back to home screen as the figure in the middle shows above.
- Tap on button  to bring up navigation panel and digital keyboard as the right figure shows above, tap on  again to hide the keyboard.

For more information about how to use GVC remote apk on your Android device, please refer to the GVC3200/GVC3202 remote control client quick start guide below:

http://www.grandstream.com/sites/default/files/Resources/GVC320x_Remote_Control_Client_Quick_Start_Guide.pdf

BlueJeans

GVC3200/GVC3202 has built-in BlueJeans access for users to dial BlueJeans calls. Follow the steps below:

1. On the LCD dial screen, press the blue shortcut key on GVC3200/GVC3202 remote control to switch call mode from SIP Call to BlueJeans Call.
2. When the call mode shows BlueJeans, input Blue Jeans conference ID and conference password.
3. Press  on the remote control or click on button  on the screen to dial out.

For more information about how to use BlueJeans on GVC3200/GVC3202, please refer to the link below:
http://www.grandstream.com/sites/default/files/Resources/gvc320x_BlueJeans_application_note.pdf





APPLICATIONS

GVC3200/GVC3202 provides built-in applications such as Contacts, Call History, File Manager, Browser and etc. Users could also download the apps from GS market or Google Play Store to install on GVC3200/GVC3202.

Contacts

GVC3200/GVC3202 Contacts app helps users to easily store and manage phone numbers and contacts information. Users can add contacts on GVC3200/GVC3202 or import contacts from external devices as well as download from a server.

On GVC3200/GVC3202 home screen, click on Contacts icon , or go to Applications, and select  to access contacts app.

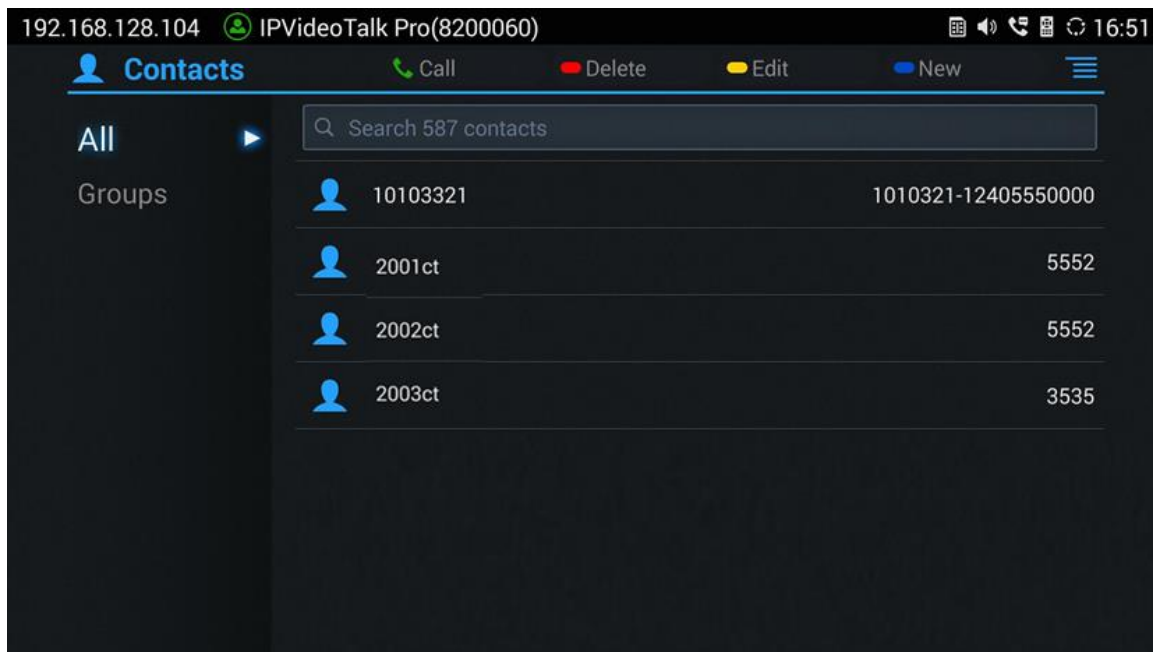





Figure 48: GVC3200/GVC3202 Contacts Screen

- **All**
It is used to display all contacts.
- **Groups**
It is used to view groups. Select one group to view group details.
- **Call**

Select the contact, and press  on GVC3200/GVC3202 remote control or click on button  to dial the contact users would like to call.

- **Delete**
Press the red shortcut key on the remote control to delete contacts.
- **Edit**
Press the yellow shortcut key on the remote control to edit contacts.
- **Add**
Press the blue shortcut key on the remote control to access New Contact screen, fill in contact information and press the yellow shortcut key on the remote control to save it.
- **Menu**
Press  on the remote control to access menu to edit/add/delete/export/import/download contacts.
- **Contact Details**
Select one contact and press "OK" key on the remote control to view contact details.

Add Contact

Add Single Contact

Follow the steps below to add one single contact:

1. Press the blue shortcut key on GVC3200/GVC3202 remote control to access New Contact screen.

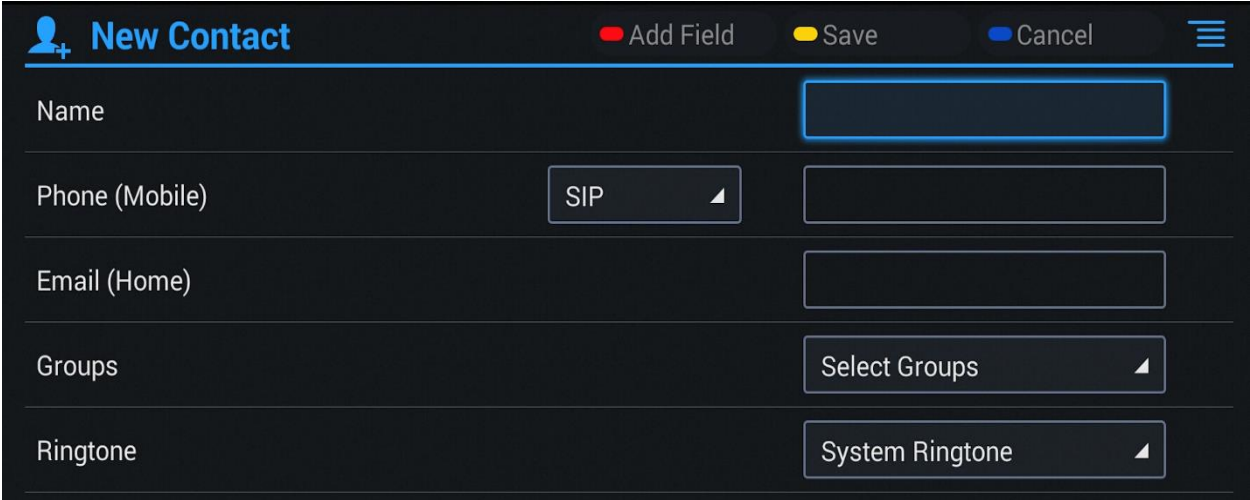

Figure 49: GVC3200/GVC3202 Add New Contact Screen

2. Enter the contact information.
3. Press the red shortcut key to add more fields.
4. Press the yellow shortcut key to save the contact information.

Users could press the red shortcut key to add more contact information.

Batch Import Contacts

Import function allows users to batch import contacts. The phonebook with compatible format needs to be saved to the storage devices like SD card/USB flash drive and plugged into GVC3200/GVC3202.

1. Press the MENU key on Contacts screen, and select "Import" to access Import Contacts screen.

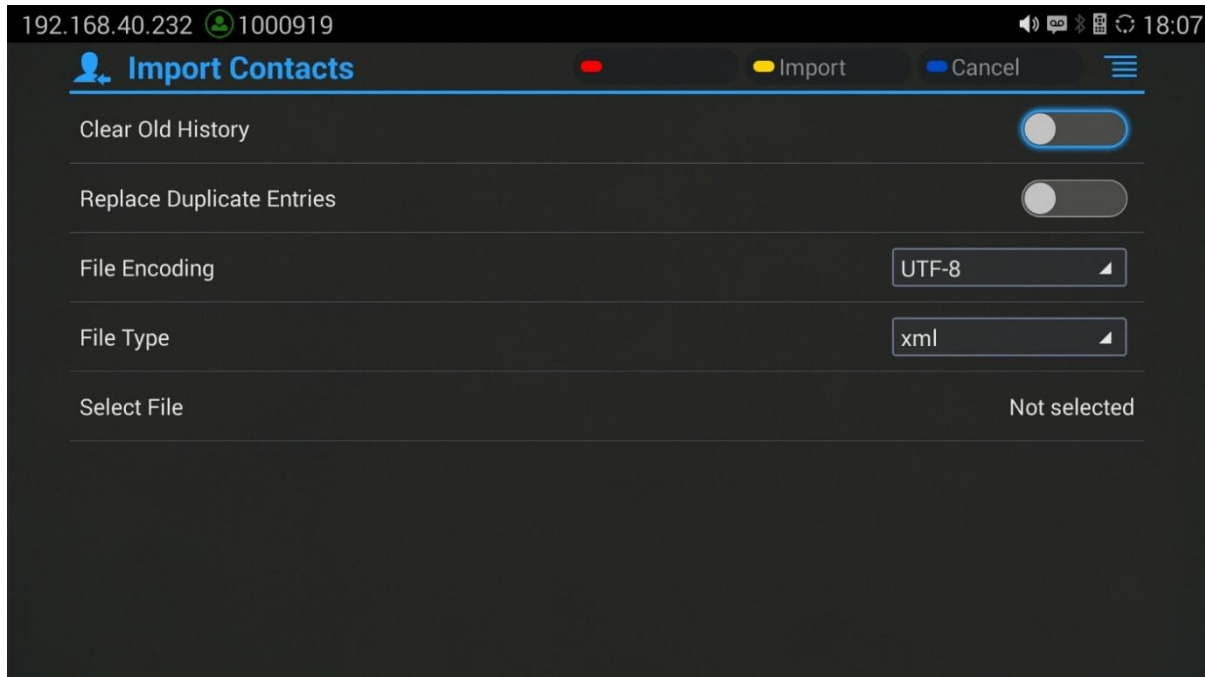

Figure 50: GVC3200/GVC3202 Import Contacts Screen

2. Configure parameters and select the path to save the imported file.
3. Press the yellow shortcut key to save the contact information.

Table 20: GVC3200/GVC3202 Import Contacts Parameters

Parameters	Descriptions
Clear The Old List	If it is enabled, the previous contact records will be deleted when a new phonebook file is loaded into the device. If it is disabled, both the old contacts and new contacts will be kept in GVC3200/GVC3202.
Replace Duplicate Entries	If it is enabled, when the phonebook file is imported to the device, the duplicated entries will be removed. If it is disabled, both the old contacts and new contacts will be kept in GVC3200/GVC3202.
File Encoding	Select the encoding format for XML contact file.
File Type	Select the file format for phonebook file import. The device supports xml, csv and vcard format.

Select The File

Select file from storage device plugged into GVC3200/GVC3202.

Download Contact

GVC3200/GVC3202 supports downloading phonebook from the file server to batch add contacts. The default file name that GVC3200/GVC3202 looks for is "phonebook.xml". The phonebook XML file should be placed under the file server directory for GVC3200/GVC3202 to retrieve. GVC3200/GVC3202 supports vcard/xml/csv file format.

1. On the Contacts screen, tap on the MENU key and select "Download" to bring up the Download Contacts screen.

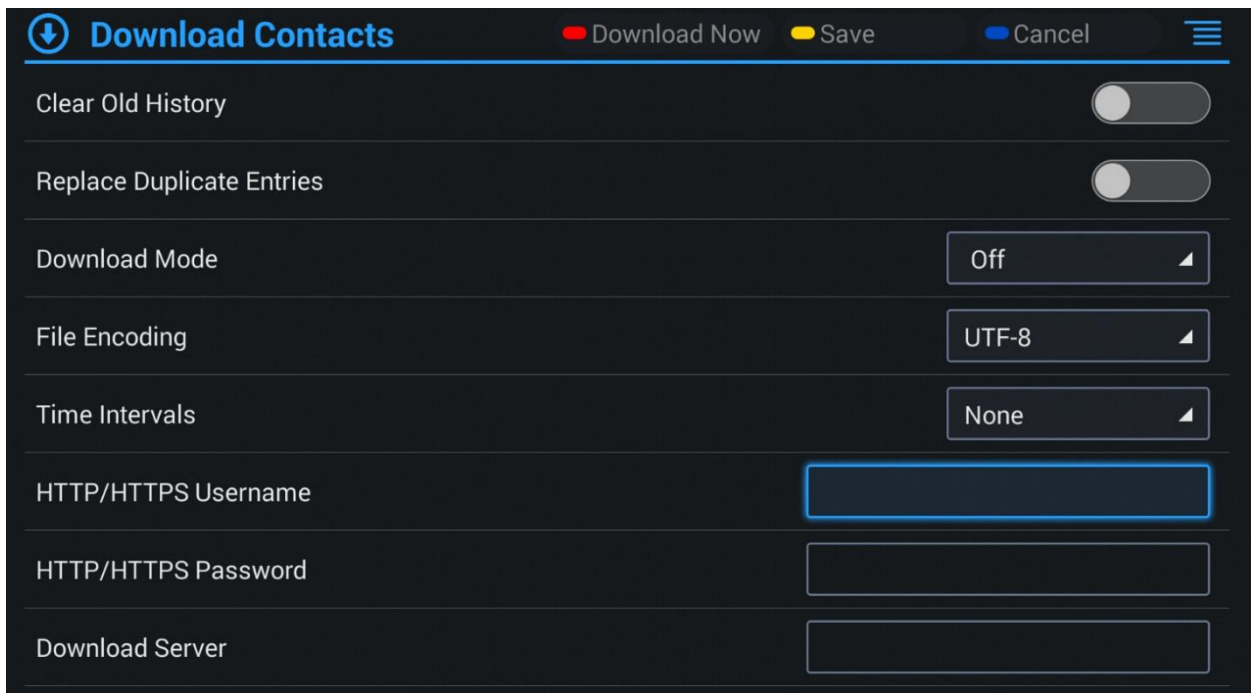

Figure 51: GVC3200/GVC3202 Download Contacts Screen

2. Configure parameters and select the path to save the file.
3. Press the red shortcut key to download the file.

Table 21: GVC3200/GVC3202 Download Contacts Parameters

Parameters	Descriptions
Clear The Old List	If it is enabled, the previous contact records will be deleted when a new phonebook file is loaded into the device. If it is disabled, both the old contacts and new contacts will be kept in GVC3200/GVC3202.

Replace Duplicate Entries	If it is enabled, when the phonebook file is imported to GVC3200/GVC3202, the duplicated entries will be removed. If it is disabled, both the old contacts and new contacts will be kept in GVC3200/GVC3202.
Download Mode	Select the phonebook download mode from TFTP, HTTP or HTTPS.
File Encoding	Select the encoding format for the XML contact file.
Time Intervals	Configure the time interval to download XML contact file.
HTTP/HTTPS Username	Configure the HTTP/HTTPS username for phone book downloading if it's required by the server.
HTTP/HTTPS Password	Configure the HTTP/HTTPS password for phone book downloading if it's required by the server.
Download Server	Fill in the server URL or IP address to download the XML contact file to the device.

Search Contacts

In the Contacts app, users could input keyword to search in the dialog. GVC3200/GVC3202 will display contacts automatically which is related to the search keyword. Fuzzy search and precise search are both supported.

Manage Contacts

Delete Contact

1. Access Contacts screen and select the contact users would like to delete.
2. Tap on  and select "Delete" option to delete contact.

Batch Remove Contacts

To delete more than one contacts,

1. Select "Batch Remove" option.
2. Select the checkbox for the contacts to be deleted, and press the red shortcut key on GVC3200/GVC3202 remote control to delete them. Users could also press the yellow shortcut key on the remote control to select all contacts at once.

Export Contacts

GVC3200/GVC3202 supports exporting phonebook as vcard/xml/csv files, and save the files to other external storage devices.



1. Press the MENU key on Contacts screen to bring up the Export Contacts screen.

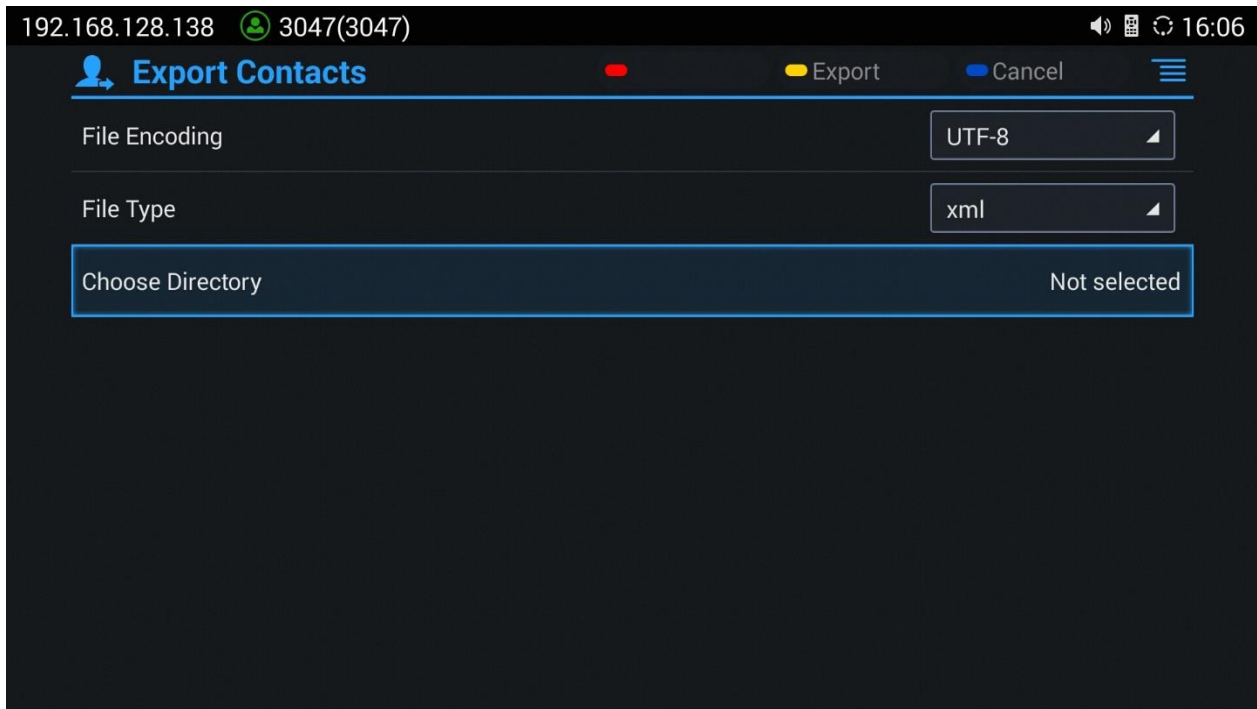

Figure 52: GVC3200/GVC3202 Export Contacts Screen

2. Configure parameters as shown in table below and select the directory to save the exported file.
3. Press the yellow shortcut key to export the file.

Table 22: GVC3200/GVC3202 Export Contacts Parameters

Parameters	Descriptions
File Encoding	Select the encoding format for XML contact file.
File Type	Select the file format for phonebook file export. The device supports xml, csv, and vcard.
Choose Directory	Select directory to save file.

Groups

Users could divide contacts into different groups with specific names. Select one group entry and press "OK" key to view group details.



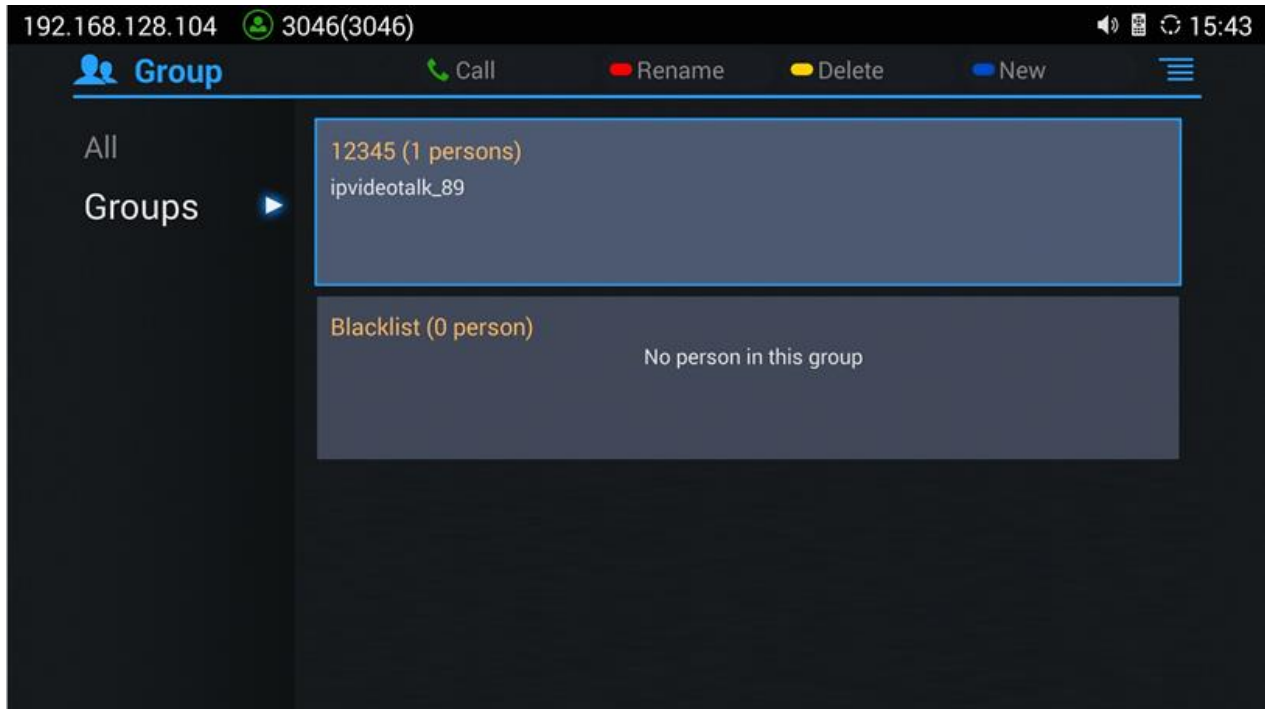



Figure 53: GVC3200/GVC3202 Groups Screen

- **Call**

Press  on GVC3200/GVC3202 remote control to call the first 8 members in a group to initiate a conference.

- **Rename (red shortcut key)**

It is used to rename a group.

- **Delete (yellow shortcut key)**

It is used to delete a group.

- **Add (blue shortcut key)**

It is used to add a group.

Add New Group

1. Select Groups tab in Contacts screen.
2. Press the blue shortcut key on GVC3200/GVC3202 remote control to bring up the screen below:

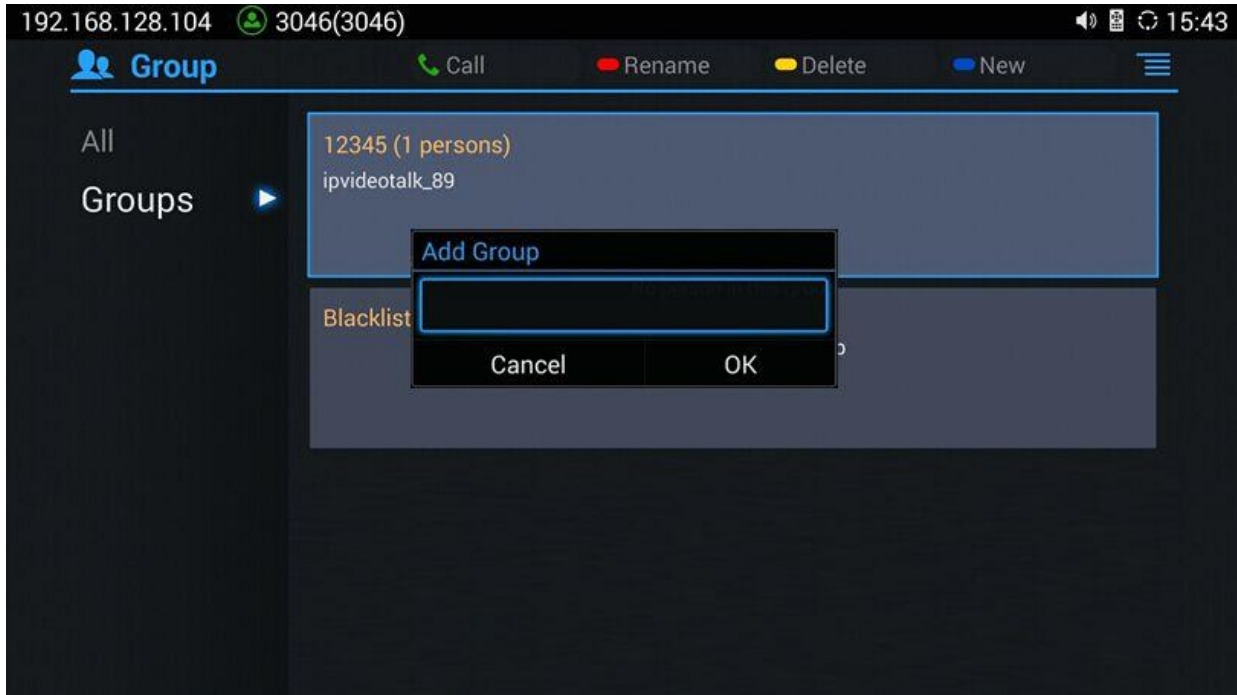

Figure 54: GVC3200/GVC3202 Add Group Screen

3. Input a group name and tap on "OK" to add a new group.
4. Go to Contacts Screen to find the group you just added and access it.
5. Press the red shortcut key on the remote control to access Groups editing screen.
6. Select the contacts users would to add to this group.
7. Press the blue shortcut key on GVC3200/GVC3202 remote control to save the operations.

Delete Group

Follow the steps below to delete groups.

1. Select Groups on Contacts screen.
2. Select the group users would like to delete.
3. Press the yellow shortcut key to bring up the dialog box.
4. Press "OK" key to delete.

LDAP contacts

LDAP contacts application can be accessed in GVC3200/GVC3202 display device LCD → **Applications** → **LDAP Contacts**. It helps users access and manage the contacts at ease.



Here is the main interface of LDAP contacts.

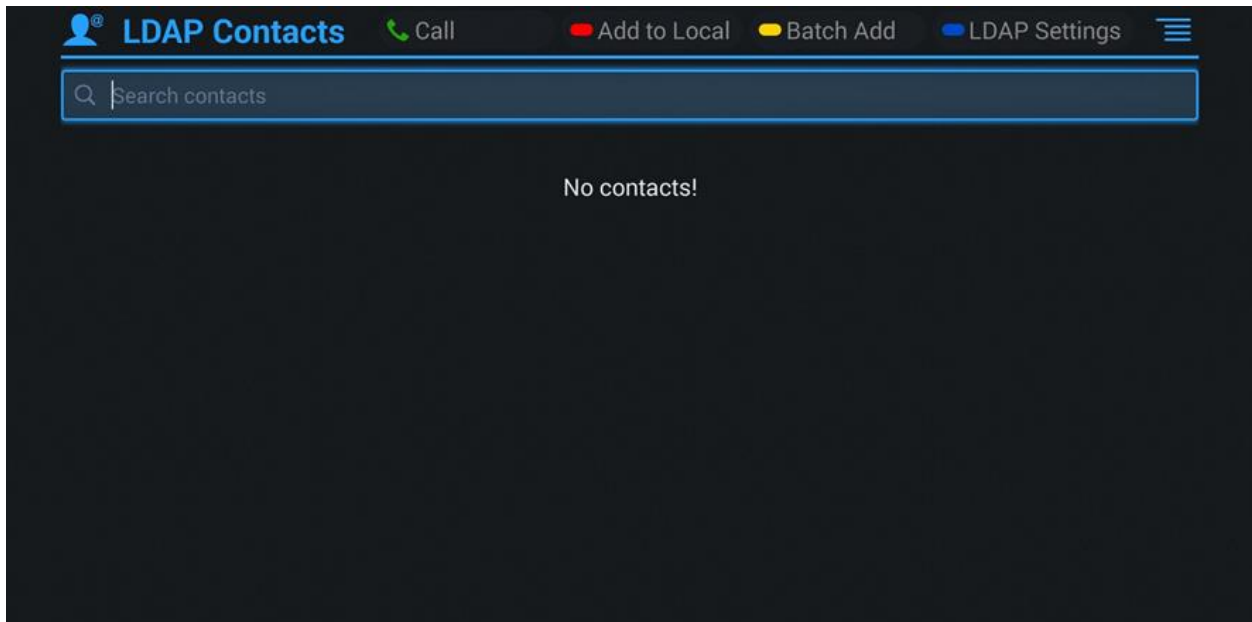

Figure 55: LDAP Contacts Interface

LDAP Settings

Before starting using LDAP on GVC3200/GVC3202, the users must configure the LDAP settings first. Press the Blue shortcut key on the GVC3200/GVC3202 remote control to access LDAP settings, or the users can configure it under GVC3200/GVC3202 web UI → **Contacts** → **LDAP** page.

Table 23: GVC3200/GVC3202 LDAP Settings Parameters

Connection Mode	It is used to select which protocol will be used for LDAP searching, LDAP or LDAPS.
Server Address	It is used to configure the URI of the LDAP (Lightweight Directory Access Protocol) server.
Port	It is used to configure the LDAP server port. The default LDAP port number is 389.
Base DN	It is used to configure the LDAP search base. This is the location in the directory where the search is requested to begin. Example: dc=grandstream, dc=com ou=Boston, dc=grandstream, dc=com
User Name	It is used to configure the bind "Username" for querying LDAP servers. Some LDAP servers allow anonymous binds in which case the setting can be left blank.



Password	It is used to configure the bind "Password" for querying LDAP servers. The field can be left blank if the LDAP server allows anonymous binds.
LDAP Name Attributes	It is used to configure the "name" attributes of each record which are returned in the LDAP search result. This field allows the users to configure multiple space separated name attributes. Example: gn cn sn description
LDAP Number Attributes	It is used to configure the "number" attributes of each record which are returned in the LDAP search result. This field allows the users to configure multiple space separated number attributes. Example: telephoneNumber telephoneNumber Mobile
LDAP Mail Attributes	It is used to configure the "mail" attributes of each record which are returned in the LDAP search result. Example: mail
LDAP Name Filter	It is used to configure the filter used for name lookups. Examples: ((cn=%)(sn=%)) returns all records which has the "cn" or "sn" field starting with the entered prefix; (!(sn=%)) returns all the records which do not have the "sn" field starting with the entered prefix; (&(cn=%) (telephoneNumber=*)) returns all the records with the "cn" field starting with the entered prefix and "telephoneNumber" field set.
LDAP Number Filter	It is used to configure the filter used for number lookups. Examples: ((telephoneNumber=%)(Mobile=%)) returns all records which has the "telephoneNumber" or "Mobile" field starting with the entered prefix; (&(telephoneNumber=%) (cn=*)) returns all the records with the "telephoneNumber" field starting with the entered prefix and "cn" field set.
LDAP Mail Filter	It is used to configure the filter used for mail lookups. Example: (mail=%)
LDAP Displaying Name Attributes	It is used to configure the entry information to be shown on phone's LCD. Up to 3 fields can be displayed. Example: %cn %sn %telephoneNumber



Max Hits	It is used to configure the maximum number of results to be returned by the LDAP server. If set to 0, server will return all search results. The default setting is 50.
Search Timeout (ms)	It is used to configure the interval (in seconds) for the server to process the request and client waits for server to return. The default setting is 4000 seconds.
LDAP Lookup When Dialing	It is used to set if allow the phone system to do the LDAP number searching when making outgoing calls. The default setting is "No".
Search LDAP For Incoming Call	It is used to set if allow the phone system to do LDAP number searching for incoming calls. The default setting is "No".

Here is an example configuration on GVC3200/GVC3202 LDAP settings in web UI. The LDAP server is the built-in LDAP server in Grandstream UCM6xxx.



Connection Mode :	<input type="text" value="LDAP"/>
Server Address :	<input type="text" value="company.ldap.server.com"/>
Port :	<input type="text" value="389"/>
Base DN :	<input type="text" value="dc=pbx,dc=com"/>
Username :	<input type="text"/>
Password :	<input type="password"/>
LDAP Name Attributes :	<input type="text" value="CallerIDName"/>
LDAP Number Attributes :	<input type="text" value="AccountNumber"/>
LDAP Mail Attributes :	<input type="text"/>
LDAP Name Filter :	<input type="text" value="(CallerIDName=%)"/>
LDAP Number Filter :	<input type="text" value="(AccountNumber=%)"/>
LDAP Mail Filter :	<input type="text"/>
LDAP Displaying Name Attributes :	<input type="text" value="%AccountNumber %CallerIDName"/>
Max Hits :	<input type="text" value="50"/>
Search Timeout (ms) :	<input type="text" value="4000"/>
LDAP Lookup When Dialing :	<input checked="" type="checkbox"/> Enable
Search LDAP for Incoming Call :	<input checked="" type="checkbox"/> Enable
	<input type="button" value="Save"/> <input type="button" value="Cancel"/>

Figure 56: LDAP Settings Example in Web UI

Search LDAP Contacts

After configuring LDAP settings, the users could search contacts in LDAP Contacts main interface. In the following example, the users could enter number or name in the Search field. The LDAP result will be displayed dynamically when the key word is entered.

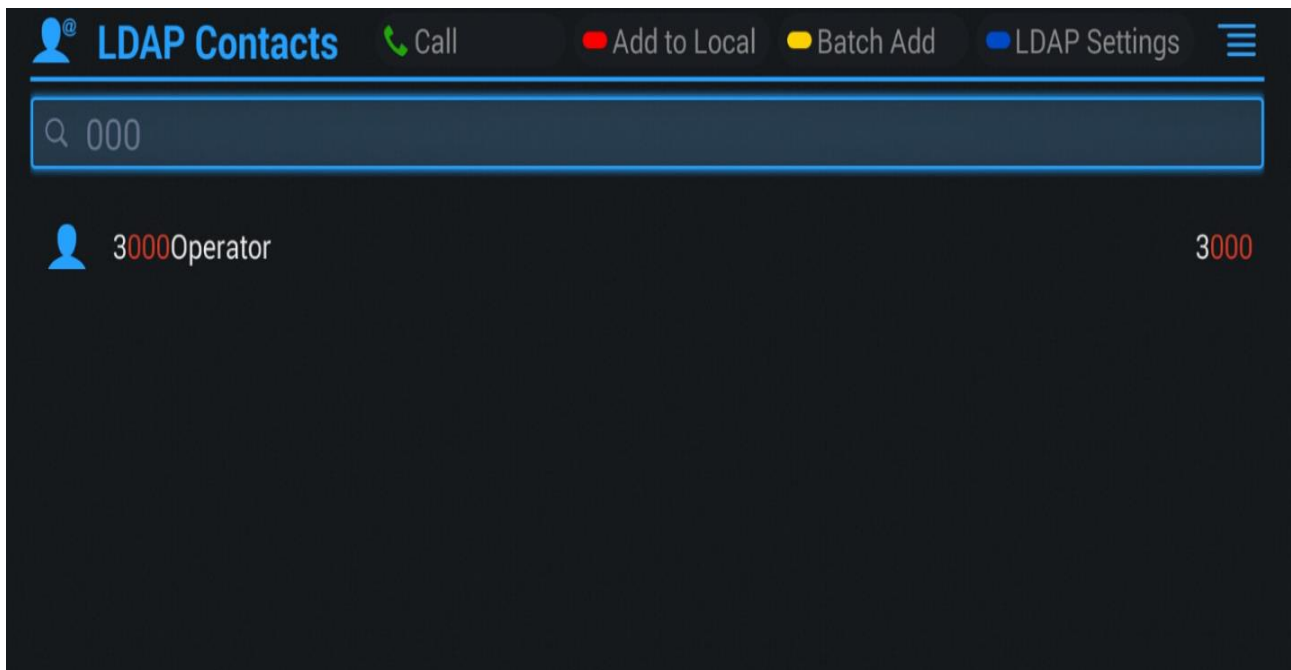

Figure 57: Search LDAP Contacts

If the user presses the Green Call button  on the GVC3200/GVC3202 remote control, the GVC3200/GVC3202 will initiate a call to this contact.

Add Search Result into Local Contacts

After performing LDAP search, the users could select to add the result into GVC3200/GVC3202 local contacts.

- **Add to Local**

On the search result screen, move the selection to the contact, then press the red shortcut key on the GVC3200/GVC3202 remote control to add single search result to local contacts. Click on OK to confirm Add to Local.



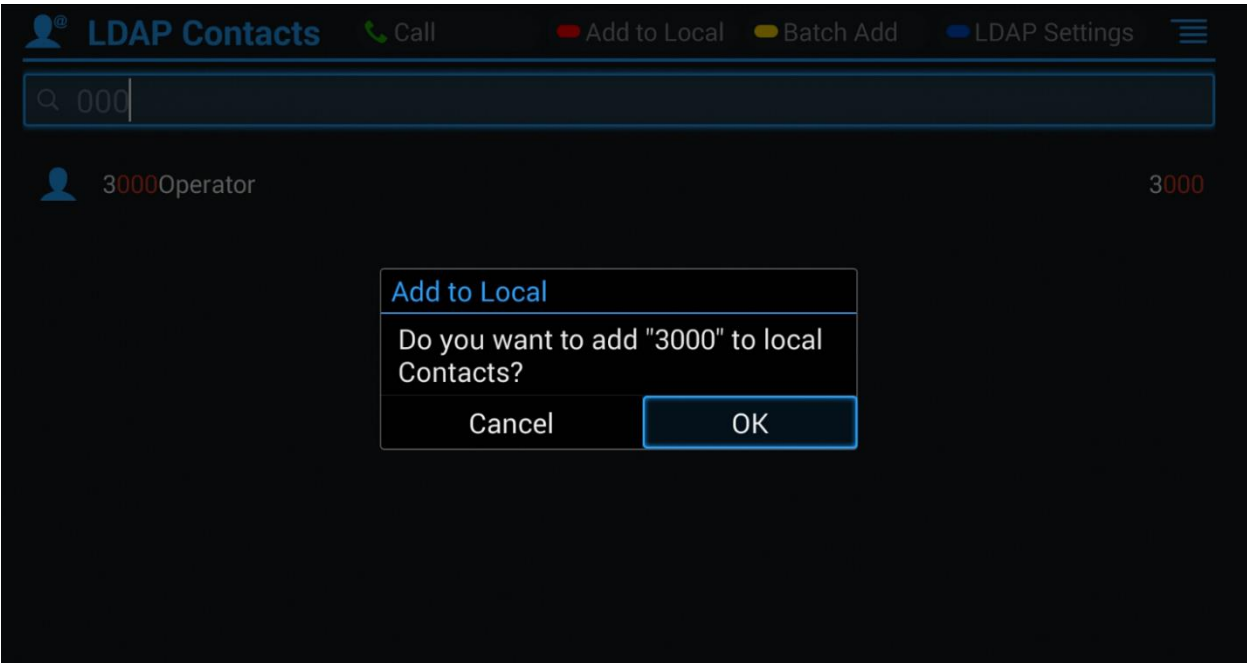

Figure 58: Add LDAP Search Result to Local Contacts

- Batch Add**

Press the yellow shortcut key on the GVC3200/GVC3202 remote control, then select the checkbox for multiple search results to be added into local contacts. Press the yellow shortcut key again and the following prompt will pop up. Click on OK to confirm Batch Add.

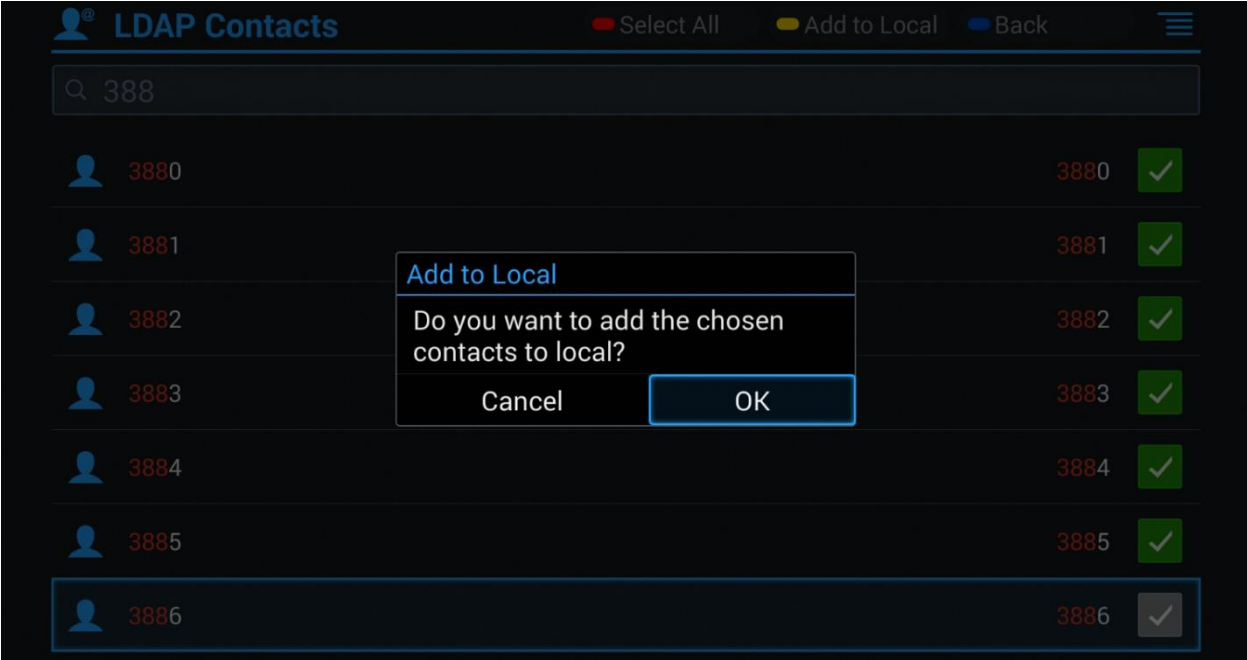



Figure 59: Batch Add LDAP Search Results to Local Contacts



Call History

Call History provides users access to phone's recent call records. Users can view all records, or select different categories for incoming calls, outgoing calls, missed call and conference.

To access Call History, go to Home screen → **Applications** → select .

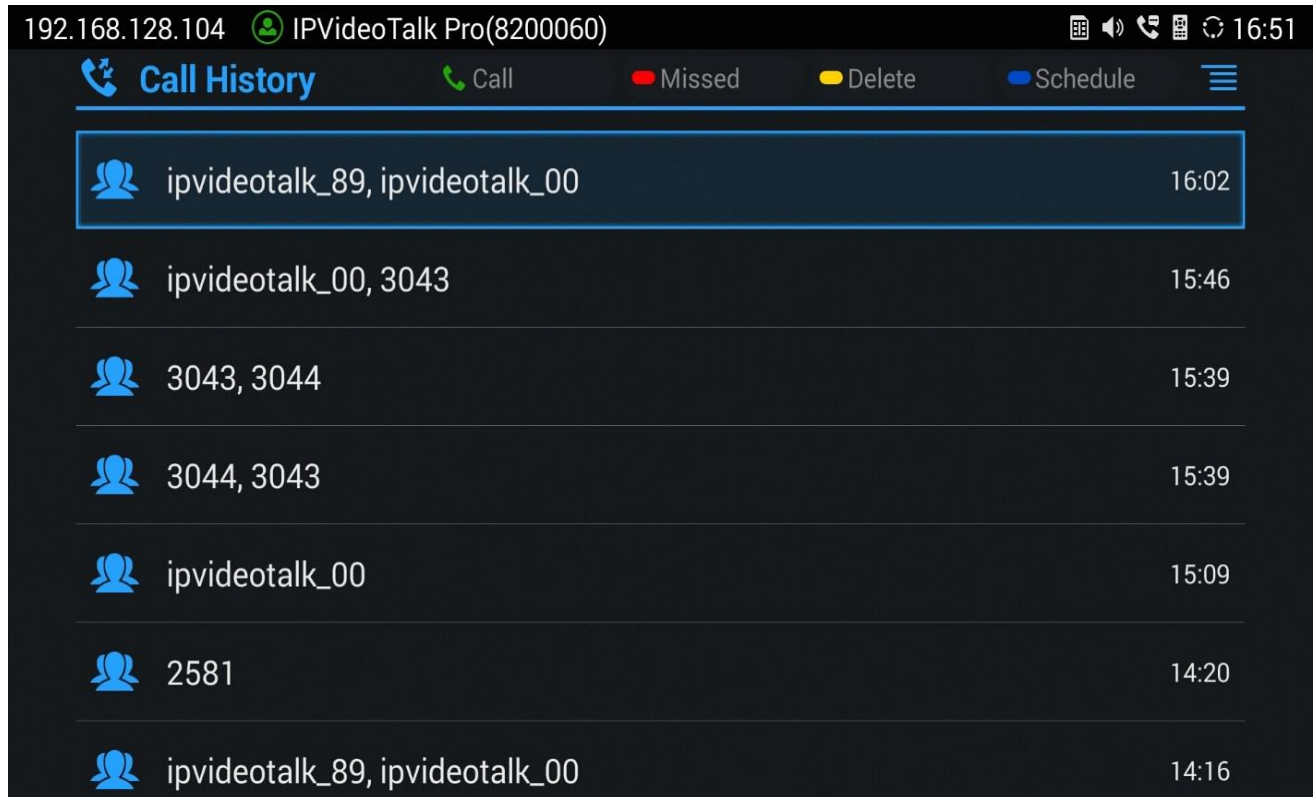

Figure 60: GVC3200/GVC3202 Call History Screen



Click on a record in the call history and press  to dial out this number directly. Press "OK" key on GVC3200/GVC3202 remote control to view call details for this number.



Figure 61: GVC3200/GVC3202 Call History Details



Note:

Call history displays all Blue Jeans conference call histories as well. Press "OK" key or  to dial out directly, and there is no need to input the password again. However, if the conference does not exist or the password has been changed, the re-dial will fail.

If an entry in call history already exists in GVC3200/GVC3202 Contacts, when the user clicks on the upper right Menu button  on the Call History screen, the users can see and select "View contact" option in the drop-down list to view the details for this contact.

Add Contact from Call History

1. Access Call History screen.
2. Select one call history entry.
3. Press the blue shortcut key to bring up the dialog box.
4. Confirm to add the contacts.



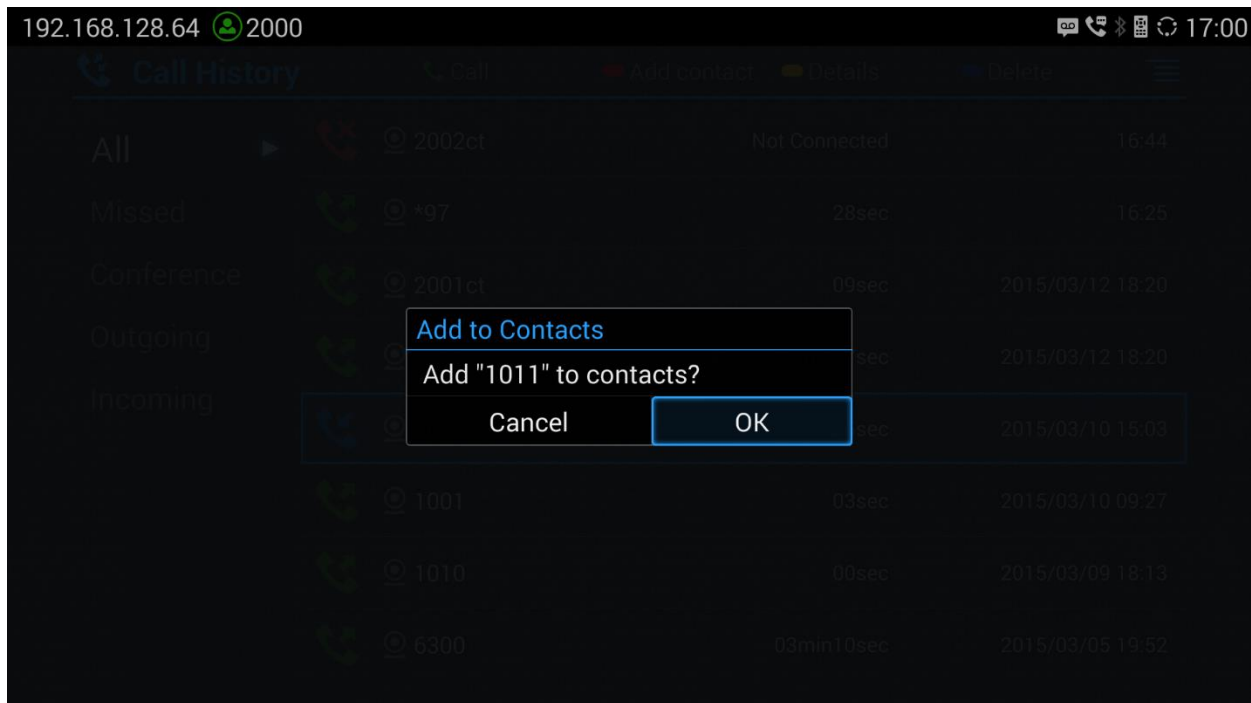

Figure 62: GVC3200/GVC3202 Add Contact Screen

5. Select existing contact or press the blue shortcut key on GVC3200/GVC3202 remote control to access edit screen.
6. Fill in contact information and press the yellow shortcut key on the remote control to save the contact.

Delete Call History

1. Select the call history entry.
2. Press the yellow shortcut key on GVC3200/GVC3202 remote control to bring up the dialog box.
3. Confirm to delete.

Conference Schedule via Call History

1. Select one call history entry users would like to add to scheduled conference.
2. Press the blue shortcut key on GVC3200/GVC3202 remote control to access schedule screen.
3. Fill in information and press the yellow shortcut to save.

File Manager

File Manager allows users to delete, move, copy, paste, send, rename files (including files on storage device such as USB flash drive and SD card), and query file properties on GVC3200/GVC3202.



Copy File

To copy the file from GVC3200/GVC3202 to USB/SD storage device:

1. Insert USB/SD storage device into USB port on GVC3200/GVC3202. It will take a few seconds for GVC3200/GVC3202 to prepare the connection.
2. The USB storage icon will show up on the status bar.
3. Go to Home screen→**Applications**→**File Manager**.
4. Open the target folder.
5. Press the yellow shortcut key and select the file.
6. Press the blue shortcut key to copy file and press ↶ to go back to the upper level directory.
7. Select target storage device and go to the directory where the file will be pasted to.
8. Press the yellow shortcut key to paste the file.

Users can also select file and press the blue shortcut key to copy one single file or folder.

Send File

1. Go to Home screen→**Applications**→**File Manager**.
2. Open the target folder.
3. Press the yellow shortcut key and select the file.
4. Press MENU key ☰ on GVC3200/GVC3202 remote control and select "Send" option.
5. Select target location and press "OK" key on GVC3200/GVC3202 remote control to send file. If users need to send the file via Bluetooth, enable and connect Bluetooth device first. Otherwise, the interface will be redirected to the corresponding setting page to configure.

Users can also select file and press the MENU key to send one single file or folder.

Delete File

1. Go to Home screen→**Applications**→**File Manager**.
2. Open the target folder.
3. Press the yellow shortcut key and select the file.
4. Press the red shortcut key.
5. A dialog will pop out for users to confirm whether to delete the file or not.
6. Press "OK" key to delete the file successfully.

Users can also select file and press the red shortcut key to delete one single file or folder.



Rename File

1. Go to Home screen→**Applications**→**File Manager**.
2. Open the target folder.
3. Press the yellow shortcut key and select the file.
4. Press MENU key  on GVC3200/GVC3202 remote control and select "Rename".
5. Input the new file name in the pop out dialog and press "OK" key to save.

Press  on GVC3200/GVC3202 remote control to cancel the operation.

Recording

GVC3200/GVC3202 recording application is used for the storage of call recording files in video conferencing. Users can play, export, lock/unlock, send, rename or delete these recordings and etc. The recording screen is as shown below:

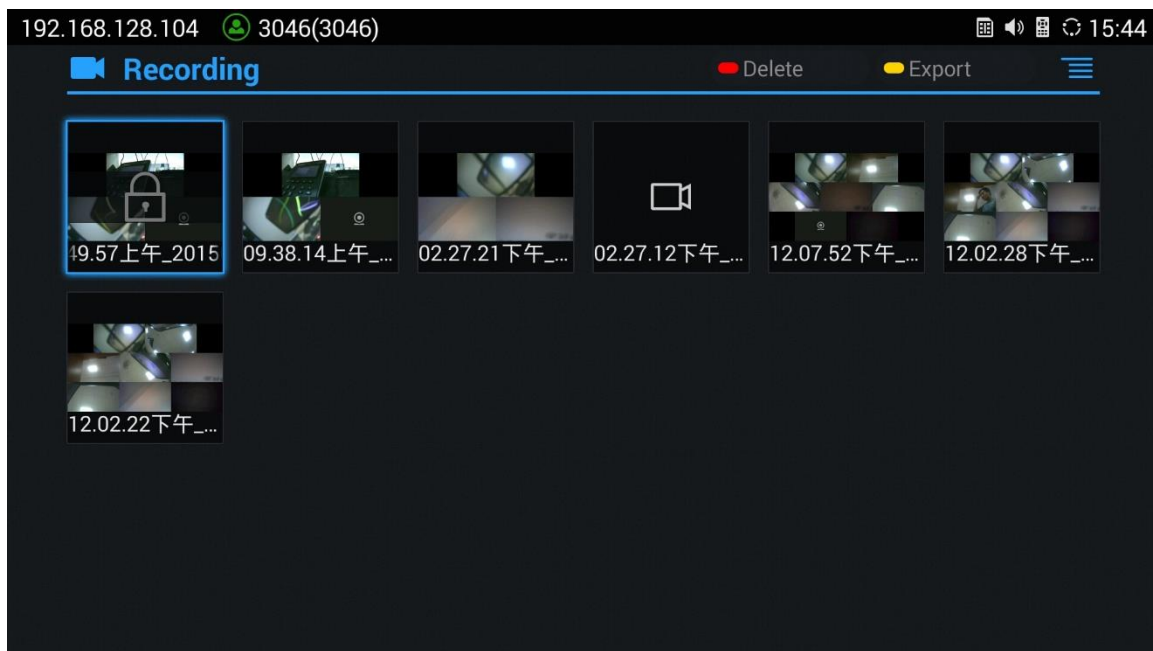



Figure 63: GVC3200/GVC3202 Recording Screen

- Press "OK" key to play recording.
- Press the red shortcut key to delete the chosen recording file.
- Press the yellow shortcut key to export the recording files to the external storage device.
- Press the MENU key to make other operations to recording files like export, rename, and lock/unlock.

Save Path

Users can change the default save path for recording to internal storage, a plugged SD card or USB storage device:

1. Go to Home screen→**Applications**→**Recording**.
2. Press the MENU key  on remote control and select “Settings”.
3. Plug in external SD card or USB storage device, and select the Recording Save Path.

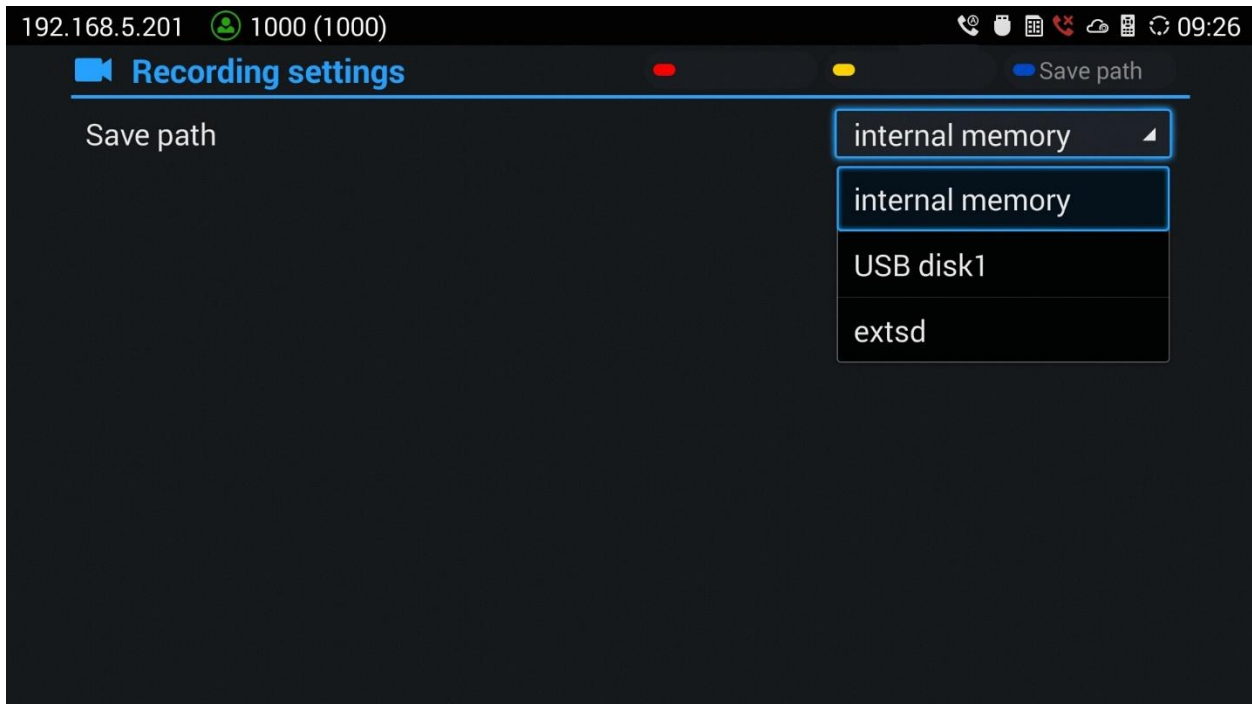

Figure 64: GVC3200/GVC3202 Default Save Path



Note:

- The locked files can't be deleted or overwritten, and cannot be shown in the third-party application, but can be viewed in GVC3200/GVC3202 video application.
- When the recording size exceeds 1.9G, the GVC3200/3202 will create a new file automatically to continue recording. There will be a prompt to indicate the storage space is insufficient if the disk storage is full.

Setup Wizard

GVC3200/GVC3202 offers a Setup Wizard tool to guide users into configuring their units step by step, the setup wizard appears automatically at factory reset, or it can be accessed anytime from LCD menu→**Applications**→**Setup Wizard**.



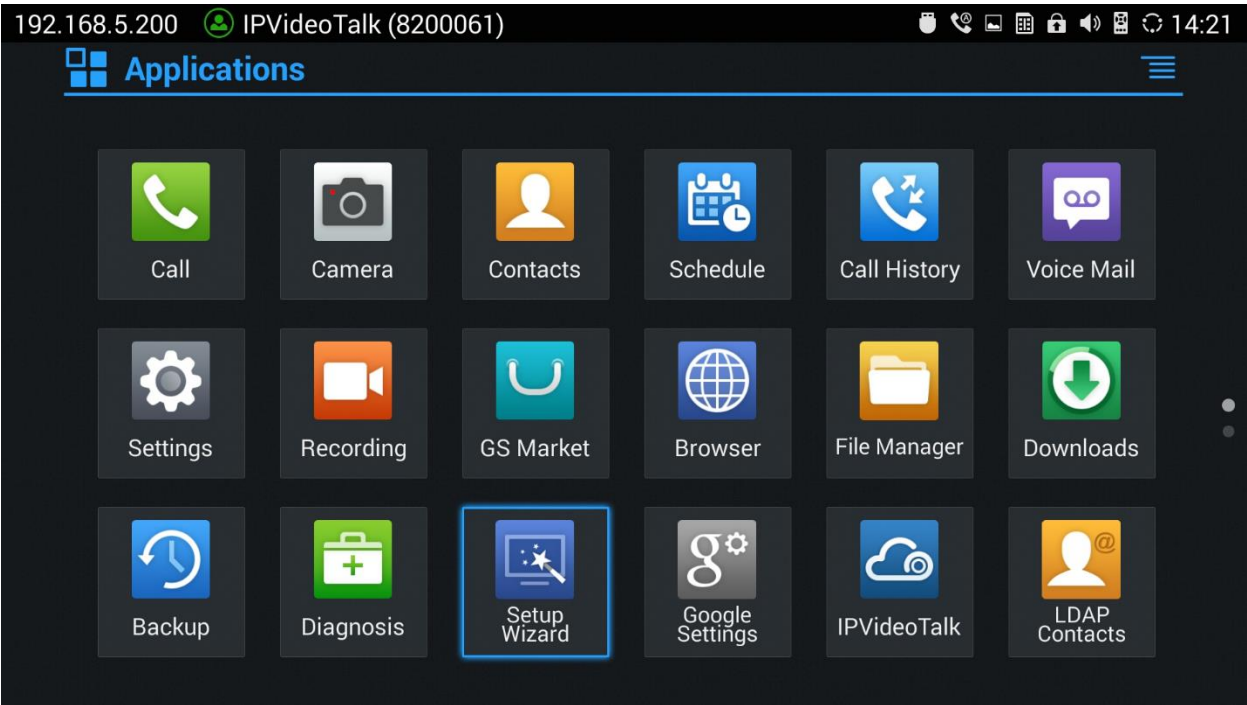

Figure 65: Applications→Setup Wizard

Users can follow the steps using the remote control to setup fields, skip, return, or confirm the action. Setup wizard tool is useful to lead users to check and configure the GVC3200/GVC3202 settings such as language, accounts, interface status and etc.

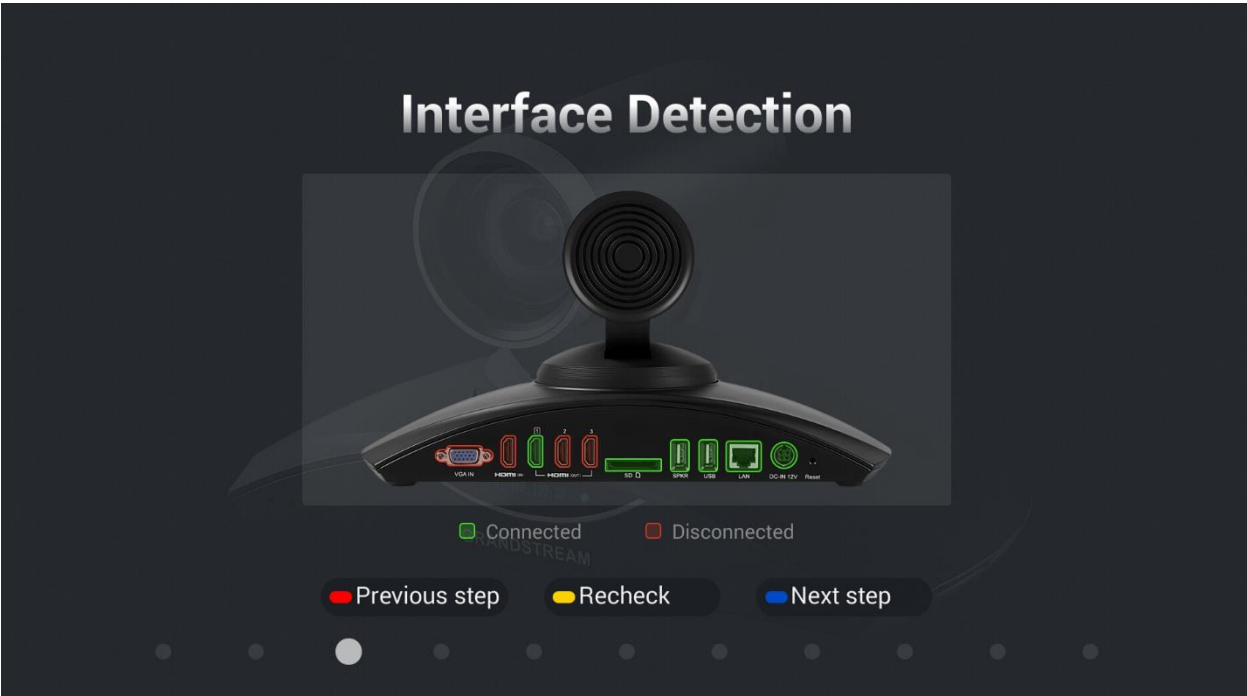

Figure 66: Interface Detection

Backup

Backup Data

GVC3200/GVC3202 BACKUP application is used to back up data or import backup files to restore data. It can be accessed from Home **screen**→**Applications**→**Backup**. The default screen will list available backup files (if any) and backup options.

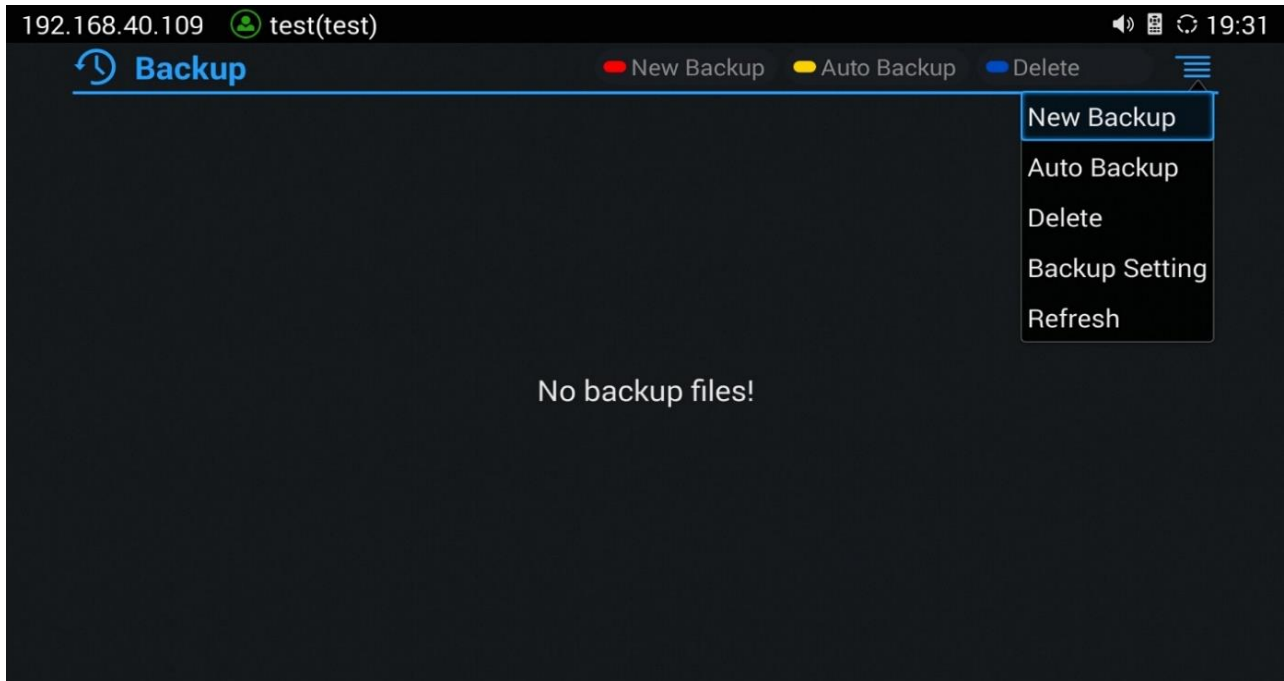

Figure 67: GVC3200/GVC3202 Backup App

GVC3200/GVC3202 supports manual backup and automatic backup:

- Press the red shortcut key on the remote control to create new backup manually. The user will select data and press the blue shortcut key to start backup.
- Press the yellow shortcut key on the remote control to access automatic backup. Then configure each parameter for automatic backup.

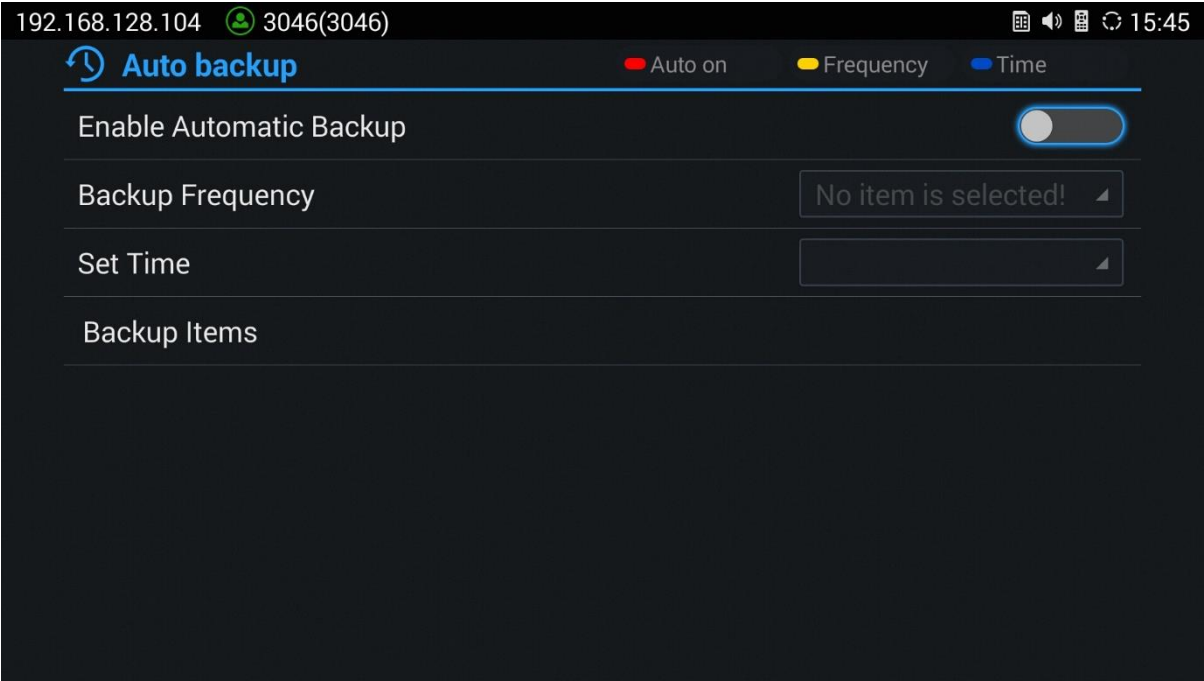

Figure 68: GVC3200/GVC3202 Automatic Backup Screen

Note: Using firmware 1.0.3.24 and above, users have also the option to choose which commonly used apps need to be backed up, such as contacts, call history.



Figure 69: Backup Commonly Used Apps



Restore Backup Data

Select one backup data and press "OK" key to access restore screen, select data and press the blue shortcut key to restore the backup data.

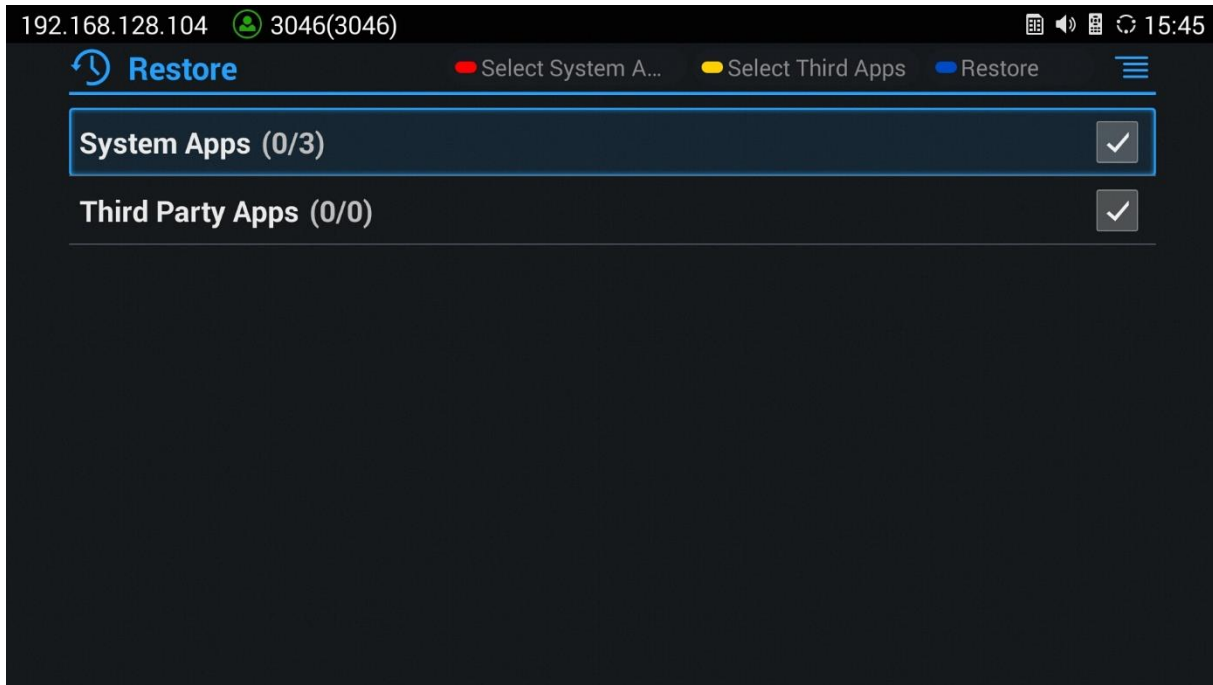

Figure 70: GVC3200/GVC3202 Restore Backup Data Screen

Set Backup Path

Press the MENU key and select "Settings" on backup screen to access settings screen, set backup path and go back to save automatically.



Note:

Insert SD card or USB flash drive to the GVC3200/GVC3202 before configuring backup path.

Diagnosis

When troubleshooting GVC3200/GVC3202, users could go to GVC3200/GVC3202 home screen → **Applications** → **Diagnosis** . Tap on the option and follow the instructions on each function to perform Camera Test, Remote Control Key Test, Built-in Speaker Test and etc. During the test, users could press the BACK key or follow the prompt to exit the test.



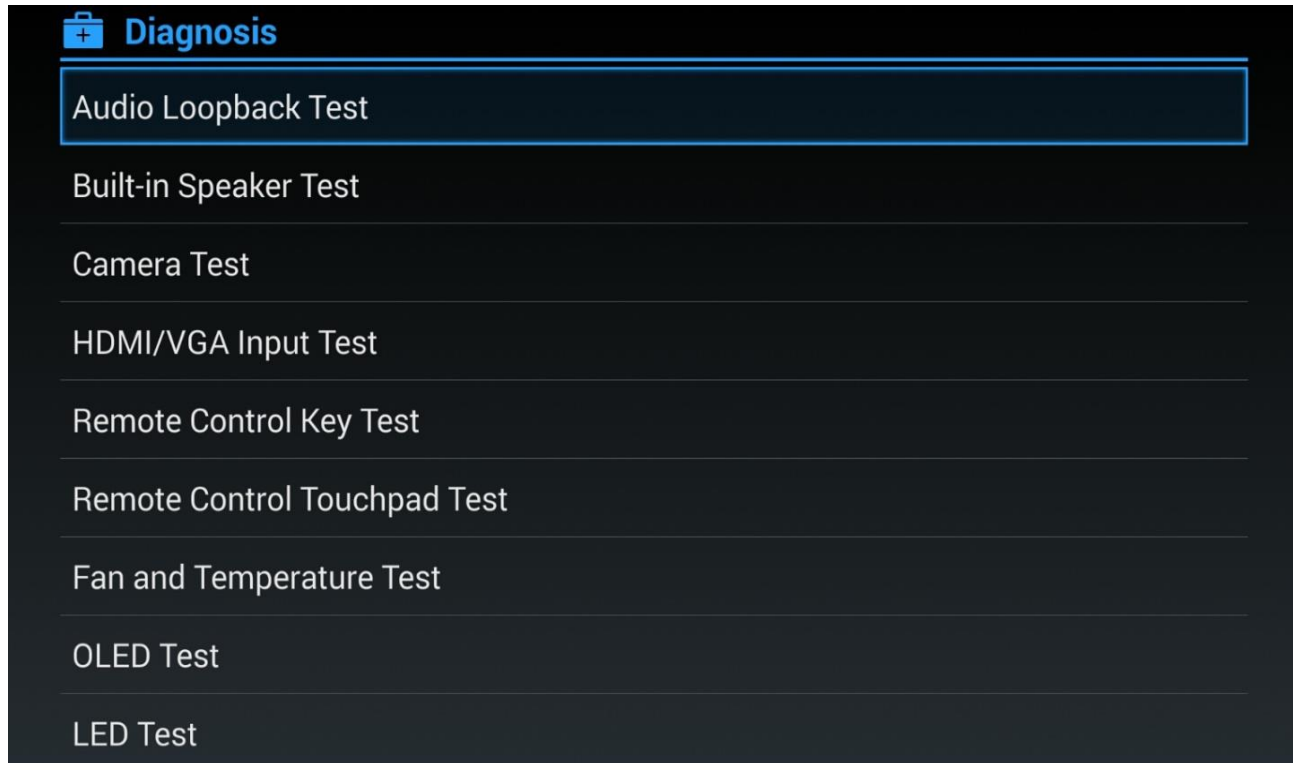

Figure 71: GVC3200/GVC3202 Diagnosis Screen

Browser

Users could browse web page, view news and watch video via the built-in GVC3200/GVC3202 Browser.

On home screen, select **Application**→**Browser** .

- Slide up or down with slide gesture to scroll the screen.
- Zoom in/out the page via zoom gesture.
- Press the MENU key to open the menu bar for more operations.

Sync Local Schedule with Google Calendar

The GVC3200/GVC3202 supports schedule that can be accessed in LCD menu→**Schedule** (see section [Schedule]). The settings in this schedule are saved locally on GVC3200/GVC3202. If the user downloads and installs Google Calendar from Play Store to GVC3200/GVC3202, the local schedule can be synced up with Google Calendar.



Please follow the steps below to set up Google Calendar sync with GVC3200/GVC3202 schedule:

1. Go to GVC3200/GVC3202 LCD **menu**→**Applications**→**GS Market**, download and install Google Play Store.
2. Sign in Google Play Store using your Google account. Download and install Google Calendar to GVC3200/GVC3202.
3. Open Google Calendar on GVC3200/GVC3202. Please update Google Play services if required by the device.
4. Once Google Calendar is successfully installed and opened on GVC3200/GVC3202, it should automatically sign in using the same Google account in step 2.
5. On GVC3200/GVC3202 LCD **menu**→**Settings**→**System**→**Accounts**→**Google Account**, select

Google account 

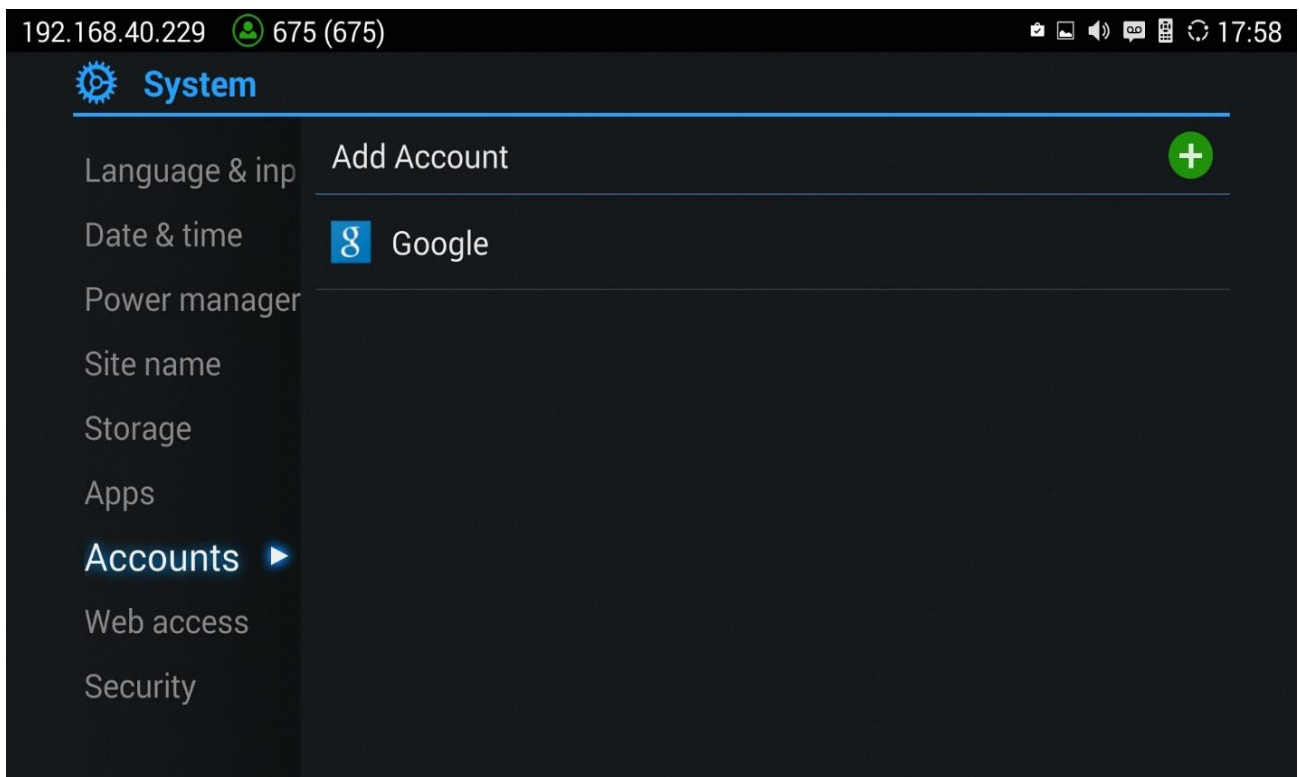
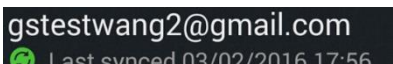

Figure 72: LCD Menu→Settings→System→Accounts

6. Select the Google account  **gstestwang2@gmail.com** Last synced 03/02/2016 17:56 under Google accounts.



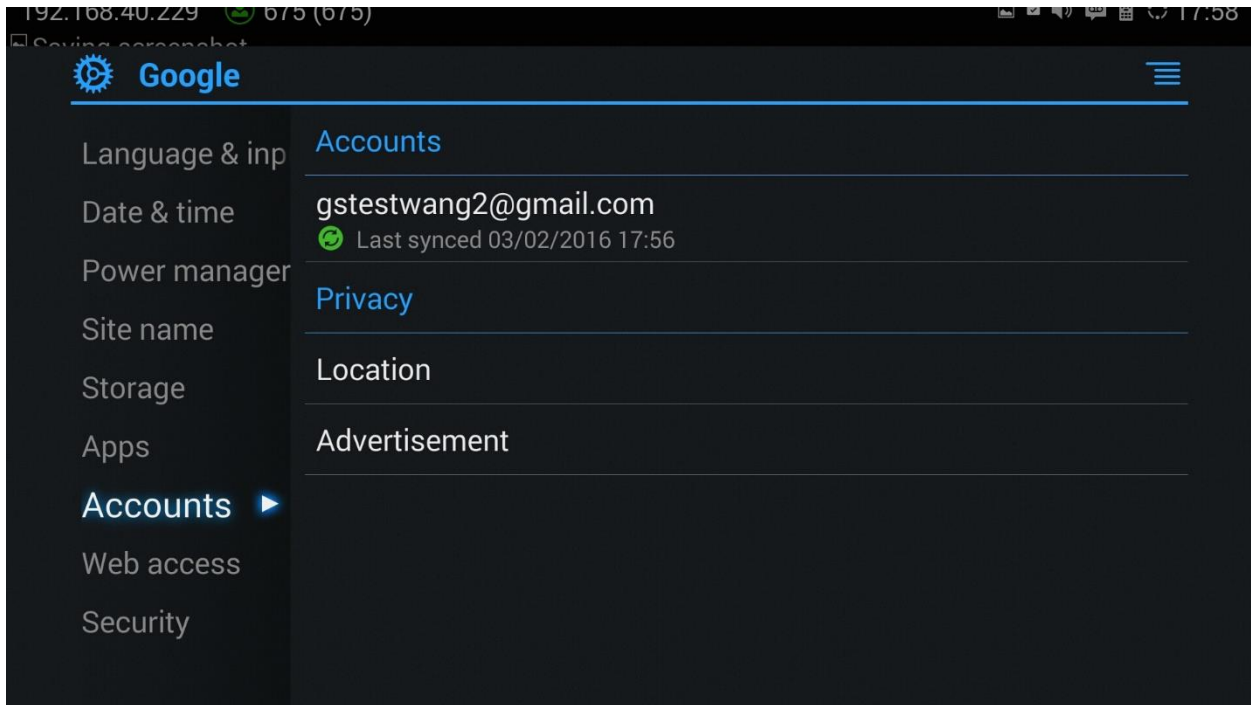

Figure 73: Select the Google Account Used for Sign-In

- Click on the checkbox for “Calendar” to enable calendar sync for this Google account.

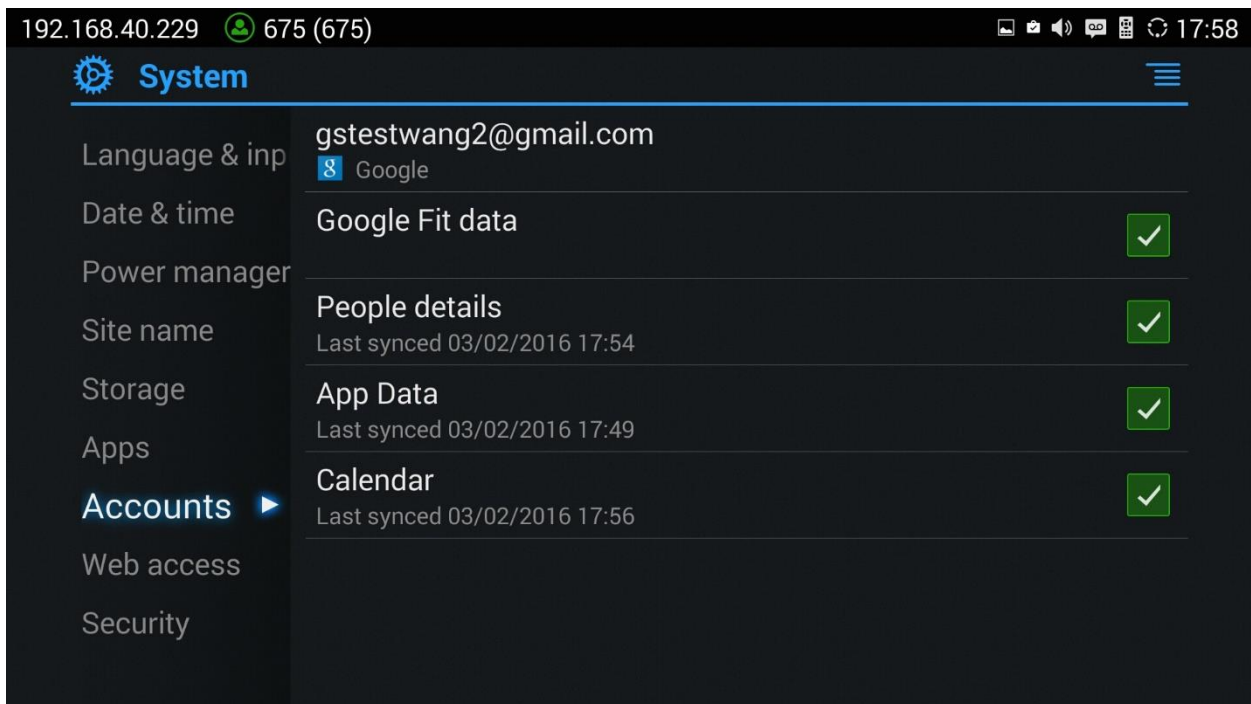

Figure 74: Enable Calendar Sync for the Google Account

- On GVC3200/GVC3202 LCD menu → **Schedule**, click on the upper right MENU icon → Settings.

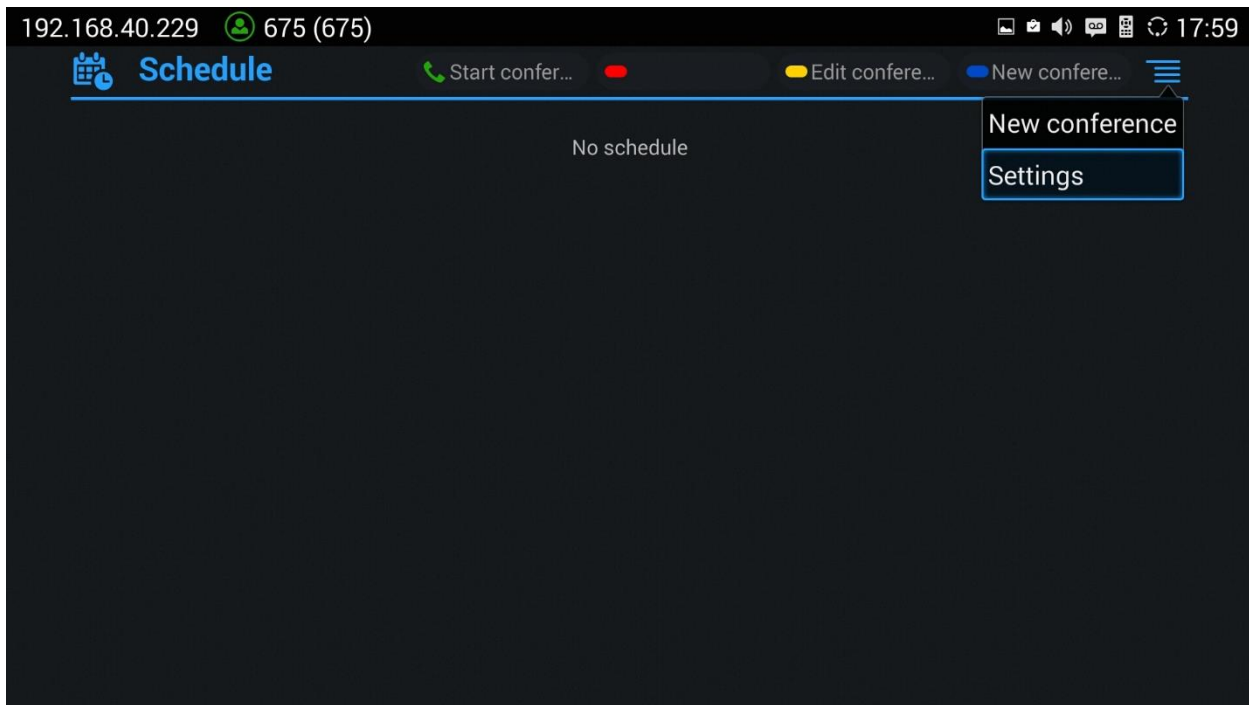

Figure 75: GVC3200/GVC3202 Schedule→Settings

9. Enable Google Calendar by selecting the checkbox for the Google account. Set the sync interval, e.g., Every 5 mins.

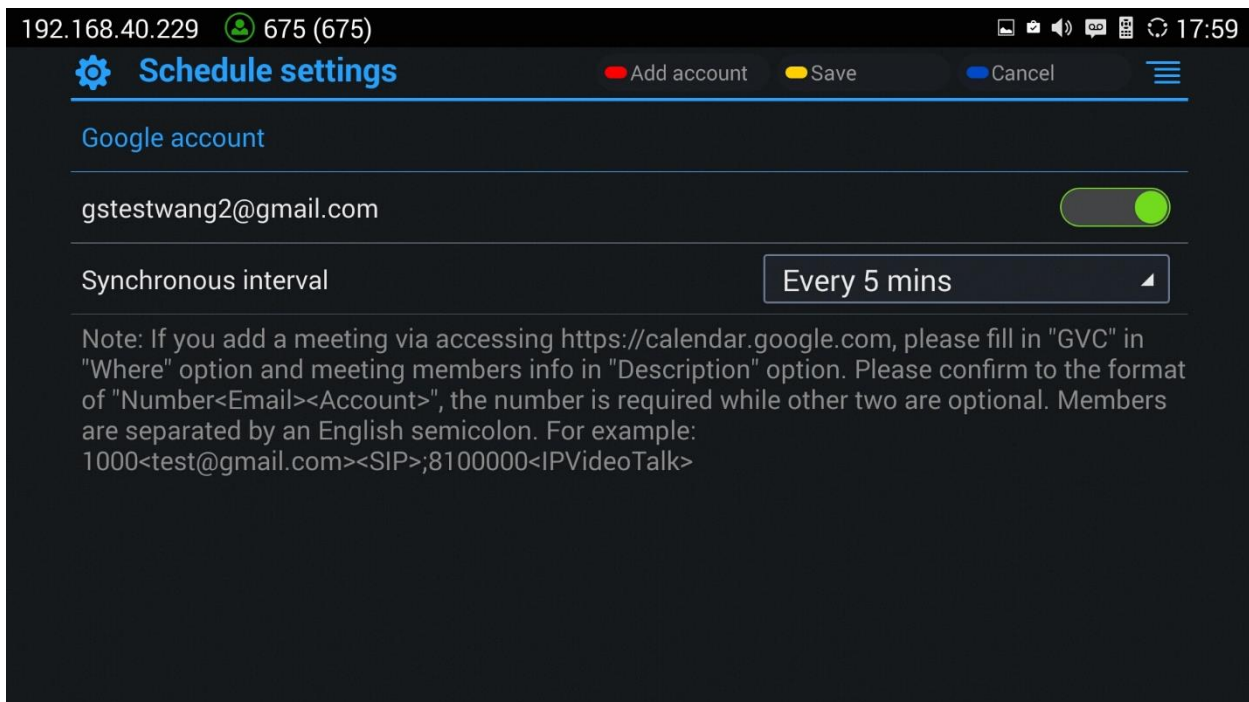

Figure 76: Enable Google Account for Schedule and Set Sync Interval

Now your GVC3200/GVC3202 has Google account successfully associated with schedule. The scheduled conference from GVC3200/GVC3202 or Google Calendar can sync with each other. Here is how to use it.



- To schedule meeting using Google Calendar and then sync up on GVC3200/GVC3202 schedule

1. When creating a new event in Google Calendar, please enter “**GVC**” in “Where” option.
2. Then enter meeting members in “Description” option. The meeting members should be in the format: **Number<Email><Account>**. “**Number**” is required while the other two fields are optional. Multiple meeting members need to be separated by semi-colon in English input method. For example, **1000<test@gmail.com><SIP>;8100000<IPVideoTalk>;1001**

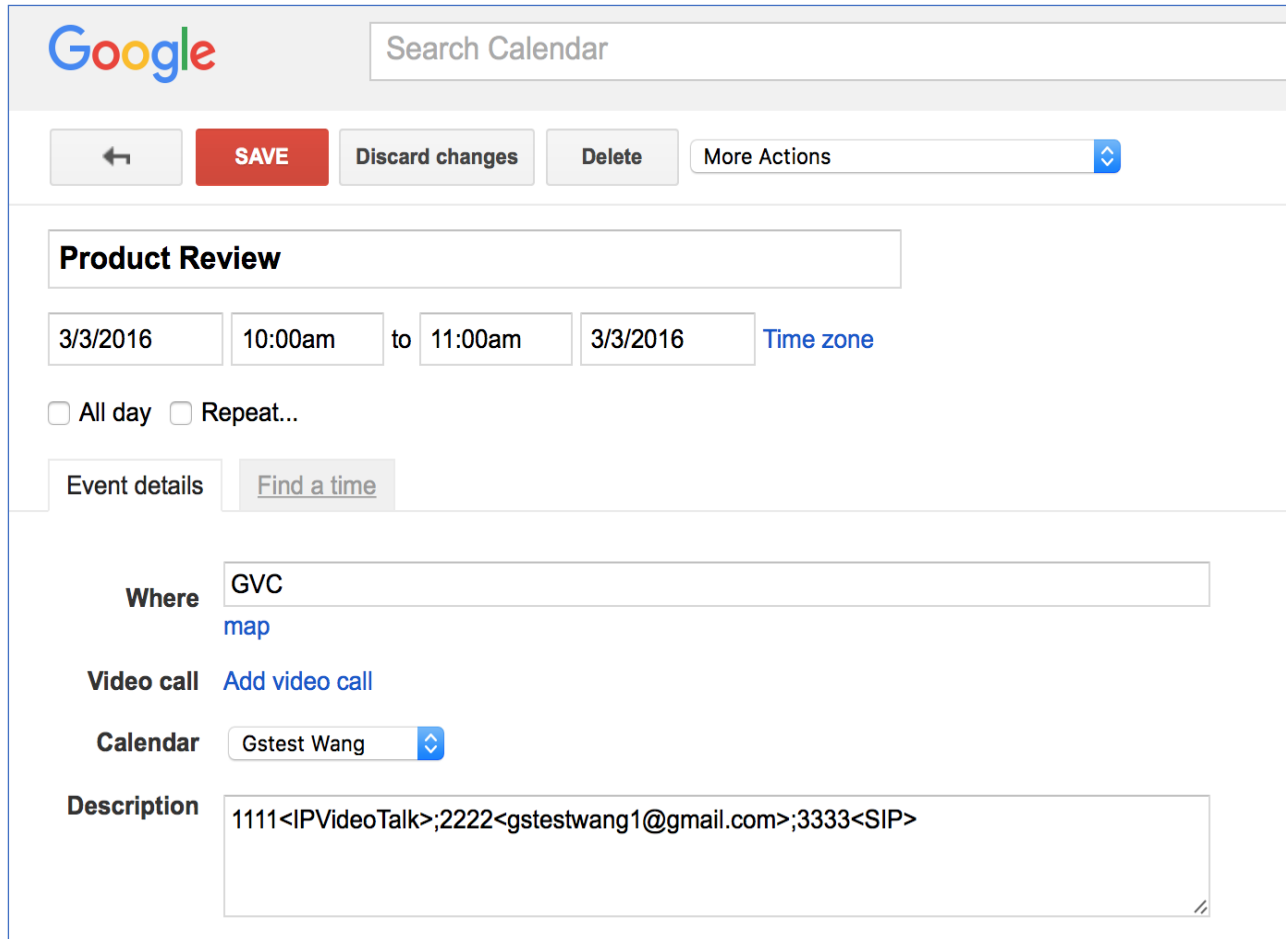

The screenshot shows the Google Calendar 'Create Event' interface. At the top, there is a search bar and navigation buttons: a back arrow, a red 'SAVE' button, 'Discard changes', 'Delete', and a 'More Actions' dropdown menu. The event title is 'Product Review'. The date and time are set to 3/3/2016 from 10:00am to 11:00am. There are checkboxes for 'All day' and 'Repeat...'. Below the date/time fields are 'Event details' and 'Find a time' buttons. The 'Where' field contains 'GVC' with a 'map' link below it. The 'Video call' section has an 'Add video call' link. The 'Calendar' dropdown is set to 'Gstest Wang'. The 'Description' field contains the text: '1111<IPVideoTalk>;2222<gstestwang1@gmail.com>;3333<SIP>'. A small 'x' icon is visible in the bottom right corner of the description field.

Figure 77: Creating New Event in Google Calendar

3. The new event will be displayed in GVC3200/GVC3202 schedule shortly.

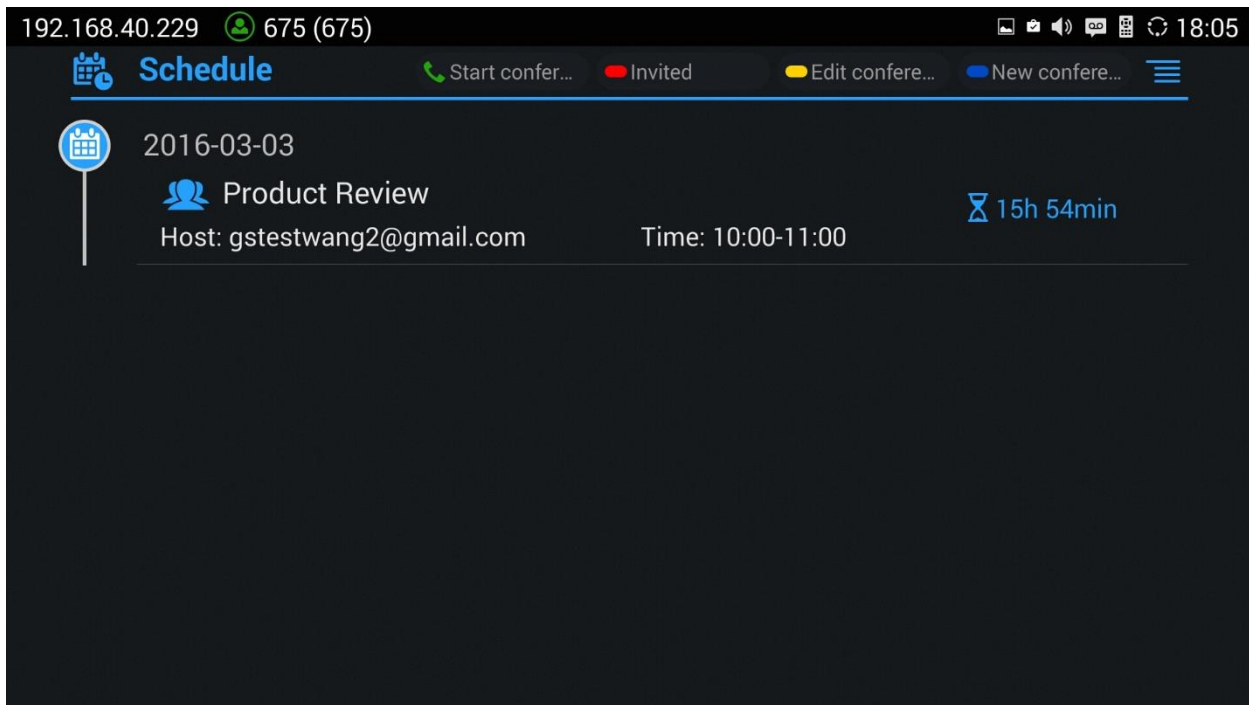

Figure 78: Google Calendar Event Synced in Schedule

- To schedule meeting on GVC3200/GVC3202 and then sync up with Google Calendar**
 On GVC3200/GVC3202 LCD idle screen (or web UI→Contacts)→Schedule, select the Google account as the “Related Account” and fill up other details to schedule the conference using Google account. The created conference will be synced up in Google Calendar.

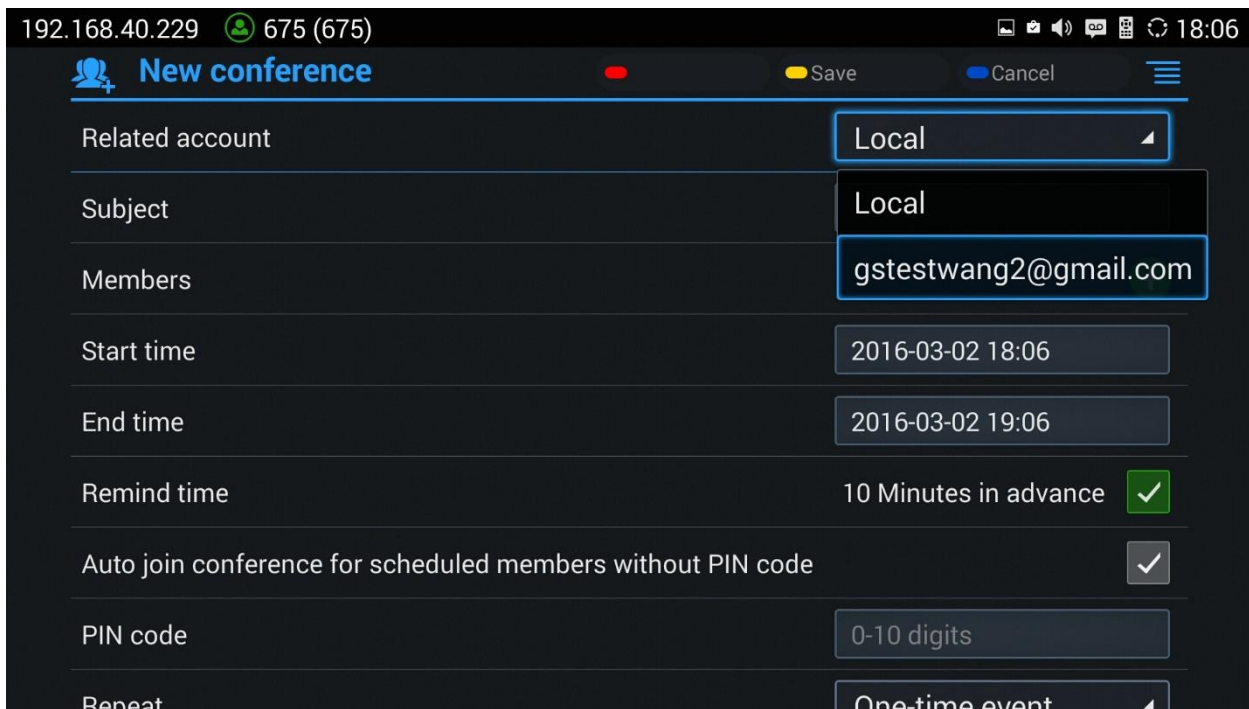



Figure 79: Set “Related Account” to Google Account

Custom App on Home Screen

Users could add one app to the home screen for easy access. GVC3200/GVC3202 only supports custom one app on home screen. The new app will overwrite the older one.

On the Home screen, click on "Custom Home App" and select one app. Press "OK" key to confirm. The system will go back to Home screen automatically and users could find the app has already been added.

To remove or change the Custom Home App, go to LCD **Home screen**→**Applications**. Click on  and select the option to modify custom app. Users could de-select the existing custom app, or change to a different app.

Move App to SD Card

The apps that are not built-in on GVC320x can be moved to an external SD card plugged to the GVC320x from GVC320x LCD→**Settings**→**System**→**Apps** page.

- Users could check the apps list on the external SD card by pressing the Blue shortcut key on the GVC320x's remote control.

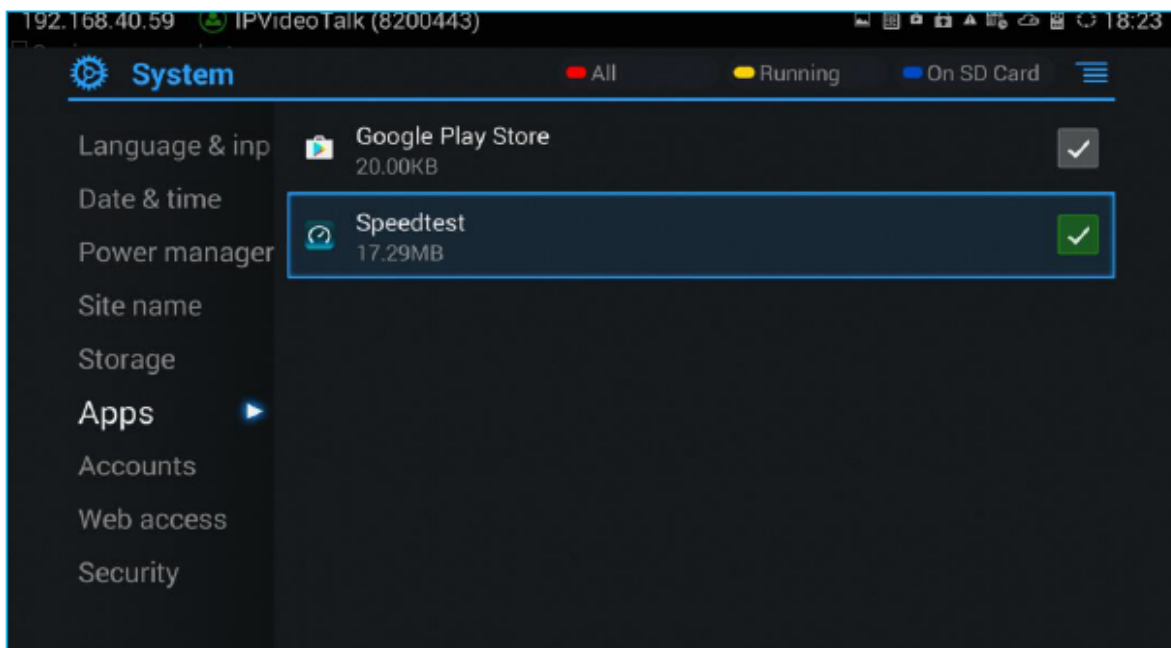

Figure 80: System→ Apps

- Choose the target app that needs to be moved to SD card, it will show its detailed information, then Click on "Move to SD card" to make the change take effect. After configuration change, note that the moved app will not be listed anymore on GVC320x device after the external SD card is ejected.

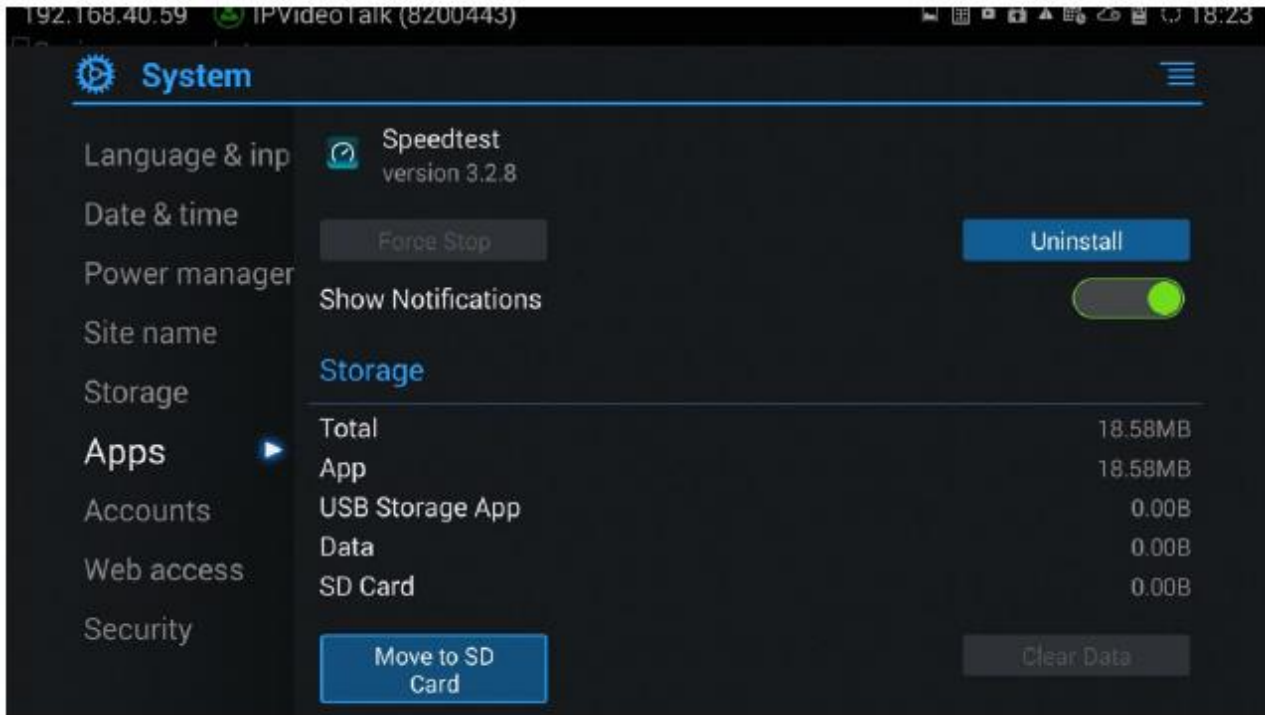

Figure 81: Move App to SD card

- To move the app back to the GVC320x internal storage, users could click “Move to device” on the detailed information page for the app on GVC320x LCD→**Settings**→**System**→**Apps** page.

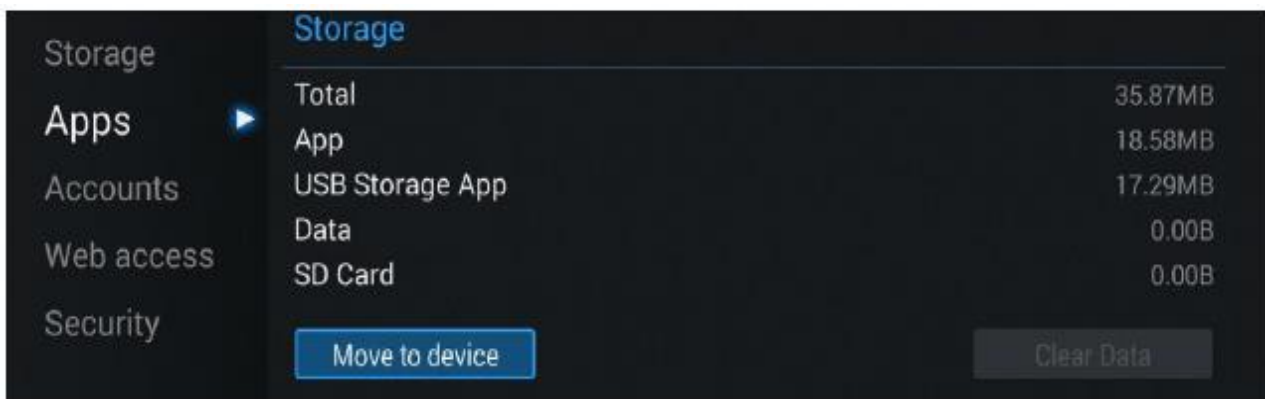



Figure 82: Move App to Device Storage

Uninstall Application

The applications (except the system applications) on GVC3200/GVC3202 can be uninstalled. Go to LCD Home screen→Applications, click on  and select "Uninstall Mode". Users will see the apps that can be deleted shown with  icon. Select and confirm the uninstallation.

Once done, press  on the remote control, or press  to go back to normal mode.

GS MARKET

GVC3200/GVC3202 provides access to apps directly via built-in GS market. Users could download the apps from the market and install to GVC3200/GVC3202.

Search Apps

On GVC3200/GVC3202 Home screen, click on **Applications** → **GS Market**  Users could view the apps by category, or input key words and click on SEARCH icon to search the app.

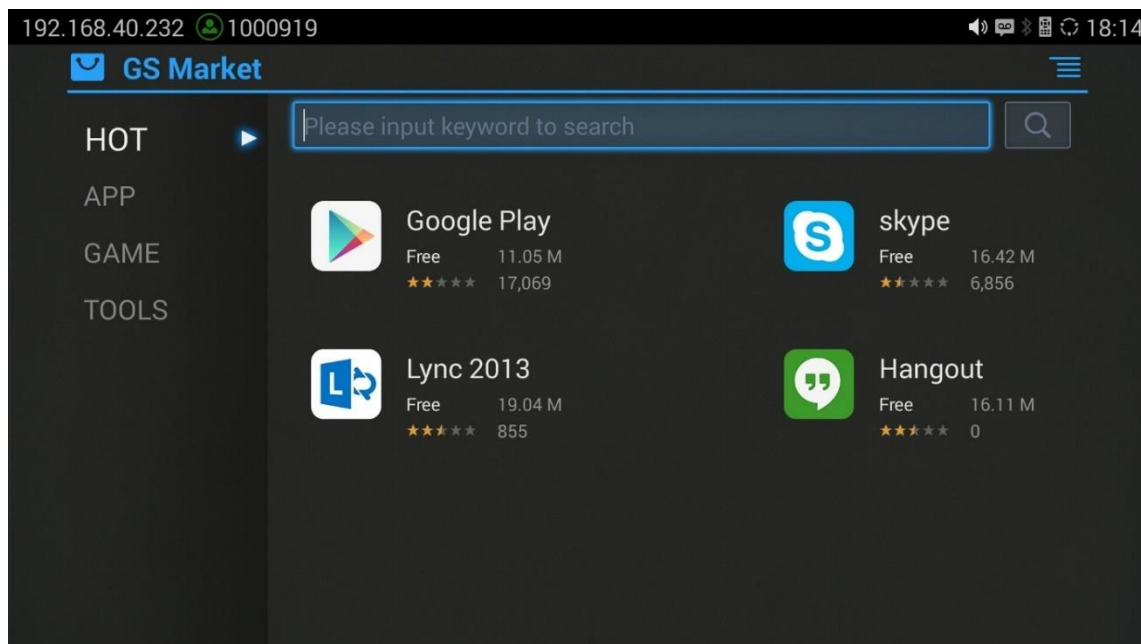



Figure 83: GVC3200/GVC3202 GS Market

Download and Install Apps

- Users could see that if the app has been installed or downloaded by pressing the blue shortcut key.
- Press MENU key  to view the downloaded apps and installed apps.
- Users could press the blue shortcut key on GVC3200/GVC3202 remote control to cancel download in process.
- The installing process will be started automatically after downloading the app.
- Go to Installed screen to view the installed apps, or press the blue shortcut key on the remote control to uninstall the downloaded apps.

Update Apps

GVC3200/GVC3202 will detect to update automatically if there is new version available for the installed apps when the network connection is normal. Users can view the relevant information, and update apps on the Installed screen.



IPVIDEOTALK

The GVC3200/GVC3202 has a built-in IPVideoTalk account that requires the user to activate it before using it. The IPVideoTalk application provides an interface for the user to manage this service on the GVC3200/GVC3202, e.g., view enterprise directory contacts, check and reply to notices from IPVideoTalk server as well as change IPVideoTalk settings. The user can access IPVideoTalk application from

LCD→Applications→IPVideoTalk .



Note:

Before using IPVideoTalk Service, please make sure the GVC3200/GVC3202 is on firmware version 1.0.3.8 or later. If the GVC3200/GVC3202's firmware version is too low, an upgrading prompt will be sent to Notices inbox on the GVC3200/GVC3202.

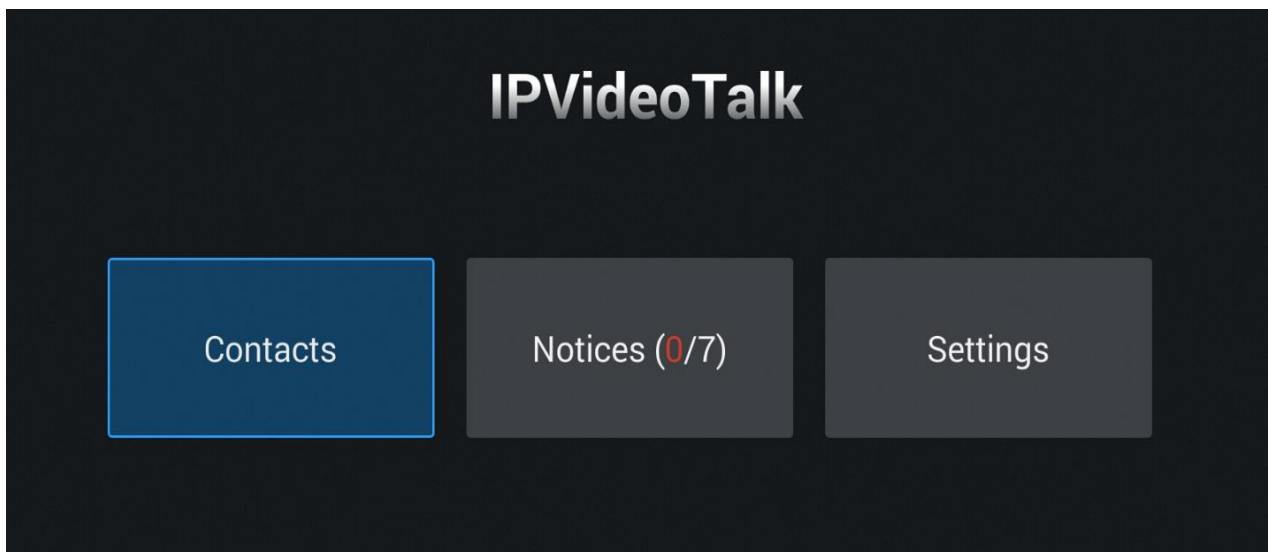

Figure 84: GVC3200/GVC3202 IPVideoTalk Application

Contacts

The contacts are managed centrally in the server side. Users can access by selecting “Contacts”.

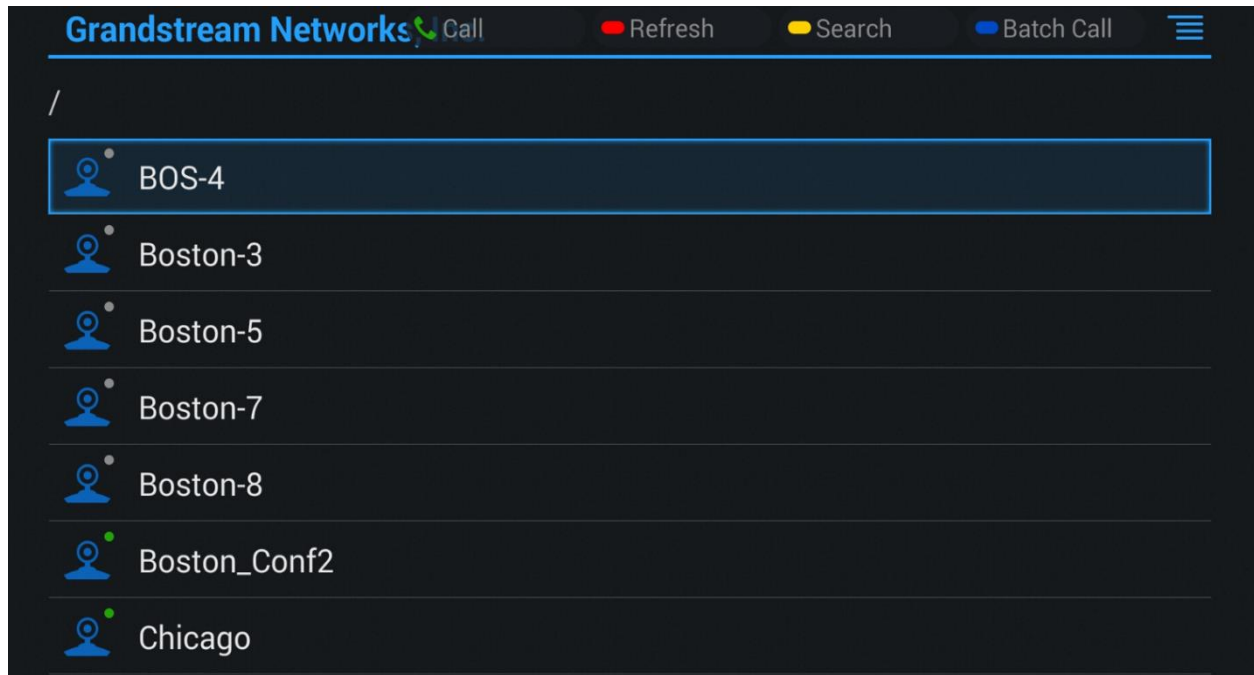







Figure 85: IPVideoTalk Application→Enterprise Directory

- In Contacts, the users can view account status: online - , offline - .
- Users can also view Contacts types:
 - a. Group. 
 - b. Regular contacts with name, phone number, Email address etc. 
 - c. Public GVC3200/GVC3202 Device with an IPVideoTalk ID. 
- Select an entry in the directory and press the Green Call button  on the GVC3200/GVC3202 remote control to call this contact.
- Press the red shortcut key on the GVC3200/GVC3202 remote control to refresh the directory.
- Press the yellow shortcut key on the GVC3200/GVC3202 remote control to search contacts in the directory.
- Press the blue shortcut key on the GVC3200/GVC3202 remote control to select entries and make a batch call to multiple contacts in the directory.

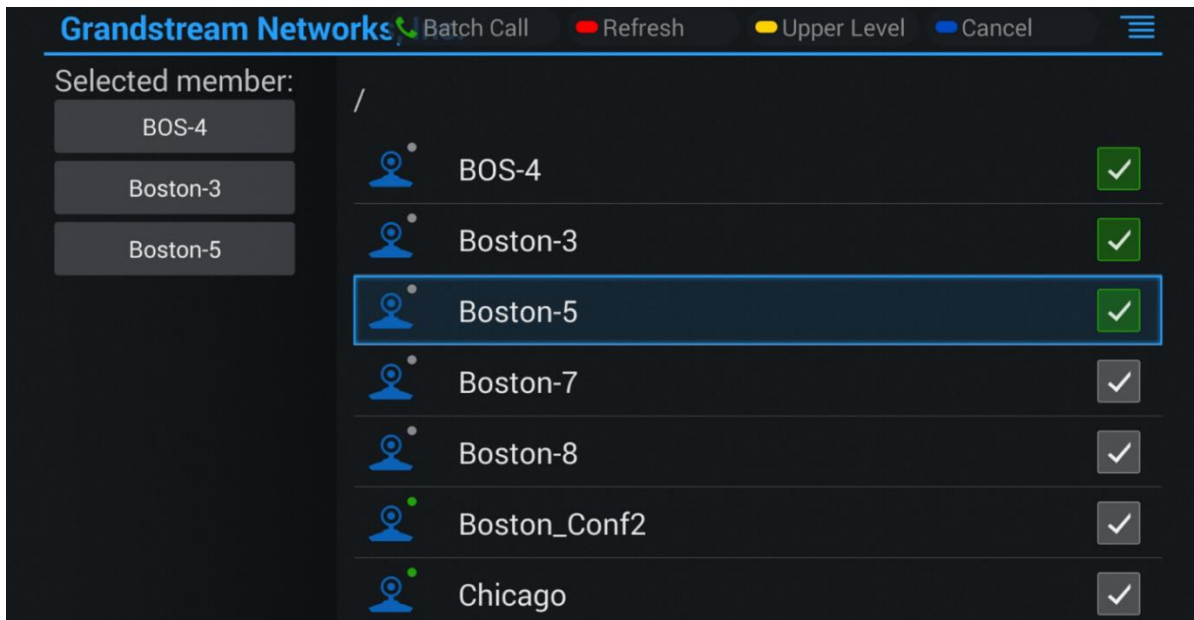

Figure 86: IPVideoTalk Application→Enterprise Directory: Batch Call

Notices

In the IPVideoTalk application, any incoming messages from the server side will be displayed in “Notices”. In the following figure, “2” indicates the number of new message and “3” indicates the number of total messages.

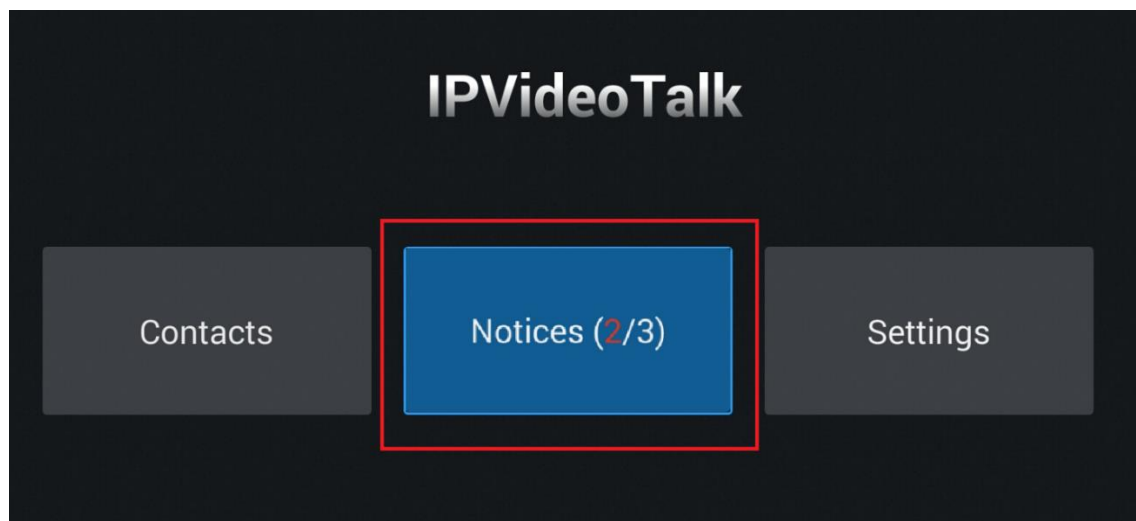

Figure 87: IPVideoTalk Application→Notices

Click on “Notices” to access the messages. Use the navigations keys/OK keys on the GVC3200/GVC3202 remote control to select and read the messages. For the messages that requires user’s reply, a prompt will pop up for the users to make a selection.

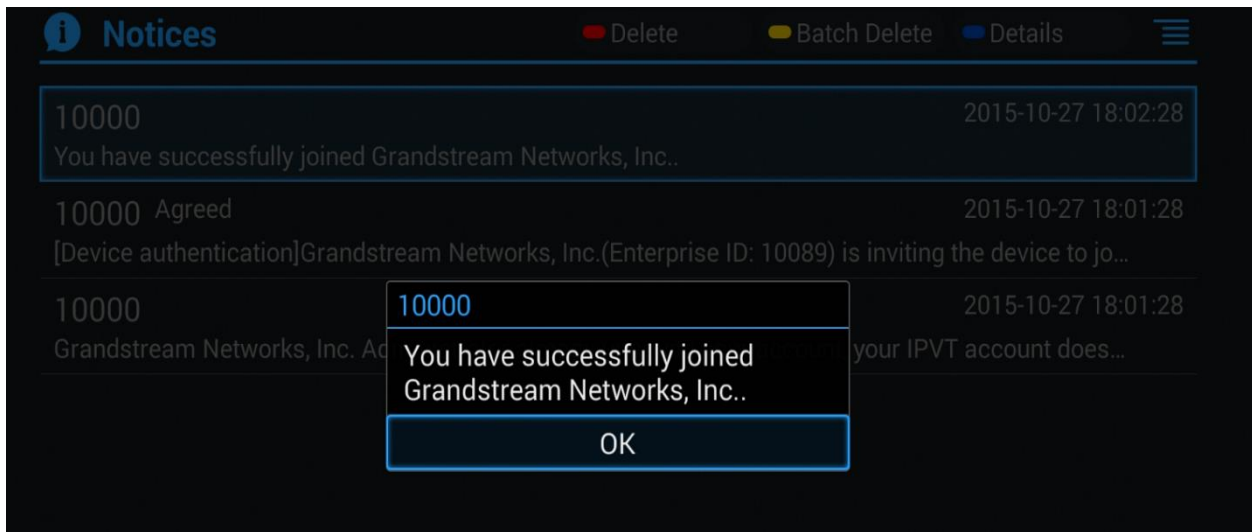
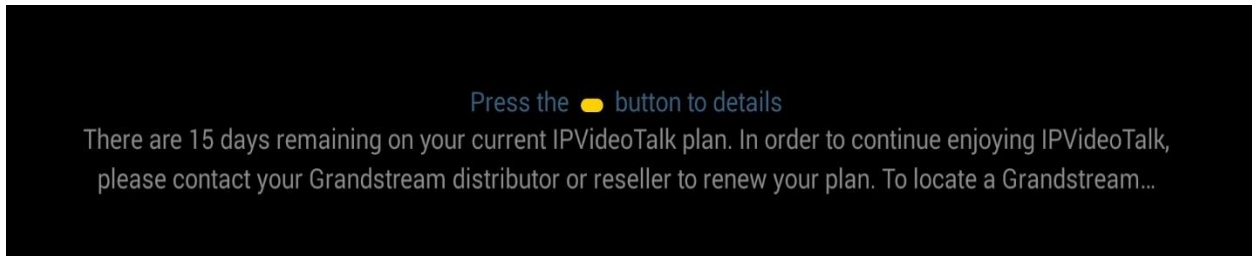
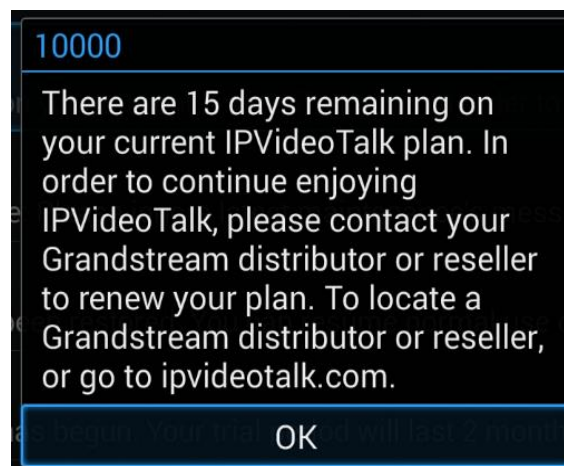



Figure 88: IPVideoTalk Application→Notices: Message Prompt

When IPVideoTalk plan is about to expire or already expired, a message will appear on the bottom of GVC3200/GVC3202 LCD home screen. Press yellow short key to view message details.



Also, detailed information is on GVC3200/GVC3202 LCD **menu→Applications→IPVideoTalk application→Notices**.



If there are new incoming messages for the IPVideoTalk account, users will see indicator icon  on the top status bar. Also on the upper right corner of the IPVideoTalk application icon in Application menu, users will see the number of new messages displayed.

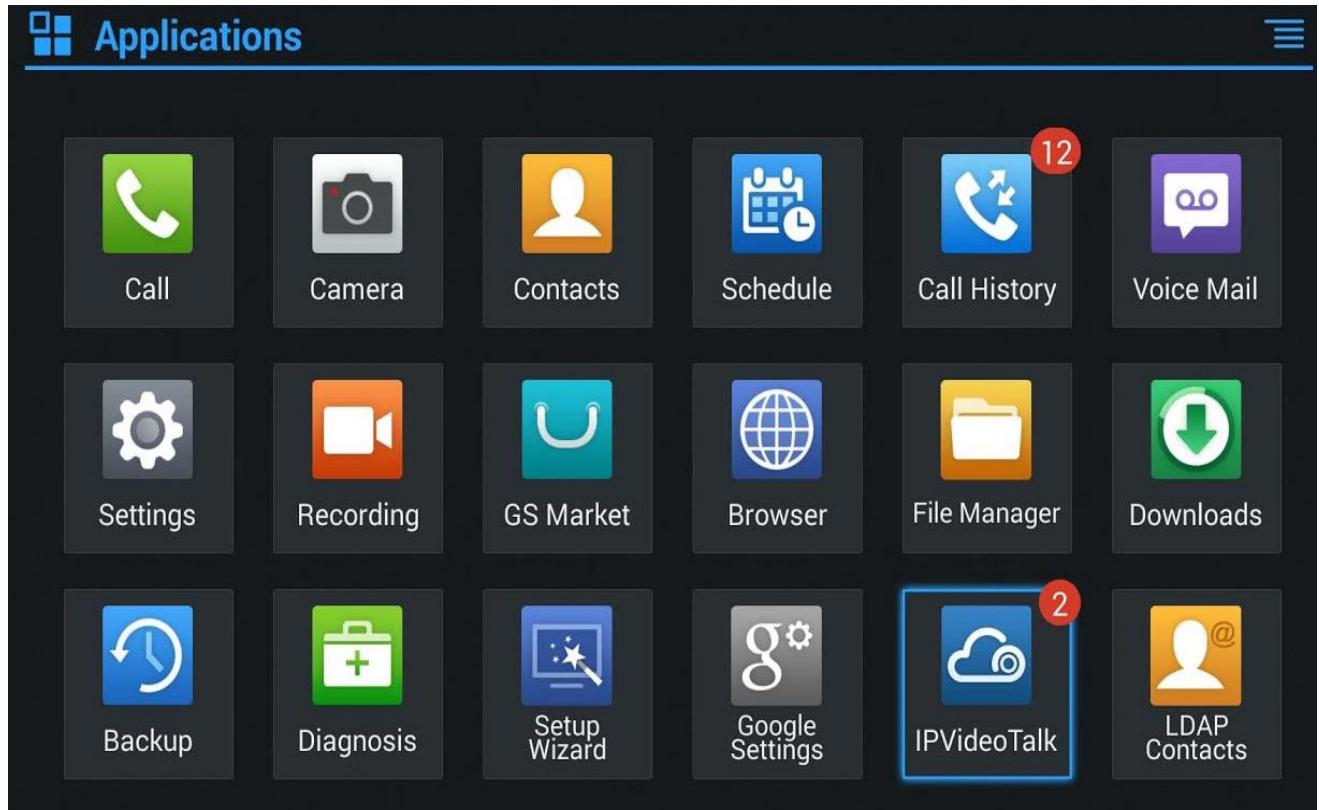

Figure 89: Message Indicator for IPVideoTalk Application

Settings

In the IPVideoTalk application, click on “Settings” to configure “Account Active” and “Display Name” for the IPVideoTalk account on GVC3200/GVC3202. The users could also click on “Device Code”, “Current plans”, “Business” for more plan details. Besides, current IPVideoTalk version information will be shown under “Application Information”.

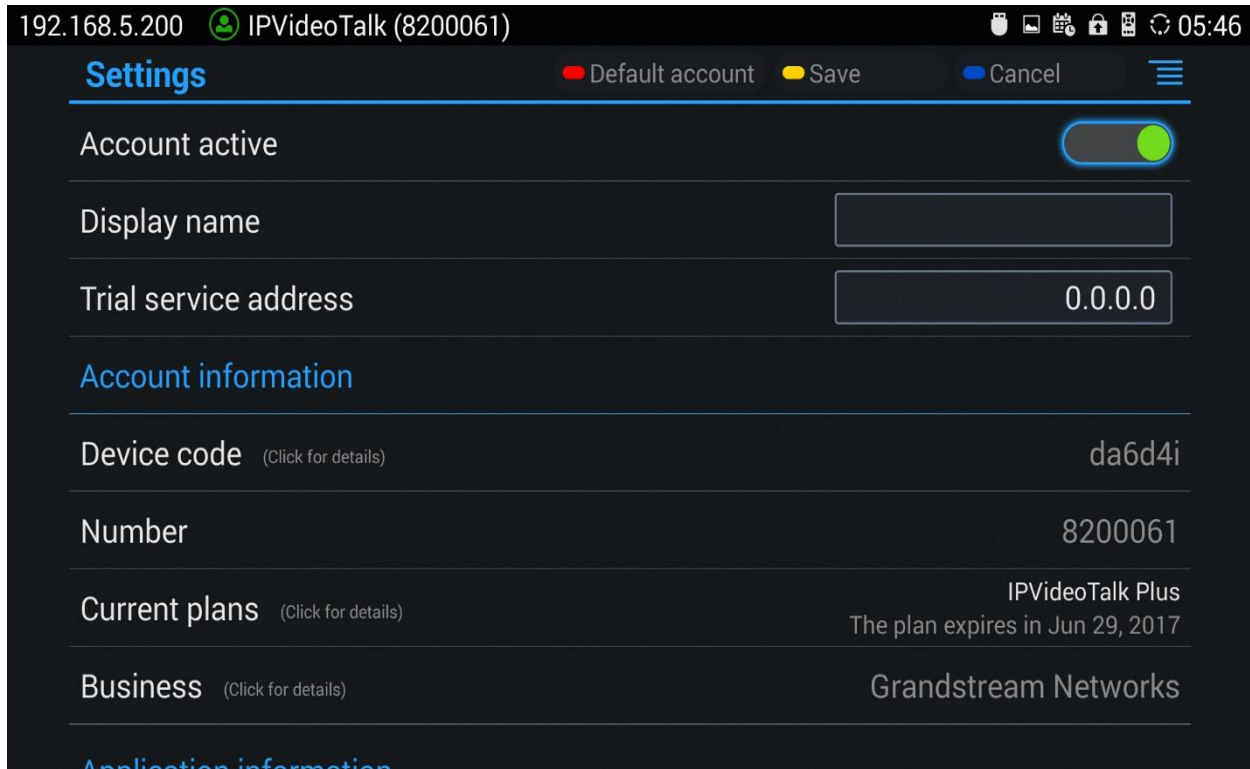
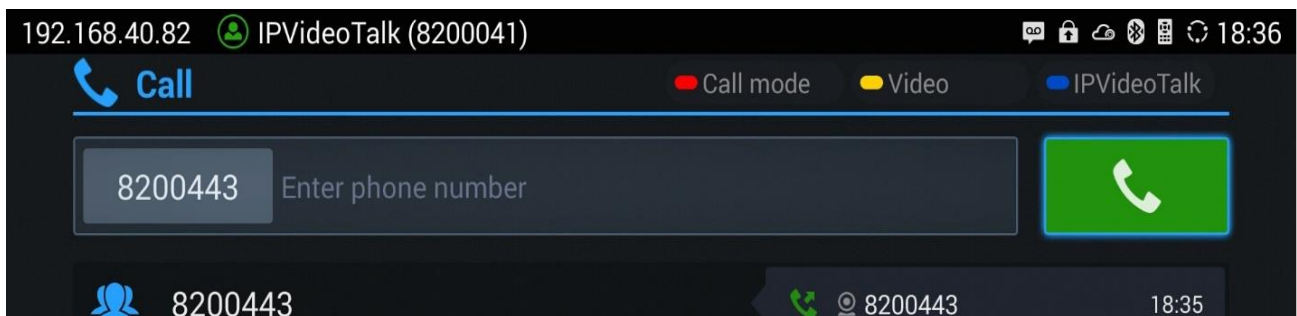

Figure 90: IPVideoTalk Account Settings

Join an IPVideoTalk Meeting

Users can join an IPVideoTalk meeting by dialing the host GVC3200/GVC3202's IPVideoTalk ID or meeting ID. Please note only after meeting starts, GVC3200/GVC3202 can use this method to join the conference as a participant.

- Dialing host GVC3200/GVC3202's IPVideoTalk ID to join an active meeting



- Dialing meeting ID to join an active meeting.



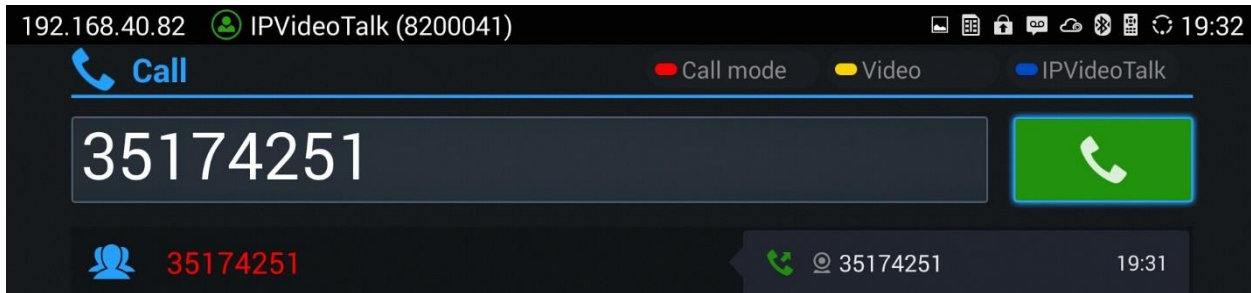

Busy Tone Responses

Please note GVC320x can only join one IPVideoTalk meeting at one time.

Note that a specific busy response messages rather than SIP 486 busy error prompt on IPVideoTalk dialing interface when trying “The number you dialed is hosting another meeting”. Host GVC cannot be added as a participant of another IPVideoTalk meeting.

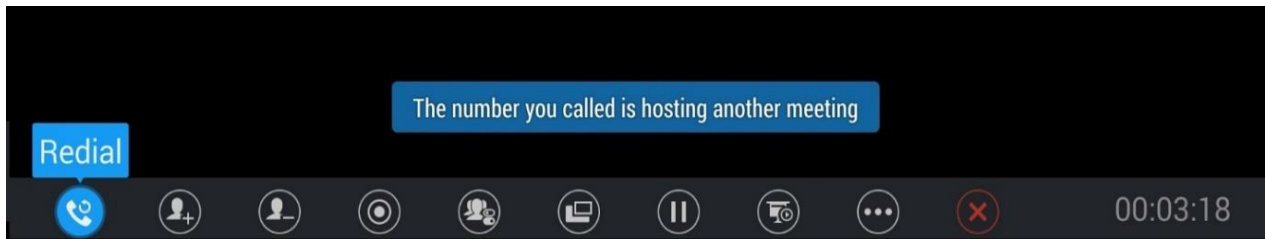

“The number you dialed is joining another meeting”. Participant GVC of an active IPVideoTalk meeting cannot be added to another meeting.

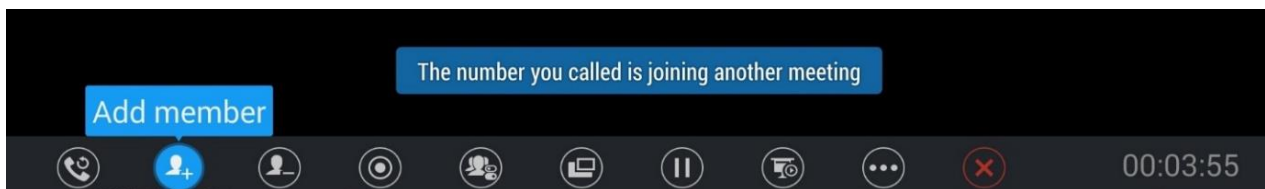

Manually Start IPVideoTalk Tip

If a meeting is scheduled from IPVideoTalk Web Portal, then the meeting will sync to host GVC3200/GVC3202 device LCD→Schedule interface. There will be a prompt message “Manually start the meeting will need to re-schedule, please confirm” when pressing CALL button on remoter to start the meeting manually before or after scheduled time.



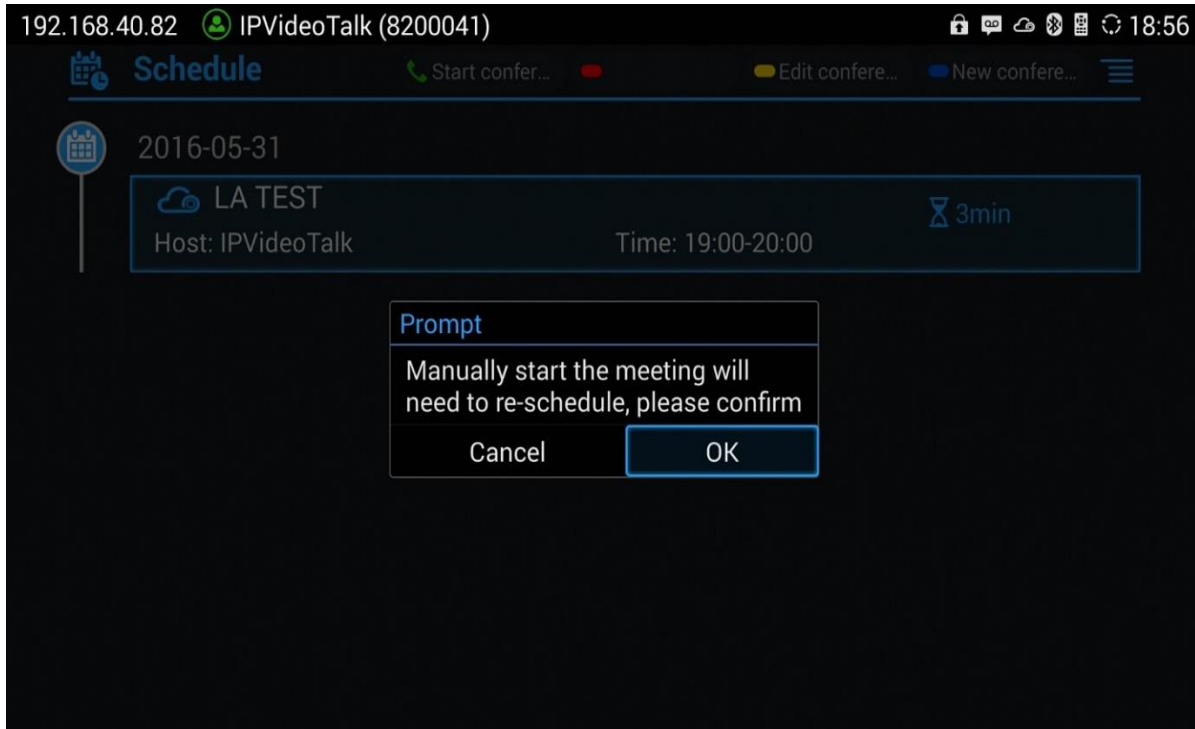

Figure 91: Manually start Scheduled Meeting

Note:

The host and invitees of webinar receive a reminder prompt for preparation to host/join the meeting before its start.

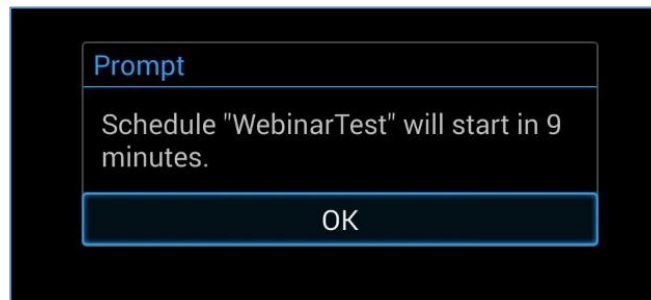



Figure 92: Reminder prompt for preparation before starting the webinar

For more information about your IPVideoTalk services, settings, how to manage accounts and schedule meetings, please check IPVideoTalk user manual from <http://www.ipvideotalk.com>

Hand Down/Up in IPVideoTalk Meeting

If GVC320x joins an IPVideoTalk meeting as a participant and the host is any WebRTC client, the participant could click on button  on GVC320x LCD→Call screen to raise hand to attract attention from host that

he/she wants to be unmuted or needs any help.

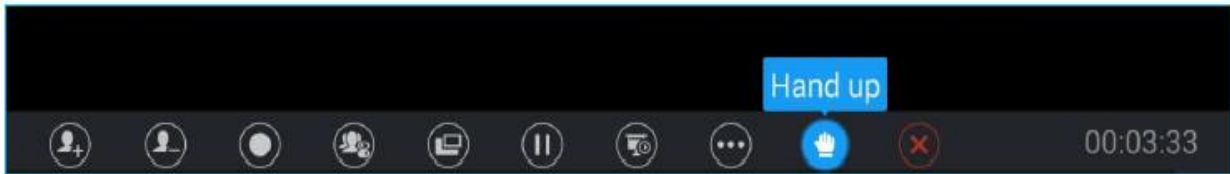

Figure 93: Hand up - IPVideoTalk

The raised hand status of GVC320x participants could be checked from Participants List on Host WebRTC Client, as shown in below figure

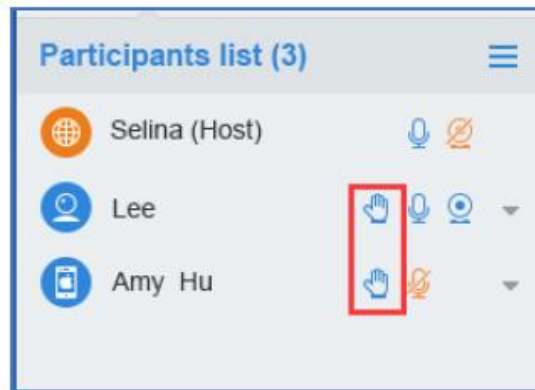

Figure 94: Participants list

The raised hand could be put down by participant itself or WebRTC host.

- Participant GVC320x could hand down itself by clicking on button  again.



Figure 95: Hand down/IPVideotalk

- WebRTC Host could put down GVC's hand.

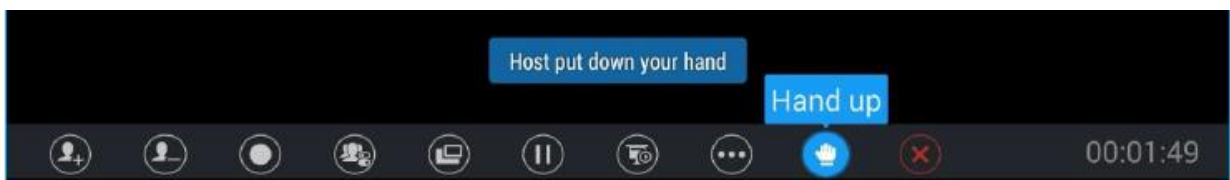



Figure 96: Hand down by Host - IPVideoTalk

Share Local Camera

During IPVT meetings, WebRTC host can request the GVC attendees to share their camera, once the request is being sent, a GVC user can either reject or accept the request for the camera to be shared.

- WebRTC host can request camera sharing by clicking on  icon, next to a GVC attendee.

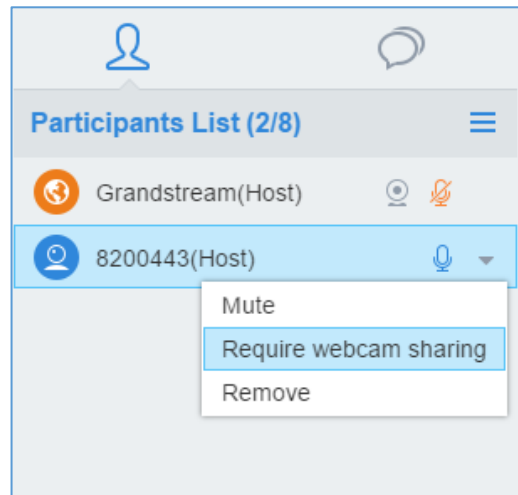

Figure 97: Require Webcam sharing

A request permission will pop up on GVC's screen, and the user can "Accept" or "Reject" the request. If accepted, the GVC video will be shared in the meeting.

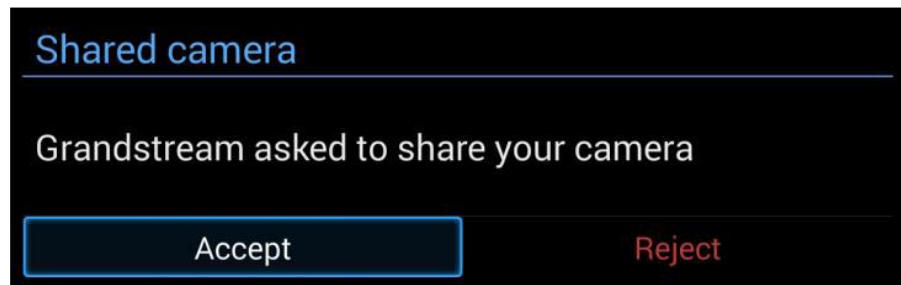

Figure 98: Sharing Camera Request

WebRTC host can also stop the camera feed of a GVC attendee to prevent it from uploading its local video streaming to IPVideoTalk Server.

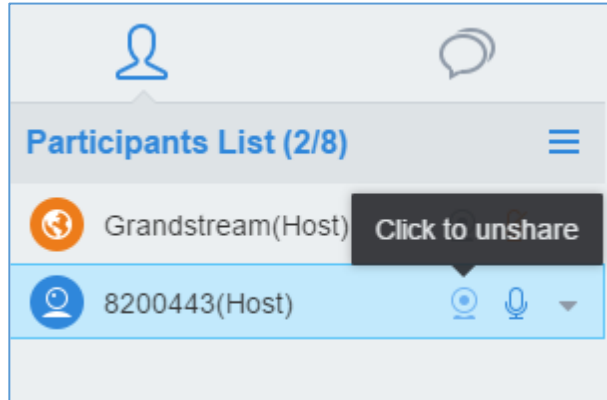



Figure 99: Stop Camera Sharing

Stop Video Upload

Under GVC320x LCD→**Call Screen**→**Conf Control**, users could prevent the GVC320x from uploading local video streaming to IPVideoTalk server during an IPVideoTalk meeting by clicking on icon . Other participants will not receive any video streaming from this GVC320x, and it will switch to 1-way video.

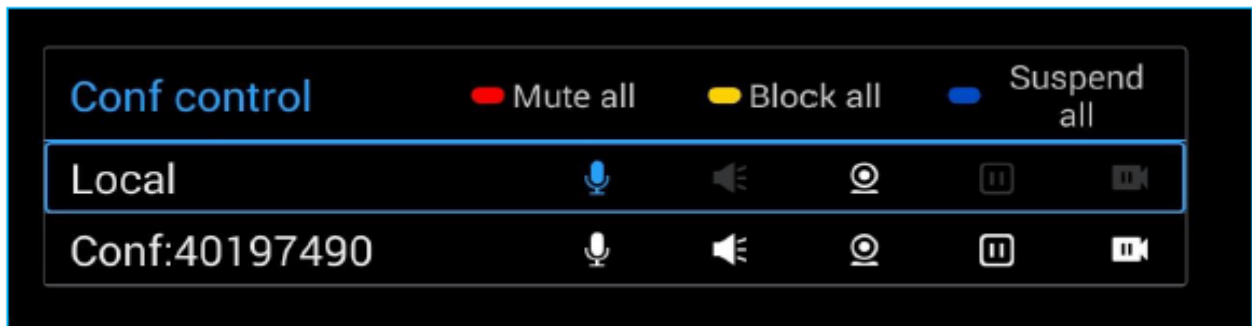

Figure 100: Stop Video Uploading

Start Cloud Recording

During an IPVideoTalk meeting/webinar, a new option is added under Call Screen of host GVC to allow users to control cloud recording.

To start/stop cloud recording, users could click on “Record” button under host GVC320x LCD → Call screen, or press  shortcut key on remote control:



Figure 101 : Start Cloud Recording

There will be an icon **Rec** shown on the left upper corner of host GVC as well as all other participants to indicate the cloud recording is in progress, the screen and record button will also show as follow:



Figure 102 : Recording

Users can at any time stop the recording by clicking the record button and press: **Stop cloud recording**

Users could log in to IPVideoTalk Enterprise web portal → Recordings page to View/Download/Delete the recordings for the cloud meetings/webinars:

Subject	Meeting ID	Organizer	Schedule Email	Start Time	Files
<input type="checkbox"/> IPVideoTalk Meeting	52696990	8200443 -IPVideoTalk Small...	...@grandstream...	07/17/2017 07:4...	Download Delete

Figure 103 : IPVideoTalk Recordings

Note: There are some prerequisites to enable cloud recording features on GVC320x.

- GVC320x needs to be linked with an IPVideoTalk enterprise account.
- The subscribed IPVideoTalk plan should include cloud recording support and adequate cloud storage space for recording. Please refer to IPVideoTalk website or User Manual for the latest plan information.

GVC3200/GVC3202 WEB UI FEATURES

GVC3200/GVC3202 embedded Web server responds to HTTP/HTTPS GET/POST requests. Embedded HTML pages allow users to configure the application device through a Web browser such as Mozilla Firefox, Google Chrome and etc.

Accessing GVC3200/GVC3202 Web GUI

The IP address of GVC3200/GVC3202 displays on OLED display screen on the front panel.

To access GVC3200/GVC3202 Web GUI:

1. Connect the computer to the same network as GVC3200/GVC3202.
2. Make sure GVC3200/GVC3202 is turned on and shows its IP address on OLED display screen.
3. Open a Web browser on your computer.
4. Enter GVC3200/GVC3202's IP address in the address bar of the browser, e.g.: http://192.168.124.111.
5. Enter the administrator's login and password to access the Web Configuration Menu. The default username and password are: admin, admin; You can select English or other language in the drop-down menu of language.



Figure 104: GVC3200/GVC3202 Web GUI - Login

6. Click "Login"  to access the configurations in web UI.



Saving Changes

When changing any setting on GVC3200/GVC3202 web UI, users need to submit them by pressing the SAVE button on the bottom of the page, and then, click the Apply button on the top of the page to apply the configuration changes. For those options with  next to it on the Web page, users have to reboot GVC3200/GVC3202 to take effect.

Definitions

This section describes the 6 options on GVC3200/GVC3202 Web GUI. Please view Settings, Maintenance and Status specifications in Administration Guide.

- **Call**
Users could start video conference and control conference from Web GUI.
- **Contacts**
Contacts, Schedule, Call History
- **Device Control**
Video Control, Audio Control
- **Settings**
SIP Account, IPVideoTalk account, Blue Jeans account, Network Settings, Peripheral, Call Features, General Settings, and Security Settings
- **Maintenance**
Upgrade, Recording, Time & Language, Troubleshooting, Reboot
- **Status**
Account Status, Peripheral Status, Network Status, System Info and Remote Control

Users can log in as an administrator or a normal user. The following table shows the web pages accessible by normal user and administrator. It is recommended to change the default password for user and administrator after login for the first time.

Table 24: GVC3200/GVC3202 Web Access

User Type	Username	Default Password	Accessible Web Pages
Normal User	user	123	<ul style="list-style-type: none"> • Call • Contacts • Device Control • Status • Settings: Network Settings, Peripheral, Security Settings • Maintenance: Recording, Time & Language, Troubleshooting
Administrator	admin	admin	All pages



Toolbar

The web UI tool bar is on the upper right corner of the web UI page.

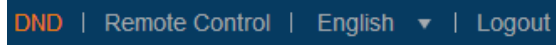

Figure 105: GVC3200/GVC3202 Web UI Tool Bar

- **DND**
It is used to turn on/off DND mode. Once it is enabled, the DND text will turn into red and all incoming calls will be rejected.
- **Remote Control**
Click to bring up virtual remote control panel.
- **English**
Select the display language for the web UI.
- **Logout**
Log out from the web UI.

Call Page

GVC3200/GVC3202 Web UI call page is shown below. Users could make calls and initiate conference from Web UI.

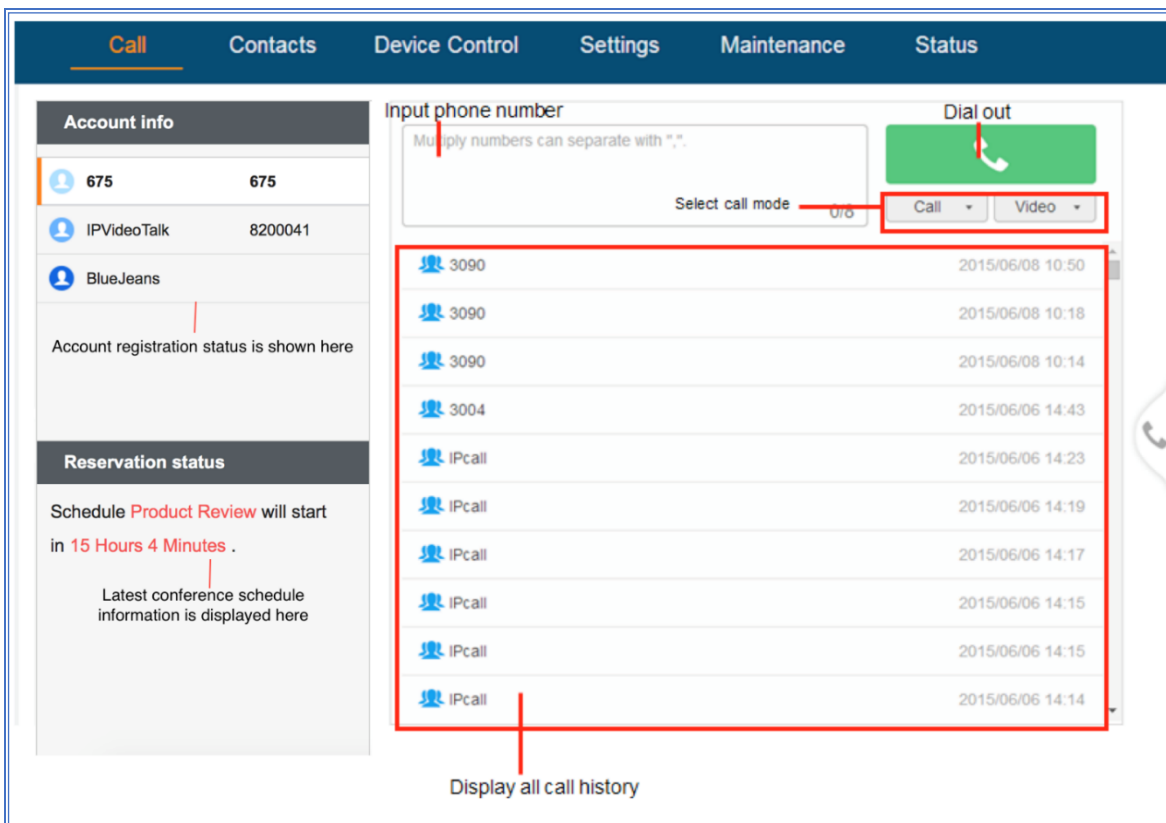



Figure 106: GVC3200/GVC3202 Web UI - Call



Making a Call

Enter phone number in input box, and select call mode, tap on button  to dial out; or, select one call history entry in the list below and click on  to dial out.

Conference Control

When making a new call, initiating a conference or receiving an incoming call, the conference screen will pop up as shown below.

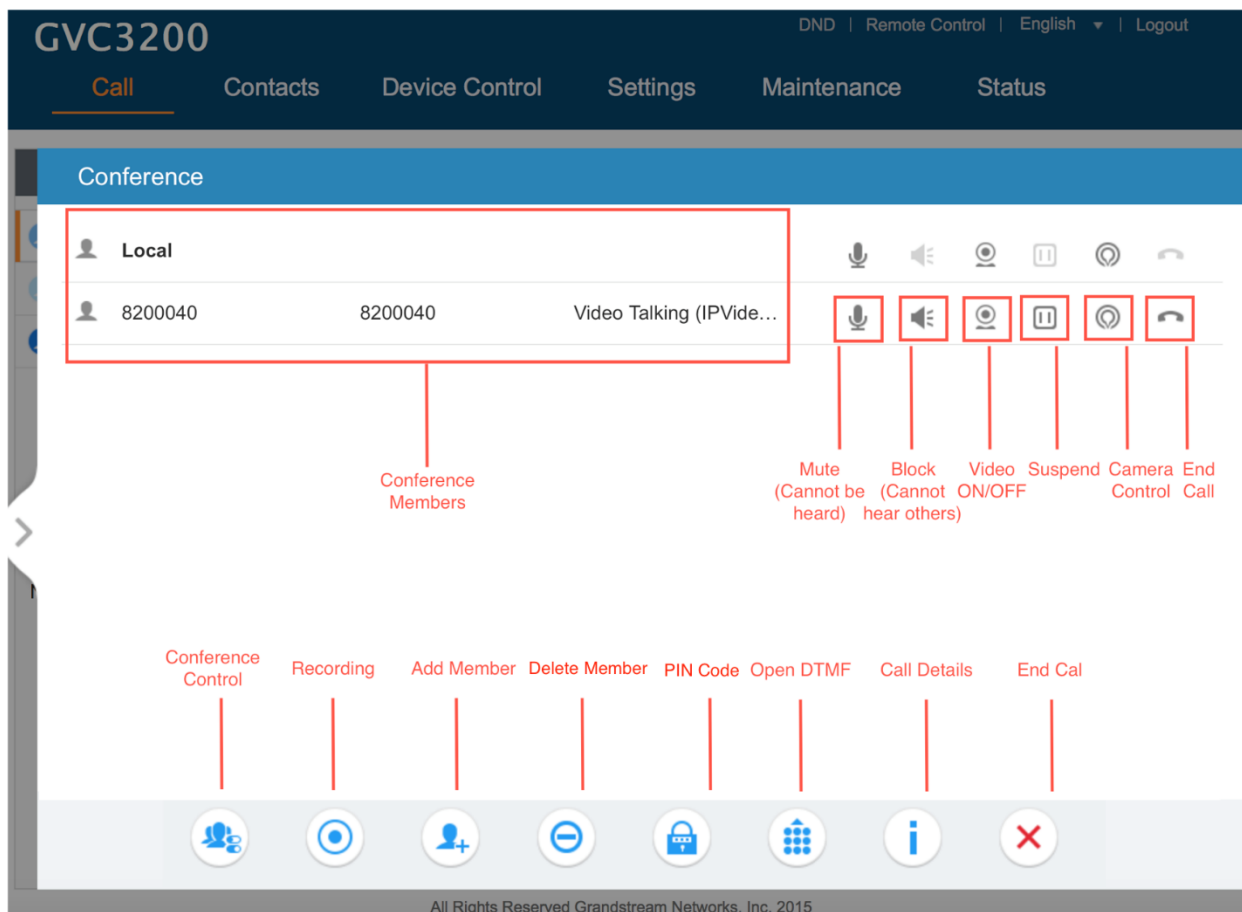

Figure 107: GVC3200/GVC3202 Web UI - Conference Status

Click on the icon for “Conference Control”, users will see a list of control icons on the bottom which are also available in LCD call screen.

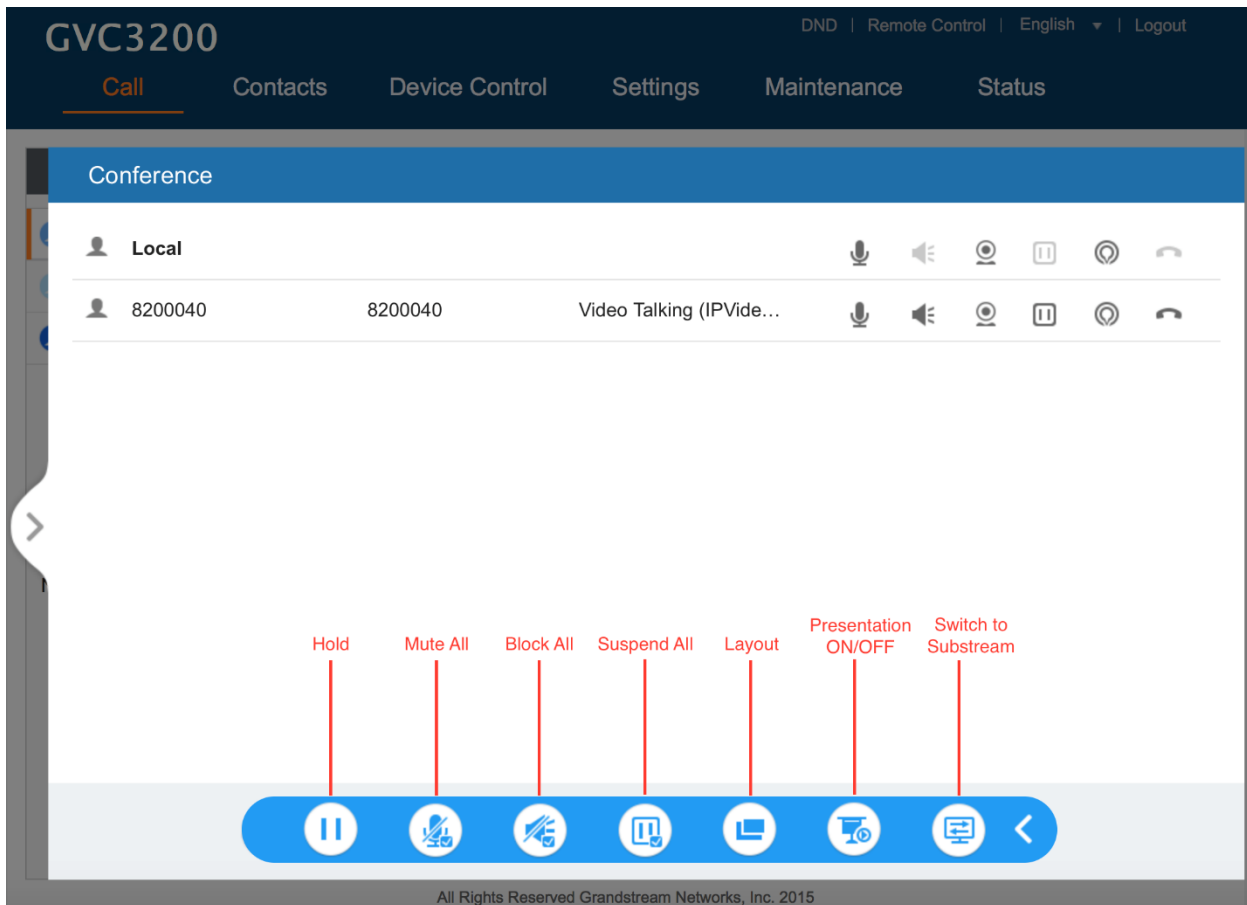

Figure 108: GVC3200/GVC3202 Web UI - Conference Control

Contacts Page

This page lists Contacts, Schedule and Call History.

Contacts

Users could search/add/delete/edit contacts on web page. The operations will be synchronized and can be viewed from LCD as well. The web UI contacts page is as shown below.

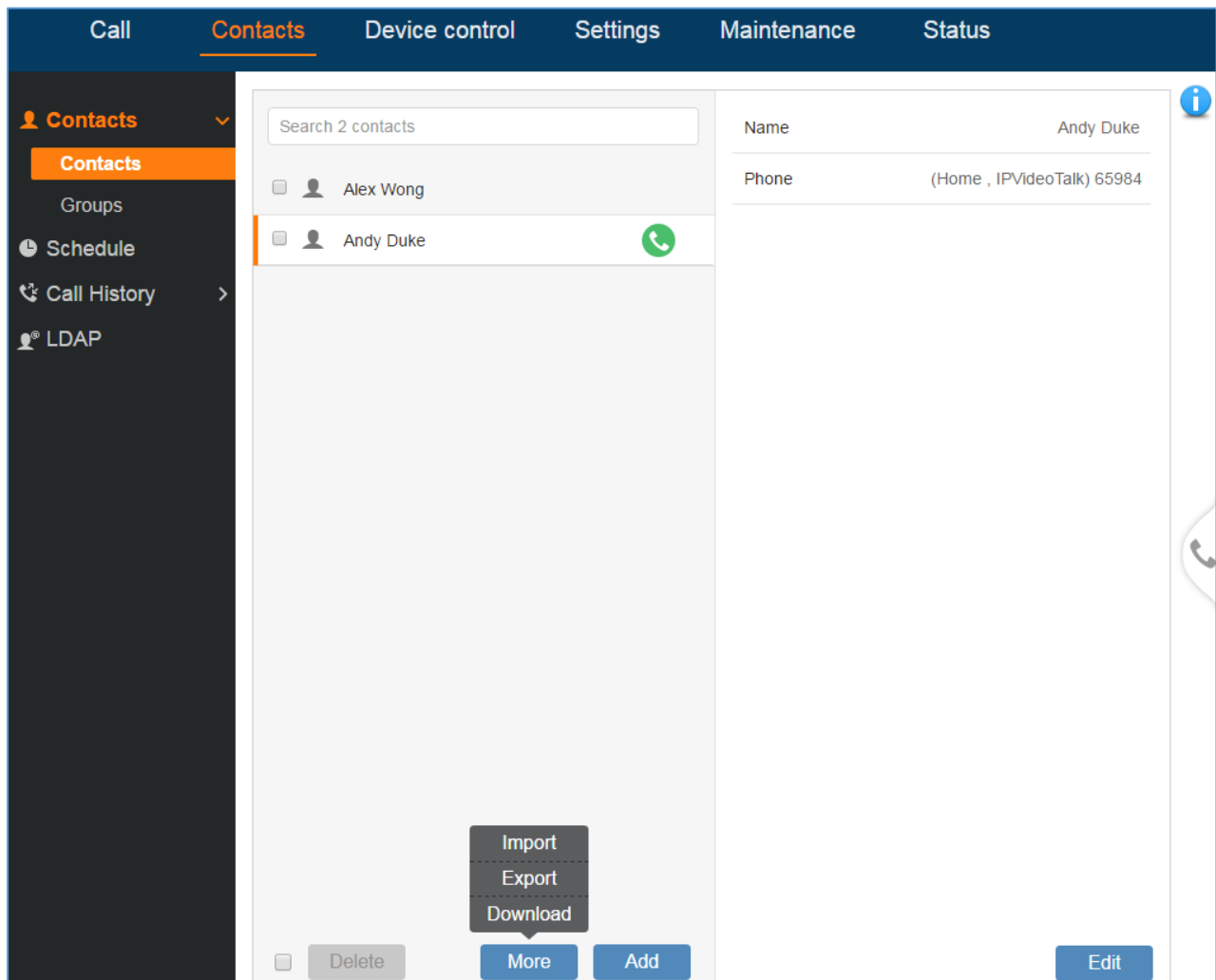

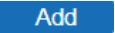



Figure 109: GVC3200/GVC3202 Web UI - Contacts

- Click on  next to the contact to dial the contact.
- Click on “More” to open more options such as export, import and download contact.
- Select "Import" option and users will find import screen on the right. Refer to chapter **Batch Import Contacts** for more details.
- Select "Export" option and users will find export screen on the right. Refer to chapter **Export Contacts** for more details.
- Select "Download" option and users will find download screen on the right. Refer to chapter **Download Contact** for more details.
- Click on  and users will find Add Contact screen on the right. Fill in contact information and save.
- Click on  and users will find Edit Contact screen on the right. Edit contact information and save.
- Click on the checkbox for “Delete” and users can select the contacts to delete from GVC3200/GVC3202.



Groups

GVC3200 supports up to 9-way video conference and GVC3202 supports up to 3-way video conference, including the GVC3200/GVC3202 itself. For GVC3200, if there are more than 8 conference members, only the first 8 members in the group will be dialed; For GVC3202, if there are more than 2 conference members, only the first 2 members in the group will be dialed.

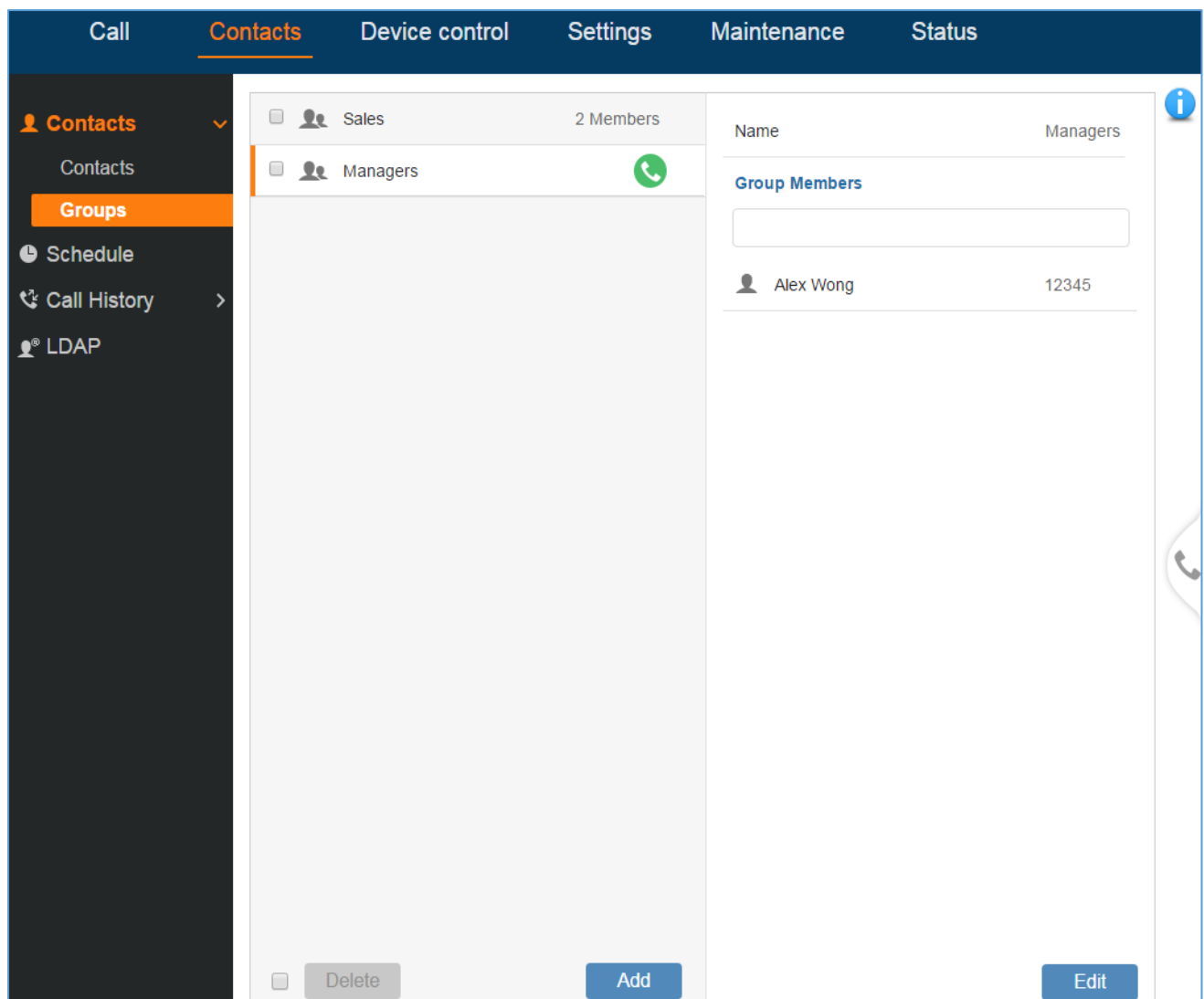

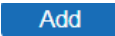



Figure 110: GVC3200/GVC3202 Web UI - Groups

- Click on  next to the group to call the contacts in the group.
- Click on  and users will find Add Group screen on the right. Select group members from existing contacts and save.
- Click on  and users will find Edit Group screen on the right. Edit Group information and save.
- Click on the checkbox for “Delete” and users can select the groups to delete from GVC3200/GVC3202.



Schedule

Conference can be scheduled, edited and deleted from web UI. See figure below. Please refer to chapter **Schedule** for more details for each option.

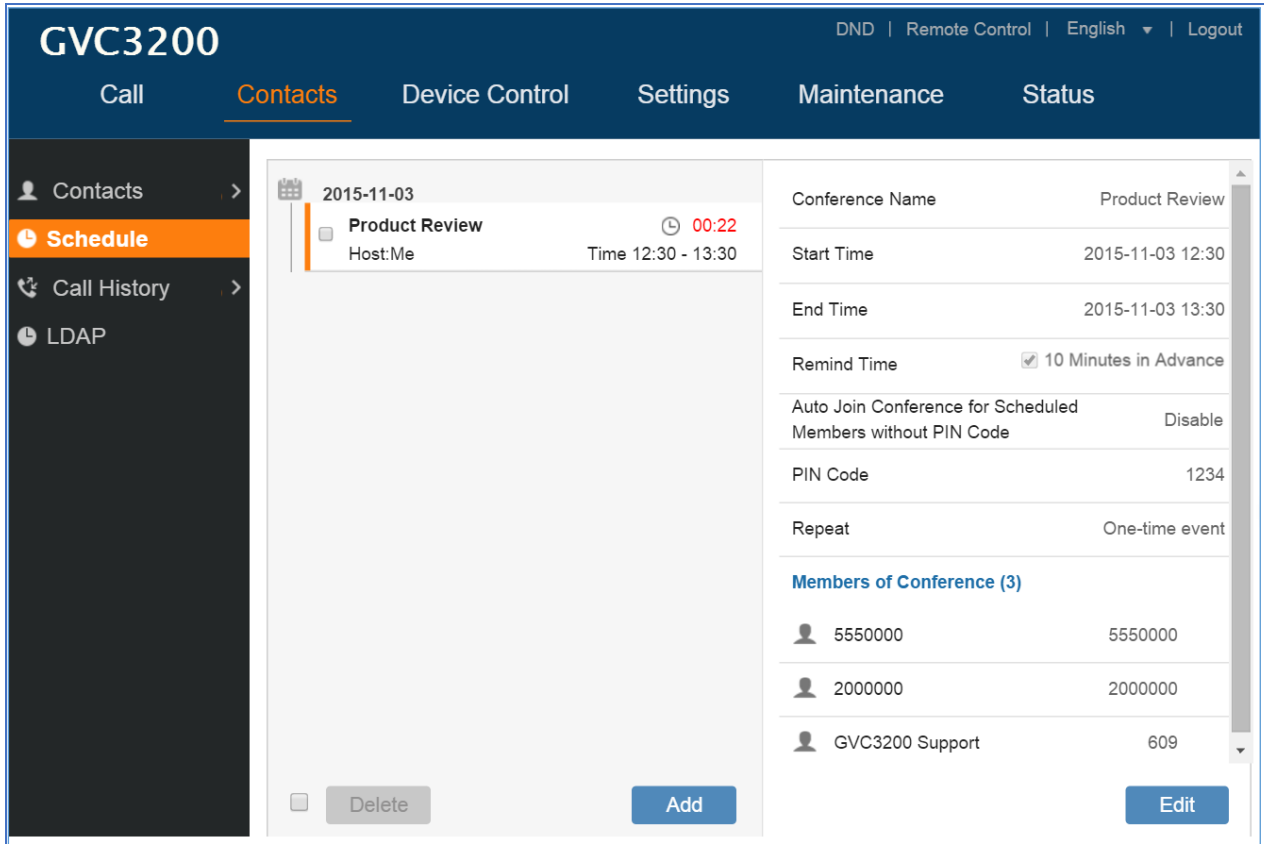

The screenshot shows the GVC3200 web interface. At the top, there's a header with 'GVC3200' and navigation links like 'DND', 'Remote Control', 'English', and 'Logout'. Below the header is a menu with 'Call', 'Contacts', 'Device Control', 'Settings', 'Maintenance', and 'Status'. The 'Contacts' menu is expanded, showing 'Contacts', 'Schedule', 'Call History', and 'LDAP'. The main content area shows a calendar for '2015-11-03' with a single event: 'Product Review' (Host: Me) from 12:30 to 13:30. To the right of the calendar is a configuration panel for the selected conference. The configuration includes: Conference Name (Product Review), Start Time (2015-11-03 12:30), End Time (2015-11-03 13:30), Remind Time (checked, 10 Minutes in Advance), Auto Join Conference for Scheduled Members without PIN Code (Disable), PIN Code (1234), and Repeat (One-time event). Below the configuration is a section titled 'Members of Conference (3)' with a list of three members: 5550000, 2000000, and GVC3200 Support (609). At the bottom of the calendar view are 'Delete' and 'Add' buttons, and at the bottom of the configuration panel is an 'Edit' button.

Figure 111: GVC3200/GVC3202 Web Page - Schedule

- Click on **Add** and users will find Add Schedule screen on the right. Click on “Save” after configuring the schedule.
- Click on **Edit** and users will find Edit Schedule screen on the right. Click on “Save” after editing the schedule.
- Click on the checkbox for “Delete” and users can select the schedules to delete from GVC3200/GVC3202.
- Move the cursor to the scheduled conference where the scheduled time is displayed, icon  will appear for the user to dial out immediately.

Call History

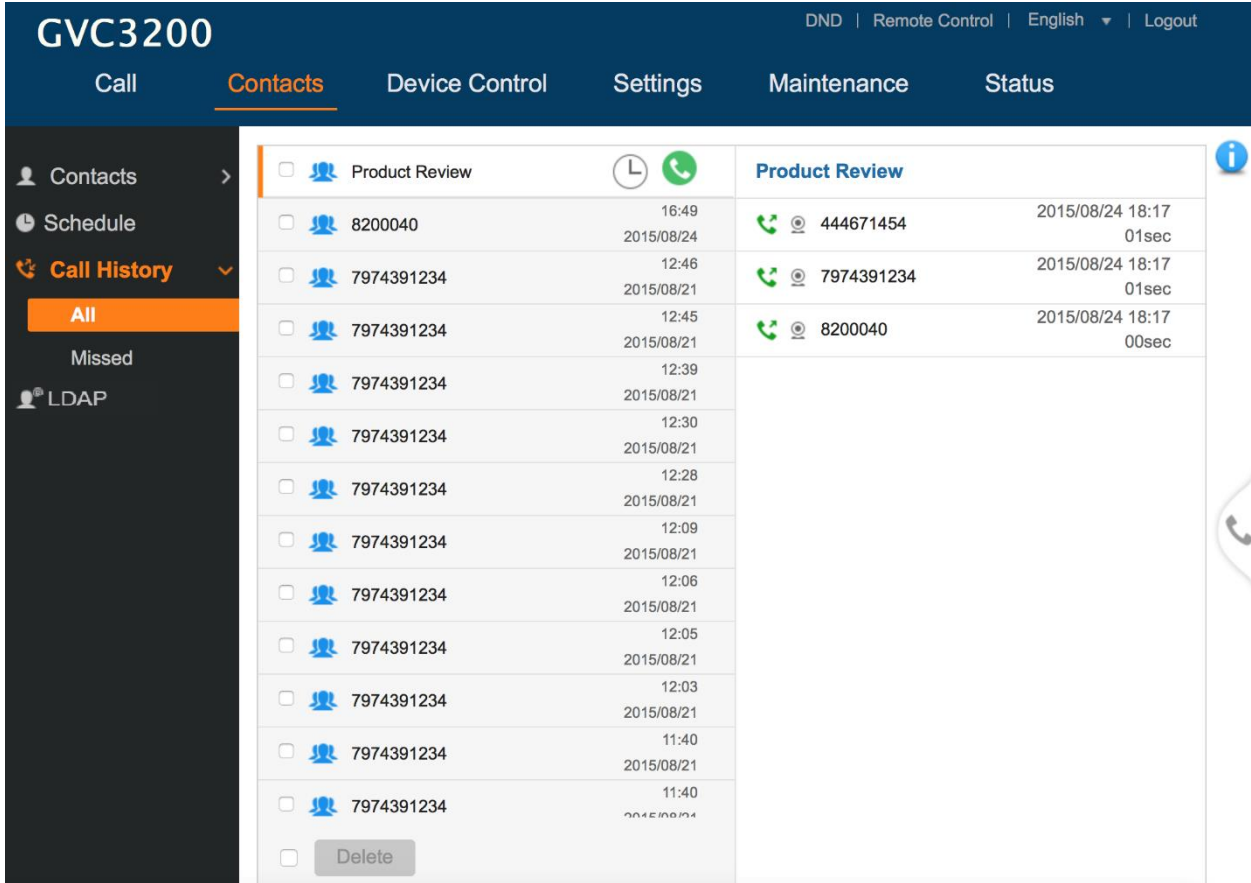

From web UI, users could also access Call history, which is synchronized with the call history from LCD.



The screenshot shows the GVC3200 web interface. The top navigation bar includes 'Call', 'Contacts', 'Device Control', 'Settings', 'Maintenance', and 'Status'. The 'Contacts' tab is active. On the left sidebar, 'Call History' is selected, showing 'All', 'Missed', and 'LDAP' options. The main content area displays a list of call history entries. The first entry, 'Product Review', is selected, and its details are shown on the right side of the interface.

Call ID	Time	Direction	Duration
8200040	2015/08/24 16:49	Incoming	01sec
7974391234	2015/08/21 12:46	Incoming	01sec
7974391234	2015/08/21 12:45	Incoming	00sec
7974391234	2015/08/21 12:39	Incoming	
7974391234	2015/08/21 12:30	Incoming	
7974391234	2015/08/21 12:28	Incoming	
7974391234	2015/08/21 12:09	Incoming	
7974391234	2015/08/21 12:06	Incoming	
7974391234	2015/08/21 12:05	Incoming	
7974391234	2015/08/21 12:03	Incoming	
7974391234	2015/08/21 11:40	Incoming	
7974391234	2015/08/21 11:40	Incoming	

Figure 112: GVC3200/GVC3202 Web UI - Call History

The call history details will be displayed on the right side when there is one entry selected. Users can also move the cursor to the call history time to add this call to schedule by clicking on  , or dial out immediately by clicking on  .

LDAP

This section is the same as LDAP settings under chapter LDAP contacts. Please refer to **LDAP contacts** for more details.

Device Control Page

Video Control

Users could add preset and manipulate PTZ control on this page.

- Move the cursor to one configured preset to preview preset.
- Click one preset to apply the preset.
- Click the un-configured preset, and adjust via the PTZ control panel on the right, then save the configurations.

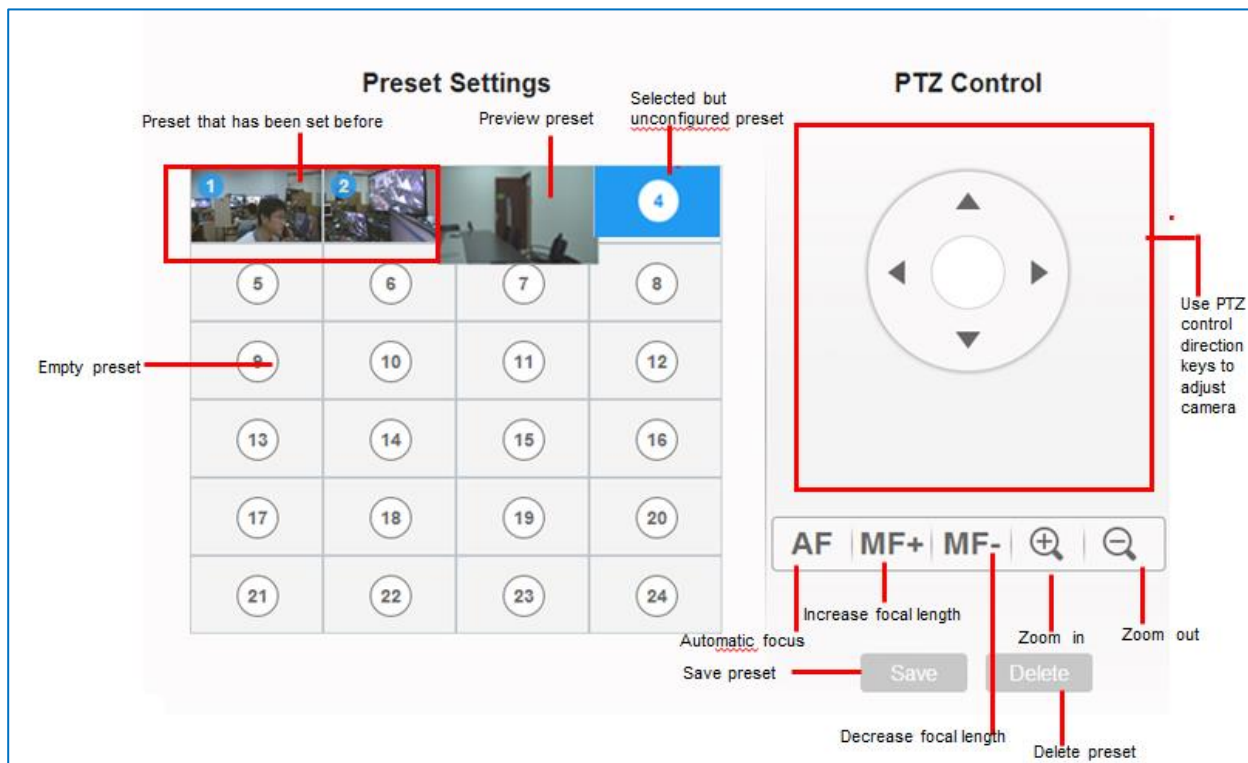

Figure 113: GVC3200/GVC3202 Web UI - Video Control

Audio Control

Table 25: GVC3200/GVC3202 Web UI - Audio Control Parameters

Parameters	Descriptions
Ringtone Volume	Users can slide left or right to adjust ringtone volume.
Media Volume	Users can slide left or right to adjust media volume.
Device Ringtone	Select device ringtone from the dropdown list.



Notification Ringtone	Select device notification ringtone from the dropdown list.
Audio Device	<p>Select the audio device that the GVC3200/GVC3202 will use for audio input and output during call or playing media. The options are “Auto”, “Bluetooth”, “USB” and “HDMI”.</p> <ul style="list-style-type: none"> • Auto GVC3200/GVC3202 will automatically detect whether any USB, Bluetooth or HDMI devices are connected. If only one of them is connected, it will be used as the audio device. If two or three are connected, the priority is “Bluetooth”→”USB”→”HDMI”. • Bluetooth The Bluetooth audio device will be used for audio input and output. • USB The USB audio device will be used for audio input and output. • HDMI The audio input comes from the built-in MIC in GVC3200/GVC3202 and the audio output comes from HDMI. <p>The default setting is "Auto".</p>
Call Progress Tones:	Using these settings, users can configure ring or tone frequencies based on parameters from the local telecom provider. By default, they are set to the North American standard.
Ring Back Tone	Frequencies should be configured with known values to avoid uncomfortable high pitch sounds.
Busy Tone	Syntax: f1=val, f2=val [,c=on1/off1[-on2/off2[-on3/off3]]]; (Frequencies are in Hz and cadence on and off are in 10ms)
Reorder Tone	
Confirmation Tone	ON is the period of ringing ("On time" in 'ms') while OFF is the period of silence. In order to set a continuous ring, OFF should be zero. Otherwise, it will ring ON ms and a pause of OFF ms and then repeat the pattern. Up to three cadences are supported.
Call-waiting Tone	<p>Ring Back Tone:</p> <p>Users can configure ring back tone which is the tone the caller will hear before the callee answers the call. The default value: f1=440@-19,f2=480@-19,c=2000/4000;</p>



	<p>Busy Tone: Users can configure busy tone which will be heard if the callee is busy or on DND. The default value: f1=480@-24,f2=620@-24,c=500/500;</p> <p>Reorder Tone: Users can configure reorder tone which will be heard when the call fails to be established such as wrong account number is dialed, or the call is timed out. The default value: f1=480@-24,f2=620@-24,c=250/250;</p> <p>Confirmation Tone: Users can configure confirmation tone which will be heard when the callee enables call recording function or when the SIP account fails to register. The default value: f1=350@-11,f2=440@-11,c=100/100-100/100-100/100.</p> <p>Call Waiting Tone: Users can configure call waiting tone when there is another incoming call during the call. The default value: f1=440@-13,c=300/2000-300/2000-0/0.</p>
Call-Waiting Tone Gain	<p>This configures the call-waiting tone gain. By default, they are set to the North American standard. Users could select "Low", "Medium" or "High". The default setting is "Low".</p>
Ring Cadence	<p>Configure the default ring cadence for the ring back tone. The default setting is c=2000/4000;</p>

FACTORY RESET

Users could reset GVC3200/GVC3202 to factory settings via the following ways: Reset via local GUI, via Web page, via the reset hole on the back panel of GVC3200/GVC3202. Factory reset will delete configuration info and syslog info.

Warning:

1. Factory reset will erase all GVC3200/GVC3202 configuration information. Please back up all settings or print useful information before making the following operations. If users lose all parameters or records, Grandstream will not take responsibility for the damage or loss.
 2. After factory reset, the remote control will not be paired to GVC3200/GVC3202 anymore. Please go to GVC3200/GVC3202 LCD settings→Network→Bluetooth, select the menu buttons on the upper right and click "Search New Devices". GVC3200/GVC3202 remote control "GS-RCU" with last 4 digits of the remote control MAC address will show in the available device list. Select it to start pairing process on GVC3200/GVC3202, immediately followed by pressing OK+5 keys on the remote control at the same time. The remote control will be paired and connected to GVC3200/GVC3202 again.
-

Reset via LCD

Go to GVC3200/GVC3202 LCD idle screen→**Settings**→**Maintenance**→**Factory Reset**, click on the "Reset" button to bring up the prompt box as shown below. Click "OK" to reboot the device and restore factory settings.



Figure 114: Factory Reset via LCD

Reset via Web UI

1. Log in GVC3200/GVC3202 Web UI→**Maintenance**→**Upgrade**, the "Factory Reset" option is on the bottom of the page.

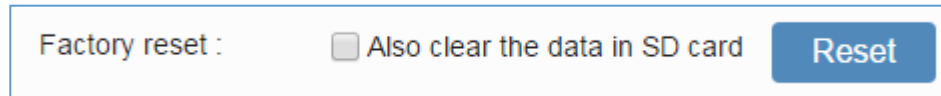

Figure 115: GVC3200/GVC3202 Web UI - Factory Reset

2. Click the "Reset" button to bring up the prompt box as shown below. Click "OK" to reboot the device, and restore factory settings.

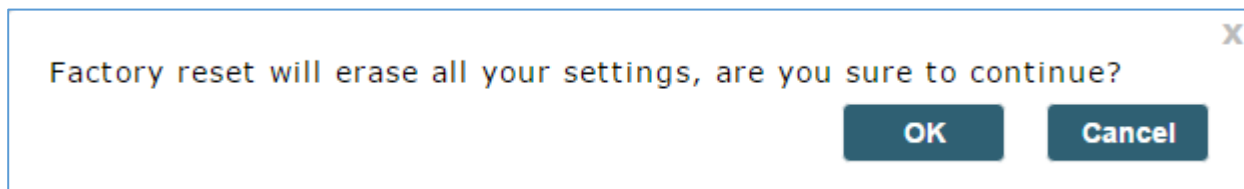

Figure 116: GVC3200/GVC3202 Web UI - Factory Reset Confirmation

Reset via Reset Hole

There is a Reset hole on the back panel of GVC3200/GVC3202, use a small pin to hold against the Reset hole for more than 10 seconds to restore factory settings.



EXPERIENCING GVC3200/GVC3202

Please visit our website: <http://www.grandstream.com> to receive the most up-to-date updates on firmware releases, additional features, FAQs, documentation and news on new products.

We encourage you to browse our product related documentation, FAQs and User and Developer Forum for answers to your general questions. If you have purchased our products through a Grandstream Certified Partner or Reseller, please contact them directly for immediate support.

Our technical support staff is trained and ready to answer all of your questions. Contact a technical support member or submit a trouble ticket online to receive in-depth support.

Thank you again for purchasing Grandstream Video Conferencing System, it will be sure to bring convenience and color to both your business and personal life.

* **Android is a trademark of Google Inc.**

* **Skype and Skype for Business are Registered Trademarks of Microsoft Corporation.**

HDMI™ HDMI, the HDMI Logo, and High-Definition Multimedia Interface are trademarks or registered trademarks of HDMI Licensing LLC in the United States and other countries.

