



Three-Input HD Video Scaler for HDMI and VGA Signals



AT-HD-SC-500

Atlona Manuals
Switchers

Version Information

Version	Release Date	Notes
6	04/17	New manual format
7	05/17	Added DispBtn command (only available when running firmware v1.3.30)

Welcome to Atlona!

Thank you for purchasing this Atlona product. We hope you enjoy it and will take a extra few moments to register your new purchase.

Registration only takes a few minutes and protects this product against theft or loss. In addition, you will receive notifications of product updates and firmware. Atlona product registration is voluntary and failure to register will not affect the product warranty.

To register your product, go to <http://www.atlona.com/registration>

Sales, Marketing, and Customer Support

Main Office

Atlona Incorporated
70 Daggett Drive
San Jose, CA 95134
United States

Office: +1.877.536.3976 (US Toll-free)
Office: +1.408.962.0515 (US/International)

Sales and Customer Service Hours
Monday - Friday: 6:00 a.m. - 4:30 p.m. (PST)

<http://www.atlona.com/>

International Headquarters

Atlona International AG
Ringstrasse 15a
8600 Dübendorf
Switzerland

Office: +41 43 508 4321

Sales and Customer Service Hours
Monday - Friday: 09:00 - 17:00 (UTC +1)

Operating Notes



IMPORTANT: Visit <http://www.atlona.com/product/AT-HD-SC-500> for the latest firmware updates and User Manual.

- The Atlona Management System (AMS) is a free downloadable application from Atlona that provides network configuration assistance for this product. This application is available only for the Windows® Operating System and can be downloaded from the Atlona web site.
- Consumer Electronics Control (CEC): Atlona has confirmed proper CEC functionality with several current models of Samsung, Panasonic, and Sony displays. However, it is not guaranteed that CEC will work with all displays. Many manufacturers do not support the CEC “off” command, and older displays use proprietary commands. Atlona only supports displays that use the CEC command structure defined in HDMI 1.2a. It is recommended that dealers request an evaluation product from Atlona, before designing a system using the CEC protocol. If this is not possible, then other control methods will need to be considered, in order to control displays using Atlona products.

Atlona, Inc. (“Atlona”) Limited Product Warranty

Coverage

Atlona warrants its products will substantially perform to their published specifications and will be free from defects in materials and workmanship under normal use, conditions and service.

Under its Limited Product Warranty, Atlona, at its sole discretion, will either:

- repair or facilitate the repair of defective products within a reasonable period of time, restore products to their proper operating condition and return defective products free of any charge for necessary parts, labor and shipping.

OR

- replace and return, free of charge, any defective products with direct replacement or with similar products deemed by Atlona to perform substantially the same function as the original products.

OR

- refund the pro-rated value based on the remaining term of the warranty period, not to exceed MSRP, in cases where products are beyond repair and/or no direct or substantially similar replacement products exist.

Repair, replacement or refund of Atlona products is the purchaser’s exclusive remedy and Atlona liability does not extend to any other damages, incidental, consequential or otherwise.

This Limited Product Warranty extends to the original end-user purchaser of Atlona products and is non-transferrable to any subsequent purchaser(s) or owner(s) of these products.

Coverage Periods

Atlona Limited Product Warranty Period begins on the date of purchase by the end-purchaser. The date contained on the end-purchaser’s sales or delivery receipt is the proof purchase date.

Limited Product Warranty Terms – New Products

- 10 years from proof of purchase date for hardware/electronics products purchased on or after June 1, 2013.
- 3 years from proof of purchase date for hardware/electronics products purchased before June 1, 2013.
- Lifetime Limited Product Warranty for all cable products.

Limited Product Warranty Terms – Refurbished (B-Stock) Products

- 3 years from proof of purchase date for all Refurbished (B-Stock) hardware and electronic products purchased on or after June 1, 2013.

Remedy

Atlona recommends that end-purchasers contact their authorized Atlona dealer or reseller from whom they purchased their products. Atlona can also be contacted directly. Visit www.atlona.com for Atlona’s contact information and hours of operation. Atlona requires that a dated sales or delivery receipt from an authorized dealer, reseller or end-purchaser is provided before Atlona extends its warranty services. Additionally, a return merchandise authorization (RMA) and/or case number, is required to be obtained from Atlona in advance of returns.

Atlona requires that products returned are properly packed, preferably in the original carton, for shipping. Cartons not bearing a return authorization or case number will be refused. Atlona, at its sole discretion, reserves the right to reject any products received without advanced authorization. Authorizations can be requested by calling 1-877-536-3976 (US toll free) or 1-408- 962-0515 (US/international) or via Atlona’s website at www.atlona.com.

Exclusions

This Limited Product Warranty excludes:

- Damage, deterioration or malfunction caused by any alteration, modification, improper use, neglect, improper packaging or shipping (such claims must be presented to the carrier), lightning, power surges, or other acts of nature.

- Damage, deterioration or malfunction resulting from the installation or removal of this product from any installation, any unauthorized tampering with this product, any repairs attempted by anyone unauthorized by Atlona to make such repairs, or any other cause which does not relate directly to a defect in materials and/or workmanship of this product.
- Equipment enclosures, cables, power supplies, batteries, LCD displays, and any accessories used in conjunction with the product(s).
- Products purchased from unauthorized distributors, dealers, resellers, auction websites and similar unauthorized channels of distribution.

Disclaimers

This Limited Product Warranty does not imply that the electronic components contained within Atlona's products will not become obsolete nor does it imply Atlona products or their electronic components will remain compatible with any other current product, technology or any future products or technologies in which Atlona's products may be used in conjunction with. Atlona, at its sole discretion, reserves the right not to extend its warranty offering in instances arising outside its normal course of business including, but not limited to, damage inflicted to its products from acts of god.

Limitation on Liability

The maximum liability of Atlona under this limited product warranty shall not exceed the original Atlona MSRP for its products. To the maximum extent permitted by law, Atlona is not responsible for the direct, special, incidental or consequential damages resulting from any breach of warranty or condition, or under any other legal theory. Some countries, districts or states do not allow the exclusion or limitation of relief, special, incidental, consequential or indirect damages, or the limitation of liability to specified amounts, so the above limitations or exclusions may not apply to you.

Exclusive Remedy

To the maximum extent permitted by law, this limited product warranty and the remedies set forth above are exclusive and in lieu of all other warranties, remedies and conditions, whether oral or written, express or implied. To the maximum extent permitted by law, Atlona specifically disclaims all implied warranties, including, without limitation, warranties of merchantability and fitness for a particular purpose. If Atlona cannot lawfully disclaim or exclude implied warranties under applicable law, then all implied warranties covering its products including warranties of merchantability and fitness for a particular purpose, shall provide to its products under applicable law. If any product to which this limited warranty applies is a "Consumer Product" under the Magnuson-Moss Warranty Act (15 U.S.C.A. §2301, ET SEQ.) or other applicable law, the foregoing disclaimer of implied warranties shall not apply, and all implied warranties on its products, including warranties of merchantability and fitness for the particular purpose, shall apply as provided under applicable law.

Other Conditions

Atlona's Limited Product Warranty offering gives legal rights, and other rights may apply and vary from country to country or state to state. This limited warranty is void if (i) the label bearing the serial number of products have been removed or defaced, (ii) products are not purchased from an authorized Atlona dealer or reseller. A comprehensive list of Atlona's authorized distributors, dealers and resellers can be found at www.atlona.com.

Important Safety Information

CAUTION
RISK OF ELECTRIC SHOCK
DO NOT OPEN

CAUTION: TO REDUCT THE RISK OF ELECTRIC SHOCK DO NOT OPEN ENCLOSURE OR EXPOSE TO RAIN OR MOISTURE. NO USER-SERVICEABLE PARTS INSIDE REFER SERVICING TO QUALIFIED SERVICE PERSONNEL.



The exclamation point within an equilateral triangle is intended to alert the user to the presence of important operating and maintenance instructions in the literature accompanying the product.



The information bubble is intended to alert the user to helpful or optional operational instructions in the literature accompanying the product.

1. Read these instructions.
2. Keep these instructions.
3. Heed all warnings.
4. Follow all instructions.
5. Do not use this product near water.
6. Clean only with a dry cloth.
7. Do not block any ventilation openings. Install in accordance with the manufacturer's instructions.
8. Do not install or place this product near any heat sources such as radiators, heat registers, stoves, or other apparatus (including amplifiers) that produce heat.
9. Do not defeat the safety purpose of a polarized or grounding-type plug. A polarized plug has two blades with one wider than the other. A grounding type plug has two blades and a third grounding prong. The wide blade or the third prong are provided for your safety. If the provided plug does not fit into your outlet, consult an electrician for replacement of the obsolete outlet.
10. Protect the power cord from being walked on or pinched particularly at plugs, convenience receptacles, and the point where they exit from the product.
11. Only use attachments/accessories specified by Atlona.
12. To reduce the risk of electric shock and/or damage to this product, never handle or touch this unit or power cord if your hands are wet or damp. Do not expose this product to rain or moisture.
13. Unplug this product during lightning storms or when unused for long periods of time.
14. Refer all servicing to qualified service personnel. Servicing is required when the product has been damaged in any way, such as power-supply cord or plug is damaged, liquid has been spilled or objects have fallen into the product, the product has been exposed to rain or moisture, does not operate normally, or has been dropped.



FCC Statement

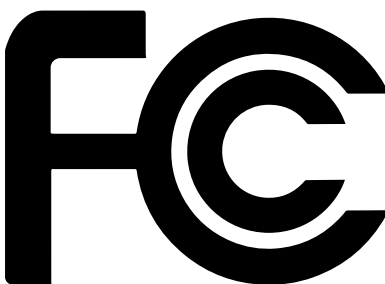

FCC Compliance and Advisory Statement: This hardware device complies with Part 15 of the FCC rules. Operation is subject to the following two conditions: 1) this device may not cause harmful interference, and 2) this device must accept any interference received including interference that may cause undesired operation. This equipment has been tested and found to comply with the limits for a Class A digital device, pursuant to Part 15 of the FCC Rules. These limits are designed to provide reasonable protection against harmful interference in a commercial installation.

This equipment generates, uses, and can radiate radio frequency energy and, if not installed or used in accordance with the instructions, may cause harmful interference to radio communications. However there is no guarantee that interference will not occur in a particular installation. If this equipment does cause harmful interference to radio or television reception, which can be determined by turning the equipment off and on, the user is encouraged to try to correct the interference by one or more of the following measures: 1) reorient or relocate the receiving antenna; 2) increase the separation between the equipment and the receiver; 3) connect the equipment to an outlet on a circuit different from that to which the receiver is connected; 4) consult the dealer or an experienced radio/TV technician for help. Any changes or modifications not expressly approved by the party responsible for compliance could void the user's authority to operate the equipment. Where shielded interface cables have been provided with the product or specified additional components or accessories elsewhere defined to be used with the installation of the product, they must be used in order to ensure compliance with FCC regulations.

Table of Contents

Introduction	9
Features	9
Package Contents	9
Panel Description	10
Installation	11
RS-232	11
Power	11
Audio	12
Connection Instructions	12
Connection Diagram	13
IP Configuration	14
Using the Front Panel	14
Using Commands	14
Using the Web GUI	15
Basic Operation	16
Selecting the Input	16
Adjusting the Output Volume	16
Auto Switching	17
Passing Analog Audio	17
Menu System	19
Accessing the On-Screen Display	19
Input Select	20
Input Resolution	20
Output Resolution	21
Picture Adjust	21
Aspect	22
Overscan	23
Audio	23
OSD	25
Control Settings	26
Others	28
Information	30
Web GUI	31
Introduction to the Web GUI	31
Logging In	31
Menus	32
Toggles	33
Sliders	33
Buttons	34
Getting Information on the Switcher	34
Video Menu	35
Input	35
Output	36
Audio Menu	37
Picture Menu	38
EDID Menu	39
Display Menu	40
CEC	40
System Settings	41
TCP/IP Settings of Controlled Devices	42
RS-232 / IP Commands	43
RS-232 Menu	44

Table of Contents

OSD Menu	45
Config Menu	46
Network Menu	47
Commands	49
Appendix	81
Updating the Firmware	81
Using the Web GUI	81
Using USB	82
Mounting Instructions	84
Default Settings	85
Specifications	87
Index	89

Introduction

The dual HDMI and VGA switcher w/scaler provides a multisystem solution. Use the HD-SC-500 as: a standalone 3 in 1 out switcher for small systems, an analog to digital video converter for systems with no VGA ports, and a scaler for systems with displays that require specific resolutions. Supports scaling of video up to 1920x1200/1080p, VGA conversion and audio embedding and de-embedding, the HD-SC-500 has a function in almost any system.

Features

- Scales incoming signals up to 1920x1200
- Three input, one output switcher
- Auto-switching (activated through RS-232 or webGUI)
- HDMI inputs support DVI and DisplayPort signals (with adaptors)
- Audio input for embedding audio onto video signals
- Control of brightness, contrast, saturation, hue, and sharpness
- Volume control
- Adjust treble and bass of audio output to ensure the best speaker performance
- Balanced, analog audio output for de-embedding audio to amplifiers or audio systems
- Control via RS-232, TCP/IP, webGUI, and OSD
- Ability to switch HDCP reporting between compliant and non-compliant
- Firmware upgradable for easy field service through USB or web GUI

Package Contents

- 1 x AT-HD-SC-500
- 1 x Phoenix terminal block, 5-pin (captive screw)
- 1 x Phoenix terminal block, 3-pin (captive screw)
- 1 x Phoenix terminal block, 2-pin (captive screw)
- 1 x 5V DC power supply
- 1 x Wall/table mount ears
- 1 x Installation Guide

Panel Description

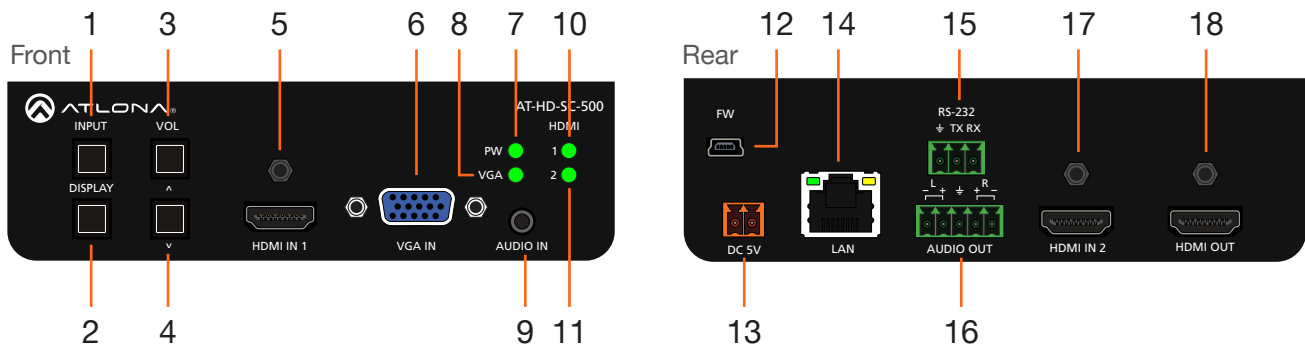

1 INPUT

Press this button to select the desired input.

2 DISPLAY

Press this button to show the On-Screen Display (OSD) and select items within the OSD.

3 VOL / UP CURSOR

Press this button to adjust the volume on the connected display and to select items within the OSD.

4 DOWN CURSOR

Press this button to scroll down within the OSD.

5 HDMI IN 1

Connect an HDMI cable from this port to an HD source.

6 VGA IN

Connect a VGA cable from this port to a VGA source.

7 PW

This LED indicator will glow bright green when the switcher is powered.

8 VGA

This LED indicator will glow bright green when the VGA IN port is selected.

9 AUDIO IN

Connect a 3.5mm mini-stereo audio cable, from an analog audio source, to this port.

10 HDMI 1

This LED indicator will glow bright green when the HDMI 1 port is selected.

11 HDMI 2

This LED indicator will glow bright green when the HDMI 2 port is selected.

12 FW

Connect a mini USB to USB-A type cable from this port to a computer to update the firmware. See [Updating the Firmware \(page 81\)](#) for more information.

13 DC 5V

Connect the included 2-pin Phoenix block from this connector to the 5V DC power supply.

14 LAN

Connect an Ethernet cable from this port to a Local Area Network (LAN).

15 RS-232

Connect the included 3-pin Phoenix block from this connector to an RS-232 device.

16 AUDIO OUT

Connect the included 5-pin Phoenix block from this connector to an audio amplifier.

17 HDMI IN 2

Connect an HD source to this port.

18 HDMI OUT

Connect an HDMI cable from this port to a display (sink) device.

Installation

RS-232

The AT-HD-SC-500 provides RS-232 control between an automation system and an RS-232 device. This step is optional.

1. Use wire strippers to remove a portion of the cable jacket.
2. Remove at least 3/16" (5 mm) from the insulation of the RX, TX, and GND wires.
3. Insert the TX, RX, and GND wires into correct terminal on the included Phoenix block. If using non-tinned stranded wire, press the orange tab, above the terminal, while inserting the exposed wire. Repeat this step for the TX, RX, and GND connections.

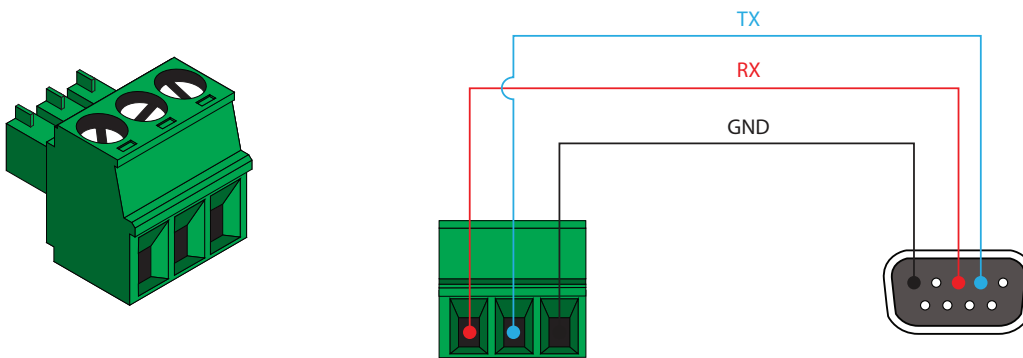

Power

Locate the included orange Phoenix terminal block and wire the included power supply to the block, as shown below. Do not use high-torque devices, when securing the wires to the Phoenix terminal block, as this may damage the screws and/or block.

1. Insert the wires into the correct terminal on the included Phoenix block, as shown below.
2. Tighten the screws to secure the wires. Do not use high-torque devices as this may damage the screws and/or connector block.

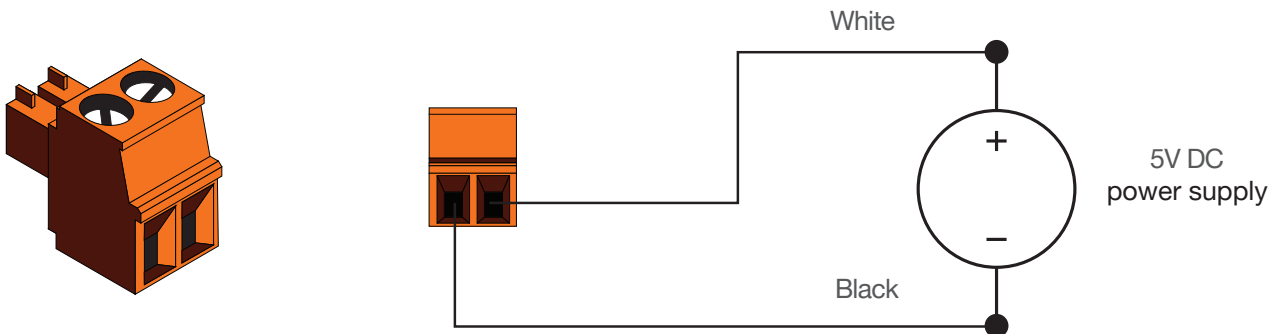

Audio

The **AUDIO OUT** connector on the AT-HD-SC-500 provides the connection of either balanced or unbalanced audio outputs using XLR connectors. Use the included 5-pin Phoenix terminal block.

Balanced audio connections use two signal wires and a ground to minimize interference in audio signals. Unbalanced audio connections use one signal wire and a ground and are used if system components don't support balanced signals.

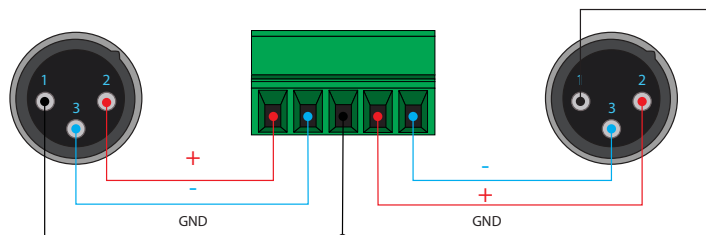
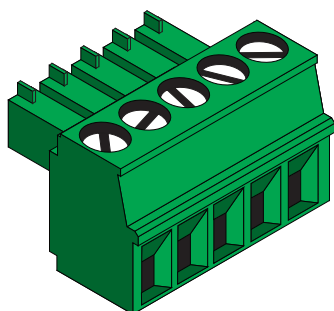

Balanced

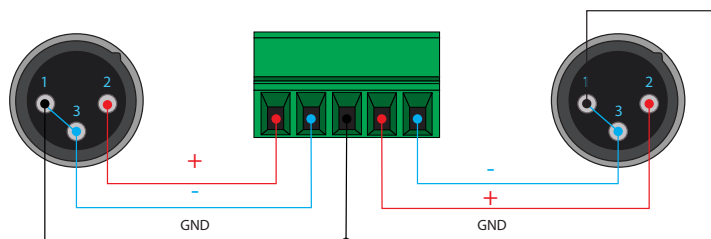

Unbalanced

Connection Instructions

1. Connect an HDMI cable between the HD source and the **HDMI IN 1** port on the switcher.
2. Connect another HDMI cable between another HD source and the **HDMI IN 2** port on the switcher.
3. Connect a VGA cable from a VGA source to the **VGA IN** port on the switcher.
4. Connect a 3.5 mm mini-stereo cable from the **AUDIO IN** port on the switcher to the analog audio source. This port allows two-channel analog audio to be included when the **VGA IN** port is selected. See [Passing Analog Audio \(page 17\)](#) for more information.
5. Connect an Ethernet cable, up to 330 feet (100 meters), from the **LAN** port on the switcher to a Local Area Network (LAN).



IMPORTANT: If EZ RJ-45 connectors are being used to terminate Ethernet cable, make sure that each twisted pair does not extend beyond the RJ-45 connector. Exposed twisted-pair wires may cause a short when connected to the **LAN** port.

6. Connect an HDMI cable from the **HDMI OUT** port on the switcher to an HD display.
7. OPTIONAL: Connect an RS-232 device, such as a projector, to the **RS-232** port on the switcher.
8. OPTIONAL: Connect an audio amplifier, or other audio output device, to the **AUDIO OUT** port on the switcher.
9. Connect the included 5V DC power supply to the **DC 5V** port.
10. Connect the power supply to an available AC outlet.

Connection Diagram

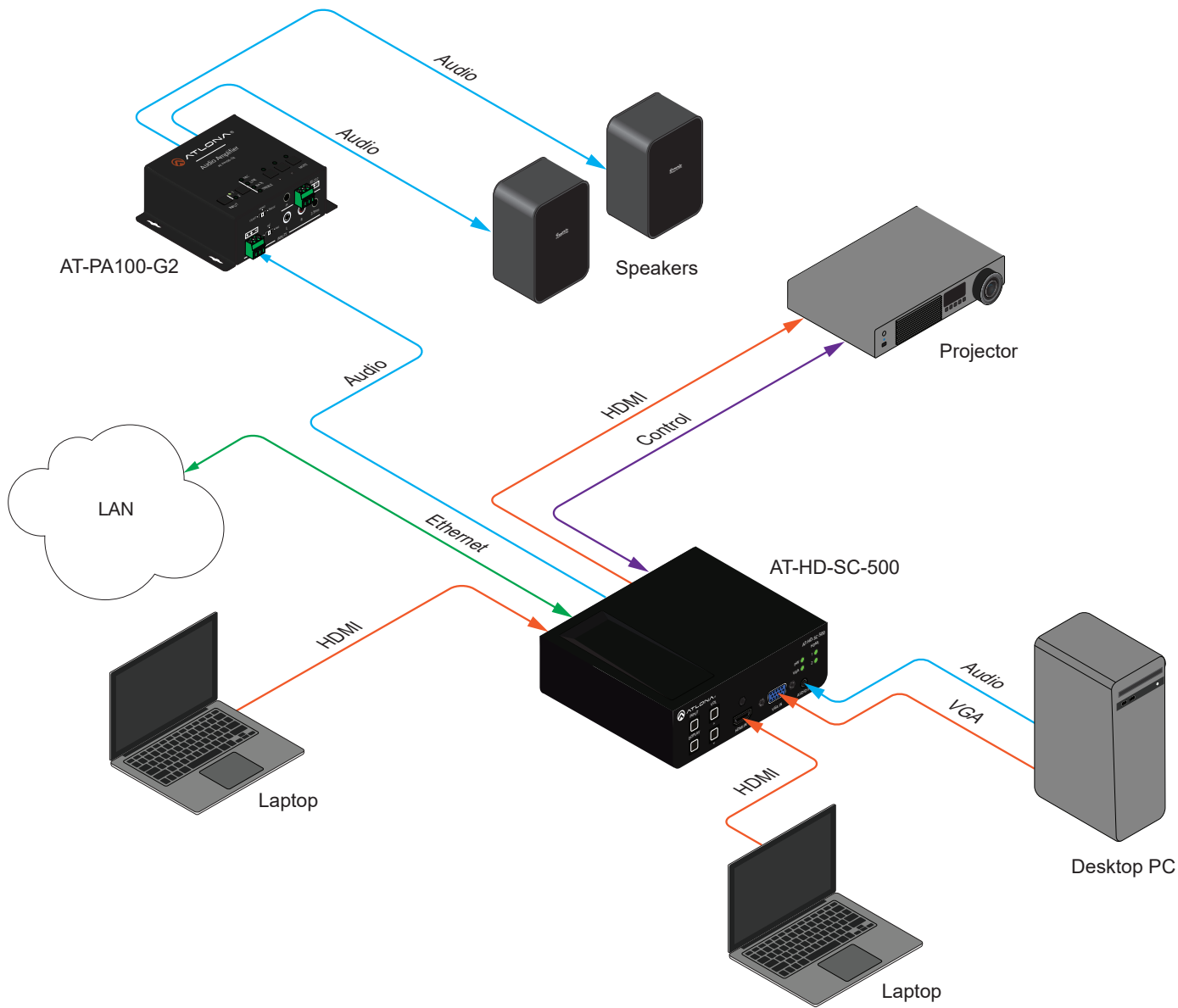

IP Configuration

The AT-HD-SC-500 is shipped with DHCP enabled. Once connected to a network, the DHCP server (if available), will automatically assign an IP address to the unit. Use an IP scanner, along with the MAC address on the bottom of the unit, to identify both the unit and its IP address on the network. If a static IP address is desired, the unit can be switched to static IP mode. Use one of the following procedures to switch between DHCP and static IP mode. The default static IP address of the AT-HD-SC-500 is 192.168.1.254.

Using the Front Panel

1. Make sure the AT-HD-SC-500 is powered.
2. Press and hold the **INPUT** button for approximately 15 seconds.



DISPLAY button

3. Release the **INPUT** button once the **DISPLAY** button begins to flash. The number of flashes will indicate the currently selected IP mode.

PW LED flashes	Description
Two	Static IP mode
Four	DHCP mode

Using Commands

Use the **IPStatic** and **IPDHCP** commands to switch between DHCP and IP mode through RS-232 or Telnet. Refer to [Commands \(page 49\)](#), for more information. All commands and their arguments are case-sensitive.

- **Setting static IP mode**

1. Connect to the AT-HD-SC-500 using RS-232 or Telnet.
2. At the command line, execute the **IPDHCP** command using the off argument, as shown.

```
IPDHCP off
```

3. Execute the **IPStatic** command. This command requires three arguments: the desired IP address of the AT-HD-SC-500, the subnet mask, and the gateway address. All arguments must be entered in dot-decimal notation. The following is an example:

```
IPStatic 192.168.1.112 255.255.255.0 192.168.1.1
```

- **Setting DHCP mode**

1. Connect to the AT-HD-SC-500 using RS-232 or Telnet.
2. At the command line, execute the **IPDHCP** command using the on argument, as shown. All characters are case-sensitive.

```
IPDHCP on
```

Once DHCP is enabled, the unit will be assigned an IP address by the DHCP server (if present).

Using the Web GUI

The **Network Menu** (page 47) in the web GUI, allows the AT-HD-SC-500 to use either DHCP or static IP mode. In order to access the web GUI, the IP address of the AT-HD-SC-500 must be known.

1. Open the desired web browser and enter the IP address of the AT-HD-SC-500.
2. Log in, using the required credentials. The factory-default username and password are listed below:

Username: root

Password: Atlona

3. Click the **Network** tab.

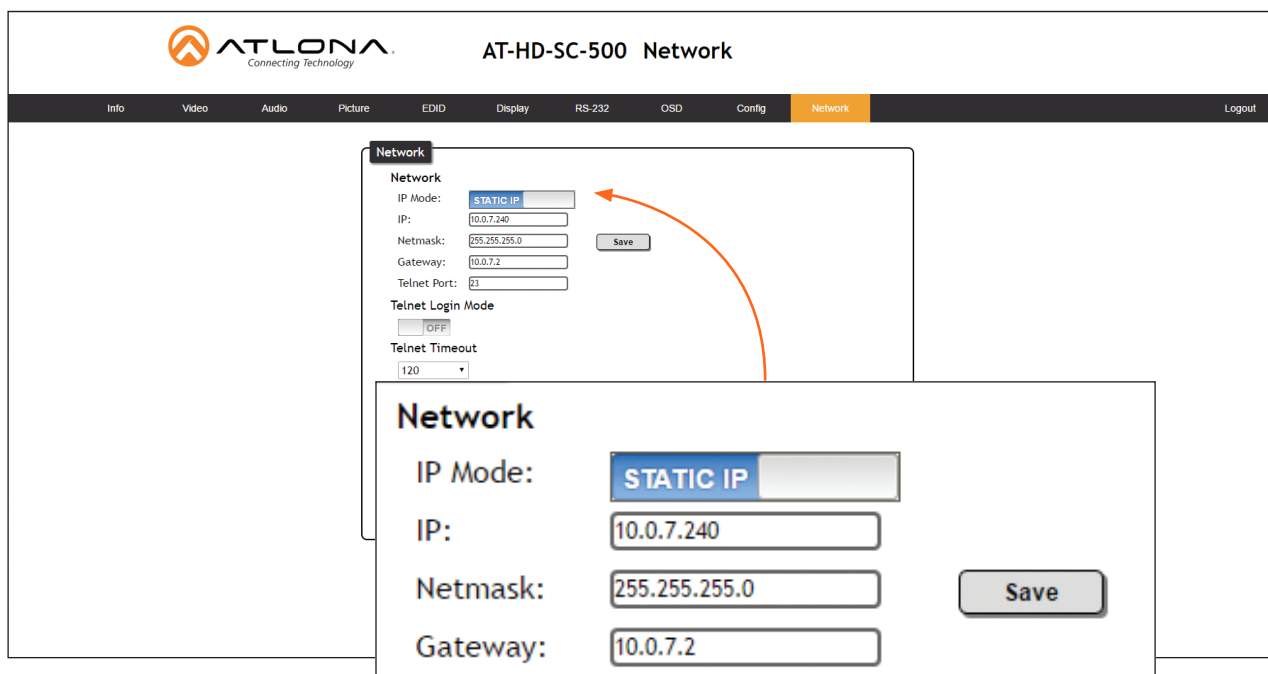

4. Click the **IP Mode** toggle to switch between the **DHCP** and **STATIC IP** setting.
When set to **STATIC IP**, the **IP**, **Netmask**, and **Gateway** fields can be modified.
5. Click the **Save** button to save the changes.

Basic Operation

Selecting the Input

Press the **INPUT** button to cycle through each of the available inputs on the unit. The unit will always retain the last selected input when the unit is powered-off.

1. Below, the **HDMI 1** LED indicator is bright green, indicating that **HDMI IN 1** is the active input. This is the default port selection of the AT-HD-SC-500.



2. Press the **INPUT** button, to select **HDMI IN 2**. The **HDMI 2** LED indicator will turn bright green.



3. Press the **INPUT** button a third time, to select the **VGA IN** port. The **VGA** LED indicator will turn bright green.
4. Press the **INPUT** button again to return to **HDMI IN 1**.

Adjusting the Output Volume

Press the **VOL UP / DN** buttons on the front panel of the AT-HD-SC-500 to control the output volume of the display device. Output volume is displayed in decibels, and can be set from -32 dB to 0 dB.

Press the **VOL UP** button to increase the volume; press the **VOL DN** button to decrease the volume. Press and hold these buttons to quickly scroll through the values.

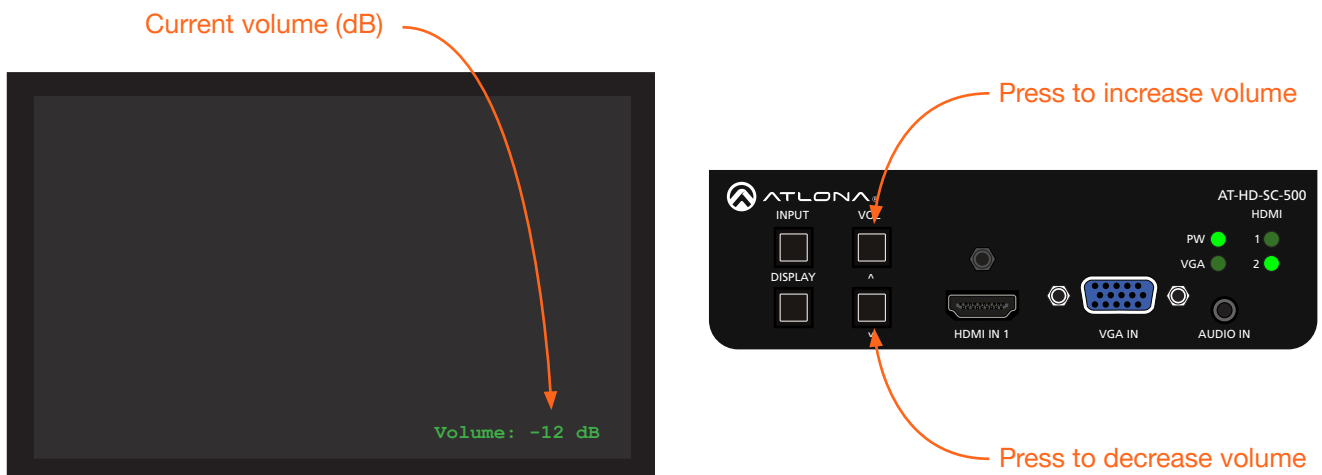

Volume control can also be managed over RS-232 or IP and can be configured using any of the following methods:

- On-Screen Display (OSD). Refer to the [Control Settings \(page 26\)](#) menu for more information.
- Web GUI. Refer to [RS-232 Menu \(page 44\)](#) for more information.

Auto Switching

Both products have auto-switching capability. The unit will automatically switch to the most recently-connected or powered source when a source is disconnected. For example, if the connection sequence is **HDMI 2 > HDMI 1 > VGA**, then disconnecting the source from **HDMI 1** will result in the product automatically switching to the **VGA** port.

Auto-switching can be enabled or disabled using any one of the following methods:

- On-Screen Display (OSD). Refer to the [Others \(page 28\)](#) menu for more information.
- Web GUI. Refer to [Introduction to the Web GUI \(page 31\)](#) for more information.
- RS-232 / IP commands. Refer to [Commands \(page 49\)](#) for more information.

Passing Analog Audio

The AT-HD-SC-500 can pass two-channel analog audio, by itself, or with a VGA signal. The signal is embedded on the HDMI output.

1. Connect a 3.5 mm mini-stereo cable from the **AUDIO IN** port to the analog audio source.
2. OPTIONAL: Connect a VGA source to the **VGA IN** port.
3. Press the **INPUT** button until the **VGA** indicator turns bright green. This input must be selected in order to use the **AUDIO IN** port.

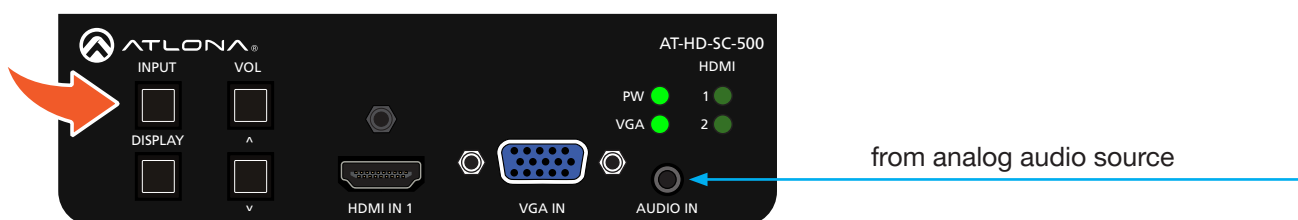

NOTE: The analog audio input will not replace existing embedded HDMI audio. Audio is heard only if the HDMI source has no audio. DVI to HDMI adapters can also be used when connecting DVI sources to one of the HDMI inputs, allowing the analog audio to be audible on the output.

The example, below, shows a desktop PC providing both the audio and video source. However, these signals may be connected to separate sources. The dotted line indicates that the video source is optional.

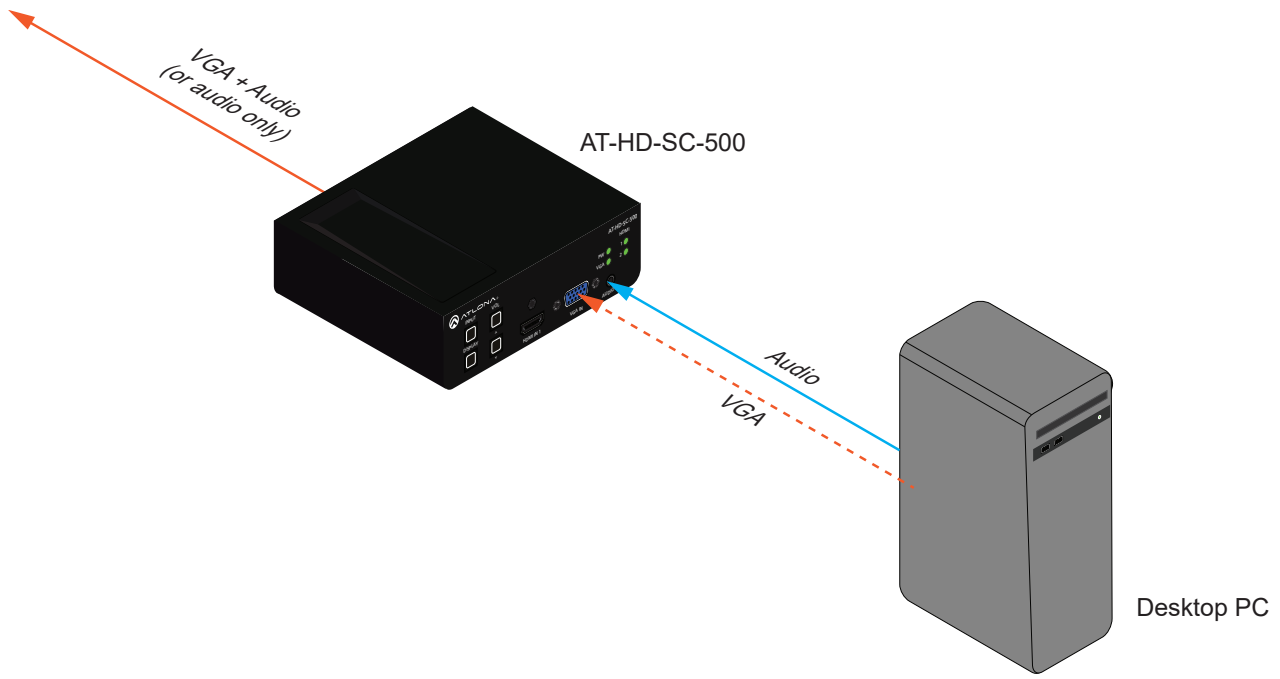

Menu System

Accessing the On-Screen Display

The AT-HD-SC-500 includes a built-in On-Screen Display (OSD) menu system to manage and control all video features.

1. Press and hold the **DISPLAY** button, until the OSD is shown.

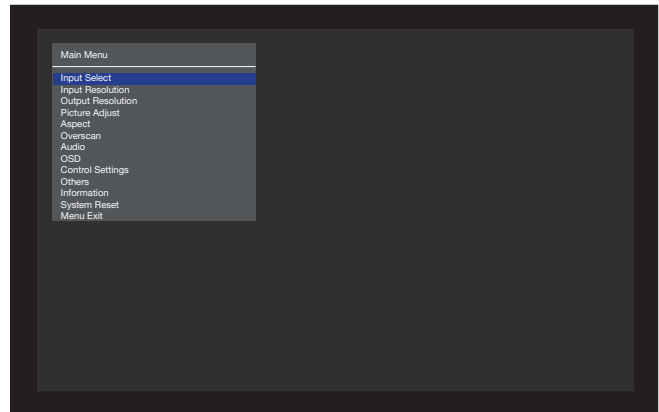

2. Release the **DISPLAY** button.

3. Press the **VOL UP / VOL DN** buttons to highlight the various menu options. The currently selected menu item will be highlighted with a blue cursor bar. Press the **VOL UP** button to move the cursor up through the menu system and press the **VOL DN** button to move down.

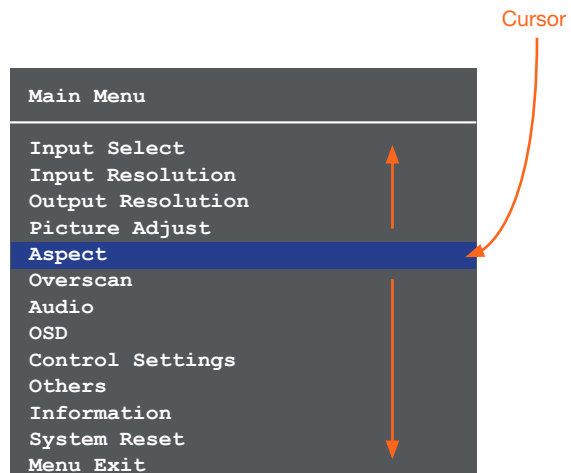
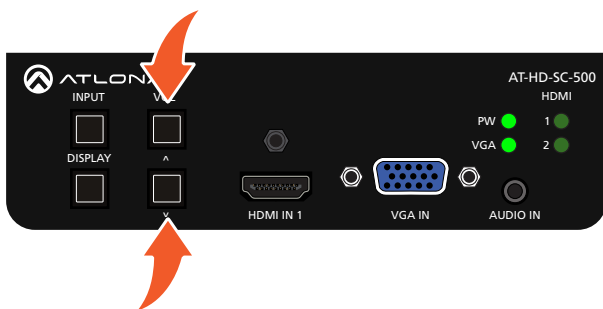

4. Once the desired menu item is highlighted, press the **DISPLAY** button to access its settings.

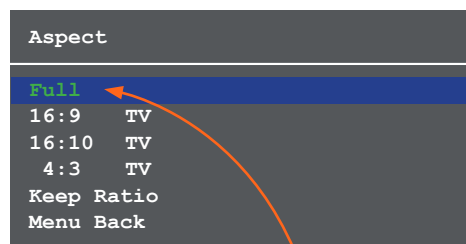
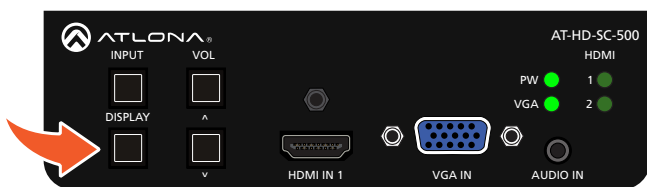

Within the menu item, the current setting will always be highlighted in green.

In this illustration, the Aspect menu item indicates that **Full** is the currently selected aspect ratio setting. Refer to [Aspect \(page 22\)](#) for more information.

Current setting

Input Select

Selects the desired input. This can also be done using the INPUT button on the front panel. Refer to [Selecting the Input \(page 16\)](#) for more information.

1. Under the **Main Menu**, highlight the **Input Select** menu item using the **VOL UP/DN** buttons on the front panel.
2. Press the **DISPLAY** button.
3. The **Input Select** menu will be displayed.
4. Press the **VOL UP/DN** buttons to highlight the desired input.

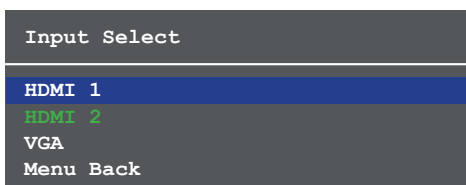

5. Press the **DISPLAY** button to confirm the selection.
6. Press the **Menu Back** option to return to the **Main Menu**.

Input Resolution

Selects the desired input resolution.

1. Under the **Main Menu**, highlight the **Input Select** menu item using the **VOL UP/DN** buttons on the front panel.
2. Press the **DISPLAY** button.
3. The **Input Resolution** menu will be displayed.
4. Press the **VOL UP/DN** buttons to highlight the desired input.
5. Press the **DISPLAY** button to confirm the selection and display the list of available input resolutions.

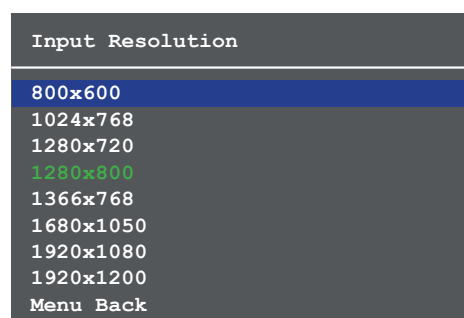
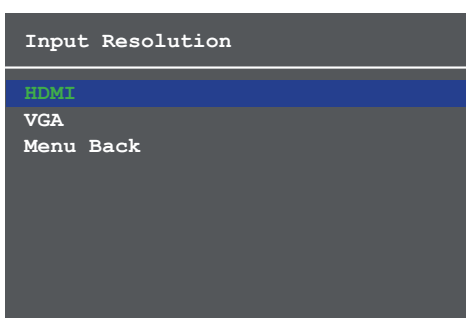

6. Press the **VOL UP/DN** buttons to select the desired resolution.
7. Press the **DISPLAY** button to confirm the selection.
8. Press the **Menu Back** option to return to the **Main Menu**.

Output Resolution

Selects the desired output resolution. The default output resolution is 720p (1280x720). The Output Resolution menu consists of three pages.

1. Under the **Main Menu**, highlight the **Output Resolution** menu item using the **VOL UP/DN** buttons on the front panel.
2. Press the **DISPLAY** button.
3. The **Output Resolution** menu will be displayed.
4. Press the **VOL UP/DN** buttons to highlight the desired resolution.

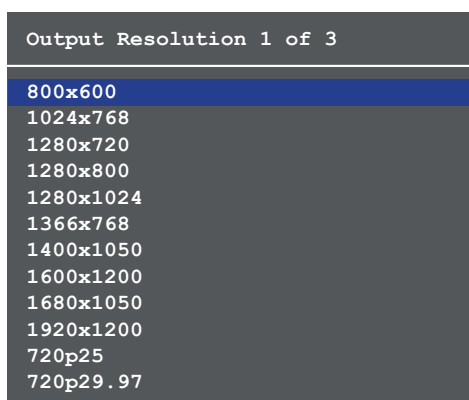

5. Press the **DISPLAY** button to confirm the selection.
6. Select the **Menu Back** option, under **Output Resolution 3 of 3**, then press the **DISPLAY** button, to return to the **Main Menu**.

Picture Adjust

Provides custom adjustment of picture brightness, contrast, saturation, hue, and color space.

1. Under the **Main Menu**, highlight the **Output Resolution** menu item using the **VOL UP/DN** buttons on the front panel.
2. Press the **DISPLAY** button.
3. The **Picture Adjust** menu will be displayed.
4. Press the **VOL UP/DN** buttons to highlight the desired option.

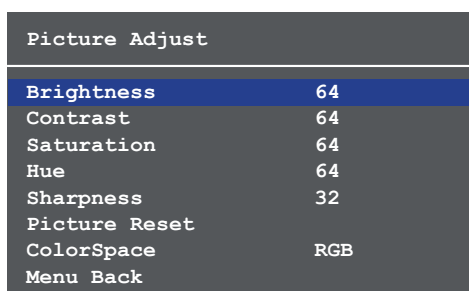

5. Press the **DISPLAY** button to confirm the selection.
6. The current value will be highlighted in green and surrounded by brackets and two arrowheads.

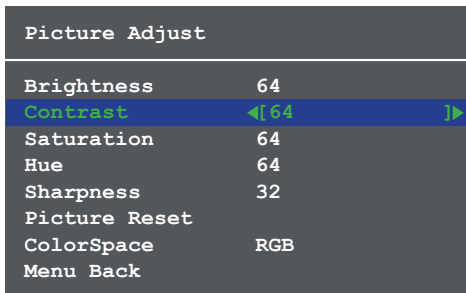

8. Press the **VOL UP/DN** buttons to select the desired value. Press the **VOL UP** button to increase the value; press **VOL DN** to decrease the value.
9. Press the **DISPLAY** button to confirm the new value.
10. Select the **Menu Back** option, then press the **DISPLAY** button, to return to the **Main Menu**.

Aspect

Allows the aspect ratio of the output image to be changed.

1. Under the **Main Menu**, highlight the **Output Resolution** menu item using the **VOL UP/DN** buttons on the front panel.
2. Press the **DISPLAY** button.
3. The **Aspect** menu will be displayed.
4. Press the **VOL UP/DN** buttons to highlight the desired aspect ratio.

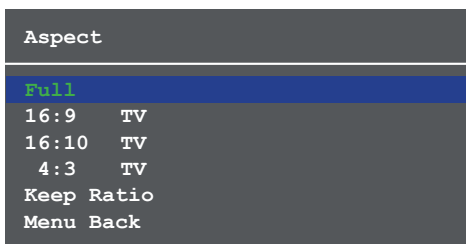

Setting	Description
Full	The output signal will be scaled to fill the screen.
16:9 TV	The output signal will be scaled to fit as 16:9.
16:10 TV	The output signal will be scaled to fit as 16:10.
4:3 TV	Output signal will be set to 4:3. If the input is HD, approximately 35% of the total horizontal resolution will be lost.
Keep Ratio	The input aspect ratio is preserved on the output.

5. Press the **DISPLAY** button to confirm the selection.
6. Select the **Menu Back** option, then press the **DISPLAY** button, to return to the **Main Menu**.

Overscan

Adjusts the overscan setting of the output video signal. By default, overscan is *disabled*.

1. Under the **Main Menu**, highlight the **Overscan** menu item using the **VOL UP/DN** buttons on the front panel.
2. Press the **DISPLAY** button.
3. The **Overscan** menu will be displayed.
4. Press the **VOL UP/DN** buttons to highlight the **Enable** option.
5. Press the **DISPLAY** button to change the **Enable** value

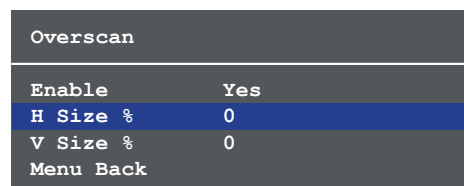
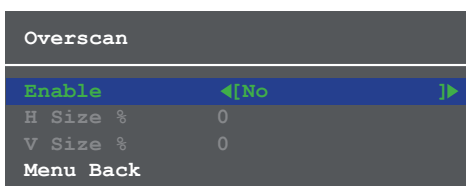

6. When overscan is *enabled*, the **H Size %** and **V Size %** fields can be adjusted. Press the **VOL UP/DN** buttons to highlight the desired field.
7. Press the **DISPLAY** button to select the field.
8. Press the **VOL UP/DN** buttons to change the value. Press the **VOL UP** button to *increase* the value; press the **VOL DN** button to *decrease* the value.
9. Press the **DISPLAY** button to confirm the change.
10. Highlight the **Menu Back** option, then press the **DISPLAY** button to return to the **Main Menu**.

Audio

The Audio menu allows adjustment of all audio settings.

1. Under the **Main Menu**, highlight the **Audio** menu item using the **VOL UP/DN** buttons on the front panel.
2. Press the **DISPLAY** button.
3. The **Audio** menu will be displayed.

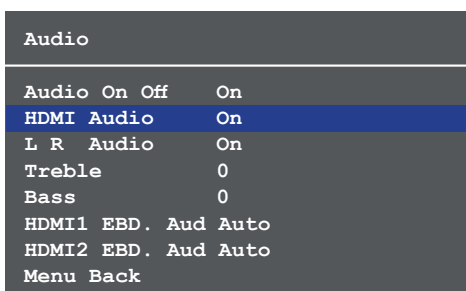

4. Press the **VOL UP/DN** buttons to highlight the desired option.
5. Press the **DISPLAY** button to confirm the selection.
6. The current value will be highlighted in green and surrounded by brackets and two arrowheads.

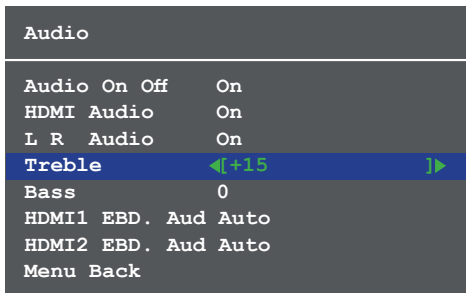

Setting	Description
Audio On Off	Provides muting of both HDMI and analog audio outputs. Set this value to Off to mute all audio.
HDMI Audio	Controls the HDMI audio, only. Set to Off to mute the HDMI audio.
L R Audio	Toggles the analog audio output On or Off. Set to Off to mute the analog audio output.
Treble	Sets the amount of treble on the audio output. Range is -12 to 15.
Bass	Sets the amount of bass on the audio output. Range is -12 to 15.
HDMI1 EBD. Aud	Selects the audio source to be embedded on HDMI 1. <ul style="list-style-type: none"> • Auto - Automatically uses the analog audio input when using DVI sources. When set to Auto, and an HDMI signal is used, the output audio will be from the HDMI input signal. • Digital - Uses audio from HDMI 1. • Analog - Forces the analog audio input to be used and embeds it on the HDMI output.
HDMI2 EBD. Aud	Selects the audio source to be embedded on HDMI 2. <ul style="list-style-type: none"> • Auto - Automatically uses the analog audio input when using DVI sources. If an HDMI signal is used, when set to Auto, the output audio will be from the HDMI input signal. • Digital - Uses audio from HDMI 2. • Analog - Forces the analog audio input to be used and embeds it on the HDMI output.

7. Press the **VOL UP/DN** buttons to select the desired value. Press the **VOL UP** button to increase the value; press **VOL DN** to decrease the value.
8. Press the **DISPLAY** button to confirm the value.
9. Highlight the **Menu Back** option, then press the **DISPLAY** button to return to the **Main Menu**.

OSD

Adjusts the appearance and position of the On-Screen Display (OSD) on the screen.

1. Under the **Main Menu**, highlight the **Audio** menu item using the **VOL UP/DN** buttons on the front panel.
2. Press the **DISPLAY** button.
3. The **OSD** menu will be displayed.
4. Press the **VOL UP/DN** buttons to highlight the desired option.

OSD	
Position	Left Top
Transparency	12
Info. Timer	10
Menu Timer	20
Info. Display	Auto
Background	Grey
Menu Back	

Setting	Description
Position	Sets the position of the OSD on the display. The following options are available: <ul style="list-style-type: none"> • Left Top • Right Top • Right Bottom • Left Bottom • Center
Transparency	Adjusts the transparency setting of the OSD. <ul style="list-style-type: none"> • Range: 5 to 100
Info. Timer	The duration, in seconds, of how long the Display Info screen is displayed. <ul style="list-style-type: none"> • Range: 5 to 100
Menu Timer	The duration, in seconds, of how long the OSD remains on the screen, after no activity. <ul style="list-style-type: none"> • Range: 5 to 100
Info. Display	Adjusts the display settings of the Info Display screen, which indicates the input and output resolution. Refer to the next page for an example of the Info Display screen. The following options are available: <ul style="list-style-type: none"> • Auto - Automatically displays the Info Display screen when a change is made to the input or output signal. The screen will automatically be hidden after approximately five seconds. • Off - Prevents the Info Display screen from being displayed. • On - The Info Display screen is always displayed.
Background	Sets the background color of the OSD. The following options are available: <ul style="list-style-type: none"> • Grey • Cyan • Magenta • Yellow

5. Press the **DISPLAY** button to confirm the selection.
6. The current value will be highlighted in green and surrounded by brackets and two arrowheads.
7. Press the **VOL UP/DN** buttons to change the value. For settings that contain a value, press the **VOL UP** button to *increase* the value; press the **VOL DN** button to *decrease* the value.

OSD	
Position	Left Top
Transparency	◀[12]▶
Info. Timer	10
Menu Timer	20
Info. Display	Auto
Background	Grey
Menu Back	

Info Display screen

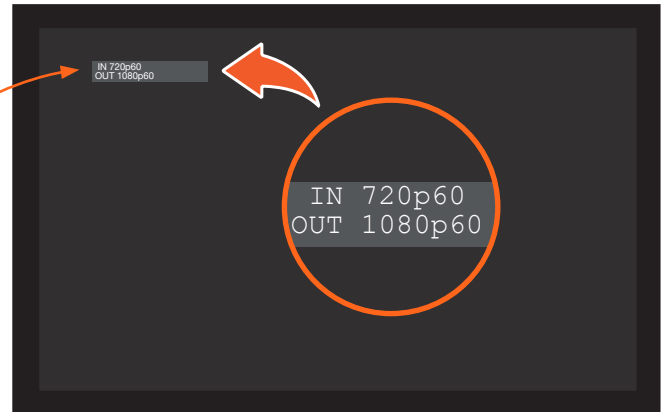

8. Press the **DISPLAY** button to confirm the change.
9. Highlight the **Menu Back** option, then press the **DISPLAY** button to return to the **Main Menu**.

Control Settings

Adjusts the control settings.

1. Under the **Main Menu**, highlight the **Control Settings** menu item using the **VOL UP/DN** buttons on the front panel.
2. Press the **DISPLAY** button.
3. The **Control Settings** menu will be displayed.
4. Press the **VOL UP/DN** buttons to highlight the desired option.

Control Settings	
CEC	On
BTN Vol. Sel	Audio Out
Auto Disp. On	Off
Auto Disp. Off	Off
Disp. Key Lock	Off
Cool Down Tmr	0
Auto Power Off	15
Warm Up Timer	0
Control Type	RS-232
Feedback Vrfy.	Off
Menu Back	

Setting	Description
CEC*	<p>Enables or disables Consumer Electronics Control (CEC) command transmission to the display (sink) device.</p> <ul style="list-style-type: none"> • On - Allows CEC commands to be transmitted over the HDMI cable to the connected display (sink) device. • Off - Prevents transmission of CEC commands.

* *Consumer Electronics Control (CEC): Atlona has confirmed proper CEC functionality with several current models of Samsung, Panasonic, and Sony displays. However, it is not guaranteed that CEC will work with all displays. Many manufacturers do not support the CEC “off” command, and older displays use proprietary commands. Atlona only supports displays that use the CEC command structure defined in HDMI 1.2a. It is recommended that dealers request an evaluation product from Atlona, before designing a system using the CEC protocol. If this is not possible, then other control methods will need to be considered, in order to control displays using Atlona products.*

Setting	Description
BTN Vol. Sel	<p>Sets the delivery method used by the VOL UP / DN buttons.</p> <ul style="list-style-type: none"> • Audio Out - Directly controls the output volume on the connected display (sink) device. • RS-232 - Volume commands are sent over RS-232, to the connected display. • IP - Volume commands are sent over IP, to the connected display.
Auto Disp. On	<p>Sends the command to power-on the display when an A/V signal is detected. The following options are available:</p> <ul style="list-style-type: none"> • On - Enables the feature. • Off - Disables the feature.
Auto Disp. Off	<p>Sends the command to power-off the display when an A/V signal is no longer present. The following options are available:</p> <ul style="list-style-type: none"> • On - Enables the feature. • Off - Disables the feature.
Disp. Key Lock	<p>Allows the DISPLAY button to be locked, preventing accidental operation when the product is in use. Define the time interval using the Warm Up Timer option, below. The following options are available:</p> <ul style="list-style-type: none"> • On - Enables the feature. • Off - Disables the feature.
Cool Down Tmr	<p>Sets the cool-down interval, in seconds, before the projector can be powered-off. During this time interval, the projector will not accept any commands until the “power off” command has been processed, requiring the projector lamp to complete the cool-down process.</p> <ul style="list-style-type: none"> • Range: 0 to 300
Auto Power Off	<p>Sets the time interval, in seconds, between when the loss of A/V signal is detected and when the “Display Off” command is sent.</p> <ul style="list-style-type: none"> • Range: 0 to 240
Warm Up Timer	<p>Sets the time interval, in seconds, between when the display is powered-on and when the DISPLAY button, on the front panel, will be locked.</p> <ul style="list-style-type: none"> • Range: 0 to 300

Setting	Description
Control Type	Sets the control method for sending commands. The following options are available: <ul style="list-style-type: none"> • RS-232 • IP • CEC
Feedback Vrfy.	Sets the feedback verification state. The following options are available: <ul style="list-style-type: none"> • On - The AT-HD-SC-500 will make four attempts to send the command. If the feedback string is not acknowledged after the fourth attempt, the process will fail. Execute the SetCmdFB (page 72) command to set the feedback string. • Off - Sends the command and ignores the feedback string.

5. Press the **DISPLAY** button to confirm the selection.
6. The current value will be highlighted in green and surrounded by brackets and two arrowheads.
7. Press the **VOL UP/DN** buttons to change the value.
8. Press the **DISPLAY** button to confirm the change.
9. Highlight the **Menu Back** option, then press the **DISPLAY** button to return to the **Main Menu**.

Others

This menu provides control for various other settings, such as auto-switching, HDCP, and vertical mirroring.

1. Under the **Main Menu**, highlight the **Others** menu item using the **VOL UP/DN** buttons on the front panel.
2. Press the **DISPLAY** button.
3. The **Others** menu will be displayed.
4. Press the **VOL UP/DN** buttons to highlight the desired option.

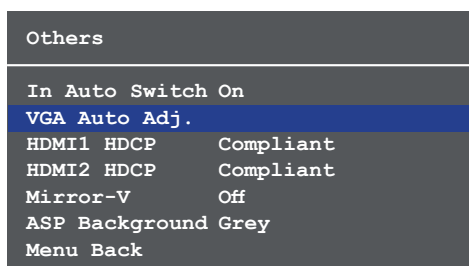

Others	
In Auto Switch On	
VGA Auto Adj.	
HDMI1 HDCP	Compliant
HDMI2 HDCP	Compliant
Mirror-V	Off
ASP Background Grey	
Menu Back	

Setting	Description
In Auto Switch	Enables or disables auto-switching. The following options are available: <ul style="list-style-type: none"> • On - Enables auto-switching. • Off - Disables auto-switching.

Setting	Description
VGA Auto Adj.	Centers the VGA signal by automatically. This feature is only available when a VGA source is connected to the switcher.
HDMI1 HDCP	<p>Provides control over the transmission of HDCP content for HDMI 1. The following options are available:</p> <ul style="list-style-type: none"> • Compliant - Forces detection of HDCP-compliant sink devices. If the sink device is not HDCP-compliant, then no content will be transmitted. • Noncompliant - Suppresses detection of HDCP-compliant sink devices, allowing non-HDCP content to be transmitted. • Auto - Automatically detects the presence of HDCP-compliant sink devices. If an HDCP-compliant display is detected, then HDCP content will be sent. Otherwise, non-HDCP content will be sent. <p>NOTE: Some source devices will enable HDCP if an HDCP-compliant display (sink) is detected. However, there may be applications where sending HDCP content is not desired. This feature does not provide decryption of HDCP content to non-HDCP sink devices</p>
HDMI2 HDCP	<p>Provides control over the transmission of HDCP content for HDMI 2. Refer to note, on the previous page. The following options are available:</p> <ul style="list-style-type: none"> • Compliant - Forces detection of HDCP-compliant sink devices. If the sink device is not HDCP-compliant, then no content will be transmitted. • Noncompliant - Suppresses detection of HDCP-compliant sink devices, allowing non-HDCP content to be transmitted. • Auto - Automatically detects the presence of HDCP-compliant sink devices.
Mirror-V	<p>Vertically flips the output signal. The default setting is Off. The following options are available:</p> <ul style="list-style-type: none"> • On - Vertically flips the output image. • Off - The output image is unaltered.
ASP Background	<p>Changes the color of background bars when changing the aspect ratio of the output image. The default color is Black. The following options are available:</p> <ul style="list-style-type: none"> • Black • Grey

5. Press the **DISPLAY** button to confirm the selection.
6. The current value will be highlighted in green and surrounded by brackets and two arrowheads.
7. Press the **VOL UP/DN** buttons to change the value.
8. Press the **DISPLAY** button to confirm the change.
9. Highlight the **Menu Back** option, then press the **DISPLAY** button to return to the **Main Menu**.

Information

The Information displays current information about the AT-HD-SC-500. None of the fields within the **Information** menu can be edited.

1. Under the **Main Menu**, highlight the **Information** menu item using the **VOL UP/DN** buttons on the front panel.
2. Press the **DISPLAY** button.
3. The **Information** menu will be displayed.

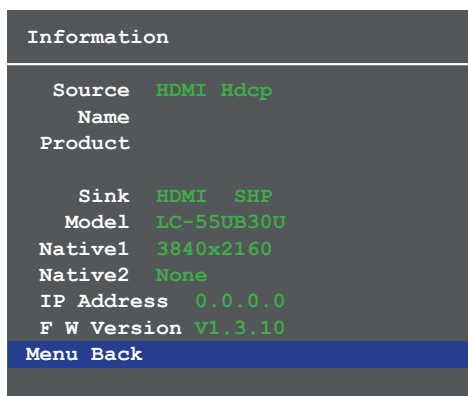

Setting	Description
Source	The current input source that is displayed. The source will be displayed as HDMI or VGA. If HDCP content is transmitted (HDMI only), then “Hdcp” will be displayed.
Name	The name of the source, if available.
Product	The product name, if available.
Sink	Contains the manufacturer’s abbreviation of the sink.
Model	Displays the model of the display.
Native1	The native (preferred) timing for the display.
Native2	Displays any detailed (alternate) timing for the display.
IP Address	IP address of the display.
F W Version	Current version of firmware running on the switcher.

4. The Menu Back option will already be selected.
5. Press the **DISPLAY** button to return to the **Main Menu**.

Web GUI

Introduction to the Web GUI

The AT-HD-SC-500 includes a built-in web GUI. Atlona recommends that the web GUI be used to control the AT-HD-SC-500, as it provides intuitive management of all features.

The AT-HD-SC-500 is shipped with DHCP enabled. Once connected to a network, the DHCP server will automatically assign an IP address to the unit. If a DHCP server is not available or if a static IP address is desired, it can be assigned using the [IPStatic \(page 66\)](#) command or through the [Network Menu \(page 47\)](#) in the web GUI. The default IP address of the AT-HD-SC-500 is 192.168.1.254.

Logging In

1. Launch a web browser.
2. In the address bar, type the IP address of the AT-HD-SC-500.
3. The **Login** page will be displayed.

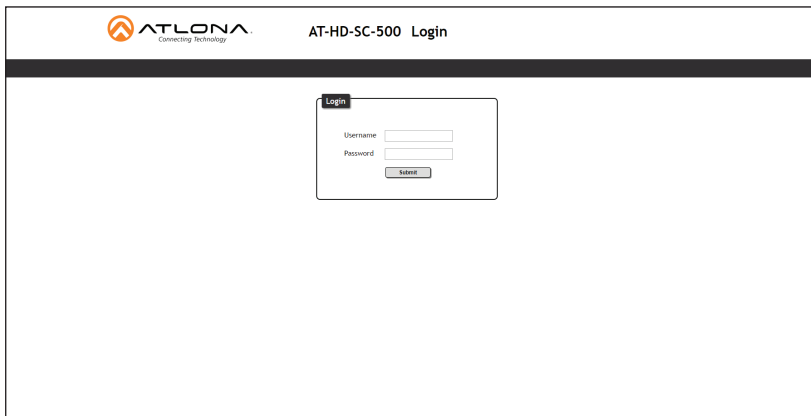

4. Type `root`, using all lower-case characters, in the **Username** field. The username cannot be altered.
5. Type `Atlona` in the **Password** field. The password field is case-sensitive. When the password is entered, it will be masked. The password can be changed through the [Config Menu \(page 46\)](#) of the web GUI.
6. Click the **Submit** button or press the ENTER key on the keyboard.

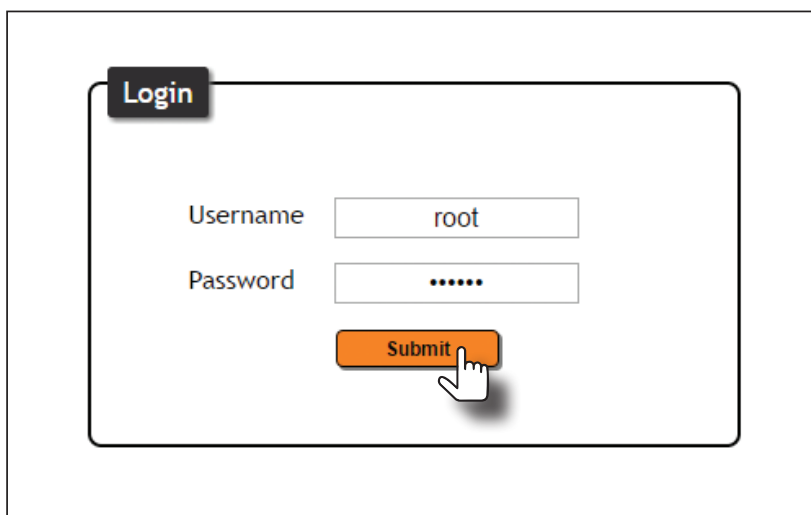

7. The **Info** page will be displayed.



Menus

The dark-colored bar, near the top of the screen, is the menu bar. When the mouse is moved over each menu element, it will be highlighted in light orange. Once the desired menu element is highlighted, click the left mouse button to access the settings within the menu.

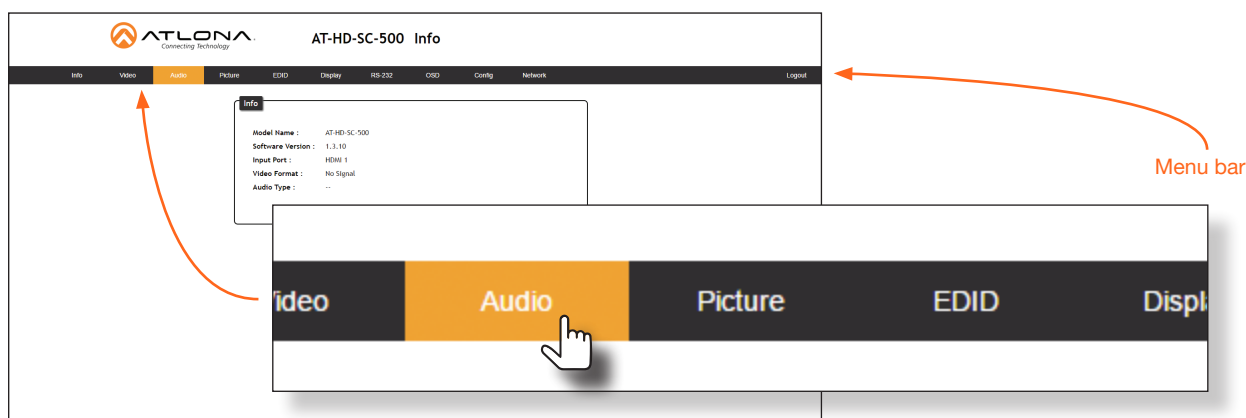

In this example, clicking **Audio**, in the menu bar, will display the **Audio** page.

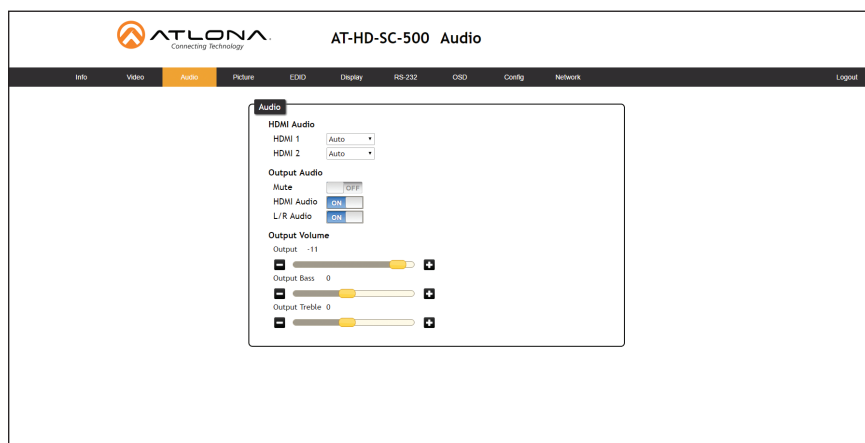

Toggles

Several settings within the Web GUI use *toggles*, which enable, disable, or assign one of two settings. In most cases, when the *toggle* is blue, this means the feature is enabled. In addition, the *toggle* will be set to the ON or ENABLED position. If a feature is disabled, then the *toggle* will appear gray and be labeled as OFF or DISABLED.



Toggles are also used to enable or access another set of controls within the Web GUI. For example, the **Enable toggle**, for the **Overscan** setting, must be set to the ON position in order for the *slider* controls to be adjusted.

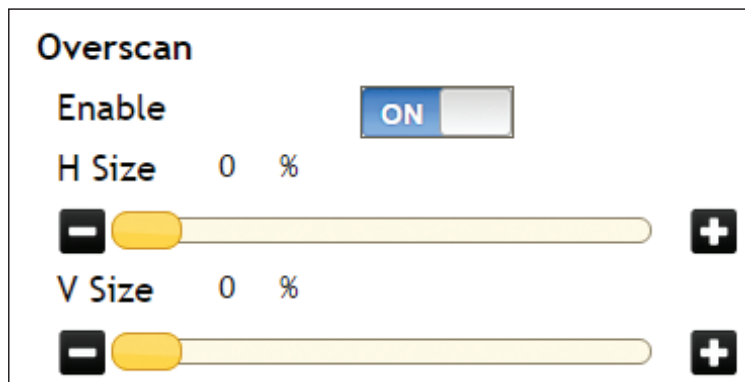

In some cases, the *toggle* will allow switching between two settings, such as the **IP Mode** setting, under the **Network** menu. This *toggle* sets the AT-HD-SC-500 to either static or DHCP mode. Refer to [Network Menu \(page 47\)](#) for more information on this feature.



Sliders

Click and drag slider controls to change their value.

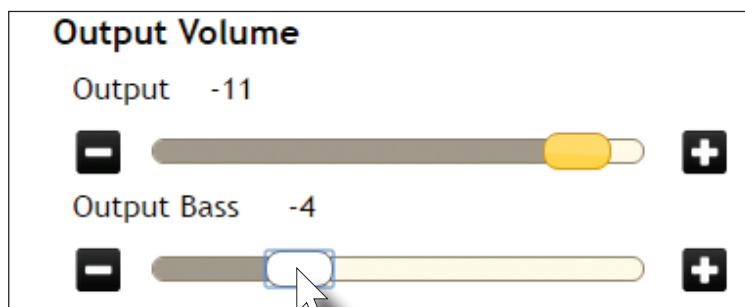

Buttons

Buttons are used to execute an action or setting. Several pages within the Web GUI include a **Save** button. Clicking the **Save** button will apply and save all settings in the current page. Other buttons, such as the **Power** command for **CEC** (found under the **Display** page), will send the power-on or power-off command to the display.



Getting Information on the Switcher

After logging in, the Info page will be displayed. The **Info** page displays the model and firmware version of the switcher. In addition, the active input, video format, and audio type are also reported. No fields can be edited on this page. To access this page from any menu, click **Info** in the menu bar.

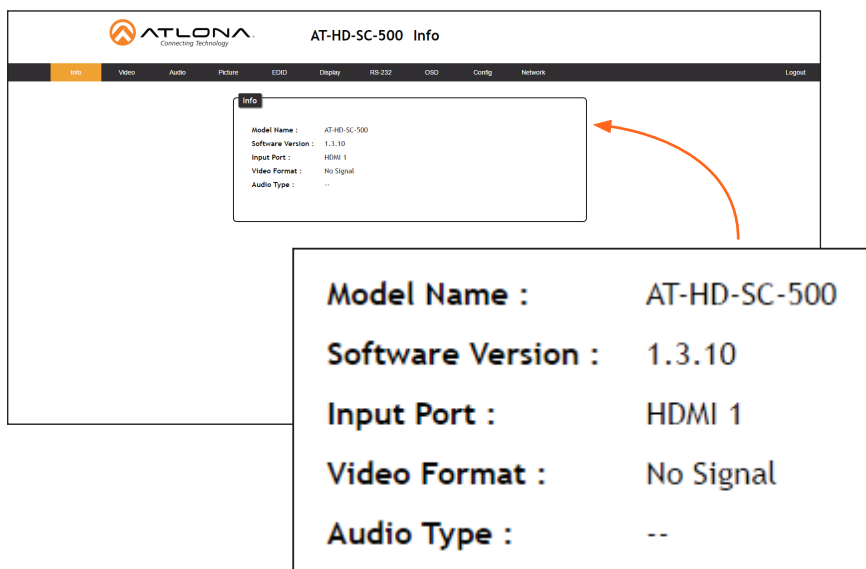

Setting	Description
Model Name	The model name of this switcher.
Software Version	The version of firmware that the AT-HD-SC-500 is running. Always make sure to check the AT-HD-SC-500 product page, on the Atlona web site, for the latest version of firmware.
Input Port	The active input port on the switcher.
Video Format	The video format of the input signal. If no input signal is detected, then No Signal will appear in this field.
Audio Type	The audio format of the input signal. If no audio is available, this field will display two dash symbols, as shown above.

Video Menu

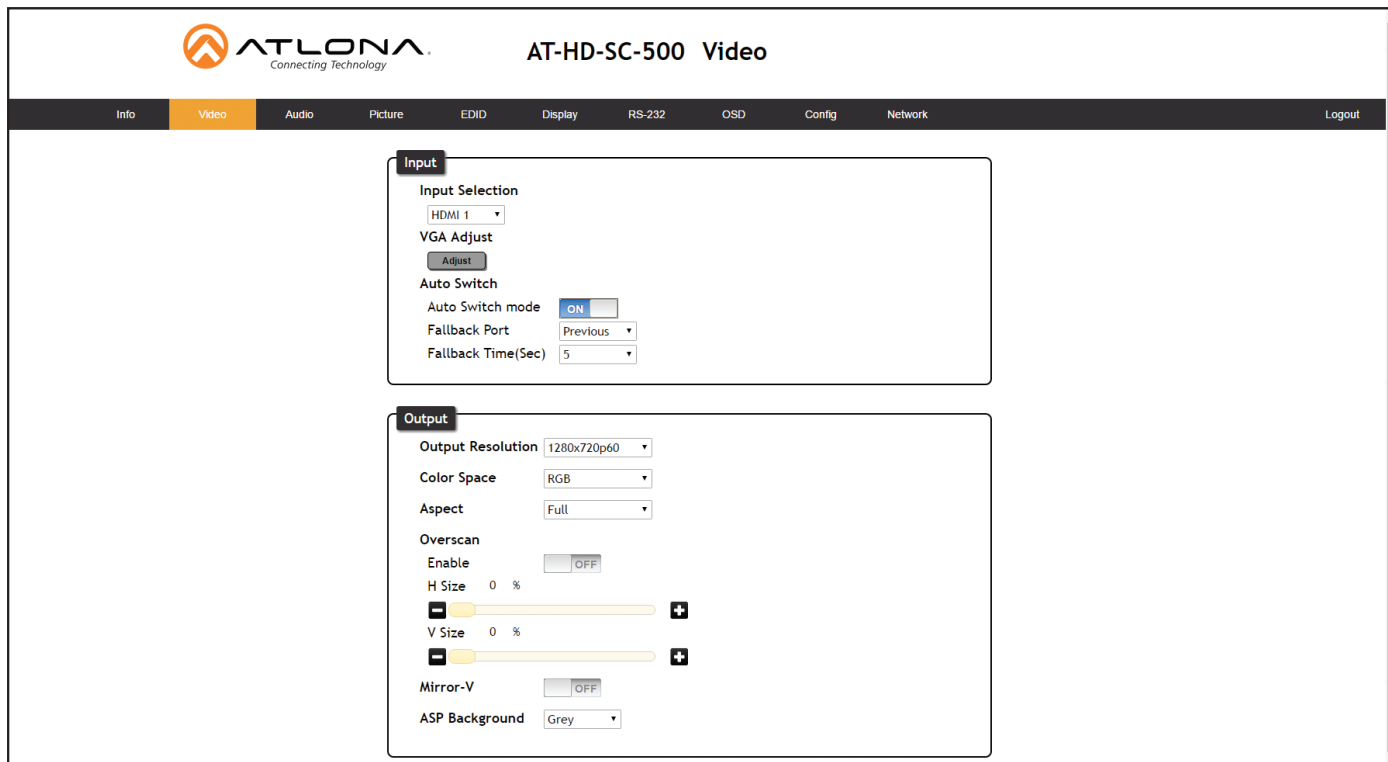

Input

Input Selection

Click this drop-down list to select the desired input.

VGA Adjust

In most situations, adjustment of the VGA signal should not necessary. However, if the VGA signal does not appear correctly, click the **Adjust** button to automatically correct the clock and phase.

Auto Switch

Three controls are available under the Auto Switch feature.

- Click the Auto Switch mode toggle to enable or disable auto-switching.
- Click the **Fallback Port** drop-down list to select the fallback port. If the source is disconnected from the active port, then the switcher can be configured to automatically switch to the desired port. Click the Auto Switch mode toggle to enable or disable auto-switching.

Setting	Description
HDMI 1	Automatically switches to HDMI 1.
HDMI 2	Automatically switches to HDMI 2.
VGA	Automatically switches to VGA.
Previous	The switcher will return to the previous (last connected) input. If no input is found, then it will attempt to switch to a ternary port.

- Click the **Fallback Time (Sec)** drop-down list and select the time interval before the switcher attempts to search for the next port. Range: 3 to 600.

Output

Output Resolution

Click the **Output Resolution** drop-down list and select the desired resolution. The default resolution is 720p.

Output Resolutions			
800x600p60	1600x1200p60	1280x720p59	1920x1080p25
1024x768p60	1680x1050p60	1280x720p60	1920x1080p29
1280x800p60	1920x1200pRB	1920x1080i50	1920x1080p30
1280x1024p60	1280x720p25	1920x1080i59	1920x1080p50
1366x768p60	1280x720p29	1920x1080i60	1920x1080p59
1400x1050p60	1280x720p30	1920x1080p23	1920x1080p60
1600x900p60	1280x720p50	1920x1080p24	NATIVE

Color Space

Click the **Color Space** drop-down list and select the desired color space.

Aspect

Click the **Aspect** drop-down list and select the desired aspect ratio.

Aspect Ratio	Description
Full	The input signal is adjusted to fill the screen.
16:9	Set the aspect ratio to 16:9; common aspect ratio for HD and widescreen formats; also notated as 1:77.1
16:10	Set the aspect ratio to 16:10; typical aspect ratio for computer and tablet displays.
4:3	Sets the aspect ratio to 4:3; if the input signal is 16:9 or 16:10, up to 30% of the vertical resolution is lost.
Keep Ratio	The output aspect ratio is the same as the input.

Overscan

Adjust the overscan of the output signal. Before the overscan can be adjusted, click the **Enable** toggle to the ON setting. Click and drag the *slider* controls to adjust the horizontal and vertical size. The **Enable** toggle must remain in the ON position, in order for the overscan to be applied. To disable overscan, click the **Enable** toggle to the OFF position.

Mirror-V

Click the **Mirror-V** toggle to the ON setting. Enabling this feature applies a vertical transformation (rotated 180° about the x-axis) to the output signal.

ASP Background

Click this drop-down list to select the color of the bars that appear when viewing an image in “letterbox” format.

Audio Menu

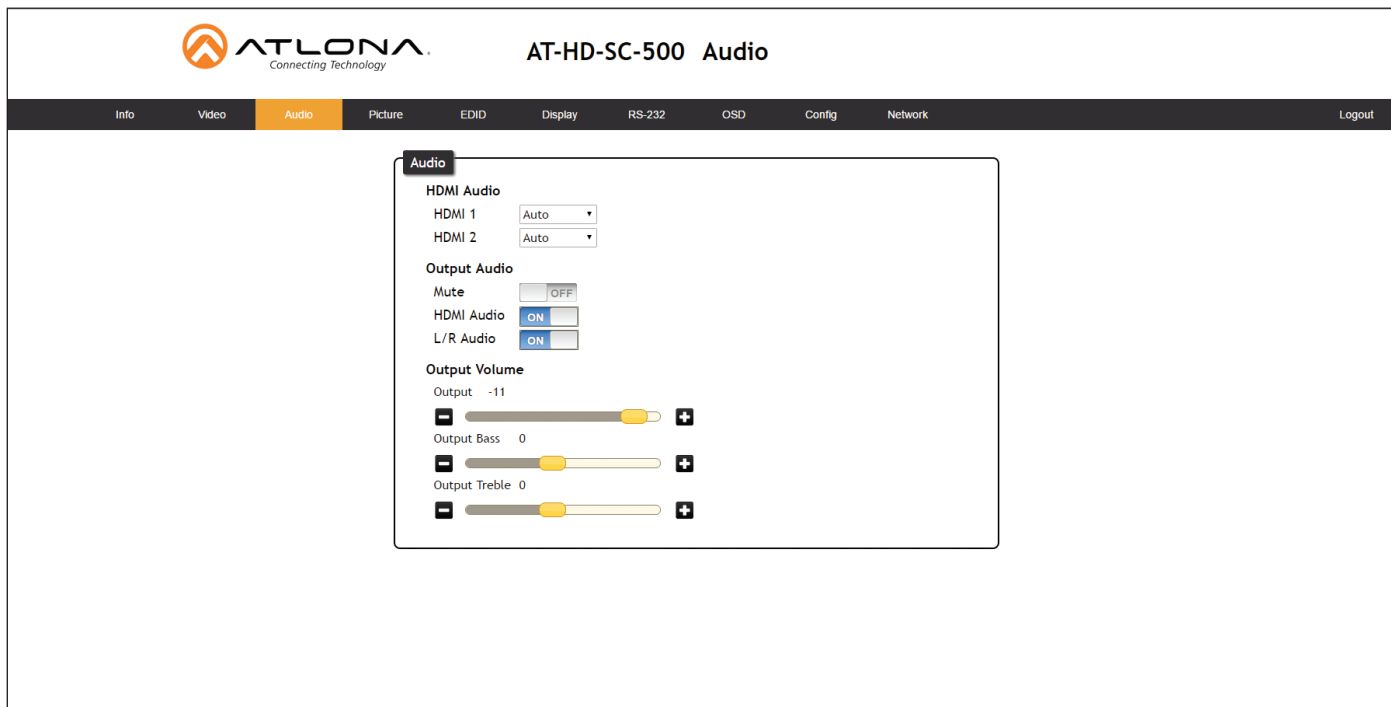

HDMI Audio

Click the drop-down list for HDMI 1 and HDMI 2 to select the input audio source used by each HDMI input.

Setting	Description
Auto	Automatically detects the audio source. If an HDMI cable with embedded audio is connected, the system will use the digital audio on the HDMI cable. If a cable, which does not support audio (such as a DVI cable) is connected to the HDMI port, then the analog audio from the AUDIO IN port will be used.
Digital	The HDMI audio will be used as the source.
Analog	The analog source, connected to the AUDIO IN port, will be used.

Mute

Click this toggle to the **OFF** position to mute all audio on the output.

HDMI Audio

Click this toggle to the **OFF** position to mute only the HDMI audio.

L/R Audio

Click this toggle to the **OFF** position to mute all audio on the output.

Volume

Click and drag this slider bar to adjust the audio volume. Range: -80 to 6.

Output Bass

Click and drag this slider bar to adjust the bass of the audio output. Range: -15 to 15.

Output Treble

Click and drag this slider bar to adjust the treble of the audio output. Range: -15 to 15.

Picture Menu

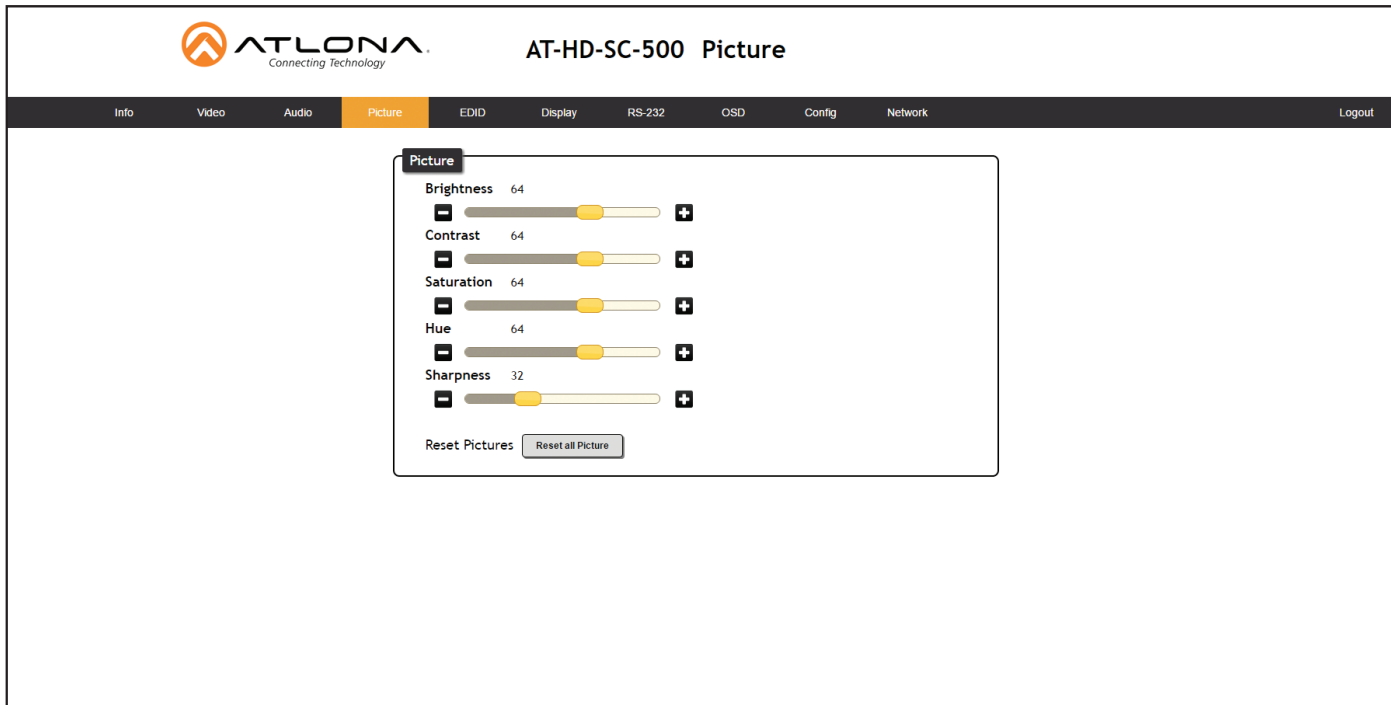

Brightness

Adjusts the brightness setting of the output signal. Range: 0 - 128

Contrast

Adjusts the contrast setting of the output signal. Contrast is the difference between the lightest and darkest area of an image. Range: 0 - 128

Saturation

Adjusts the color saturation of the output signal. Range: 0 - 128

Hue

Adjusts the hue of the output signal. Range: 0 - 128

Sharpness

Adjusts the sharpness of the output signal. Range: 0 - 128

Reset all Picture

Click this button to reset the above picture settings to their factory-default settings.

EDID Menu

AT-HD-SC-500 EDID

Info
Video
Audio
EDID
Display
RS-232
OSD
Config
Network
Logout

EDID

HDMI Prefer Timing 1280x800

VGA Prefer Timing 1280x800

HDMI1 HDCP compliant

HDMI2 HDCP compliant

HDMI Perfer Timing

Sets the preferred timing for the HDMI input.

VGA Prefer Timing

Sets the preferred timing for the VGA input.

HDMI1 HDCP

Provides control over the transmission of HDCP content for HDMI 1. The following options are available:

- **Compliant** - Forces detection of HDCP-compliant sink devices. If the sink device is not HDCP-compliant, then no content will be transmitted.
- **Noncompliant** - Suppresses detection of HDCP-compliant sink devices, allowing non-HDCP content to be transmitted.
- **Auto** - Automatically detects the presence of HDCP-compliant sink devices. If an HDCP-compliant display is detected, then HDCP content will be sent. Otherwise, non-HDCP content will be sent.

HDMI2 HDCP

Provides control over the transmission of HDCP content for HDMI 2. The following options are available:

- **Compliant** - Forces detection of HDCP-compliant sink devices. If the sink device is not HDCP-compliant, then no content will be transmitted.
- **Noncompliant** - Suppresses detection of HDCP-compliant sink devices, allowing non-HDCP content to be transmitted.
- **Auto** - Automatically detects the presence of HDCP-compliant sink devices. If an HDCP-compliant display is detected, then HDCP content will be sent. Otherwise, non-HDCP content will be sent.



NOTE: The HDCP control feature does **not** provide decryption of HDCP content to non-HDCP sink devices.

Display Menu



AT-HD-SC-500 Display

Info
Video
Audio
Picture
EDID
Display
RS-232
OSD
Config
Network
Logout

CEC

CEC Command

Power

System Settings

Display Auto Power On

Display Auto Power Off

Power Button Lock

Lamp Cool Down Timer(0-300 Sec.)

Display Warm Up Timer(0-300 Sec.)

Auto Power Off Timer(5-240 Sec.)

Control Type

Feedback Verify

Display Mode

Volume/Mute

TCP/IP Settings of Controlled Device

IP Mode

IP Address

Port

Username

Password

RS-232/IP commands

Display commands

Send Mode

ON

Set command

Feedback

OFF

Set command

Feedback

Volume+

Set command

Volume-

Set command

Mute

Set command

Feedback

CEC

CEC Command

Click the **ON** button to send the power-on command to the display device. Click the **OFF** button to toggle the power state to off.

System Settings

Display Auto Power On

Sends the command to power-on the display when an A/V signal is detected. Click the toggle to enable or disable this feature.

Display Auto Power Off

Sends the command to power-off the display when an A/V signal is no longer present. Click the toggle to enable or disable this feature.

Power Button Lock

Allows the **DISPLAY** button, on the front panel, to be locked, preventing accidental operation when the product is in use. Define the time interval, before the button is locked, in the Display Warm Up field.

Lamp Cool Down Timer

Sets the cool-down interval, in seconds, before the projector can be powered-off. During this time interval, the projector will not accept any commands until the “power off” command has been processed and the projector lamp has completed the cool-down cycle. Range: 0 to 300.

Display Warm Up Timer

Sets the time interval, in seconds, between when the display is powered on and when the **DISPLAY** button, on the front panel, will be locked. Range: 0 to 300.

Auto Power Off Timer

Sets the time interval, in seconds, between when the loss of A/V signal is detected and when the “Display Off” command is sent.

Control Type

Sets the control method for sending commands. The following options are available: RS-232, IP, CEC.

Setting	Description
RS-232	RS-232 is used to send commands.
IP	Commands are sent over IP.
CEC	Uses CEC to send commands.

Feedback Verify

Sets the feedback verification state. Click the toggle to enable or disable this feature. The following options are available.

Setting	Description
On	The AT-HD-SC-500 will make four attempt to send the command, if the feedback string is not acknowledged. After the fourth attempt, the process will fail. Execute the SetCmdFB (page 72) command to set the feedback string.
Off	Sends the command and ignores the feedback string.

Display Mode

Click this drop-down list to select the display mode.

Setting	Description
DispSW AVon	Display switches on/off, source audio/video signal always on.
DispSW AVSW	Display switches on/off, source audio/video signal switches on/off.
AV SW	Display is always on, source audio/video signal switches on/off

Volume / Mute

Click this drop-down list to select the control method for volume and muting.

Setting	Description
Audio Out	Volume and mute buttons will control volume level of the output.
RS-232	Volume/Mute buttons will send the commands using RS-232 to compatible extenders and displays.
IP	Volume/Mute buttons will send the commands over Ethernet using the LAN connection.

TCP/IP Settings of Controlled Devices

IP Mode

Click this drop-down list to select the control method for volume and muting.

Setting	Description
Non-login	Does not require a username and password when using TCP/IP to control the display.
RS-232	Requires a username and password to control the display through TCP/IP.

IP Address

Enter the IP address of the display in this field.

Port

Enter the listening port of the device in this field.

Username

Enter the username for login.

Password

Enter the password for login.

RS-232 / IP Commands

Send Mode

Click this toggle to set how the commands will be sent to the display. Range: **ASCII** or **Hex**.

ON/OFF/Volume+/Volume-/Mute

These are the available operations that can be performed on the display.

- **Set command**
Enter the command in this field.
- **Feedback**
Enter the feedback string in this field.
- **CR-LF**
Click this drop-down list to select the desired end-of-line characters to be sent.

Setting	Description
None	No end-of-line characters included
CR	Carriage return
LF	Line feed
CR-LF	Carriage return + Line feed
Space	Space character
STX	Start-of-text character
ETX	End-of-text character
Null	Null character (binary zero)

RS-232 Menu

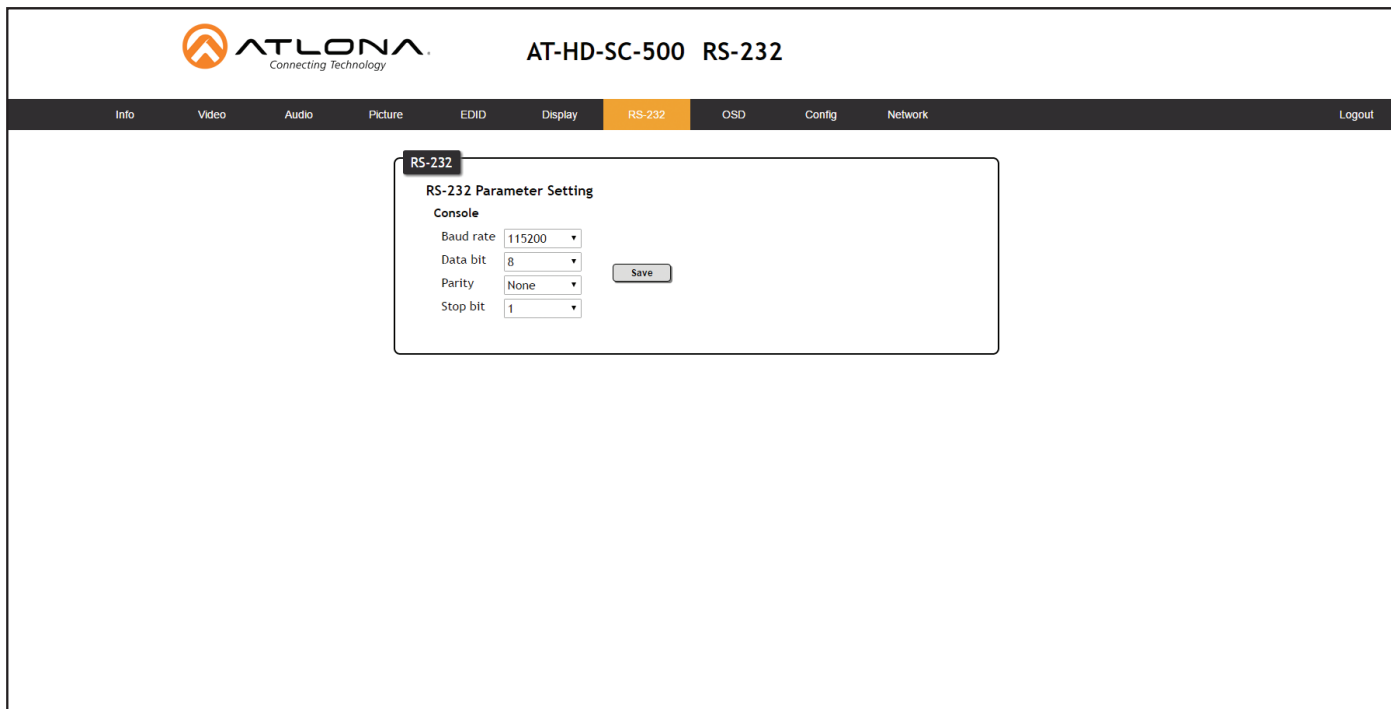

Baud rate

Sets the baud rate for the AT-HD-SC-500. The following options are available: 2400, 4800, 9600, 19200, 28800, 57600, 115200.

Data bit

Sets the number of data bits used to represent each character of data. The following options are available: 5, 6, 7, 8, 9.

Parity

Sets the parity bit, which can be included with each character to detect errors during the transmission of data. The following options are available: None, Odd, or Even.

Setting	Description
None	No parity; error detection is handled by RS-232 protocol.
Odd	Parity will be set to 1 if, for a given set of bits, the count is odd.
Even	Parity will be set to 1 if, for a given set of bits, the count is even.

Stop bit

Sets the stop bit. Stop bits are sent at the end of each character, allowing the client to detect the end of a character stream. The following options are available: 1 or 2.

Save

Click this button to save all changes to the RS-232 settings.

OSD Menu

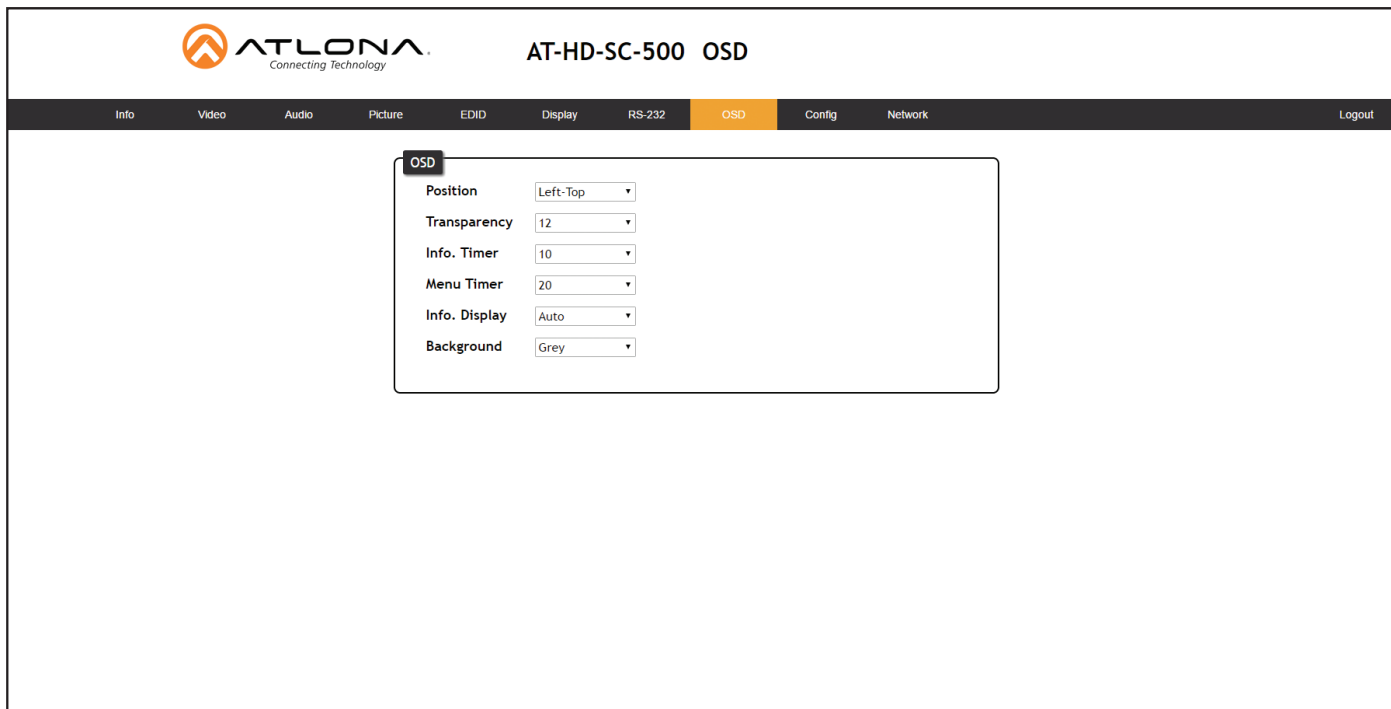

Position

Sets the position of the OSD on the display. The following options are available. Left Top, Right Top, Right Bottom, Left Bottom, Center.

Transparency

Adjusts the transparency setting of the OSD. Range: 5 to 100.

Info Timer

The duration, in seconds, of how long the Display Info screen is displayed.

Menu Timer

The duration, in seconds, of how long the OSD remains on the screen after no activity.

Info. Display

Adjusts the display settings of the Info Display screen, which indicates the input and output resolution. The following options are available:

Setting	Description
Auto	Automatically displays the Info Display screen when a change is made to the input or output signal. The screen will automatically be hidden after approximately five seconds.
Off	Prevents the Info Display screen from being displayed.
On	The Info Display screen is always displayed.

Background

Sets the background color of the OSD. The following options are available: Grey, Cyan, Magenta, Yellow.

Config Menu



Old Username

This field cannot be changed. “root” is the administrator user.

Old Password

Enter the current password for the “root” username in this field. The default password is “Atlona”.

New Username

This field cannot be changed.

Save

Click this button to save all changes.

New Password

Enter the new password for the “root” username in this field.

Confirm New Password

Verify the new password by retyping it in this field.

All User Login Settings

- Username**
 Displays the username.
- Password**
 Displays the password for the associated username.
- Edit**
 Click the **Add** button, in this column, to edit the username and password in the row.
- Del**
 Click the **Remove** button to delete the user in the row. This button will only be available if a username and password have been created.

Network Menu

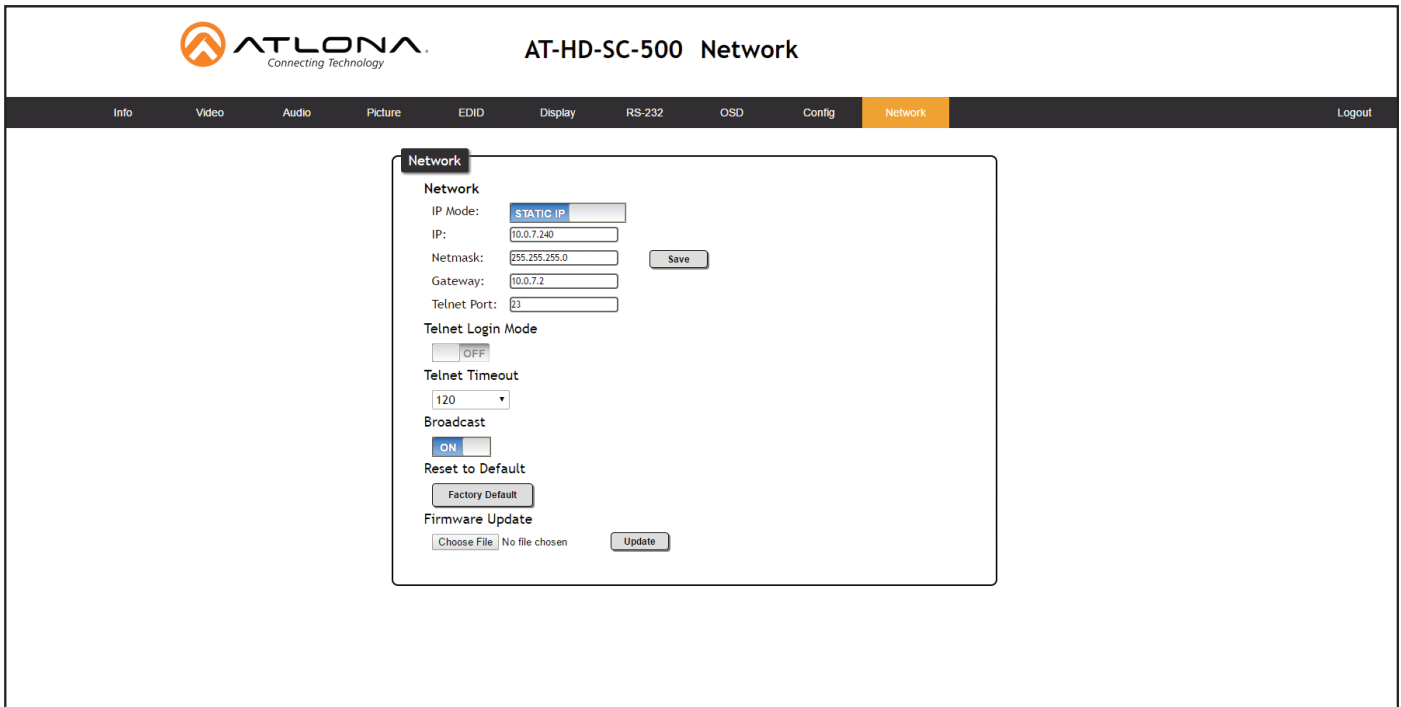

IP Mode

Click this toggle to set the IP mode of the AT-HD-SC-500. By default, the AT-HD-SC-500 is set to DHCP mode.

IP

Enter the IP address of the AT-HD-SC-500 in this field. This field will only be available if **IP Mode** is set to **STATIC IP**.

Netmask

Enter the subnet mask in this field. This field will only be available if **IP Mode** is set to STATIC IP.

Gateway

Enter the gateway (router) address in this field. This field will only be available if **IP Mode** is set to STATIC IP.

Telnet Port

Enter the Telnet port in this field.

Telnet Login Mode

Click this toggle to set the login mode to ON or OFF. If this feature is set to on, then the AT-HD-SC-500 will prompt for both the username and password. Use the same credentials as the web GUI.

Telnet Timeout

Click this drop-down list to select the timeout interval, in seconds, before the Telnet connection is automatically closed after no activity.

Broadcast

By default, broadcast mode is set to off. When set to on, changes in the web GUI will also be affected on the control system (if connected), via TCP/IP. To separate control between web GUI and Telnet, set this feature off.

Factory Default

Sets the AT-HD-SC-500 to factory-default settings.

Choose File

Click this button to select the firmware file, when upgrading the firmware on the AT-HD-SC-500.

Save

Click this button to save all changes to the network settings.

Update

Click this button to begin the upgrade procedure. Refer to [Updating the Firmware \(page 81\)](#) for more information.

Commands

The following tables provide an alphabetical list of commands available on the AT-HD-SC-500. All commands are case-sensitive and must be entered as documented.

Command	Description
AnaGain	Sets the gain of the analog audio input
ASPBGRND	Sets the matte color for the bars used in viewing letterbox formats
Aspect	Sets the aspect ratio of the output signal
ASwOutTime	Sets period of time after loss of signal before auto switching to the selected fallback input
ASwPrePort	Sets the default fallback input for auto-switching
AudioSrc	Set audio source for the HDMI inputs
AutoDispOff	Enables / disables display auto-off
AutoDispOn	Enables / disables display auto-on
AutoPwrMode	Set the display mode for auto power on and off
AutoSW	Enable/Disable auto switching or display auto switching status
Bass	Increases / decreases the amount of bass on the output
Broadcast	Enables / disables broadcast mode
BRT	Sets the picture brightness
BTNVol	Defines the behavior of the VOL+, VOL-, and MUTE buttons
CliIPAddr	Sets the IP address of the Telnet client
CliMode	Sets the login mode of the Telnet client
CliPass	Sets the password for the Telnet client
CliPort	Sets the listening port for the Telnet client
CliUser	Sets the username for the Telnet client
CMDFMT	Sets the display format for commands
CSpara	Sets the baud rate, data bits, stop bits, and parity for the serial device
CtlType	Sets the communication protocol used to send the on/off command
CTRST	Sets the picture contrast
DisWarmUp	Sets the Display power-on time interval when locking the DISPLAY button
DispBtn	Simulates pressing the DISPLAY button on the front panel
Down	Scrolls the cursor down on position in the OSD
HDCPSet1	Sets the HDCP reporting mode for HDMI IN 1

Command	Description
HDCPSet2	Sets the HDCP reporting mode for HDMI IN 2
HDMIAUD	Enables / disables audio on the HDMI output
Help	Displays the list of available commands
HUE	Sets the picture hue
HZoom	Sets the horizontal zoom (overscan) for the output image
INFOOSD	Enables / disables the OSD info screen
INFOTMR	Sets the time interval for the info screen before it is hidden
Input	Sets the active input
IPAddUser	Adds a user for Telnet control
IPCFG	Displays the current network settings for the AT-HD-SC-500
IPDelUser	Deletes the specified Telnet user
IPDHCP	Enables / disables DHCP mode on the AT-HD-SC-500
IPLogin	Enables / disables login credentials when starting a Telnet session
IPPort	Sets the Telnet listening port for the AT-HD-SC-500
IPQuit	Terminates the Telnet session
IPStatic	Sets the static IP address, subnet mask, and gateway for the AT-HD-SC-500
IPTimeout	Specifies the time interval of inactivity before the Telnet session is closed
LampCool	Sets the cool-down interval before the projector can be powered-off
Lock	Locks the buttons on the front panel
LRAUD	Enables / disables the L/R audio output
MENUTMR	Specifies the time interval of inactivity before the OSD menu is hidden
MirrorV	Vertically mirrors the video
Mreset	Resets the AT-HD-SC-500 to factory-default settings
OSD	Sets the location of the OSD menu on the screen
OSDApha	Sets the transparency of the OSD menu
OSDBGRND	Sets the background color of the OSD menu
PicReset	Resets all picture settings
PTIMGHDMI	Sets the preferred HDMI input timing
PTIMGVGA	Sets the preferred VGA input timing
PWLock	Locks / unlocks the DISPLAY key on the front panel

Command	Description
QOSD	Exits the OSD menu
RAtIMac	Displays the MAC address of the AT-HD-SC-500
SATRT	Sets the picture color saturation
Select	Confirms the selection in the OSD
SetCmd	Assigns an RS-232 or IP command to the specified button on the front panel
SetCmdFB	Sets the feedback string for the specified command key
SetCS	Sets the output color space
SetEnd	Sets the end-character of the specified command
SetOff	Sets the time period to place the unit in standby
SHARP	Sets the picture sharpness
System	Displays system information about the AT-HD-SC-500
Treble	Increases / decreases the treble on the output
TrigCEC	Triggers the stored CEC command
TrigIP	Triggers the stored IP commands to the Telnet client
TrigRS	Triggers the stored command from RS-232 or IP
UARTPara	Sets the baud rate, data bits, parity, and stop bits for the serial port
Unlock	Unlocks the buttons on the front panel
Up	Scrolls up the cursor, in the OSD menu, one position
Version	Displays the current firmware version of the AT-HD-SC-500
VGAAuto	Automatically adjusts the clock and phase of the VGA signal
VidOutRes	Sets the video output resolution
VOUT1	Increases / decreases the audio volume
VOUTMute1	Mutes / unmutes the audio
VOUTOSD	Enables / disables the volume bar in the OSD
VZoom	Adjusts the vertical zoom (overscan) of the output image
x1\$	Enables / disables the HDMI video output
Zoom	Enables / disables overscan

AnaGain

Sets the gain of the analog input.

Syntax

AnaGain X

Parameter	Description	Range
X	Audio gain	0 ... 16

Example
AnaGain 1

Feedback
AnaGain 1

ASPBGRND

Sets the matte color when viewing an image that has been processed in “letterbox” format. The default setting is grey.

Syntax

ASPBGRND X

Parameter	Description	Range
X	Matte color	0 = Grey 1 = Black

Example
ASPBGRND 1

Feedback
ASPBGRND 1

Aspect

Sets the aspect ratio of the output signal. The default setting is **Full**.

Syntax

Aspect X

Parameter	Description	Range
X	Aspect ratio	0 = Full 1 = 16:9 2 = 16:10 3 = 4:3 4 = Keep Ratio

Example
Aspect 1

Feedback
Aspect 1

ASwOutTime

Sets the time interval after loss of signal occurs, before automatically switching to the selected fallback input. Execute the **ASwPrePort** command to set the fallback input.

Syntax

```
ASwOutTime X
```

Parameter	Description	Range
X	Time (in seconds)	1 ... 600

Example

```
ASwOutTime 15
```

Feedback

```
ASwOutTime 15
```

ASwPrePort

Sets the fallback input when auto-switching is enabled. Use the **sta** argument to return the current fallback input. To always return the AT-HD-SC-500 to the last active input, use the **Prev** argument.

Syntax

```
ASwPrePort X
```

Parameter	Description	Range
X	Port	HDMI1, HDMI2, VGA, Prev, sta

Example

```
ASwPrePort HDMI1
```

Feedback

```
ASwPrePort HDMI1
```

AudioSrc

Sets the audio source for the each HDMI input. Parameter X specifies the HDMI port. Parameter Y specifies the type of audio that will be used.

Syntax

```
AudioSrcX Y
```

Parameter	Description	Range
X	Port	HDMI1, HDMI2, VGA, Prev, sta
Y	Audio type	auto = Automatically selects the audio type dig = Digital audio only ana = Analog audio from the AUDIO IN port is embedded on the output.

Example

```
AudioSrc1 ana
```

Feedback

```
AudioSrc1 ana
```

AutoDispOff

Sends the command to power-off the display when an A/V signal is no longer present. Use the **on** argument to enable this feature. Use the **sta** argument to return the current **AutoDispOff** setting.

Syntax

```
AutoDispOff X
```

Parameter	Description	Range
X	Value	on, off, sta

Example

```
AutoDispOff on
```

Feedback

```
AutoDispOff on
```

AutoDispOn

Sends the command to power-on the display when an A/V signal is detected. Use the **on** argument to enable this feature. Use the **sta** argument to return the current **AutoDispOff** setting.

Syntax

```
AutoDispOn X
```

Parameter	Description	Range
X	Value	on, off, sta

Example

```
AutoDispOn on
```

Feedback

```
AutoDispOn on
```

AutoPwrMode

Sets the display mode for auto-power on and off.

Syntax

```
AutoPwrMode X
```

Parameter	Description	Range
X	Value	DISPAVON, DISPAVSW, AVSW, sta

Example

```
AutoPwrMode DISPAVON
```

Feedback

```
AutoPwrMode DISPAVON
```

AutoSW

Enables / disables auto switching or display auto switching status.

Syntax

```
AutoSW X
```

Parameter	Description	Range
X	Value	on, off, sta

Example

AutoSW on

Feedback

AutoSW on

Bass

Increases / decreases the amount of bass on the **output**. In addition to specifying an integer value, the + and - arguments can be used, by themselves, to increase or decrease the bass by 1 value, respectively.

Syntax

```
Bass X
```

Parameter	Description	Range
X	Value	-12 ... 15, sta

Example

Bass -5

Bass +

Feedback

Bass -5

Bass -4

Broadcast

Enables / disables broadcast mode. By default, broadcast mode is set to off. When set to on, changes in the web GUI will also be affected on the control system (if connected), via TCP/IP. To separate control between web GUI and Telnet, set this feature off. on = enables broadcast mode; off = disables broadcast mode; sta = displays the current Broadcast setting.

Syntax

```
Broadcast X
```

Parameter	Description	Range
X	Value	on, off, sta

Example

Broadcast on

Feedback

Broadcast on

BRT

Sets the picture brightness. Use the sta argument to display the current brightness setting.

Syntax

```
BRT X
```

Parameter	Description	Range
X	Value	0 ... 100, sta

Example
BRT 60

Feedback
BRT 60

BTNVol

Defines the behavior of the VOL+, VOL-, and MUTE buttons, on the front panel. AudOut = buttons will control volume level of the output, RS232 = buttons will send the commands using RS-232 to compatible extenders and displays, IP = buttons will send the commands over Ethernet using the LAN connection, sta = displays the current BTNVol setting.

Syntax

```
BTNVol X
```

Parameter	Description	Range
X	Value	AudOut, RS232, IP, sta

Example
BTNVol RS232

Feedback
BTNVol RS232

CliIPAddr

Sets the IP address of the Telnet client. The IP address must be specified in dot-decimal notation. Use the sta argument to display the IP address of the Telnet client. DHCP must be disabled before using this command. Refer to the [IPDHCP \(page 64\)](#) command for more information.

Syntax

```
CliIPAddr X
```

Parameter	Description	Range
X	IP address	0 ... 255 (per byte)

Example
CliIPAddr 192.168.1.61

Feedback
CliIPAddr 192.168.1.61

CliMode

Sets the login mode of the Telnet client. login = requires login credentials, non-login = no login credentials required, sta = displays the current CliMode setting.

Syntax

```
CliMode X
```

Parameter	Description	Range
X	Value	login, non-login, sta

Example

```
CliMode login
```

Feedback

```
CliMode login
```

CliPass

Sets the password for the Telnet client. Execute the CliPass command without arguments to display the current password. The default password is Atlona.

Syntax

```
CliPass X
```

Parameter	Description	Range
X	Password	20 characters (max)

Example

```
CliPass R3ind33r
```

Feedback

```
CliPass R3ind33r
```

CliPort

Sets the listening port for the Telnet client. Use the sta argument to display the current listening port. The default port is 23.

Syntax

```
CliPort X
```

Parameter	Description	Range
X	Port	0 ... 65535

Example

```
CliPort 30
```

Feedback

```
CliPort 30
```

CliUser

Sets the username for the Telnet client. Execute the CliUser command without arguments to display the current username.

Syntax

```
CliUser X
```

Parameter	Description	Range
X	Username	20 characters (max)

Example

```
CliUser BigBoss
```

Feedback

```
CliUser BigBoss
```

CMDFMT

Sets the display format for commands. `ascii` = ASCII format, `hex` = hexadecimal format, `sta` = displays the current command format.

Syntax

```
CMDFMT X
```

Parameter	Description	Range
X	Format	ascii, hex, sta

Example

```
CMDFMT ascii
```

Feedback

```
CMDFMT ascii
```

CSpa

Sets the baud rate, data bits, parity bit, and stop bits for the serial device. Use the `sta` argument to display the current serial port settings. Each argument must be separated by a comma; no spaces are permitted. Brackets must be used when executing this command.

Syntax

```
CSpa[W,X,Y,Z]
```

Parameter	Description	Range
W	Baud rate	2400, 4800, 9600, 19200, 38400, 57600, 115200
X	Data bits	7, 8
Y	Parity bit	None, Odd, Even
Z	Stop bits	1, 2

Example

```
CSpa[115200,8,0,1]
CSpa[sta]
```

Feedback

```
CSpa[115200,8,0,1]
CSpa [115200,8,0,1]
```

CtrlType

Sets the communication protocol used to send the on/off command. rs232 = command set over rs232, IP = command sent over IP, CEC = command sent using CEC, sta = displays the current CtrlType setting.

Syntax

```
CtrlType X
```

Parameter	Description	Range
X	Protocol	rs232, IP, CEC, sta

Example
CtrlType IP

Feedback
CtrlType IP

CTRST

Sets the picture contrast. Use the sta argument to display the current contrast setting.

Syntax

```
CTRST X
```

Parameter	Description	Range
X	Contrast	0 ... 100, sta

Example
CTRST 65

Feedback
CTRST 65

DisWarmUp

Sets the time interval, in seconds, between when the display is powered on and when the **DISPLAY** button, on the front panel, will be locked. Use the sta argument to display the current time interval.

Syntax

```
DisWarmUp X
```

Parameter	Description	Range
X	Time interval	0 ... 300, sta

Example
DisWarmUp 120

Feedback
DisWarmUp 120

DispBtn

Simulates pressing the **DISPLAY** button on the front panel, activating the display mode and RS-232/CEC/IP display control commands. On = simulates pressing the DISPLAY button to the “on” state, Off = simulates pressing the DISPLAY button to the “off” state, Tog = reverses the current state of the DISPLAY button, Sta = displays the current DispBtn setting.

Syntax

DispBtn X

Parameter	Description	Range
X	Setting	On, Off, Tog, Sta

Example

DispBtn on

Feedback

DispBtn on

Down

Scrolls down the cursor, in the OSD menu, one position.

Syntax

Down

This command does not require any parameters

Example

Down

Feedback

Down

HDCPSet1

Set the HDCP reporting mode of the **HDMI IN 1** port. Some computers will send HDCP content if an HDCP-compliant display is detected. Setting this value to off, will force the computer to ignore detection of HDCP-compliant displays. Disabling this feature will *not* decrypt HDCP content. on = enables HDCP detection; off = disables HDCP detection; sta = displays the current HDCPSet1 setting.

Syntax

HDCPSet1 X

Parameter	Description	Range
X	Value	on, off, sta

Example

HDCPSet1 on

Feedback

HDCPSet1 on

HDCPSet2

Set the HDCP reporting mode of the **HDMI IN 2** port and performs the same type of function as the **HDCPSet1** command. on = enables HDCP detection; off = disables HDCP detection; sta = displays the current HDCPSet2 setting.

Syntax
HDCPSet2 X

Parameter	Description	Range
X	Value	on, off, sta

Example
HDCPSet2 off

Feedback
HDCPSet2 off

HDMIAUD

Enables / disables audio on the HDMI output. on = enables HDMI audio output; off = disables HDMI audio output; sta = displays the current HDMIAUD setting.

Syntax
HDMIAUD

Parameter	Description	Range
X	Value	on, off, sta

Example
HDMIAUD off

Feedback
HDMIAUD off

Help

Displays the list of available commands. To obtain help on a specific command, enter the **Help** command followed by the name of the command.

Syntax
Help X

Parameter	Description	Range
X	Command name	Optional

Example
Help

Feedback
Command List

Help
IPCFG
...
CliIPAddr
CliPort

HUE

Sets the picture hue. Use the sta argument to display the current HUE value.

Syntax

```
HUE X
```

Parameter	Description	Range
X	Value	0 ... 100, sta

Example
HUE 40

Feedback
HUE 40

HZoom

Set the horizontal zoom for the output image. Use the sta argument to display the current HZoom value.

Syntax

```
HZoom X
```

Parameter	Description	Range
X	Value	0 ... 50, sta

Example
HZoom 10

Feedback
HZoom 10

INFOOSD

Enables / disables the OSD info screen. on = info screen always on, off = info screen is off, auto = info screen is displayed when a resolution change is made, then is automatically hidden, sta = displays the current INFOOSD setting.

Syntax

```
INFOOSD X
```

Parameter	Description	Range
X	Value	on, off, sta

Example
INFOOSD on

Feedback
INFOOSD on

INFOTMR

Sets the time interval (in seconds) of the info screen, before it is hidden. Use the sta argument to display the current INFOTMR value.

Syntax
INFOTMR X

Parameter	Description	Range
X	Time interval	5 ... 100, sta

Example
INFOTMR 60

Feedback
INFOTMR 60

Input

Sets the active input. Use the sta argument to display the currently active input.

Syntax
Input X

Parameter	Description	Range
X	Input	HDMI 1, HDMI 2, VGA, sta

Example
Input HDMI 2

Feedback
Input HDMI 2

IPAddUser

Adds a user for Telnet control. This command performs the same function as adding a user within the **Config** page of the web GUI. Refer to [Config Menu \(page 46\)](#) for more information.

Syntax
IPAddUser X Y

Parameter	Description	Range
X	User name	20 characters (max)
Y	Password	20 characters (max)

Example
IPAddUser BigBoss b055man

Feedback
IPAddUser BigBoss b055man
TCP/IP user was added

IPCFG

Displays the current network settings for the AT-HD-SC-500.

Syntax

```
IPCFG
```

This command does not require any parameters

Example

```
IPCFG
```

Feedback

```
IP Addr : 192.168.1.38
Netmask : 255.255.255.0
Gateway : 192.168.1.1
Telnet Port: 23
Http Port: 80
```

IPDelUser

Deletes the specified TCP/IP user. This command performs the same function as removing a user within the **Config** page of the web GUI. Refer to the [Config Menu \(page 46\)](#) for more information.

Syntax

```
IPDelUser X
```

Parameter	Description	Range
X	User	User name

Example

```
IPDelUser BigBoss
```

Feedback

```
IPDelUser BigBoss
TCP/IP user was deleted
```

IPDHCP

Enables / disables DHCP mode on the AT-HD-SC-500. on = enables DHCP mode; off = disables DHCP mode; sta = displays the current IPDHCP setting. If this feature is disabled, then a static IP address must be specified for the AT-HDR-M2C. Refer to the [IPStatic \(page 66\)](#) command for more information.

Syntax

```
IPDHCP X
```

Parameter	Description	Range
X	Value	on, off, sta

Example

```
IPDHCP on
```

Feedback

```
IPDHCP on
```

IPLogin

Enables / disables the use of login credentials when starting a Telnet session on the AT-HD-SC-500. If this feature is set to on, then the AT-HD-SC-500 will prompt for both the username and password. Use the same credentials as the web GUI. on = login credentials required; off = no login required; sta = displays the current IPLogin setting.

Syntax

```
IPLogin X
```

Parameter	Description	Range
X	Value	on, off, sta

Example

```
IPLogin off
```

Feedback

```
IPLogin off
```

IPPort

Sets the Telnet listening port for the AT-HD-SC-500. Use the sta argument to display the current port setting.

Syntax

```
IPPort X
```

Parameter	Description	Range
X	Port	0 ... 65535, sta

Example

```
IPPort 23
```

Feedback

```
IPPort 23
```

IPQuit

Terminates the Telnet session.

Syntax

```
IPQuit X
```

This command does not require any parameters

Example

```
IPQuit
```

Feedback

```
IPQuit
```

IPStatic

Sets the static IP address, subnet mask, and gateway (router) address of the AT-HDR-M2C. Before using this command, DHCP must be disabled on the AT-HDR-M2C. Refer to the [IPDHCP \(page 64\)](#) command for more information. Each argument must be entered in dot-decimal notation and separated by a space. The default static IP address is 192.168.1.254.

Syntax

```
IPStatic X Y Z
```

Parameter	Description	Range
X	IP address	0 ... 255 (per byte)
Y	Subnet mask	0 ... 255 (per byte)
Z	Gateway (router)	0 ... 255 (per byte)

Example

```
IPStatic 192.168.1.112 255.255.255.0 192.168.1.1
```

Feedback

```
IPStatic 192.168.1.112 255.255.255.0 192.168.1.1
```

IPTimeout

Specifies the time interval of inactivity before the Telnet session is automatically closed.

Syntax

```
IPTimeout X
```

Parameter	Description	Range
X	Interval (in seconds)	0 ... 60000

Example

```
IPTimeout 300
```

Feedback

```
IPTimeout 300
```

LampCool

Sets the cool-down interval, in seconds, before the projector can be powered-off. During this time interval, the projector will not accept any commands until the “power off” command has been processed and the projector lamp has completed the cool-down cycle. Use the `sta` argument to display the current port setting.

Syntax

```
LampCool X
```

Parameter	Description	Range
X	Interval (in seconds)	0 ... 300, sta

Example

```
LampCool 120
```

Feedback

```
LampCool 120
```

Lock

Locks the buttons on the front panel. This function is useful to prevent accidental activation of the front-panel buttons in a busy environment. Use the [Unlock \(page 76\)](#) command to unlock the button on the front panel.

Syntax

```
Lock
```

This command does not require any parameters

Example

```
Lock
```

Feedback

```
Lock
```

LRAUD

Enables / disables the L/R audio output. on = enables L/R audio out, off = disables L/R audio out, sta = displays the current LRAUD setting.

Syntax

```
LRAUD X
```

Parameter	Description	Range
X	Value	on, off, sta

Example

```
LRAUD off
```

Feedback

```
LRAUD off
```

MENUTMR

Sets the time interval before the OSD menu system is automatically hidden after no activity. Use the sta argument to display the current MENUTMR setting.

Syntax

```
MENUTMR X
```

Parameter	Description	Range
X	Interval (in seconds)	5 ... 100, sta

Example

```
MENUTMR 60
```

Feedback

```
MENUTMR 60
```

MirrorV

Vertically mirrors the video. on = enables vertical mirroring, off = disables vertical mirroring, sta = displays the current MirrorV setting.

Syntax

```
MirrorV
```

Parameter	Description	Range
X	Value	on, off, sta

Example

```
MirrorV on
```

Feedback

```
MirrorV on
```

Mreset

Resets the AT-HD-SC-500 to factory-default settings.

Syntax

```
MReset
```

This command does not require any parameters

Example

```
Mreset
```

Feedback

```
Mreset
```

OSD

Sets the location of the OSD menu on the screen. 0 = Left-Top, 1 = Right-Top, 2 = Right-Bottom, 3 = Left-Bottom, 4 = Center, sta = displays the current OSD setting.

Syntax

```
OSD X
```

Parameter	Description	Range
X	Position	0 ... 4, sta

Example

```
OSD 2
```

Feedback

```
OSD 2
```

OSDAAlpha

Sets the transparency of the OSD menu. Use the sta argument to display the current OSDAlpha setting.

Syntax

```
OSDAAlpha X
```

Parameter	Description	Range
X	Opacity	0 ... 15, sta

Example
OSDAAlpha 2

Feedback
OSDAAlpha 2

OSDBGRND

Sets the background color of the OSD menu. 0 = grey, 1 = cyan, 2 = magenta, 3 = yellow, sta = displays the current OSDBGRND setting.

Syntax

```
OSDBGRND X
```

Parameter	Description	Range
X	Color	0 ... 3, sta

Example
OSDBGRND 2

Feedback
OSDBGRND 2

PicReset

Resets all picture settings.

Syntax

```
PicReset
```

This command does not require any parameters

Example
PicReset

Feedback
PicReset

PTIMGHDMI

Sets the preferred HDMI input timing. This setting is applied to both **HDMI IN 1** and **HDMI IN 2** ports. Use the sta argument to display the current PTIMGHDMI setting.

Syntax

```
PicReset
```

Parameter	Description	Range
X	Timing	0 ... 7, sta

Preferred Timing List

0 = 800 x 600

1 = 1024 x 768

2 = 1280 x 720

3 = 1280 x 800

4 = 1366 x 768

5 = 1680 x 1050

6 = 1920 x 1080

7 = 1920 x 1200

PTIMGVGA

Sets the preferred VGA input timing. Use the sta argument to display the current PTIMGVGA setting.

Syntax

```
PTIMGVGA X
```

Parameter	Description	Range
X	Timing	0 ... 7, sta

Example

```
PTIMGVGA 3
```

Feedback

```
PTIMGVGA 3
```

PWLock

Locks / unlocks the **DISPLAY** key on the front panel. on = enables DISPLAY lock, off = disables DISPLAY lock button, sta = displays the current PWLock setting.

Syntax

```
PWLock
```

Parameter	Description	Range
X	Value	on, off, sta

Example

```
PWLock on
```

Feedback

```
PWLock on
```

QOSD

Exits the OSD menu.

Syntax

```
QOSD
```

This command does not require any parameters

Example

```
QOSD
```

Feedback

```
QOSD
```

RAtIMac

Displays the MAC address of the AT-HDR-M2C.

Syntax

```
RAtIMac
```

This command does not require any parameters

Example

```
RAtIMac
```

Feedback

```
b8-98-b0-01-21-7c
```

SATRT

Sets the picture color saturation value. Use the sta argument to display the current SATRT setting.

Syntax

```
SATRT X
```

Parameter	Description	Range
X	Saturation	0 ... 100, sta

Example

```
SATRT 50
```

Feedback

```
SATRT 50
```

Select

Confirms the current selection in the OSD. Use the [Up \(page 77\)](#) and [Down \(page 60\)](#) commands to select (highlight) the desired option within the OSD.

Syntax

```
Select
```

This command does not require any parameters

Example

```
Select
```

Feedback

```
Select
```

SetCmd

Assigns an RS-232 or IP command to the specified button on the front panel.

Syntax

```
SetCmd X[Y]
```

Parameter	Description	Range
X	Button	on, off, vol+, vol-, mute
Y	Command	Command string

Example

```
SetCmd mute[Select]
```

Feedback

```
SetCmd mute[Select]
```

SetCmdFB

Sets the feedback string for the specified command key.

Syntax

```
SetCmdFB X
```

Parameter	Description	Range
X	Feedback string	Feedback string

Example

```
SetCmdFB mute[Selected]
```

Feedback

```
SetCmdFB mute[Selected]
```

SetCS

Sets the output color space. 0 = RGB, 1 = YUV, sta = displays the current SetCS setting.

Syntax

```
SetCS
```

Parameter	Description	Range
X	Color space	0, 1, sta

Example

```
SetCS 0
```

Feedback

```
SetCS 0
```

SetEnd

Sets the end-character of the specified command. Refer to the [RS-232 / IP Commands \(page 43\)](#) section for more information.

Syntax

```
SetEnd X[Y]
```

Parameter	Description	Range
X	Command	on, off, vol+, vol-, mute, fbkon, fbkoff, fbkmute
Y	EOL character	None, CR, LF, CR-LF, Space, STX, ETX, null

Example

```
SetEnd off[CR-LF]
```

Feedback

```
SetEnd off[CR-LF]
```

SetOff

Sets the time period (in seconds) to place the unit in standby. Use the sta argument to display the current SetOff setting.

Syntax

```
SetOff X
```

Parameter	Description	Range
X	Time interval	5 ... 240, sta

Example

```
SetOff 60
```

Feedback

```
SetOff 60
```

SHARP

Sets the picture sharpness.

Syntax

```
SHARP X
```

Parameter	Description	Range
X	Sharpness	0 ... 100, sta

Example
SHARP 70

Feedback
SHARP 70

System

Displays system information about the AT-HD-SC-500. The sta argument must be specified.

Syntax

```
System X
```

Parameter	Description	Range
X	Status	sta

Example
System sta

Feedback
 Model: AT-HD-SC-500
 MAC Addr: b8-98-b0-01-21-7c
 Address Type: DHCP
 Netmask: 255.255.255.0
 Gateway: 10.0.1.1
 HTTP Port: 80
 Telnet Port: 23
 Firmware: 1.3.10
 On/Up Time(dd HH:mm:ss): 0 4:57:29
 Power Status: PWON

Treble

Increases / decreases the amount of treble. In addition to specifying an integer value, the + and - arguments can be used, by themselves, to increase or decrease the amount of treble by 1 value, respectively. To display the current value, use the sta argument.

Syntax

```
TREBLE1 X
```

Parameter	Description	Range
X	Value	-12 ... 15, sta

Example

Treble 7
Treble -

Feedback

Treble 7
Treble 6

TrigCEC

Triggers the stored CEC command.

Syntax

```
TrigCEC X
```

Parameter	Description	Range
X	Value	on, off, vol+, vol-, mute

Example

TrigCEC on

Feedback

TrigCEC on

TrigIP

Trigger the stored IP commands to the Telnet client.

Syntax

```
TrigIP X
```

Parameter	Description	Range
X	Value	on, off, vol+, vol-, mute

Example

TrigIP vol+

Feedback

TrigIP vol+

TrigRS

Triggers the stored commands from RS-232 or IP.

Syntax

```
TrigRS X
```

Parameter	Description	Range
X	Value	on, off, vol+, vol-, mute

Example

TrigRS mute

Feedback

TrigRS mute

UARTPara

Sets the baud rate, data bits, parity, and stop bits for the serial port. Each argument must be separated by a comma with no spaces.

Syntax

```
UARTPara X
```

Parameter	Description	Range
W	Baud rate	2400, 4800, 9600, 19200, 38400, 57600, 115200
X	Data bits	7, 8
Y	Parity bit	0, 1, 2 (None, Odd, Even)
Z	Stop bits	1, 2

Example

UARTPara 115200,8,0,1

Feedback

UARTPara setting ok!

Unlock

Unlocks the buttons on the front panel. Use the [Lock \(page 67\)](#) command to lock the buttons on the front panel.

Syntax

```
Unlock
```

This command does not require any parameters

Example

Unlock

Feedback

Unlock

Up

Scrolls up the cursor, in the OSD menu, one position.

Syntax
Up

This command does not require any parameters

Example

Up

Feedback

Up

Version

Displays the current firmware version of the AT-HD-SC-500.

Syntax
Version

This command does not require any parameters

Example

Version

Feedback

1.3.10

VGAAuto

Executes the VGA auto-adjust. This command automatically adjusts the phase and clock of the VGA signal. A VGA display must be connected to the AT-HD-SC-500 when executing this command. Otherwise, the command will fail.

Syntax
VGAAuto

This command does not require any parameters

Example

VGAAuto

Feedback

VGAAuto

VidOutRes

Sets the video output resolution. Use the sta argument to display the current video output resolution.

Syntax

```
VidOutRes
```

Parameter	Description	Range
X	Value	0 ... 27, sta

Output Resolution List

0 = 800x600p60	14 = 1280x720p59
1 = 1024x768p60	15 = 1280x720p60
2 = 1280x800p60	16 = 1920x1080i50
3 = 1280x1024p60	17 = 1920x1080i59
4 = 1366x768p60	18 = 1920x1080i60
5 = 1400x1050p60	19 = 1920x1080p23
6 = 1600x900p60	20 = 1920x1080p24
7 = 1600x1200p60	21 = 1920x1080p25
8 = 1680x1050p60	22 = 1920x1080p29
9 = 1920x1200pRB	23 = 1920x1080p30
10 = 1280x720p25	24 = 1920x1080p50
11 = 1280x720p29	25 = 1920x1080p59
12 = 1280x720p30	26 = 1920x1080p60
13 = 1280x720p50	27 = NATIVE

Example

```
VidOutRes 26
```

Feedback

```
VidOutRes 26
```

VOUT1

Increases / decreases the audio output volume. In addition to specifying an integer value, the + and - arguments can be used, by themselves, to increase or decrease the volume by 1 value, respectively. To display the current value, execute the VOUT1 command without any arguments.

Syntax

```
VOUT1
```

Parameter	Description	Range
X	Value	-80 ... 6

Example

```
VOUT1 4  
VOUT1 +
```

Feedback

```
VOUT1 4  
VOUT1 5
```

VOUTMute1

Mutes / unmutes the audio. on = enables muting; off = disables muting; sta = displays the current VOUMute1 setting.

Syntax

```
VOUMute1 X
```

Parameter	Description	Range
X	Value	on, off, sta

Example

VOUMute1 on

Feedback

VOUMute1 on

VOUOSD

Enables / disables the volume bar in the OSD. on = displays volume bar; off = hides volume bar; sta = displays the current VOUOSD setting.

Syntax

```
VOUOSD X
```

Parameter	Description	Range
X	Value	on, off, sta

Example

VOUOSD on

Feedback

VOUOSD off

VZoom

Adjusts the vertical zoom (overscan) of the output image. Use the sta argument to display the current VZoom setting.

Syntax

```
VZoom X
```

Parameter	Description	Range
X	Value	0 ... 50, sta

Example

VZoom 10

Feedback

VZoom 10

x1\$

Enables / disables the HDMI video output. on = enables HDMI output, off = disables HDMI output, sta = displays the current x1\$ setting.

Syntax

```
x1$ X
```

Parameter	Description	Range
X	Value	on, off, sta

Example

x1\$ off

Feedback

x1\$ off

Zoom

Enables / disables overscan. on = enables overscan; off = disables overscan; sta = displays the current Zoom setting.

Syntax

```
Zoom X
```

Parameter	Description	Range
X	Value	on, off, sta

Example

Zoom on

Feedback

Zoom off

Appendix

Updating the Firmware

Updating the firmware can be completed using either the USB interface or the web GUI. Atlona recommends using the web GUI for updating the firmware. However, if a network connection is not available, the AT-HD-SC-500 firmware can be updated using a USB-A to USB mini-B cable.

Using the Web GUI

Requirements

- AT-HD-SC-500
 - Firmware file
 - Computer
1. Connect an Ethernet cable from the computer, containing the firmware, to the same network where the AT-HD-SC-500 is connected.
 2. Go to the **Network Menu (page 47)** in the web GUI.

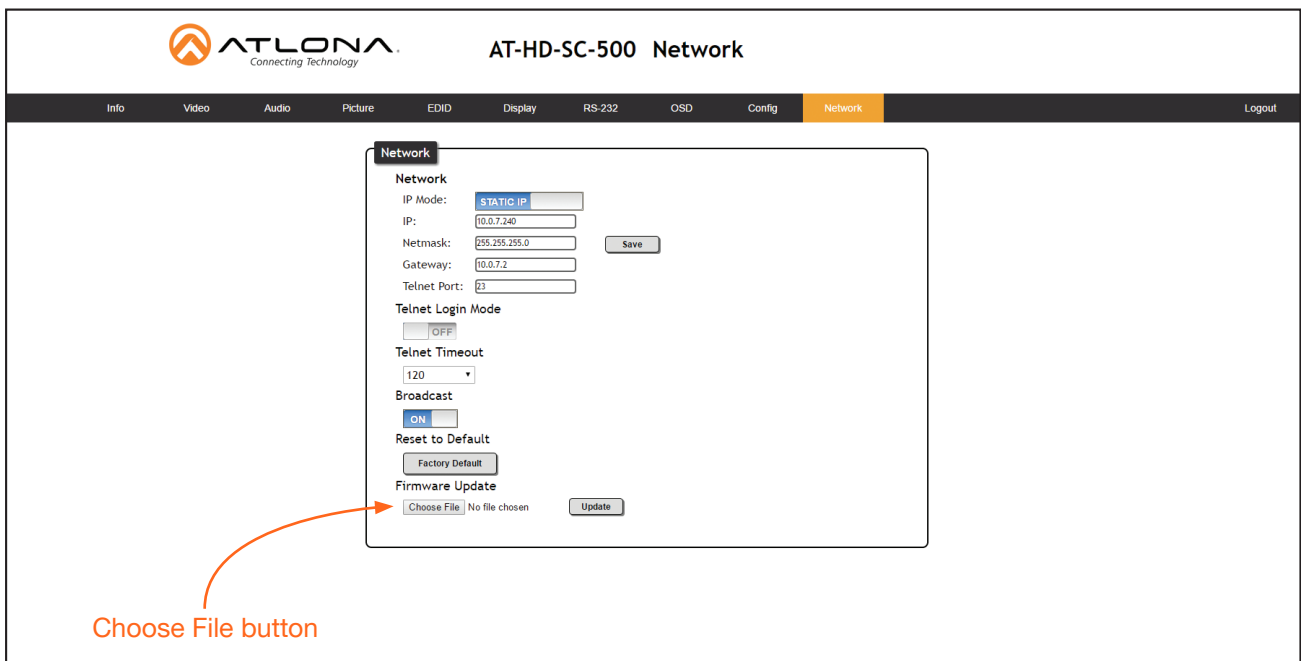

3. Click the **Choose File** button, under the **Firmware Update** section.
4. Browse to the location of the firmware file, select it, and click the **Open** button.
5. Click the **Update** button.
6. The following dialog will be displayed.

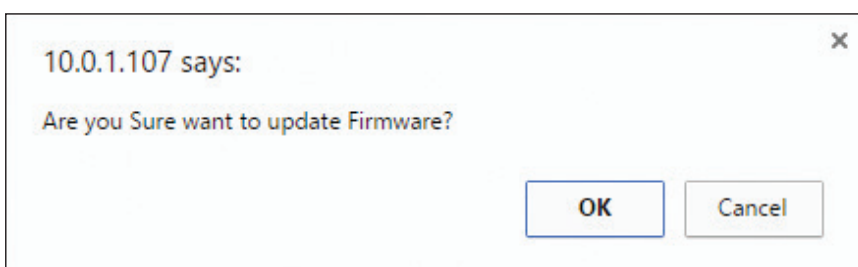

7. Click the **OK** button to begin the firmware update process. Click the **Cancel** button to cancel the process.
8. The update process will take approximately 60 seconds and will automatically reboot the AT-HD-SC-500.
9. After the firmware update process is complete, the **Login** screen will be displayed.

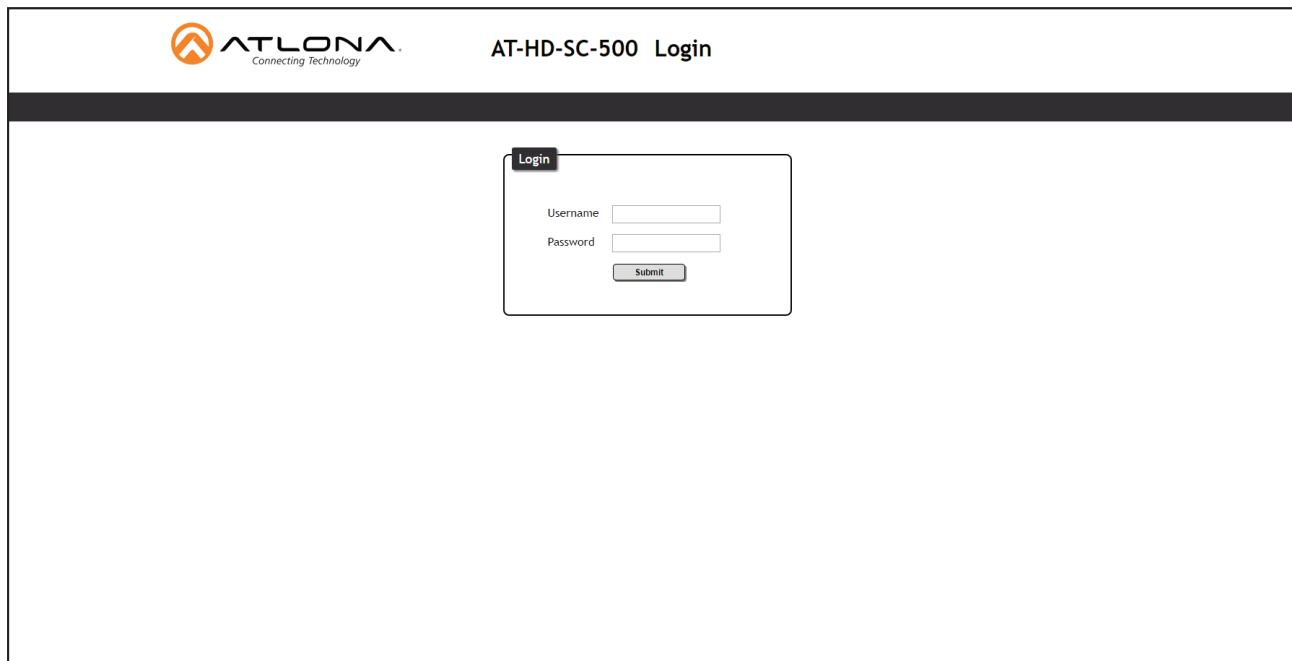

Using USB

Requirements

- AT-HD-SC-500
- Firmware file: HDSC-500-FW-[version].BIN
- Computer running Windows
- USB-A to USB mini-B cable

1. Disconnect power from the AT-HD-SC-500.
2. Connect the USB-A to USB mini-B cable from the computer to the **FW** port on the AT-HD-SC-500.

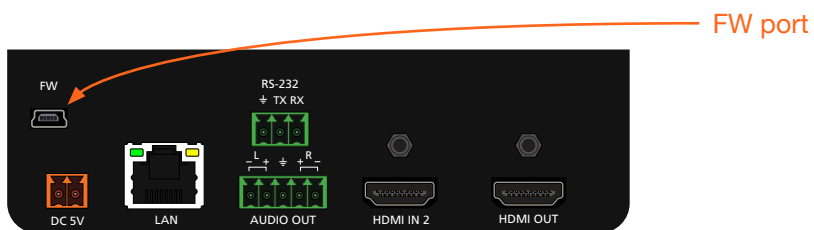

3. Press and hold the **DISPLAY** key, on the front panel, while connecting power to the AT-HD-SC-500.



- The USB UPDATE folder will be displayed.

If this folder is not displayed, automatically, select the USB UPDATE drive from Windows Explorer.

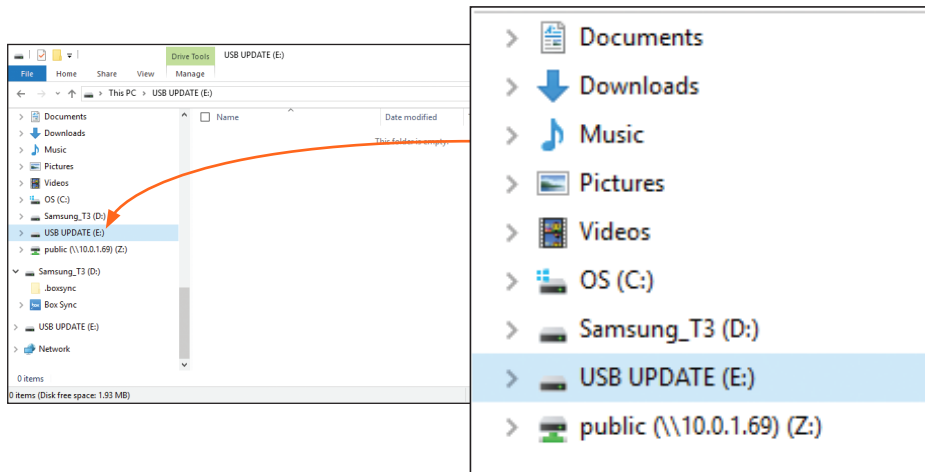

- Delete all files from the USB UPDATE drive, if any are present.
- Drag-and-drop the HDSC-500-FW-[version].BIN firmware file to the drive.
- After the file has been copied, disconnect the USB cable from both the computer and the AT-HD-SC-500.
- Power-cycle the AT-HD-SC-500 by disconnecting then reconnecting the power supply.
- The firmware update process is complete.

Mounting Instructions

The AT-HD-SC-500 includes two mounting brackets, which can be used to attach the unit to any flat surface. Use the enclosure screws, on the sides of the unit to attach the mounting brackets.

1. Using a small Phillips screwdriver, remove the four screws from the left side of the enclosure.

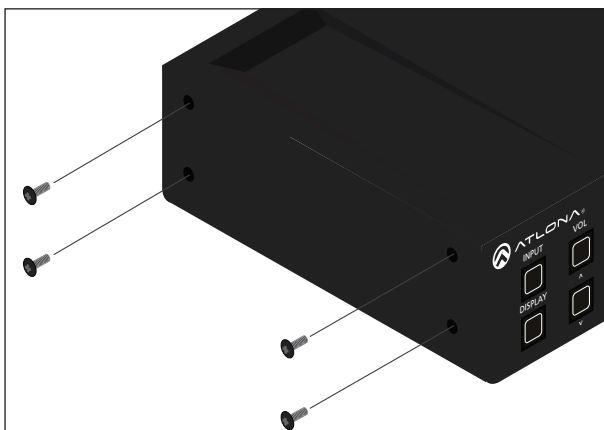

2. Position one of the mounting brackets, as shown below, aligning the holes on the side of the enclosure with one set of holes on the mounting bracket.
3. Repeat steps 1 and 2 to attach the second mounting bracket to the opposite side of the unit.
4. Mount the unit to a flat surface using the oval-shaped holes, on each mounting bracket. If using a drywall surface, a #6 drywall screw is recommended.

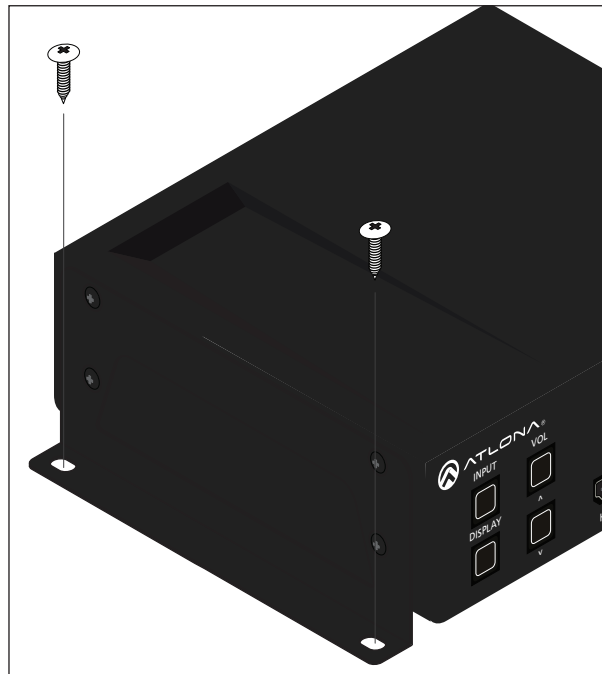

NOTE: Mounting brackets can also be inverted to mount the unit under a table or other flat surface.

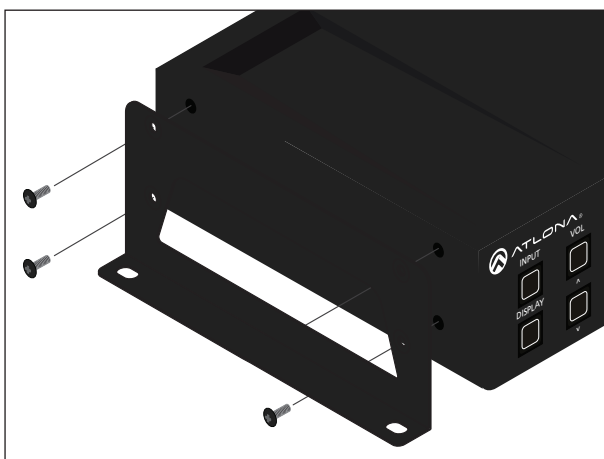

Default Settings

The following tables list the factory-default settings for the AT-HD-SC-500.

Feature	Settings	
Video	Input Selection	HDMI 1
	Auto Switch mode	ON
	Fallback Port	Previous
	Fallback Time (Sec)	5
	Output Resolution	1280x720p60
	Color Space	RGB
	Aspect	Full
	Overscan	Off
	Mirror-V	Off
	ASP Background	Grey
Audio	HDMI 1	Auto
	HDMI 2	Auto
	Mute	OFF
	HDMI Audio	On
	L/R Audio	On
	Output Volume	-10
	Output Bass	0
	Output Treble	0
Picture	Brightness	64
	Contrast	64
	Saturation	64
	Hue	64
	Sharpness	32
EDID	HDMI Preferred Timing	1280x800
	VGA Preferred Timing	1280x800
	HDMI1 HDCP	compliant
	HDMI2 HDCP	compliant
Display	Display Power On	DISABLED
	Display Power Off	DISABLED
	Power Button Lock	DISABLED
	Lamp cool down timer (sec)	0
	Display Warm Up Timer (sec)	0
	Auto Power Off Timer (sec)	15
	Control Type	RS-232
	Feedback Verify	OFF
	Display Mode	DispSW AVon
	Volume / Mute	AudOut
	IP Mode	Non-Login
	IP Address	0.0.0.0
	Port	23
	Username	root
	Password	Atlona
	Send Mode	ASCII

Feature	Settings
System	IP Mode: DHCP Static IP Address (default): 192.168.1.254 Netmask: 255.255.255.0 Gateway: 192.168.1.1 Telnet Port: 23 Telnet Login Mode: Off Telnet Timeout: 120 (seconds) Broadcast: On
RS-232	Baud Rate: 115200 Data Bit: 8 Parity: None Stop bit: 1
OSD	Position: Left-Top Transparency: 12 Info. Timer: 10 Menu Timer: 20 Info. Display: Auto Background: Grey
Network	IP Mode: DHCP IP: assigned by DHCP server Netmask: 255.255.255.0 Gateway: assigned by DHCP server Telnet Port: 23 Telnet Login Mode: Off Telnet Timeout: 120 Broadcast: On

Specifications

Video	
HD/SD Resolutions (input)	1080p@23.98/24/25/29.97/30/50/59.94/60Hz, 1080i@50/59.94/60Hz, 720p@50/59.94/60Hz, 576p, 576i, 480p, 480i, 1920×1200, 1680×1050, 1600×1200, 1600×900, 1440×900, 1400×1050, 1366×768, 1360×768, 1280×1024, 1280×800, 1280×768, 1152×864, 1024×768, 800×600, 640×480
HD/SD Resolutions (output)	1080p@23.98/24/25/29.97/30/50/59.94/60Hz, 1080i@50/59.94/60, 720p@25/29.97/30/50/59.94/60, 1920×1200, 1680×1050, 1600×1200, 1600×900, 1400×1050, 1366×768, 1280×1024, 1280×800, 1024×768, 800×600
Color Space	YUV, RGB
Chroma Subsampling	4:4:4, 4:2:2
Color Depth	8-bit, 10-bit, 12-bit

Audio	
Analog In	3.5mm stereo jack, -10 dBu nominal input
Analog Out	Balanced, +4 dBu nominal analog output. Max output +18 dBu (only from 2Ch PCM sources)
HDMI IN / OUT	PCM 2Ch, LPCM 5.1, LPCM 7.1, Dolby® Digital, Dolby Digital Plus, Dolby TrueHD, DTS® 5.1, DTS-HD Master Audio™, DTS:X™, Dolby Atmos®
Sample Rate	32 kHz, 44.1 kHz, 48 kHz, 88.2 kHz, 96 kHz, 176.4 kHz, 192 kHz
Bit Rate	24-bit (max.)

Resolution / Distance	Feet	Meters
HDMI IN/OUT @ 1080p	30	10

Signal	
Bandwidth	6.75 Gbps
CEC	Yes
HDCP	Switchable – Compliant/Non-compliant

Temperature	Fahrenheit	Celsius
Operating	32 to 122	0 to 50
Storage	-4 to 140	-20 to 60
Humidity (RH)	20% to 90%, non-condensing	

Power	
Consumption	10.4 W
Supply	Input: 100 - 240 V AC, 50/60 Hz Output: 5 V DC, 3.6 A

Dimensions	Inches	Millimeters
H x W x D	1.5 x 5 x 4.02	38 x 127 x 102

Weight	Pounds	Kilograms
Unit	0.60	0.27

Certification	
Power Supply	CE, TUV, RCM, RoHS, FCC
Product	CE, FCC

Index

- A**
- Aspect ratio** 22, 36
- Audio**
 - embedding 24
 - muting 37, 79
 - passing analog audio 17
 - settings 23
- Auto switching** 17
- B**
- Bass**
 - adjusting 37
- Brightness** 21, 38
- C**
- CEC**
 - compatibility 27
 - ON/OFF 40
- Color space** 21, 36
- Commands**
 - AnaGain 52
 - ASPBGRND 52
 - Aspect 52
 - ASwOutTime 53
 - ASwPrePort 53
 - AudioSrc 53
 - AutoDispOff 54
 - AutoDispOn 54
 - AutoPwrMode 54
 - AutoSW 55
 - Bass 55
 - Broadcast 55
 - BRT 56
 - BTNVol 56
 - CliIPAddr 56
 - CliMode 57
 - CliPass 57
 - CliPort 57
 - CliUser 58
 - CMDFMT 58
 - CSpa 58
 - CtrlType 59
 - CTRST 59
 - DispBtn 60
 - DisWarmUp 59, 60
 - Down 60
 - HDCPSet1 60
 - HDCPSet2 61
 - HDMIAUD 61
 - Help 61
 - HUE 62
 - HZoom 62
 - INFOOSD 62
 - INFOTMR 63
 - Input 63
 - IPAddUser 63
 - IPCFG 64
 - IPDelUser 64
 - IPDHCP 64
 - IPLogin 65
 - IPPort 65
 - IPQuit 65
 - IPStatic 66
 - IPTimeout 66
 - LampCool 66
 - Lock 67
 - LRAUD 67
 - MENUTMR 67
 - MirrorV 68
 - Mreset 68
 - OSD 68
 - OSDAAlpha 69
 - OSDBGRND 69
 - PicReset 69
 - PTIMGHDMI 70
 - PTIMGVGA 70
 - PWLock 70
 - QOSD 71
 - RAtIMac 71
 - SATRT 71
 - Select 72
 - SetCmd 72
 - SetCmdFB 72
 - SetCS 73
 - SetEnd 73
 - SetOff 73
 - SHARP 74
 - System 74
 - Treble 75
 - TrigCEC 75
 - TrigIP 75
 - TrigRS 76
 - UARTPara 76
 - Unlock 76
 - Up 77
 - Version 77
 - VGAAuto 77
 - VidOutRes 78
 - VOUT1 78
 - VOUTMute1 79
 - VOUTOSD 79
 - VZoom 79
 - x1\$ 80
 - Zoom 80
- Configuration**
 - IP. See IP configuration
- Connection**
 - diagram 11
 - instructions 11
- Contents**
 - package 9
- Contrast** 21, 38, 59
- Customer support** 3
- D**
- Default settings** 85
- DHCP** 31, 47, 64
- Display volume**
 - adjusting 16
- F**
- FCC statement** 6
- Features** 9
- Firmware**
 - updating 81
- G**
- Gateway** 47
- H**
- HDCP**
 - settings 39
- Hue** 21, 38, 62
- I**
- Information**
 - displaying 30
- Input**
 - selecting 16, 20
- Installation** 11
- IP address**
 - default 31, 66
- IP configuration**
 - using commands 14
 - using the front panel 14
 - using the web GUI 15
- M**
- Mounting instructions** 84
- Muting**
 - audio 37, 79
- O**
- Operating notes** 3
- OSD**
 - displaying 19
 - settings 25

Output volume

adjusting 78

Overscan

adjusting 23, 36, 79, 80

P**Password**

setting 46

Preferred timing

HDMI 39

Picture

settings 21

Power

connector 11

Preferred timing

VGA 39

R**Reset**

factory-default 47, 68

Resolution

input 20

output 21, 36, 78

RS-232

baud rate 44

data bits 44

parity bit 44

stop bit 44

S**Safety information 6****Saturation 21, 38****Sharpness 38, 74****Specifications 87****Static IP 31, 47, 66****Subnet mask 47****Switching**

auto 17, 35

T**Telnet**

listening port 47

login mode 47

timeout 47

Timer

auto power-off 41

display warm-up 41

lamp cool down 41

Treble

adjusting 37

U**Users**

adding 46, 63

editing 46

removing 46, 64

V**VGA**

signal adjustment 35

Volume

adjusting 16, 78

output, adjusting 37

W**Warranty 4**

