



# Cisco 1.25 GHz Flexible Solutions Tap (FST) with Power Distribution Port

## Installation and Operation Guide









# For Your Safety

## Explanation of Warning and Caution Icons

Avoid personal injury and product damage! Do not proceed beyond any symbol until you fully understand the indicated conditions.

The following warning and caution icons alert you to important information about the safe operation of this product:

-  You may find this symbol in the document that accompanies this product. This symbol indicates important operating or maintenance instructions.
-  You may find this symbol affixed to the product. This symbol indicates a live terminal where a dangerous voltage may be present; the tip of the flash points to the terminal device.
-  You may find this symbol affixed to the product. This symbol indicates a protective ground terminal.
-  You may find this symbol affixed to the product. This symbol indicates a chassis terminal (normally used for equipotential bonding).
-  You may find this symbol affixed to the product. This symbol warns of a potentially hot surface.
-  You may find this symbol affixed to the product and in this document. This symbol indicates an infrared laser that transmits intensity-modulated light and emits invisible laser radiation or an LED that transmits intensity-modulated light.

## Important

Please read this entire guide. If this guide provides installation or operation instructions, give particular attention to all safety statements included in this guide.

# Notices

## Trademark Acknowledgments

Cisco and the Cisco logo are trademarks or registered trademarks of Cisco and/or its affiliates in the U.S. and other countries. A listing of Cisco's trademarks can be found at <http://www.cisco.com/go/trademarks>.

Third party trademarks mentioned are the property of their respective owners.

The use of the word partner does not imply a partnership relationship between Cisco and any other company. (1009R)

## Publication Disclaimer

Cisco Systems, Inc. assumes no responsibility for errors or omissions that may appear in this publication. We reserve the right to change this publication at any time without notice. This document is not to be construed as conferring by implication, estoppel, or otherwise any license or right under any copyright or patent, whether or not the use of any information in this document employs an invention claimed in any existing or later issued patent.

## Copyright

© 2007, 2008, 2012, 2014, 2016 Cisco and/or its affiliates. All rights reserved. Printed in the United States of America.

Information in this publication is subject to change without notice. No part of this publication may be reproduced or transmitted in any form, by photocopy, microfilm, xerography, or any other means, or incorporated into any information retrieval system, electronic or mechanical, for any purpose, without the express permission of Cisco Systems, Inc.

# Contents

<b>Important Safety Instructions</b>	<b>v</b>
<b>Introducing the FST with Power Distribution Port</b>	<b>1</b>
Description of the FST with Power Distribution Port.....	3
Features .....	3
2/4/8-way FST with Power Distribution Port Full Profile Housing.....	4
2/4/8-Way Tap Dimensions .....	4
2/4/8-way FST with Power Distribution Port Full Profile Faceplate .....	5
Optional Modules .....	6
Reverse Attenuator .....	6
Inverse Equalizer .....	7
Forward Equalizer .....	8
<b>Installing the Tap</b>	<b>9</b>
Tools and Torque Specifications .....	10
Tools Required .....	10
Torque Specifications .....	10
Torque Sequence .....	11
Preparing for Installation.....	12
To Prepare the Connectors .....	13
Removing the Faceplate.....	14
To Remove the Faceplate.....	14
To Remove a Faceplate with Feeder Cables Connected (Hot Install) .....	15
Installing the Tap Housing on a Strand.....	17
To Install the Tap Housing on a Strand.....	17
Installing the Tap Housing in a Pedestal.....	19
To Install the Tap Housing in a Pedestal.....	19
Mounting the Faceplate .....	21
To Mount the Faceplate.....	21
Installing the Optional Modules.....	24
To Install the Optional Modules.....	24
<b>Customer Support Information</b>	<b>26</b>
<b>Appendix A Technical Information</b>	<b>27</b>
Specifications.....	28
2/4/8-Way Tap Dimensions .....	28
Electrical Specifications.....	28
AC/RF Bypass Switch Performance .....	28

## Contents

Standards Compliance .....	29
Part Numbers .....	30
FST with Power Distribution Port Full Profile Taps .....	30
FST with Power Distribution Port Full Profile Faceplates .....	31
Reverse Attenuator Plug-ins .....	31
Forward Equalizer Plug-ins .....	32
Equalizer Plug-ins .....	33

## Index

35

# Important Safety Instructions

## Read and Retain Instructions

Carefully read all safety and operating instructions before operating this equipment, and retain them for future reference.

## Follow Instructions and Heed Warnings

Follow all operating and use instructions. Pay attention to all warnings and cautions in the operating instructions, as well as those that are affixed to this equipment.

## Terminology

The terms defined below are used in this document. The definitions given are based on those found in safety standards.

**Service Personnel** - The term *service personnel* applies to trained and qualified individuals who are allowed to install, replace, or service electrical equipment. The service personnel are expected to use their experience and technical skills to avoid possible injury to themselves and others due to hazards that exist in service and restricted access areas.

**User and Operator** - The terms *user* and *operator* apply to persons other than service personnel.

**Ground(ing) and Earth(ing)** - The terms *ground(ing)* and *earth(ing)* are synonymous. This document uses *ground(ing)* for clarity, but it can be interpreted as having the same meaning as *earth(ing)*.

## Electric Shock Hazard

This equipment meets applicable safety standards.



**WARNING:**

**To reduce risk of electric shock, perform only the instructions that are included in the operating instructions. Refer all servicing to qualified service personnel only.**

Electric shock can cause personal injury or even death. Avoid direct contact with dangerous voltages at all times.

Know the following safety warnings and guidelines:

- Only qualified service personnel are allowed to perform equipment installation or replacement.
- Only qualified service personnel are allowed to remove chassis covers and access any of the components inside the chassis.

## Equipment Placement



**WARNING:**

**Avoid personal injury and damage to this equipment. An unstable mounting surface may cause this equipment to fall.**

To protect against equipment damage or injury to personnel, comply with the following:

- Install this equipment in a restricted access location (access restricted to service personnel).
- Make sure the mounting surface or rack is stable and can support the size and weight of this equipment.

## Strand (Aerial) Installation



**CAUTION:**

**Be aware of the size and weight of strand-mounted equipment during the installation operation.**

**Ensure that the strand can safely support the equipment's weight.**

## Pedestal, Service Closet, Equipment Room or Underground Vault Installation



**WARNING:**

**Avoid the possibility of personal injury. Ensure proper handling/lifting techniques are employed when working in confined spaces with heavy equipment.**

- Ensure this equipment is securely fastened to the mounting surface or rack where necessary to protect against damage due to any disturbance and subsequent fall.
- Ensure the mounting surface or rack is appropriately anchored according to manufacturer's specifications.
- Ensure the installation site meets the ventilation requirements given in the equipment's data sheet to avoid the possibility of equipment overheating.
- Ensure the installation site and operating environment is compatible with the equipment's International Protection (IP) rating specified in the equipment's data sheet.

## Connecting to Utility AC Power

**Important:** If this equipment is a Class I equipment, it must be grounded.

- If this equipment plugs into an outlet, the outlet must be near this equipment, and must be easily accessible.



- Connect this equipment only to the power sources that are identified on the equipment-rating label, which is normally located close to the power inlet connector(s).
- This equipment may have two power sources. Be sure to disconnect all power sources before working on this equipment.
- If this equipment **does not** have a main power switch, the power cord connector serves as the disconnect device.
- Always pull on the plug or the connector to disconnect a cable. Never pull on the cable itself.

## Connection to Network Power Sources

Refer to this equipment's specific installation instructions in this manual or in companion manuals in this series for connection to network ferro-resonant AC power sources.

## AC Power Shunts

AC power shunts may be provided with this equipment.

**Important:** The power shunts (where provided) must be removed before installing modules into a powered housing. With the shunts removed, power surge to the components and RF-connectors is reduced.



**CAUTION:**

RF connectors and housing seizure assemblies can be damaged if shunts are not removed from the equipment before installing or removing modules from the housing.

## Grounding (Utility AC Powered Equipment in Pedestals, Service Closets, etc.)

This section provides instructions for verifying that the equipment is properly grounded.

### Safety Plugs (USA Only)

This equipment is equipped with either a 3-terminal (grounding-type) safety plug or a 2-terminal (polarized) safety plug. The wide blade or the third terminal is provided for safety. Do not defeat the safety purpose of the grounding-type or polarized safety plug.

To properly ground this equipment, follow these safety guidelines:

- **Grounding-Type Plug** - For a 3-terminal plug (one terminal on this plug is a protective grounding pin), insert the plug into a grounded mains, 3-terminal outlet.

**Note:** This plug fits only one way. If this plug cannot be fully inserted into the outlet, contact an electrician to replace the obsolete 3-terminal outlet.

## Important Safety Instructions

- **Polarized Plug** - For a 2-terminal plug (a polarized plug with one wide blade and one narrow blade), insert the plug into a polarized mains, 2-terminal outlet in which one socket is wider than the other.

**Note:** If this plug cannot be fully inserted into the outlet, try reversing the plug. If the plug still fails to fit, contact an electrician to replace the obsolete 2-terminal outlet.

### Grounding Terminal

If this equipment is equipped with an external grounding terminal, attach one end of an 18-gauge wire (or larger) to the grounding terminal; then, attach the other end of the wire to a ground, such as a grounded equipment rack.

### Safety Plugs (European Union)

- **Class I Mains Powered Equipment** – Provided with a 3-terminal AC inlet and requires connection to a 3-terminal mains supply outlet via a 3-terminal power cord for proper connection to the protective ground.  
**Note:** The equipotential bonding terminal provided on some equipment is not designed to function as a protective ground connection.
- **Class II Mains Powered Equipment** – Provided with a 2-terminal AC inlet that may be connected by a 2-terminal power cord to the mains supply outlet. No connection to the protective ground is required as this class of equipment is provided with double or reinforced and/or supplementary insulation in addition to the basic insulation provided in Class I equipment.  
**Note:** Class II equipment, which is subject to EN 50083-1, is provided with a chassis mounted equipotential bonding terminal. See the section titled **Equipotential Bonding** for connection instructions.

## Equipotential Bonding

If this equipment is equipped with an external chassis terminal marked with the IEC 60417-5020 chassis icon () , the installer should refer to CENELEC standard EN 50083-1 or IEC standard IEC 60728-11 for correct equipotential bonding connection instructions.

## General Servicing Precautions



### WARNING:

Avoid electric shock! Opening or removing this equipment's cover may expose you to dangerous voltages.



### CAUTION:

These servicing precautions are for the guidance of qualified service personnel only. To reduce the risk of electric shock, do not perform any servicing other than that contained in the operating instructions unless you are qualified to do so. Refer all servicing to qualified service personnel.

Be aware of the following general precautions and guidelines:

- **Servicing** - Servicing is required when this equipment has been damaged in any way, such as power supply cord or plug is damaged, liquid has been spilled or objects have fallen into this equipment, this equipment has been exposed to rain or moisture, does not operate normally, or has been dropped.
- **Wristwatch and Jewelry** - For personal safety and to avoid damage of this equipment during service and repair, do not wear electrically conducting objects such as a wristwatch or jewelry.
- **Lightning** - Do not work on this equipment, or connect or disconnect cables, during periods of lightning.
- **Labels** - Do not remove any warning labels. Replace damaged or illegible warning labels with new ones.
- **Covers** - Do not open the cover of this equipment and attempt service unless instructed to do so in the instructions. Refer all servicing to qualified service personnel only.
- **Moisture** - Do not allow moisture to enter this equipment.
- **Cleaning** - Use a damp cloth for cleaning.
- **Safety Checks** - After service, assemble this equipment and perform safety checks to ensure it is safe to use before putting it back into operation.

## Electrostatic Discharge

Electrostatic discharge (ESD) results from the static electricity buildup on the human body and other objects. This static discharge can degrade components and cause failures.

Take the following precautions against electrostatic discharge:

- Use an anti-static bench mat and a wrist strap or ankle strap designed to safely ground ESD potentials through a resistive element.
- Keep components in their anti-static packaging until installed.
- Avoid touching electronic components when installing a module.

## Fuse Replacement

To replace a fuse, comply with the following:

- Disconnect the power before changing fuses.
- Identify and clear the condition that caused the original fuse failure.
- Always use a fuse of the correct type and rating. The correct type and rating are indicated on this equipment.

## Important Safety Instructions

### Batteries

This product may contain batteries. Special instructions apply regarding the safe use and disposal of batteries:

#### Safety

- Insert batteries correctly. There may be a risk of explosion if the batteries are incorrectly inserted.
- Do not attempt to recharge 'disposable' or 'non-reusable' batteries.
- Please follow instructions provided for charging 'rechargeable' batteries.
- Replace batteries with the same or equivalent type recommended by manufacturer.
- Do not expose batteries to temperatures above 100°C (212°F).

#### Disposal

- The batteries may contain substances that could be harmful to the environment
- Recycle or dispose of batteries in accordance with the battery manufacturer's instructions and local/national disposal and recycling regulations.



廢電池請回收

- The batteries may contain perchlorate, a known hazardous substance, so special handling and disposal of this product might be necessary. For more information about perchlorate and best management practices for perchlorate-containing substance, see <http://www.dtsc.ca.gov/hazardouswaste/perchlorate>.

### Modifications

This equipment has been designed and tested to comply with applicable safety, laser safety, and EMC regulations, codes, and standards to ensure safe operation in its intended environment. Refer to this equipment's data sheet for details about regulatory compliance approvals.

Do not make modifications to this equipment. Any changes or modifications could void the user's authority to operate this equipment.

Modifications have the potential to degrade the level of protection built into this equipment, putting people and property at risk of injury or damage. Those persons making any modifications expose themselves to the penalties arising from proven non-compliance with regulatory requirements and to civil litigation for compensation in respect of consequential damages or injury.

### Accessories

Use only attachments or accessories specified by the manufacturer.

## Electromagnetic Compatibility Regulatory Requirements

This equipment meets applicable electromagnetic compatibility (EMC) regulatory requirements. Refer to this equipment's data sheet for details about regulatory compliance approvals. EMC performance is dependent upon the use of correctly shielded cables of good quality for all external connections, except the power source, when installing this equipment.

- Ensure compliance with cable/connector specifications and associated installation instructions where given elsewhere in this manual.

## EMC Compliance Statements

Where this equipment is subject to USA FCC and/or Industry Canada rules, the following statements apply:

### **FCC Statement for Class A Equipment**

This equipment has been tested and found to comply with the limits for a Class A digital device, pursuant to Part 15 of the FCC Rules. These limits are designed to provide reasonable protection against harmful interference when this equipment is operated in a commercial environment.

This equipment generates, uses, and can radiate radio frequency energy and, if not installed and used in accordance with the instruction manual, may cause harmful interference to radio communications. Operation of this equipment in a residential area is likely to cause harmful interference in which case users will be required to correct the interference at their own expense.

### **Industry Canada - Industrie Canadienne Statement**

This apparatus complies with Canadian ICES-003.  
Cet appareil est conforme à la norme NMB-003 du Canada.

### **CENELEC/CISPR Statement with Respect to Class A Information Technology Equipment**

This is a Class A equipment. In a domestic environment this equipment may cause radio interference in which case the user may be required to take adequate measures.



# 1

## Introducing the FST with Power Distribution Port

### Introduction to This Document

This guide provides the procedures for installing the Cisco FST with Power Distribution Port.

### Who Should Use This Document

This document is intended for authorized personnel who have experience working with similar equipment. The personnel should have appropriate background and knowledge to complete the procedures described in this document. Service engineers who help system operators manage their systems will also find the contents of this document useful.

### Qualified Personnel

Only appropriately qualified and skilled personnel should attempt to install, operate, maintain, and service this product.



**WARNING:**

**Allow only qualified and skilled personnel to install, operate, maintain, and service this product. Otherwise, personal injury or equipment damage may occur.**

### Scope

This guide discusses the following topics.

- Installing the tap on a strand
- Installing the tap in a pedestal
- Mounting the faceplate
- Installing the optional modules in the tap

# In This Chapter

- Description of the FST with Power Distribution Port ..... 3
- 2/4/8-way FST with Power Distribution Port Full Profile Housing ..... 4
- 2/4/8-way FST with Power Distribution Port Full Profile Faceplate ..... 5
- Optional Modules ..... 6



## Description of the FST with Power Distribution Port

The FST with Power Distribution Port provides all of the features and plug-in of the 1.25 GHz FST with the additional feature of providing a tap port which passes 1.5A of power down the drop connected to that port. This power passing port enables the powering and signal path for additional network devices such as wireless radios.

### Features

The FST with Power Distribution Port faceplate and housing is similar in form, fit, and function to traditional tap. However, the FST with Power Distribution Port offers a variety of enhanced features essential to the successful delivery of telephony and other advanced services.

The following are the features of the tap.

- Optional Reverse Attenuator (RA) plug-in modules that provide more loss in the reverse spectrum
- Optional Inverse Equalizer (IEQ) plug-in modules (cable sim) that offer flexibility in the reverse path design
- Optional Forward Equalizer (EQ) plug-in modules that offer flexibility in the forward path design
- 1.5 amp current distribution through a safe and easily identifiable tap port
- Available in 2-,4-, and 8 way full profile versions
- Rugged design enables the products to continue to operate after surges
- 6 kV surge protection provides significantly improved protection against voltage transients in lightning strike areas and locations with unreliable power networks
- 12 amp through current rating
- Improved return loss performance
- AC/RF bypass switch provides interruption-free service to rest of network during faceplate removal
- Backwards compatible housing supports economical faceplate upgrades
- AL360T housing with powder coating for superior environmental protection
- Sealed and swaged extended F-ports for maximum resistance to moisture ingress
- Nickel plated brass F-ports to ensure a corrosion-resistant drop interface
- Component covers for additional protection of faceplate circuitry during maintenance

## 2/4/8-way FST with Power Distribution Port Full Profile Housing

The following illustration shows the 2/4/8-way FST with Power Distribution Port full profile housing.

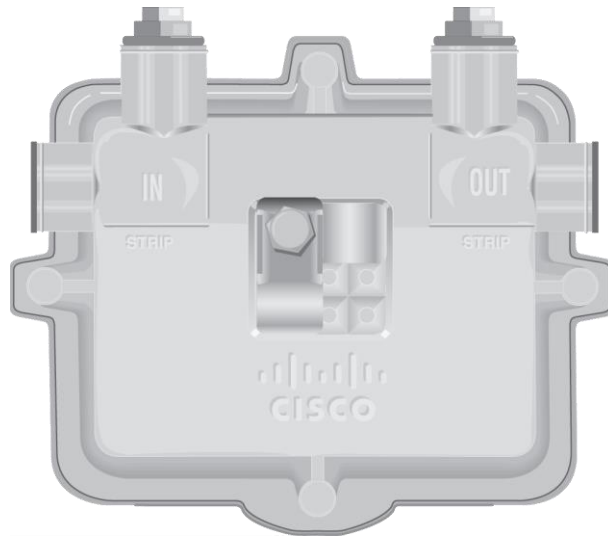

### 2/4/8-Way Tap Dimensions

Item	Specification
Height	4.45 in. (113.0 mm)
Width	5.5 in. (139.75 mm)
Depth	3.0 in. (76.2 mm)

## 2/4/8-way FST with Power Distribution Port Full Profile Faceplate

The following illustration shows the 2/4/8-way FST with Power Distribution Port full profile faceplate installed on the housing. The power distribution port is clearly identified with the different colored tap port insulating boot.

2-Way Full Profile Tap

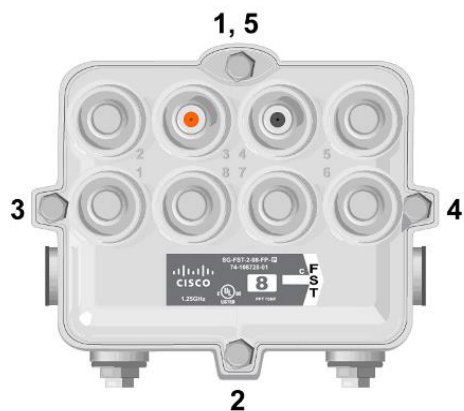

4-Way Full Profile Tap

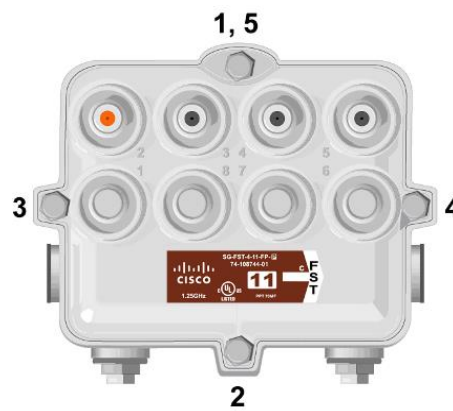

8-Way Full Profile Tap

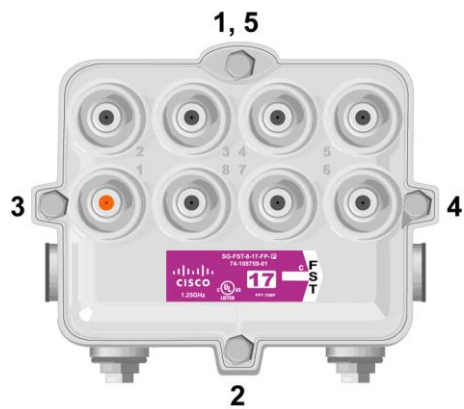

## Optional Modules

The tap accepts three types of optional plug-in modules:

- Reverse Attenuator (RA) plug-in modules are available in 0, 3, 6, 9, and 12 dB values. These plug-in modules are used to increase the reverse path tap loss without significantly affecting forward tap loss. By selectively adding reverse attenuation to taps of middle to lower value, reverse path tap losses can be made more similar across the various values of taps used in an HFC network.
- Inverse Equalizer (IEQ) modules are available in 3, 6, 9, 12, and 15 dB values. These plug-in modules are used to increase the forward path tap loss in a down-tilted fashion, with greater loss at higher frequencies than lower frequencies, without significantly affecting reverse tap loss. IEQ plug-in modules allow optimization of tap output levels at tap locations closest to nodes and amplifiers with high-level forward RF signals and significant up-tilt.
- Forward Equalizer (EQ) modules are available in 3, 6, 9, 12, and 15 dB values. These plug-in modules are used to increase the forward path tap loss in a standard cable-tilted fashion, with greater loss at lower frequencies than higher frequencies. The EQ plug-in modules allow optimization of tap output levels at tap locations near the end of the feeder line.

**Note:** For help in selecting plug-in modules, see *Flexible Solutions Taps Data Sheet* for tables showing tap loss increase by frequency for each module.





### Reverse Attenuator













The Reverse Attenuator is a plug-in that can be installed in the field. For details, see *Installing the Optional Modules* (on page 24).

Four types of split are available:

- 42/54 MHz
- 65/86 MHz
- 85/102 MHz
- 204/258 MHz

RA modules are labeled as shown in the following table.











Value	42/54 MHz Split	65/86 MHz Split	85/102 MHz Split	204/258 MHz Split	Color
3 dB					Red

Value	42/54 MHz Split	65/86 MHz Split	85/102 MHz Split	204/258 MHz Split	Color
6 dB					Red
9 dB					Red
12 dB					Red

## Inverse Equalizer

The Inverse EQ is a plug-in module that can be installed in the field. For details, see *Installing the Optional Modules* (on page 245).





Inverse EQ modules are labeled as shown in the following table.

Value	Label	Value	Label	Value	Label	Color
2 dB		8 dB		15 dB		Blue
3 dB		9 dB		18 dB		Blue
4 dB		10 dB		21 dB		Blue
6 dB		12 dB				Blue

## Forward Equalizer

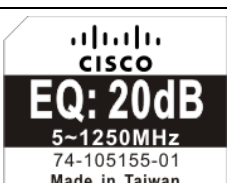
The Forward EQ is a plug-in module that can be installed in the field. For details, see *Installing the Optional Modules* (on page 245).

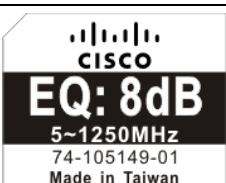
Forward EQ modules are labeled as shown in the following table.

Value	Label	Value	Label	Value	Label	Color
2 dB		9 dB		16 dB		Black
3 dB		10 dB		18 dB		Black
4 dB		12 dB		20 dB		Black
6 dB		14 dB		22 dB		Black
8 dB		15 dB				Black

# 2

---

## Installing the Tap

This chapter gives step-by-step instructions for installing the tap in your cable system.

### In This Chapter

■ Tools and Torque Specifications .....	10
■ Preparing for Installation.....	12
■ Removing the Faceplate.....	14
■ Installing the Tap Housing on a Strand.....	17
■ Installing the Tap Housing in a Pedestal.....	19
■ Mounting the Faceplate .....	21
■ Installing the Optional Modules.....	24

## Tools and Torque Specifications

### Tools Required

Before you start, make sure you have the following tools.

Tools	Used to . . .
Appropriate coaxial cable coring tool	Prepare feeder cable ends
3/8-in. hex wrench, or nut driver	Tighten strand clamp bolts and retainer bolts
1/2-in. or 3/8-in. wrench, or nut driver	Remove and replace cable end plugs
3/16-in. hex nut driver	Tighten seizure screws
Small flat-end screwdriver	Rotate seizure mechanism
Propane torch, or equivalent	Apply heat shrink
Wire cutters	Cut cable/center conductor
Sharp knife	Trim
Torque wrench in in-lb (0 in-lb to 250 in-lb minimum) (0 Nm to 28.2 Nm minimum)	Tighten seizure screws, connectors, and retainer bolts
7/16-in. wrench	Tighten house drop F-connector
15/16-in., 1-in., and 1 1/8-in. wrenches	Tighten connectors for feeder cable Sizes may vary depending on manufacturer and connector style.
Grounding wire assembly, part number 569533 (hot install only)	Prevent electric shock and equipment damage. Certain components can deliver an electrical shock
Room temperature vulcanizing (RTV) silicone	Seal connections

### Torque Specifications

The following are recommended torque specifications for the tap.

Part	Torque Specification
Strand clamp bolt	30 in-lb to 40 in-lb (3.4 Nm to 4.5 Nm)
KS-connector	Tighten according to manufacturer's recommended torque specification, typically 15 ft-lb to 25 ft-lb (20.3 Nm to 33.9 Nm), but not to exceed 60 ft-lb (81.3 Nm)



Part	Torque Specification
Port end plug	30 in-lb to 40 in-lb (3.4 Nm to 4.5 Nm)
Seizure screw	15 in-lb to 20 in-lb (1.7 Nm to 2.3 Nm)
Faceplate bolt	50 in-lb to 60 in-lb (5.6 Nm to 6.8 Nm)
F-connector (drop cable) RG-6 or RG-59	Tighten to manufacturer's recommended torque specification

## Torque Sequence

The following diagrams show the proper torque sequence for closing the housing.

2-Way Full Profile Tap



4-Way Full Profile Tap



8-Way Full Profile Tap

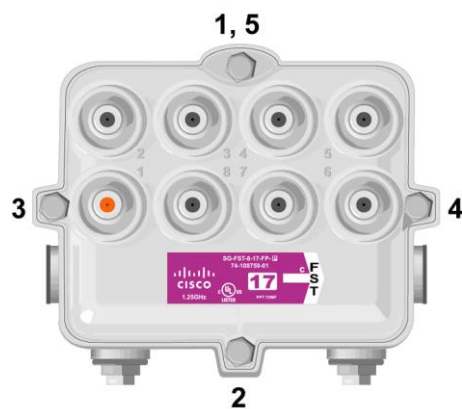

## Preparing for Installation

Be aware of the following notes when installing the tap.

- The tap requires a surge protector device (SPD) or listed surge arrester as part of the installation to address transient overvoltage exceeding Overvoltage Category II, 2500 Vpk.
- The tap must be grounded. The ground wire must be connected to the strand clamp. The minimum ground wire size is between 1/4" to 5/16".
- The tap drop cable (TV signal) must be connected to a grounded surge protector box at the building entrance. The overvoltage/overcurrent protection box is mandatory at the house entrance. Select the defined overvoltage/overcurrent as per the national rules.
- The tap drop cable shield must also be connected to ground at the building entrance.
- The tap must be powered by the service provider power supply including reinforced insulation between the mains input of that service provider power supply and 60 to 90VAC output.
- The tap power input and output wire gauge cannot be less than 18AWG.
- The tap drop cable must be connect at the house entrance first and then to the equipment output.
- Ensure that the power sources of either line that are to be connected are not powered.
- The IP rating of the tap is IP68.
- KS connector is used on input and output port, F connector is used on other ports. For all the connectors, the minimum IP rating must be the same IP rating of the tap or better.

Complete the following tasks before installing the tap housing.

- Prepare the connectors
- Remove the faceplate

**Important:** The installer should review and install this product per EN 50083-1/A2:1998.



**CAUTION:**

To reduce the risk of fire, use only 26 AWG or larger (e.g, 24 AWG) UL listed or CSA certified telecommunication line cord.

## To Prepare the Connectors

The tap requires KS-connectors for input and output connections. You must trim the pins to the correct length before inserting them into the housing. Follow these steps to prepare the connector.



**WARNING:**

**Avoid electrical shock and damage to this product. If AC is present on the cable, take care to avoid electrocution or short circuits when cutting the cable.**

- 1 Cut the cable to allow proper entry into the port while also allowing for expansion hoops in strand installations.
- 2 Prepare the cable ends per the cable manufacturer's recommended method.
- 3 Place the connector above the entry port so that it lines up with its installed position.
- 4 If the pin extends beyond the stripline on the housing, use wire cutters to trim the pin flush to the stripline. See the diagram below for a visual guide.



**WARNING:**

**Avoid electrical shock and damage to this product. If AC is present on the cable, take care to avoid electrocution or short circuits when cutting the cable.**

**Important:** If the pin does not reach the stripline on the housing, inadequate electrical connection to the tap may occur, causing loss of signal to all downstream subscribers.



**CAUTION:**

**Always ensure that the length of the center conductor pin is accurate. Excessive length could damage the connection beam housing and cause performance problems in the unit.**

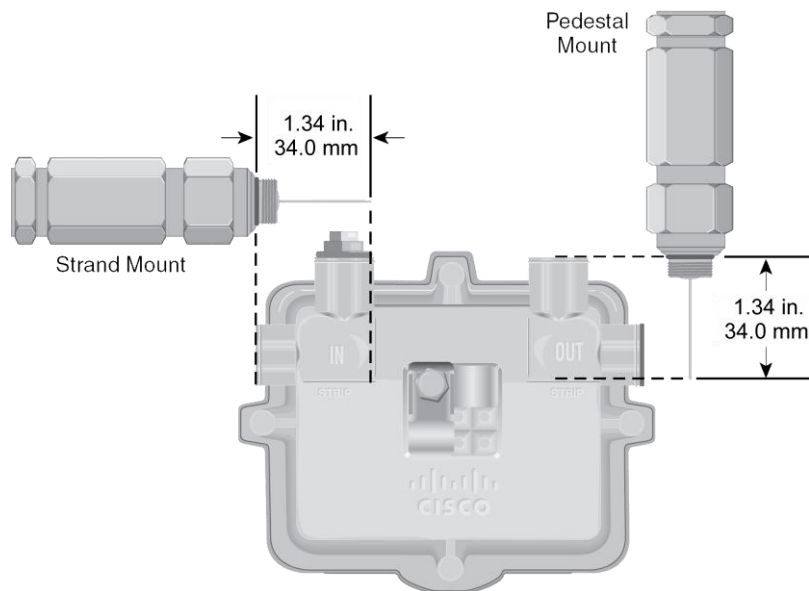

## Removing the Faceplate

The complete FST with Power Distribution Port assembly consists of a housing and a faceplate.



**WARNING:**

When removing the faceplate with the feeder cables attached, take care to protect yourself from electrical shock and your equipment from damage. Certain components can deliver an electrical shock.

If the faceplate needs to be removed with the feeder cables connected, refer to the procedure *To Remove a Faceplate with Feeder Cables Connected (Hot Install)* (on page 15).

### To Remove the Faceplate

Follow these steps to remove the tap faceplate from the housing.

- 1 Using a 3/8-in wrench, loosen all faceplate bolts as shown in the 8-way tap diagram below.

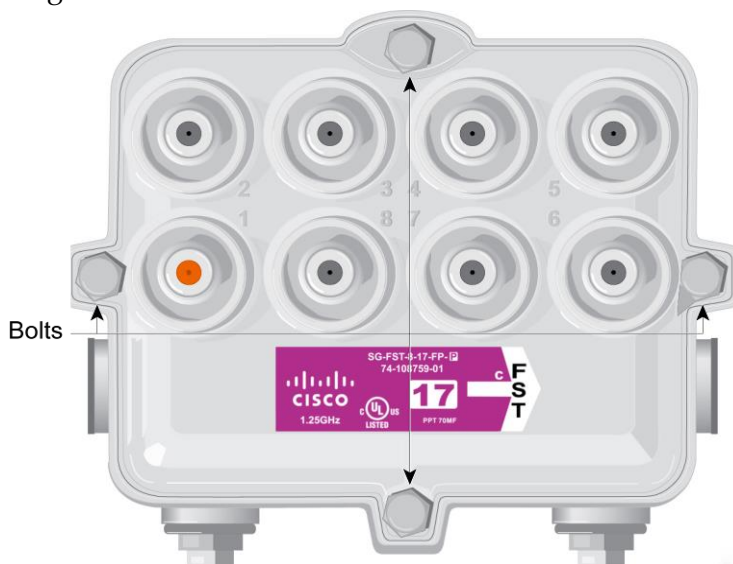

- 2 Pull the faceplate straight out from the housing. You need to use a small amount of force to pull the faceplate out.



**CAUTION:**

Handle the faceplate with care to avoid damage to the circuitry mounted to the rear of the faceplate.

- 3 Place the faceplate in a small box or on a block of foam to protect the tap circuitry. Set the faceplate in a secure place.
- 4 Proceed to *Installing the Tap Housing on a Strand* (on page 17) or *Installing the Tap Housing in a Pedestal* (on page 1719).

## To Remove a Faceplate with Feeder Cables Connected (Hot Install)

Follow these steps to remove a faceplate with feeder cables already connected to the housing.

- 1 Remove all coax drop cables from the drop port F-connectors.
- 2 Using a 3/8-in. wrench, loosen all faceplate bolts.
- 3 If the housing is installed on a strand, go to step 4.  
If the housing is installed on a pedestal, go to step 5.



**WARNING:**

Protect yourself from electric shock and your equipment from damage. Certain components can deliver an electrical shock.

- 4 Attach a grounding wire assembly to the strand wire and a drop port F-connector.

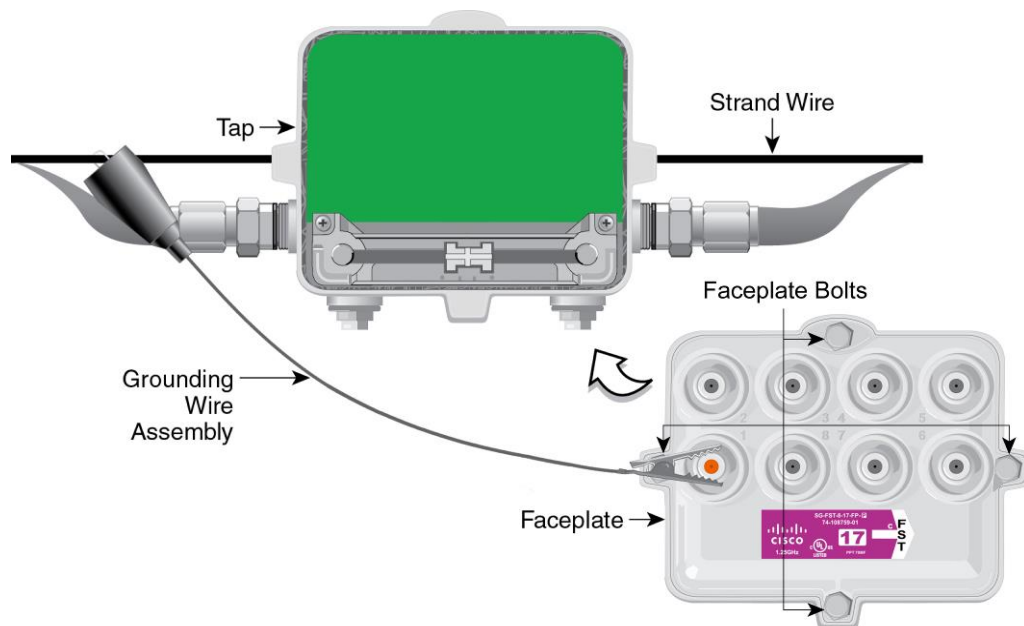

Proceed to step 6.

- 5 Attach a grounding wire assembly to the strand clamp bolt on the pedestal and a drop port F-connector.

Front View:

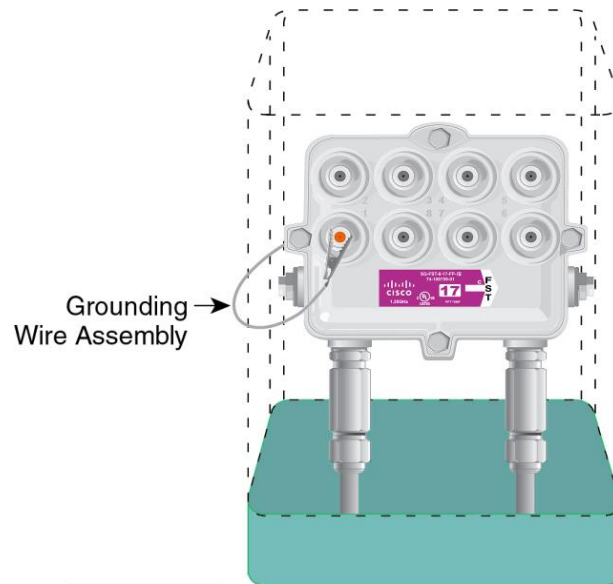

Back View:

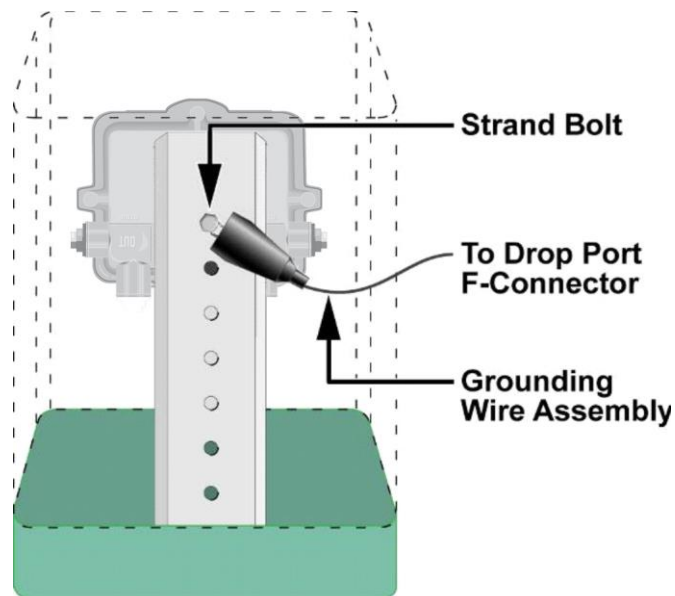

Proceed to step 6.

- 6 Pull the faceplate straight out from the housing. You need to use a small amount of force to pull the faceplate out.



**CAUTION:**

Handle the faceplate with care to avoid damage to the circuitry mounted to the rear of the faceplate.

## Installing the Tap Housing on a Strand

The strand-mounted configuration has the feeder cable entering one side of the unit and exiting the other side. The unit has one strand clamp with a strand clamp bolt and uses a standard cable strand for mounting.

### To Install the Tap Housing on a Strand

Follow these steps to install a tap housing on a strand.

- 1 Begin this procedure with the faceplate removed. Refer to *To Remove the Faceplate* (on page 145).
- 2 Using a 3/8-in. wrench, loosen the strand clamp bolt.
- 3 Attach the housing to the strand, make sure that the strand enters the strand clamp.

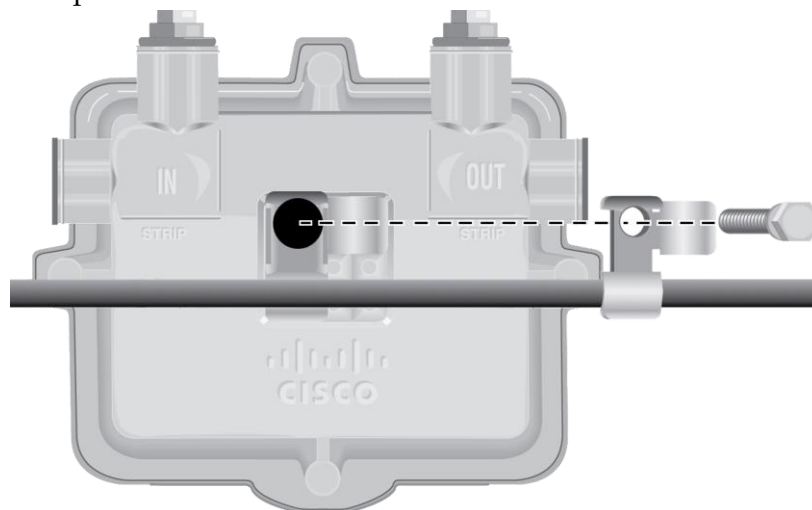

- 4 Secure the strand clamp to the strand by tightening the strand clamp bolt with a 3/8-in. wrench from 30 in-lb to 40 in-lb (3.4 Nm to 4.5 Nm).

## Chapter 2 Installing the Tap

- Using a 3/16-in. hex-head driver or 3/16-in. straight blade screwdriver, loosen the two seizure screws inside the housing.

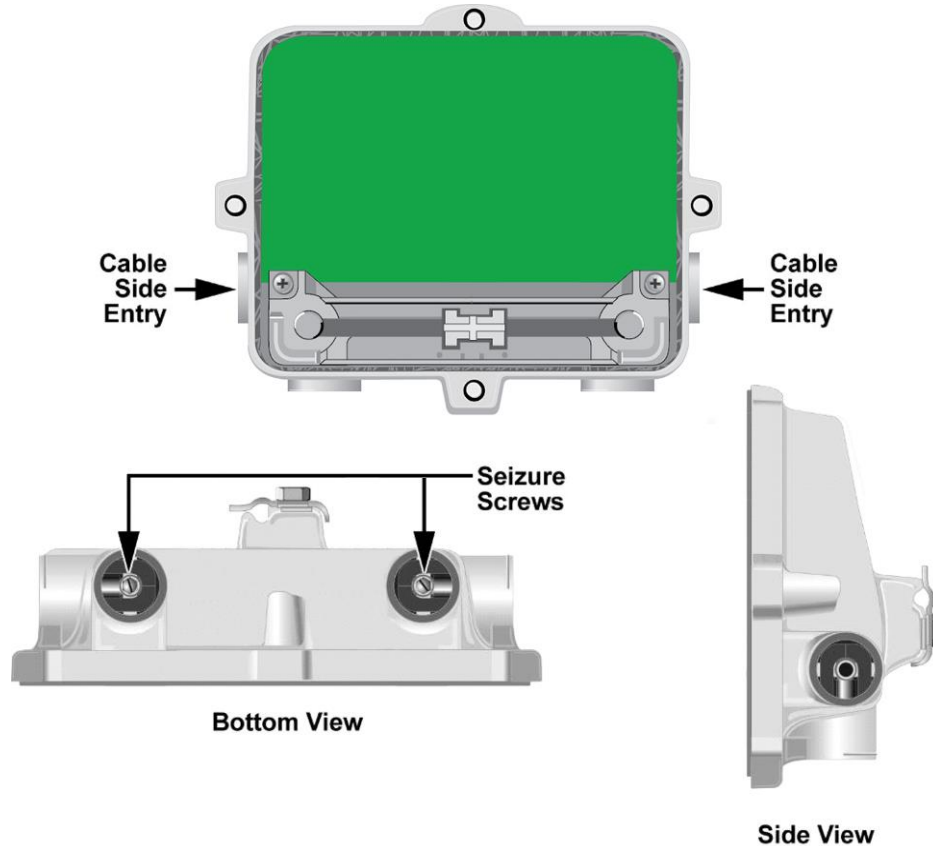

- Thread the prepared KS-connectors into the cable side entry port as shown in the figure above. Make sure to tighten the connector according to the manufacturer's recommended torque specification, typically 15 ft-lb to 25 ft-lb (20.3 Nm to 33.9 Nm), but not to exceed 60 ft-lb (81.3 Nm).
- Using a 3/16-in. hex-head driver or a 3/16-in. straight blade screwdriver, tighten the two seizure screws from 15 in-lb to 20 in-lb (1.7 Nm to 2.3 Nm). See the diagram in step 5 for the location of the seizure screws.
- Replace the end plugs on the unused entry ports and torque with a 3/8-in. hex wrench from 50 in-lb to 60 in-lb (5.6 Nm to 6.8 Nm).
- Attach the faceplate to the housing. Refer to *To Mount the Faceplate* (on page 21).
- Attach the drop cable (RG-6 or RG-59) to the tap faceplate.

**Note:** Be sure to provide strain relief for the coax drop cable per manufacturer's recommendation, and terminate all unused F-ports with 75 terminators.



## Installing the Tap Housing in a Pedestal

The pedestal-mounted configuration has the feeder cable entering and exiting the unit from the bottom. The tap without traps or filters fits in a 6-in. round or square pedestal. A larger pedestal is needed if traps or filters are installed.

### To Install the Tap Housing in a Pedestal

Follow these steps to install a tap housing in a pedestal.

- 1 Begin this procedure with the faceplate removed. Refer to *To Remove the Faceplate* (on page 144).
- 2 Using a 3/8-in. wrench, remove the strand bolt and strand clamp from the housing.
- 3 Mount the housing to the pedestal-mounting bracket using the strand bolt. Use the strand clamp as a spacer, if necessary.

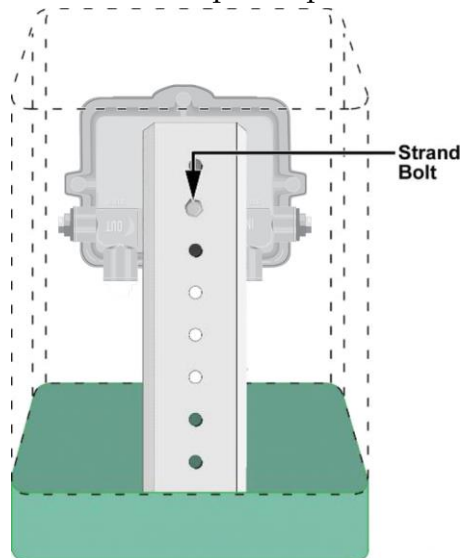

- 4 Using a 3/8-in. wrench, tighten the strand bolt from 30 in-lb to 40 in-lb (3.4 Nm to 4.5 Nm).

## Chapter 2 Installing the Tap

- Using a 3/16-in. hex-head driver or a 3/16-in. straight blade screwdriver, loosen the two seizure screws inside the housing.

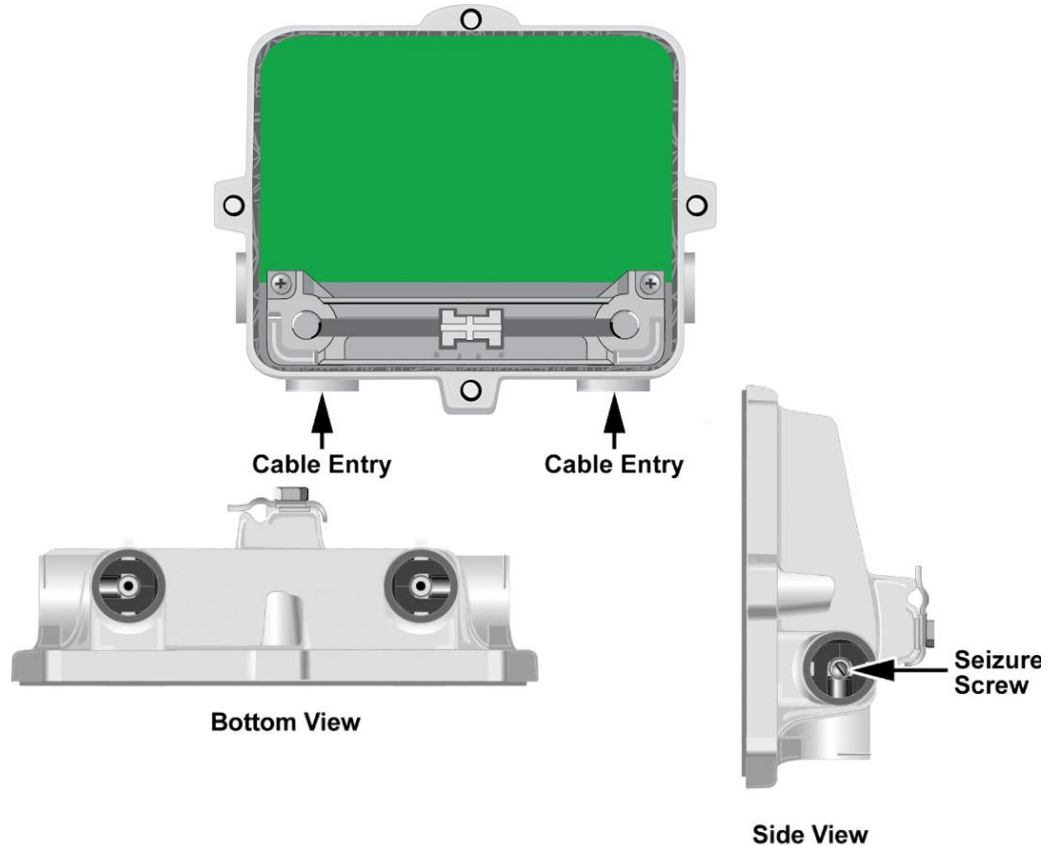

- Thread the prepared KS-connectors into the cable side entry port as shown in the figure above. Make sure to tighten the connector according to the manufacturer's recommended torque specification, typically 15 ft-lb to 25 ft-lb (20.3 Nm to 33.9 Nm), but not to exceed 60 ft-lb (81.3 Nm).
- Using a 3/16-in. hex-head driver or a 3/16-in. straight blade screwdriver, tighten the two seizure screws from 15 in-lb to 20 in-lb (1.7 Nm to 2.3 Nm). See the diagram in step 5 for the location of the two seizure screws.
- Replace the end plugs on the unused entry ports and torque with a 3/8-in. hex wrench from 50 in-lb to 60 in-lb (5.6 Nm to 6.8 Nm).
- Attach the faceplate to the housing. Refer to *To Mount the Faceplate* (on page 211).
- Attach the drop cable (RG-6 or RG-59) to the tap faceplate.

**Note:** Be sure to provide strain relief for the coax drop cable per manufacturer's recommendation, and terminate all unused F-ports with 75 Ω terminators.

## Mounting the Faceplate

After mounting the housing and connecting the feeder cables, you are ready to install the faceplate in the tap housing.

### To Mount the Faceplate

Follow these steps to attach the faceplate to the housing.

- 1 If the housing is installed on a strand, go to step 2.  
If the housing is installed in a pedestal, go to step 3.



#### WARNING:

Protect yourself from electric shock and your equipment from damage. Certain components can deliver an electrical shock.

- 2 Attach a grounding wire assembly to the strand wire and a drop port F-connector.

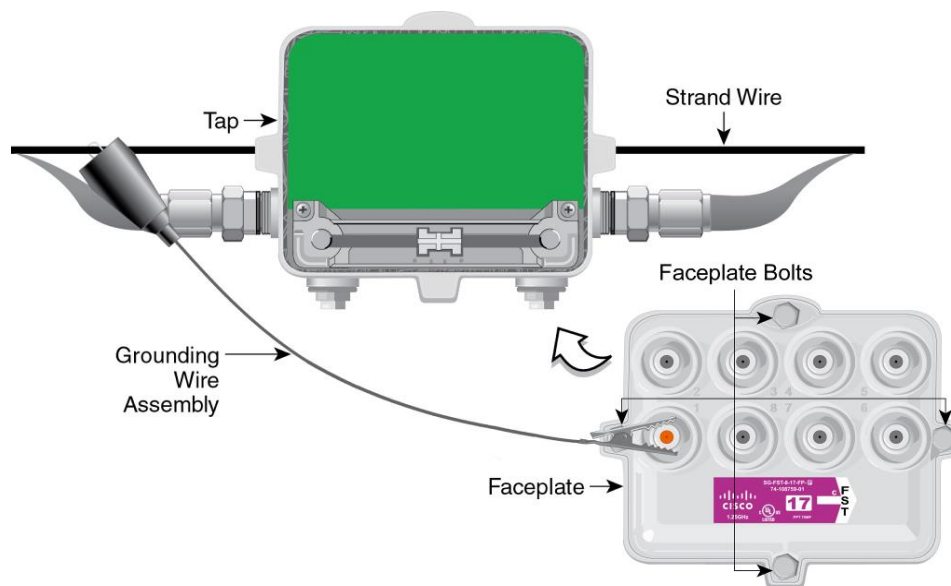

Proceed to step 4.

- 3 Attach a grounding wire assembly to the strand clamp bolt on the pedestal and a drop port F-connector.

## Chapter 2 Installing the Tap

Front View:

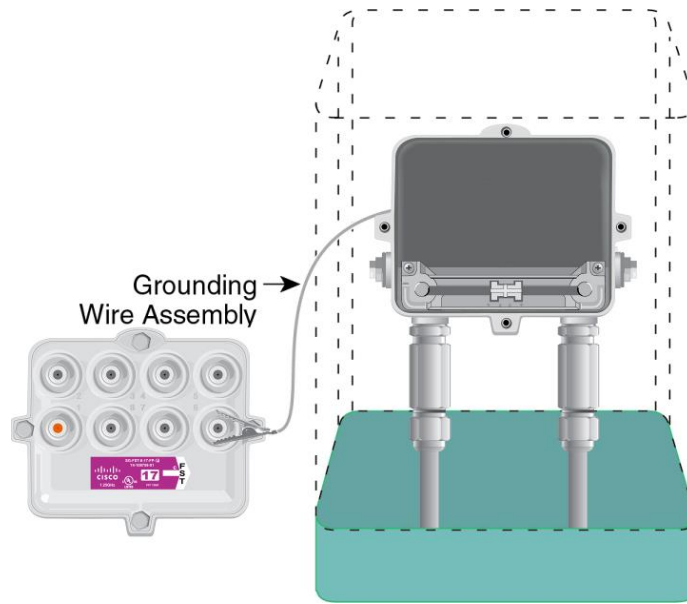

Back View:

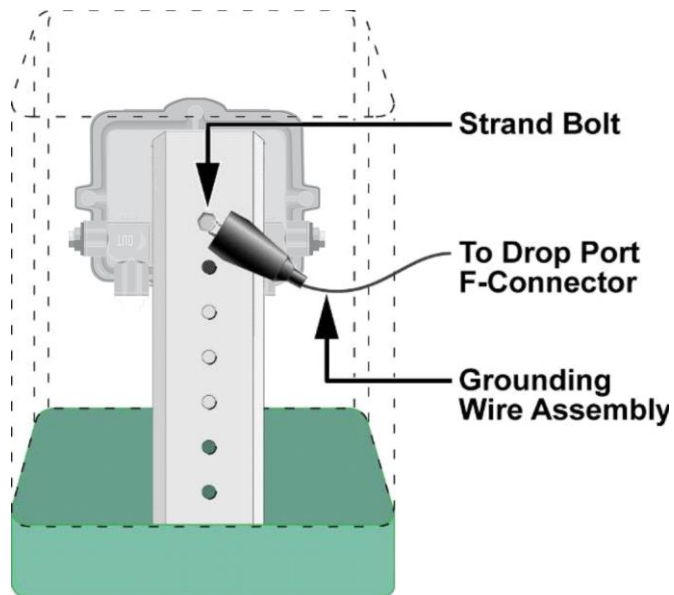

Proceed to step 4.

- 4 Inspect the housing gasket and all mating surfaces. Wipe off any dirt, moisture, or debris.
- 5 Place the faceplate on the tap housing. Push firmly on the faceplate to seat it in the housing.
- 6 Remove the grounding wire assembly.

## Mounting the Faceplate

- Using a 3/8 in. wrench, tighten the faceplate bolts from 50 in-lb to 60 in-lb (5.6 Nm to 6.8 Nm).

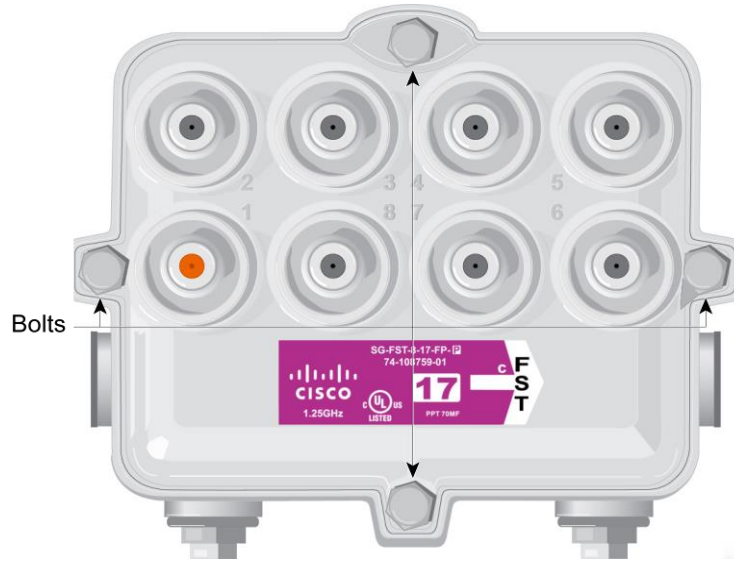

## Installing the Optional Modules

The reverse attenuator, forward equalizer, and inverse equalizer are plug-in optional modules that can be installed in the field. Refer to *Optional Modules* (on page 6) for details.

### To Install the Optional Modules

Follow these steps to install the optional modules.

- 1 If the faceplate is mounted in the tap housing, before proceeding, follow the steps in *To Remove the Faceplate* (on page 144).
- 2 Select the appropriate optional module that is to be installed.
- 3 Locate and remove the jumper module.

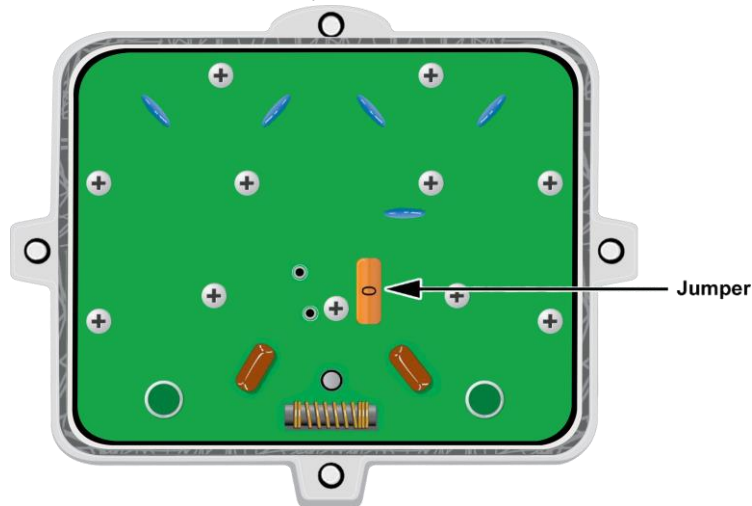

- 4 Align the optional module pins with the five pin holes on the tap faceplate.

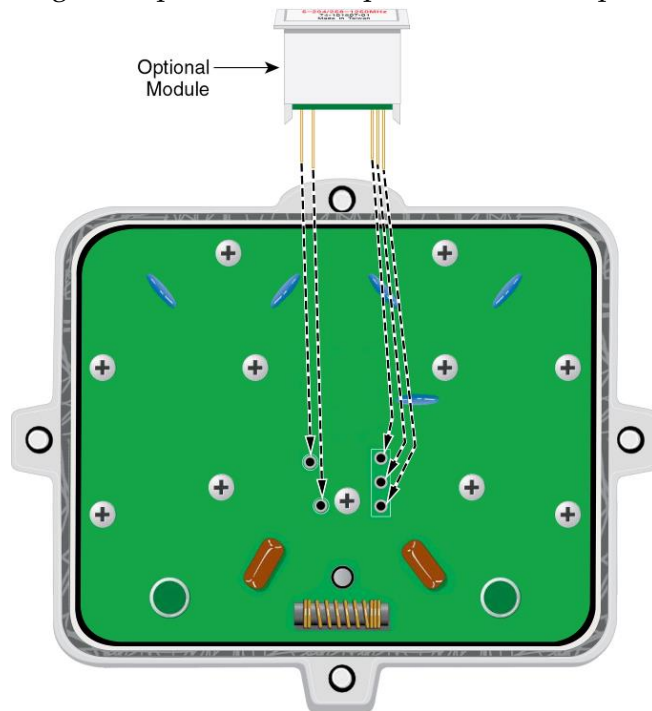

**Note:** Be sure the optional module is seated securely on the socket.

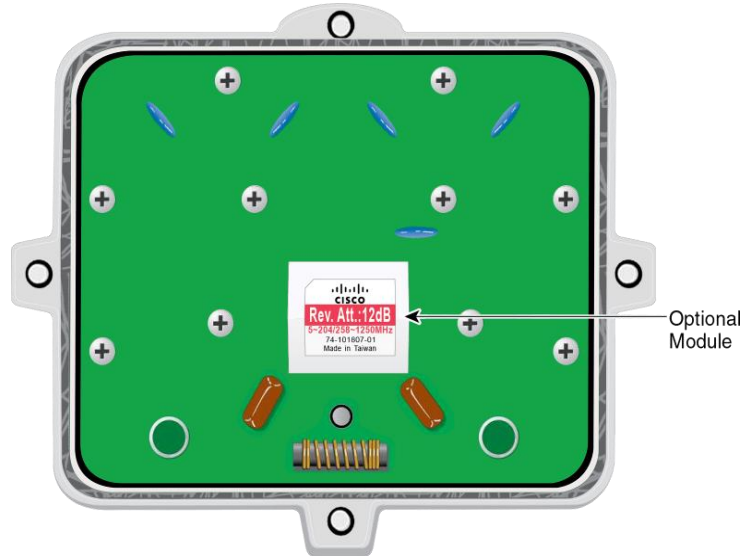

- 5 Clean the decal area of any dirt or oil. Attach the appropriate decal shipped with the module.

# 3

## Customer Support Information

### **If You Have Questions**

If you have technical questions, call Cisco Services for assistance. Follow the menu options to speak with a service engineer.

Access your company's extranet site to view or order additional technical publications. For accessing instructions, contact the representative who handles your account. Check your extranet site often as the information is updated frequently.



# A

---

## Technical Information

This appendix contains important technical information about the Flexible Solutions Tap.

### In This Appendix

■ Specifications .....	28
■ Part Numbers .....	30

## Specifications

The following are the specifications for the tap.

**Note:** Specifications are subject to change without notice.

### 2/4/8-Way Tap Dimensions

Item	Specification
Height	4.25 in. (107.95 mm)
Width	5.5 in. (139.75 mm)
Depth	3.0 in. (76.2 mm)

### Electrical Specifications

Item	Specification
Frequency bandpass	5 MHz to 1000 MHz
Power passing	12 A, 60 V AC to 90 V AC
Impedance	75
Interface	■ ports: KS-connectors ■ drop ports: F-connectors
Operating temperature	-40 F to +140 F (-40 C to +60 C)
Port current limiting	250 mA (at 60 C)
Surge resistance	■ 6 kV combination wave on KS port ■ 6 kV ring wave on F port

### AC/RF Bypass Switch Performance

Item	Specification
System open circuit time	0 ms
Contact resistance	10 m max
Current and voltage capacity	15 A, 60 V AC to 90 V AC
Frequency bandpass	5 MHz to 1000 MHz w/DC

## Standards Compliance

<b>Standard Committee</b>	<b>Standard</b>
SCTE	F-port interface specification IPS-SP-400
FCC	Part 76
EU EMC	50083-2

## Part Numbers

The table below lists the part numbers and descriptions of the tap.

### FST with Power Distribution Port Full Profile Taps

Part Number	Description
SG-FST-2-04-FP-P	FST Full Profile Taps with power passing,1.25GHz,2way,04dB
SG-FST-2-08-FP-P	FST Full Profile Taps with power passing,1.25GHz,2way,08dB
SG-FST-2-11-FP-P	FST Full Profile Taps with power passing,1.25GHz,2way,11dB
SG-FST-2-14-FP-P	FST Full Profile Taps with power passing,1.25GHz,2way,14dB
SG-FST-2-17-FP-P	FST Full Profile Taps with power passing,1.25GHz,2way,17dB
SG-FST-2-20-FP-P	FST Full Profile Taps with power passing,1.25GHz,2way,20dB
SG-FST-2-23-FP-P	FST Full Profile Taps with power passing,1.25GHz,2way,23dB
SG-FST-2-26-FP-P	FST Full Profile Taps with power passing,1.25GHz,2way,26dB
SG-FST-4-08-FP-P	FST Full Profile Taps with power passing,1.25GHz,4way,08dB
SG-FST-4-11-FP-P	FST Full Profile Taps with power passing,1.25GHz,4way,11dB
SG-FST-4-14-FP-P	FST Full Profile Taps with power passing,1.25GHz,4way,14dB
SG-FST-4-17-FP-P	FST Full Profile Taps with power passing,1.25GHz,4way,17dB
SG-FST-4-20-FP-P	FST Full Profile Taps with power passing,1.25GHz,4way,20dB
SG-FST-4-23-FP-P	FST Full Profile Taps with power passing,1.25GHz,4way,23dB
SG-FST-4-26-FP-P	FST Full Profile Taps with power passing,1.25GHz,4way,26dB
SG-FST-8-11-FP-P	FST Full Profile Taps with power passing,1.25GHz,8way,11dB
SG-FST-8-14-FP-P	FST Full Profile Taps with power passing,1.25GHz,8way,14dB
SG-FST-8-17-FP-P	FST Full Profile Taps with power passing,1.25GHz,8way,17dB
SG-FST-8-20-FP-P	FST Full Profile Taps with power passing,1.25GHz,8way,20dB
SG-FST-8-23-FP-P	FST Full Profile Taps with power passing,1.25GHz,8way,23dB
SG-FST-8-26-FP-P	FST Full Profile Taps with power passing,1.25GHz,8way,26dB

## FST with Power Distribution Port Full Profile Faceplates

Part Number	Description
SG-FST-2-04-FFP-P	FST Full Profile Taps with power passing Faceplates,1.25GHz,2way,04dB
SG-FST-2-08-FFP-P	FST Full Profile Taps with power passing Faceplates,1.25GHz,2way,08dB
SG-FST-2-11-FFP-P	FST Full Profile Taps with power passing Faceplates,1.25GHz,2way,11dB
SG-FST-2-14-FFP-P	FST Full Profile Taps with power passing Faceplates,1.25GHz,2way,14dB
SG-FST-2-17-FFP-P	FST Full Profile Taps with power passing Faceplates,1.25GHz,2way,17dB
SG-FST-2-20-FFP-P	FST Full Profile Taps with power passing Faceplates,1.25GHz,2way,20dB
SG-FST-2-23-FFP-P	FST Full Profile Taps with power passing Faceplates,1.25GHz,2way,23dB
SG-FST-2-26-FFP-P	FST Full Profile Taps with power passing Faceplates,1.25GHz,2way,26dB
SG-FST-4-08-FFP-P	FST Full Profile Taps with power passing Faceplates,1.25GHz,4way,08dB
SG-FST-4-11-FFP-P	FST Full Profile Taps with power passing Faceplates,1.25GHz,4way,11dB
SG-FST-4-14-FFP-P	FST Full Profile Taps with power passing Faceplates,1.25GHz,4way,14dB
SG-FST-4-17-FFP-P	FST Full Profile Taps with power passing Faceplates,1.25GHz,4way,17dB
SG-FST-4-20-FFP-P	FST Full Profile Taps with power passing Faceplates,1.25GHz,4way,20dB
SG-FST-4-23-FFP-P	FST Full Profile Taps with power passing Faceplates,1.25GHz,4way,23dB
SG-FST-4-26-FFP-P	FST Full Profile Taps with power passing Faceplates,1.25GHz,4way,26dB
SG-FST-8-11-FFP-P	FST Full Profile Taps with power passing Faceplates,1.25GHz,8way,11dB
SG-FST-8-14-FFP-P	FST Full Profile Taps with power passing Faceplates,1.25GHz,8way,14dB
SG-FST-8-17-FFP-P	FST Full Profile Taps with power passing Faceplates,1.25GHz,8way,17dB
SG-FST-8-20-FFP-P	FST Full Profile Taps with power passing Faceplates,1.25GHz,8way,20dB
SG-FST-8-23-FFP-P	FST Full Profile Taps with power passing Faceplates,1.25GHz,8way,23dB
SG-FST-8-26-FFP-P	FST Full Profile Taps with power passing Faceplates,1.25GHz,8way,26dB

## Reverse Attenuator Plug-ins

Part Number	Description	Label Color
SG-FST-RA-4254-03	Flexible Solutions Tap Rev ATT,1.25G,42/54M,3dB	Red
SG-FST-RA-4254-06	Flexible Solutions Tap Rev ATT,1.25G,42/54M,6dB	Red
SG-FST-RA-4254-09	Flexible Solutions Tap Rev ATT,1.25G,42/54M,9dB	Red
SG-FST-RA-4254-12	Flexible Solutions Tap Rev ATT,1.25G,42/54M,12dB	Red

**Appendix A**  
**Technical Information**

<b>Part Number</b>	<b>Description</b>	<b>Label Color</b>
SG-FST-RA-6586-03	Flexible Solutions Tap Rev ATT,1.25G,65/86M,3dB	Red
SG-FST-RA-6586-06	Flexible Solutions Tap Rev ATT,1.25G,65/86M,6dB	Red
SG-FST-RA-6586-09	Flexible Solutions Tap Rev ATT,1.25G,65/86M,9dB	Red
SG-FST-RA-6586-12	Flexible Solutions Tap Rev ATT,1.25G,65/86M,12dB	Red
SG-FST-RA-85105-03	Flexible Solutions Tap Rev ATT,1.25G,85/105M,3dB	Red
SG-FST-RA-85105-06	Flexible Solutions Tap Rev ATT,1.25G,85/105M,6dB	Red
SG-FST-RA-85105-09	Flexible Solutions Tap Rev ATT,1.25G,85/105M,9dB	Red
SG-FST-RA-85105-12	Flexible Solutions Tap Rev ATT,1.25G,85/105M,12dB	Red
SG-FST-RA204258-03	Flexible Solutions Tap Rev ATT,1.25G,204/258M,3dB	Red
SG-FST-RA204258-06	Flexible Solutions Tap Rev ATT,1.25G,204/258M,6dB	Red
SG-FST-RA204258-09	Flexible Solutions Tap Rev ATT,1.25G,204/258M,9dB	Red
SG-FST-RA204258-12	Flexible Solutions Tap Rev ATT,1.25G,204/258M,12dB	Red

## **Forward Equalizer Plug-ins**

<b>Part Number</b>	<b>Description</b>	<b>Label Color</b>
SG-FST-FEQ-02	Flexible Solutions Tap Fwd EQ,1.25GHz, 02dB	Black
SG-FST-FEQ-03	Flexible Solutions Tap Fwd EQ,1.25GHz, 03dB	Black
SG-FST-FEQ-04	Flexible Solutions Tap Fwd EQ,1.25GHz, 04dB	Black
SG-FST-FEQ-06	Flexible Solutions Tap Fwd EQ,1.25GHz, 06dB	Black
SG-FST-FEQ-08	Flexible Solutions Tap Fwd EQ,1.25GHz, 08dB	Black
SG-FST-FEQ-09	Flexible Solutions Tap Fwd EQ,1.25GHz, 09dB	Black
SG-FST-FEQ-10	Flexible Solutions Tap Fwd EQ,1.25GHz, 10dB	Black
SG-FST-FEQ-12	Flexible Solutions Tap Fwd EQ,1.25GHz, 12dB	Black
SG-FST-FEQ-14	Flexible Solutions Tap Fwd EQ,1.25GHz, 14dB	Black
SG-FST-FEQ-15	Flexible Solutions Tap Fwd EQ,1.25GHz, 15dB	Black
SG-FST-FEQ-16	Flexible Solutions Tap Fwd EQ,1.25GHz, 16dB	Black
SG-FST-FEQ-18	Flexible Solutions Tap Fwd EQ,1.25GHz, 18dB	Black
SG-FST-FEQ-20	Flexible Solutions Tap Fwd EQ,1.25GHz, 20dB	Black
SG-FST-FEQ-22	Flexible Solutions Tap Fwd EQ,1.25GHz, 22dB	Black

## Equalizer Plug-ins

Part Number	Description	Label Color
SG-FST-INVEQ-02	Flexible Solutions Tap Inverse EQ,1.25GHz, 02dB	Blue
SG-FST-INVEQ-03	Flexible Solutions Tap Inverse EQ,1.25GHz, 03dB	Blue
SG-FST-INVEQ-04	Flexible Solutions Tap Inverse EQ,1.25GHz, 04dB	Blue
SG-FST-INVEQ-06	Flexible Solutions Tap Inverse EQ,1.25GHz, 06dB	Blue
SG-FST-INVEQ-08	Flexible Solutions Tap Inverse EQ,1.25GHz, 08dB	Blue
SG-FST-INVEQ-09	Flexible Solutions Tap Inverse EQ,1.25GHz, 09dB	Blue
SG-FST-INVEQ-10	Flexible Solutions Tap Inverse EQ,1.25GHz, 10dB	Blue
SG-FST-INVEQ-12	Flexible Solutions Tap Inverse EQ,1.25GHz, 12dB	Blue
SG-FST-INVEQ-15	Flexible Solutions Tap Inverse EQ,1.25GHz, 15dB	Blue
SG-FST-INVEQ-18	Flexible Solutions Tap Inverse EQ,1.25GHz, 18dB	Blue
SG-FST-INVEQ-21	Flexible Solutions Tap Inverse EQ,1.25GHz, 21dB	Blue





# Index

---

## 2

- 2/4/8-way FST Power Passing Tap Full Profile Faceplate • 7
- 2/4/8-way FST Power Passing Tap Full Profile Housing • 5
- 2/4/8-Way Tap Dimensions • 32

## A

- AC/RF Bypass Switch Performance • 33

## C

- Customer Support Information • 29

## D

- Description of the Flexible Solutions Tap • 3

## E

- Electrical Specifications • 32

## I

- Installing Optional Modules • 26
- Installing the Tap • 11
- Installing the Tap Housing in a Pedestal • 21
- Installing the Tap Housing on a Strand • 19
- Introducing the Flexible Solutions Tap • 1
- Inverse Equalizer Plug-ins • 37

## M

- Mounting the Faceplate • 23

## O

- Optional Modules • 8

## P

- Part Numbers • 34
- Preparing for Installation • 14

## R

- Removing the Faceplate • 16
- Reverse Attenuator Plug-ins • 36

## S

- Specifications • 32
- Standards Compliance • 33

## T

- To Install the Reverse Attenuator • 26
- To Install the Tap Housing in a Pedestal • 21
- To Install the Tap Housing on a Strand • 19
- To Mount the Faceplate • 23
- To Prepare the Connectors • 14
- To Remove a Faceplate with Feeder Cables Connected (Hot Install) • 17
- To Remove the Faceplate • 16
- Tools and Torque Specifications • 12
- Tools Required • 12
- Torque Sequence • 13
- Torque Specifications • 12



**Americas Headquarters**

Cisco Systems, Inc.  
170 West Tasman Drive  
San Jose, CA 95134-1706  
USA

<http://www.cisco.com>  
Tel: 408 526-4000  
800 553-6387  
Fax: 408 527-0883

This document includes various trademarks of Cisco Systems, Inc. Please see the Notices section of this document for a list of Cisco Systems, Inc., trademarks used in this document.

Product and service availability are subject to change without notice.

© 2007, 2008, 2012, 2014, 2016 Cisco Systems, Inc. All rights reserved.

First Published: 2007  
Last Updated: June 2016