

INSTRUCTION MANUAL

Intensifier K[®] Glacier Series

HTINTB8GK
(Bullet Camera)



Contents

● Contents.....	1
● Precautions	2, 3
● Safety Instructions	4
● Package Contents.....	5
● Camera Installation	6-8
● Lens Adjustment	9
● Specifications.....	10
● Camera Dimension	11
● Features.....	12
● OSD Menu Details	13-35
● Trouble Shooting.....	36

Precautions

Do not install the camera in extreme temperature conditions.

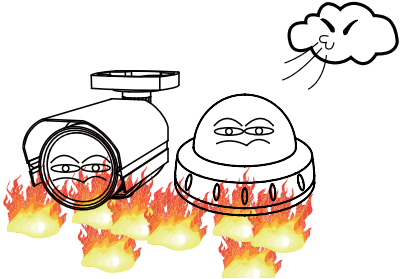

Only use the camera under conditions where temperatures are between -10°C and $+50^{\circ}\text{C}$. Be especially careful to provide ventilation when operating under high temperatures.

Do not install the camera under unstable lighting conditions.

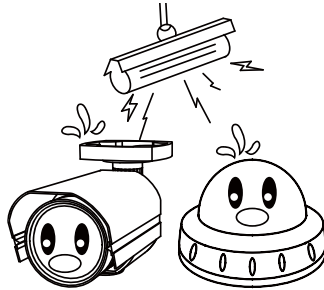

Severe lighting change or flicker can cause the camera to work improperly.

Do not touch the front lens of the camera.

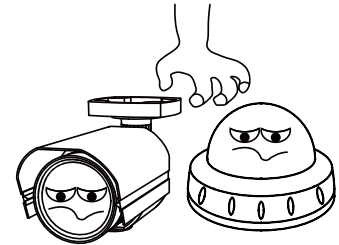

This is one of the most important parts of the camera. Be careful not to leave fingerprints on the lens cover.

Never keep the camera pointed directly at strong light.

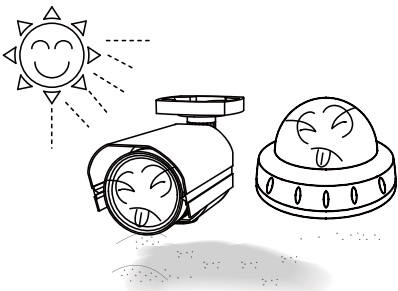

It can cause malfunctions to occur.

Do not drop the camera or subject it to physical shocks.

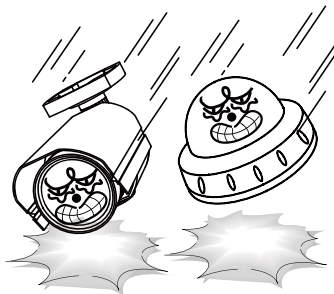

Housing damage can compromise weatherproof ratings.

Do not expose the camera to radioactivity.

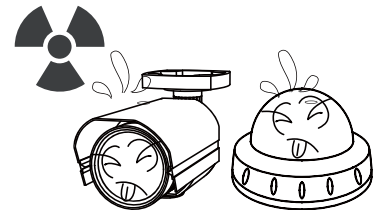

If exposed to radioactivity the CCD will fail.

NOTE

* If the camera is exposed to spotlight or object reflecting strong light, smear or blooming may occur.

* please check that the power satisfies the normal specification before connecting the camera.

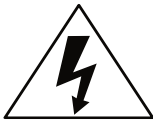

The lightning flash with an arrowhead symbol, within an equilateral triangle is intended to alert the user to the presence of uninsulated dangerous voltage within the product's enclosure that may be of sufficient magnitude to constitute a risk of electric shock to persons.



The exclamation point within an equilateral triangle is intended to alert the user to the presence of important operating and maintenance (servicing) instructions in the literature accompanying the appliance.

In USA and Canada, Use Class 2 Power Supply Only

INFORMATION - This equipment has been tested and found to comply with limits for a Class A digital device, pursuant to part 15 of the FCC Rules & CE Rules. These limits are designed to provide reasonable protection against harmful interference when the equipment is operated in a commercial environment. This equipment generates, uses, and can radiate radio frequency energy and, if not installed and used in accordance with the instruction manual, may cause harmful interference to radio communications.

Operation of this equipment in a residential area is likely to cause harmful interference in which case the user will be required to correct the interference at their own expense.

WARNING - Changes or modifications not expressly approved by the manufacturer could void the user's authority to operate the equipment.

WARNING - To prevent electric shock and risk of fire hazards:

- ◆ Do NOT use power sources other than that specified.
- ◆ Do NOT expose this appliance to rain or moisture.

Apparatus shall not be exposed to dripping or splashing and no objects filled with liquids, such as vases, shall be placed on the apparatus.

CAUTION : To prevent electric shock and risk of fire hazards:

- ☞ Do NOT use power sources other than those specified.

Safety Instructions

Precautions for use

- ① This camera should be installed by qualified personnel only
- ① There are no user serviceable parts inside
- ① Do not disassemble this camera other than to make initial adjustments
- ① Use a UL approved regulated 24 volt AC or 12 volt DC power supply
- ① Use appropriate low voltage power cable to prevent fire or electrical shock
- ① Please insure that your installation area can support the weight of the camera

Please handle this camera carefully :

- ① Do not use a strong or abrasive detergent when cleaning the camera
- ① Do not install near cooling or heating device

Package Contents

Please make sure that the following items are included in the Package:

- 1 Video Test Connector, Power Jack
- 1 Focus Adjustment
- 1 Bracket Base
- 1 Wrench
- Set Screw
 - 4 Tapping Screws 4x25
 - 4 Hexagon Socket Screws M5x10

CAMERA INSTALLATION

CONNECT POWER CABLE

1. WHEN USING 12 VOLTS DC (constant voltage 500 mA)

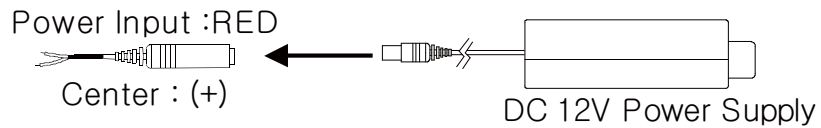

2. WHEN USING 24 VOLTS AC (40 Volt Amps)

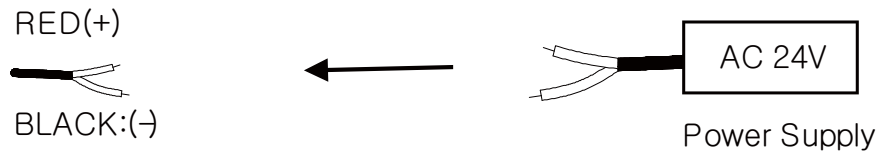

3. CONNECT VIDEO CABLE

– CONNECT BNC CABLE TO THE BNC JACK.

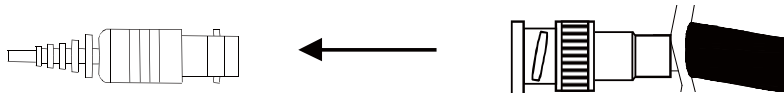

CAMERA INSTALLATION

Compatibility

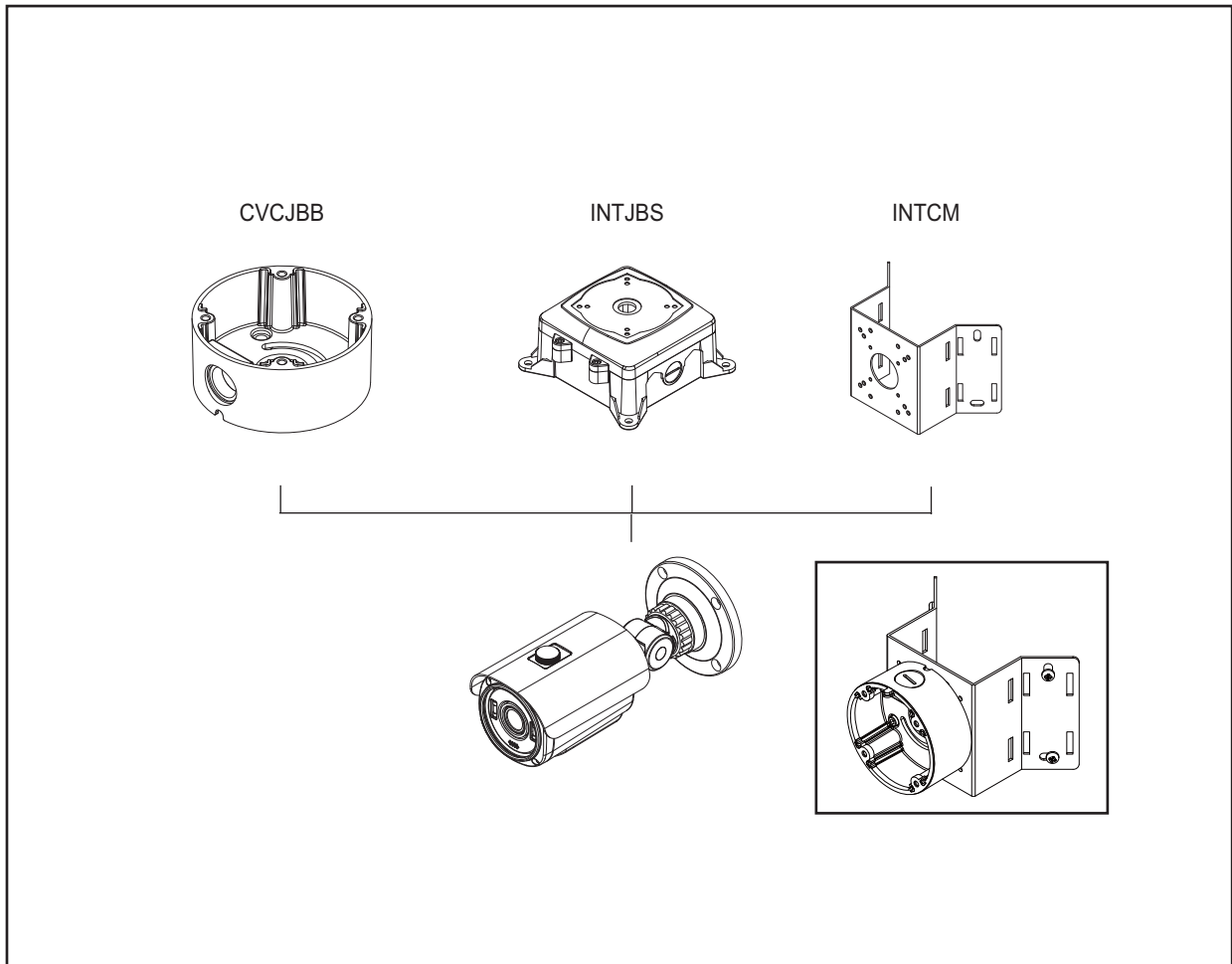

CAUTION : The installation instructions in this manual are for use by qualified service personnel only. To reduce the risk of electric shock, do not perform any servicing other than that contained in the operating instructions unless you are qualified to do so.

CAMERA INSTALLATION

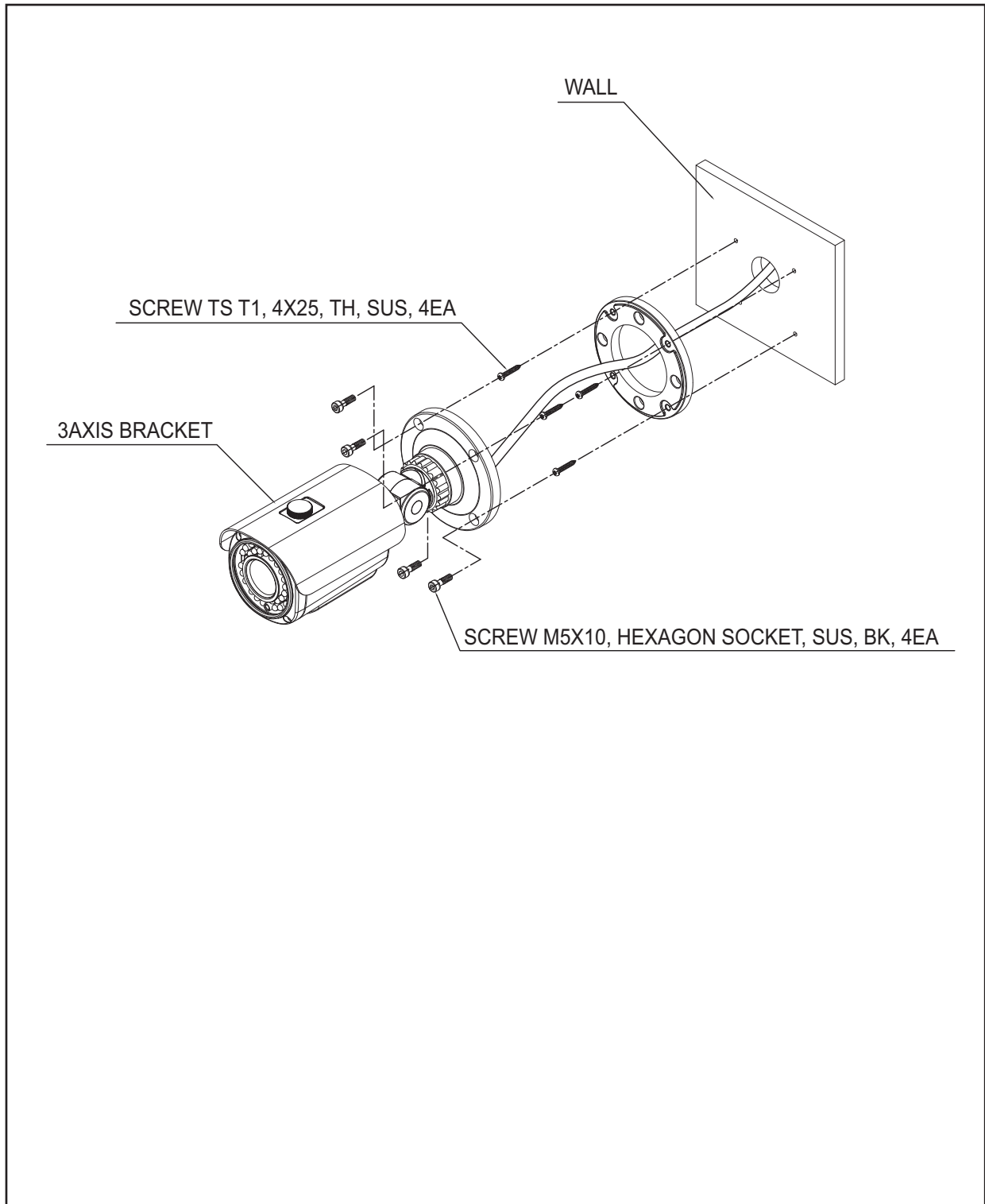

LENS ADJUSTMENT

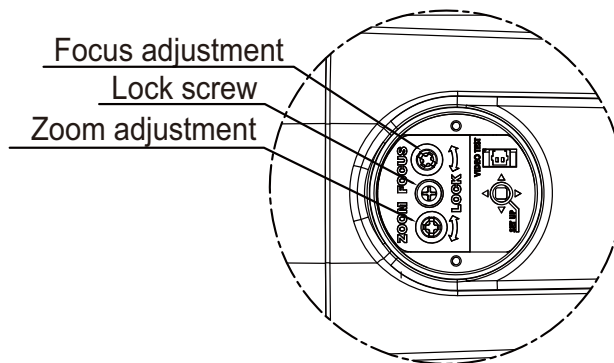
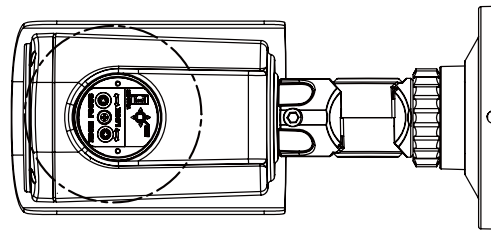
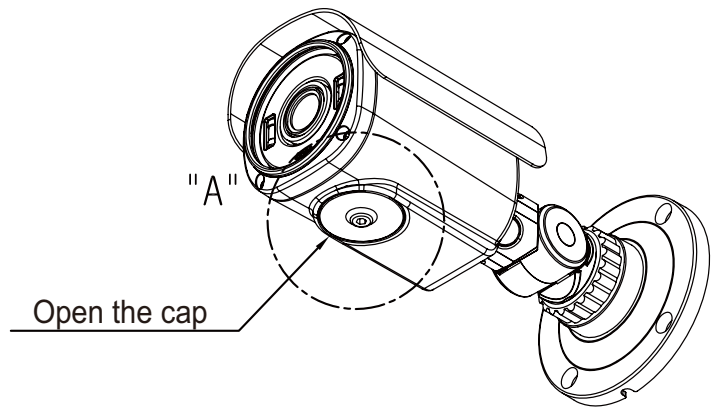

Intensifier K[®] Glacier Series

DC Auto Iris Varifocal Lens 2.8-12mm



■ HTINTB8GK

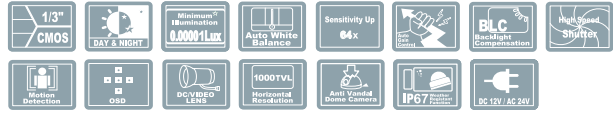

Automatic Thermostatic Sensor

SPECIFICATIONS

MODEL	HTINTB8GK
Image Sensor	1/3" 1.3MP SONY Sensor
Resolution	1000TV Lines
Effective Pixels	1305(H) X 1049(V), 1.37M Pixels
Total Pixels	1312(H) X 1069(V), 1.40M Pixels
Scanning System	Progressive Scan
S/N Ratio	More than 50dB
Frame rate	MAX 50P/60P
Video Output	CVBS : 1.0Vp-p/75 Ohm
Minimum Illumination	0Lux(Intensify x64)
LENS	DC/MANUAL
Electronic Shutter Speed	AUTO / Manual(1/60Sec ~ 1/60000Sec) / FLICKER
OSD	Built-in
BLC	0
HSBLC	0
WDR (Wide Dynamic Range)	ON(LOW,MIDDLE,HIGH) / OFF
Digital WDR	ON(LOW/MIDDLE/HIGH) / OFF
Day&Night	Color / BW / EXTERN / Auto
White Balance	AATW / AWB / AWC -> SET / MANUAL
Smart-IR	0~20(Level Adjustable), Default : 0
Sense-Up	x2 ~ x64, Default : x16
Motion Detection	ON / OFF (Programmable 4 Zones)
Motion Tracking (Quick Zoom)	ON/OFF
OSD output for Anti Shifting	ON/OFF
OSD output for Anti Blocking	ON/OFF
3D DNR	OFF/LOW/MIDDLE/HIGH
Defog	ON(AUTO/MANUAL) / OFF
Brightness	0~20 (Level Adjustable), Default : 10
AGC	0~20 (Level Adjustable), Default : 15
Privacy Masking	ON / OFF (Programmable 16 Zones)
Mirror / V-FLIP	ON/OFF
Sharpness	0~10 (Level Adjustable), Default : 7
LensShading Compensation (LSC)	ON/OFF
RS-485(Protocol)	Available
View Angle	WIDE 4:3 / Normal / WIDE 16:9
CVBS OUTPUT	NTSC / PAL selectable
Communication	Coaxial Control
Language	English
Power Supply	DC12V/AC24V Dual Voltage Operation
Power Consumption	Heater ON: DC 12V-400mA, AC24V-150mA Heater OFF(Glacier OFF): DC 12V-200mA, AC24V-90mA Heater ON(Glacier ON): DC 12V-1.2A, AC24V-500mA
Storage Temperature	-4°F ~ +140°F(Humidity : 20%RH ~ 95%RH)
Operating Temperature	-4°F ~ +140°F RH 95% Mxa / -40°F with Glacier Heaters
Lens	DC Auto Iris Varifocal Lens(2.8mm-12mm)
Dimension	3.94"(W) * 3.94"(H) * 8.27"(D)
Weight	3.09 lbs

CAMERA DIMENSION

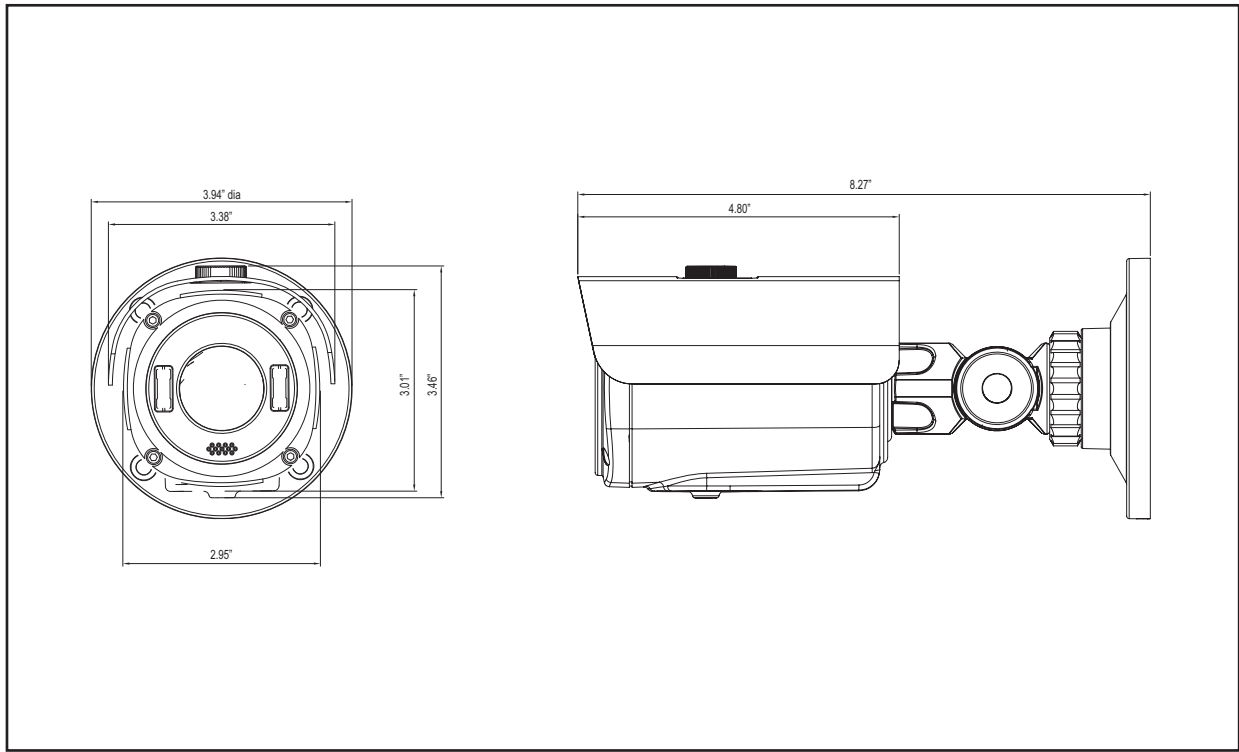

General Features

- **1000 TV Lines**

1.3 MEGA HD ANALOG 1000 TVL combined with SONY EXMOR SENSOR (IMX 138)

- **WDR (Wide Dynamic Range)**

A powerful and ultra-advanced technology that captures cleaner and superior high resolution picture even where images appear dark because there is a strong back light present.

- **PRESET**

Preset (Indoor, Outdoor, Low light, Hallway, Lobby, Elevator) is provided to maximize user convenience.

- **DNR (Digital Noise Reduction)**

SMART 3D DNR prevents the image blurring of moving objects and activates only when moving objects appear on the scene.

- **SMART IR**

No saturation image, vivid image in darkness. it makes very sharp video image in darkness.

This technology eliminates saturation of video image of the closer object in darkness by control of the IR sensitivity.

- **INTENSIFY**

INTENSIFY - Max. up to x64 helps get dark images visible and make it clear images in a low light environment.

- **DEFOG**

Defog function improve the clarity of images taken in poor conditions such as fog, smoke, rain or snow.

- **CVBS (Composite Video Blanking and Sync)**

TV System is switchable into 'NTSC' or 'PAL' with built-in OSD.

- **INTELLIGENCE**

An extraordinary technology enables to become an ultimate analog solution by providing intelligent features based on motion tracking. it strengthens crime prevention & detection.

- **Automatic Thermostatic Sensor**

How to Set Up the camera menu

● Setup Menu

PRESET MODE MENU

MAIN SETUP						
	INDOOR	OUTDOOR	LOW LIGHT	HALL WAY	LOBBY	ELEVATOR

LENS	DC	MODE	INDOOR / OUTDOOR / DEBLUR			
		RETURN				
	MANUAL	MODE	NORMAL / DEBLUR			
RETURN						
EXPOSURE		BRIGHTNESS	0 ~ 20			
		SHUTTER	AUTO			
			MANUAL	SPEED	1/60 ~ 1/60,000	
			RETURN			
		FLICKER				
		INTENSIFY	OFF / X2 ~ X64			
		AGC	0 ~ 20			
RETURN						
WHITE BAL	ATW					
	AWB					
	AWC -> SET					
	MANUAL	KELVIN	LOW / MIDDLE / HIGH			
		R-GAIN	0 ~ 20			
		B-GAIN	0 ~ 20			
RETURN						
BLACKLIGHT	OFF					
	HLC	LEVEL	0 ~ 20			
		MODE	ALL DAY / NIGHT ONLY			
		RETURN				
	BLC	H-POS	0 ~ 20			
		V-POS	0 ~ 20			
		H-SIZE	0 ~ 20			
		V-SIZE	0 ~ 20			
		RETURN				
	WDR	WEIGHT	LOW / MIDDLE / HIGH			
		RETURN				
DNR	OFF					
	LOW					
	MIDDLE					
	HIGH					
DAY&NIGHT	AUTO	SMART IR	0 ~ 20			
		AGC THRES	0 ~ 20			
		AGC MARGIN	0 ~ 20			
		DELAY	LOW / MIDDLE / HIGH			
		RETURN				
	COLOR					
	B/W	SMART IR	0 ~ 20			
		RETURN				
	EXTERN	SMART IR	0 ~ 20			
		EXTERN S/W	LOW / HIGH			
		DELAY	LOW / MIDDLE / HIGH			
		RETURN				

How to Set Up the camera menu

● Setup Menu

IMAGE	SHARPNESS		0 ~ 10		
	GAMMA		0.45 ~ 0.65		
	PEDSTAL		0 ~ 20		
	COLOR GAIN		0 ~ 20		
	MIRROR		OFF / ON		
	FLIP		OFF / ON		
	RETURN				
SYSTEM	COM.	CAM ID	0 ~ 255		
		BAUDRATE	2400 / 4800 / 9600 / 57600 / 115200		
		RETURN			
	VIEW ANGLE	WIDE 4 : 3			
		WIDE 16 : 9	XY ADJUST		
		NORMAL	XY ADJUST		
	CVBS	NTSC / PAL			
	LANGUAGE	ENG / CHN / CHN(S) / JAN / KOR			
	RESET	ON	PUSHING		
	RETURN				
SPECIAL	D-ZOOM	1.0X ~ 8.0X			
	D-WDR	OFF / LOW / MIDDLE / HIGH			
	DEFOG	OFF			
		ON	MODE	AUTO	
				MANUAL	
			LEVEL	LOW	
			MIDDLE		
		HIGH			
	RETURN				
	SHADING	OFF			
		ON	WEIGHT	0 ~ 100%	
			RETURN		
	OFF				
	PRIVACY	ON	ZONE NUM	0 ~ 15	
			ZONE DISP	ON / OFF	
			H-POS	0 ~ 40	
			V-POS	0 ~ 32	
			H-SIZE	0 ~ 40	
			V-SIZE	0 ~ 32	
			Y LEVEL	0 ~ 20	
			CR LEVEL	0 ~ 20	
			CB LEVEL	0 ~ 20	
RETURN					
INTELLIGENT	MTN TRACKER	ON	DET. SETTING	SENSITIVITY	0 ~ 20
				OBJ KEEP	LV 0 ~ LV 60
				MOTION EST	0 ~ 20
				SIGNAL OUT	OFF / ON
		RETURN			
		WINDOW TONE	0 ~ 6		
		WINDOW ZONE	0 ~ 3		
		WINDOW USE	OFF / ON		
		DET H-POS	0 ~ 40		
		DET V-POS	0 ~ 32		
		DET H-SIZE	0 ~ 40		
		DET V-SIZE	0 ~ 32		
		RETURN			

How to Set Up the camera menu

● Setup Menu

			ALARM	ANTI-SHIFT	OFF / ON
				SHIFT SCALE	0 ~20
				ANTI-BLOCK	OFF / ON
				BLOCK SCALE	0 ~ 20
				RETURN	
			QUICK ZOOM	MOVING	0 ~ 240 sec
				ZOOM IN	0 ~ 240 sec
				STANDBY	0 ~ 240 sec
				SYNCHRONOUS	OFF / ON
				TRACKING	OFF / ON
				REPEAT	OFF / ON
				RETURN	
RETURN					

MENU

Menu setting can be selected by the button inside the camera.

1. Press the set button.

* MENU will be displayed on the monitor.

◆ MENU

→ PRESET : Preset is provided to maximize user convenience.

(PRESET : Indoor // Outdoor // Low light // Hallway // Lobby // Elevator)



→ MAIN SETUP : Enter the MAIN SETUP to adjust further settings.



MENU SETUP

Menu setting can be selected by the button inside the camera.

1. Press the set button.

* The Set Up menu will be displayed on the monitor.

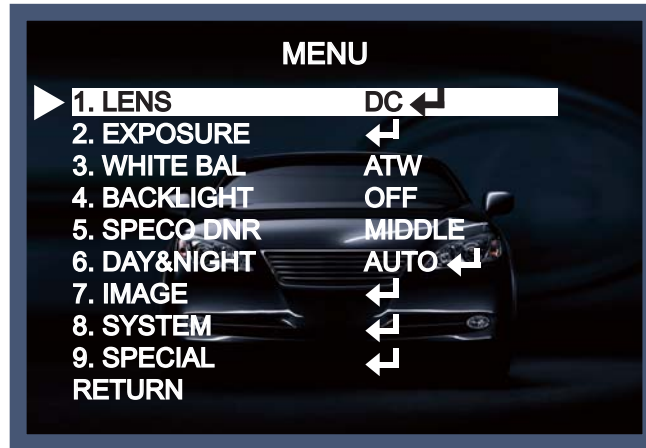

2. Move and select the required function using the Up and Down button.

* Move the triangular indicator Up or Down to select the desired feature by pressing the Up or Down button.

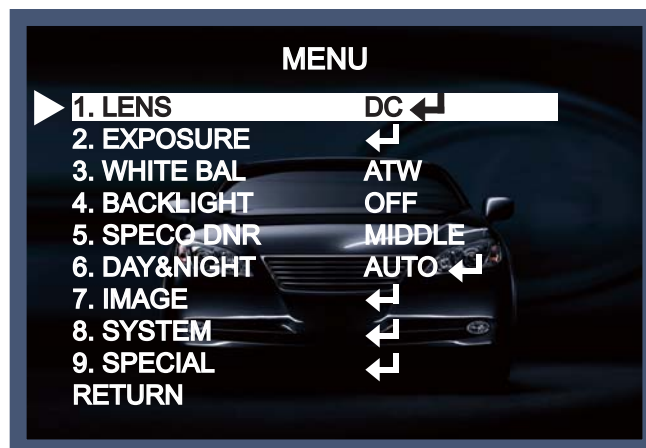

3. Change menu settings using the Left or Right button.

* Available values or Status are displayed by pressing the Left or Right buttons.

Press the button until desired value / status is displayed.

4. After Changing the setting move the arrow indicator to RETURN and press the SET button to RETURN.

NOTE

* Move to the available submenu by moving  arrow to desired feature.

* Submenu is not available when this symbol displayed "---".

1. LENS

This function is to adjust the brightness of the monitor.

1. Move the triangular indicator to LENS using the Up and Down buttons on the Set Up menu screen.

2. Select the desired lens type by pressing the Left or Right button.

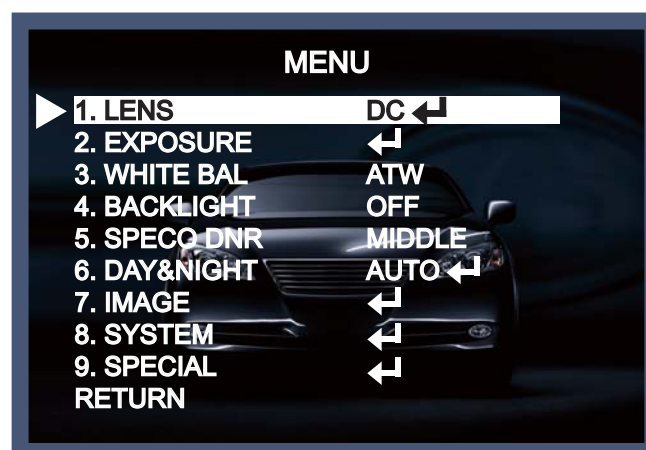

NOTE

- * On DC mode, you can select INDOOR, OUTDOOR, or DEBLUR depending on the installation environment.
- * On MANUAL mode, you can select NORMAL or DEBLUR depending on the installation environment.

2. EXPOSURE

On this manu, users can control exposure by selecting one of modes (Brightness, Shutter, Sens-up, AGC)

1. Move the triangular indicator to EXPOSURE on the SETUP menu screen using the Up and Down button
2. Select the desired mode using the Left or Right buttons.

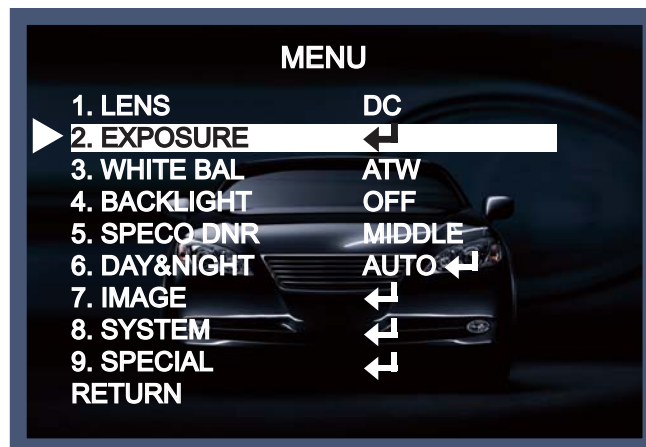

◆ EXPOSURE

- BRIGHTNESS : It is used to adjust overall brightness level.
(BRIGHTNESS : 0 ~ 20 // default value : 10)

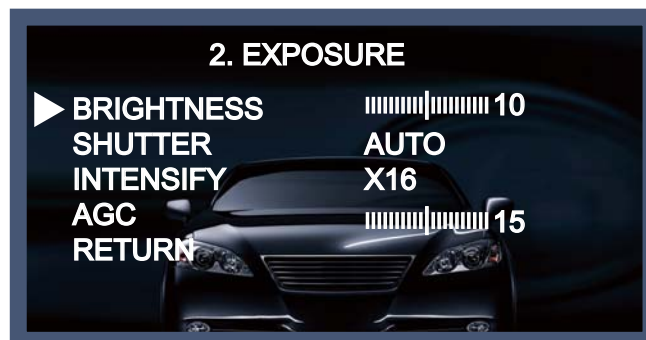

→ SHUTTER : Users adjust electronic shutter speed by selecting one of modes(AUTO, MANUAL, FLICKER).



Manual mode : shutter speed is adjustable from 1/60 up to 1/60,000.



→ INTENSIFY : The brighter image can be displayed by operating digital slow shutter speed in low light environment.
(digital slow shutter : x2 ~ x64 // default value : x16)



→ AGC : the brighter image can be displayed by adjusting AGC(Auto Gain Control) level.
(AGC : 0 ~ 20 / default : 15 // default value : 15)



3. WHITE BALANCE

Use this function when the color adjustment of a screen is needed.

1. Move the triangular indicator to WHITE BAL on the SETUP menu screen using the Up and Down button.
2. Select the desired mode by using the left or Right button.

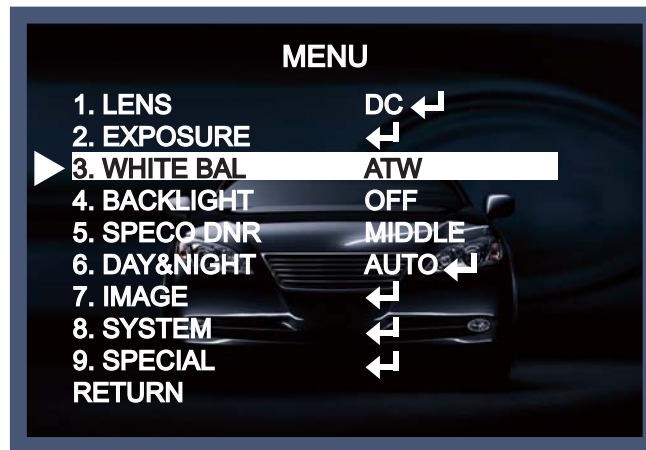

Use the appropriate mode according to your purposes among these three modes.

- * ATW : Use this mode when the color temperature is from 1,800K to 10,500K.
- * AWB : The function to search for the color which is matched well with the ambient environment. This be used when the color temperature is from 3,000K to 7,000K.
- * AWC→SET : After letting camera focus on the blank white paper to the best condition of current lighting environment, press the SET button. If the lighting condition is changed, Re-adjustment should be needed.
- * MANUAL : Manual compensation make the more detailed control possible. First, after adjusting the white balance using the ATW or AWB mode, change the mode into the manual compensation mode and then press Set button. While looking at the color change of the subject seen on the screen after setting up the proper color temperature, increase the each value of the blue and the red.

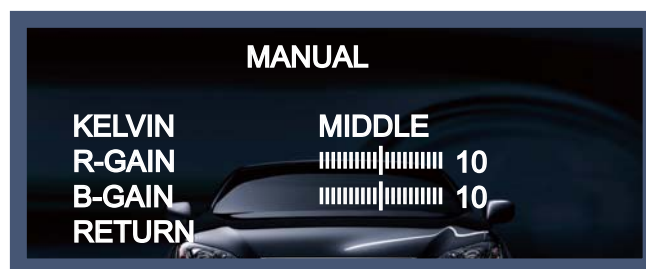

NOTE

The White Balance may not be worked properly in the following conditions. If this doesn't work, use the AWB mode.

- * When there is a very high color temperature in the circumstances of the subject.
(for example, clear sky, Sunset)
- * It is very dark.
- * If the camera is headed to the fluorescent light directly or if there is a drastic lighting change, The operation of White balance may become unstable.

4. BACK LIGHT

On this menu, back light image can be compensated by users selecting one of modes (HLC, BLC, and WDR).

1. Move the triangular indicator to BACKLIGHT on the SETUP menu screen using the Up and Down button
2. Select the desired mode using the Left or Right buttons.

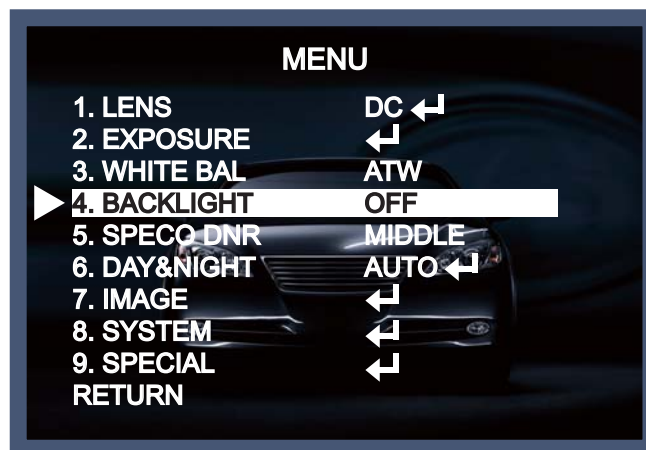

- ◆ HLC (Highlight Light Compensation) : When there is a car head light turned on at the entrance of the gas station or in some place in the parking lot, the numbers of the car plate can be recognized by blocking only the light from the car headlight. At the area is set up specifically, you can recognize the car plate numbers by blocking the strong light signal.

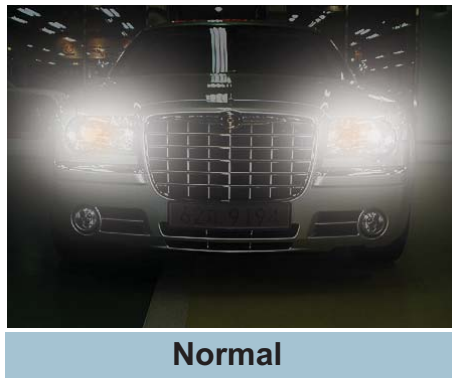

- ◆ BLC (Back Light Compensation) : The camera with 3D-DNR provides the intelligent light level control to overcome strong backlight conditions.

→ BLC : The set up area can be seen vividly by the user who set up the desired area to compensate the back light directly according to the installation environment.



- | | |
|--------|--|
| H-POS | Adjust the H(Horizontal)-position of the BLC area. |
| V-POS | Adjust the V(Vertical)-position of the BLC area. |
| H-SIZE | Adjust the H(Horizontal)-size of the BLC area. |
| V-SIZE | Adjust the V(Vertical)-size of the BLC area. |

- ◆ WDR(wide dynamic range) : the function is intended to provide clear images even under back light circumstances where intensity of illumination can vary excessively, namely when there are both very bright and very dark areas simultaneously in the field of view of the camera. (To adjust WDR level, select the LOW, MIDDLE, HIGH by pressing the left or the right button)

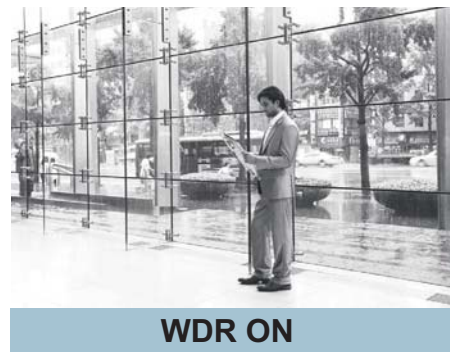
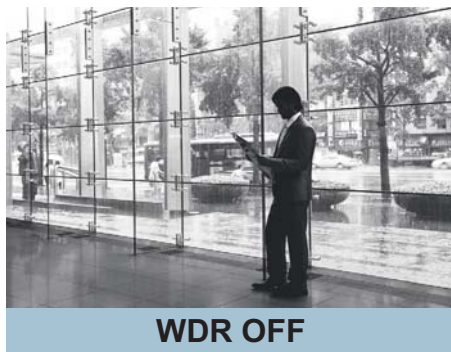

5. DNR

This function makes the noise of the low light background decrease and is a highlighted feature.

1. Move the triangular indicator to DNR on the SETUP menu screen using the Up and Down button
2. Select one of modes(OFF, LOW, MIDDLE, HIGH) to use DNR by pressing the Right or Left button.

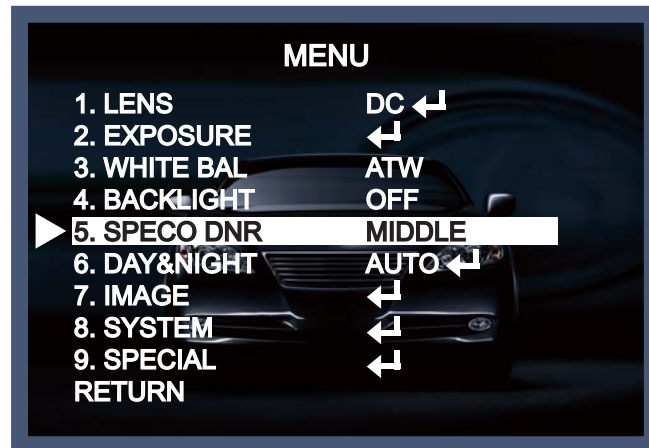

NOTE

* If DNR function is activated, digital noise on image get reduced.

The higher the compensation proportion raises, the better noise cancellation effect is.

However, high DNR value might cause ghost effect on image to occur.

6. DAY&NIGHT

You can change the color mode of color or black / white by setting up the mode.

1. Select DAY&NIGHT using the Up or Down button on the Set Up menu screen.
2. Select one of modes (EXTERN, AUTO, COLOR, B/W) using the Left or Right buttons.

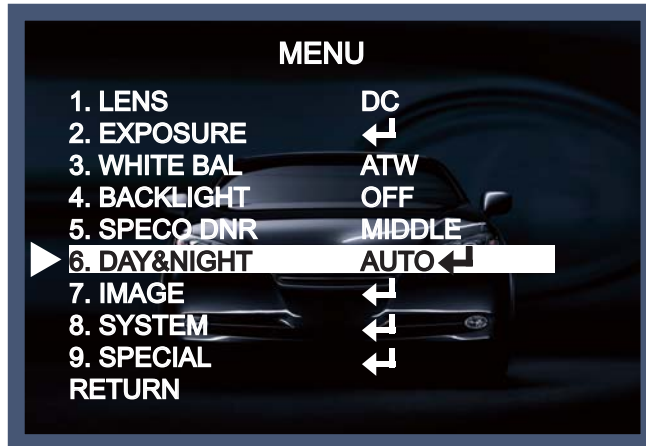

- ◆ EXT : it can change into COLOR or B/W mode automatically through the connection with the ground terminal. Users can adjust SMART-IR level (0 ~ 20), EXTERN S/W Level, and working time of the D/N filter.



- ◆ Auto : Automatically, It shifts into the color mode in the bright environment and the B/W mode in the low light condition. It can adjust the delay time, starting brightness and end brightness according to the ambient conditions by pressing the Set button.



- * SMART IR : It is used to compensate IR saturation (0 ~ 20)
- * AGC THRES : AGC threshold level (0 ~ 20)
- * AGC MARGIN : AGC D/N margin level (0 ~ 20)

◆ COLOR : Making the video output color always.

◆ B / W : Making the video output B/W always. By selecting the color signal On or Off, this lets the burst signal be disappeared or not.



7. IMAGE

This can be used when you want to select the additional function control.

1. When the SETUP menu is displayed, select IMAGE using the Up and Down button.
2. Select one of the mode using the Left or Right buttons.

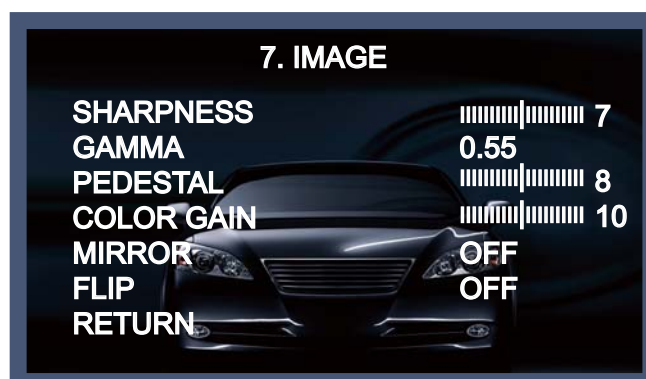
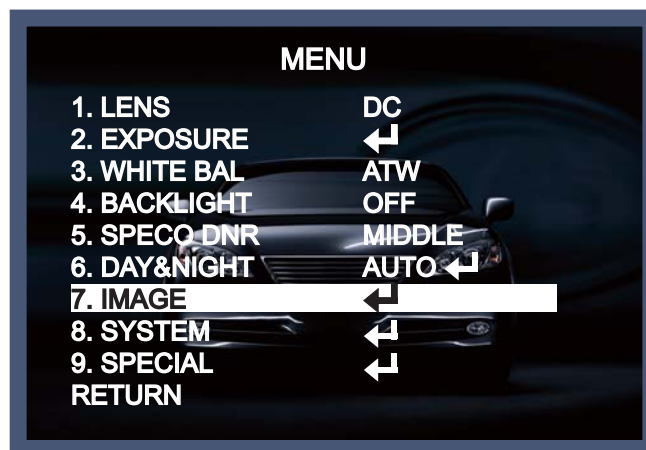

◆ IMAGE

→ SHARPNESS : the outline of an image becomes sharp and more distinct as the level of sharpness increases.
It has better be used to adjust the value to the proper one depending on a sort of image.

(SHARPNESS : 0 ~ 10)

→ GAMMA : Gamma value is adjustable (GAMMA : 0.45 ~ 0.65)

→ PEDSTAL : Pedstal value is adjustable (PEDSTAL : 0 ~ 20)

→ COLOR GAIN : Color gain value is adjustable (COLOR GAIN : 0 ~ 20)

→ MIRROR : The image of the monitor is reversed horizontally.

→ FLIP : The image of the monitor is reversed vertically.



8. SYSTEM

This can be used when you want to select the additional function control.

1. When the SETUP menu is displayed, select SYSTEM using the Up and Down button.
2. Select one of the mode using the Left or Right buttons.

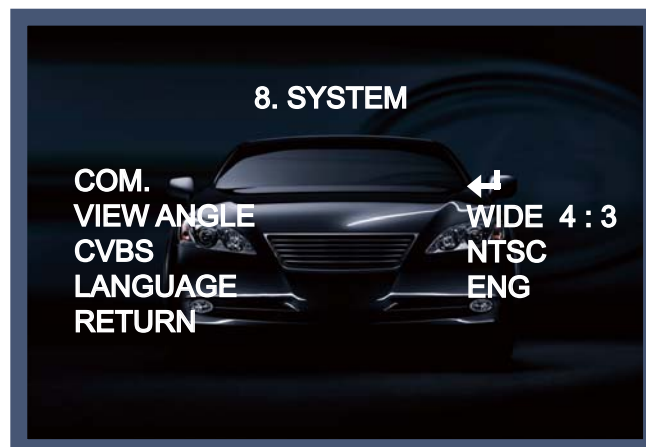
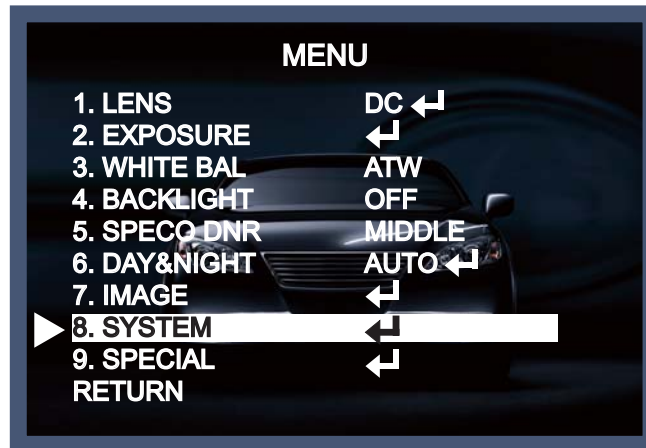

◆ SYSTEM

→ COM : this menu is used for RS-485 communication.

Users are able to select 'CAM ID (0 ~ 255)' and 'BAUDRATE (2400 / 4800 / 9600 / 57600 / 115200)'



→ VIEW ANGLE : users are able to adjust aspect ratio by selecting 'WIDE 4:3', 'WIDE 16:9' or 'NORMAL' depending on monitor aimed for surveillance. (default value : WIDE 4:3

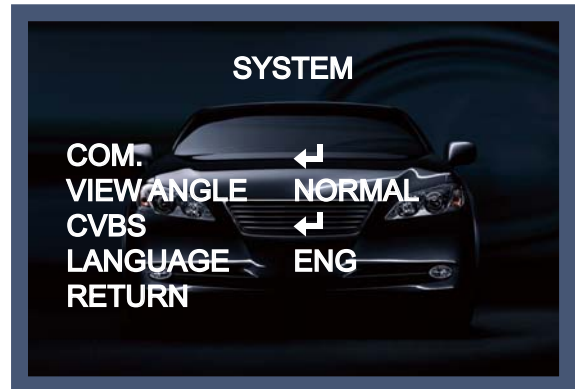
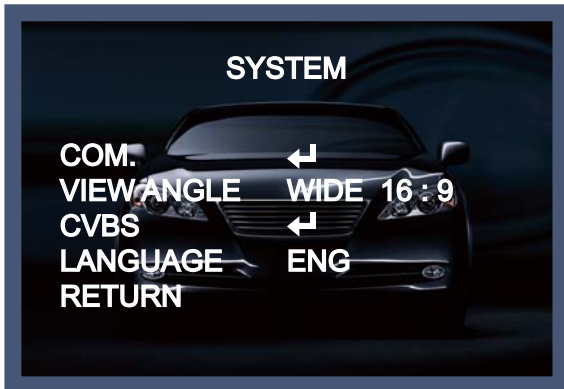
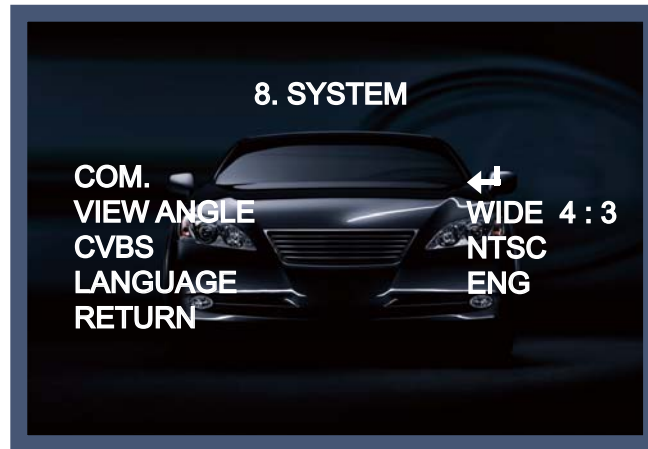

→ CVBS : TV system is manually switchable to 'PAL' or 'NTSC' on CVBS(Composite Video Blanking and Sync).

9. SPECIAL

This can be used when you want to select the additional function control.

1. When the SETUP menu is displayed, select SPECIAL using the Up and Down button.
2. Select one of the mode using the Left or Right buttons.

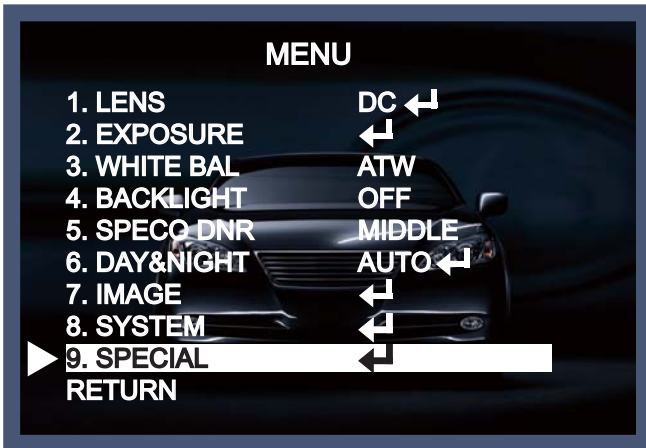

◆ SPECIAL

→ D-ZOOM : digital zoom supports up to x8 available (x1 ~ x8)

The higher the digital zoom magnification is, the lower the resolution is.



→ D-WDR : This camera which is using 3D-DNR DSP provides intelligent light level control to overcome even strong backlight conditions. (OFF / LOW / MIDDLE / HIGH)

→ DEFOG : This function helps to recognize the object in a foggy or dusty weather condition.

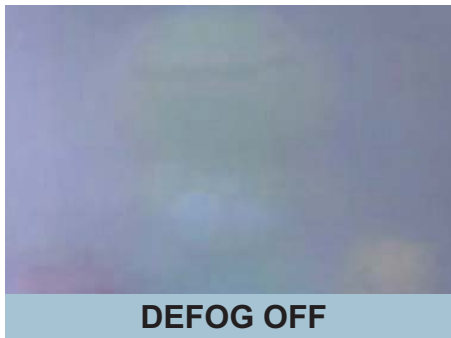

→ SHADING : It is used to increase brightness in case angle of lens set as wide cause darker image on both sides than that on the center.



→ PRIVACY : This is used to hide certain areas on the monitor. You can designate each different 15 area. The size of a designated area can be adjusted.

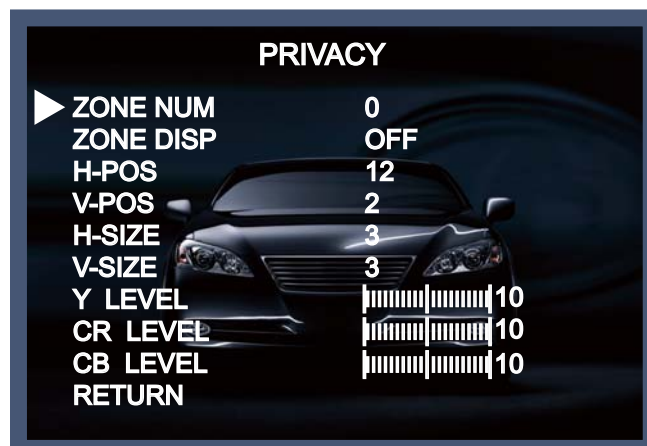

→ INTELLIGENT : It is used for crime prevention & detection by providing intelligent functions based on motion tracking.



◆ INTELLIGENT (MTN TRACKER, ALARM, QUICK ZOOM)

1) MTN TRACKER : it is used to adjust a certain area for motion tracking.

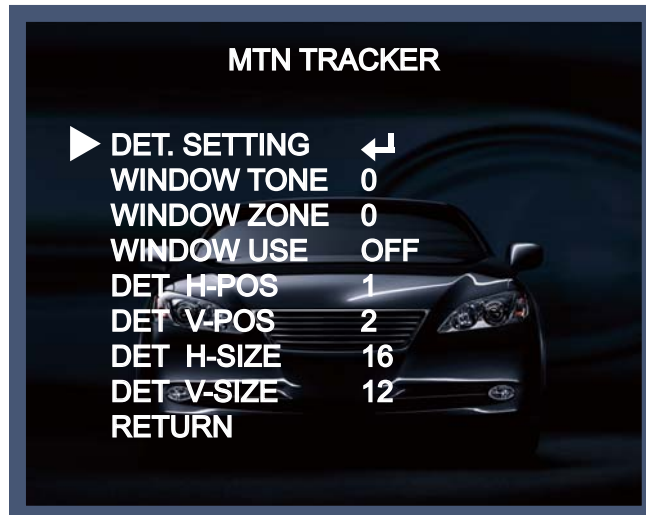

2) ALARM : it is used to set 'ANTI-SHIFT' or 'ANTI-BLOCK' based on motion tracking. scale level of these functions are adjustable.

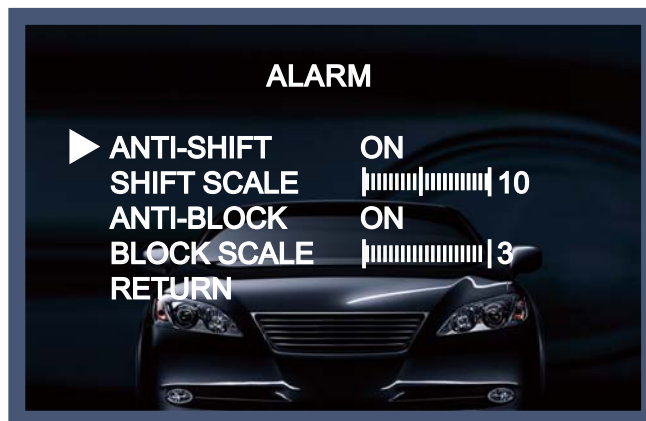



* ANTI-BLOCK: If someone intentionally block the front of camera by hands or spray, etc., it will be automatically detected by a warning message(BLOCKING DETECTED !!!) on monitor.



3) QUICK ZOOM : Digital 'zoom-in' is operated to precisely detect objects when objects get in a designated motion-detection area. The area setting is available on MTN TRACKER(P. 27).

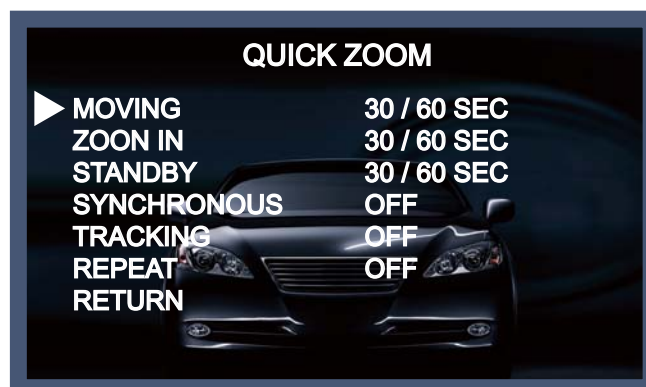



10. RETURN

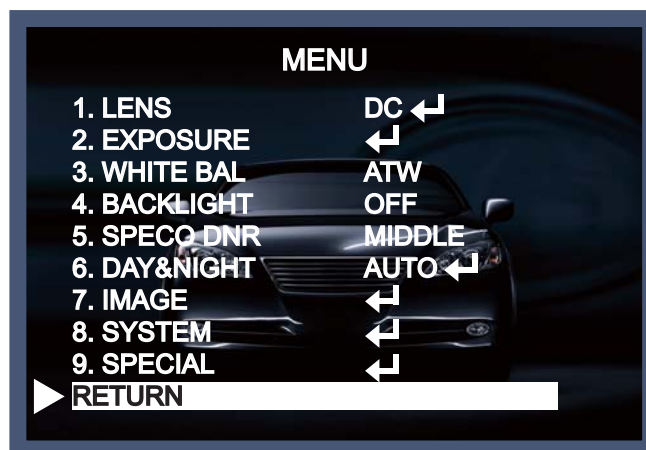

Press 'RETURN' button to save the current settings and exit the setup menu.

• Trouble Shooting

PROBLEM	POSSIBLE CAUSE
Nothing appears on the screen.	☞ Check the power cable, power supply output and video connection between the camera and monitor.
The image on the screen is dim.	☞ Are the camera lens or the lens glass dirty? Clean the lens / glass with a soft clean cloth. ☞ Adjust the monitor controls, as required. ☞ If the camera is facing a very strong light, change the camera position. ☞ Adjust the lens focus.
The image on the screen is dark.	☞ Adjust the contrast control of the monitor. ☞ If there is an intermediate device, correctly set the 75Ω/Hi-z.
The camera is not working properly and the surface of the camera is hot.	☞ Check the camera is correctly connected to an appropriate regulated power source.
Motion Detection is not activated.	☞ Has MOTION DET been set to ON in the menu? ☞ Has MD AREA been properly defined?
The color of the picture is not correct.	☞ Check the settings in WHITE BALANCE menu.
The image on the screen flickers.	☞ Make sure that the camera isn't facing direct sunlight or fluorescent lighting. If necessary, change the camera position.
The INTENSIFY does not work.	☞ Check that the AGC setting in the EXPOSURE menu is not set to OFF. ☞ Check the EXPOSURE menu and make sure SHUTTER is set to----- .



LIMITED WARRANTY - VIDEO PRODUCTS

THIS WARRANTY IS VALID ONLY ON PRODUCTS PURCHASED AND USED IN THE UNITED STATES OF AMERICA AND CANADA. THIS WARRANTY APPLIES ONLY TO THE ORIGINAL USER.

SUBJECT TO CONDITIONS AND EXCLUSIONS FOUND BELOW, THIS PRODUCT IS WARRANTED AGAINST MANUFACTURING DEFECTS IN MATERIAL AND WORKMANSHIP FOR THE FOLLOWING PERIOD FOR PARTS AND LABOR:

SPECO TECHNOLOGIES CAMERAS.....	5 YEARS	DVRs	3 YEARS
SPECO TECHNOLOGIES IP CAMERAS.....	2 YEARS	NVRs	3 YEARS
SPECO PTZ AND VL CAMERAS.....	1 YEAR	BALANCE OF	
SPECO TECHNOLOGIES MONITORS.....	1 YEAR	SPECO TECHNOLOGIES LINE.....	1 YEAR
IR LEADS	90 DAYS		

SPECO TECHNOLOGIES WILL REPAIR OR REPLACE (AT OUR DISCRETION) ANY PARTS FOUND TO BE DEFECTIVE FOR THE WARRANTY PERIOD SPECIFIED. WE WILL PROVIDE A REPLACEMENT FOR ANY DEFECTIVE PART.

CONDITIONS

- 1. YOU MUST OBTAIN A RETURN AUTHORIZATION (RA) NUMBER FOR ANY MERCHANDISE BEING RETURNED TO SPECO TECHNOLOGIES, WHETHER FOR RETURN/EXCHANGE OR REPAIR, WHETHER IN OR OUT OF WARRANTY.**
2. THIS WARRANTY WILL BE HONORED ONLY UPON PRESENTATION OF THE ORIGINAL DATED BILL OF SALE OR SALES SLIP.
3. TRANSPORTATION OF THE PRODUCT TO OUR SERVICE DEPARTMENT IS THE RESPONSIBILITY OF THE USER. REPAIRED OR REPLACED PRODUCT WILL BE RETURNED PREPAID DURING THE WARRANTY PERIOD.
4. SPECO TECHNOLOGIES DOES NOT AUTHORIZE ANY INTERNET OR MAIL ORDER PRODUCT SALES. IF A SPECO TECHNOLOGIES PRODUCT IS PURCHASED FROM AN UNAUTHORIZED DISTRIBUTOR OR OTHER SOURCE, INCLUDING RETAILERS, MAIL ORDER SELLERS AND ONLINE SELLERS, IT WILL NOT BE HONORED OR SERVICED UNDER THE EXISTING SPECO TECHNOLOGIES WARRANTY POLICY. ANY SPECO TECHNOLOGIES PRODUCT PURCHASED FROM THESE ONLINE MERCHANTS WILL VOID THE APPLICABLE WARRANTY AND IS INELIGIBLE FOR TECHNICAL SUPPORT. IF YOU HAVE QUESTIONS ABOUT A RESELLER, PLEASE CONTACT SPECO TECHNOLOGIES AT 1-800-645-5516 FOR A LIST OF UNAUTHORIZED DEALERS, VISIT: www.specotech.com/unauthorized.

EXCLUSIONS

1. THIS WARRANTY SHALL NOT COVER ADJUSTMENT OF CUSTOMER OPERATED CONTROLS AS EXPLAINED IN THE APPROPRIATE Model 's INSTRUCTION MANUAL OR PRODUCTS WHICH HAVE BEEN ALTERED, ABUSED, OR HAVE MISSING OR ALTERED SERIAL NUMBERS.
2. THIS WARRANTY SHALL NOT APPLY TO UNCRATING, SETUP, INSTALLATION, OR THE REMOVAL AND REINSTALLATION OF PRODUCTS AFTER REPAIR.
3. THIS WARRANTY SHALL NOT APPLY TO REPAIRS OR REPLACEMENTS NECESSITATED BY ANY CAUSE BEYOND THE RESULT OF MANUFACTURE INCLUDING, BUT NOT LIMITED TO, ANY MALFUNCTION, DEFECTS OR FAILURE CAUSED BY OR RESULTING FROM UNAUTHORIZED SERVICE OR PARTS, IMPROPER MAINTENANCE, MODIFICATION OR REPAIR BY THE USER, ABUSE, MISUSE, NEGLIGENCE, ACCIDENT, FIRE, FLOOD, OR OTHER ACTS OF NATURE, INCORRECT LINE VOLTAGE, DAMAGE OR IMAGE BURNS TO TELEVISION PICTURE TUBES CAUSED BY OR ATTRIBUTABLE TO THE USE OF ANY ACCESSORY, ELECTRONICS GAME OR DEVICE, OR DAMAGE CAUSED TO IMAGE PICKUP DEVICES BY EXCESSIVE LIGHT.

THE FOREGOING IS IN LIEU OF ALL OTHER EXPRESSED WARRANTIES AND WE DO NOT AUTHORIZE ANY PARTY TO ASSUME FOR US ANY OTHER OBLIGATION OR LIABILITY. IN NO EVENT SHALL WE BE LIABLE FOR INCIDENTAL OR CONSEQUENTIAL DAMAGES ARISING FROM THE USE OF THIS PRODUCT, OR FOR ANY DELAY IN THE USE OF THIS PRODUCT DUE TO CAUSES BEYOND OUR CONTROL. SOME STATES DO NOT ALLOW LIMITATIONS OF HOW LONG AN IMPLIED WARRANTY LASTS AND/OR DO NOT ALLOW THE EXCLUSION OR LIMITATION OF CONSEQUENTIAL DAMAGES. THE ABOVE LIMITATIONS ON IMPLIED WARRANTY AND CONSEQUENTIAL DAMAGES MAY NOT APPLY TO YOU.

THIS WARRANTY GIVES YOU SPECIFIC LEGAL RIGHTS. YOU MAY HAVE OTHER RIGHTS WHICH VARY FROM STATE TO STATE.

NOTE: FOR YOUR PROTECTION IN THE EVENT OF THEFT OR LOSS OF THIS PRODUCT, PLEASE FILL IN THE INFORMATION REQUESTED BELOW AND RETAIN WITH YOUR SALES RECEIPT.

MODEL NO.: _____ SERIAL NO.: _____
(LOCATED ON BACK OR BOTTOM OF UNIT)

DATE OF PURCHASE: _____

WHERE PURCHASED: _____ PURCHASE PRICE: _____

Speco Technologies 200 New Highway Amityville, NY 11701 www.specotech.com	FOR MORE INFORMATION REGARDING SERVICE OR RETURN, CALL US TOLL FREE: 1-800-645-5516 IN METRO NY: 631-957-8700
---	---

ALWAYS USE DISCRETION WHEN INSTALLING VIDEO AND/OR AUDIO SURVEILLANCE EQUIPMENT ESPECIALLY WHEN THERE IS AN EXPECTATION OF PRIVACY. INQUIRE REGARDING FEDERAL, STATE AND/OR LOCAL REGULATIONS APPLICABLE TO THE LAWFUL INSTALLATION OF VIDEO AND/OR AUDIO RECORDING OR SURVEILLANCE EQUIPMENT. PARTY CONSENT MAY BE REQUIRED.

12-300 5/12

▶MEMO



**200 New Highway
Amityville, NY 11701
631-957-8700
1 800 645 5516
www.specotech.com**