

# Installation Guide

## SR2319ADAPT 23" to 19" Rack Mounting Adapter Kit

### Contents

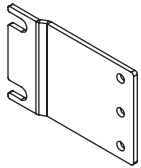

Adapter Brackets (2)

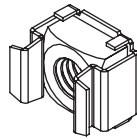
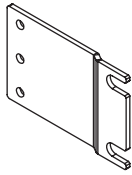

M6 Cage Nuts (4)

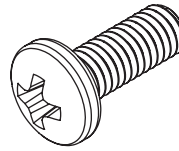

M6 Screws (4)

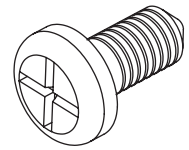

#12-24 Screws (6)

### Installation

Attach and secure the adapter brackets to the front vertical rails of the rack enclosure using two of the included M6 cage nuts and screws (per bracket).

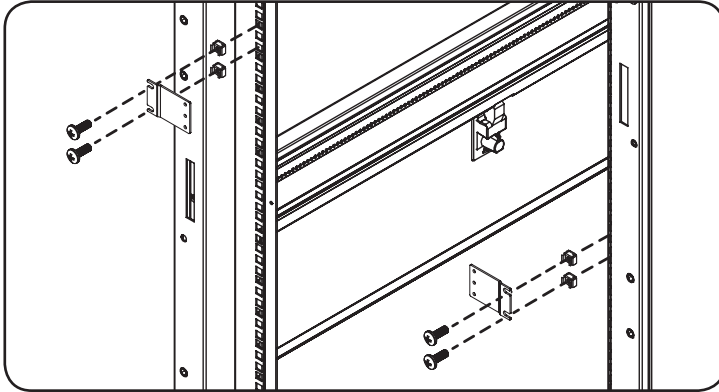

### Mounting Equipment

Use the six included #12-24 screws or appropriate user-supplied hardware to attach equipment to the adapter brackets.

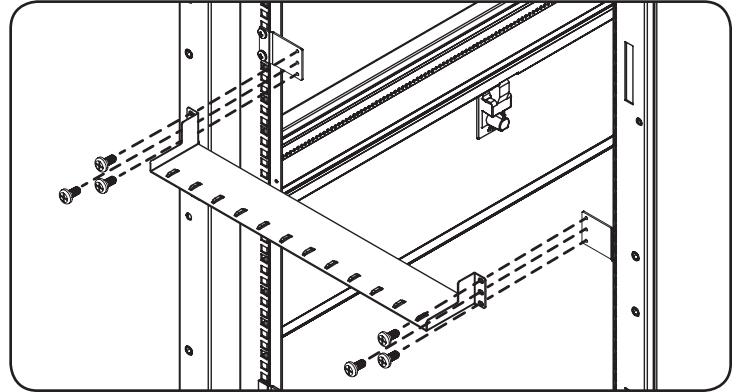

Tripp Lite has a policy of continuous improvement. Specifications are subject to change without notice.

### PROTECT YOUR INVESTMENT!

Register your product for quicker service and ultimate peace of mind.

You could also win an ISOBAR6ULTRA surge protector—a \$100 value!

[www.tripplite.com/warranty](http://www.tripplite.com/warranty)



# TRIPP·LITE



1111 W. 35th Street, Chicago, IL 60609 USA • [www.tripplite.com/support](http://www.tripplite.com/support)

Copyright © 2015 Tripp Lite. All rights reserved.

15-08-358 93-3435\_RevC