

Emerald Series LED HDTV

EM40NF5 40" Class

EM43NF5 43" Class

EM50NF5 50" Class

EM55NF5 55" Class

EM40RF5 40" Class

EM43RF5 43" Class

EM50RF5 50" Class

EM55RF5 55" Class



Before operating your LED TV, please read this manual thoroughly.

(*Images shown in this user manual are for illustration purpose only.)

WE ARE HERE TO HELP!



**FOR HELP WITH TELEVISION SUPPORT:
1-855-868-1928**

WE CAN HELP YOU WITH:
DAMAGED PACKAGE • MISSING PARTS • TECHNICAL SUPPORT

JVC

Contents

Congratulations on purchasing your new JVC TV. To get the most out of your JVC LED TV, read these instructions before making any adjustments, and retain them for future reference.

For assistance, call the JVC Customer Support and Service Center 1-855-868-1928 or visit our website: <http://jvc-tv.com/support>

We recommend that you register your JVC LED TV either at our website: <http://jvc-tv.com/support> or fill out and mail the Product Registration Card on the back of the manual.

Retain your purchase receipt and write down the model and serial number located at the back of your LED TV for easy reference when obtaining service support.

Serial Number: _____
Model Number: _____



MHL, Mobile High-Definition Link and the MHL Logo are trademarks or registered trademarks of the MHL, LLC.



This product qualifies for ENERGY STAR in the "factory default" setting and this is the setting in which power savings will be achieved. Changing the factory default picture setting or enabling other features will increase power consumption that could exceed the limits necessary to qualify for Energy Star rating.



The terms HDMI and HDMI High-Definition Multimedia Interface, and the HDMI Logo are trademarks or registered trademarks of HDMI Licensing LLC in the United States and other countries.



Manufactured under license from Dolby Laboratories. Dolby and the double-D symbol are trademarks of Dolby Laboratories.

THE TRADEMARKS SHOWN HEREIN ARE THE PROPERTY OF THEIR RESPECTIVE OWNERS; IMAGES USED ARE FOR ILLUSTRATION PURPOSES ONLY. JVC, THE JVC LOGO, AND OTHER JVC TRADEMARKS ARE THE INTELLECTUAL PROPERTY OF JVC KENWOOD Corporation. PRODUCT SPECIFICATIONS ARE SUBJECT TO CHANGE WITHOUT NOTICE.

Copyrights © 2015 AmTRAN Video Corporation. ALL RIGHTS RESERVED.

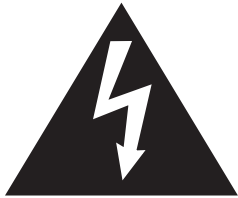

CAUTION
RISK OF ELECTRIC SHOCK
DO NOT OPEN



CAUTION: To Reduce The Risk Of Electric Shock, Do Not Remove Cover (Or Back). No User-Serviceable Parts Inside. Refer Servicing To Qualified Service Personnel.



The lightning flash with arrowhead symbol, within an equilateral triangle is intended to alert the user to the presence of uninsulated dangerous voltage within the product's enclosure that may be of sufficient magnitude to constitute a risk of electric shock.



The exclamation point within an equilateral triangle is intended to alert the user to the presence of important operating and maintenance (servicing) instructions in the literature accompanying the appliance.

WARNING: TO PREVENT FIRE OR SHOCK HAZARD, DO NOT EXPOSE THIS APPLIANCE TO RAIN OR MOISTURE. TO PREVENT THE SPREAD OF FIRE, KEEP CANDLES OR OPEN FLAMES AWAY FROM THIS PRODUCT AT TIMES.

CAUTION: TO PREVENT ELECTRIC SHOCK. DO NOT USE THIS POLARIZED PLUG WITH AN EXTENSION CORD, RECEPTACLE OR OTHER OUTLET UNLESS THE BLADES CAN BE FULLY INSERTED TO PREVENT BLADE EXPOSURE.

WARNING: This device complies with Part 15 of the FCC Rules. Operation is subject to the following two conditions: (1) this device may not cause harmful interference, and (2) this device must accept any interference received, including interference that may cause undesired operation. Note: This equipment has been tested and found to comply with the limits for a Class B digital device, pursuant to Part 15 of the FCC Rules. These limits are designed to provide reasonable protection against harmful interference in a residential installation. This equipment generates, uses, and can radiate radio frequency energy and, if not installed and used in accordance with the instructions, may cause harmful interference to radio communications. However, there is no guarantee that interference will not occur in a particular installation. If this equipment does cause harmful interference to radio or television reception, which can be determined by turning the equipment off and on, the user is encouraged to try to correct the interference by one of the following measures: - Reorient or relocate the receiving antenna. - Increase the separation between the equipment and receiver. - Connect the equipment into an outlet on a circuit different from that to which the receiver is connected. - Consult the dealer or an experienced radio/TV technician for help. FCC Caution: To assure continued compliance, (example – use only shielded interface cables when connecting to computer or peripheral devices). Any changes or modifications not expressly approved by the party responsible for compliance could void the user's authority to operate this equipment.

Responsible Party: AmTRAN Video Corporation
Address: 9 Goddard, Irvine, CA 92618 USA
Telephone No: 1-855-868-1926

CAUTION: Changes or modifications not expressly approved by the party responsible for compliance with the FCC Rules could void the user's authority to operate this equipment.

Location of the required Marking

The rating sheet and the safety caution are on the rear of the unit.

Important Safety Instructions

- 1) Read these instructions.
- 2) Keep these instructions.
- 3) Heed all warnings.
- 4) Follow all instructions.
- 5) Do not use this apparatus near water.
- 6) Clean only with dry cloth.
- 7) Do not block any ventilation openings. Install in accordance with manufacturer's instructions.
- 8) Do not install near any heat sources such as radiators, heat registers, stoves, or other apparatus (including amplifiers) that produce heat.
- 9) Do not defeat the safety purpose of the polarized or grounding-type plug. A polarized plug has two blades with one wider than the other. A grounding-type plug has two blades and a third grounding prong. The wide blade or the third prong are provided for your safety. If the provided plug does not fit into your outlet, consult an electrician for replacement of the obsolete outlet.
- 10) Protect the power cord from being walked on or pinched, particularly at plugs, convenience receptacles, and the point where they exit from the apparatus.
- 11) Only use attachments/accessories specified by the manufacturer.
- 12) Use only with the cart, stand, tripod, bracket, or table specified by the manufacturer, or sold with the apparatus. When a cart is used, use caution when moving the cart/ apparatus combination to avoid injury from tip-over.
- 13) Unplug this apparatus during lightning storms or when unused for long periods of time.
- 14) Refer all servicing to qualified service personnel. Servicing is required when the apparatus has been damaged in any way, such as power-supply cord or plug is damaged, liquid has been spilled or objects have fallen into the apparatus, the apparatus has been exposed to rain or moisture, does not operate normally, or has been dropped.
- 15) Apparatus should not be exposed to dripping or splashing, and objects filled with liquids, such as vases, should not be placed on the apparatus.
- 16) An outside antenna system should not be located in the vicinity of overhead power lines or other electric light or power circuits, or where it can fall into such power lines or circuits. When installing an outside antenna system, extreme care should be taken to keep from touching such power lines or circuits, as contact with them might be fatal.
- 17) Do not overload wall outlets and extension cords, as this can result in a risk of fire or electric shock.
- 18) Do not push objects through any openings in this unit, as they may touch dangerous voltage points or short out parts that could result in fire or electric shock. Never spill or spray any type of liquid into the unit.
- 19) If an outside antenna or cable system is connected to the unit, be sure the antenna or cable system is grounded to provide some protection against voltage surges and built-up static charges, Section 810 of the National Electrical Code, ANSI/NFPA 70, provides information with respect to proper grounding of the mast and supporting structure, grounding of the lead-in wire to an antenna discharge unit, size of grounding conductors, location of antenna discharge unit, connection to grounding electrodes, and requirements for the grounding electrode.
- 20) When replacement parts are required, be sure the service technician uses replacement parts specified by the manufacturer or those that have the same characteristics as the original part. Unauthorized substitutions may result in fire, electric shock or other hazards.
- 21) Upon completion of any service or repairs to this unit, ask the service technician to perform safety checks to determine that the unit is in proper operating condition.



Important Safety Instructions

- 22) When you connect the product to other equipment, turn off the power and unplug all of the equipment from the wall outlet. Failure to do so may cause an electric shock and serious personal injury. Read the owner's manual of the other equipment carefully and follow the instructions when making any connections.
- 23) Sudden high volume sound may cause hearing or speaker damage. When you use headphones, (if the unit is equipped with a headphone jack) keep the volume at a moderate level. If you use headphones continuously with high volume sound, it may cause hearing damage.
- 24) Do not allow the product to output distorted sound for an extended period of time. It may cause speaker overheating and fire.
- 25) This reminder is provided to call the cable TV system installer's attention to Article 820-40 of the NEC that provides guidelines for proper grounding and, in particular, specifies that the cable ground shall be connected to the grounding system of the building, as close to the point of cable entry as practical.
- 26) The socket-outlet must be installed near the unit and easily accessible.

CHILD SAFETY:

It Makes A Difference How and Where You Use TV

Congratulations on your purchase! As you enjoy your new product, please keep these safety tips in mind:

THE ISSUE

The home theater entertainment experience is a growing trend and larger TVs are popular purchases. However, TVs are not always supported on the proper stands or installed according to the manufacturer's recommendations.

TVs that are inappropriately situated on dressers, bookcases, shelves, desks, speakers, chests or carts may fall over and cause injury.

THIS MANUFACTURER CARES!

The consumer electronics industry is committed to making home entertainment enjoyable and safe.

TUNE INTO SAFETY

One size does NOT fit all. Follow the manufacturer's recommendations for the safe installation and use of your TV.

Carefully read and understand all enclosed instructions for proper use of this product.

Don't allow children to climb on or play with furniture and television sets.

Don't place TVs on furniture that can easily be used as steps, such as a chest of drawers.

Remember that children can become excited while watching a program, especially on a "larger than life" TV. Care should be taken to place or install the display where it cannot be pushed, pulled over, or knocked down.

Care should be taken to route all cords and cables connected to the TV so that they cannot be pulled or grabbed by curious children.

CONDENSATION

Moisture will form in the operating section of the unit if the unit is brought from cool surroundings into a warm room or if the temperature of the room rises suddenly. When this happens, unit's performance will be impaired. To prevent this, let the unit stand in its new surroundings for about an hour before switching it on, or make sure that the room temperature rises gradually. Condensation may also form during the summer if the unit is exposed to the breeze from an air conditioner. In such cases, change the location of the unit.

HOW TO HANDLE THE LED PANEL

- Do not press hard or jolt the LED panel. It may cause the LED panel glass to break and injury may occur.
- If the LED panel is broken, make absolutely sure that you do not touch the liquid in the panel. This may cause skin inflammation.
- If the liquid gets in your mouth, immediately gargle and consult with your doctor. Also if the liquid gets in your eyes or touches your skin, consult with your doctor after rinsing for at least 15 minutes or longer in clean water.

Possible Adverse Effects on LED Panel:

If a fixed (non-moving) pattern remains on the LED Panel for long periods of time, the image can become permanently ingrained in the LED Panel and cause subtle but permanent ghost images. This type of damage is **NOT COVERED BY YOUR WARRANTY**. Never leave your TV on for long periods of time while it is displaying the following formats or images:

- Fixed Images, such as stock tickers, video game patterns, TV station logos, and website.
- Special Formats that do not use the entire screen. For example, viewing letterbox style (16:9) media on a normal (4:3) display (black bars at top and bottom of screen); or viewing normal style (4:3) media on a widescreen (16:9) display (black bars on left and right sides of screen).

The following symptoms are not signs of malfunction but technical limitation.

- LED Panels are manufactured using an extremely high level of precision technology, however sometimes parts of the screen may be missing picture elements or have luminous spots. This is not a sign of a malfunction.
- Do not install the TV near electronic equipment that produces electromagnetic waves. Some equipment placed too near this unit may cause interference.
- Effect on infrared devices – There may be interference while using infrared devices such as infrared cordless headphones.

Important Safety Instructions

Television Antenna Connection Protection

External Television Antenna Grounding

If an outside antenna/satellite dish or cable system is to be connected to the TV, make sure that the antenna or cable system is electrically grounded to provide some protection against voltage surges and static charges.

Article 810 of the National Electrical Code, ANSI/NFPA 70, provides information with regard to proper grounding of the mast and supporting structure, grounding of the lead-in wire to an antenna discharge unit, size of the grounding conductors, location of antenna discharge unit, connection to grounding electrodes, and requirements of the grounding electrode.

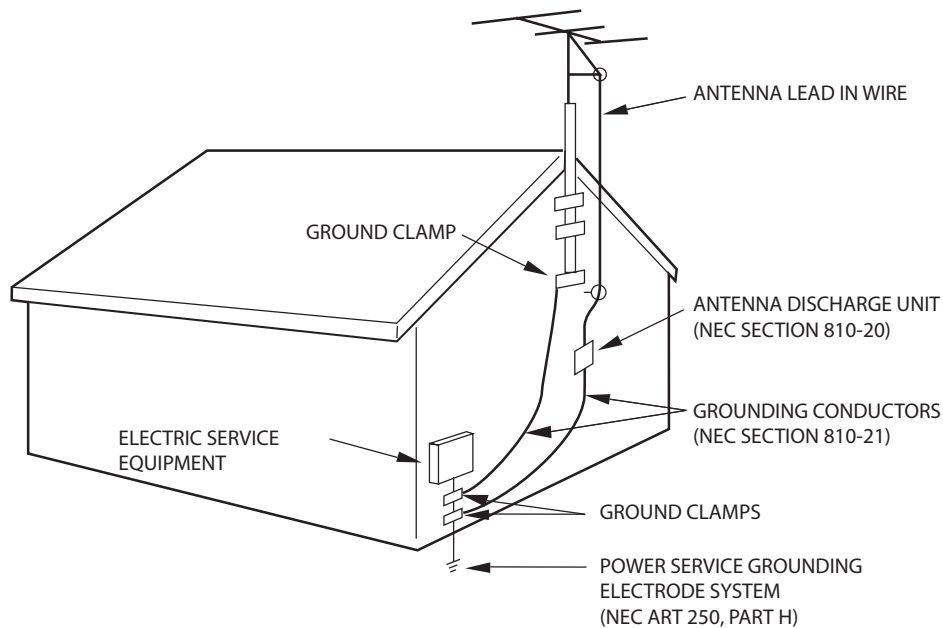

Lightning Protection

For added protection of the TV during a lightning storm or when it is left unattended or unused for long periods of time, unplug the TV from the wall outlet and disconnect the antenna or cable system.

Power Lines

Do not mount the antenna near overhead light or power circuits, or where it could fall into such power lines or circuits.

DTV Transition Advisory

As of June 12, 2009, all U.S. television stations have switched to digital broadcasting. As a result, owners of analog television sets must connect a digital-to-analog converter box to the television set or subscribe to cable or satellite TV to receive over-the-air TV. Analog-only TVs continue to work as before to receive low power, Class A or translator television stations and with cable and satellite TV services, gaming consoles, VCRs, DVD players, and similar products.

For more information about the DTV transition, visit www.dtv.gov.

FCC's Consumer Center

Email: dtvinfo@fcc.gov

Phone: 1-888-CALL-FCC (1-888-225-5322)

Fax: 1-866-418-0232; or writing to:

Mail: Federal Communications Commission

Consumer and Governmental Affairs Bureau

Consumer Inquiries and Complaints Division

445 12th Street, SW

Washington, DC 20554

Attaching the Stand

The stand installation varies depending on model. Perform the installation according to the instructions of your TV model.

Unpacking the TV

- 1** Remove TV accessories and protective foam.
- 2** Remove TV from the box and place it on a flat and clean surface with TV screen facing down.
- 3** Attach the stand to TV using the provided screw.

EM40NF5

EM40RF5

EM43NF5

EM43RF5

EM50NF5

EM50RF5

EM55NF5

EM55RF5

Removing the Stand

When the TV needs to be transported, remove the stand and pack the TV back in the carton.

To remove the stand, perform the assemble steps in reverse order according to your TV model.

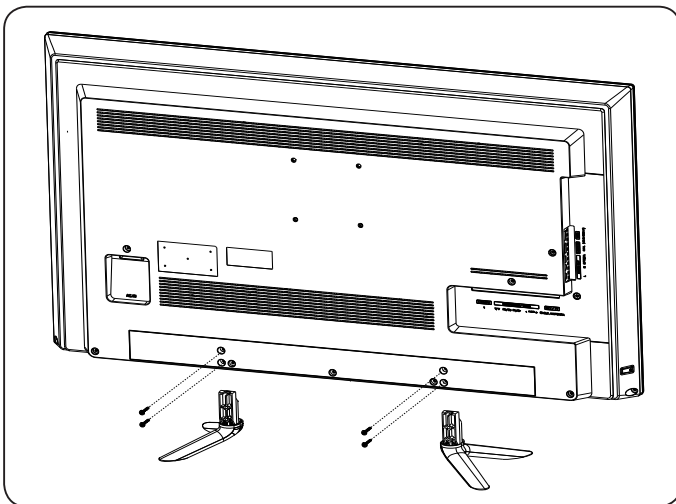

Package Contents

Check if the following items are included in your package.

LED TV



Remote Control



Batteries

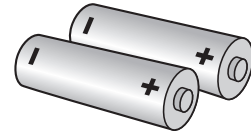

Quick Start Guide



Power Cord



DOWNLOAD FULL VERSION USER MANUAL
<http://jvc-tv.com/support>

Remote Control Batteries

1 Push the tab, then lift to open the cover.



3 Close the battery cover.



2 Insert the batteries, making sure the [+] and [-] polarities are correct.

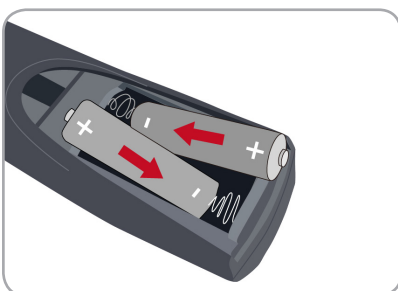

Battery Precautions:

Be sure to follow the correct polarity. Incorrect installation may cause battery leakage or damage the remote control.

Always replace batteries in pair. Do not combine a used battery with a new one.

Do not use different battery types together (e.g. "Alkaline" and "Carbon-zinc").

If the remote control is not to be used for a long period of time, remove the batteries to prevent battery leakage.

Parts and Functions

EM40NF5
EM40RF5

Front View



Power indicator
Remote control IR receiver

EM40NF5
EM40RF5

Rear View

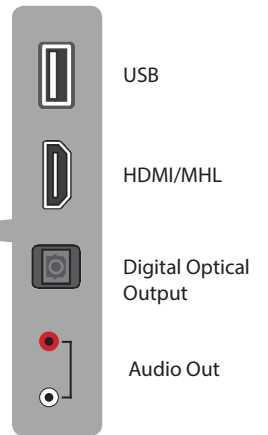
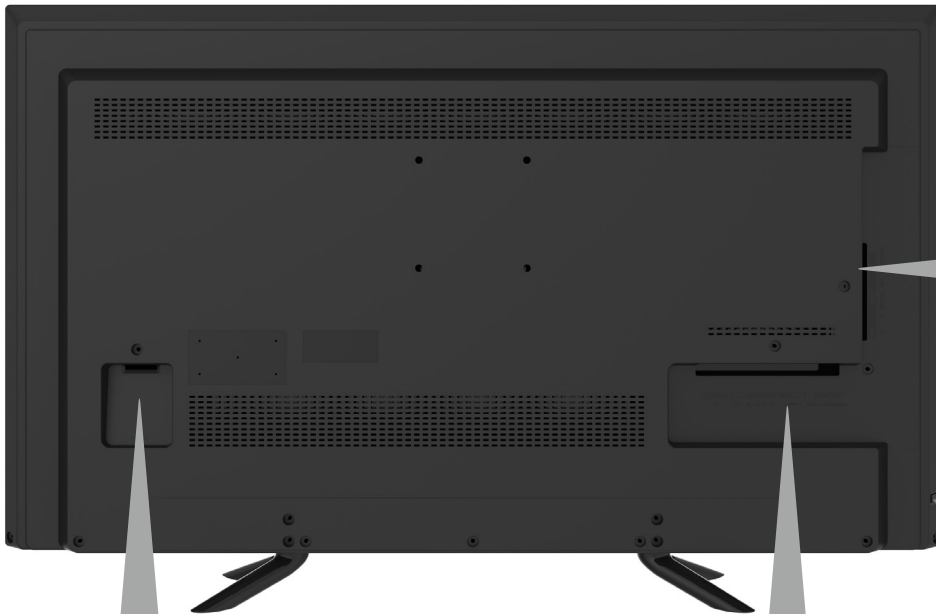

Power Button



AC Power

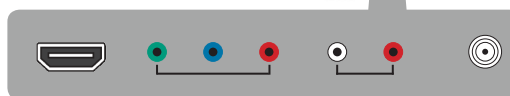

HDMI-1/
ARC

Component/
Video Input

Audio Input/
Music Port

Antenna
Input

Parts and Functions

EM43NF5
EM43RF5

Front View



Power indicator
Remote control IR receiver

EM43NF5
EM43RF5

Rear View

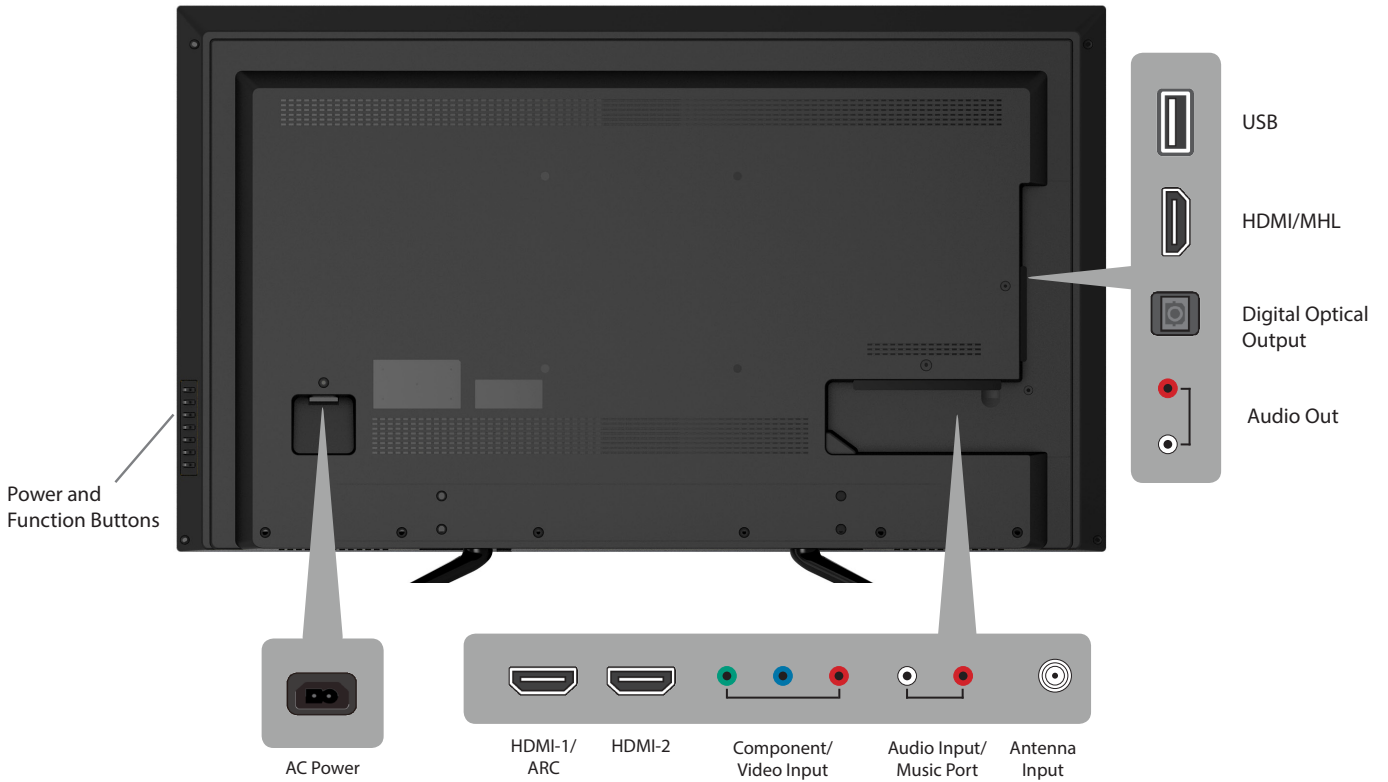

Parts and Functions

EM50NF5
EM50RF5

Front View



Power indicator
Remote control IR receiver

EM50NF5
EM50RF5

Rear View



Power and
Function Buttons

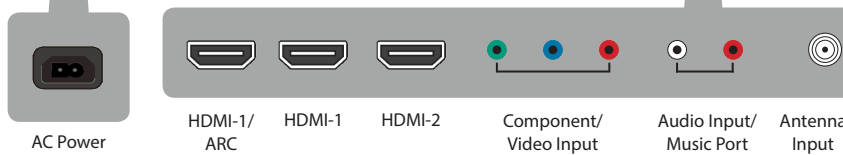
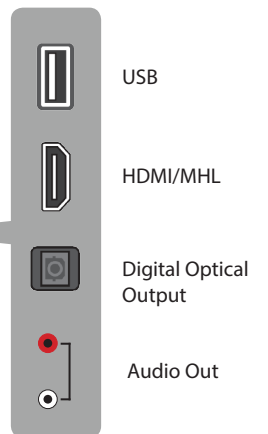

AC Power

HDMI-1/
ARC

HDMI-1

HDMI-2

Component/
Video Input

Audio Input/
Music Port

Antenna
Input

Parts and Functions

EM55NF5
EM55RF5

Front View



Power indicator
Remote control IR receiver

EM55NF5
EM55RF5

Rear View



Power and
Function Buttons

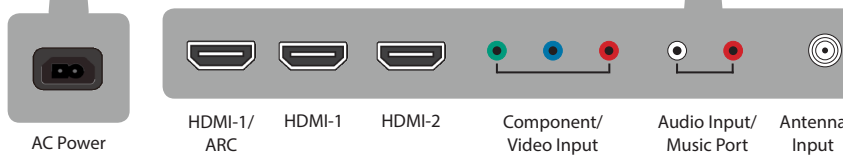
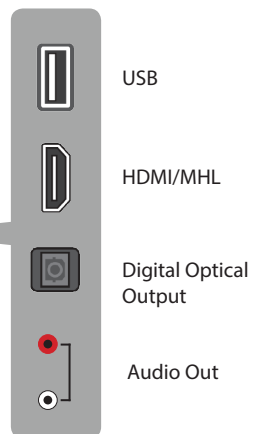

Remote Control (EMxxNF5 Models)

- 1 IR Transmitter:** Sends remote control signal to the TV.
- 2 Remote Control LED:** Lights red when a button is pressed.
- 3 Playback controls:** The buttons are used for Photo, Music, Video, HDMI CEC function.
- 4 BACK:** Go back to previous selection.
- 5 INPUT button:** Changes the input source.
- 6 MUTE button:** Turns the TV audio off or on.
- 7 VOL (Volume) buttons:** Press **VOL [+]** to increase volume or **VOL [-]** to decrease volume.
- 8 Number pad (0~9, -):** Use the number keys to directly change channel.
- 9 POWER button:** Turns the TV on or off.
- 10 MEDIA button:** Enters USB media mode.
- 11 INFO button:** Displays program information (if available).
- 12 MENU button:** Displays the MENU screen.
- 13 AUDIO button:** Enters Audio Only mode and turns the screen off.
- 14 Directional buttons $\wedge / \vee / \langle / \rangle$:** Navigates the menu, selects options, or adjusts setting values.
- 15 OK button:** Enters a menu or confirms an option.
- 16 CH (Channel) buttons:** Use **CH \wedge** to increase the channel number or **CH \vee** to decrease the channel number.
- 17 LAST button:** Return to previous channel.

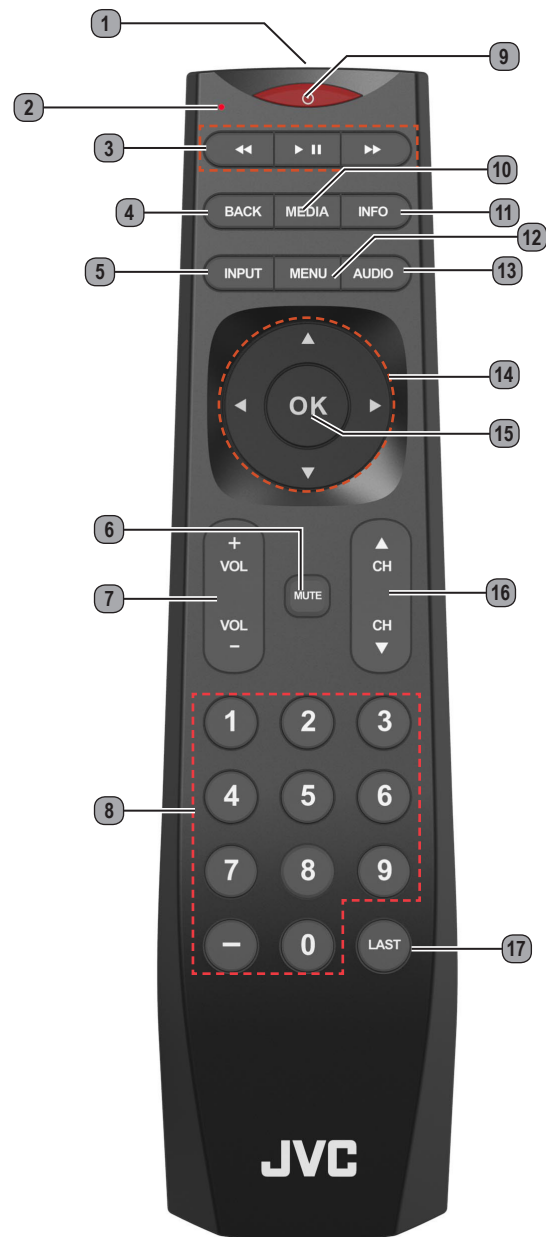

Notes: To obtain best results, use the remote control with a proper distance from the TV and ensure that there are no obstacles between them.

Aim the remote control transmitter to the remote control sensor on the TV.

Do not expose the remote control to direct sunlight. This may affect the performance of the remote control.

Remote Control (EMxxRF5 Models)

- 1 IR Transmitter:** Sends remote control signal to the TV.
- 2 Remote Control LED:** Lights red when a button is pressed.
- 3 **Playback controls:** The buttons are used for Photo, Music, Video, HDMI CEC function.
- 4 ** ←:** Go back to previous selection.
- 5 INPUT button:** Changes the input source.
- 6 MUTE button:** Turns the TV audio off or on.
- 7 VOL (Volume) buttons:** Press **VOL [+]** to increase volume or **VOL [-]** to decrease volume.
- 8 Number pad (0~9, -):** Use the number keys to directly change channel.
- 9 POWER button:** Turns the TV on or off.
- 10 **ROKU home button:** Enter Roku home page.
- 11 **INFO* button:** Enter Roku special options.
- 12 MENU button:** Displays the MENU screen.
- 13 AUDIO button:** Enters Audio Only mode and turns the screen off.
- 14 Directional buttons ▲ / ▼ / ◀ / ▶:** Navigates the menu, selects options, or adjusts setting values.
- 15 OK button:** Enters a menu or confirms an option.
- 16 CH (Channel) buttons:** Use **CH ▲** to increase the channel number or **CH ▼** to decrease the channel number.
- 17 ** ↶ button:** Return to previous channel.

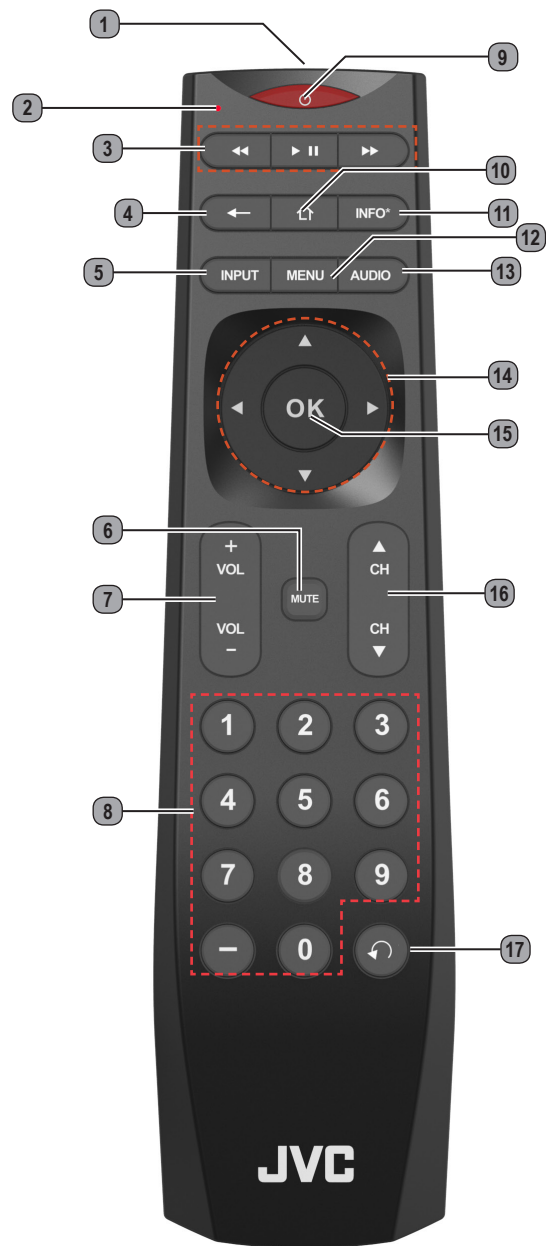

****Compatible with Roku® Streaming Stick™**

Notes: To obtain best results, use the remote control with a proper distance from the TV and ensure that there are no obstacles between them.
Aim the remote control transmitter to the remote control sensor on the TV.
Do not expose the remote control to direct sunlight. This may affect the performance of the remote control.

Making Connections

Connecting Antenna / Cable

Connect the 75 ohm coaxial cable directly to the DTV/TV Cable/Antenna jack of the TV.

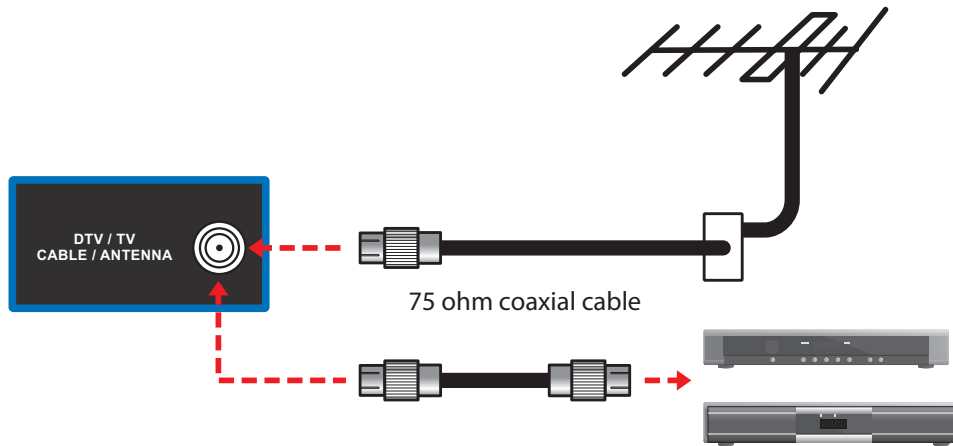

Connecting HD Devices

You can connect different devices to the TV using HDMI, Composite, or Component connections. Check the type of connection available on your device.

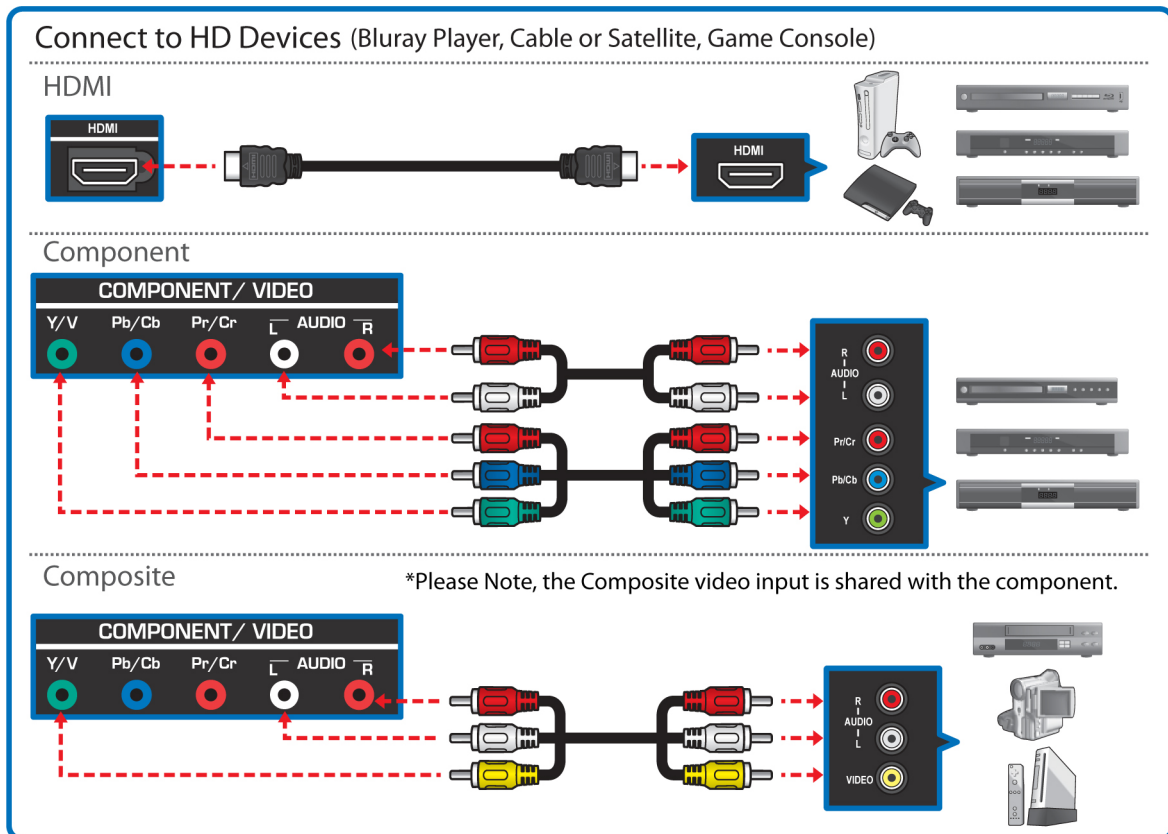

Connecting External Speakers / Soundbar / AV Receivers

Digital Connection

Connect the SPDIF/Optical audio cable to the Audio OUT optical port of the TV and the optical port of the soundbar, AV receiver, or audio system.

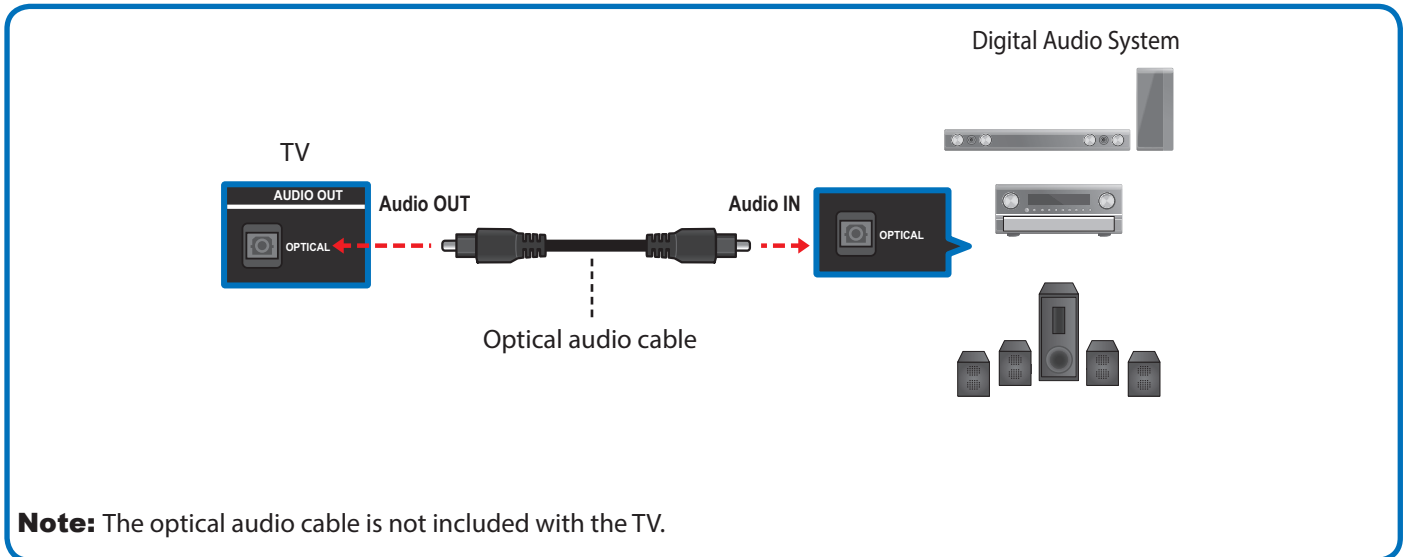

Analog Audio Connection

The TV supports music playback from portable music players, such as an MP3 player or iPod™.

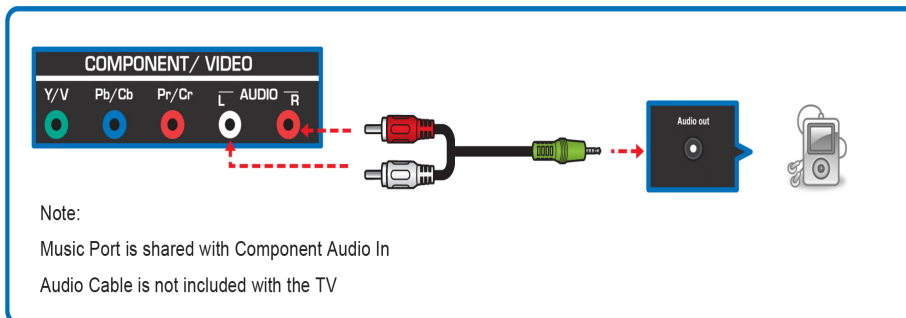

Basic Operations

Setup Wizard

The Setup Wizard will assist you with setting up your TV for the first time. Please follow the instructions carefully.

Note: If you would like to setup over-the-air or cable programming, make sure the antenna or cable TV system is connected.

- 1 When you turn on the TV for the first time, the Setup Wizard screen will appear. Select the menu language, then press **OK**.

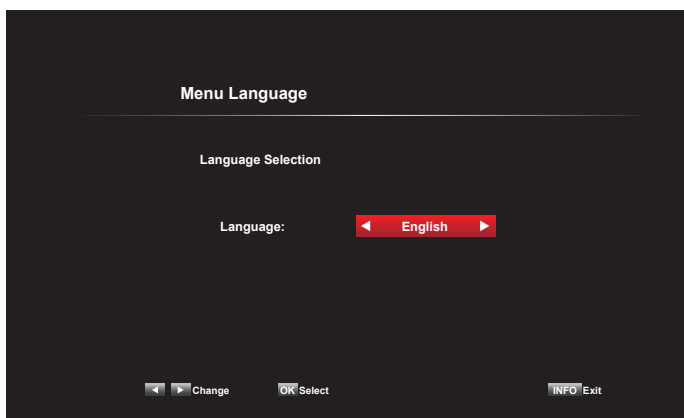

- 2 Select the TV Mode, then press **OK**.

TV Mode options:

Retail Mode: Select this mode for in store demo.

Home Mode: Select this mode for in home mode.

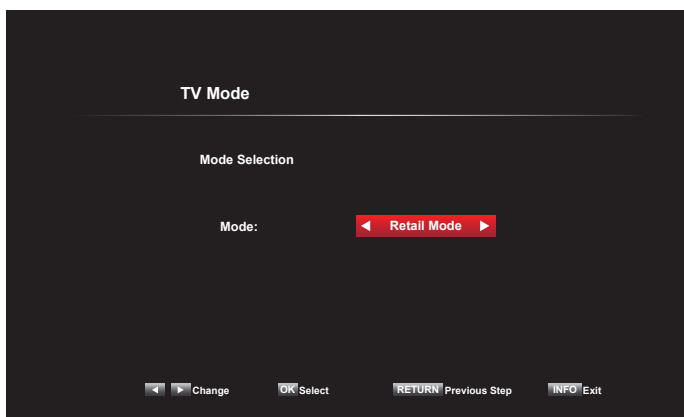

Note: Retail Mode is for retailers only. To exit Retail Mode, see page 18.

- 3 Select Time Zone, then press **OK**.

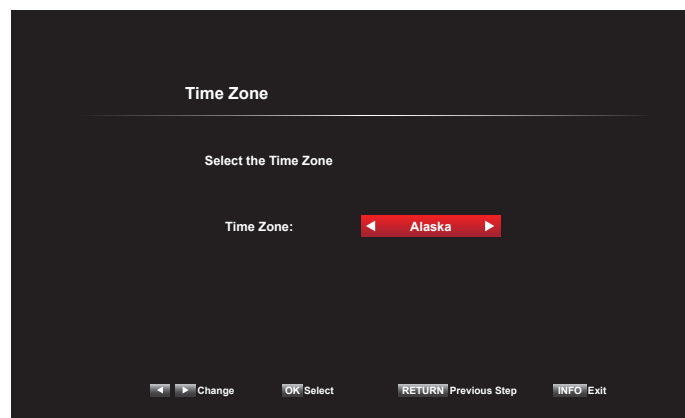

- 4 Set Daylight Saving Time "**ON**" or "**OFF**", then press **OK**.

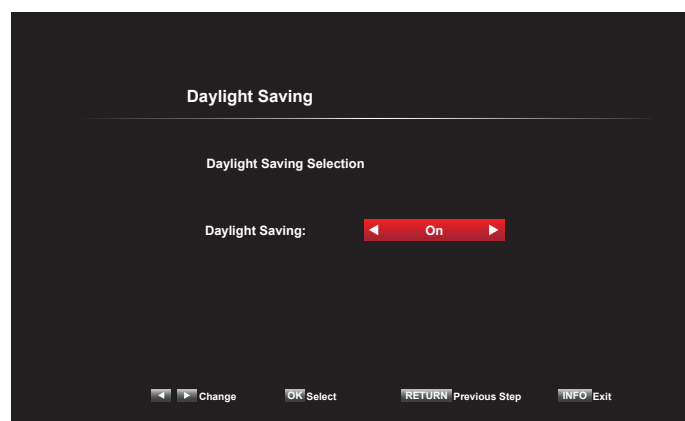

- 5 Select the TV service, then press **OK**.

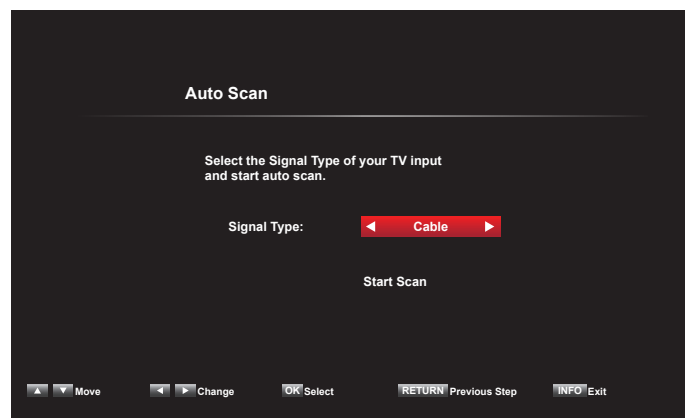

Basic Operations

6 Press **OK** to start channel scan.

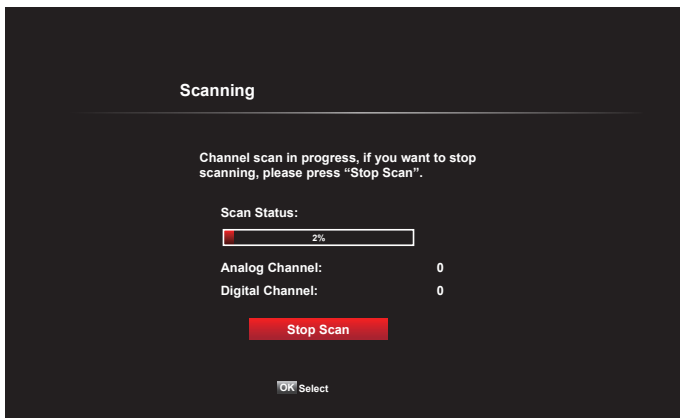

Note: Scanning may take some time to complete. Select Stop Scan to cancel the auto scan at any time.

7 When auto scan is complete, press **OK** to continue.

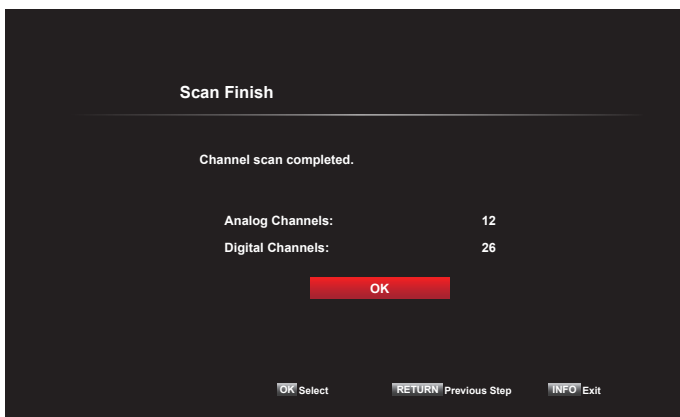

8 Press **OK** to complete setup.

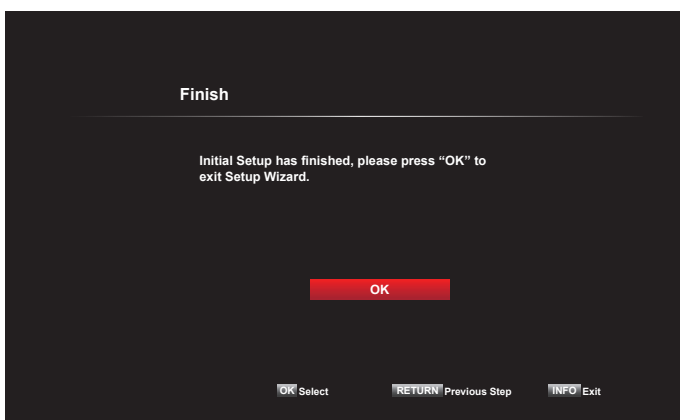

Exit Retail Mode

1 Press **BACK OR** ←.

2 Select **OK** then press **OK** to confirm.

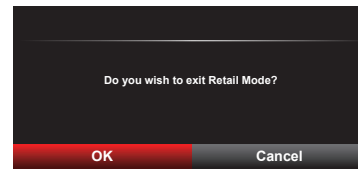

Basic TV Operation

One button operation (only for EM40NF5 & EM40RF5)

The TV power button also serves as multi-function button for input select, TV channel and volume control.

- Press the button to show Quick Control Menu and switch between options
- Press and hold the button to select highlighted option
- To power off TV, press and hold the button while Quick Control Menu is not on screen

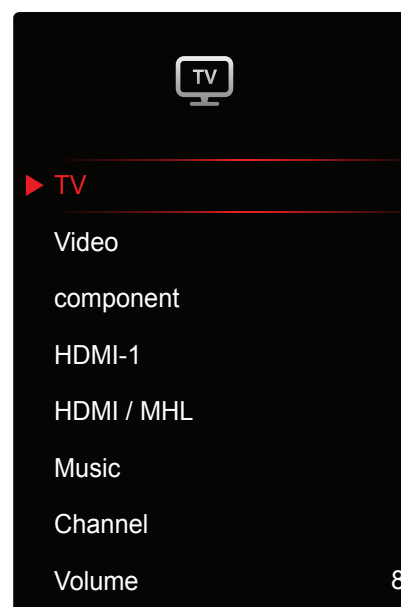

Basic Operations

Changing Channel

Press the number buttons to directly select channels.

Note: After pressing the number buttons, there will be a few seconds delay before the TV changes channel. To change to the channel right away, press **OK** after pressing the number buttons.

To Browse Channel

Press the Channel **▲**/**▼** buttons on the remote control.



To Select Analog Channels

- 1~9 Press 1~9 as needed.
Example, to select channel 2, press **2**, then press **OK**.
- 10~99 Press the 2 digits in order.
Example, to select channel 15, press **1, 5**, then **OK**.
- 100~135: Press the 3 digits in order,
Example, to select channel 130, press **1, 3, 0**, then press **OK**.

To Select Digital Channels

Press the first 3 digits, then press **-**, followed by the remaining number.

Example, to select channel 15-1, press **1, 5, -, 1**, then press **OK**.

To Select by Channel List

All channels found from channel scan are listed on the Channel List screen. You can select channels from this screen.

- 1 Press **OK** to display the Channel List screen.
- 2 Press **▲** or **▼** to select a channel number, then press **OK**.
- 3 Press **BACK OR** **←** to close the Channel List

Mute Volume

Press **MUTE** to turn the sound off. To turn the sound back on, press **MUTE** again or any of the **VOL** buttons.

Set Sleep Timer

Sleep timer sets the TV to automatically turn off after a preset amount of time. After setting a preset amount of time, the TV will automatically turn off after the timer has expired.

- 1 Press **MENU** and select sleep to display the sleep screen.
- 2 Press **▲** or **▼** to scroll through the options, then press **OK**.

To cancel sleep, set the timer Off.

Display Info

Press **INFO** to display the channel or input information on the screen.

Press **INFO** again to hide the Info screen.

Set Aspect Ratio

- 1 Press **Menu** to display the Wide menu.
- 2 Go to **Wide** repeatedly or press **▲** or **▼** to scroll through the options, then press **OK**.

Normal

When watching a 4:3 content, the TV displays a standard picture with black side bars. When viewing a 16:9 content, it displays a full picture.

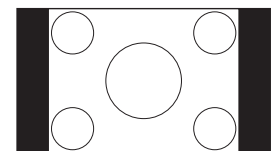

Wide

When displaying a 4:3 content, the picture is stretched horizontally to fill the width of the screen. When watching a 16:9 content, the image is slightly overscan.

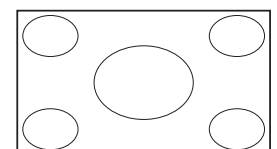

Basic Operations

Zoom

The entire picture is uniformly enlarged to retain its original proportion. However, some parts of the picture may be hidden.

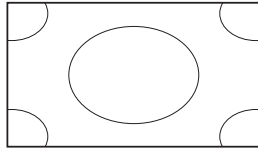

Panoramic

The picture is stretched horizontally on the left and right sides to fill the width of the screen. The center of the picture is not stretched.

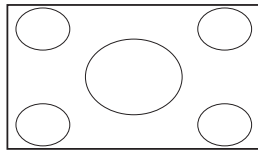

Stretch

The picture is stretched horizontally on the left and right sides.

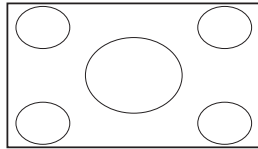

Note: Panoramic mode is only available on 4:3 contents. Stretch is only available on 16:9 contents.

Selecting Input Source

The TV provides various ways to select the input source:

On the Remote Control

Press **INPUT** repeatedly to scroll through the input source options, then press **OK** to select the input.

Picture Mode

The TV Allows you to play image slide shows from a USB memory stick.

Note: Due to the wide variety of picture file formats some formats may not be supported.

Playing Picture Files

1 Insert the USB memory stick into the USB slot of the TV.

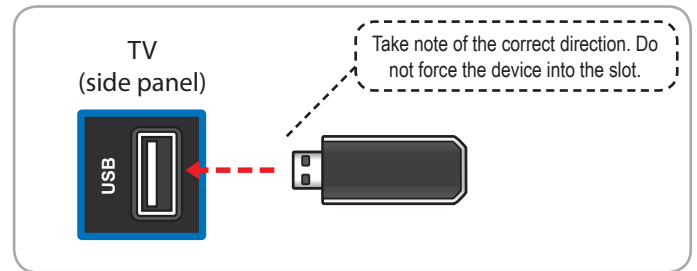

2 A message box will appear on the screen. Press **<** or **>** to select **OK**.

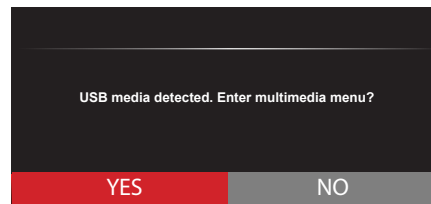

3 Press **OK** to select USB.

Basic Operations

4 The displayed screen varies depending on the media type you selected. Press **▲**, **▼**, **◀** or **▶** to select a file or function, then press **OK**.

Picture Viewer: Photo



1 Start Slideshow button: Play slide show.

2 Sort button: Change sorting order. The label on this button varies depending on the current sorting order. (Name A-Z, Name Z-A, Newest First, Oldest First)

3 View button: Change view mode. The button label varies depending on the current view. (Folders, Thumbnails)

4 Setting button: Change slide show settings.

Audio Only Mode

While watching TV or playing music, you can set the TV to Audio Only mode to turn off the TV display and save power.

1 Press **AUDIO** to activate Audio Only mode. A message appears on the screen, then after a few seconds, the TV display turns off.

2 Press any button to turn on the display again and exit Audio Only mode.

Wall Mount

Installing Wall Mount

The wall mount kit allows you to mount the TV on the wall. For detailed information on installing the wall mount, see the instructions provided with the wall mount kit.

Note: The wall mount kit is not included with the product.



For product protection and safety reasons, JVC strongly recommends contacting a technician or professional for assistance installing the wall mount and setting up the TV. If you decide to install the wall mount and TV without the assistance of a technician or professional, JVC will not be responsible for any damage to the product or injury to yourself or others.



Do not install your wall mount while your TV is turned on. It can result in personal injury due to electric shock.

- 1 Disconnect all cables connected to the TV.
- 2 Carefully place the TV on a flat and clean surface with screen facing down. It is recommended to place the TV cover or protection sheet between the TV and flat surface.
- 3 Remove the screw attaching the stand and TV.
- 4 Remove and store the stand for future use.

Wall Mount

Product Model #	VESA hole pattern (mm)	Standard Screw
EM40NF5/EM40RF5 (40")	100 x 100	M4
EM43NF5/EM43RF5 (43")	200 x 200	M6
EM50NF5/EM50RF5 (50")	200 x 200	M6
EM55NF5/EM55RF5 (55")	400 x 400	M6

Note: The mounting should be strong enough to bear the weight of the display. The wall mounting bracket should have UL or related approval.

Adjusting the Menu Settings

Menu Operation

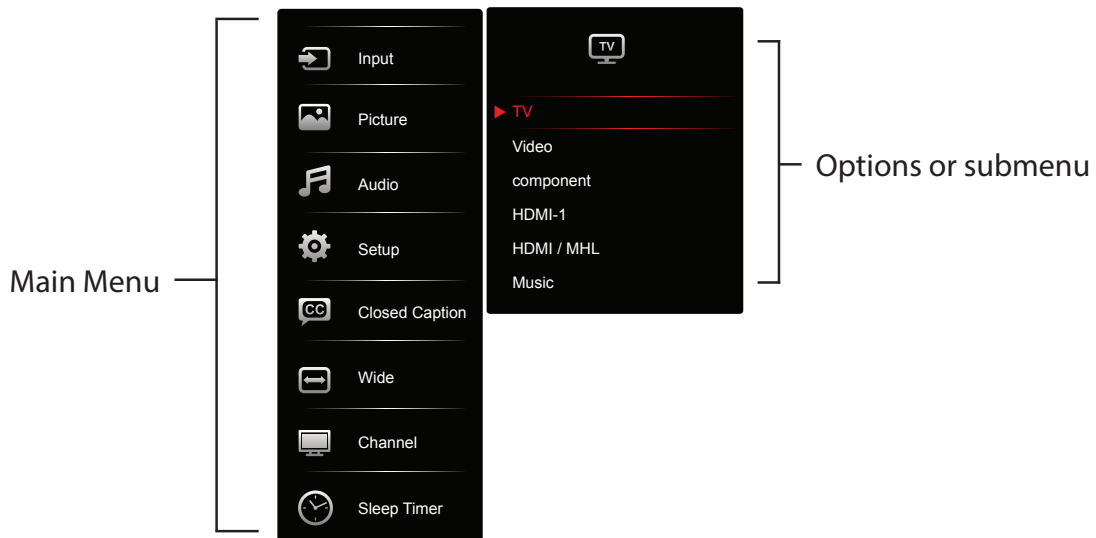

Remote Control	
1 Display the menu.	Press MENU .
2 Select a menu option.	<ol style="list-style-type: none">1. Press ▼ or ▲ to select a menu or option.2. Press OK or ▶ to enter a menu or confirm an option.
3 Adjust or select the setting.	<ol style="list-style-type: none">1. Press ▼ or ▲ to select an option. Or, press ◀ or ▶ to adjust a setting, such as Brightness.2. Press OK to apply the settings.
4 Exit the menu.	To exit the menu, press BACK OR ◀ . Or, to return to a previous screen one at a time, press MENU or ◀ .

Input Menu

Select the input source signal.

TV

To watch analog or digital TV channels.

Video

To use VCRs, camcorders, or game consoles connected via composite connection.

Component

To use VCRs, camcorders, or game consoles connected via component connection.

HDMI-1

To connect HD devices via HDMI Connection.

HDMI/MHL

To connect MHL devices via HDMI/MHL Connection.

Music

To play music from a music player connected via music port.

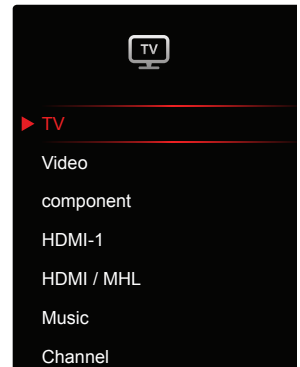

Picture Menu

Select the picture mode.

Picture

Select the picture mode.

Custom	For custom picture settings.
Standard	For standard picture settings.
Movie	For moving pictures such as movies.
Game	For fast and dynamic pictures suitable with playing games.
Vivid	For bright and vivid picture settings.
Sport	Suggested settings for sporting events.

Backlight

Adjusts the backlight that affects the overall brilliance of the picture. (0 ~100)

Contrast

Adjusts the white level in the picture. Low contrast makes pictures look dark, high contrast makes pictures washed out. (0 ~100)

Brightness

Adjusts the brightness setting. (0 ~100)

Color

Adjusts the amount of color level in the picture. (0 ~100)

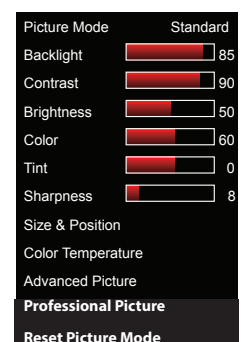

Adjusting the Menu Settings

Tint

Adjusts the sharpness of the edges of elements in the picture.

Sharpness

Selects WIDE to change TV viewing aspect ratio (Normal, Wide, Zoom and Stretch).

Size & Position

Horiz. Position/Vertical Position	Adjusts the horizontal/vertical position of the picture.
Horiz. Size/Vertical Size	Adjusts the horizontal/vertical side of the picture.

Color Temperature

Color Temperature	Apply preset color temperature setting. (Custom/Cool/Natural/Warm)
Red/Green/Blue Gain	Adjusts the red/green/blue gain settings according to your preference.
Red/Green/Blue Offset	Adjusts the red/green/blue offset settings according to your preference.
Reset Color Temperature	Resets the color temperature to default settings.

Advanced Picture

CrystalColor	Produces more vivid and crisp color picture. (Off/Normal/Rich)
Dynamic Contrast	Automatically enhances the image for greater picture details.
Adaptive Backlight	Enables or disable adaptive backlight. (Off/On)
Noise Reduction	Resets the color temperature to default settings.
Digital NR	Reduces noise level of digital signals. (Off/Low/Medium/High)
Film Mode	Produces smoother motion picture when viewing movies.
Super White	Brightens the white color to produce more vibrant images.
Black Enhancement	Enhances black colors to a darker level.

Crystal Color	Off
Dynamic Contrast	Off
Adaptive Backlight	Off
Noise Reduction	Off
Digital NR	Off
Film Mode	Off
Super White	Off
Black Enhancement	Off

Professional Picture

Adjust various professional picture settings.

Reset Picture Settings

Reset the picture mode settings to default.

Audio Menu

XinemaSound 3D*

Thrilling surround sound effects with XinemaSound 3D, which delivers deep bass and crystal clear dialogue.. (Off, Movie, News)

XinemaSound

XinemaSound delivers a natural audio balance, with deep bass, clear dialogue and detailed treble. (Off, Movie, News)

Bass

Adjusts the bass level to your preference. (-12 ~ 12)

Treble

Adjusts the treble level to your preference. (-12 ~ 12)

Balance

Adjusts the audio level of the L/R channels of the speakers to your preference. (-10 ~ 10)

Lip Sync

Adjusts to match the movements and the lips of the person talking on the screen. (0 ~ 5)

TV Speakers

Turn the internal speakers on or off.

Audio Only

Outputs audio from the TV speakers but turns off the TV display.

Digital Audio Out

Selects the type of digital audio output. (Off / Dolby Digital / PCM)

Analog Audio Out

Select the type of analog audio output. (Fixed / Variable)

Reset Audio Mode

Resets the audio mode settings to default settings.

Equalizer Settings

Adjusts the equalizer settings. (120Hz / 500Hz / 1.5KHz / 5KHz / 10KHz)

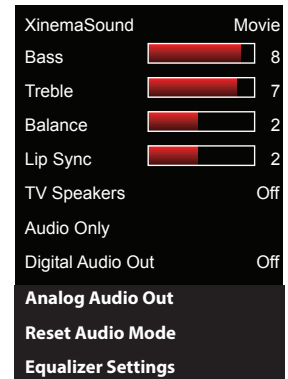

*Available on EM55NF5 & EM55RF5 only.

Adjusting the Menu Settings

Setup Menu

Name Input

The Name Input feature of the TV allows you to add a label name on an input source.

To label an input source , perform the following steps:

- 1 Press **MENU**.
- 2 Press **▼** or **▲** to select "Setup", then press **▶** or **OK**.
- 3 Press **▼** or **▲** to select "Name Input", then press **▶** or **OK**.
- 4 Press **▼** or **▲** to select "Input Source", then press **▶** or **OK**.
- 5 Press **▼** or **▲** to select the input source that you want to add a label name to, then press **OK**.
- 6 To select a custom label:
 1. Press **▼** or **▲** to select "Input Labels", then press **▶** or **OK**.
 2. Press **▼** or **▲** to select "Custom" and press **OK**.

To enter desired label:

1. Press **▼** or **▲** to select the text box, then press **OK**.
2. Press **▼**, **▲**, **◀** or **▶** to select a character, then press **OK**.
3. Press **▼**, **▲**, **◀** or **▶** to select "**OK**", then press **OK**.

Press **BACK OR** **◀** to close the menu screen.

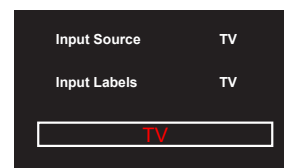
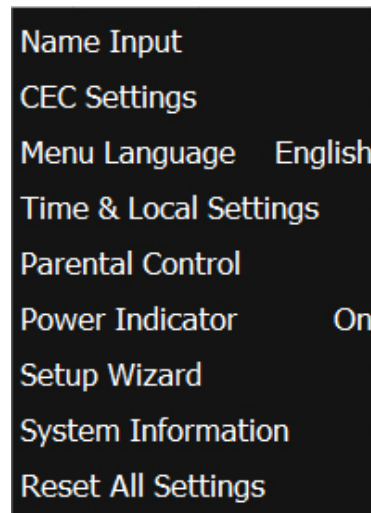

CEC Settings

CEC allows you to control devices using your TV remote control when the CEC devices are connected via HDMI.

CEC Function	Enable or disable CEC function.
Device Search	If CEC Function is enabled, select to search for CEC devices.
System Audio Control	Connect to your device though Audio Return Channel-enabled HDMI Port (HDMI 1)

Menu Language

Selects the on-screen menu language.

Time Zone	Selects a location to apply the time zone.
Daylight Saving	Enables or disables daylight savings time.

Parental Control

The Parental Control feature allows you to control and restrict TV programs by Channel Lock , TV Rating, or Movie Rating.

Access Parental Control Menu

The Parental Control menu requires you to enter the password to access its submenu.

- 1 Press **MENU**.
- 2 Press **▼** or **▲** to select "Setup", then press **▶** or **OK**.
- 3 Press **▼** or **▲** to select "Parental Control", then press **▶** or **OK**.
- 4 Enter the 4-digit password, press **▼**, **◀** or **▶** to select "OK", then press **OK** to access the submenu options.

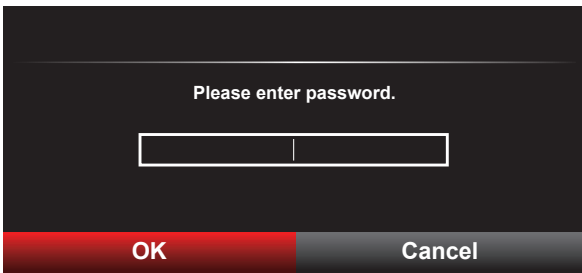

Note: The default password is "0000".

- 5 Press **▼** or **▲** to select the submenu options, then press **▶** or **OK** to enter the submenu.

Restrict By Channel

Use the Channel Lock feature to restrict viewing a specified channel. Once locked channel is selected, the TV displays a blank screen.

- 1 In the "Parental Control" menu, press **▼** or **▲** to select "Channel Lock", then press **▶** or **OK**.
- 2 Press **▼** or **▲** to highlight a channel that you want to lock.
- 3 Press **OK** to mark and lock the channel.
- 4 Press **◀** to return to the previous screen or press **BACK OR ←** to close the menu screen.

Adjusting the Menu Settings

Restrict By TV/Movie Rating

You can select which TV/Movie rating to lock for viewing.

1 In the “Parental Control” menu, press ▼ or ▲ to select a rating submenu, then press ▶ or **OK**.

- **Enable Rating**
Select “On” to enable rating.
- **USA-TV**
Set the rating by age level and genre.
- **CAN-English**
Set by Canadian English movie rating standards.
- **CAN-French**
Set by Canadian French movie rating standards.
- **Block Unrated Shows**
Select “On” to block unrated shows.

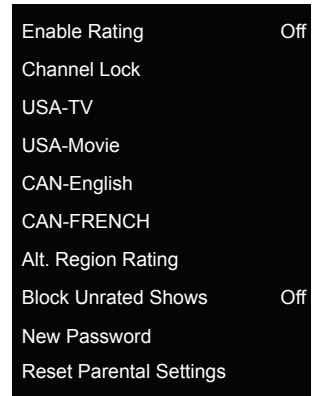

2 Press ▼ or ▲, then press **OK** to select the rating.

3 Press ◀ to return to the previous screen or press RETURN to close the menu screen.

Change Password

1 In the “Parental Control” menu, press ▼ or ▲ to select “Change Password”, then press ▶ or **OK**.

2 Enter a new password, then press **OK**.

3 Re-enter the new password, then press **OK** to complete.

Power Indicator

To turn on/off the LED power indicator while TV is on.

Setup Wizard

Run the guided setup.

System Information

Display the system information of the TV.

Reset All Settings

Reset all TV settings to default settings.

Closed Caption

Closed Caption decodes and displays closed caption data of television programs as subtitle. This feature displays text on the screen or it translates and displays text in another language.

- 1 Press **MENU**.
- 2 Press **▼** or **▲** to select "Closed Caption", then press **▶** or **OK**.
- 3 Press **▼** or **▲** to select "Analog Closed Caption" or "Digital Closed Caption", then press **▶** or **OK**.

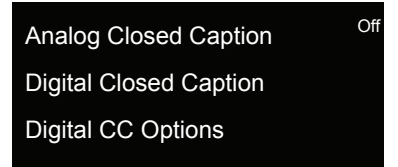

Note: Either "Analog Closed Caption" or "Digital Closed Caption" is available depending on your TV service.

- 4 Press **▼** or **▲** to select a closed caption type or select "Off" to disable this feature, then press **OK**. For digital closed caption, you can select closed caption options, such as text size and text color. Press **▼** or **▲** to select closed caption options, such as text size and text color. Press **▼** or **▲** to select "Digital CC Options", then press **OK**. Select the desired options.
- 5 Press **BACK OR ◀** to close the menu screen.

Wide

Press **MENU** and select wide to change TV viewing aspect ratio.

- 1 Press **▼** or **▲** to select "Wide", then press **▶** or **OK**.
- 2 Press **▼** or **▲** to select "Normal" or "Wide", "Zoom", "Panoramic".

Note: Refer to Basic Operation section for details.

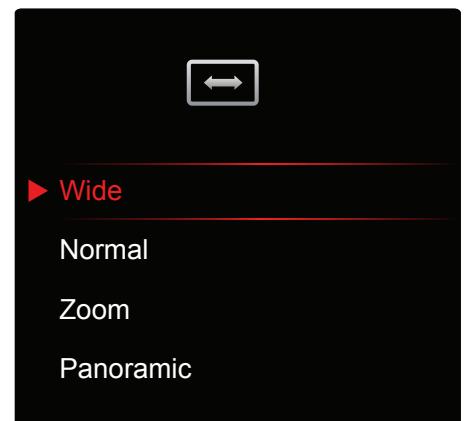

Channel Menu

Select Antenna/Cable

Select Antenna or Cable for the service connected to your TV.

- 1 Press **MENU**.
- 2 Press **▼** or **▲** to select "Channel", then press **▶** or **OK**.
- 3 Press **▼** or **▲** to select "TV Mode", then press **OK**.
- 4 Press **▼** or **▲** to select "Antenna", or "Cable", then press **OK**.



Scan Channels

Auto Scan Channels

When you run auto scan, the TV scans for all available channels. Make sure the antenna/cable is connected properly.

- 1 Press **MENU**.
- 2 Press **▼** or **▲** to select "Auto Channel Scan", then press **▶** or **OK**.
- 3 Press **▼** or **▲** to select "Start Scan", then press **OK**.

Scanning progress is displayed on the menu screen. To stop scanning, select "Stop Scan" and press **OK**.

Note: Auto scan may take 15 to 30 minutes to find available channels.

Partial Scan Channels

You can partially scan for network signal within a specified range of channels.

- 1 Press **MENU**.
- 2 Press **▼** or **▲** to select "Partial Channel Scan", then press **▶** or **OK**.
- 3 Press **▼** or **▲** to select "Scan Mode", then press **▶** or **OK**.
- 4 Press **▼** or **▲** to select an option, then press **OK**.
 - "Analog/Digital": Scans for both analog and digital channels.
 - "Analog": Scans for analog channels.
 - "Digital": Scans for digital channels.
- 5 Press **▼** or **▲** to select "From Channel", then enter a starting channel range.
- 6 Press **▼** or **▲** to select "To Channel", then enter an ending channel range.
- 7 Press **▼** or **▲** to select "Start Scan", then press **OK**.

Scanning progress is displayed on the menu screen. To stop scan, select "Stop Scan" and press **OK**.

Adjusting the Menu Settings

Add Channel

New channels may be added to your area periodically. Use the Add Channel function to add new channels.

- 1** Press **MENU**.
- 2** Press **▼** or **▲** to select "Channel", then press **▶** or **OK**.
- 3** Press **▼** or **▲** to select "Find Channel", then press **▶** or **OK**.
- 4** Press **▼** or **▲** to select "Enter Channel", then enter a channel.
- 5** Press **▼** to select "Add Channel", then press **OK**.

Added channels are listed on the Channel List screen.

Delete Channel

To remove a channel from the Channel List screen.

- 1** Press **MENU**.
- 2** Press **▼** or **▲** to select "Channel", then press **▶** or **OK**.
- 3** Press **▼** or **▲** to select "Channel Management", then press **▶** or **OK**.
- 4** Press **▼** or **▲**, then press **OK** to mark the channels that you want to remove from the Channel List.
- 5** Press **BACK OR ◀** to close the menu screen.

Sleep Timer

Sleep timer sets the TV to automatically turn off after a preset amount of time.

Appendix

Supported Resolution

Model Name	EMxxNF5 & EMxxRF5
Supported HDMI Timing	640 x 480 @ 60, 75Hz
	800 x 600 @ 60, 75Hz
	1024 x 768 @ 60, 75Hz
	1920 x 1080 @ 60Hz
Supported Video Timing (NTSC, Composite)	480i
Supported Video Timing (ATSC, Composite, HDMI)	480i, 480p, 720p, 1080i, 1080p

Troubleshooting

If your TV fails to work properly, check the following guidelines for possible causes and solutions. Consult your local dealer or service outlet if problems persists.

Problem	Solution
No power.	<ul style="list-style-type: none"> • Make sure the power cord is plugged in. • The power is off, press the Power button to turn on the TV. • Try another outlet. • Unplug the unit for an hour, then plug it back in.
Poor sound or no sound.	<ul style="list-style-type: none"> • Press the VOL ▲ button on the remote control or the Power/Multi Function button on the TV to adjust volume . • Press MUTE on the remote control to ensure that mute is not on. • The channel or cable TV is experiencing problems, tune to another channel. • Check the TV audio settings. • Check for possible sources of interference.
Poor picture or no picture.	<ul style="list-style-type: none"> • The channel or cable TV is experiencing problems, tune to another channel. • Make sure that channels are set into memory. • Check the antenna or cable TV connections. • Check for possible sources of interference.
Poor reception on some channels.	<ul style="list-style-type: none"> • The channel or cable TV is experiencing problems, tune to another channel. • Make sure that channels are set into memory. • The network signal is weak, adjust the antenna to receive better reception. • Check for possible sources of interference.
The remote control does not work.	<ul style="list-style-type: none"> • Batteries may be weak, dead, or inserted incorrectly. • Point the remote control directly at the remote sensor on the TV with an angle of 35°. • Remove any obstacles between the remote control and the TV. • Remote control is out of range, move closer to the TV. • Make sure LED Indicator is lit up when any button is pressed.
TV shuts off.	<ul style="list-style-type: none"> • Sleep timer is on. • Power is interrupted.
No CATV reception.	<ul style="list-style-type: none"> • Check all cable TV connections. • Set the TV Mode in Channel menu.
Closed caption is not activated.	<ul style="list-style-type: none"> • The program tuned is not closed captioned. Try another channel. • Enable Closed Caption in the menu.

Specifications

Specifications are subject to change without prior notice.

	EM40NF5 & EM40RF5
Display Specification	
Size Class (diagonal)	40" (actual viewing size 39.5")
Resolution / Aspect:	1920x1080 / 16:9
Backlit:	DLED
Refresh Rate Frame Rate:	60 Hz
Contrast Ratio:	5000:1
TV Features	
Color Enhancement:	Yes
Tuner:	Yes
PIP/POP:	No
Close Caption:	Yes
Parental Control:	Yes
(EPG):	No
Picture Modes:	Yes
Audio	
Audio Technology:	MTS Stereo Decoder
	Dolby Digital Decoder
	(5.1 Ch Pass Through)
Graphic Equalizer:	Yes (XinemaSound Audio Modes)
Speaker Output Power:	10 Watts x 2
Convenience Features	
Ambient Sensor:	No
Interactive Setup Guide:	Yes
Input Port Naming:	Yes
Audio Only Mode:	Yes
HDMI-ARC:	Yes
HDMI-CEC:	Yes
USB Multimedia: (Picture Viewer)	Yes
Remote:	Yes
Energy Saving Features	
Auto Power OFF (DMPS)	Yes
Energy Star:	Yes Energy Star 6.1
Input/ Output	
Input	
Antenna In:	1
HDMI:	2 (side port support MHL)
Component:	1
Composite (RCA):	1 (shared with component)
VGA / RGB:	0
Music Port:	1
USB:	1
Output	
Optical Digital Audio Out:	1
Stereo Audio Out:	1
Mechanical	
Wall Mount Pattern:	100mm x 100mm M4
Without Stand (WxHxD) and Weight (approx.):	35.5" x 20.5" x 2.8" / 15.3 lbs
With Stand (WxHxD) and Weight (approx.):	35.5" x 22.1" x 7.7" / 15.7 lbs

Specifications

Specifications are subject to change without prior notice.

	EM43NF5 & EM43RF5
Display Specification	
Size Class (diagonal)	43" (actual viewing size 42.5")
Resolution / Aspect:	1920x1080 / 16:9
Backlit:	DLED
Refresh Rate Frame Rate:	CM120 Hz
Contrast Ratio:	1200:1
TV Features	
Color Enhancement:	Yes
Tuner:	Yes
PIP/POP:	No
Close Caption:	Yes
Parental Control:	Yes
(EPG):	No
Picture Modes:	Yes
Audio	
Audio Technology:	MTS Stereo Decoder
	Dolby Digital Decoder
	(5.1 Ch Pass Through)
Graphic Equalizer:	Yes (XinemaSound Audio Modes)
Speaker Output Power:	10 Watts x 2
Convenience Features	
Ambient Sensor:	No
Interactive Setup Guide:	Yes
Input Port Naming:	Yes
Audio Only Mode:	Yes
HDMI-ARC:	Yes
HDMI-CEC:	Yes
USB Multimedia: (Picture Viewer)	Yes
Remote:	Yes
Energy Saving Features	
Auto Power OFF (DMPS)	Yes
Energy Star:	Yes Energy Star 6.1
Input/ Output	
Input	
Antenna In:	1
HDMI:	3 (side port support MHL)
Component:	1
Composite (RCA):	1 (shared with component)
VGA / RGB:	0
Music Port:	1
USB:	1
Output	
Optical Digital Audio Out:	1
Stereo Audio Out:	1
Mechanical	
Wall Mount Pattern:	200mm x 200mm M6
Without Stand (WxHxD) and Weight (approx.):	38.1" x 22.4" x 2.8" / 19.4 lbs
With Stand (WxHxD) and Weight (approx.):	38.1" x 24.0" x 7.7" / 19.8 lbs

Specifications

Specifications are subject to change without prior notice.

	EM50NF5 & EM50RF5
Display Specification	
Size Class (diagonal)	50" (actual viewing size 49.5")
Resolution / Aspect:	1920x1080 / 16:9
Backlit:	DLED
Refresh Rate Frame Rate:	CM120 Hz
Contrast Ratio:	3000:1
TV Features	
Color Enhancement:	Yes
Tuner:	Yes
PIP/POP:	No
Close Caption:	Yes
Parental Control:	Yes
(EPG):	No
Picture Modes:	Yes
Audio	
Audio Technology:	MTS Stereo Decoder
	Dolby Digital Decoder
	(5.1 Ch Pass Through)
Graphic Equalizer:	Yes (XinemaSound Audio Modes)
Speaker Output Power:	10 Watts x 2
Convenience Features	
Ambient Sensor:	No
Interactive Setup Guide:	Yes
Input Port Naming:	Yes
Audio Only Mode:	Yes
HDMI-ARC:	Yes
HDMI-CEC:	Yes
USB Multimedia: (Picture Viewer)	Yes
Remote:	Yes
Energy Saving Features	
Auto Power OFF (DMPS)	Yes
Energy Star:	Yes Energy Star 6.1
Input/ Output	
Input	
Antenna In:	1
HDMI:	4 (side port support MHL)
Component:	1
Composit (RCA):	1 (shared with component)
VGA / RGB:	0
Music Port:	1
USB:	1
Output	
Optical Digital Audio Out:	1
Stereo Audio Out:	1
Mechanical	
Wall Mount Pattern:	200mm x 200mm M6
Without Stand (WxHxD) and Weight (approx.):	44.30" x 26.02" x 2.83" / 26.24 lbs
With Stand (WxHxD) and Weight (approx.):	44.30" x 27.91" x 11.60" / 27.56 lbs

Specifications

Specifications are subject to change without prior notice.

	EM55NF5 & EM55RF5
Display Specification	
Size Class (diagonal)	55" (actual viewing size 54.6")
Resolution / Aspect:	1920x1080 / 16:9
Backlit:	DLED
Refresh Rate Frame Rate:	CM120 Hz
Contrast Ratio:	3500:1
TV Features	
Color Enhancement:	Yes
Tuner:	Yes
PIP/POP:	No
Close Caption:	Yes
Parental Control:	Yes
(EPG):	No
Picture Modes:	Yes
Audio	
Audio Technology:	MTS Stereo Decoder
	Dolby Digital Decoder
	(5.1 Ch Pass Through)
Graphic Equalizer:	Yes (XinemaSound 3D)
Speaker Output Power:	15 Watts x 2
Convenience Features	
Ambient Sensor:	No
Interactive Setup Guide:	Yes
Input Port Naming:	Yes
Audio Only Mode:	Yes
HDMI-ARC:	Yes
HDMI-CEC:	Yes
USB Multimedia: (Picture Viewer)	Yes
Remote:	Yes
Energy Saving Features	
Auto Power OFF (DMPS)	Yes
Energy Star:	Yes Energy Star 6.1
Input/ Output	
Input	
Antenna In:	1
HDMI:	4 (side port support MHL)
Component:	1
Composit (RCA):	1 (shared with component)
VGA / RGB:	0
Music Port:	1
USB:	1
Output	
Optical Digital Audio Out:	1
Stereo Audio Out:	1
Mechanical	
Wall Mount Pattern:	400mm x 400mm M6
Without Stand (WxHxD) and Weight (approx.):	TBD
With Stand (WxHxD) and Weight (approx.):	TBD

Limited Warranty

ON PARTS AND LABOR

This Limited Warranty covers units that are purchased as new and in the United States Only. This Product is manufactured, distributed, and warranted by AmTRAN Video Corporation (hereinafter known as "Warrantor") under brand license by JVC KENWOOD Corporation. The Warrantor provides a warranty to the original purchaser of a new Product against defects in materials and workmanship for a period of one (1) year of non-commercial usage and ninety (90) days of commercial use. If a Product covered by this warranty is determined to be defective within the warranty period, the Warrantor will either repair or replace the Product at its sole option and discretion.

To obtain warranty service, contact our Technical Support:

Visit the Web Site: <http://jvc-tv.com/support>
Or call our Customer Support and Service Center
1-855-868-1928

PRE-AUTHORIZATION MUST BE OBTAINED BEFORE SENDING ANY PRODUCT TO A DESIGNATED SERVICE CENTER. Proof of purchase in the form of a purchase receipt or copy thereof is required to show that a Product is within the warranty period.

Parts and Labor

There will be no charge for parts or labor during the warranty period. Replacement parts and Products may be new or recertified at the Warrantor's option and sole discretion. Replacement parts and Products are warranted for the remaining portion of the original warranty or for ninety (90) days from warranty service or replacement, whichever is longer.

Type of Service

Defective Products must be sent to the designated service center to obtain warranty service. The Warrantor is not responsible for the transportation costs to the service center, but will cover the costs for return shipping to the customer. PRE-AUTHORIZATION IS REQUIRED BEFORE SENDING ANY PRODUCT TO A DESIGNATED SERVICE CENTER FOR WARRANTY SERVICE.

Product returned to designated service centers must utilize either the original carton box and shipping material or packaging that affords an equal degree of protection. Technical Support will provide instructions for packing and shipping the covered Product to the designated service center.

Limitations and Exclusions

The Warrantor's one-year limited warranty only covers defects in materials and workmanship. This warranty does not cover product issues caused by any other reason, including but not limited to cosmetic damage, normal wear and tear, improper operation, improper voltage supply or power surges, signal issues, damages from shipping, acts of God, any type of customer misuse, modifications or adjustments, as well as installation and set-up issues or any repairs attempted by anyone other than by an authorized service center. Products with unreadable or removed serial numbers, or requiring routine maintenance are not covered. This one year limited warranty does not cover Products that are sold "AS IS", "Open Box", "FACTORY RECERTIFIED", or by a non-authorized reseller.

THERE ARE NO EXPRESS WARRANTIES OTHER THAN THOSE LISTED OR DESCRIBED ABOVE. ANY IMPLIED WARRANTIES, INCLUDING ANY IMPLIED WARRANTY OF MERCHANTABILITY, AND FITNESS FOR A PARTICULAR PURPOSE, SHALL BE LIMITED IN DURATION TO THE PERIOD OF TIME SET FORTH ABOVE. THE WARRANTOR'S TOTAL LIABILITY FOR ANY AND ALL LOSSES AND DAMAGES RESULTING FROM ANY CAUSE WHATSOEVER INCLUDING WARRANTOR'S NEGLIGENCE, ALLEGED DAMAGE, OR DEFECTIVE GOODS, WHETHER SUCH DEFECTS ARE DISCOVERABLE OR LATENT, SHALL IN NO EVENT EXCEED THE PURCHASE PRICE OF THE PRODUCT. THE WARRANTOR SHALL NOT BE RESPONSIBLE FOR LOSS OF USE, LOSS OF INFORMATION OR DATA, COMMERCIAL LOSS, LOST REVENUE OR LOST PROFITS, OR OTHER INCIDENTAL OR CONSEQUENTIAL DAMAGES. SOME STATES DO NOT ALLOW LIMITATIONS ON HOW LONG AN IMPLIED WARRANTY LASTS OR THE EXCLUSION OF INCIDENTAL OR CONSEQUENTIAL DAMAGES, SO THE ABOVE LIMITATIONS OR EXCLUSIONS MAY NOT APPLY TO YOU. THIS WARRANTY GIVES YOU SPECIFIC LEGAL RIGHTS, AND YOU MAY ALSO HAVE OTHER RIGHTS, WHICH VARY FROM STATE TO STATE. THIS WARRANTY IS SUBJECT TO CHANGE WITHOUT NOTICE. CHECK TV.JVC.COM FOR THE MOST CURRENT VERSION.

Personal Data

If your Product is capable of storing personal data and other information, all contents and information will be deleted in the course of some in-home and all ship-in warranty service. If this occurs, your product will be restored to you configured as originally purchased. You will be responsible for restoring all applicable data and passwords. Recovery and reinstallation of user data is not covered under this Limited Warranty. In order to protect your personal information, we recommends that you always clear all personal information from the unit before it is serviced, regardless of the servicer.

Important Open Source Software Notice

Some JVC device may contain free software which is based on the license granted under the GNU General Public License and Lesser General Public License (hereinafter "GPL/LGPL") that are subject to the GPL2.0/LGPL2.1 You may use, modify, or distribute only if you agree to all of the terms and conditions of the GPL/LGPL. For more details on the list of JVC devices with open source software, please visit : <http://jvc-tv.com/support>

Please note that any software component developed or created independently by AmTRAN Video Corporation shall not be subject to "GPL/LGPL" requirement for provision of the source code. Users are urged to read the details for the relevant license carefully before using the software component covered by "GPL/LGPL."

You can obtain a copy of the GPL/LGPL license from <http://www.gnu.org/licenses/gpl> and <http://www.gnu.org/licenses/lgpl>.

For details of any open source software on your JVC device, please visit the following web site: <http://jvc-tv.com/support>

Please note that we are unable to answer any inquiry relating to the contents, etc of the source code. Permission is hereby granted, free of charge, to any person obtaining a copy of any such software and associated documentation files (the "Open Source Software"), to deal in the Open Source Software without restriction including without limitation the rights to use, copy, modify, merge, publish, distribute, sublicense, and/or sell copies of the Open Source Software, and to permit persons to whom the Open Source Software is furnished to do so, subject to the following conditions:

THE SOFTWARE IS PROVIDED "AS IS", WITHOUT WARRANTY OF ANY KIND, EXPRESS OR IMPLIED, INCLUDING BUT NOT LIMITED TO THE WARRANTIES OF MERCHANTABILITY, FITNESS FOR A PARTICULAR PURPOSE AND NON-INFRINGEMENT, IN NO EVENT SHALL THE AUTHORS OR COPYRIGHT HOLDERS BE LIABLE FOR ANY CLAIM, DAMAGES OR OTHER LIABILITY, WHETHER IN AN ACTION OF CONTRACT, TORT OR OTHERWISE, ARISING FROM, OUT OF OR IN CONNECTION WITH THE SOFTWARE OR THE USE OR OTHER DEALINGS IN THE SOFTWARE.

Third Party Application Notice

You may encounter third-party applications (including links to websites, widgets, software or other software utilities ("Applications") that interact with the Product. Such Applications are owned and operated by third parties that are not related to or sponsored by us. Use of an Application through the Product is at your own option and risk. We do not endorse any included third-party Applications or third-party products or services. Your use of included Applications is subject to the terms of use and privacy policy of the Application provider.

JVC

Do not send product or other
correspondence to this address

Place
Stamp
Here

JVC

Attn: Product Registration

**P.O. BOX 50427
IRVINE, CA 92619**

Register Online: <http://jvc-tv.com/support>

First Name	
Last Name	
Address	
Apt. #	
City	
State	
Zip Code	
Phone Number	
E-mail Address	

Model Number	
Serial Number	
Dealer Name	
Purchase Price	
Date of Purchase	
Comments	

I would like to receive the JVC Community e-mail newsletter

WE ARE HERE TO HELP!



**FOR HELP WITH TELEVISION SUPPORT:
1-855-868-1928**

WE CAN HELP YOU WITH:
DAMAGED PACKAGE • MISSING PARTS • TECHNICAL SUPPORT

JVC