

STYLEVIEW® QUICK REFERENCE

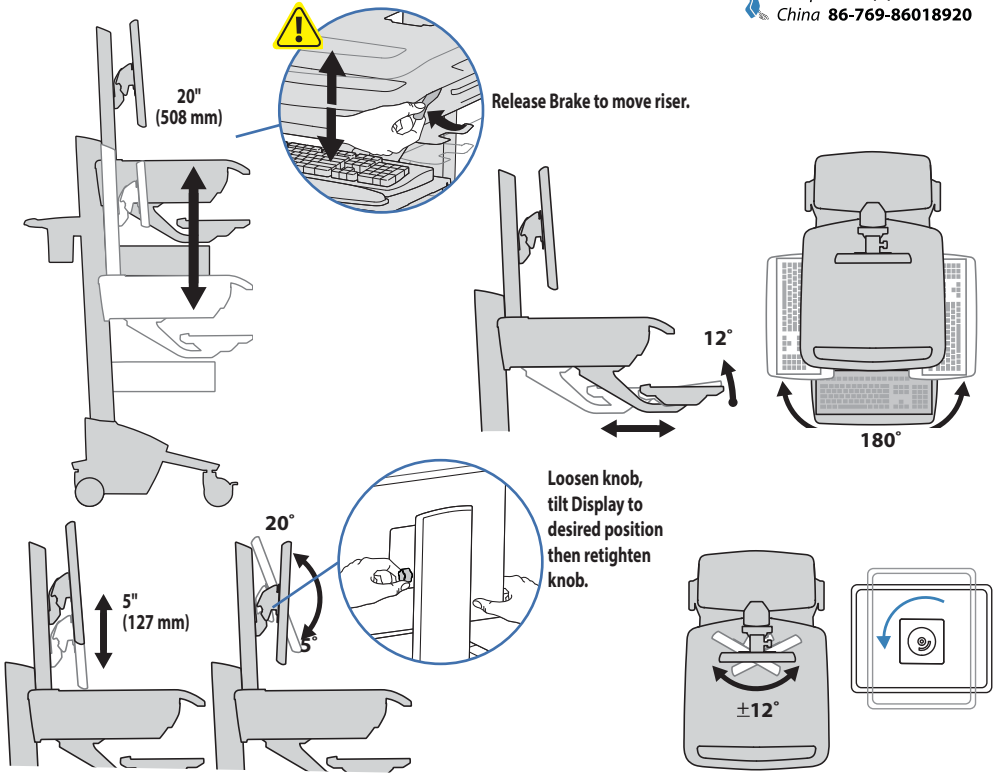

RANGE OF MOTION



ERGONOMICS

Working customize - to your size

- 1 Set top of monitor screen about one inch below eye level - Release brake and lift or lower riser as needed.
- 2 Tilt screen for comfortable viewing and to reduce eye and neck strain.
- 3 Pull keyboard tray forward and position mouse tray and mouse pouch on right or left, as needed.
- 4 Work with elbows bent at about 90° to minimize muscle strain.
- 5 If the riser moves up and down with difficulty, or if it drifts out of set position, consult the product manual for adjustment information.
- 6 Stay in charge!

Powered carts should be plugged into outlet as often as possible to keep battery charged and computer running.

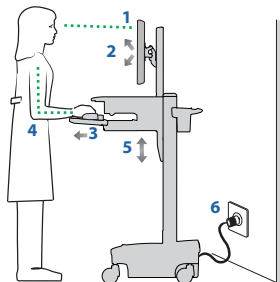

Moving slow - before you go

- 1 During normal movement, release brake and lower worksurface to lowest position for optimal stability and unobstructed view.
- 2 Tuck away open trays and return mouse, scanner and other accessories to their places. Clear worksurface
- 3 Unlock both front casters.
- 4 Push cart from rear with elbows bent at about 90° to maximize control and minimize muscle strain.
- 5 Don't run out!
Before moving, make sure cord is unplugged from outlet and hooked to basket for safe travel. Remember, charge battery fully 100% every day!

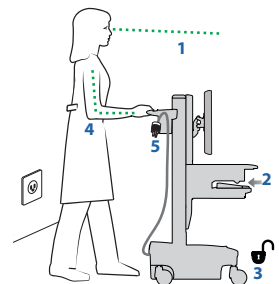

KEYBOARD LIGHT

Your computer must be on for this light to function.

Keyboard Light will automatically turn off after 15 minutes if not manually turned off.

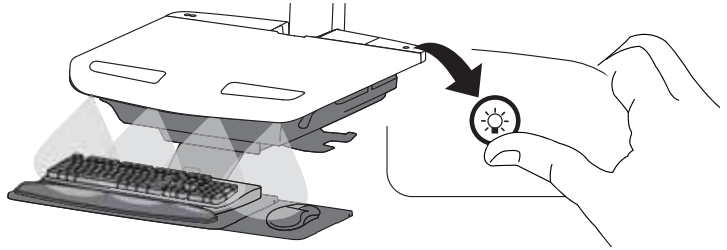

Unlock Drawer (2 methods): NOTE: All Drawers in row must be closed before a new row can be unlocked.

- Enter User PIN (only numbers for available drawer rows flash green), then press desired drawer row number*.
- Key - turn clockwise 1/4 turn

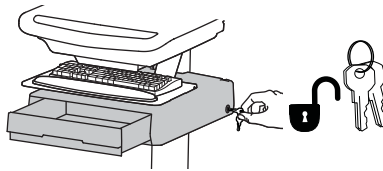
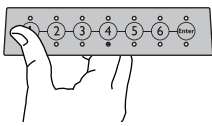

***Drawer Row Numbers:**

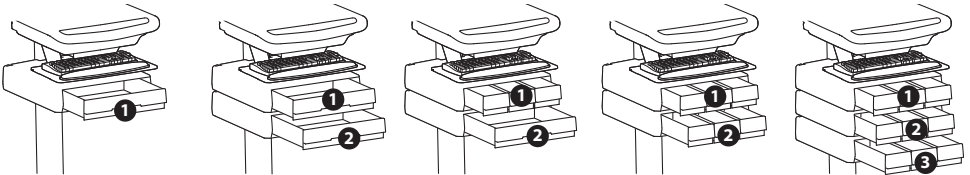

Lock Drawer:

- Wait 4 seconds for lock to engage automatically.

NOTE: Always ensure drawer is pushed in all the way and engaged with lock.

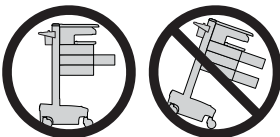

CAUTION: Close worksurface before opening drawers. Open only one drawer at a time. Do Not push cart when drawers or worksurface are open. Failure to follow these instructions may cause the cart to be unstable.