

# EHN Series Mini Rugged IP Dome Camera

Full HD, WDR, IP67, IK10, EN50155

---

*User's Manual*



Copyright © EverFocus Electronics Corp,

Release Date: August, 2013



Copyright © 2013 EverFocus Electronics Corp.

All rights reserved. No part of the contents of this manual may be reproduced or transmitted in any form or by any means without written permission of the EverFocus Electronics Corporation.

EverFocus

12F, No.79, Sec. 1, Shin-Tai Wu Road,

Hsi-Chih, Taipei, Taiwan

TEL: +886 2 2698 2334

FAX: +886 2 2698 2380

[www.everfocus.com.tw](http://www.everfocus.com.tw)

August, 2013

## About this document

All the safety and operating instructions should be read and followed before the unit is operated. This manual should be retained for future reference. The information in this manual was current when published. The manufacturer reserves the right to revise and improve its products. All specifications are therefore subject to change without notice.

## Regulatory Notices

### FCC Notice "Declaration of Conformity Information"

This equipment has been tested and found to comply with the limits for a Class

A digital device, pursuant to part 15 of the FCC Rules. These limits are designed to provide reasonable protection against harmful interference in a residential installation. This equipment generates, uses and can radiate radio frequency energy and, if not installed and used in accordance with the instructions, may cause harmful interference to radio communications. However, there is no guarantee that interference will not occur in a particular installation. If this equipment does cause harmful interference to radio or television reception, which can be determined by turning the equipment off and on, the user is encouraged to try to correct the interference by one or more of the following measures:

- Reorient or relocate the receiving antenna.
- Increase the separation between the equipment and receiver.
- Connect the equipment into an outlet on a circuit different from that to which the receiver is connected.
- Consult the dealer or an experienced radio/TV technician for help.

Warning: Changes or modifications made to this equipment, not expressly approved by EverFocus or parties authorized by EverFocus could void the user's authority to operate the equipment.

This device complies with part 15 of the FCC Rules. Operation is subject to the following two conditions:

- (1) This device may not cause harmful interference, and
- (2) This device must accept any interference received, including interference that may cause undesired operation.

EverFocus Electronics Corp.

12F, No. 79, Sec. 1, Shin-Tai Wu Rd., Hsi-Chi,  
Taipei Hsien, Taiwan, R.O.C.

EHN Series cameras comply with CE and FCC.

# Precautions

**1. Do not install the camera near electric or magnetic fields.**

Install the camera away from TV/radio transmitters, magnets, electric motors, transformers and audio speakers since the electromagnetic fields generated from these devices may distort the video image or otherwise interfere with camera operation.

**2. Never disassemble the camera beyond the recommendations in this manual nor introduce materials other than those recommended herein.**

Improper disassembly or introduction of corrosive materials may result in equipment failure or other damage.

**3. Try to avoid facing the camera toward the sun.**

In some circumstances, direct sunlight may cause permanent damage to the sensor and/or internal circuits, as well as creating unbalanced illumination beyond the capability of the camera to compensate.

**4. Keep the power cord away from water and other liquids and never touch the power cord with wet hands.**

Touching a wet power cord with your hands or touching the power cord with wet hands may result in electric shock.

**5. Never install the camera in areas exposed to oil, gas or solvents.**

Oil, gas or solvents may result in equipment failure, electric shock or, in extreme cases, fire.

**6. Cleaning**

For cameras with interchangeable lenses, do not touch the surface of the sensor directly with the hands. Use lens tissue or a cotton tipped applicator and ethanol to clean the sensor and the camera lens. Use a damp soft cloth to remove any dirt from the camera body. Please do not use complex solvents, corrosive or abrasive agents for cleaning of any part of the camera.

**7. Do not operate the camera beyond the specified temperature, humidity or power source ratings.**

This camera is suitable for outdoor operation only. Use the camera at temperatures within  $-40^{\circ}\text{C}\sim 55^{\circ}\text{C}/-40^{\circ}\text{F}\sim 131^{\circ}\text{F}$  (DC Power) or  $-20^{\circ}\text{C}\sim 55^{\circ}\text{C}/-4^{\circ}\text{F}\sim 131^{\circ}\text{F}$  (PoE), and humidity between 20% and 85%; this device is not rated as submersible. The input power source is 10-36VDC/PoE. Be sure to connect the proper + / - polarity and voltage, as incorrect polarity or too high a voltage will likely cause the camera to fail, and such damage is not covered by the warranty. The use of properly fused or Class 2 power limited type supplies is highly recommended.

**8. Mounting**

Use care in selecting a solid mounting surface which will support the weight of the camera plus any wind, snow, ice or other loading, and securely attach the camera to the mounting surface using screws and anchors which will properly support the camera. If necessary (e.g. when mounting to drop ceilings) use a safety wire to provide additional support for the camera.

# Contents

<b>1.</b>	<b>Introduction .....</b>	<b>1</b>
<b>2.</b>	<b>Physical Description .....</b>	<b>2</b>
2.1	Dimensions.....	3
2.2	Packing List.....	3
<b>3.</b>	<b>Features .....</b>	<b>4</b>
<b>4.</b>	<b>Installation .....</b>	<b>5</b>
4.1	Basic Installation .....	5
<b>5.</b>	<b>Accessing the User Interface .....</b>	<b>8</b>
5.1	Checking the Dynamic IP Address.....	8
5.2	Settings for Microsoft Internet Explorer .....	10
5.3	Connecting the Camera to the Network.....	12
5.4	Live View Window.....	14
<b>6.</b>	<b>Playback.....</b>	<b>17</b>
6.1	Remote Playback Using Playback Page .....	17
6.2	Setting Up the Playback Function .....	19
6.2.1	Inserting / Removing the SD Card.....	19
6.2.2	Testing the Playback Function.....	20
6.3	Playing Back Using ARV Viewer.....	22
<b>7.</b>	<b>Settings .....</b>	<b>23</b>
7.1	System Settings .....	24
7.1.1	Network .....	24
7.1.2	Date / Time .....	30
7.1.3	Storage .....	31
7.1.4	Display and Overlay .....	33
7.1.5	System Maintenance.....	34
7.1.6	System Information.....	37
7.1.7	User.....	38
7.1.8	Black/White List .....	40
7.2	Camera Settings .....	41
7.2.1	Streaming and Audio .....	41
7.2.2	Camera.....	44
7.2.3	Schedule.....	46
7.2.4	Image .....	47

7.3	Event Settings.....	48
7.3.1	Event Wizard .....	48
7.3.2	Event .....	49
7.3.3	Notification .....	53
7.4	Link to Smart Phone App .....	56
<b>8.</b>	<b>Upgrading Firmware Using IP Utility .....</b>	<b>57</b>
<b>9.</b>	<b>Specifications .....</b>	<b>59</b>
<b>10.</b>	<b>Troubleshooting .....</b>	<b>61</b>

## 1. Introduction

The small form-factor rugged dome, EHN series mini rugged IP dome, comes with three models, 1.3 MP, 2 MP and 3 MP, providing up to 15 fps at 2048 x 1536 viewing resolution. Video compression formats including H.264, MPEG4 and MJPEG are all supported. Equipped with a vandal-proof (IK10) and weather-proof (IP67) housing, the cameras meet a wide variety of needs for outdoor surveillance.

The EHN series mini IP dome features the Wide Dynamic Range (WDR) function, which can provide clear images even under back light circumstances where intensity of illumination can vary excessively. The DNR (Digital Noise Reduction) function is designed for reducing the noises in the images, allowing the camera to better distinguish between real motion and image noise, and thus results in a possibility to store more video evidence on the connected storage devices.

A built-in micro SDHC card slot and Power over Ethernet (IEEE802.3af) features are also provided. You can power the camera over the network or by connecting the camera to a 10-36 VDC power supply. Since the EHN series mini IP dome conforms to ONVIF / PSIA for compatibility with other network video devices, it interoperates with a wide variety of hardware and software systems. You can also use EverFocus Mobile Applications to remotely view the live views of the cameras through your handheld devices; or use EverFocus CMS to remotely manage multiple IP devices connected on the network. The EHN series mini rugged IP dome is the ideal solution for your mobile surveillance needs.

### The EHN Series Mini Rugged IP Dome Models

Model Name	Megapixel	Fixed Lens (Selectable)
EHN1120	1.3 MP	2.8mm, 3.6mm, 6mm, 8mm
EHN1220	2 MP	
EHN1320	3 MP	

### System Requirement

Before installing, please check that your computer meets the following system requirements.

- Operating System: Microsoft Windows XP / Vista (32-bit) / 7 (32-bit)
- Microsoft Internet Explorer 7 or above

**Note:** For using the Internet Explorer, some settings are required. Please refer to *5.2 Settings for Microsoft Internet Explorer*.

**2. Physical Description**

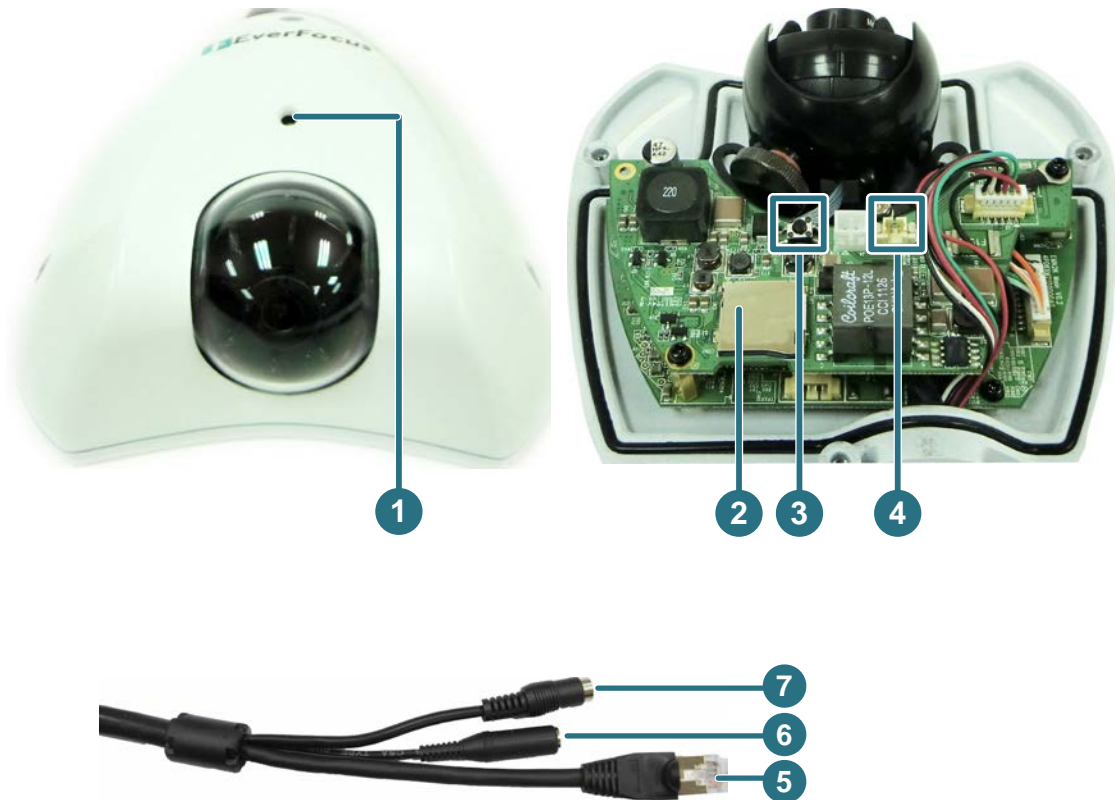

No.	Item Name	Descriptions
1	<b>Microphone</b>	One built-in microphone.
2	<b>Micro SD / SDHC Slot</b>	For inserting a micro SD / SDHC card.
3	<b>Reset Button</b>	Resets all configurations to the factory default settings.
4	<b>Video Test-Out Connector</b>	Connects to a handheld monitor for adjusting camera angles using the supplied Video Test-Out Cable.
5	<b>LAN / PoE Cable</b>	Connects to a 10/100 Ethernet or PoE.
6	<b>Power Cable</b>	Connects to a 10-36 VDC power.
7	<b>Audio Cable</b>	A Line-in cable for connecting to the audio input device.



## 2.1 Dimensions

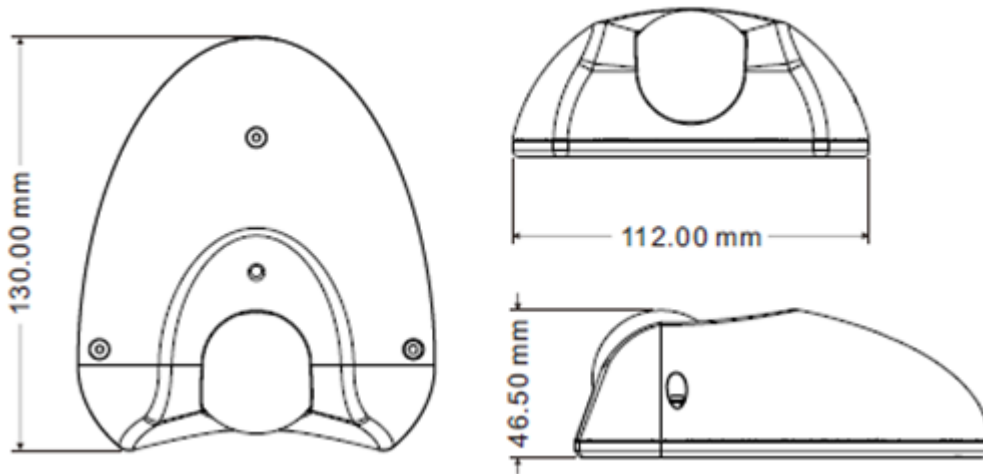

## 2.2 Packing List

Please check that there is no missing item in the package before installing.

- Camera x 1
- Long Screw x 4 (with 4 Anchors)  
- for thick surface installation
- Set Screw x 4 (with 4 Nuts)  
- for thin surface installation
- Video Test-Out Cable x 1
- RJ-45 connector x 1
- Power Pigtail Cable x 1
- Torx Screwdriver x 1
- Mounting Template x 1
- Software CD x 1
- Quick Installation Guide x 1
- Desiccant Bag x 1

### Note:

1. Equipment configurations and supplied accessories vary by country. Please consult your local EverFocus office or agents for more information. Please also keep the shipping carton for possible future use.
2. Contact the shipper if any items appear to have been damaged in the shipping process.

### 3. Features

- 1/2.7" progressive scan CMOS (for EHN1120 / 1220)  
1/3" progressive scan CMOS (for EHN1320)
- Quad streams from H.264, MPEG4 or MJPEG\*
- Up to 30 fps at 1920 × 1080  
Supports 15 fps at 2048 x 1536 (only for EHN1320)
- Hallway Display (9:16)
- Vandal-proof (IK10)
- Weather-proof (IP67-rated)
- EN50155 compliance for rolling stock applications
- Built-in micro SD / SDHC card slot
- Electronic Day / Night
- 3-axis mechanism (pan / tilt / rotate)
- Built-in microphone
- BNC video output for simplified on-site installation and verification
- Wide Dynamic Range (WDR)
- Digital Slow Shutter (DSS)
- 2D / 3D Dynamic Noise Reduction (DNR)
- Motion Detection
- 10x Digital Zoom
- Privacy Mask
- Anti-tampering
- Endurable to low environment temperatures (-40°C ~ 55°C / -40°F ~ 131°F)
- 10-36 VDC / PoE
- Multi-languages on Web interface
- ONVIF / PSIA compliant
- Supports EverFocus CMS and Mobile Applications (iOS / Android)

\* Only EHN1220/1320 models support MPEG4. EHN1120 do not support MPEG4.

## 4. Installation

### 4.1 Basic Installation

Please follow the steps below to mount the camera to the wall / ceiling.

1. Paste the supplied mounting template onto a desired location on the wall / ceiling. Drill the three cross marks and insert the supplied three Anchors into the holes. Note that the camera lens should point to the arrow direction.

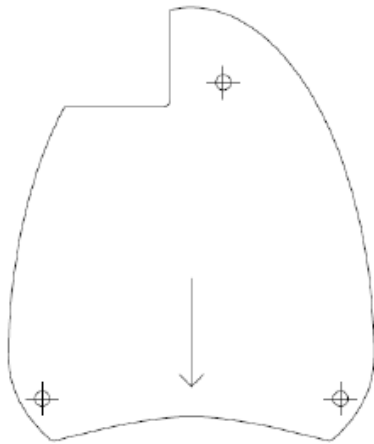

**Note:** Drill another hole on the upper-left corner of the template only if you want to run the cables through the wall / ceiling.

2. Unscrew the three screws to remove the cover.



3. Attach and then screw the camera to the wall / ceiling using the supplied three Long Screws.

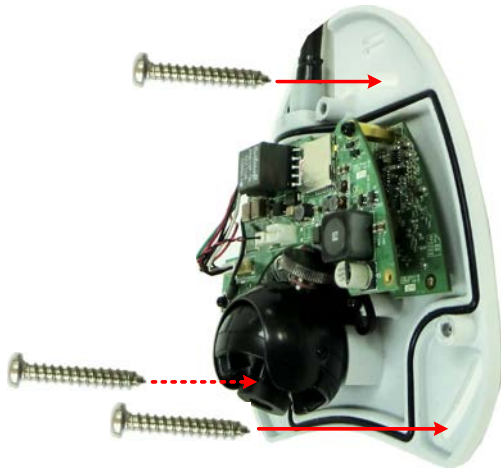

4. Thread the cables.
  - a. From the side cut of the camera case: remove the plug from the camera case first.



- b. Through the wall / ceiling: run the cables through the hole on the wall / ceiling.
5. Connect the network, power or audio cables to the camera.
6. Optionally insert a micro SD / SDHC card to the card slot. See **No.2** in 2. *Physical Description*.
7. Access the camera live view. See 5.1 *Checking the Dynamic IP Address*. Or using the supplied Video Test-Out cable to connect a monitor to the Video Test-Out connector (see **No.4** in 2. *Physical Description*) of the camera for adjusting camera angles.

**Note:** Do Not adjust camera focus yourself as it has already been adjusted (with the dome cover on) in the factory. It is normal to see the blurry image on the live view when the camera is connected to a monitor without the dome cover on. The live view image will be focused once the dome cover has been put back to the camera.

**Pan Adjustment:** Loosen the screw and pan the camera by  $\pm 25^\circ$ .

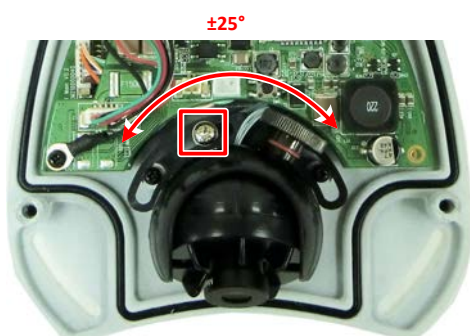

**Tilt Adjustment:** Loosen the screw and tilt the camera by 90°.

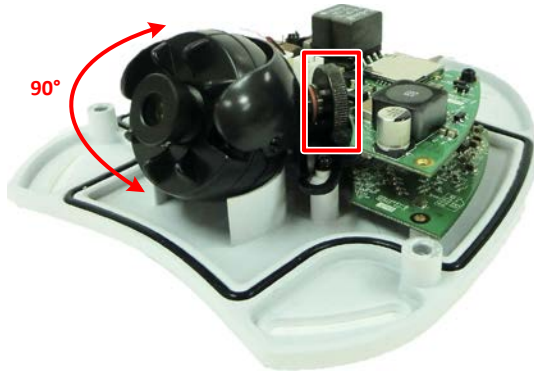

**Rotational Adjustment:** Loosen the screw and rotate the camera by ±90°.

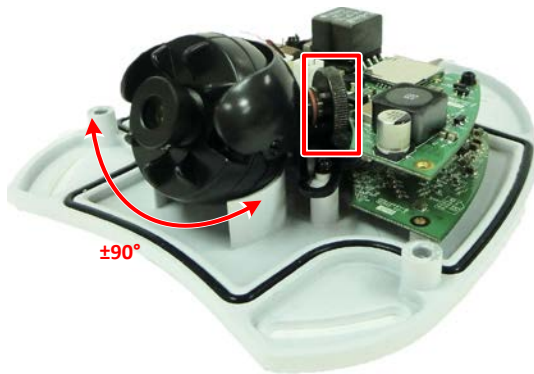

8. Remove the used desiccant bag from the camera and then stick the supplied Desiccant Bag on the inner side of the cover.



**Note:** It is highly recommended to replace the desiccant bag every time when you open the camera.

9. Secure the cover back to the camera.

## 5. Accessing the User Interface

This section explains how to access the Web interface of the camera for configuration.

### 5.1 Checking the Dynamic IP Address

You can look up the IP address and access the Web interface of the camera using the **IP Utility (IPU)** software included in the software CD. Please connect the IP camera in the same LAN of your computer.



1. Install and then start the IPU program . The following dialog box appears.

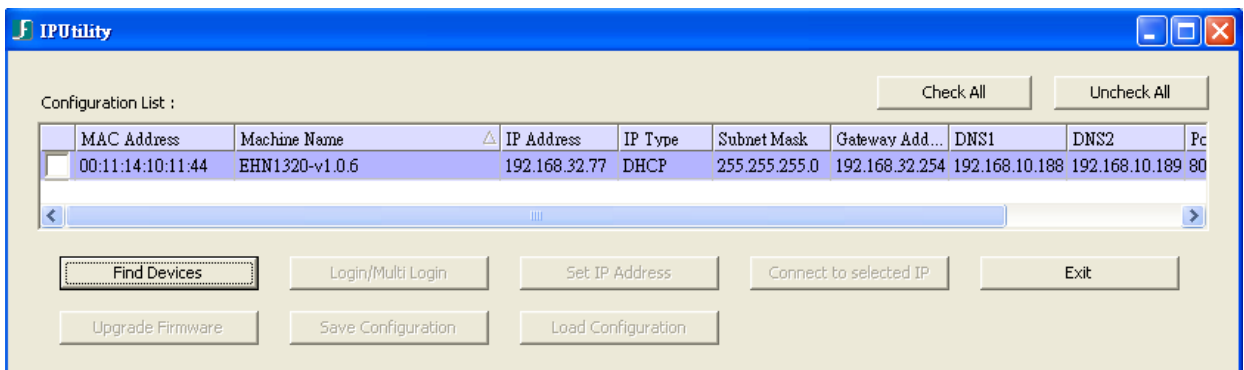

2. IPU will automatically search the cameras connected in the LAN. The default network values of the cameras will be displayed. By default, the network protocol of the camera is **DHCP**.
3. To configure the network settings, select a camera and then click **Login/Multi Login** to log in.

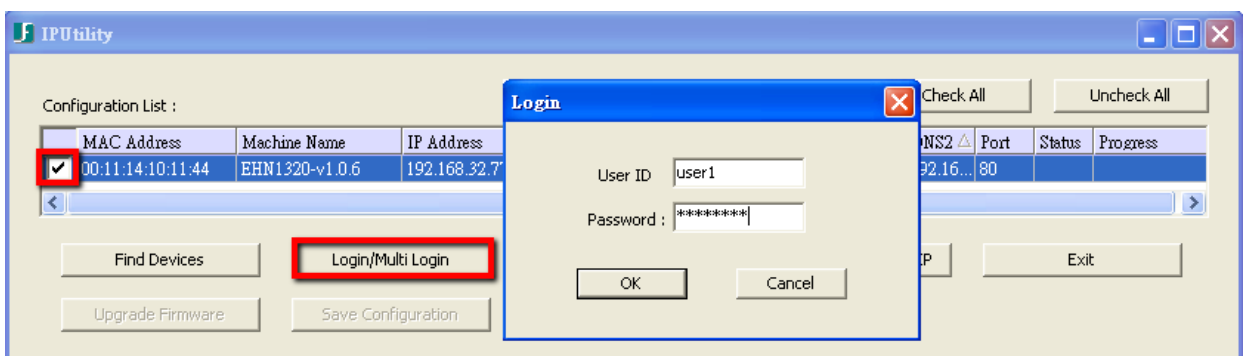

4. Type the user ID and password. Click **OK**.

**Note:**

1. The default user ID is **user1** and the default password is **11111111**.
2. If you select more than one camera that has the same user ID / password, you will be able to log in several cameras at once.

- To change the IP settings, double-click the values in the column and type the numbers or select an option. Click **Set IP Address** to save the settings.

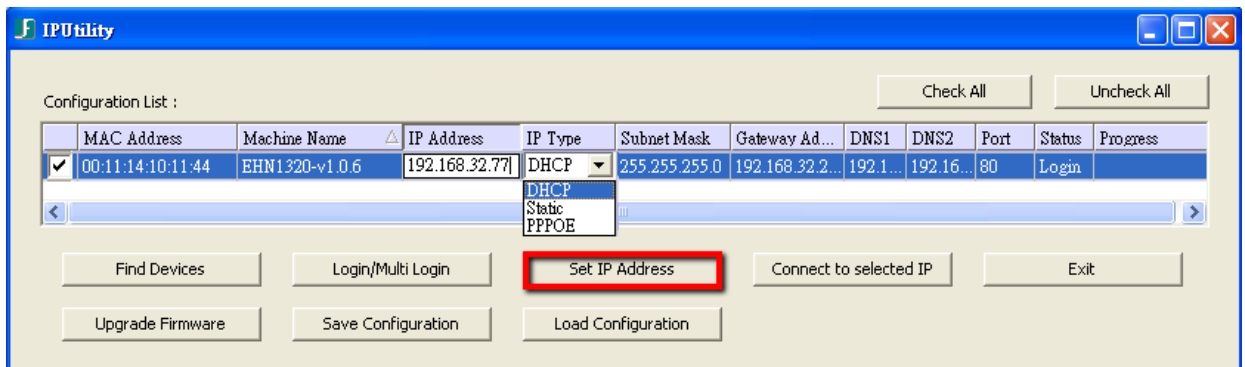

**Note:** Most networks support DHCP protocol, but if you are unsure of your network protocol, please consult your IP administrator for network configuration details.

- To access the camera, highlight the camera and click **Connect to Selected IP**. The Internet Explorer window pops up.
- Type the user ID and password to log in. The Live View window of the camera appears.

**Note:** You might be required to download **ActiveX**, which is required to view the camera feed. If asked, click "**Yes**". For more details on setting up the Microsoft Internet Explorer, please refer to *5.2 Settings for Microsoft Internet Explorer*.

## 5.2 Settings for Microsoft Internet Explorer

To enable Remote Live View, Firmware Upgrade and ActiveX Prompt on Internet Explorer, some settings have to be complete. Please follow the steps below:

1. On the computer, click Start > Control Panel > System and Security > Action Center (click Change User Account Control Settings), the **User Account Control Settings** window appears. Adjust the slide bar to **Never notify** and then click **OK**. Restart your computer if requested.

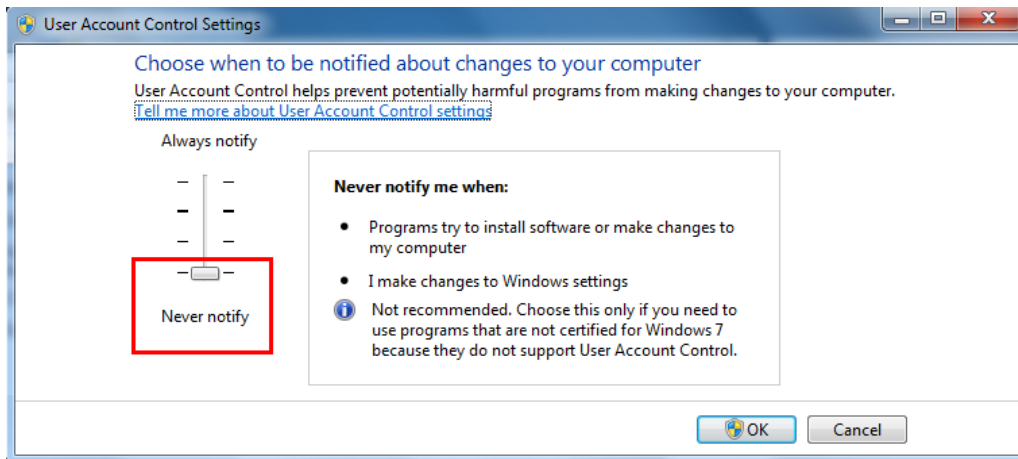

2. Open the Internet Explorer, click Tools > Internet Options > Security Tab > Custom Level, the **Security Settings** windows appears.

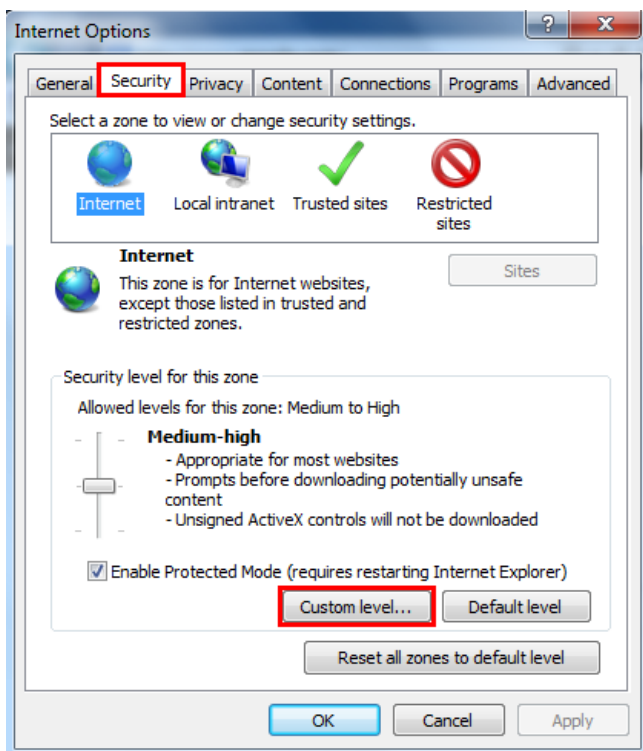



- In the **Download unsigned ActiveX controls** field, select **Prompt**. In the **Include local directory path when uploading files to a server** field, select **Enable**. Click **OK**.

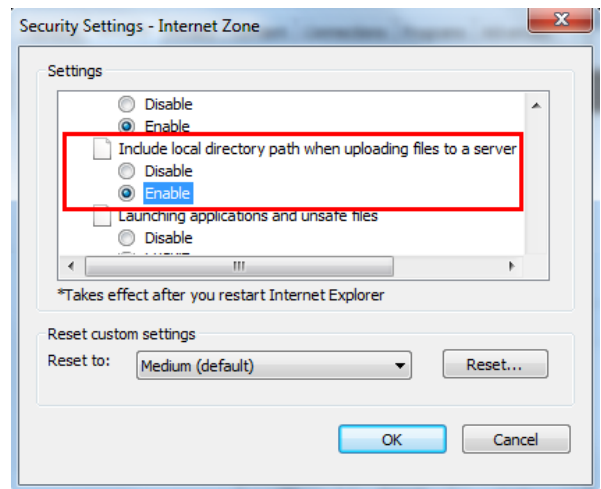
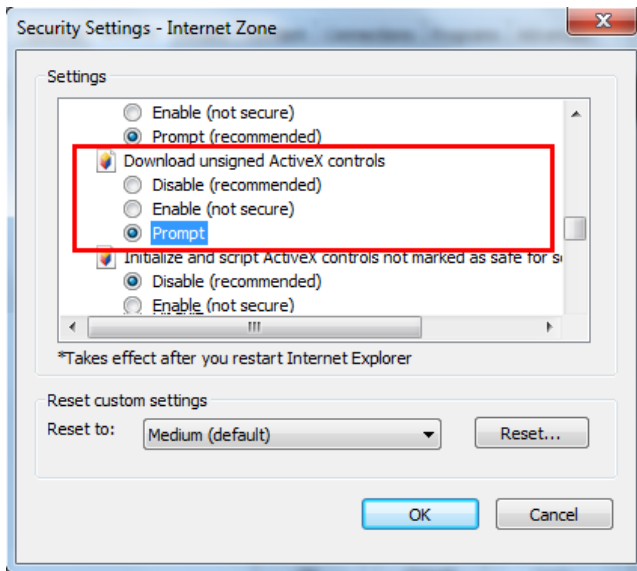

- In the Internet Options window, click the **Advanced** tab and then disable **Enable memory protection to help mitigate online attacks**. Click **OK**.

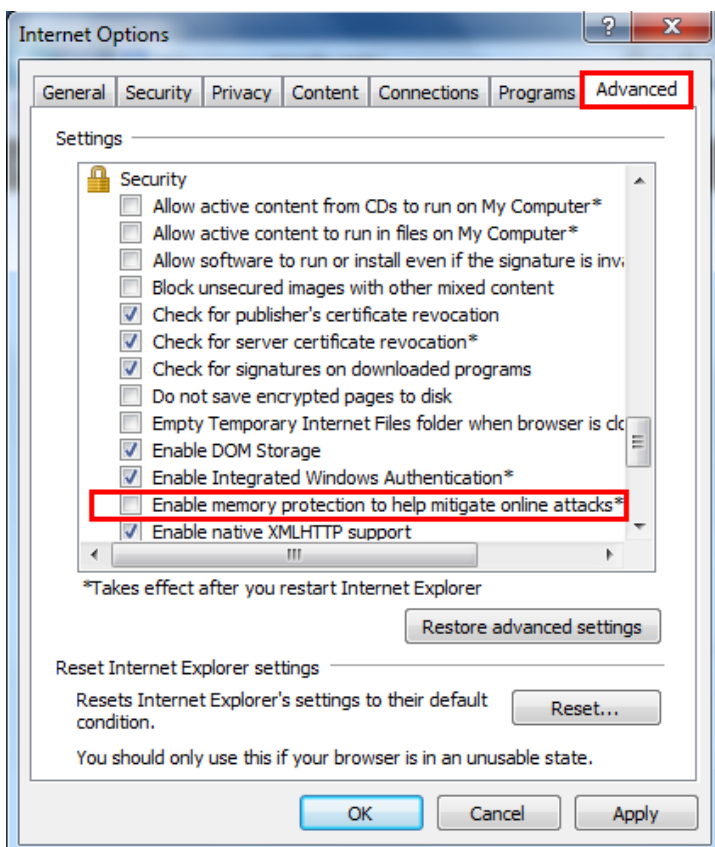

### 5.3 Connecting the Camera to the Network

There are three methods to connect the IP camera to the network: **Router or LAN Connection**, **Direct High-Speed Connection** and **One-to-One Connection**.

#### Router or LAN connection

This is the most common connection in which the IP camera is connected to a router and allows multiple users on and off site to see the IP camera on a LAN/WAN (Internet). The camera must be assigned an IP address that is compatible with its LAN. By setting up port forwarding on the router, you can remotely access the cameras from outside of the LAN via the Internet. To remotely access the Web interface of the IP camera, please refer to *7.1.1 Network (DDNS)* in the User's Manual. To set up port forwarding, please consult the manual of the router.

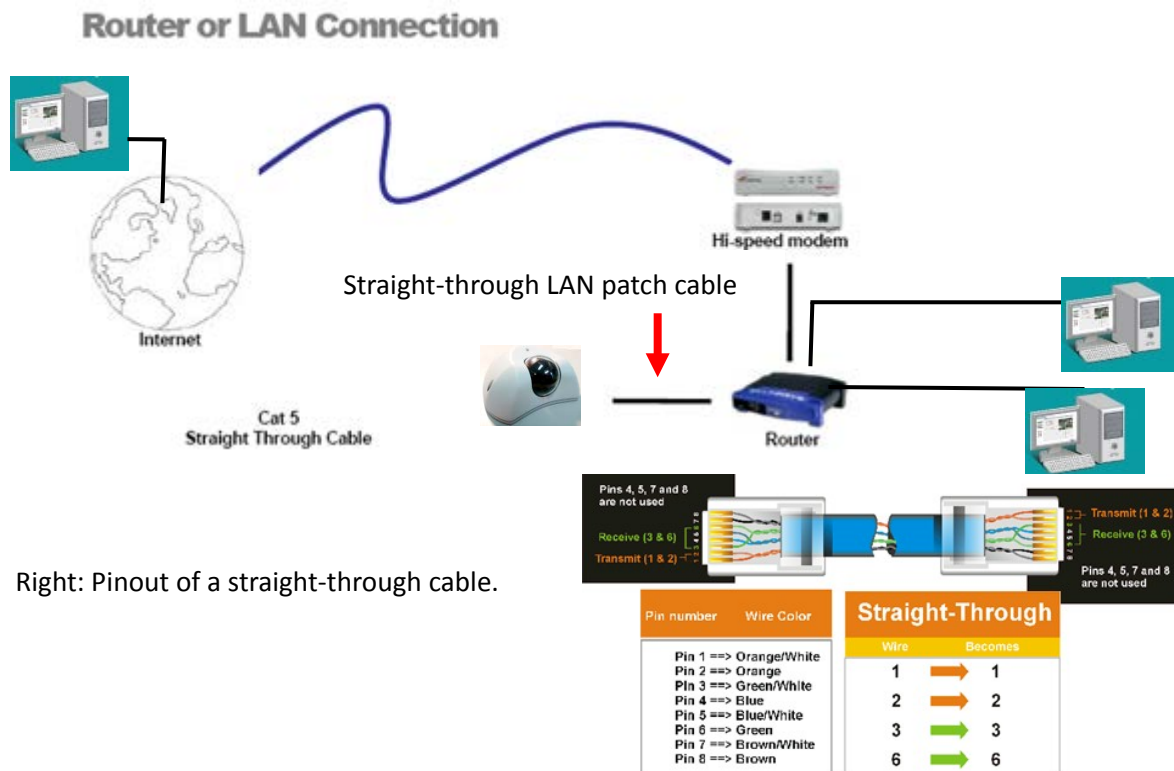

**Direct High-Speed Connection**

In a Direct High-Speed Connection, the camera connects directly to a modem without the need for a router. You need to set the static or dynamic WAN IP address assigned by your ISP (Internet Service Provider) in the camera’s configuration web pages. To access the camera, just type “http://xxx.xxx.xxx.xxx”, where xxx.xxx.xxx.xxx is the IP address given by your ISP. If you have a dynamic IP address, this connection may require that you use DDNS for a reliable connection. Please refer to 7.1.1 Network (DDNS) in the User’s Manual .

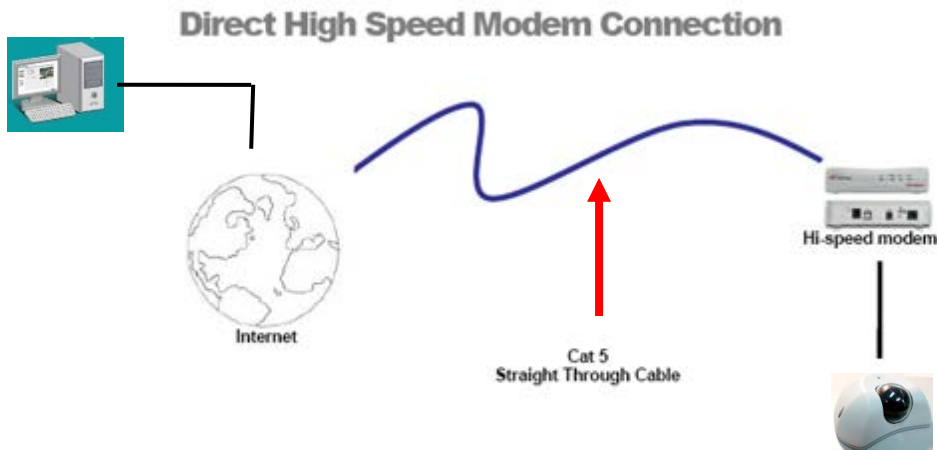

**One-to-One Connection (Directly from PC to IP Camera)**

You can connect directly without using a switch, router or modem. However, only the PC connected to the camera will be able to view the IP camera. You will also have to manually assign a compatible IP address to both the computer and the IP camera. Unless the PC has another network connection, the IP camera will be the only network device visible to the PC. See the diagram below:

**Simple One to One Connection**

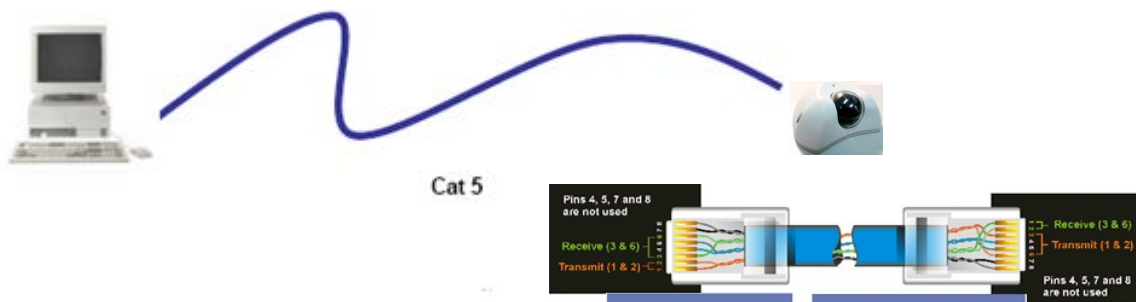

Right: Pinout of a crossed-over cable.



Pin number	Wire Color
Pin 1 ==>	Orange/White
Pin 2 ==>	Orange
Pin 3 ==>	Green/White
Pin 4 ==>	Blue
Pin 5 ==>	Blue/White
Pin 6 ==>	Green
Pin 7 ==>	Brown/White
Pin 8 ==>	Brown

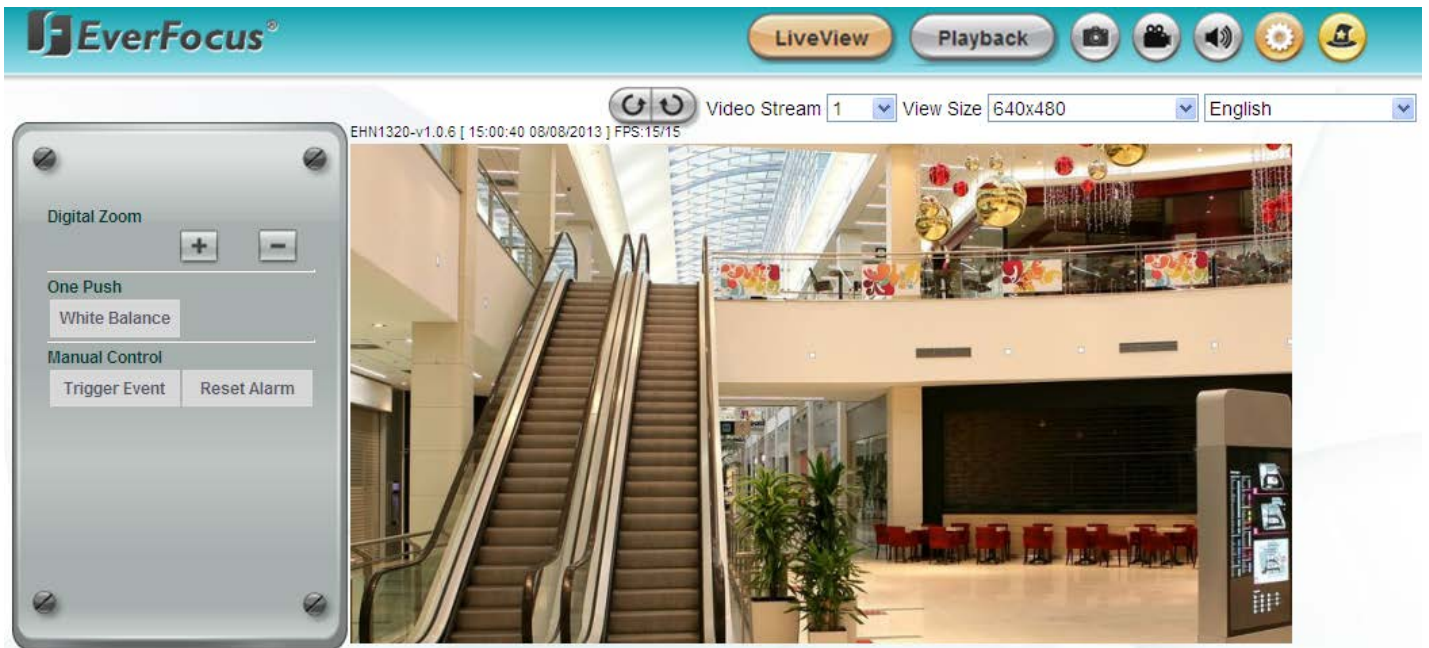

Crossed-Over	
Wire	Becomes
1	3
2	6
3	1
6	2

5.4 Live View Window





1. Click the  button to display the Live View window. If you experience video feed lag time (if connected via Internet), you can reduce the resolution or limit the number of streams. See 7.2.1 *Streaming and Audio*.
2. Click the  button to play back the recorded data directly from the on-camera Micro SD / SDHC card (for this function to become active, you have to insert a Micro SD / SDHC card in the Micro SD / SDHC card slot on the camera. See 6.2 *Setting up the Playback Function*).
3. **Snapshot** 



Click the **Snapshot** button to take a snapshot. By default, the snapshot will be saved at C:\EverFocus\. To change the location, see Record to Local in 7.1.3 *Storage*.
4. **Record** 

Click the **Record** button to start / stop recording. By default, the video recordings will be saved at C:\EverFocus\. To change the location, see Record to Local in 7.1.3 *Storage*. To change the source video stream and recording format, see Recording and Snapshot Settings in 7.1.3 *Storage*. To configure the Schedule Record setting, see Schedule Settings in 7.3.2 *Event*.
5. **Audio** 

Click the **Audio** button to switch on/off the speaker function for listening to the audio from the camera. To activate the Audio function, the **Enable Audio** must be selected. See Audio Settings in 7.2.1 *Streaming and Audio*.

6. Click the **Setting** button  to enter the Settings page (see 7. *Settings*).
7. Click the **Wizard** button  to enter the Setup Wizard.
8. **Hallway Display (9:16):** Click the **Rotate** button  to rotate the live image. This function allows users to monitor vertically-oriented areas such as hallway, corridors and aisles. It's recommended to select a 16:9 View Size (e.g. 1920x1080 / 1024x768) to achieve the best display effect.



9. **Video Stream**  
Select the Video Stream (Stream 1, Stream 2, Stream 3 or Stream 4) that will be displayed in the video box on the bottom. Stream 2, Stream 3 and Stream 4 are only selectable if you have enabled the stream. The default setting is Stream 1 only. See 7.2.1 *Streaming and Audio*.
10. **View Size**  
Use this to select the appropriate view size and shape of the video box on the bottom. A smaller size might increase transmission speed and video quality.
11. **Language**  
Click the Language drop-down list to select the desired language.
12. **Digital Zoom**  
Click   to zoom in / out the camera view up to 10x. Clicking on a magnified image will re-center the image around that point.

### 13. One Push

The **One Push** button can be displayed on the live view window by enabling the **Show One Push Buttons** function in the Live View Layout Settings (see 7.1.4 *Display and Overlay*). For the

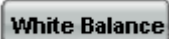
 **White Balance**

button to work, select **One Push** from the White Balance Mode drop-down list (see 7.2.4 *Image*). Once this is done, clicking the **White Balance** button on the Live View Window will instruct the camera to adjust the white balance settings, and these settings will be active until the button is pushed again. This is like a “semi-automatic” way to adjust white balance to suit the user, if the Auto or Manual mode does not give the result the user wants.

### 14. Manual Control

Click the  **Trigger Event** button to trigger an event directly from the Live View window. If you have configured an event (in the Event List) that will trigger a reaction (like a recording) when a *Manual Trigger* event occurs, clicking this button will trigger that reaction. You can select what that reaction will be. You can, for instance, set the camera to record the audio/video feed to the SD card on board the camera. You can then click on the **Playback** button to open the Playback page and search for and play all such recordings that had been stored on the card. Such event actions will be effective once they have been configured in the Event List (see 7.3.2 *Event*).

Click the  **Reset Alarm** button to reset the alarm output remotely.

### 15. Status Display (info line that can be placed above video box or at bottom of page)

This shows the name of the camera that is currently active or being configured, current date/time and current frame rate. You can activate these info displays in the Overlay Text Settings (see 7.1.4 *Display and Overlay*).

### 16. Event signal icons (above video screen)

When an alarm or motion event is triggered, a signal icon will appear at the top right of the Live View window to alert the user.

Alarm event icon  : When an alarm is triggered, this icon appears.

Motion detection icons  : The colors of these motion event icons correspond to the colors of the motion trigger areas you have configured in the Motion Settings (see 7.3.2 *Event*).

Recording icon  : When the camera is recording to a PC-based folder, this icon appears.

## 6. Playback

You can remotely play back the recordings stored in the on-camera micro SD card on the Web interface, or play back the recordings stored in the computer using the **ARV Viewer** included in the software CD.

Playback is designed as a quick way to check recent recordings that were triggered by Events that were configured to “Record to SD Card” in the Event Management (see 7.3.2 *Event*).

**Note:** Note that the Playback page is only accessible once the on-camera SD card is inserted and active.

### 6.1 Remote Playback Using Playback Page

On the Live View Window, click the **Playback** button to open the Playback page.

The screenshot displays the playback interface. On the left is a search panel with the following sections:

- Show All Files on SD Card:** Includes a 'Search' button.
- Search by Time:** Includes 'Date' and 'Time' input fields and a 'Search' button.
- Search by Event:** Includes checkboxes for 'Alarm', 'Motion', and 'Manual Trigger', and input fields for 'Start Date', 'Start Time', 'End Date', and 'End Time', with a 'Search' button.
- At the bottom of the search panel are checkboxes for 'Multiple Files' and 'Loop Again'.

The main area shows a live view of a mall interior with escalators and a digital display. Below the live view are playback controls: play, pause, stop, camera view, zoom in, and zoom out.

At the bottom, there is a file list table:

Filename	File Information
...	File Size : 15894630
20110905234740_0012_010200.arv	File Lock : false
	Start Time : 2011-09-05T23:47:40
	End Time : 2011-09-05T23:47:52
	Event List : Motion

Below the table are 'Copy', 'Lock', and 'Remove' buttons.

**Search by File:** Click the **Search** button to search for all recording files on the on-camera SD card. Search results will be displayed in the Filename area.

**Search by Time:** Click the **Date / Time** column and select the date and time from which you want to search until the present moment. Click **Search** to get your search results, which will be displayed in the Filename area.

**Search by Event:** Select the type of Event recordings you want to search for (Alarm, Motion, Manual Trigger) and then click the **Start Date / Time; End Date / Time** column to select the Start Time date/time and the End Time date/time of your search. Click **Search** to get your search results, which will be displayed in the Filename area.

**Multiple Files:** Check this box if you want the video player to play all the files in the selected folder. The files will be displayed in the Filename area.

**Loop Again:** Check this box if you want the video player to play the selected file over and over again.

**Play:** Once you have opened the file's folder and have clicked on the file to highlight it, its details will be displayed in the File Information area. You can now click **Play**  to play that specific file.

**Pause:** Click  to pause playing back.

**Stop:** Click  to stop playing back.

**Snapshot:** Click  to take a snapshot.

**Zoom In:** Click  to zoom in.

**Zoom Out:** Click  to zoom out.

**Filename:** This area will display a list of search results (recording files and folders). Folders (named with the recorded date) will be displayed first. Click on the folder and click on each subfolder until the recording files (.arv) in that folder is listed.

**File Information:** Click a file on the Filename list, the selected file information will be listed.

**Copy:** Click to copy the selected file to the computer-based folder of your choice. A browsing box will open so that you can search for the folder of your choice. You can use the ARV Viewer to play back the recordings recorded in your computer. For details on ARV Viewer, see *6.3 Playing Back Using ARV Viewer*.

**Lock:** Click to lock the selected file. This will protect that file from being overwritten during any overwrite procedure. The file will thus be saved on the micro SD card indefinitely. However, the file will still be deleted if the micro SD card is ever formatted.

**Remove:** Click to delete the selected file.



## 6.2 Setting Up the Playback Function

Note that the Playback function will not be activated until the user has inserted a micro SD card in the camera's micro SD card slot. The card may also have to be formatted in the Secure Digital Card field (see 7.1.3 Storage).

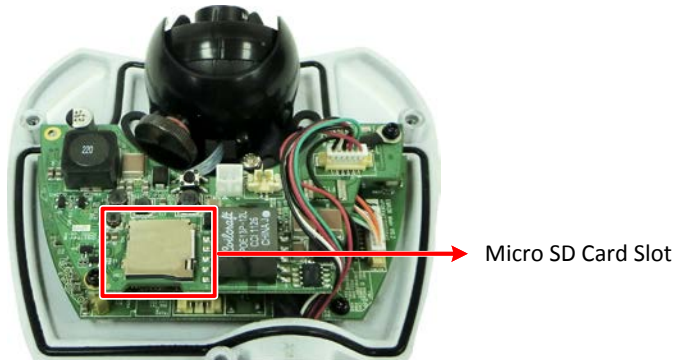

### 6.2.1 Inserting / Removing the SD Card

1. **To insert the SD card:** Remove the camera cover and insert the SD card into the SD card slot before powering on the camera.
2. **To remove the SD card:** Click the **Remove** button (System Settings > Storage > Secure Digital Card) when the camera is powered on, the SD card information "SD card is not mounted" will display and the Remove button will change to **Attach**, and then you may remove the SD card. If you want to insert the SD card again, insert the SD card and then click the **Attach** button.

After inserting the SD card into the SD card slot, the Playback button on the Live View page should be activated. If not, do the following:

1. Click the **Remove** button, pull the card out and re-insert it.
2. Click the **Format** button to format the card. NOTE: All data on the disk will be deleted if the Format button is clicked.

### 6.2.2 Testing the Playback Function

1. To test the Playback function (this is not required), set up a “Manual Trigger” Recording Event by clicking Event Settings > Event.

#### Event Management

##### Event List

Name	Type	Notification	Enable
Motion	VMD	SDNAsyslog	true
Tampering Detection	badvideo	SDNAsyslog	true
Test 1	manualTrigger	SD	true

Page 1 of 1      View 1 - 3 of 3

**Event Name**

**Event Trigger Type**

**Enable This event**

**Enable Re-trigger miniman interval between triggers**  **second**

**Enable Pre-trigger Buffer**

**Enable Post-trigger Buffer**

**Notification Over**

Log

Send Mail Notification

Upload to FTP

Record to SD Card

Network Alarm

#### Trigger Options Settings

**Pre-trigger Buffer**  **second**

**Post-trigger Buffer**  **second**

2. Give the event a name, like “Test 1”.
3. In the “Event Triggered Type” field, click on Manual Trigger.
4. Below this, check “Enable This Event”, “Enable Post-trigger Buffer”, and “Record to SD Card”.
5. To save your settings, click the **Create** button, and the Event will be listed in the Event List.
6. Look at the “Post-trigger Buffer” at the bottom to make sure the buffer time is set to 10 seconds. Click the **Apply** button.
7. Click the **LiveView** button to go back to the Live View page.
8. Get ready to click the **Trigger Event** button on the Live View page. Before you do, see if you can find something in the view screen that will give you a visual time marker. For instance, if you can get your hand in front of the camera’s lens, get ready to count down on your fingers.

9. Click the **Trigger Event** button and slowly count down on your fingers in front of the lens (if you are able to do so – if not, try to find visual cues on the view screen that will help you to mark the moment you pushed the trigger). The recording period will be as long as the buffer time you selected – the default period is 10 seconds.
10. Click the **Playback** button to open the Playback page.
11. There are different ways to search for recording files on the camera’s micro SD card (i.e. the Playback memory). For a recent recording like your test event, simply click the “Search” button under the “Show All Files on SD Card” header.
12. If the micro SD card is active and formatted correctly, the recording folder’s name (the recording day’s date) will appear in the Filename area. Click on this folder to open it. If there are sub-folders, click on the bottom one (the most recent would be at the bottom) until you can click on a file that cannot open to another sub-level and shows data in the File Information area to the right. This would be the file of the most recent recording event.
13. To play this file, click the **Play** button below the video box. The test footage you have recorded should start playing. Play time should be 10 seconds if you left the Post-trigger Buffer as 10 seconds.

**6.3 Playing Back Using ARV Viewer**

You can play back the recordings stored in the computer using the **ARV Viewer**  included in the software CD. To store the recordings in the computer, please refer to **Copy** in *6.1 Remote Playback using Playback Page*.

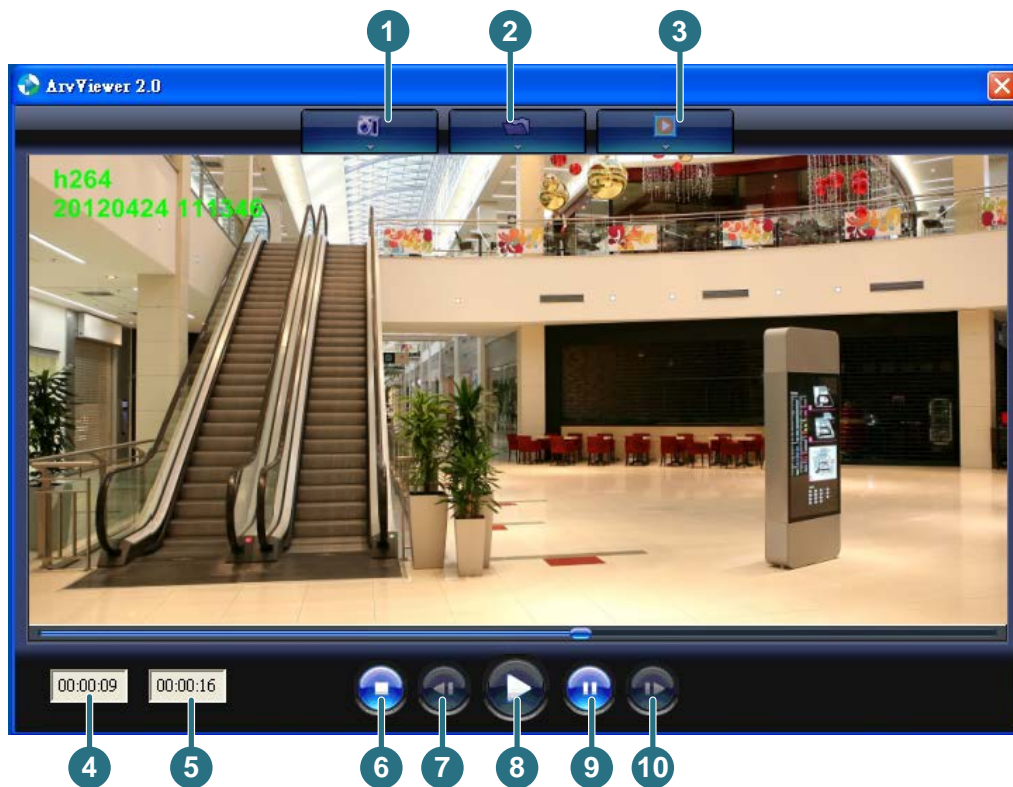

No.	Item Name	Descriptions
1	<b>Snapshot</b>	Click to take and save a snapshot.
2	<b>Load File</b>	Click to load the recordings for playing back.
3	<b>Convert ARV to AVI</b>	Convert the recording from ARV format to AVI format.
4	<b>Playback Time</b>	Display the playback time.
5	<b>Total Time of Recording</b>	Display the total time of the recording.
6	<b>Stop</b>	Click to stop playing the recording.
7	<b>Step Reverse</b>	Click to display the previous frame.
8	<b>Play</b>	Click to play back the recording.
9	<b>Pause</b>	Click to pause the recording.
10	<b>Step Forward</b>	Click to display the next frame.

## 7. Settings

Click the **Setting** button  on the Live View Window to enter the setting submenu. There are two tabs: Basic and Advanced on the left-side bar. You can set up the basic camera settings in the **Basic** tab. To further set up comprehensive camera settings, click the **Advanced** tab, which includes all the settings to be configured. The chapters below describe the detailed information of the Advanced tab.

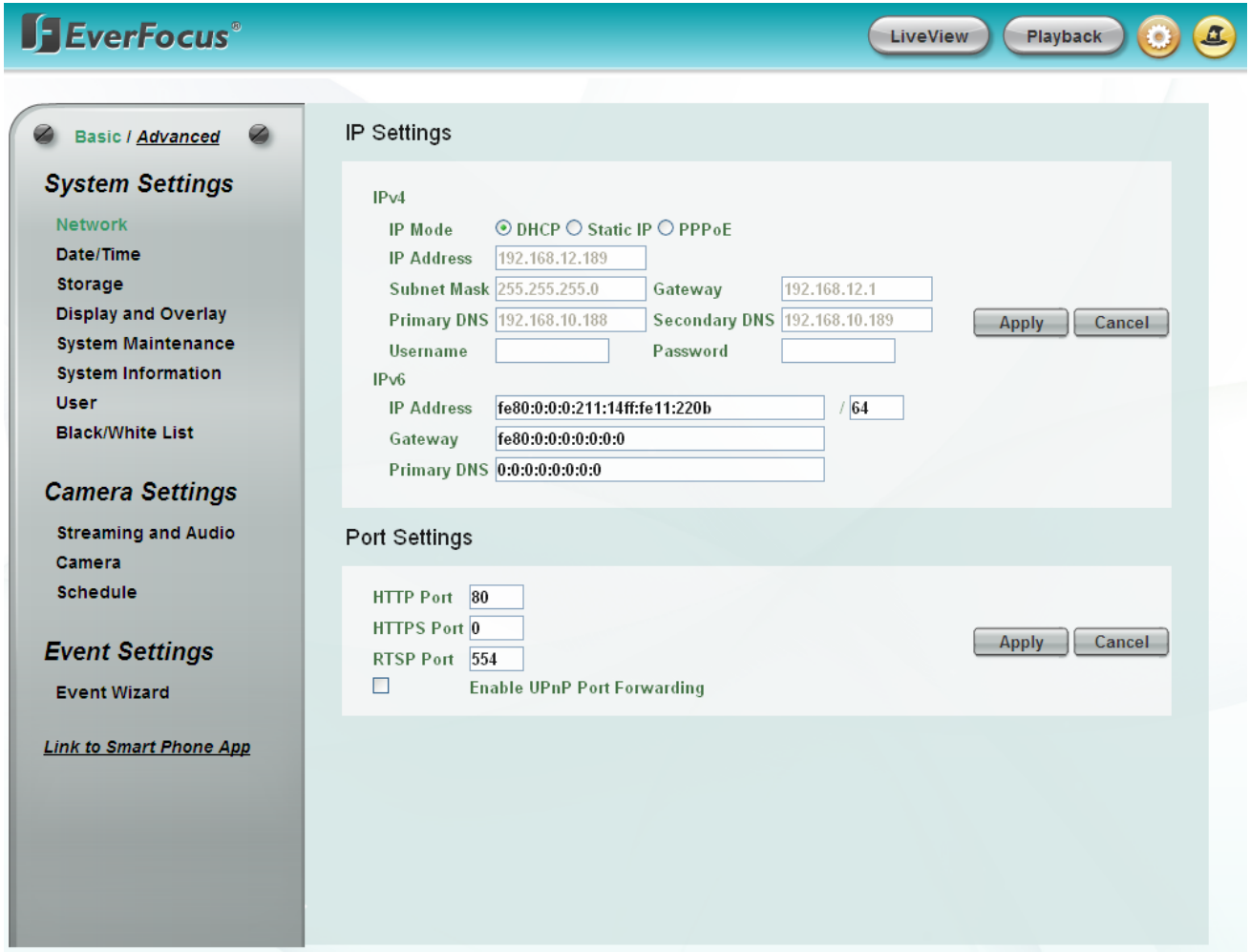

The screenshot displays the EverFocus web interface. At the top, there is a navigation bar with the EverFocus logo, a 'LiveView' button, a 'Playback' button, and two circular icons (a gear for settings and a camera for live view). On the left side, there is a sidebar menu with the following categories and items:

- Basic / Advanced** (selected)
- System Settings**
  - Network
  - Date/Time
  - Storage
  - Display and Overlay
  - System Maintenance
  - System Information
  - User
  - Black/White List
- Camera Settings**
  - Streaming and Audio
  - Camera
  - Schedule
- Event Settings**
  - Event Wizard
- [Link to Smart Phone App](#)

The main content area is titled 'IP Settings' and is divided into two sections:

**IPv4**

- IP Mode:  DHCP  Static IP  PPPoE
- IP Address:
- Subnet Mask:  Gateway:
- Primary DNS:  Secondary DNS:
- Username:  Password:

**IPv6**

- IP Address:  /
- Gateway:
- Primary DNS:

Buttons:

**Port Settings**

- HTTP Port:
- HTTPS Port:
- RTSP Port:
- Enable UPnP Port Forwarding

Buttons:

7.1 System Settings

7.1.1 Network

Basic / Advanced

**System Settings**

Network

Date/Time

Storage

Display and Overlay

System Maintenance

System Information

User

Black/White List

**Camera Settings**

Streaming and Audio

Camera

Schedule

Image

**Event Settings**

Event Wizard

Event

Notification

[Link to Smart Phone App](#)

**Protocol Settings**

RTP over UDP  
 RTP over TCP  
 RTP over HTTP  
 Nevio CGI

Apply Cancel

**IP Settings**

**IPv4**

IP Mode  DHCP  Static IP  PPPoE

IP Address

Subnet Mask  Gateway

Primary DNS  Secondary DNS

Username  Password

Apply Cancel

**IPv6**

IP Address  /

Gateway

Primary DNS

**Port Settings**

HTTP Port

HTTPS Port

RTSP Port

Enable UPnP Port Forwarding

Apply Cancel

**Multicast Settings**

Enable Multicast

Multicast IP

Port  Time to Live

Apply Cancel

**DDNS Settings**

Enable Service ISP

www.everfocusddns.com

IP Camera Name  .everfocusddns.com Register

www.sitelutions.com  www.dyndns.com  www.no-ip.com

Record ID  FQDN

Username  Password

Apply Cancel

**HTTPS Settings**

Create Certificated Mode  Self-signed Certificated  
 Certificate Request

Country Name

State or Province Name

Locality Name

Organization Name

Organization Unit Name

Common Name

Email

Validity  Day

Created Request

Install Signed Certificated

Install Certificated Info

Apply Cancel

<input type="text"/>	Property Remove
<input type="text"/>	Browse Upload
<input type="text"/>	Property Remove

Property Information

**【Protocol Settings】** This function can only be set up in the **Advanced** tab. You can transmit the data stream from the IP cameras using the RTSP (Real Time Streaming Protocol) on the network. The RTSP is a protocol that allows you to access video streams by using the compatible media players. Click **Apply** to apply the changes or **Cancel** to cancel the changes and return to the previous settings.

- **RTP over UDP:** The RTSP protocol uses UDP for camera data stream transmission.
- **RTP over TCP:** The RTSP protocol uses TCP for camera data stream transmission.
- **RTP over HTTP:** The RTSP protocol uses HTTP for camera data stream transmission.
- **Nevio CGI:** This is EverFocus' protocol designed for EverFocus' IP devices. Select this protocol for camera data stream transmission.

**【IP Settings】** Enter the IPv4 / IPv6 details in this area, which applies to your system. Click **Apply** to apply the changes or **Cancel** to cancel the changes and return to the previous settings.

■ **IPv4:**

**IP Mode:** Refer to the network administrator for these settings of the server. **Default: DHCP.**

- **DHCP:** This setting lets the system use an automatically assigned (dynamic) IP address. This address can change under certain circumstances. For instance, when the camera's network switch/hub has to be rebooted. Do not assign to the DHCP server the same IP addresses used for the other network cameras and PCs with unique IP addresses.
- **Static IP:** The user can manually set the Static IP address. This type of address is stable and cannot change, but the user has to make sure there are no address conflicts with other network-connected devices.
- **PPPoE:** This is a DSL-connection application. The ISP will ask the user to input a username and password. Contact your ISP for these details.

**Note:** If PPPoE is selected as the IP type, the supplied IP Utility program will not be able to detect the device.

**IP address:** When DHCP is not used, the user needs to manually enter the IP address of the camera. Do not enter an IP address that is already used for your computer or other network cameras.

**Subnet Mask:** This field is used to set the subnet mask for your network, so that the IP camera will be recognized within the network. Example: 255.255.255.0. When DHCP is selected, the DHCP server will assign this value automatically.

**Gateway:** This field is used to set the gateway for your network so that the IP camera will be recognized within the network. When DHCP is selected, the DHCP server will assign this value automatically.

**Primary DNS:** Enter the IP address of the DNS server if this is provided by an ISP.

**Secondary DNS:** If your ISP provided you with a secondary DNS address, please enter it here.

**Username:** Enter the account's username (used only for PPPoE).

**Password:** Used only for PPPoE.

- **IPv6:** Enter the IPv6 details in this area, if this applies to your system.

**【Port Settings】** Enter the HTTP, HTTPS and RTSP port numbers. Check the **Enable UPnP Port Forwarding** box to enable the UPnP function. Click **Apply** to apply the changes or **Cancel** to cancel the changes and return to the previous settings.

Promoted by the UPnP Forum (Universal Plug and Play), the UPnP is a networking architecture providing compatibility among networked devices listed in the networked device table. Enable the UPnP function means you can directly connect the cameras listed in the networked device table by clicking on them.

**Note:**

1. For the UPnP function to work, an UPnP-enabled router is required.
2. The UPnP function may fail owing to the compatibility between the camera and the router.

**【Multicast Settings】** This function can only be set up in the **Advanced** tab. Enable if required, fill in the setting options and click **Apply** to save.

**【DDNS Settings】** This function can only be set up in the **Advanced** tab. DDNS (Dynamic Domain Name System) is a service used to map a domain name to the dynamic IP address of a network device. You can set up the DDNS service for remote access to the IP camera. DDNS assigns a domain name (URL) to the IP camera, so that the user does not need to go through the trouble of checking if the IP address assigned by DHCP Server has changed. Once the IP is changed, the IP camera will automatically update the information to the DDNS to ensure it is always available for remote access. Before enabling the following DDNS function, user should have applied for a host name from the DDS service provider’s website. We support these four DDNS server providers: [www.everfocusddns.com](http://www.everfocusddns.com), [www.sitelutions.com](http://www.sitelutions.com), [www.dyndns.com](http://www.dyndns.com), and [www.no-ip.com](http://www.no-ip.com)

**Note:** We highly recommend that you use [xxx.everfocusddns.com](http://xxx.everfocusddns.com) for the simplicity of setting up your IP cameras.

- **Enable Service ISP:** Check this box to enable the DDNS function. You can either apply for a host name from **EverFocus** or **other DDNS server providers**.
  - **From EverFocus:** If you choose the EverFocus DDNS server, you can obtain a free host name from EverFocus. To obtain a free host name from EverFocus, type a desired host name in the textbox, click the **Register / Update** button, and then click the **Apply** button.
  - **From other DDNS server providers:** To obtain a domain name from one of the three DDNS server providers, you have to register your name with the provider first, and then select the provider and fill in the required information. Please refer to the specific DDNS company’s website for further information.

Record ID: Type the record ID if provided by the DDNS server provider.

FQDN: Type the fully qualified domain name applied from the DDNS server provider. For example, [xxx.dyndns.com](http://xxx.dyndns.com)

Username / Password: Type the login account of your DDNS server provider.

Click **Apply** to apply the changes or **Cancel** to cancel the changes and return to the previous settings.



**Note:**

1. In order to support the full functionality of the camera, you must open the port numbers (80, 554, 443) on the router for remote access to the IP camera. This function is available on most routers in the market and is often known as “Port Forwarding”. To set up Port Forwarding, please consult the manual of the router.
2. In certain router models, it is possible that you will not be able to access the camera using DDNS while inside the router’s network. Please try using a PC located outside of your router’s network.

**Default Ports on All EverFocus IP Cameras:**

HTTP: 80  
 RTSP: 554  
 HTTPS: 443

**【HTTPS Settings】** This function can only be set up in the **Advanced** tab. Hypertext Transfer Protocol Secure (HTTPS) is a combination of the Hypertext Transfer Protocol and the SSL/TLS protocol that provides encrypted communication and secure identification of a network web server. Before using the HTTPS function for communication with the IP camera, a Certificate must be created first. There are two ways to create and install a certificate: **Self-Signed Certificated** and **Certificate Request**.

**Self-Signed Certificated**

Please note that even though self-signed certificates are free and offer some protection, true security is only implemented after the installation of a signed certificate issued by a certificate authority.

1. Select **Self-Signed Certificated** and fill in the following information.

<b>Create Certificated Mode</b>	<input checked="" type="radio"/> <b>Self-signed Certificated</b> <input type="radio"/> <b>Certificate Request</b>
<b>Country Name</b>	TW
<b>State or Province Name</b>	TPE
<b>Locality Name</b>	TPE
<b>Organization Name</b>	EF
<b>Organization Unit Name</b>	PM
<b>Common Name</b>	1
<b>Email</b>	everfocus@everfocus.c
<b>Validity</b>	7 Day

- Click the **Apply** button. The subject line will be displayed in the Install Certificated Info field.

Install Certificated Info	C=TW,ST=TPE,L=TPE,O=EF,OU=PM,CN=1	Property	Remove
---------------------------	-----------------------------------	----------	--------

- Click the **Property** button, a pop-up window appears to display the details of the certificate.

**Property Information**

**Install Certificated Info Property**

Not Valid Before : Tue Sep 6 22:10:33 2011  
 Not Valid After : Tue Sep 13 22:10:33 2011  
 Subject : C=TW,ST=TPE,L=TPE,O=EF,OU=PM,CN=1

Certificated (PEM format) :

```
-----BEGIN RSA PRIVATE KEY-----
MIICXglBAAKBgQCyludiB5SKR0JaRUvxeZmZDorhDosOpDidwRYTo4Y1r5N/kAAI
memxkCjQSiVh317WkMC2oOnS0P4gtNqvUDSz3iLTKSJUnjtoazZ8Yd57Q8b0SbZg
HXSB66JuoiT+7oB6x040EI2Ue32Im20wAsXxVV0Coq4FkhiRs2LzTkuf8QIDAQAB
AoGARK/Rclyj/sMFfB6m5Mr2Dm4PcBvd09XJiLMywJjmFjUHL7C8vbmCri5Z5DKA
SjJVEYU++X7OL6z98KpeaYsZmWdfAa1cz7j06phgzlrFeoq6qtgXTkWZ4V8lgx8P
0rg5nZ4HyCTk/BYa4kHBBGsNWccDa+99Z3Ze0tbep/Js0xkCQQDnH6M8bhNlcaWy
IzbNK/PLxgXFmevUuR2t3Rs8NRh0I23VI4BWiVbVx6AbcoEqs8K6LywHzHFcJBBQ
ZZt45qwPAkEAXc++1NSjW6Dgr2PnjT9sg8vL8NIZ0dqjDMEdVQM/NE+MZGUrMk
PtZsz1Pk75M4QD9g9yCj1V8nnTC+/Yzz/wJBALveo7nDYFDdiGsbL5inWY0Sci6I
Z2WK8+0YBcNzBWYAkW7nZLLzAHrVwfeNpCEp7eeZ4JiWPq8/QWOYtEAagVECQDA
7k5ltd2cc6pz590kMVULbWFP9keZIRRJ2i4vdo4zHSI4Qap1HqRLZXfa/0hblovK
-----
```

- To optionally create and install other certificates, remove the existing one by clicking the **Remove** button to erase the certificate.
- On the Web page, change the address from “http://” to <https://> in the address bar and press Enter on the keyboard. Some Security Alert dialogs will pop up. Click **OK** or **Yes** to enable HTTPS.

### Create Certificate Request

You can apply for an official certificate from an issuing Certificate Authority.

- Select **Certificate Request** and fill in the following information.

<b>Create Certificated Mode</b>	<input type="radio"/> Self-signed Certificated <input checked="" type="radio"/> Certificate Request
<b>Country Name</b>	TW
<b>State or Province Name</b>	TPE
<b>Locality Name</b>	TPE
<b>Organization Name</b>	EF
<b>Organization Unit Name</b>	PM
<b>Common Name</b>	1
<b>Email</b>	everfocus@everfocus.c
<b>Validity</b>	7 Day

2. Type the required Certificate information and then click the **Apply** button. The subject line will be displayed in the Created Request field



3. Click the **Property** button, a pop-up window appears to display the details of the certificate.

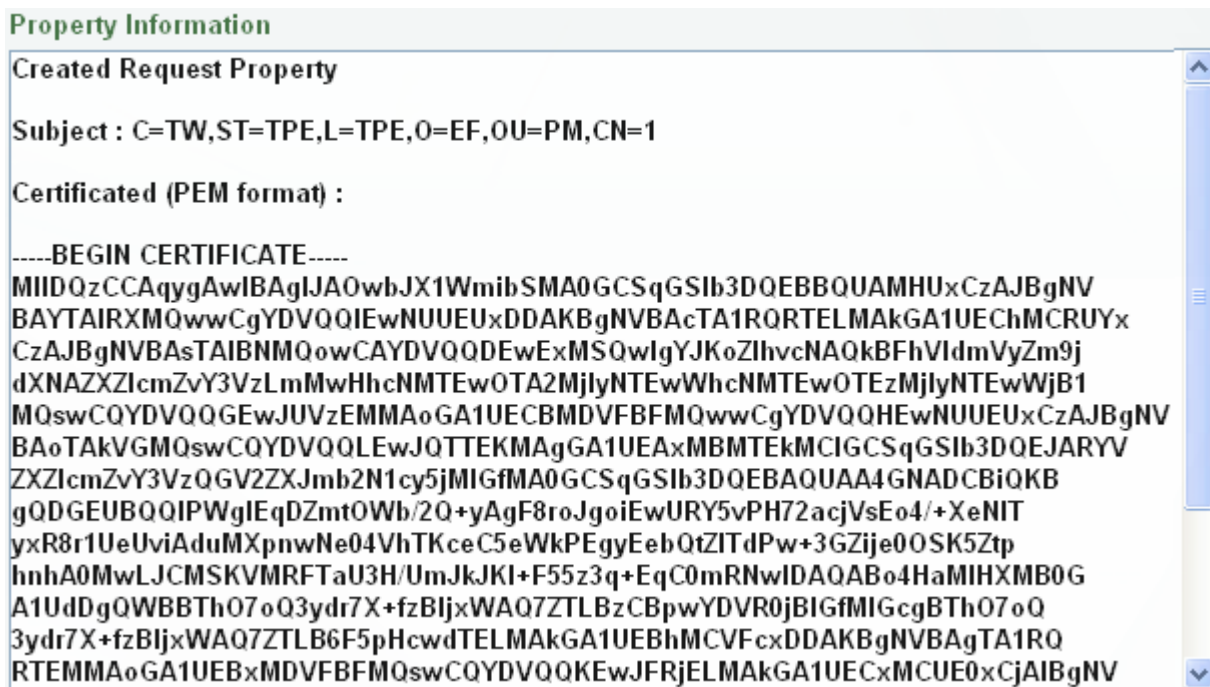

4. To optionally create and install other certificates or request, remove the existing one by clicking the **Remove** button to erase the certificate or request.
5. Copy the contents of the Certificate request (in PEM format) and paste it to the certificate request field on the Web page of the 3<sup>rd</sup>-party certification authority such as Symantec VeriSign. Wait for the certificate authority to issue an SSL/TLS certificate and then download the issued certificate on your computer.
6. In the Install Signed Certificated field, click the **Browse** button to search for the issued certificate, and then click the **Upload** button to import the certificate. Once the certificate has been uploaded, this field will show the subject line of the certificate.

### 7.1.2 Date / Time

You can set up the system's time on this page.

The screenshot shows the 'Date / Time' configuration page. On the left is a sidebar with a 'Basic / Advanced' toggle and several menu categories: System Settings (Network, Date/Time, Storage, Display and Overlay, System Maintenance, System Information, User, Black/White List), Camera Settings (Streaming and Audio, Camera, Schedule, Image), and Event Settings (Event Wizard, Event, Notification). A link to a Smart Phone App is at the bottom of the sidebar. The main content area has four sections:

- Date/Time Format Settings:** Includes 'Date Format' (Default - mm/dd/yy) and 'Time Format' (radio buttons for 24 Hours and 12 Hours).
- Date/Time Settings:** Includes 'Date' (09/06/2011), 'Time' (22:37), and 'NTP Server' (ntp0.nl.net).
- Time Zone Setting:** Includes 'Time Zone' (GMT).
- Daylight Savings Time Settings:** Includes a checked 'Enable Daylight Saving' box, 'Start' (LAST Sunday in March), 'Switch from' (02:00) 'To' (03:00), 'End' (LAST Sunday in September), and 'Switch from' (03:00) 'To' (02:00).

**【Date/Time Format Settings】** Select the desired Date / Time format and then click the **Apply** button.

#### **【Date/Time Settings】**

- **Manual:** Set the date/time if you won't be using an NTP server to update the date/time. Click **Apply** to save the setting.
- **NTP:** Enter the Network Time Protocol server, if applicable. The camera's time will be automatically adjusted by synchronizing with the NTP server. Click **Apply** to save the setting.

**【Time Zone Setting】** Set the time zone of the camera's location. Click **Apply** to apply the changes or **Cancel** to cancel the changes and return to the previous settings.

**【Daylight Savings Time Settings】** Click **Enable Daylight Saving** to enable this schedule, and select the dates when the region's daylight saving period begins and ends. Click **Apply** to apply the changes or **Cancel** to cancel the changes and return to the previous settings.

### 7.1.3 Storage

You can configure the recording path / format, source video stream and SD card settings on this page.

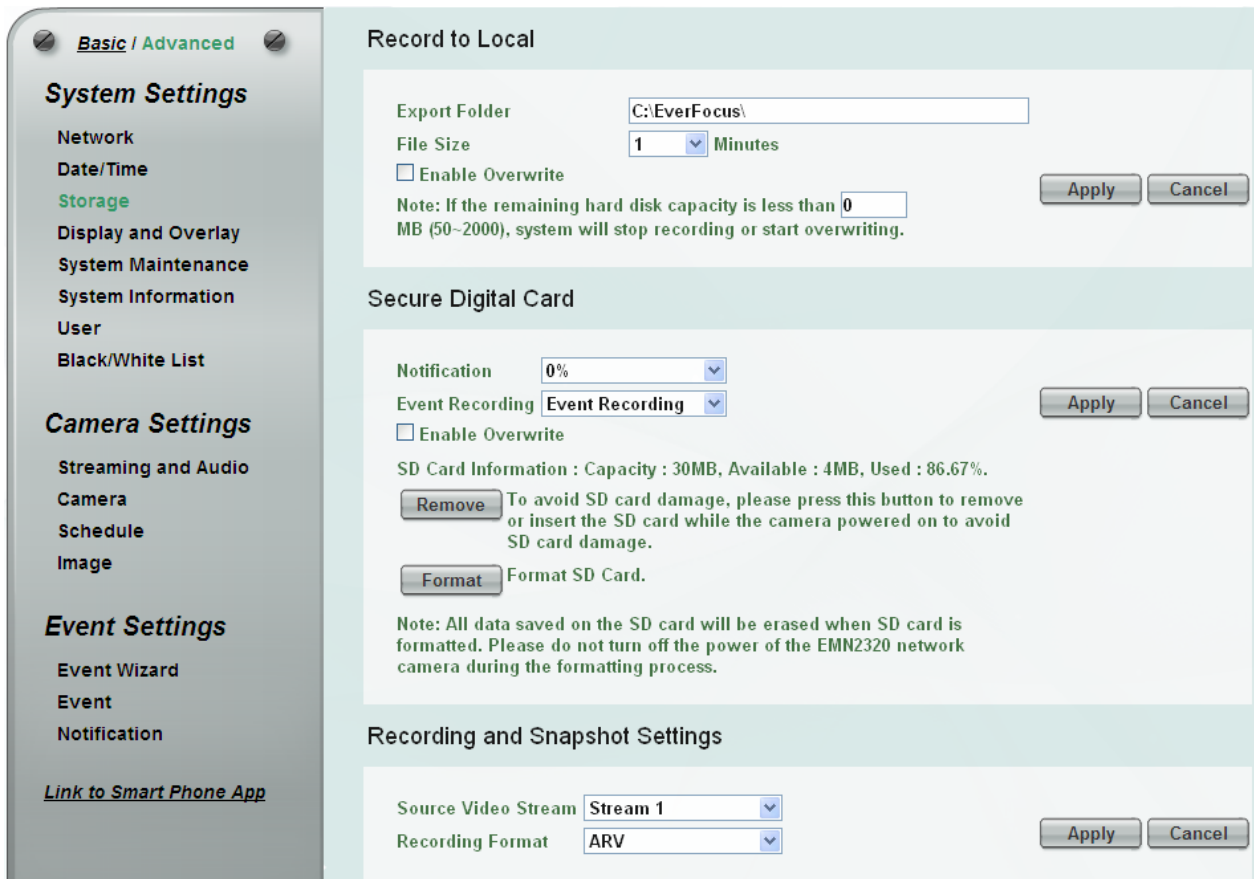

**【Record to Local】** This function can only be set up in the **Advanced** tab. You can configure the storage path for storing the recordings / snapshot on your PC.

- **Export Folder:** Type the storage path for storing the recordings / snapshot.
- **File size:** The user can limit the size of each recorded file here (in minutes). When a single recording file exceeds the time you set, the system will create a new file to save that data to.
- **Enable Overwrite:** Check the box for overwriting recording/snapshot file when the disk storage capacity is full. The user can set the storage capacity limitation in the in-sentence box below the Enable Overwrite setting: “If the remaining hard disk capacity is less than \_\_\_\_ MB (50~2000), ... “

Click **Apply** to apply the changes or **Cancel** to cancel the changes and return to the previous settings.

#### **【Secure Digital Card】**

- **Notification:** Select the percentage of storage space that should be left on the card before the camera notifies you of the impending storage shortage or overwrite. The notification will be sent out through the E-mail (*Event Settings > Notification > SMTP (Email) Settings*).

- **Event Recording:** Select the location where you want the camera to send the impending storage shortage text notification to.
  - **FTP Back Up Only:** Select to send the impending storage shortage text notification to the FTP server entered in the FTP Repository Settings (see 7.3.3 *Notification*).
  - **Event Recording:** Select to send the impending storage shortage text notification to the checked locations in the Event Management (see 7.3.2 *Event*).

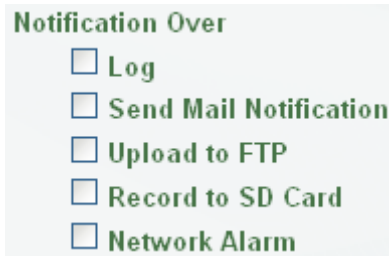

- **Enable Overwrite:** Check the box if you want the card to start writing over recorded footage when its memory is full. Uncheck the box if you want the card to stop recording new footage when its memory is full.
- **SD Card Information:** If a SD card has been inserted to the card slot of the camera, the SD card information will be displayed in this field.
- **Remove:** Click before removing the card from the system (6.2.1 *Inserting / Removing the SD Card*).
- **Format:** Click to format the card. All data saved on the SD card will be removed if the card is formatted (6.2.1 *Inserting / Removing the SD Card*).

Click **Apply** to apply the changes or **Cancel** to cancel the changes and return to the previous settings.

**【Recording and Snapshot Settings】** Select the desired video stream and recording format. The video stream can be configured in 7.2.1 *Streaming and Audio*. Click **Apply** to apply the changes or **Cancel** to cancel the changes and return to the previous settings.

### 7.1.4 Display and Overlay

You can configure the recording path / format, source video stream and SD card settings on this page.

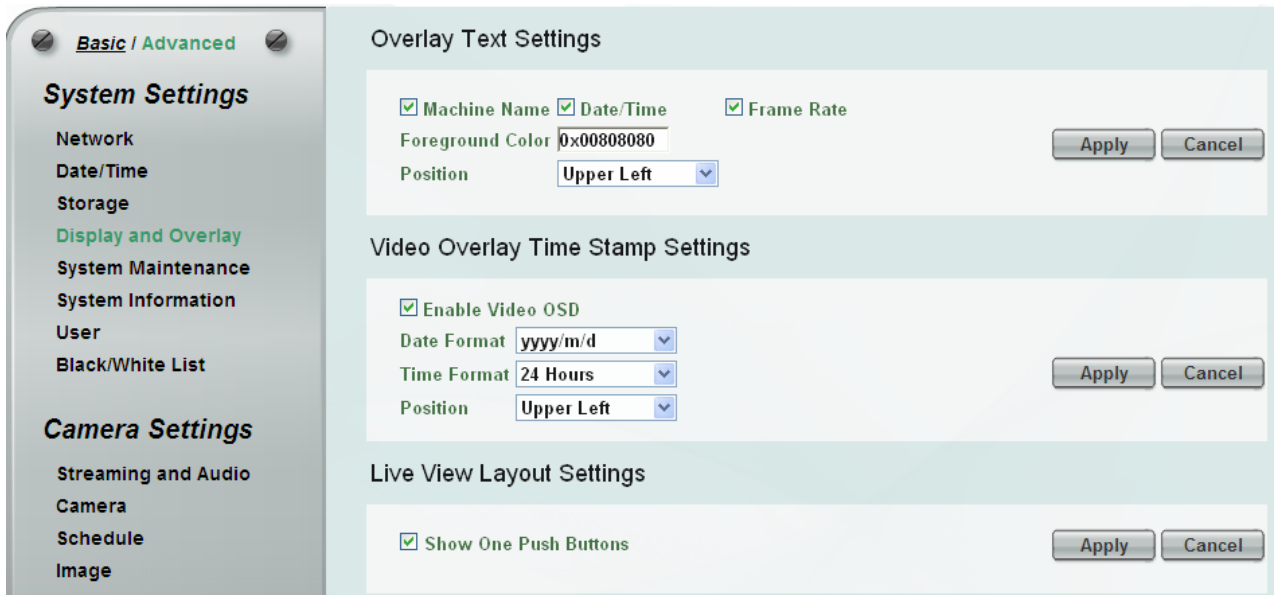

**【Overlay Text Settings】** Check the boxes to display the information on the Live View Page. To change the foreground color of the text, directly click on the box and then select a color. Select a position where you want the information to be displayed on the Live Window. Click **Apply** to apply the changes or **Cancel** to cancel the changes and return to the previous settings.

**【Video Overlay Time Stamp Settings】** Check the **Enable Video OSD** box to enable displaying time/day information on the live view window. Select the desired Date/Time format and the position where you want the time/day information to be displayed on the Live View window. Click **Apply** to apply the changes or **Cancel** to cancel the changes and return to the previous settings.

**【Live View Layout Settings】** Check the box if you want to show the One Push button on the Live View Page. Uncheck this box to hide the button. Click **Apply** to apply the changes or **Cancel** to cancel the changes and return to the previous settings.

### 7.1.5 System Maintenance

You can configure the recording path / format, source video stream and SD card settings on this page.

**Basic / Advanced**

**System Settings**

- Network
- Date/Time
- Storage
- Display and Overlay
- System Maintenance**
- System Information
- User
- Black/White List

**Camera Settings**

- Streaming and Audio
- Camera
- Schedule
- Image

**Event Settings**

- Event Wizard
- Event
- Notification

[Link to Smart Phone App](#)

---

**Machine Name**

Name

**Language Settings**

Language

New Language

**Maintenance**

Reboot the IP camera.

Resets all parameters, except for the IP, time zone and daylight saving parameters, to the original factory settings.

Resets all parameters to the original factory settings

**Entire Configuration**

Save all configuration to a config. file.

Use a saved entire config. file to return the unit to a precious configuration.

**Video Configuration**

Save video configuration to a config. file.

Use a saved video config. file to return the unit to a precious configuration.

**Video Format**

Format

**Upgrade Firmware**

Upgrade the EHN1320 with the latest firmware.

**Note:** Do not disconnect power to the unit during upgrade. The unit will reboot automatically after the upgrade has completed. (1.5 minutes.)



**【Machine Name】** If required, enter a new name for the machine. This name will be visible in the Machine Name field of the IP Utility software, which is included in the software CD. Click **Apply** to apply the changes or **Cancel** to cancel the changes and return to the previous settings.

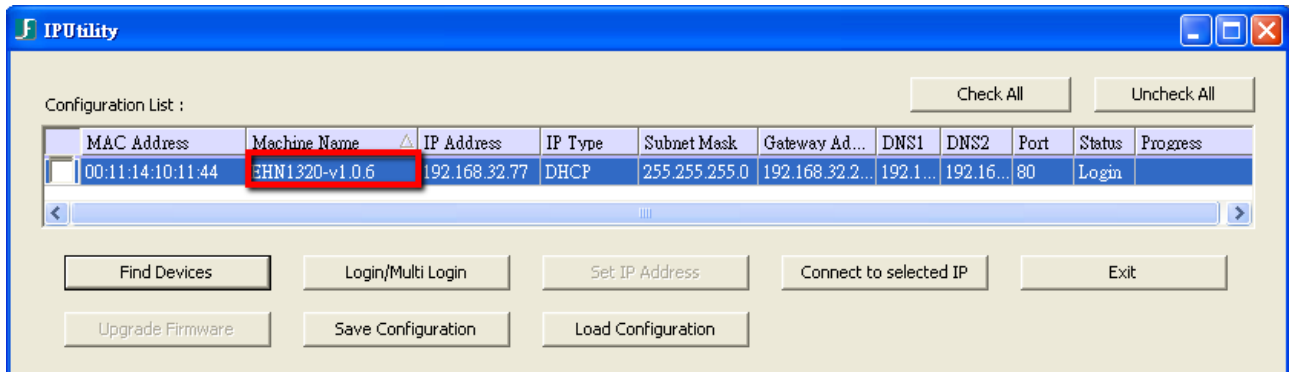

**【Language Settings】** Select the language to be displayed on the Web interface of the IP camera. The default language is English.

To add a new language not listed in the current Language list, click the **Browse** button to locate the new language file (.evb) on your computer and then click the **Upload** button. Updated language files might be available on the manufacturer's website. Contact your vendor if required.

Click **Apply** to apply the changes or **Cancel** to cancel the changes and return to the previous settings.

**Note:** Uploading a new language file will cause the system to reboot automatically. Please create a new network connection to the IP camera when the reboot is complete.

### **【Maintenance】**

- **Reboot:** Click to reboot the unit without changing any of the settings. Use this function if the unit is not behaving as expected.
- **Restore:** Click to restart and reset most of the current settings to their factory default values. The only settings that will not be changed to default are: IP Settings and DDNS Settings.
- **Initialize:** This function can only be set up in the **Advanced** tab. This button should be used with caution. Clicking this button will return all of the camera's settings, including the IP address, to the factory default values. The camera will then have to be reconfigured.

### **【Entire Configuration】**

- **Save:** To make a backup file of the machine's current configurations, click this button to save all the configurations to a configuration file. This will enable the user to reload these configuration settings if the settings are changed and there is unexpected behavior.
- **Upload:** This function can only be set up in the **Advanced** tab. To load a previously saved configuration, click the **Browse** button to locate the saved configuration file (see above) and then click the **Upload** button. The system's settings will be restored to the saved configuration.

**【Video Configuration】**

- **Save:** To make a backup file of the machine’s video configurations, click this button to save the video configurations to a configuration file. This will enable the user to reload these configuration settings if the settings are changed and there is unexpected behavior.
- **Upload:** This function can only be set up in the **Advanced** tab. To load a previously saved video configuration, click the **Browse** button to locate the saved configuration file (see above) and then click the **Upload** button. The system’s settings will be restored to the saved video configuration.

**【Video Format】** Select NTSC or PAL for your local scanning system. Click **Apply** to save the setting.

**【Upgrade Firmware】** This function can only be set up in the **Advanced** tab. Click the **Browse** button to find a previously prepared firmware upgrade file. Click the **Upload** button to install the new firmware.

**Note:**

1. Do not disconnect power to the unit during the upgrade sequence. The unit will reboot automatically after the upgrade has completed (1-5 minutes).
2. During the upgrade process, all event recording actions will be stopped. Event recording actions will resume after the camera is rebooted.
3. If the “*File Error, Please re-login!!*” warning message appears when upgrading the firmware, please try the following instructions:
  - a. Go to Internet Explorer > Tools > Internet Option > Security > Custom.
  - b. Find and enable the **Include local directory path when uploading files to a server**.

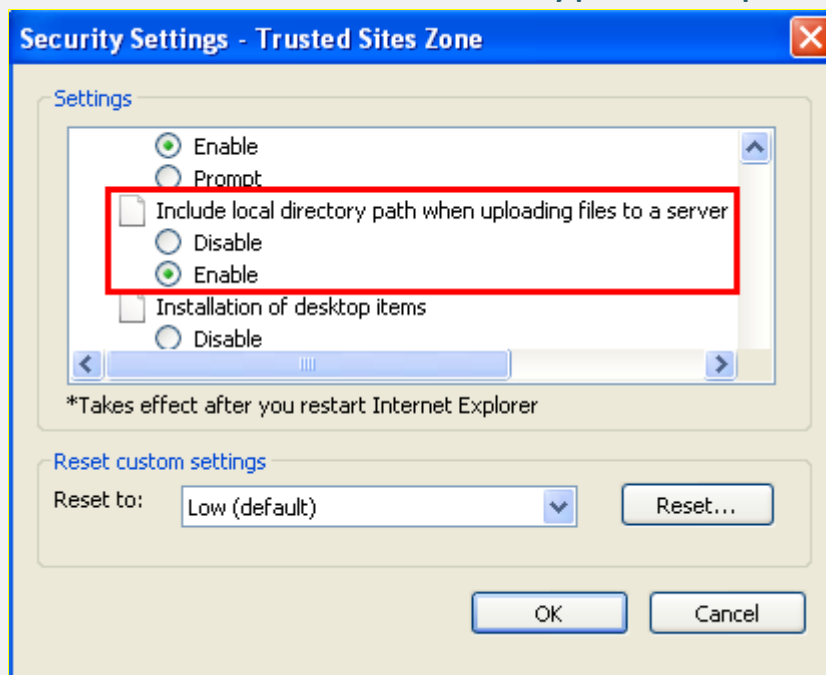

### 7.1.6 System Information

You can see the system information and log information displayed on this page.

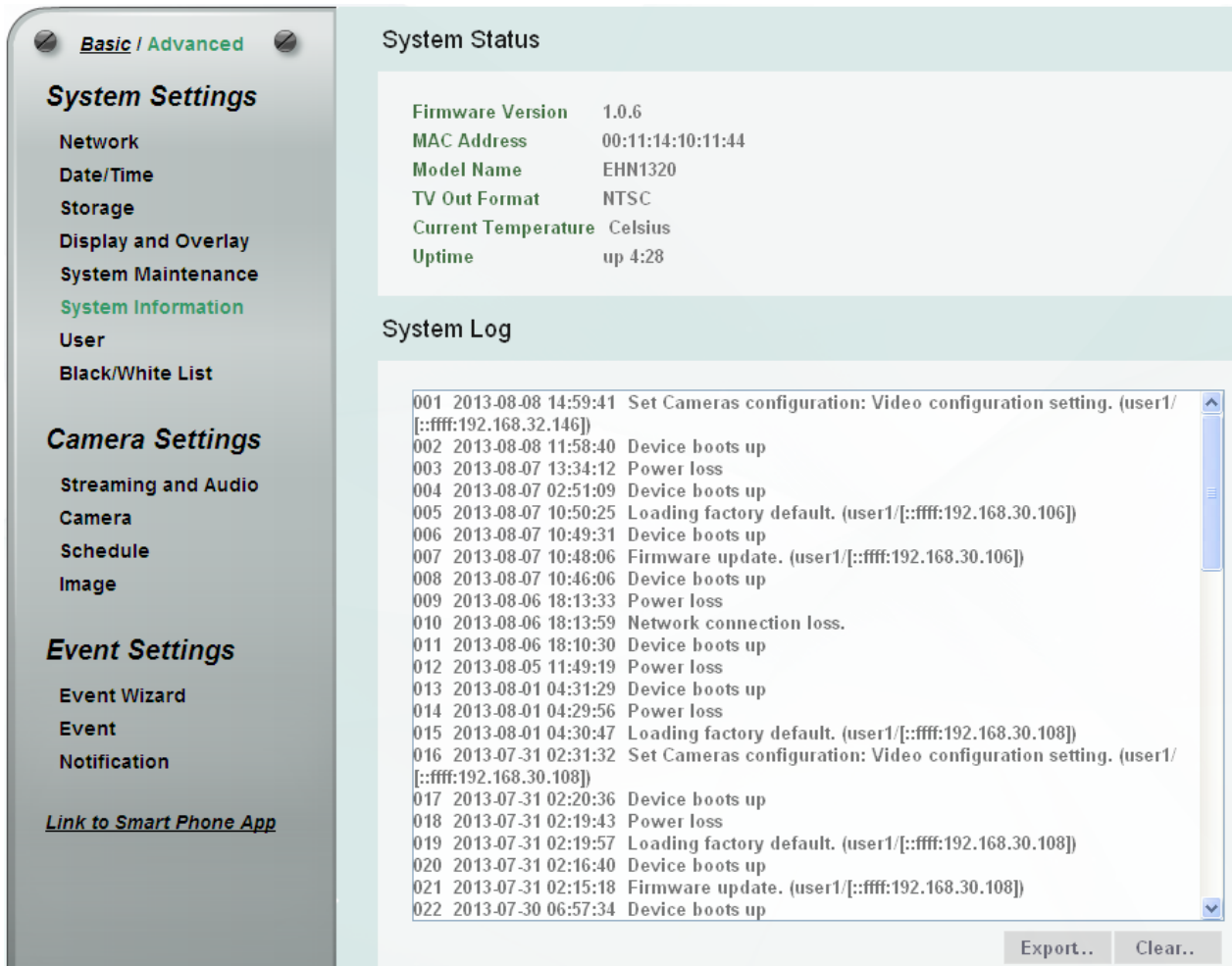

**【System Status】** Displayed the system information. The values cannot be changed on this page. The Uptime represents the period since the camera has been powered on. For example, up 1 day 2:36 represents the camera has been powered on for one day, 2 hours and 36 minutes.

**【System Log】** Displayed the sequence number, date, time and event messages of the log event. The log will display the last 256 log events. Click the **Export Log** button to export the system log event list into a ".txt" file and select the location where the exported log file will be saved to. Click the **Clear Log** to erase all the log data from the SD card. The system will be required to reboot after clicking the Clear Log button.

7.1.7 User

The system administrator can create up to ten user accounts on this page.

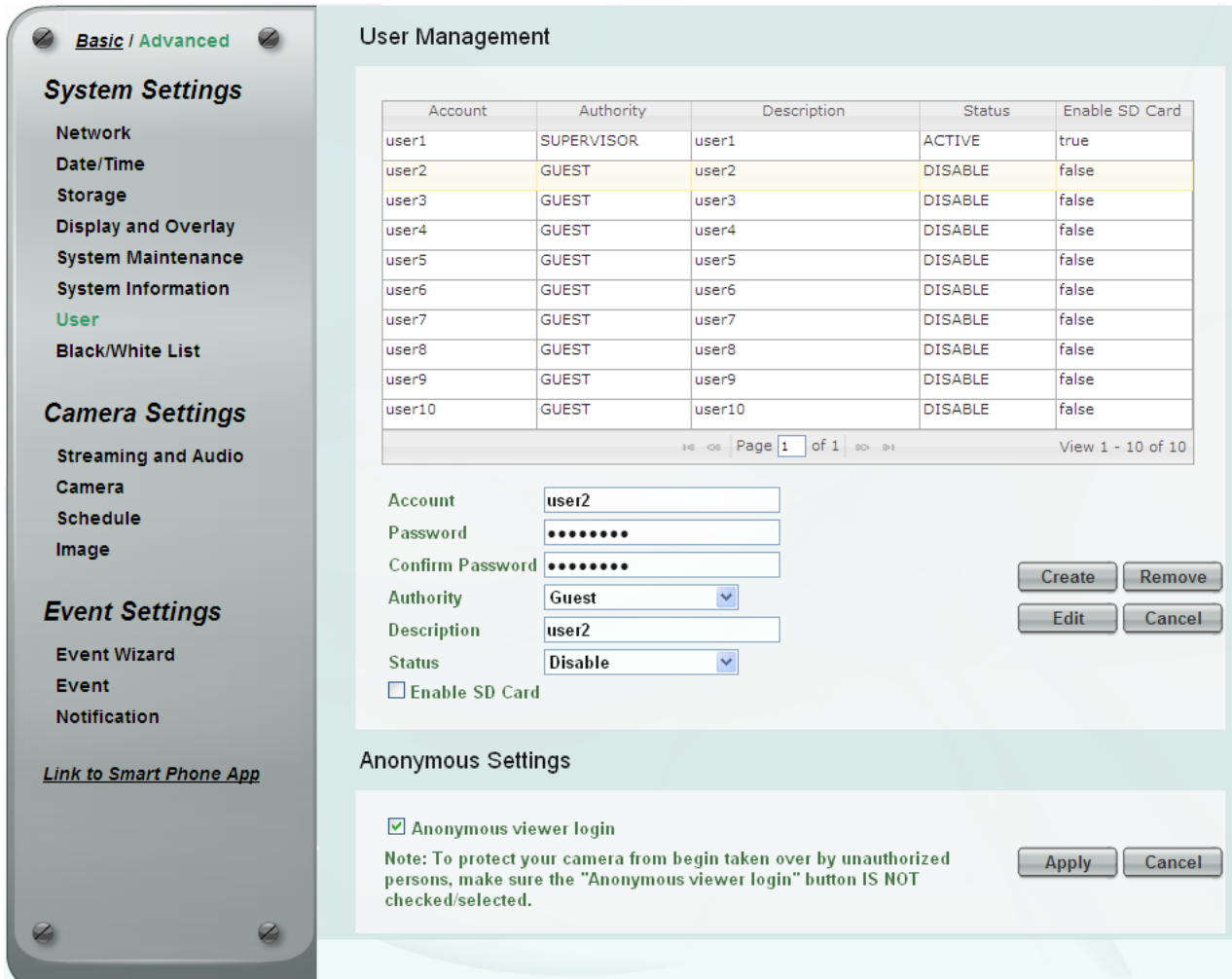

**【User Management】** The system has automatically created ten user accounts.

To set up an user account:

1. Highlight a user account and its information will be displayed in the field below the account list.
2. Revise the account name, password and description. Select an authority level for the user account.
  - **Supervisor / Administrator:** The only difference between a supervisor and administrator is that a supervisor can edit an administrator’s account and password, but an administrator cannot edit the supervisor’s account and password. The supervisor and administrators all have unrestricted access to the Setting submenus and can determine the registration of all other users.

- **User:** A user can not only view the live view but also view/configure the below camera settings.

View	Configure
<b>System Settings</b>	
Network	Network > Protocol Settings
Date/Time	Date/Time > Date/Time Format Settings
Storage > Record to Local	Storage > Record to Local
Display and Overlay > Overlay Text Settings	Display and Overlay > Overlay Text Settings
Display and Overlay > Video Overlay Time Stamp Settings	Display and Overlay > Video Overlay Time Stamp Settings
System Maintenance > Language Settings	System Maintenance > Language Settings
System Information	System Information > Export Log
<b>Camera Settings</b>	
Streaming and Audio	-
Camera	-
Schedule	-
Image	-

- **Guest:** The lowest level of access, which only allows the user access to the live view page.
3. Select **Active** or **Disable** to active or disable the user account.
  4. Check the Enable SD Card box to allow the user to access the SD card playback function.
  5. Click the **Edit** button to save the changes.

**Create**: The button is only activated when the number of list is less than ten. Enter the account information and click the **Create** button, the new account will be listed in the account list.

**Remove**: Highlight an account and then click the **Remove** button to remove the highlighted account.

**Edit**: Highlight an account and enter the account information in the boxes below the account list. Click the **Edit** button and the account will be edited.

**Cancel**: Click the button to cancel the changes and return to the previous settings.

**【Anonymous Settings】** Check the box to allow the unauthorized persons to log in the camera. Click **Apply** to apply the changes or **Cancel** to cancel the changes and return to the previous settings.

### 7.1.8 Black/White List

Use this page to specify IP addresses that are allowed / denied to access this camera. By default, any IP address can access the camera.

**Note:** The Allowed IP addresses only become relevant when the Denied items contain a **Network** or **Range**, and the supervisor wants to allow one or more IP addresses within that excluded range or network. In such a scenario, the user would enter the excluded range or network for the Denied items, and enter the exceptions for the Allowed items.

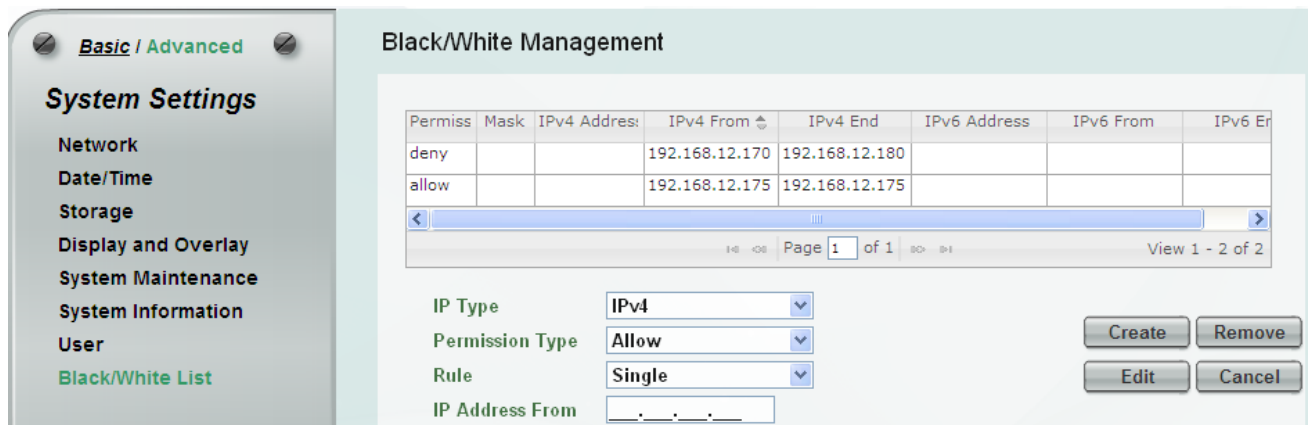

- **IP Type:** Select IPv4 or IPv6 from the drop-down list.
- **Permission Type:** Select **Deny** to deny the IP addresses configured below from accessing the camera. The **Allow** option is only relevant if you've set up at least one Deny item configured with Network or Range network rule from the Rule drop-down list.
- **Rule:** Select a network rule and then fill in the IP information in the below boxes.
  - **Single:** Type a single IP address in the IP Address field below.
  - **Network:** Type the IP address and subnet mask in the field below.
  - **Range:** Type a range for the IP addresses.

**Create**: Set up the IP information and click the **Create** button, the created IP information will be listed in the Black/White list.

**Remove**: Highlight an item in the list and then click the **Remove** button to remove the highlighted item.

**Edit**: Highlight an item in the list and set up the IP information in the boxes below the Black/White list. Click the **Edit** button and the item will be edited.

**Cancel**: Click the button to cancel the changes and return to the previous settings.

## 7.2 Camera Settings

You can configure camera related settings, such as video / audio, region of interest and privacy mask.

### 7.2.1 Streaming and Audio

**Basic / Advanced**

**System Settings**

- Network
- Date/Time
- Storage
- Display and Overlay
- System Maintenance
- System Information
- User
- Black/White List

**Camera Settings**

- Streaming and Audio
- Camera
- Schedule
- Image

**Event Settings**

- Event Wizard
- Event
- Notification

[Link to Smart Phone App](#)

**Stream Settings**

Streaming Preview

**Stream 1**

Enable Stream 1

Format:

Resolution:

Frame Rate:

Bit Rate:

Constant Bit Rate:

Variable Bit Rate:  Bit/s

**Stream 2**

Enable Stream 2

Format:

Resolution:

Frame Rate:

Bit Rate:

Constant Bit Rate:

Variable Bit Rate:  Bit/s

**Stream 3**

Enable Stream 3

Format:

Resolution:

Frame Rate:

Bit Rate:

Constant Bit Rate:

Variable Bit Rate:  Bit/s

**Stream 4**

Enable Stream 4

Format:

Resolution:

Frame Rate:

Bit Rate:

Constant Bit Rate:

Variable Bit Rate:  Bit/s

**Region of Interest Settings**

ROI Draw Tool

ROI 1 Quality:

ROI 2 Quality:

ROI 3 Quality:

ROI 4 Quality:

ROI 5 Quality:

ROI 6 Quality:

ROI 7 Quality:

ROI 8 Quality:

**Privacy Mask Settings**

Privacy Mask Draw Tool

Color:

Level:

Area 1:   Enable

Area 2:   Enable

Area 3:   Enable

Area 4:   Enable

**Audio Settings**

Enable Audio

Audio Input:

Input Volume: 0  10



**【Stream Settings】** This IP camera can output three video streams simultaneously. For each of these streams, the user can set the compression format, resolution, bit rate, and frame rate individually. Stream 1 is always enabled for live view. To enable Stream 2, Stream3 and/or Stream 4, check the **Enable Stream 2 / Enable Stream 3 / Enable Stream 4** box.

**Note:** If you connect to the camera via the Internet and experience a delay (lag time) in the video feed, try to reduce the number of streams and the quality and resolution of the streams – but keep the frame rate at its maximum.

**Format:** Select the encoding format – H.264, MJPEG or MPEG4.

**Resolution:** Select the most suitable resolution for your needs.

**Frame Rate:** This function can only be set up in the **Advanced** tab. Select from 1 to 30 fps. Note that the maximum frame rate is 15 fps if the selected resolution is higher than 1920 x 1080.

**Bit Rate:** This function can only be set up in the **Advanced** tab. If required, select whether you want the stream to stream a **Constant Bit Rate** or a **Variable Bit Rate**, and set the values of whichever option you choose.

Click **Apply** to apply the changes or **Cancel** to cancel the changes and return to the previous settings.

**【Region of Interest Settings】** This function can only be set up in the **Advanced** tab. The Region of Interest (ROI) function allows users to set up multiple regions within an image with better quality and less distortion than the rest of the image. You can also use this function together with the Digital Zoom function on the Live View window to get a better image result. Up to eight ROIs can be configured in this field.



To set up an ROI region:

1. Enabled the **ROI Draw Tool** and click the **Draw** button .
2. On the left-side live image, move the cursor to the position where you want the ROI rectangle to start and then click. Move the cursor to the position (diagonally opposing corner) where you want the ROI rectangle to end and then click.
3. Select a quality value for the ROI from the Quality drop-down list.
4. Click the **Apply** button to apply the settings, or click the **Cancel** button to reset without saving the settings.



**【Privacy Mask Settings】** This function can only be set up in the **Advanced** tab. The Privacy Mask can block out sensitive areas from view, covering the areas with colored or black and white boxes in both live view and recorded clips. This feature is useful when users' don't want the sensitive information visible. Up to four Privacy Masks can be configured.

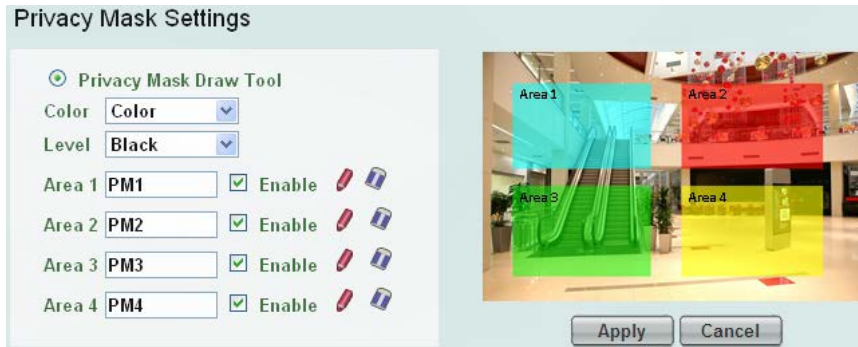

To set up a Privacy Mask:

1. Enabled the **Privacy Mask Draw Tool**.
2. From the Color drop-down list, select **Color** to make the masks appear as colored rectangles on the screen; or select **B/W** to make the masks appear as gray rectangles on the screen.
3. Select a color if you select **Color** from the color drop-down list. Select a level of grayness if you select B/W from the color drop-down list.
4. Check the **Enable** box to enable the configured privacy mask.
5. Click the **Draw** button  and move the cursor on the left-side live image.
6. Move the cursor to the position where you want the mask rectangle to start and then click. Move the cursor to the position (diagonally opposing corner) where you want the mask rectangle to end and then click.
7. Click the **Apply** button to apply the settings, or click the **Cancel** button to reset without saving the settings.

**【Audio Settings】** The camera can transmit audio to your computer if you have connected an external microphone / line-in audio device to its audio Input. Check the **Enable Audio** box to enable the camera's audio input function. Select an audio input type from the Audio Input drop-down list and then adjust the audio input volume.

Click **Apply** to apply the changes or **Cancel** to cancel the changes and return to the previous settings.

7.2.2 Camera

The screenshot displays the camera's configuration web interface. On the left is a sidebar menu with categories: System Settings (Network, Date/Time, Storage, Display and Overlay, System Maintenance, System Information, User, Black/White List), Camera Settings (Streaming and Audio, Camera, Schedule, Image), Event Settings (Event Wizard, Event, Notification), and a link to a Smart Phone App. The main content area is divided into several sections:
 

- Day/Night Settings:** Includes a 'Mode' dropdown set to 'Auto' and a 'D/N Level' slider from 0 to 46, currently set at 10. There are radio buttons for 'Day Profile' (selected) and 'Night Profile'.
- Exposure Settings:** Includes a 'Mode' dropdown set to 'Auto', 'Shutter (Manual)' set to 1/60, 'AGC (Manual)' slider from 0 to 46 set at 10, 'Slow Shutter' dropdown set to 'x2', 'AGC' slider from 0 to 46 set at 10, and 'Flickerless' dropdown set to 'OFF'.
- Backlight Compensation Settings:** Includes a 'BLC Edit Mode' section with 'Enable' and 'Disable' buttons.
- Features:** Includes 'Noise Reduction' (Mode: ON, Level: 0-100 slider at 100), 'Wide Dynamic Range' (Mode: OFF, Level: Low), and 'Monitor Type' (Type: Vivid).

 A live video feed of a mall interior with an escalator is shown on the right, with 'Apply' and 'Cancel' buttons below it.

**【Day/Night Settings】**

- **Mode:** Select a mode from the drop-down list.
  - **Auto:** Select to let the camera automatically switch to Night mode (black and white images) when the light levels fall to a specified level, and back to Day mode (color images) when the light levels rise to a specified level.
  - **Day:** Select to keep the camera in Day mode (color images), even in nighttime.
  - **Night:** Select to keep the camera in Night mode (black and white images, even in daytime).
  - **Schedule:** Select to let the camera to switch to Day mode or Night mode based on the day and night schedule settings (see 7.2.3 Schedule).
- **D/N Level:** The value represents the AGC level. Adjust the level for the camera to switch between Day mode and Night mode based on the configured value. Note that the level should be less than the AGC configured in the Exposure Settings field. For example, if you configure 10 for the AGC, and 14 for the D/N level, the D/N level will be inactivated as the AGC has set up between 0 and 10.

Click **Apply** to apply the changes or **Cancel** to cancel the changes and return to the previous settings.

**Day Profile/ Night Profile:** Select **Day Profile** to configure the following settings for daytime and select **Night Profile** to configure the following settings for nighttime. Click the **Apply** button to save the settings.

**【Exposure Settings】** This function can only be set up in the **Advanced** tab. This setting is used to adapt to the amount or type of light used by the camera. Click **Apply** to apply the changes or **Cancel** to cancel the changes and return to the previous settings.

- **Mode:** Select a mode from the drop-down list.
  - **Auto:** Selecting Auto for the camera to automatically adjust the Shutter based on the measured light level.
  - **ALC (Shutter Priority):** Selecting ALC (Automatic Light Control) allows the camera circuitry to either take bright spots more into consideration (peak), bringing out detail in bright areas, or less into consideration (average) bringing out detail in shadows.
  - **Manual:** Select this option to manually set up the Shutter (Manual) and AGC (Manual) values.
- **Shutter (Manual):** The function is only activated if you select **ALC** or **Manual** in the Mode field. If enabled, this setting lets you set the shutter speed yourself (measured in fractions of a second).
- **AGC (Manual):** The function is only activated if you select **Manual** in the Mode field. Set the Auto Gain Control limit here. The lower the AGC level, the lower the video signal and the noise.
- **Slow Shutter:** The function is only activated if you select **Auto** in the Mode field.
- **AGC:** The function is only activated if you select **Auto** or **ALC** in the Mode field. Set the Auto Gain Control limit here. The lower the AGC level, the lower the video signal and the noise.
- **Flickerless:** The function is only activated if you select **Auto** in the Mode field. Choose between OFF, 50HZ, 60HZ, 50HZ (High Luminance) or 60HZ (High Luminance).

**【Backlight Compensation Settings】** This function is useful when the background of the subject is very bright and the subject itself is dark. Click **Apply** to apply the changes or **Cancel** to cancel the changes and return to the previous settings.

- **BLC Edit Mode:** Click the **Enable** button, the BLC grids appear on the image. Click on the grids to enable / disable the BLC function. The selected grids (in green) will be applied with the BLC function.

**【Features】** This function can only be set up in the **Advanced** tab. Click **Apply** to apply the changes or **Cancel** to cancel the changes and return to the previous settings.

- **Noise Reduction (NR):** This limits the amount of digital “video noise” that is usually found in any video stream, and helps to reduce file size. Select **ON / OFF** to enable / disable the Noise Reduction function. Slide the Level bar to set up the level. The higher the level, the more the reduction.
- **Wide Dynamic Range (WDR):** The WDR function provides clearer images when both of the very bright and dark areas simultaneously appear on the camera view. There are three value options: OFF, ON and Auto. Note that when WDR is ON, some parts of the image may appear solarized. This is normal for WDR, and is not a camera malfunction.
- **Monitor Type:** Users can use this field to optimize video quality of the monitor.

### 7.2.3 Schedule

The Schedule setup page is designed for users to configure the daytime and nighttime of each day. The Schedule setting is only functional if you select **Schedule** from the D/N Mode drop-down list on the Camera setup page.

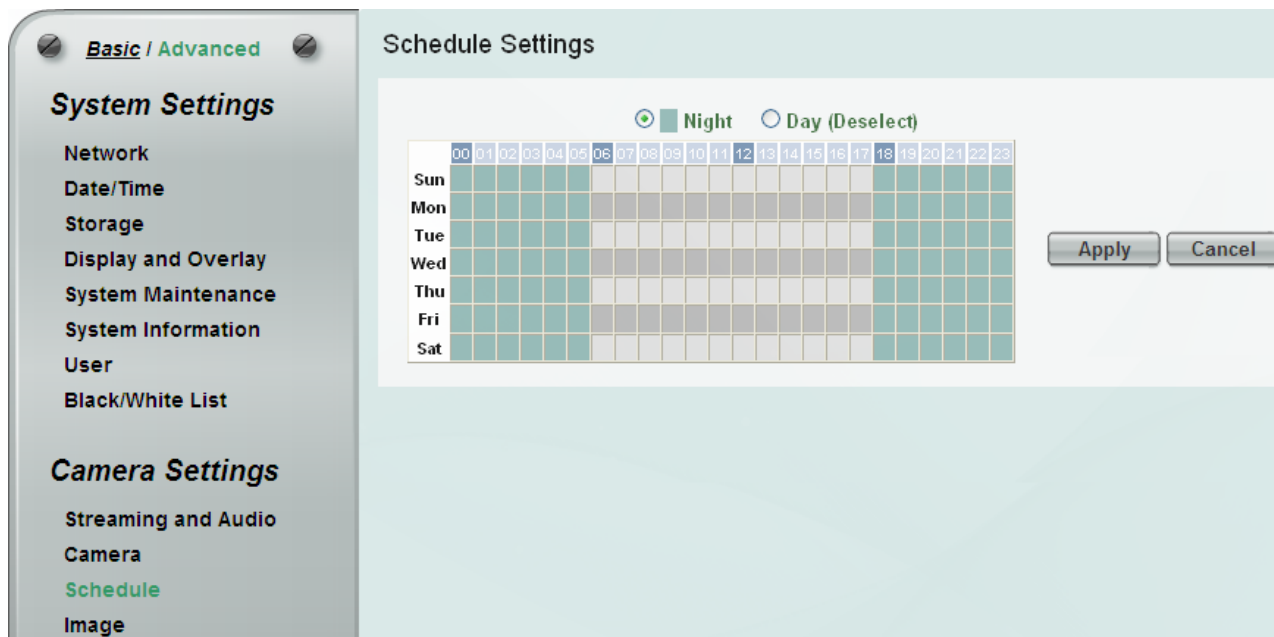

Select **Night** and then move the cursor on the desired time square, click and drag the cursor over the time squares to configure them to the Night mode (blue color). Select **Day** and then move the cursor on the desired time square, click on the time squares to configure them to the Day mode (gray color).

Click **Apply** to apply the changes or **Cancel** to cancel the changes and return to the previous settings.

### 7.2.4 Image

This function can only be set up in the **Advanced** tab.

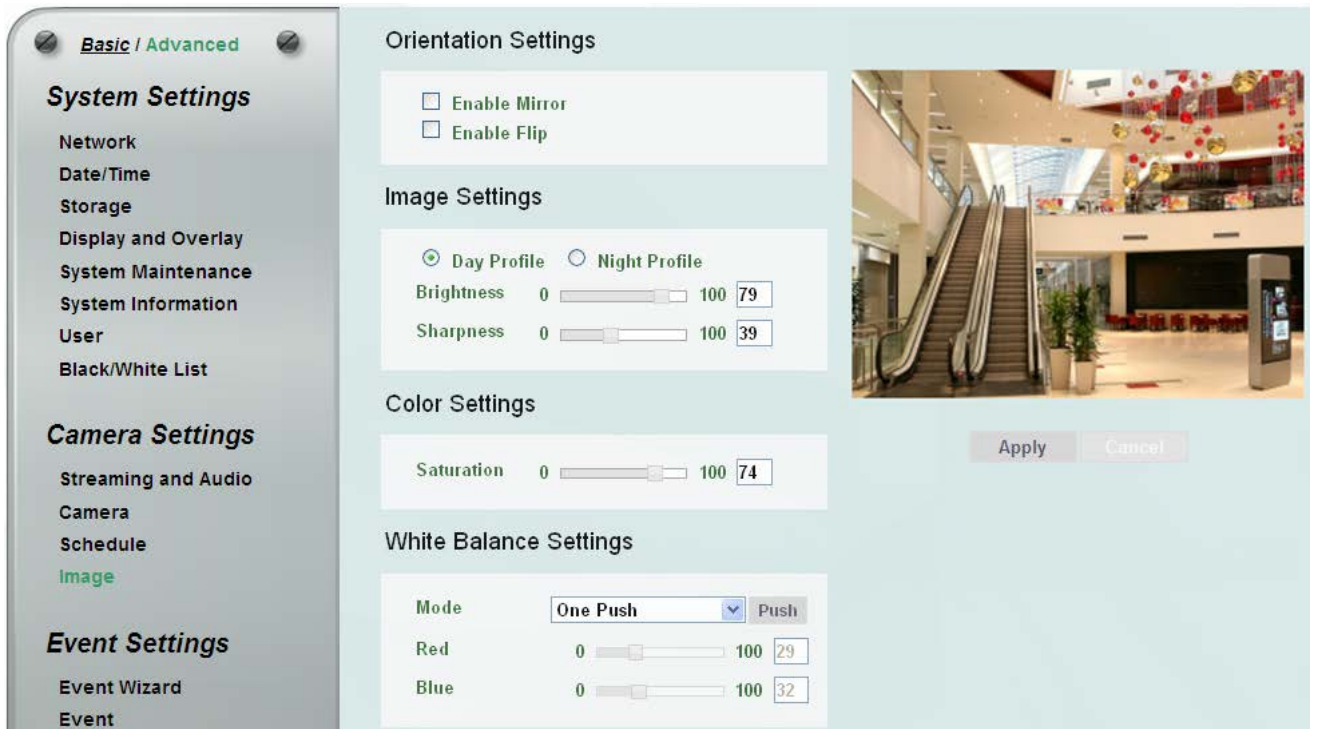

#### 【Orientation Settings】

- **Enable Mirror:** Check the box to enable the mirror function. The image will be rotated horizontally around a vertical axis.
- **Enable Flip:** Check the box to enable the flip function. The image will be rotated vertically around a horizontal axis.

【Image Settings】 Select **Day Profile** or **Night Profile** and then adjust the slide bars below to configure the brightness and sharpness for daytime or nighttime.

【Color Settings】 Slide the bar to adjust the saturation.

【White Balance Settings】 Select a mode that delivers the best image quality for the camera’s light environment.

- **Auto:** Select to let the camera automatically adjust the White Balance. In the Auto mode the camera computes the white balance value output using color information from the entire screen. It outputs the proper value using the color temperature radiating from a black subject based on a range of value from 3000 to 7500K.
- **Manual:** Select to adjust the Red and Blue values yourself in the fields below this field.
- **One Push:** Select to enable the **One Push** button on the Live View window. This will allow you to force the camera to readjust the white balance every time you push the **One Push** button.

### 7.3 Event Settings

You can set up the Motion Detection event or Tampering Detection event to automatically notify the users when an event occurs. You can also set up a schedule to automatically record the videos when an event occurs.

#### 7.3.1 Event Wizard

The Event Wizard allows users to easily configure the event settings. Follow the on-screen instructions to complete the event settings.

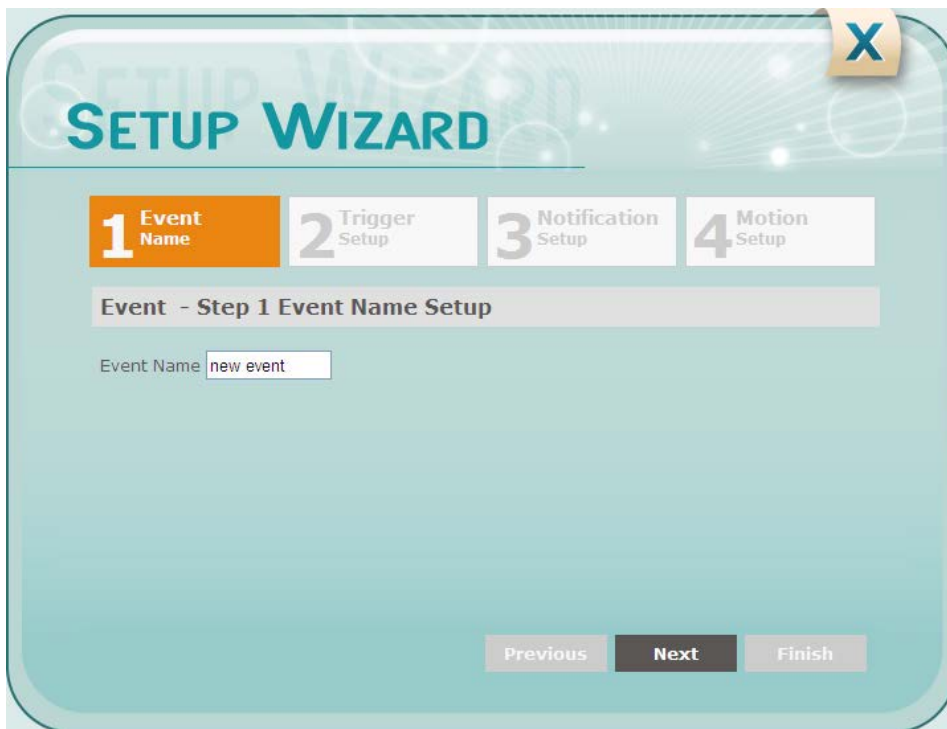

### 7.3.2 Event

This function can only be set up in the **Advanced** tab. Except the Event Wizard, you can also configure the event settings along with the Recording Schedule on this page.

Basic / **Advanced**

**System Settings**

- Network
- Date/Time
- Storage
- Display and Overlay
- System Maintenance
- System Information
- User
- Black/White List

**Camera Settings**

- Streaming and Audio
- Camera
- Schedule
- Image

**Event Settings**

- Event Wizard
- Event**
- Notification

[Link to Smart Phone App](#)

#### Event Management

Event List			
Name	Type	Notification	Enable
motion	VMD	syslog,SD,NA	true
Taipei	SR	syslog,FTP,SD	true
EF	badvideo	syslog,email,FTP,SD	true

View 1 - 3 of 3

Event Name:

Event Trigger Type: Tampering Detection Motion Area 1

Enable This event

Enable Re-trigger miniman interval between triggers  second

Enable Pre-trigger Buffer

Enable Post-trigger Buffer

Notification Over

- Log
- Send Mail Notification
- Upload to FTP
- Record to SD Card
- Network Alarm

Create Remove  
Edit Cancel

#### Trigger Options Settings

Pre-trigger Buffer  second

Post-trigger Buffer  second

Apply Cancel

#### Schedule Settings

Event 
  Schedule 
  Event + Schedule 
  Deselect

	00	01	02	03	04	05	06	07	08	09	10	11	12	13	14	15	16	17	18	19	20	21	22	23
Sun																								
Mon																								
Tue																								
Wed																								
Thu																								
Fri																								
Sat																								

Apply Cancel

#### Motion Settings

Area 1  Enable

Sensitivity 5(Normal)

Area 2  Enable

Sensitivity 5(Normal)

Area 3  Enable

Sensitivity 5(Normal)

Area 4  Enable

Sensitivity 5(Normal)

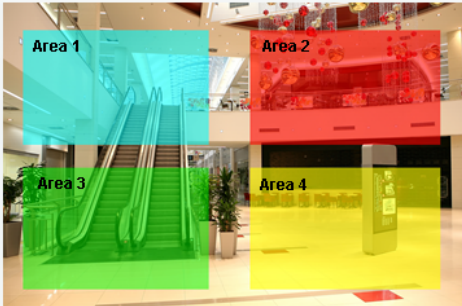

Apply Cancel

**【Event Management】** You can set up the events such as Motion Detection or Tampering Detection to automatically notify the users when an event occurs.

**Event Name:** Type an event name.

- **Event Trigger Type:** Select an event for the to-be-specified-below reaction/s.
  - **Manual Trigger:** Select this option if you want to manually trigger the alarm by clicking the **Trigger Event** button on the Live View Page.
  - **Motion Detection:** Select this option to trigger the to-be-specified-below reaction/s when motion events occur. You have to pre-configure the Motion Settings for this function to work.
  - **Schedule Recording:** Select this option if you want the Schedule Recording periods configured in the Schedule Settings to activate this event. In this scenario, a preconfigured event reaction like a log entry will list the start and end times of each period. Actual recording will only be triggered if the event is preconfigured to do so.
  - **Tampering Detection:** Select this option if you want the camera’s tampering detection sensor to trigger the to-be-specified-below reaction/s.
- **Enable This Event:** Check the box to activate the event.
- **Enable Re-trigger minimum interval between triggers xx second:** Check the box to set a minimum time after the event is triggered before the event can be triggered again.
- **Enable Pre-trigger Buffer:** Check the box if you want the Event reaction (as selected in the “Notification Over” field below) to be the activation of the video recording function, and if you want the recording to include the video feed from the time period (configurable in the Schedule Settings field) just before the Event trigger occurred.
- **Enable Post-trigger Buffer:** Check the box if you want the Event reaction (as selected in the Notification Over field) to be the activation of the video recording function, and if you want the recording to include the video feed from a time period (configurable in the Schedule Settings field) just after the Event trigger occurred.

**Notification Over:** Select the desired notification types from the following items.

- **Log:** Check the box if you want the camera to list the event’s details in its log if the event is triggered.
- **Send Mail Notification:** Check the box if you want the camera to send an email text notification and one image file to the email address entered in the SMTP Settings field (see 7.3.3 *Notification*).
- **Upload to FTP:** Check the box if you want the camera to upload the recordings to the FTP server entered in the FTP Repository Settings (see 7.3.3 *Notification*).
- **Record to SD Card:** Check the box if you want the camera to start recording its video feed (when the event occurs) on an on-camera SD Card (if such a card has been inserted).

**Note:** The recording will only be as long as the combined Pre- and Post-trigger Buffers, so make sure you enable at least one of these buffers, especially the Post-trigger Buffer.



- Network Alarm:** Check the box if you want the camera to send a network alarm signal (when the event occurs) to the CMS servers. Note that you have to configure the Network Alarm Settings for this function to work (see 7.3.3 Notification).

**Create**: Set up the Event information and click the **Create** button, the created Event information will be listed in the Event List.

**Remove**: Highlight an item in the Event List and then click the **Remove** button to remove the highlighted item.

**Edit**: Highlight an item in the Event List and edit the Event information on the left-side. Click the **Edit** button and the item will be edited.

**Cancel**: Click the button to cancel the changes and return to the previous settings.

### 【Trigger Options Settings】

- Pre-trigger Buffer:** Select the duration for the buffer. This will determine the amount of footage (length of time) before the event trigger moment that will be included in an event-triggered video recording, if that buffer and video recording has been enabled in the Event Management field.

**Enable Pre-trigger Buffer**

- Post-trigger Buffer:** Select the duration for the buffer. This will determine the amount of footage (length of time) after the event trigger moment that will be included in an event-triggered video recording, if that buffer and video recording has been enabled in the Event Management field.

**Enable Post-trigger Buffer**

Click **Apply** to apply the changes or **Cancel** to cancel the changes and return to the previous settings.

【**Schedule Settings**】 Users can configure the recording schedule here. Select the desired recording types among the options below. Click and drag the cursor on the time block, which will be applied with the selected recording type.

- Event Recording (Red):** Select for the camera to activate all the Event Recording set up in the Event Management field (Event Trigger Type), except the Schedule Recording.
- Schedule Recording (Green):** Select for the camera to activate only the Schedule Recording set up in the Event Management field (Event Trigger Type).
- Event + Schedule (Yellow):** Select for the camera to active both of the configured Event and Schedule Recordings.
- Deselect (Grey):** Select for the camera to stop recording.

Click **Apply** to apply the changes or **Cancel** to cancel the changes and return to the previous settings.

**【Motion Settings】** Use this page to configure up to four areas in which motion will be detected. When a motion is detected by the camera, the motion detection icon  will appear at the top right corner on the Live page to alert the user. This function can also be linked with correctly configured Events to trigger Event reactions like the activation of video recording periods, snapshots, etc.

To set up the Motion area:

1. Check the **Enable** box to enable the selected area.
2. Select a sensitivity value of the motion detection sensor function.
3. Click the **Draw** button  and move the cursor on the left-side live image.
4. Move the cursor to the position where you want the motion rectangle to start and then click. Move the cursor to the position (diagonally opposing corner) where you want the motion rectangle to end and then click.
5. Click the **Apply** button to apply the settings, or click the **Cancel** button to reset without saving the settings.

### 7.3.3 Notification

This function can only be set up in the **Advanced** tab.

Basic / **Advanced**

**System Settings**

- Network
- Date/Time
- Storage
- Display and Overlay
- System Maintenance
- System Information
- User
- Black/White List

**Camera Settings**

- Streaming and Audio
- Camera
- Schedule
- Image

**Event Settings**

- Event Wizard
- Event
- Notification

[Link to Smart Phone App](#)

#### SMTP (Email) Settings

SMTP Server:

SMTP Port:

Authentication

Username:

Password:

Receiver Address:

(use ; to separate addresses)

Sender Address:

Attach Image

SSL Connection

Send Test Email:

#### FTP Repository Settings

FTP Server:

FTP Port:

Recording Path:

Username:

Password:

PASV Mode

Test FTP Server:

#### SNMP Settings

Enable SNMP v1/v2/v2c

Read-Only Community:

Read-Write Community:

Trap Community:

Trap Address:

Enable SMNP v3

Read-Only Username:

Read-Only Auth. Method:

Read-Only Auth. Key:

Read-Only Privacy Method:

Read-Only Privacy Key:

Read-Write Username:

Read-Write Auth. Method:

Read-Write Auth. Key:

Read-Write Privacy Method:

Read-Write Privacy Key:

#### Network Alarm Settings

Protocol:

Port No:

Unique ID:

Server 1:

Server 2:

Server 3:

**【SMTP (Email) Settings】** This area is for configuring the mail server that is used to send e-mail text notifications and one image file from the camera to predefined addresses via SMTP. Note that to enable e-mail notification function, you have to check the **Send Mail Notification** box in the Event Management field (see 7.3.2 *Event*).



- **SMTP Server:** Enter the IP address or the host name of the SMTP server used to send e-mails.
- **SMTP Port:** Enter the port number for SMTP. The default is 25.
- **Authentication:** Check the box if the SMTP server requires authentication (user/password).
- **Username:** Input the user's login ID if the SMTP server requires authentication.
- **Password:** Input the user's login password if the SMTP server requires authentication.
- **Receiver Address:** Input the e-mail addresses for receiving an e-mail message when events occur. Please use “;” to separate multiple addresses.
- **Sender Address:** Input the sender's e-mail address, so that the receiver can recognize the sender when an event message is received.
  - **Attach Image:** Check the box if you want to attach an image when events occur.
  - **SSL Connection:** Check the box to enable the SSL function. Enable this function means you can access the camera through the SSL protocol that provides communication security over the Internet.
- **Send Test Email:** Click the **Test** button to send a testing email to the assigned address.

Click **Apply** to apply the changes or **Cancel** to cancel the changes and return to the previous settings.

**【FTP Repository Settings】** This area is for configuring the FTP server that is used to send alarm recordings from the camera to the preconfigured FTP server. Note that to enable uploading recordings to the FTP server function, you have to check the **Upload to FTP** box in the Event Management field (see 7.3.2 *Event*).



- **FTP Server:** Enter the IP address or the host name of the FTP server.
- **FTP Port:** Enter the port number for the FTP server. Default is 21.
- **Recording Path:** Assign the recording path.
- **Username:** Set FTP User's name.
- **Password:** Set FTP password.
- **PASV mode:** Check the box to enable Passive mode. Passive mode is normally enabled. If a connection cannot be established, uncheck "PASV Mode".
- **Test FTP Server:** Click the **Test** button to send a testing file to the assigned FTP server.

Click **Apply** to apply the changes or **Cancel** to cancel the changes and return to the previous settings.

**【SNMP Settings】**The default values for SNMP v1/v2/v2c and SNMP v3 are already filled in. Click either of the Enable buttons to enable either of the two. Make your changes as desired. Click on the Trap Address field to enter the digits, if required.

Click **Apply** to apply the changes or **Cancel** to cancel the changes and return to the previous settings.

**【Network Alarm Settings】** This function works with EverFocus CMS software. The camera can send a network alarm signal (when the event occurs) to the CMS servers. To establish the connection between the camera and CMS servers, the protocol and port number should match with each other. For more details, please refer to the CMS user's manual. Note that to enable the Network Alarm function, you have to check the **Network Alarm** box in the Event Management field (see 7.3.2 *Event*).

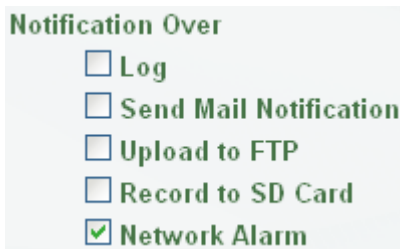

**Notification Over**

- Log
- Send Mail Notification
- Upload to FTP
- Record to SD Card
- Network Alarm

Click **Apply** to apply the changes or **Cancel** to cancel the changes and return to the previous settings.

## 7.4 Link to Smart Phone App

You can access camera live view or take a snapshot via your smart phone. This page is designed for users to download the mobile app to your mobile phone by scanning the QR code.

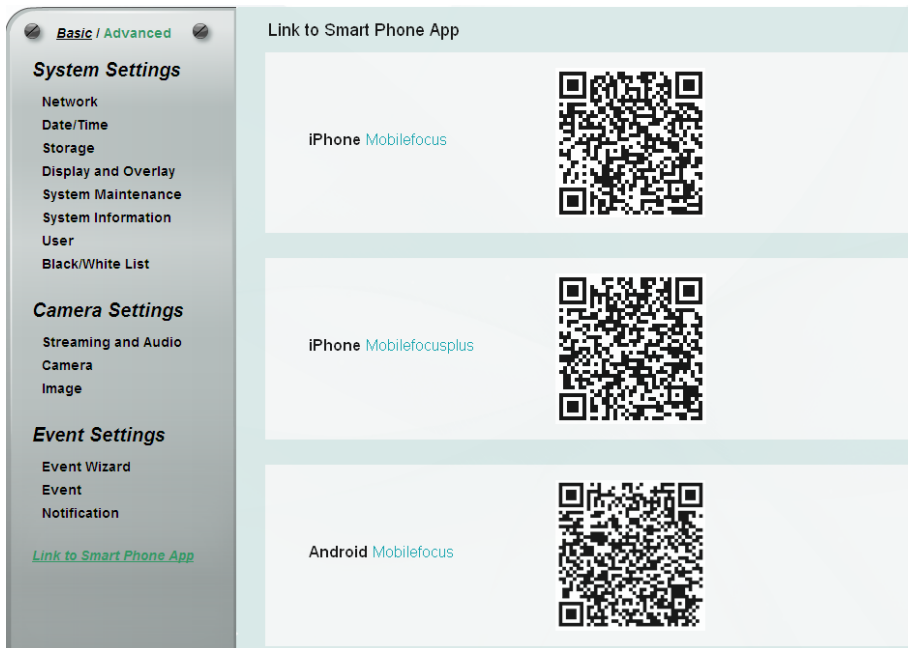

### MobileFocus for iPhone



### MobileFocusPlus for iPhone



### MobileFocus for Android-based smart phone

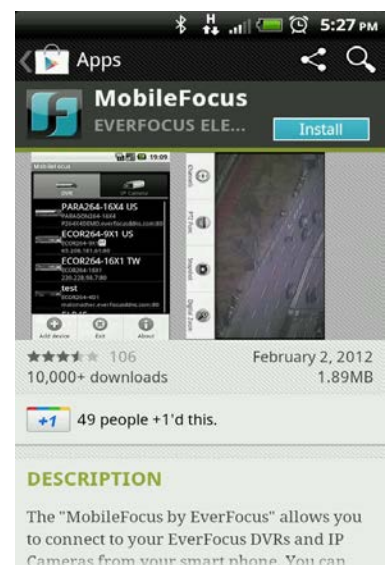

## 8. Upgrading Firmware Using IP Utility

You can upgrade the Firmware using the **IP Utility** software included in the software CD.

1. Install and then start the **IP Utility** . The following dialog box appears.

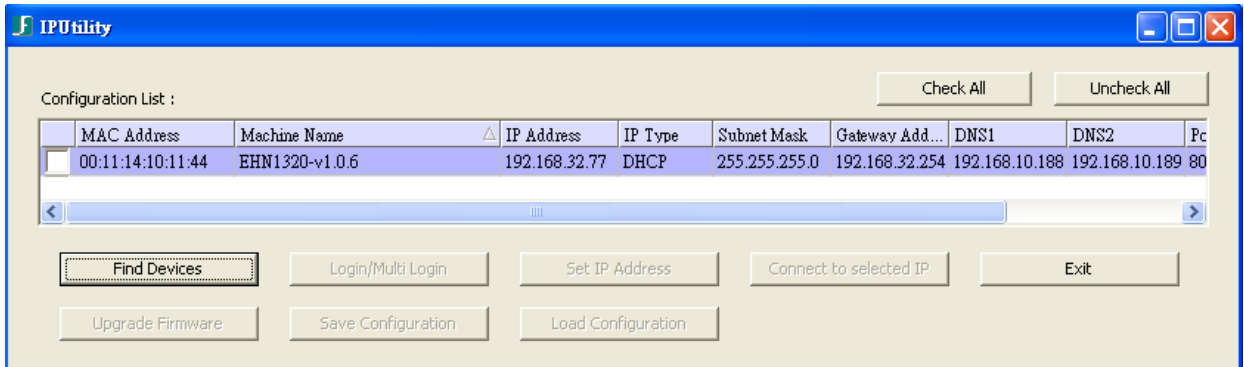

2. IPU will automatically search the cameras connected in the LAN. The default network values of the cameras will be displayed. By default, the network protocol of the camera is **DHCP**.
3. Select a camera and click **Login/Multi Login** to log in the camera.

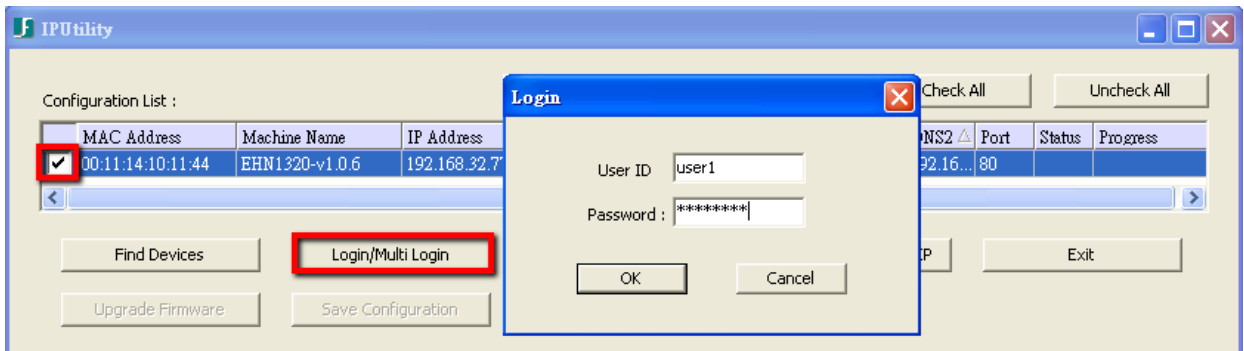

4. Type the user ID and password. Click **OK**.

**Note:**

1. The default user ID is **user1** and the default password is **11111111**.
2. If you select more than one camera that has the same user ID / password, you will be able to log in several cameras at once.
3. Up to 10 cameras can be simultaneously upgraded to the latest firmware. If you connect the cameras to a PoE switch, please make sure the Power Consumption of the PoE switch is sufficient.

- Select the camera and then click **Upgrade Firmware**. A browsing window appears.

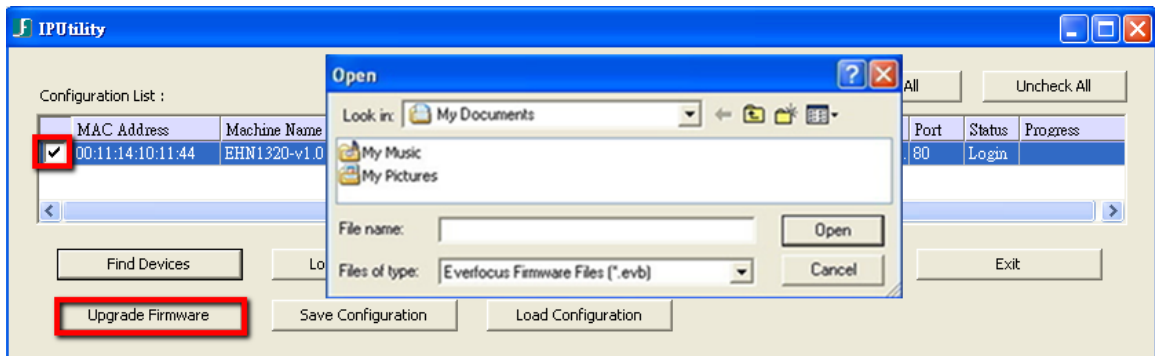

- Select the **firmware file (.evb)** and then click **Open**. The IP Utility will automatically upgrade the firmware.

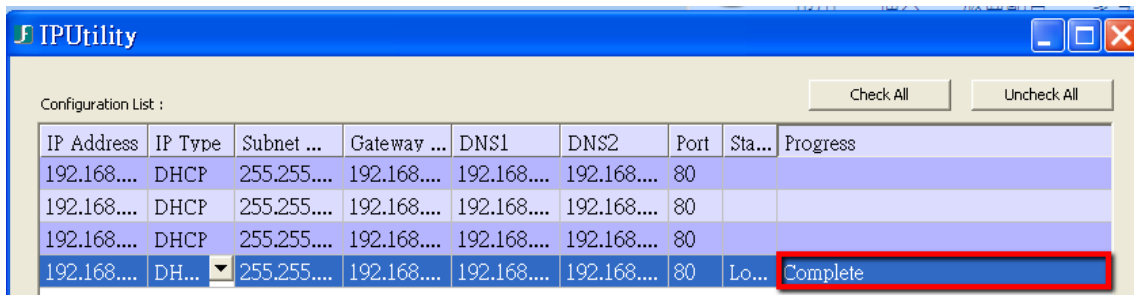

The camera will reboot once the update is complete. Click **Find Devices**, the new firmware version should be displayed in the last part of the Machine Name.



## 9. Specifications

Model	EHN1120		EHN1220		EHN1320	
<b>System Information</b>						
CPU	Multimedia SoC (System-on-Chip)					
Flash	32 MB					
RAM	512 MB					
<b>Camera</b>						
Image Sensor	1/2.7" Progressive		1/2.7" Progressive		1/3" Progressive CMOS	
Megapixel	1.3 MP		2 MP		3 MP	
Max. Resolution	1280 x 1024		1920 x 1080		2048 x 1536	
Min. Illumination	Color: 0.5 Lux B/W: 0.1 Lux		Color: 0.5 Lux B/W: 0.1 Lux		Color: 0.3 Lux B/W: 0.1 Lux	
Electronic Shutter	4 ~ 1/15,000 sec.		4 ~ 1/15,000 sec.		4 ~ 1/25,000 sec.	
Scanning System	NTSC / PAL					
WDR	Yes					
Digital Zoom	10x					
Image Settings	Compression, Brightness, Sharpness, Contrast, Saturation, Hue, White Balance, Exposure Control, Backlight Compensation, Rotation, Mirroring of images, Text and Image Overlay, Auto Gain Control, Auto White Balance					
Event Trigger	Manual Trigger, Motion Detection, Tamper Detection					
Notification	E-mail notification, FTP uploading, record video to PC and network alarm					
<b>Lens</b>						
Lens Type	Fixed-focal					
Focal Length (Selectable)	2.8 mm / 3.6 mm / 6 mm / 8 mm					
Aperture	F1.8 (f = 2.8 mm / 3.6 mm / 6 mm) F1.6 (f = 8 mm)					
Day / Night	Electronic D/N					
<b>Video</b>						
Video Compression	H.264 and MJPEG		H.264, MPEG4 and MJPEG			
Resolution	NTSC	2048 x 1536, 1920 x 1200 (for EHN1320 only) 1920 x 1080 (for EHN1320/1220 only), 1280 x 1024, 1280 x 720 (for EHN1320/1220 only), 1024 x 768, 720 x 480, 704 x 480, 640 x 480, 352 x 240, 320 x 240, 160 x 128				
	PAL	2048 x 1536, 1920 x 1200 (for EHN1320 only) 1920 x 1080 (for EHN1320/1220 only), 1280 x 1024, 1280 x 720 (for EHN1320/1220 only), 1024 x 768, 720 x 576, 704 x 576, 640 x 480, 352 x 288, 320 x 240, 160 x 128				

<b>Frame Rate</b>	30 fps at 1280 x 1024	30 fps at 1920 x 1080	15 fps at 2048 x 1536
<b>S/N Ratio</b>	Above 48dB		
<b>Audio</b>			
<b>Audio Capability</b>	Audio input		
<b>Audio Compression</b>	G.711, GSM-AMR, AAC		
<b>Interface</b>	Internal microphone / Line-In		
<b>Effective Range</b>	5 meters		
<b>Network</b>			
<b>Interface</b>	10 / 100 Base-T Ethernet, LAN / PoE Cable		
<b>Supported Protocols</b>	TCP/IP, IPV6, UDP, ICMP, DHCP, NTP, DNS, DDNS, SMTP, SNMP, FTP, HTTP, HTTPS, PPPoE, UPnP, Bonjour, RTP, RTSP, RTCP, IGMP, ARP, ONVIF, PSIA		
<b>Mechanical</b>			
<b>Memory Card</b>	One built-in micro SD / SDHC card slot		
<b>Video Test-Out Connector</b>	One built-in DIP connector		
<b>LAN / PoE Cable</b>	Connects to a 10 / 100 Base-T Ethernet or PoE		
<b>Power Cable</b>	10-36 VDC input		
<b>Audio Cable</b>	Line-in cable		
<b>Camera Angle Adjustment</b>	<b>Pan</b>	-25° ~ 25°	
	<b>Tilt</b>	0° ~ 90°	
	<b>Rotate</b>	-90° ~ 90°	
<b>General</b>			
<b>Power Source</b>	10-36 VDC / PoE (IEEE802.3af)		
<b>Power Consumption</b>	7.5W (10-36 VDC) 4.8W (PoE)	7.5W (10-36 VDC) 6.2W (PoE)	7.5W (10-36 VDC) 5.9W (PoE)
<b>Operating Temperature</b>	-40°C ~ 55°C / -40°F ~ 131°F (DC Power) -20°C ~ 55°C / -4°F ~ 131°F (PoE)		
<b>Humidity</b>	20% ~ 80% (no condensation)		
<b>Safety</b>	CE, FCC, EN50155		
<b>Vandal-Proof</b>	IK10		
<b>Weather-Proof</b>	IP67-rated		
<b>Dimensions (L x W x H)</b>	130 x 112 x 46.5 mm / 5.12" x 4.41" x 1.83"		
<b>Weight</b>	300 g / 0.66 lbs		
<b>Language</b>	Czech, Dutch, English, French, German, Japanese, Polish, Portuguese, Russian, Simplified Chinese, Spanish, Traditional Chinese		

## 10. Troubleshooting

### Error messages pop up

When these error messages pop up, follow the steps below to fix the problem.



1. To enter the Registry Editor of your computer: Click **Start** and type “**regedit**” in the *Search Program and Files* field.

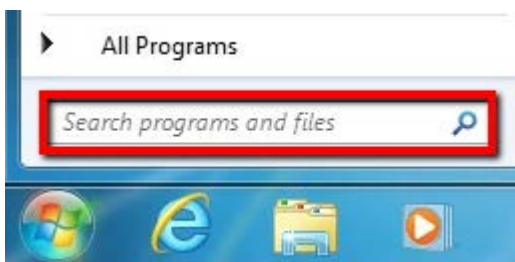

2. Click the **Enter** button, the Registry Editor window appears.

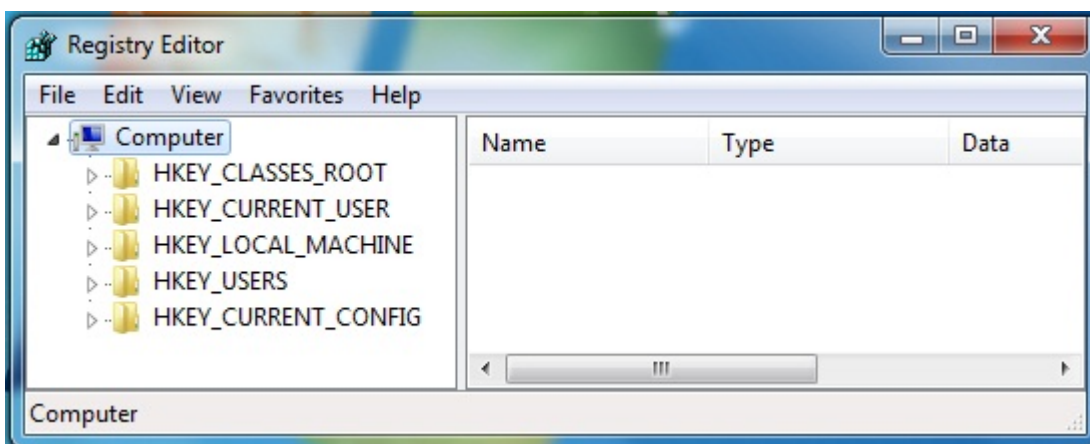

3. Find the **KeepAlive Timeout** Dword by following the path:

\HKEY\_CURRENT\_USER\Software\Microsoft\Windows\CurrentVersion\Internet Settings

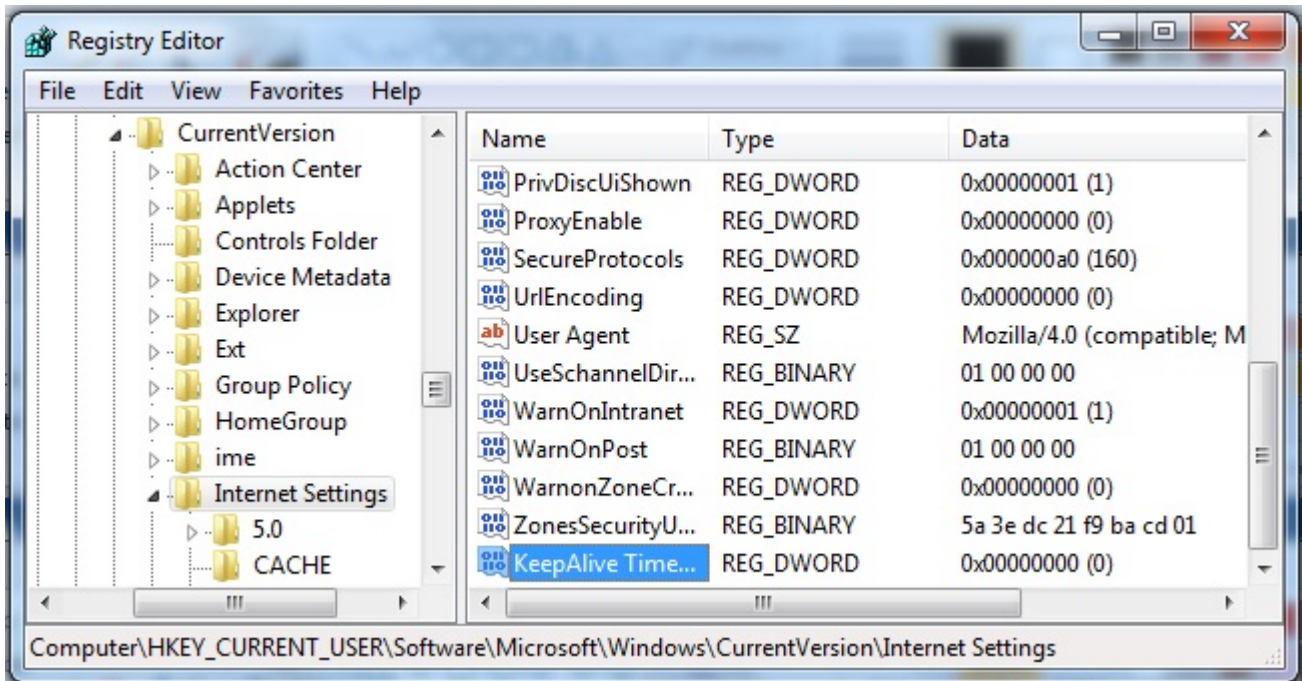

4. Double-click **KeepAlive Timeout** and this window appears.

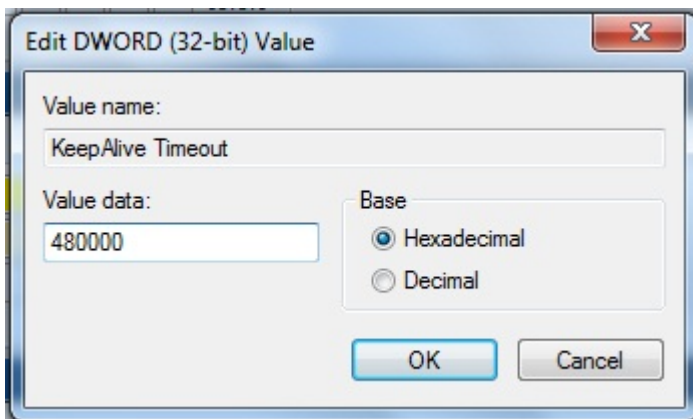

5. Change the Value data to **480000** and click **OK**.

# EverFocus Electronics Corp.

## EverFocus Taiwan:

12F, No.79, Sec. 1, Shin-Tai Wu Road,  
Hsi-Chih, Taipei, Taiwan  
TEL: +886 2 2698 2334  
FAX: +886 2 2698 2380  
www.everfocus.com.tw  
[marketing@everfocus.com.tw](mailto:marketing@everfocus.com.tw)

## EverFocus China - Beijing:

Room 609, Technology Trade Building,  
Shangdi Information Industry Base,  
Haidian District, Beijing 100085, China  
TEL: +86 10 6297 3336~39  
FAX: +86 10 6297 1423  
www.everfocus.com.cn  
[marketing@everfocus.com.cn](mailto:marketing@everfocus.com.cn)

## EverFocus USA - California:

1801 Highland Avenue, Unit A, Duarte, CA 91010, USA  
TEL: +1 626 844 8888  
FAX: +1 626 844 8838  
www.everfocus.com  
[sales@everfocus.com](mailto:sales@everfocus.com)

## EverFocus Japan:

5F, Kinshicho City Building, 2-13-4 Koto-Bashi, Sumida-Ku,  
Tokyo, 130-0022, Japan  
TEL: +81 3 5625 8188  
FAX: +81 3 5625 8189  
www.everfocus.co.jp  
[info@everfocus.co.jp](mailto:info@everfocus.co.jp)

## EverFocus India:

Suite 803, Housefin Bhavan, C-21,  
Bandra Kurla Complex, Bandra (East),  
Mumbai 400051, India  
TEL: +91 22 6128 8700  
FAX: +91 22 6128 8705  
www.everfocus.in  
[sales@everfocus.in](mailto:sales@everfocus.in)

## EverFocus Europe - Germany:

Albert-Einstein-Strasse 1, D-46446  
Emmerich, Germany  
TEL: +49 2822 93940  
FAX: +49 2822 939495  
www.everfocus.de  
[sales@everfocus.de](mailto:sales@everfocus.de)

## EverFocus China - Shenzhen:

4F, No. 2, D4 Building, Wan Yelong  
Industrial Park, Tangtou Road, Shiyao,  
Baoan, Shenzhen, Guangdong 518101, China  
TEL: +86 755 2765 1313  
FAX: +86 755 2765 0337  
www.everfocus.com.cn  
[marketing@everfocus.com.cn](mailto:marketing@everfocus.com.cn)

## EverFocus USA - New York:

415 Oser Avenue, Unit S, Hauppauge, NY 11788, USA  
TEL: +1 631 436 5070  
FAX: +1 631 436 5027  
www.everfocus.com  
[sales@everfocus.com](mailto:sales@everfocus.com)

## EverFocus Europe - UK:

Unit 12, Spitfire Business Park,  
Hawker Road, Croydon Surrey, CR0 4WD, UK  
TEL: +44 20 8649 9757 / +44 845 430 9999  
FAX: +44 20 8649 9907  
www.everfocusuk.co.uk  
[salesuk@everfocus.com](mailto:salesuk@everfocus.com)



Your EverFocus product is designed and manufactured with high quality materials and components which can be recycled and reused. This symbol means that electrical and electronic equipment, at their end-of-life, should be disposed of separately from your household waste. Please, dispose of this equipment at your local community waste collection/recycling centre. In the European Union there are separate collection systems for used electrical and electronic product. Please, help us to conserve the environment we live in!

Ihr EverFocus Produkt wurde entwickelt und hergestellt mit qualitativ hochwertigen Materialien und Komponenten, die recycelt und wieder verwendet werden können. Dieses Symbol bedeutet, dass elektrische und elektronische Geräte am Ende ihrer Nutzungsdauer vom Hausmüll getrennt entsorgt werden sollen. Bitte entsorgen Sie dieses Gerät bei Ihrer örtlichen kommunalen Sammelstelle oder im Recycling Centre. Helfen Sie uns bitte, die Umwelt zu erhalten, in der wir leben!



P/N: 4605PH1120B010A