

EDN Series Mini Dome IP Camera

H.264, Easy Installation, Micro SD Card, Night Vision

User's Manual



Copyright © EverFocus Electronics Corp,

Release Date: October, 2013



Copyright © 2013 EverFocus Electronics Corp.

All rights reserved. No part of the contents of this manual may be reproduced or transmitted in any form or by any means without written permission of the EverFocus Electronics Corporation.

EverFocus

12F, No.79, Sec. 1, Shin-Tai Wu Road,

Hsi-Chih, Taipei, Taiwan

TEL: +886 2 2698 2334

FAX: +886 2 2698 2380

www.everfocus.com.tw

October, 2013

About this document

All the safety and operating instructions should be read and followed before the unit is operated. This manual should be retained for future reference. The information in this manual was current when published. The manufacturer reserves the right to revise and improve its products. All specifications are therefore subject to change without notice.

Regulatory Notices

FCC Notice "Declaration of Conformity Information"

This equipment has been tested and found to comply with the limits for a Class A digital device, pursuant to part 15 of the FCC Rules. These limits are designed to provide reasonable protection against harmful interference in a residential installation. This equipment generates, uses and can radiate radio frequency energy and, if not installed and used in accordance with the instructions, may cause harmful interference to radio communications. However, there is no guarantee that interference will not occur in a particular installation. If this equipment does cause harmful interference to radio or television reception, which can be determined by turning the equipment off and on, the user is encouraged to try to correct the interference by one or more of the following measures:

- Reorient or relocate the receiving antenna.
- Increase the separation between the equipment and receiver.
- Connect the equipment into an outlet on a circuit different from that to which the receiver is connected.
- Consult the dealer or an experienced radio/TV technician for help.

Warning: Changes or modifications made to this equipment, not expressly approved by EverFocus or parties authorized by EverFocus could void the user's authority to operate the equipment.

This device complies with part 15 of the FCC Rules. Operation is subject to the following two conditions:

- (1) This device may not cause harmful interference, and
- (2) This device must accept any interference received, including interference that may cause undesired operation.

EverFocus Electronics Corp.

12F, No. 79, Sec. 1, Shin-Tai Wu Rd., Hsi-Chi,
Taipei Hsien, Taiwan, R.O.C.

EDN Series cameras comply with CE and FCC.

Precautions

1. Do not install the camera near electric or magnetic fields.

Install the camera away from TV/radio transmitters, magnets, electric motors, transformers and audio speakers since the electromagnetic fields generated from these devices may distort the video image or otherwise interfere with camera operation.

2. Never disassemble the camera beyond the recommendations in this manual nor introduce materials other than those recommended herein.

Improper disassembly or introduction of corrosive materials may result in equipment failure or other damage.

3. Try to avoid facing the camera toward the sun.

In some circumstances, direct sunlight may cause permanent damage to the sensor and/or internal circuits, as well as creating unbalanced illumination beyond the capability of the camera to compensate.

4. Keep the power cord away from water and other liquids and never touch the power cord with wet hands.

Touching a wet power cord with your hands or touching the power cord with wet hands may result in electric shock.

5. Never install the camera in areas exposed to oil, gas or solvents.

Oil, gas or solvents may result in equipment failure, electric shock or, in extreme cases, fire.

6. Cleaning

For cameras with interchangeable lenses, do not touch the surface of the sensor directly with the hands. Use lens tissue or a cotton tipped applicator and ethanol to clean the sensor and the camera lens. Use a damp soft cloth to remove any dirt from the camera body. Please do not use complex solvents, corrosive or abrasive agents for cleaning of any part of the camera.

7. Do not operate the camera beyond the specified temperature, humidity or power source ratings.

This camera is suitable for outdoor operation only. Use the camera at temperatures within 0°C~40°C/32°F~104°F. The input power source is 12 VDC/PoE. Be sure to connect the proper + / - polarity and voltage, as incorrect polarity or too high a voltage will likely cause the camera to fail, and such damage is not covered by the warranty. The use of properly fused or Class 2 power limited type supplies is highly recommended.

8. Mounting

Use care in selecting a solid mounting surface which will support the weight of the camera plus any wind, snow, ice or other loading, and securely attach the camera to the mounting surface using screws and anchors which will properly support the camera. If necessary (e.g. when mounting to drop ceilings) use a safety wire to provide additional support for the camera.

CONTENTS

1.	Introduction.....	1
2.	Physical Description.....	2
3.	Features	3
4.	Installation	4
4.1	Packing List.....	4
4.2	Optional Accessory	4
4.3	Basic Installation	5
4.4	Wall-Mount Installation Using a Dome Bracket	9
5.	Accessing the User Interface.....	12
5.1	Checking the Dynamic IP Address.....	12
5.2	Settings for Microsoft Internet Explorer.....	15
5.3	Connecting the Camera to the Network.....	18
5.4	Live View Window	20
5.5	Switching Streams.....	22
5.6	Digital Zoom Window	22
6.	Playback	23
6.1	Local Playback.....	23
6.2	Remote Playback.....	23
7.	Settings	25
7.1	System Settings.....	25
7.1.1	System Information & Log	25
7.1.1.1	System Information.....	25
7.1.1.2	Status	26
7.1.1.3	Parameters.....	26
7.1.1.4	Remote Log Setting.....	26
7.1.1.5	Current Log	27
7.1.2	Network	28
7.1.2.1	Protocol Setting.....	28
7.1.2.2	Network Setting	29
7.1.2.3	DDNS Setting.....	32
7.1.3	DateTime	34
7.1.3.1	Time Zone	34
7.1.3.2	Daylight Saving.....	34
7.1.3.3	Time Setting.....	34
7.2	Camera Settings.....	35
7.2.1	Camera	35
7.2.1.1	Camera Setting.....	35

7.2.1.2	Video Setting	36
7.2.1.3	WDR Setting.....	37
7.2.1.4	Infrared LED Setting	37
7.2.1.5	Microphone Setting	38
7.2.2	Streaming.....	38
7.2.2.1	Video Codec Setting.....	38
7.2.2.2	Snapshot and Time Display Setting	39
7.3	Record.....	40
7.3.1	The Record Storage is.....	40
7.3.2	The Record Type.....	41
7.3.3	Client Setting Record.....	43
7.4	Storage.....	44
7.4.1	NAS Server Setting	44
7.4.2	SD Card.....	45
7.5	Event.....	47
7.5.1	Application Setting.....	47
7.5.2	Schedule Mode	48
7.5.3	Trigger Mode.....	48
7.5.4	Media Mode.....	50
7.5.5	Response Mode	51
7.6	User Management.....	53
7.6.1	Security Setting	53
7.6.2	Manage User.....	54
7.7	Access List	56
7.7.1	Access List Setting	56
7.7.2	Filter information.....	57
7.8	Maintenance.....	58
7.8.1	General Setting	58
7.8.2	Reboot System	58
7.8.3	Restore System.....	59
7.8.4	Export / Import File.....	59
7.8.5	Upload Firmware	60
7.8.6	Language.....	60
8.	Upgrading Firmware Using IP Utility	61
9.	Specifications.....	63
10.	Troubleshooting	65

1. Introduction

The EDN Series IP camera is a palm-sized mini dome that comes with three models, 1 MP, 2 MP and 5 MP, providing up to 10 fps at 2560 x 1920 viewing resolution. The cameras support dual streams from H.264, MJPEG or MPEG4. Equipped with 19 IR LEDs, the EDN series cameras can support the night visibility of up to 10 meters.

The EDN series cameras are small yet versatile and powerful. With the true Day/Night functionality benefited from auto IR-cut filter, the cameras can deliver high-clarity images in lowlight or nighttime conditions. Coupled with the Wide Dynamic Range (WDR) function to overcome extreme lighting conditions, the cameras are able to offer optimized quality images during the day. A built-in micro SDHC card slot and Power over Ethernet (IEEE802.3af Class 3) features are also provided. You can power the camera over the network or by connecting the camera to a 12 VDC power supply.

Since the EDN series conforms to ONVIF / PSIA for compatibility with other network video devices, it interoperates with a wide variety of hardware and software systems. You can also use EverFocus Mobile Applications to remotely monitor the live views of the cameras through your handheld devices; or use EverFocus CMS to remotely manage multiple IP devices connected on the network. With all the above advantages plus the simple and flat user interface design, the EDN series brings out the clarity and usability in your surveillance system.

The EDN Series Mini IP Dome Models

Model Name	Megapixel	Fixed Lens
EDN2160	1 MP	4 mm, F2.0
EDN2260	2 MP	
EDN2560	5 MP	

Minimum System Requirement

Before installing, please check that your device meets the following requirements.

- **Device:** Microsoft Windows / Mac / Pad / Smart Phone
- **Browser:** IE8 and above / Chrome / Firefox / Safari

2. Physical Description

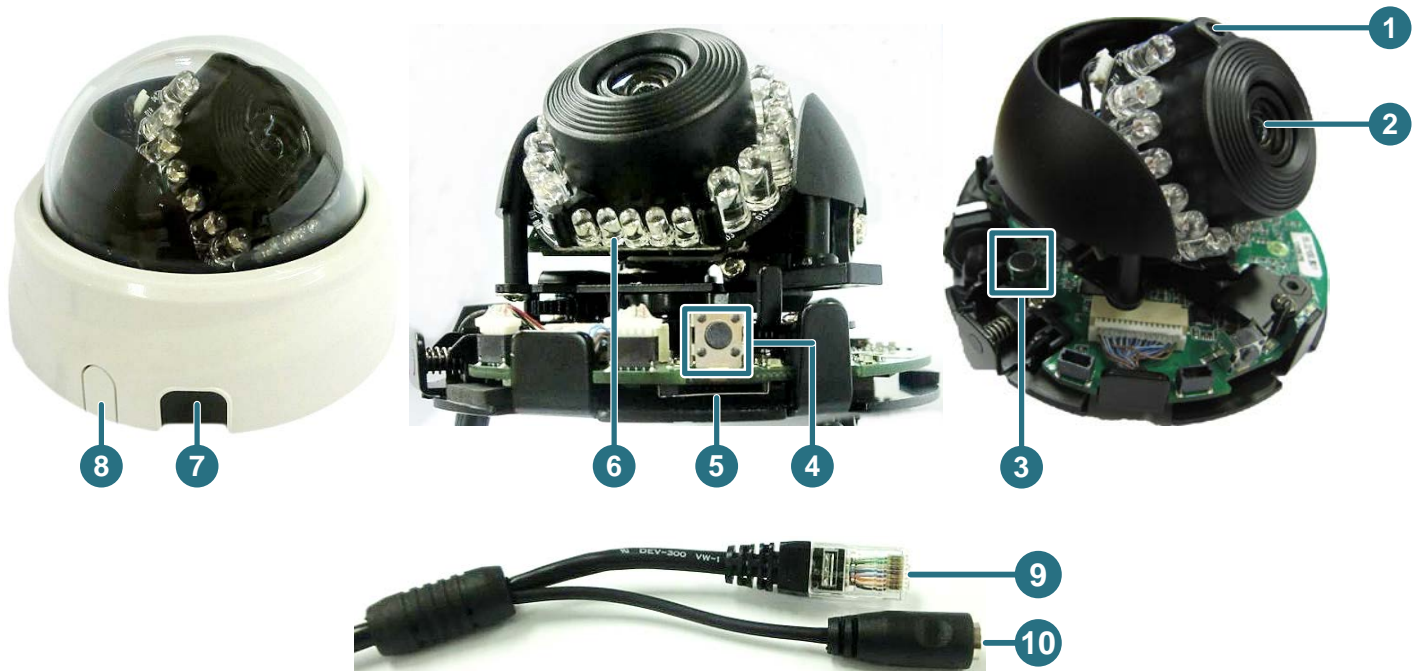

No.	Item Name	Descriptions
1	Light Sensor	Detects lights.
2	Lens	Fixed IRIS with 4 mm focal length and F2.0 aperture.
3	Microphone	One built-in microphone.
4	Reset Button	Resets all configurations to the factory default settings.
5	Micro SD / SDHC Slot	For inserting a micro SD / SDHC card.
6	LEDs	19 IR LEDs for infrared illumination in night vision applications.
7	Release Button	Push to remove the camera cover.
8	Plastic Cut	Remove to wire the cables along the wall / ceiling.
9	LAN / PoE Cable	Connects to a 10/100 Ethernet or PoE.
10	Power Cable	Connects to a 12 VDC power.

Dimensions

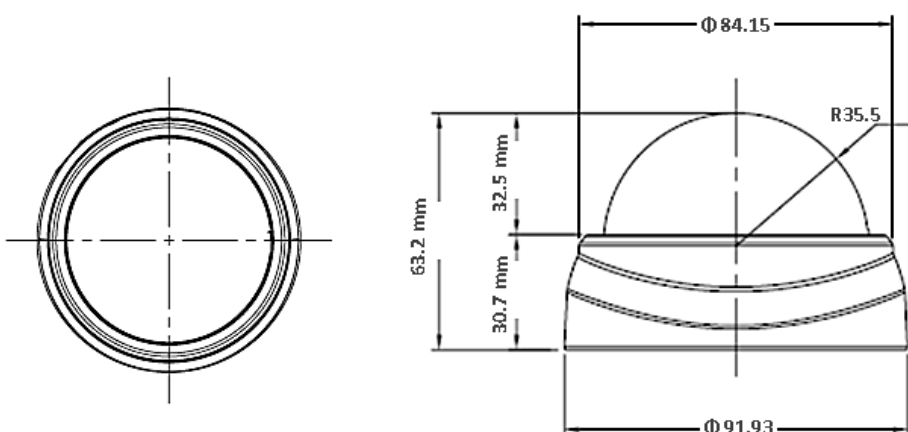

3. Features

- 1/4" color CMOS image sensor delivers 1-megapixel resolution (EDN2160)
1/2.7" color CMOS image sensor delivers 2-megapixel resolution (EDN2260)
1/3" color CMOS image sensor delivers 5-megapixel resolution (EDN2560)
- Mini palm-sized, easy installation
- Provides True Day/Night functionality with automatic IR filter operation
- Wide Dynamic Range function
- Extended IR range of up to 10 meters with 19 IR LEDs
- Dual streaming from H.264, MJPEG or MPEG4
- H.264 up to 30 fps at 1280 x 800 of video resolution (EDN2160)
H.264 up to 30 fps at 1920 x 1080 of video resolution (EDN2260)
H.264 up to 10 fps at 2560 x 1920 of video resolution; 30 fps at all the other resolution (EDN2560)
- Built-in microphone
- Built-in Micro SD Card slot for edge recording
- Support Motion Detection and Email Notification functions
- 12 VDC / PoE
- Multi-languages on Web interface
- ONVIF / PSIA compliant
- Supports EverFocus CMS and Mobile Applications (iOS / Android)

4. Installation

4.1 Packing List

Please check that there is no missing item in the package before installing.

- Camera x 1
- Base Plate and Mounting Plate x 1
- RJ-45 connector x 1
- Software CD x 1
- Quick Installation Guide x 1
- Mounting Kit x 1
 - Screw Anchor x 2
 - Long Screw x 2
 - Short Screw x 2
 - Fix Screw x 1

Note:

1. Equipment configurations and supplied accessories vary by country. Please consult your local EverFocus office or agents for more information. Please also keep the shipping carton for possible future use.
2. Contact the shipper if any items appear to have been damaged in the shipping process.

4.2 Optional Accessory

The Dome Bracket (BA-ED) is an L-type bracket designed to install the dome camera on the wall. For details on the wall-mount installation, please refer to *4.4 Wall-Mount Installation Using a Dome Bracket*.



4.3 Basic Installation

The camera adopts a clever mounting design for users to easily install or remove it from the wall / ceiling.

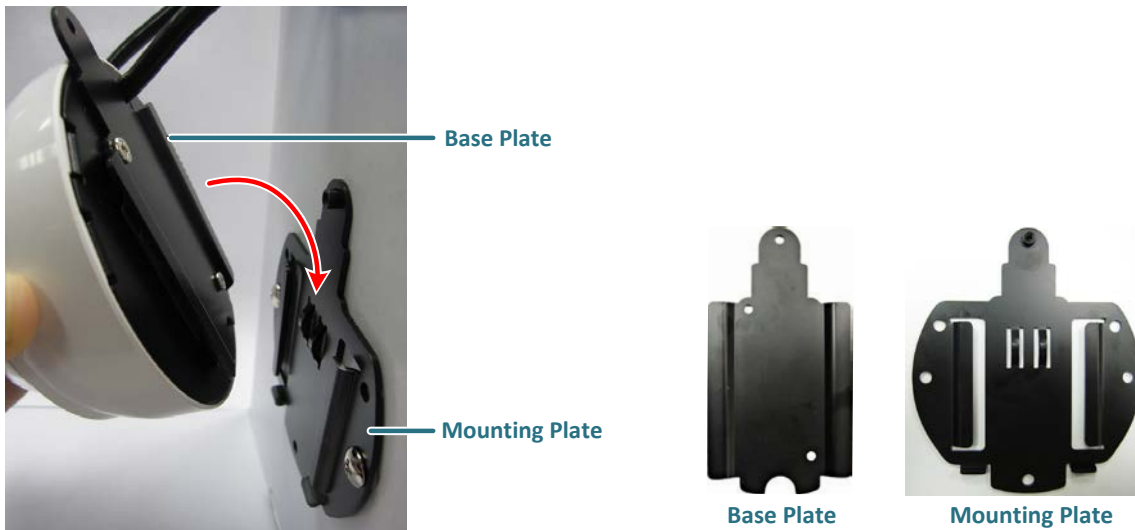

Please follow the detail steps below to mount the camera to the wall / ceiling:

1. Screw the Base Plate onto the bottom of the camera using the supplied Short Screws.

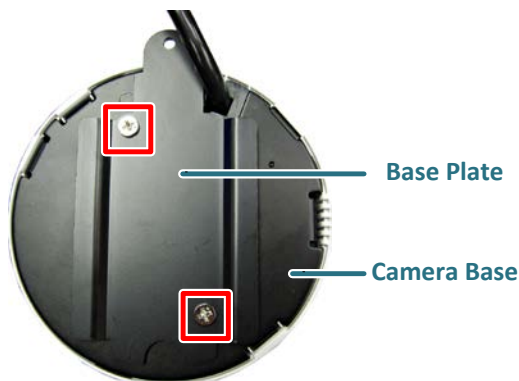

2. Attach the Mounting Plate to the wall / ceiling and mark the location of the screw holes based on the Mounting Plate.

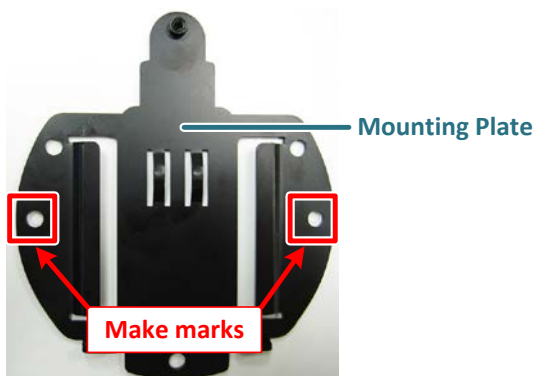

Note: Before drilling the holes, make sure the camera lens can be adjusted to the desired view of your surveillance environment.

3. Drill the two marks and insert the supplied two Screw Anchors into the anchor holes. Then, screw the Mounting Plate to the wall / ceiling.



4. Thread the cables from the side cut of the camera or through the wall.
 - a. To thread the cables through the wall / ceiling:
 - (1) Drill a hole on the upper-left side of the Mounting Plate.

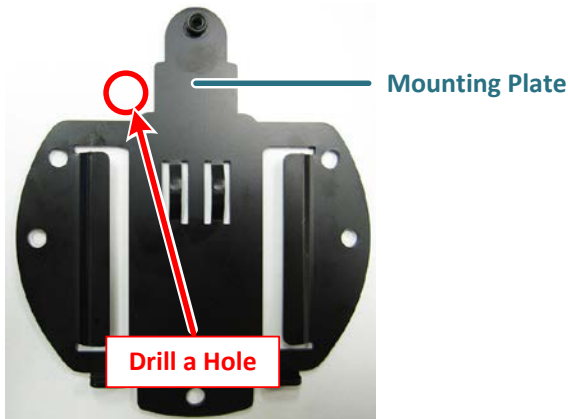

- (2) Run the cables through the hole and then slide the camera into the Mounting Plate.

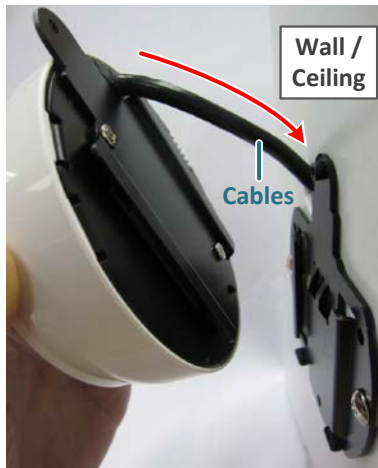

b. To thread the cables from the side cut of the camera:

- (1) Remove the camera cover by pressing the Release Button. Break the Plastic Cut and then pull it out.



- (2) Run the cable through the side cut of the camera cover.



- (3) Slide the camera into the Mounting Plate.



5. Press the Release Button to remove the cover and then:
 - a. Adjust the camera Pan / Tilt angles.

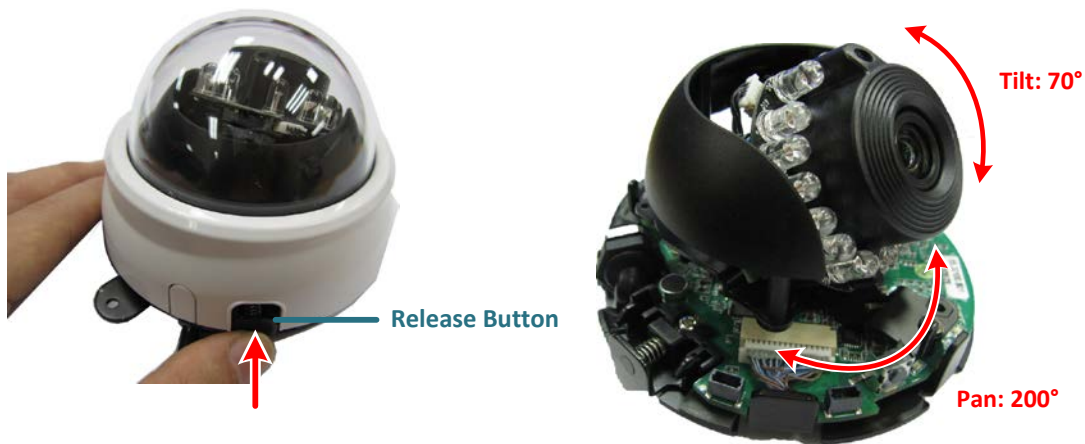

- b. Optionally insert a micro SD / SDHC card to the card slot.



6. Connect the network and power cables to the camera.
7. Place the dome cover back by aligning the Cut-Out with the Release Button. Press the dome cover for it to snap into place. A "click" sound should be heard when installed properly.

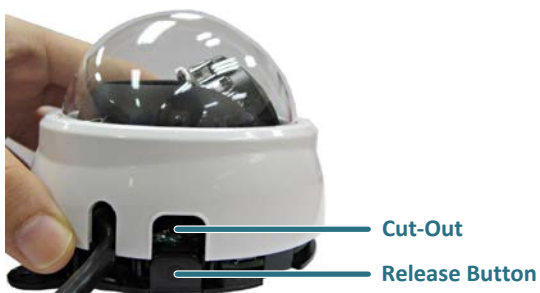

8. Screw the camera to the Mounting Plate using the supplied Fix Screw.

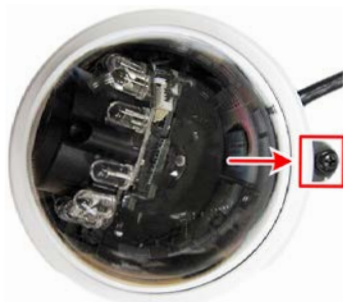

4.4 Wall-Mount Installation Using a Dome Bracket

You can optionally install the camera onto the wall using a Dome Bracket (BA-ED).



1. Remove the Top Cover and Bracket Plate from the Dome Bracket.

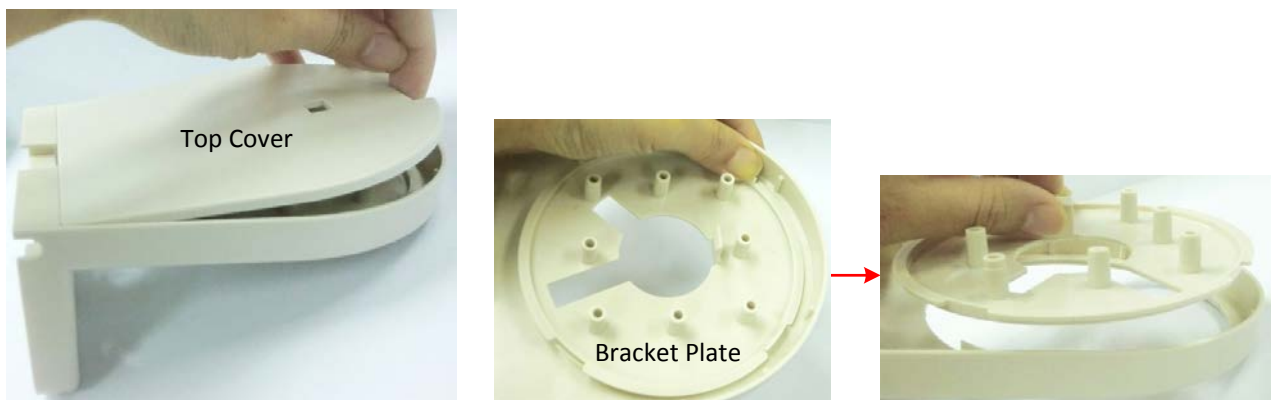

2. Drill two small holes on the wall and insert the supplied two Anchors into the holes. Drill another hole on the wall only if you wish to run the cables through the wall. Attach and screw the Dome Bracket to the wall using the supplied two Long Screws. Note that the distance between the ceiling and the Dome Bracket should be more than 10 cm.

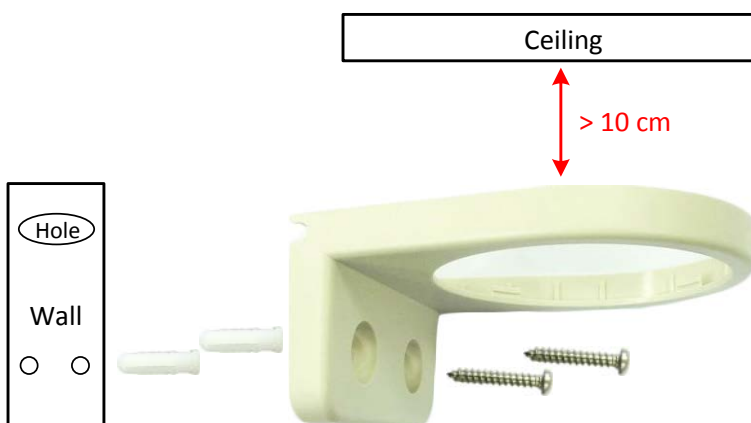

3. Screw the Base Plate onto the bottom of the camera.

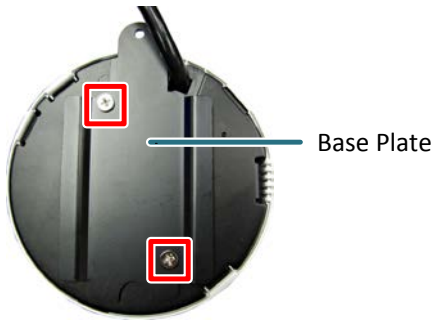

4. Run the cable through the hole of the Bracket Plate and then screw the Mounting Plate to the Bracket Plate using the supplied three Short Screws.

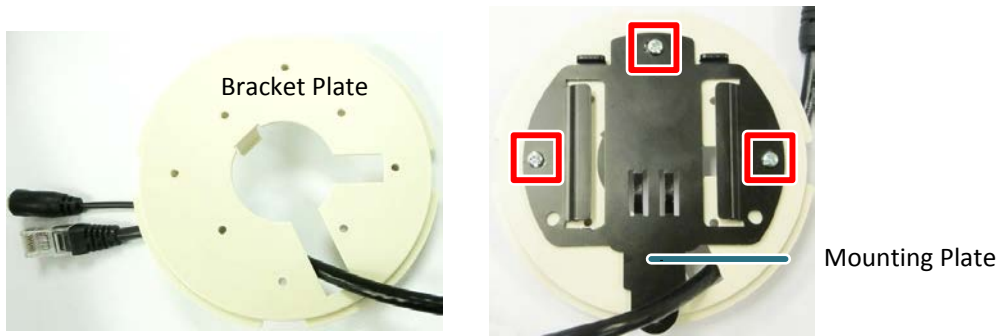

5. Slide the camera into the Mounting Plate and then screw the camera using the supplied Fix Screw.



6. Place the camera into the Dome Bracket.



7. Thread the cables from the side cut or through the hole on the wall.



8. Put the Top Cover back to the Dome Bracket.



5. Accessing the User Interface

This section explains how to access the Web interface of the camera for configuration.

5.1 Checking the Dynamic IP Address

You can look up the IP address and access the Web interface of the camera using the **IP Utility (IPU)** software included in the software CD. Please connect the IP camera in the same LAN of your computer.

1. Install and then start the IPU program , the following IPU window appears. The IPU will automatically search the IP devices connected in the LAN.

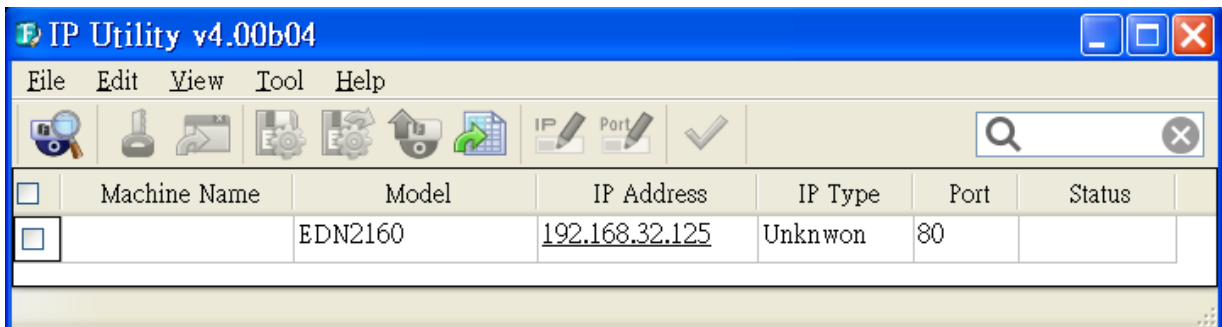

2. Double click the IP address of the desired device, the login window pops up. Type the user ID and password to log in. By default, the user ID is **user1** or **admin** and the password is **1111111**.



3. Click **OK**, the Live View window appears.

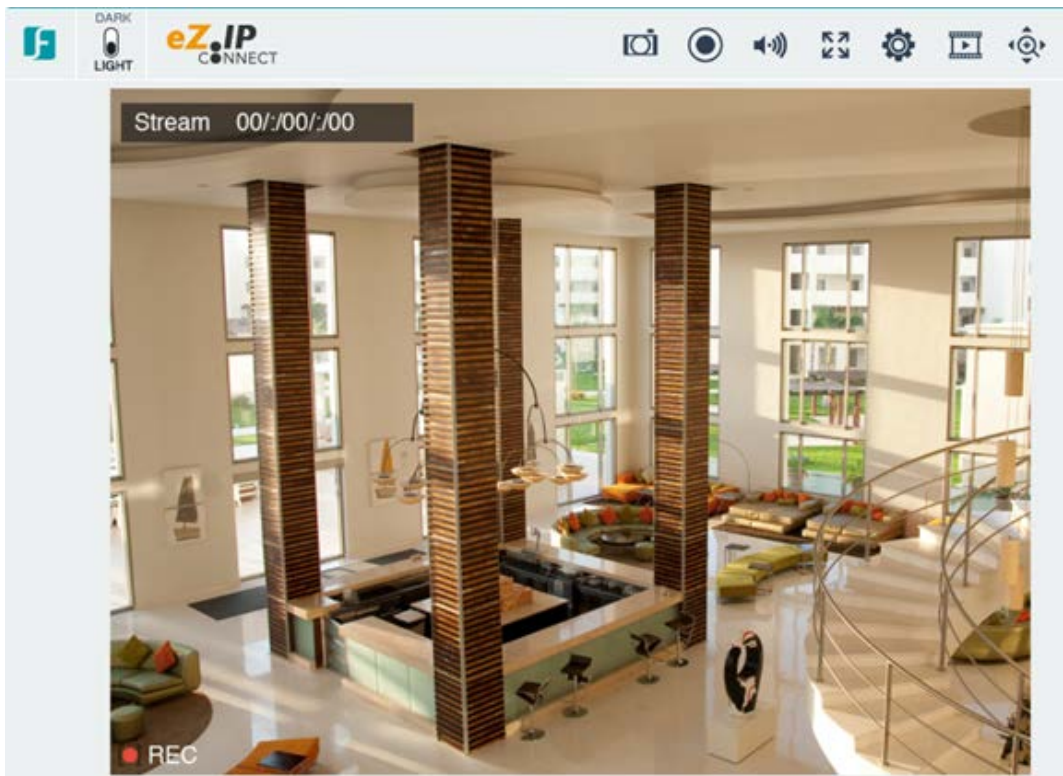

Note that for the first time user, you will be prompted to choose a desired video standard (lower-left image). Check the desired video standard, input a host name and then click the **Apply** button, a Thank You window appears (lower-right image). To access camera live view, click the **Launch eZ.IP Connect** button. To change video standard, see *7.2.1.1 Camera Setting*.

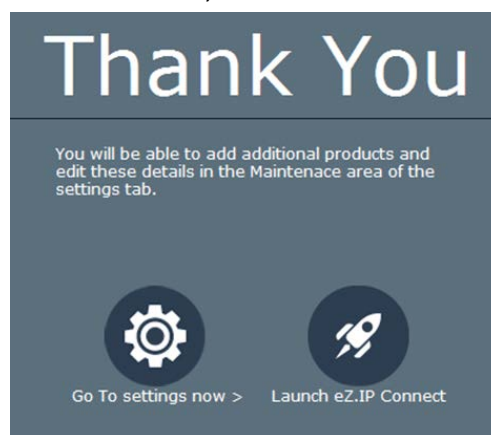
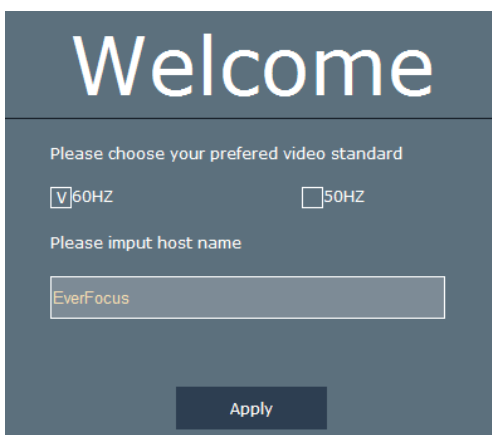

Note:

1. You might be required to download **ActiveX** for viewing the camera feed. If asked, click **Yes**.
2. To enable Remote Live View, Firmware Upgrade and ActiveX Prompt on Internet Explorer, some settings have to be complete. Please refer to *5.2 Settings for Microsoft Internet Explorer* in the *User's Manual*.

4. To optionally configure the Machine Name, IP Address, IP Type or Port Number using IPU:
 - a. Log in the camera by checking the desired model and then click the **Log in**  icon. The Log in dialog box appears.

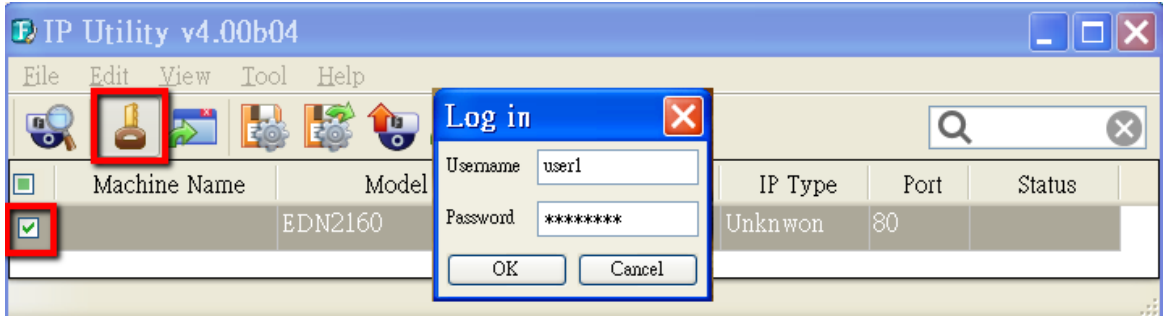

- b. Click the **OK** button directly, the status of the selected camera will displayed **Login**.

<input type="checkbox"/>	Machine Name	Model	IP Address	IP Type	Port	Status
<input checked="" type="checkbox"/>	Network Pan/Tilt Dor	EDN2160	192.168.32.125	DHCP	80	Login

Note:

9. The default user ID is **user1** or **admin** and the default password is **1111111**.
10. If you select more than one camera that has the same user ID / password, you will be able to log in several cameras at once.

- c. Right click the column to configure the settings. Click the **Apply Changes**  button to apply and save the settings.

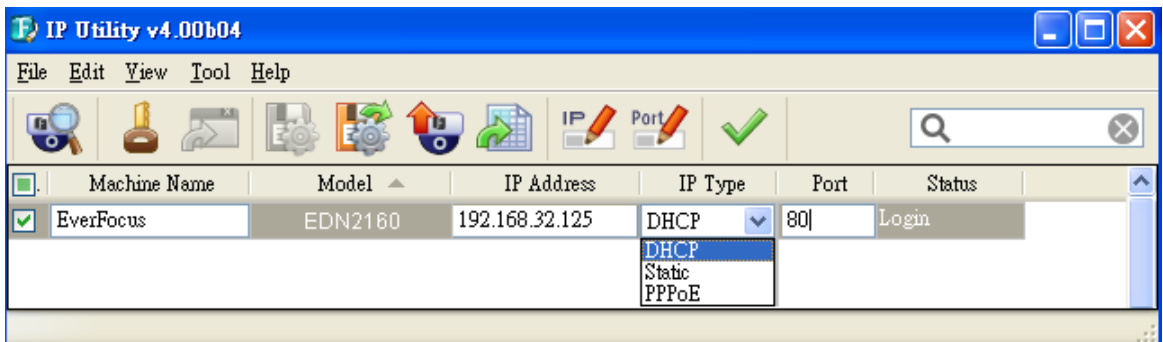

Note: Most networks uses DHCP to assign IP address, if you are unsure of your network settings, please consult your network administrators for configuration details.

5.2 Settings for Microsoft Internet Explorer

A. To enable Remove Live View, Firmware Upgrade and ActiveX Prompt on Internet Explorer, some settings have to be complete. Please follow the steps below:

1. On the computer, click Start > Control Panel > System and Security > Action Center (click Change User Account Control Settings), the **User Account Control Settings** window appears. Adjust the slide bar to **Never Notify** and then click **OK**. Restart your computer if requested.

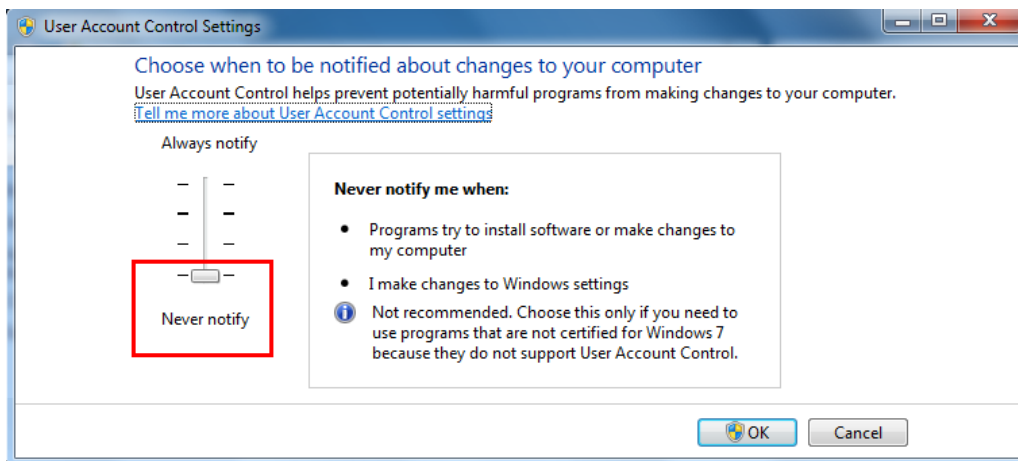

2. Open the Internet Explore, click Tools > Internet Options > Security Tab > Custom Level, the **Security Settings** windows appears.

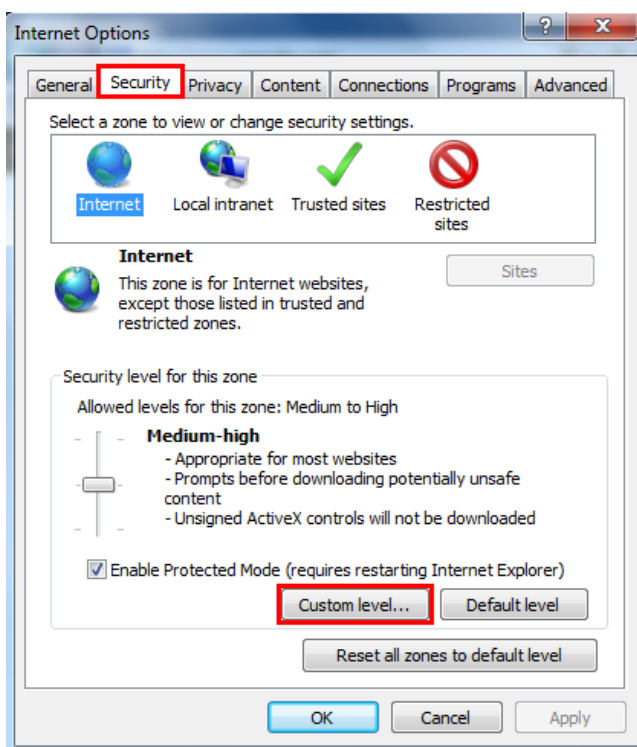

3. In the **Download unsigned ActiveX controls** field, select **Prompt**. In the **Include local directory path when uploading files to a server** field, select **Enable**. Click **OK**.

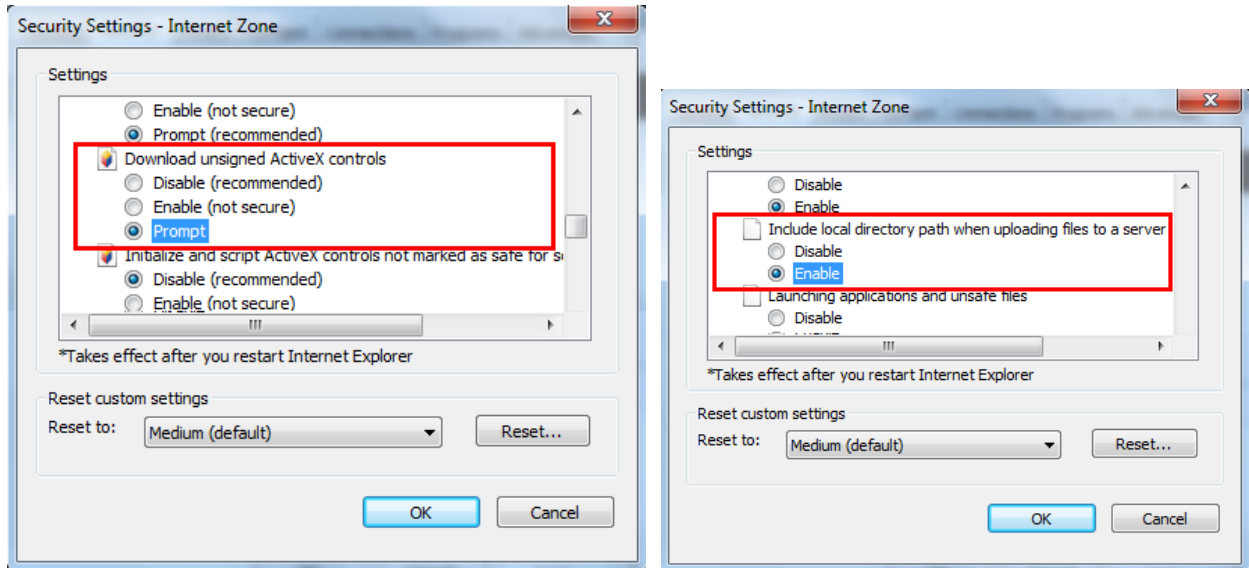

4. In the Internet Options window, click the **Advanced** tab and then disable **Enable memory protection to help mitigate online attacks**. Click **OK**.

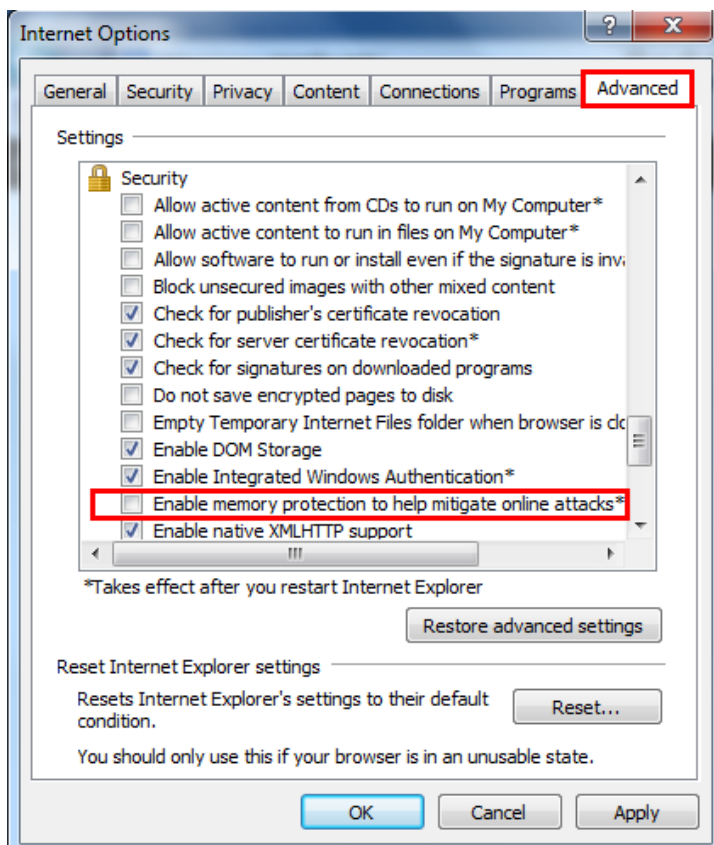

- B. On the Setting page, you can see the following Process Loading window every time when you click the **Apply** button. The spinning loading wheel indicates the loading process is running.

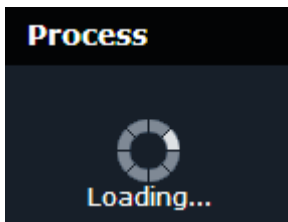

If you don't see the wheel spinning, click the **Advanced** tab in the Internet Options window and then enable **Play animations in webpages***. Click **OK**.

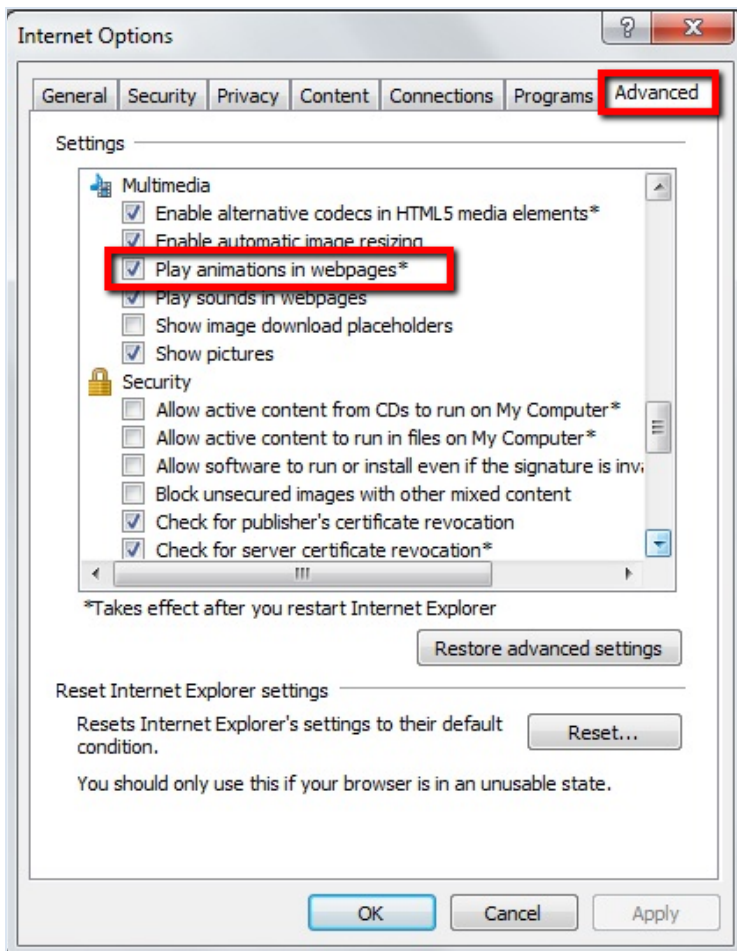

- C. For Windows 8 and above systems, to enable the local recording function by clicking the **Recording** button on the Live View window, please select “Run as administrator” on the browser. Right-click on the IE icon and select **Run as administrator**.

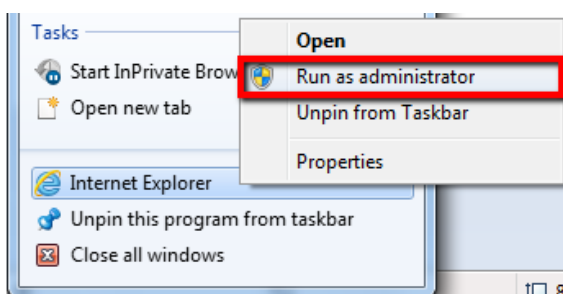

5.3 Connecting the Camera to the Network

There are three methods to connect the IP camera to the network: **Router or LAN Connection**, **Direct High-Speed Connection** and **One-to-One Connection**.

Router or LAN connection

This is the most common connection in which the IP camera is connected to a router and allows multiple users on and off site to see the IP camera on a LAN/WAN (Internet). The camera must be assigned an IP address that is compatible with its LAN. By setting up port forwarding on the router, you can remotely access the cameras from outside of the LAN via the Internet. To remotely access the Web interface of the IP camera, please refer to *7.1.2.3 DDNS Setting* in the User's Manual. To set up port forwarding, please consult the manual of the router.

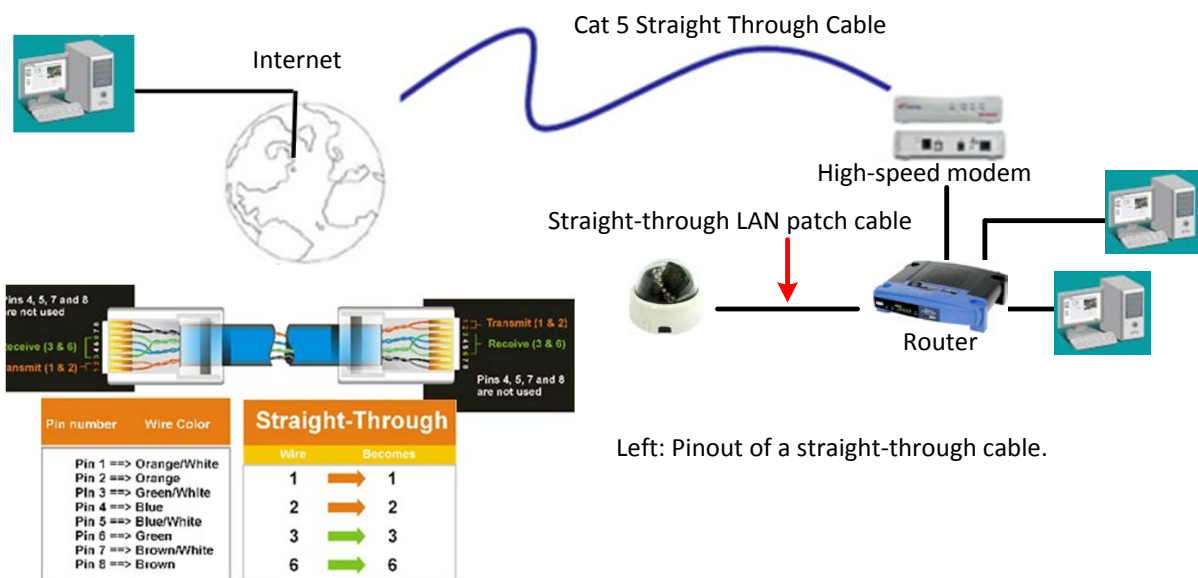

Direct High-Speed Connection

In a Direct High-Speed Connection, the camera connects directly to a modem without the need for a router. You need to set the static or dynamic WAN IP address assigned by your ISP (Internet Service Provider) in the camera’s configuration web pages. To access the camera, just type “http://xxx.xxx.xxx.xxx”, where xxx.xxx.xxx.xxx is the IP address given by your ISP. If you have a dynamic IP address, this connection may require that you use DDNS for a reliable connection. Please refer to 7.1.2.3 *DDNS Setting* in the *User’s Manual*.

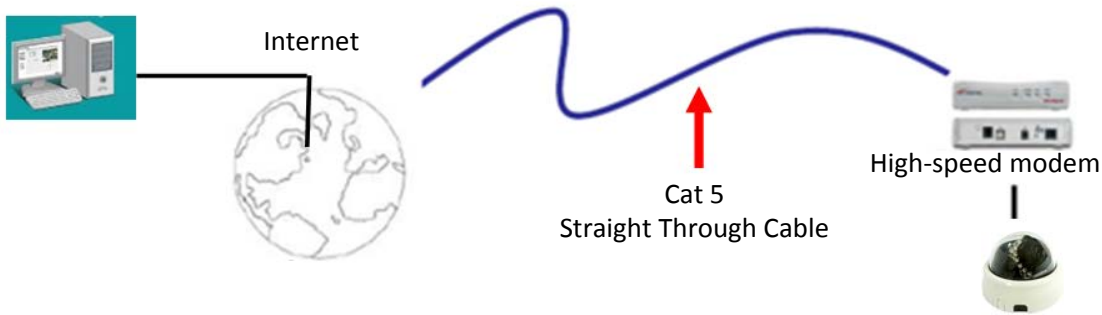

One-to-One Connection (Directly from PC to IP Camera)

You can connect directly without using a switch, router or modem. However, only the PC connected to the camera will be able to view the IP camera. You will also have to manually assign a compatible IP address to both the computer and the IP camera. Unless the PC has another network connection, the IP camera will be the only network device visible to the PC. See the diagram below:

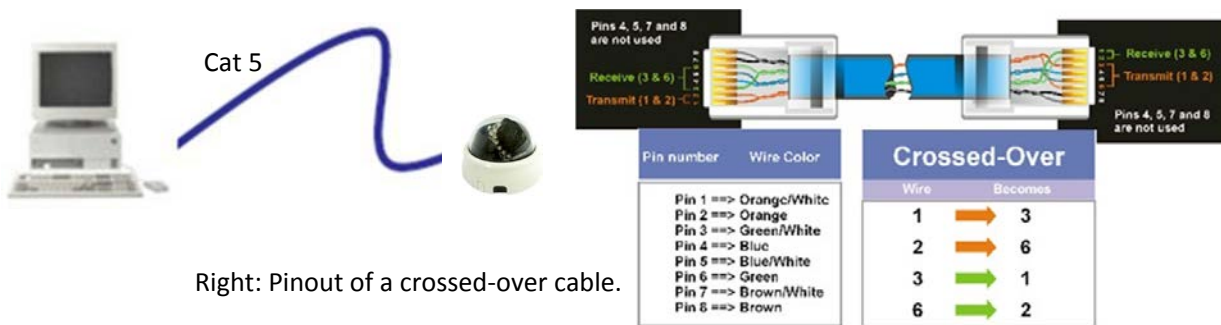

5.4 Live View Window





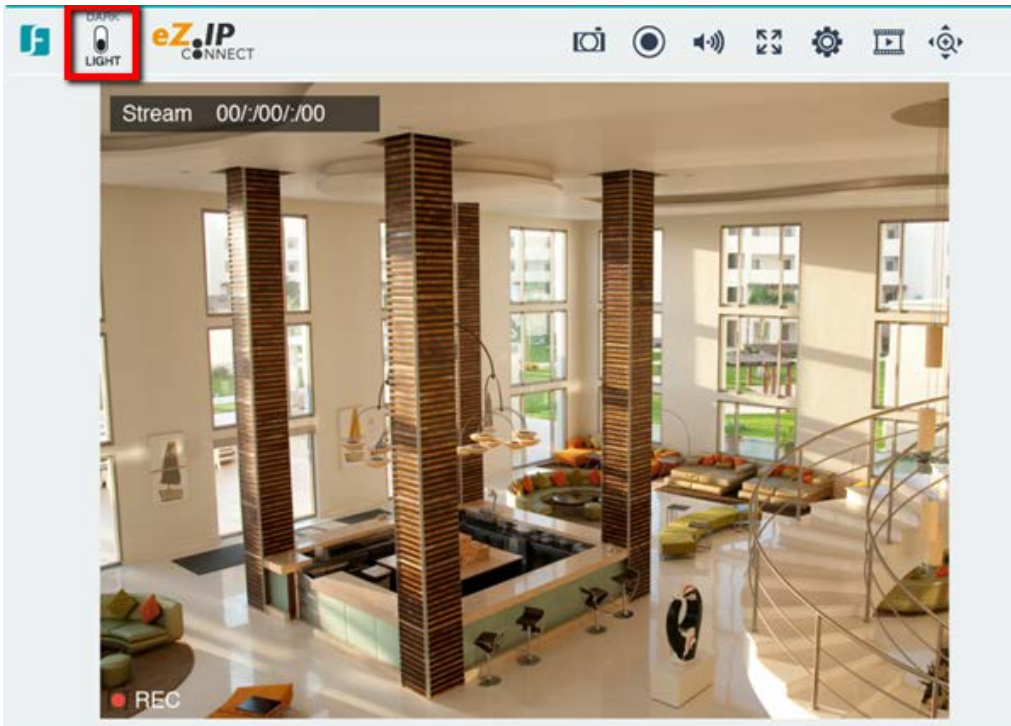

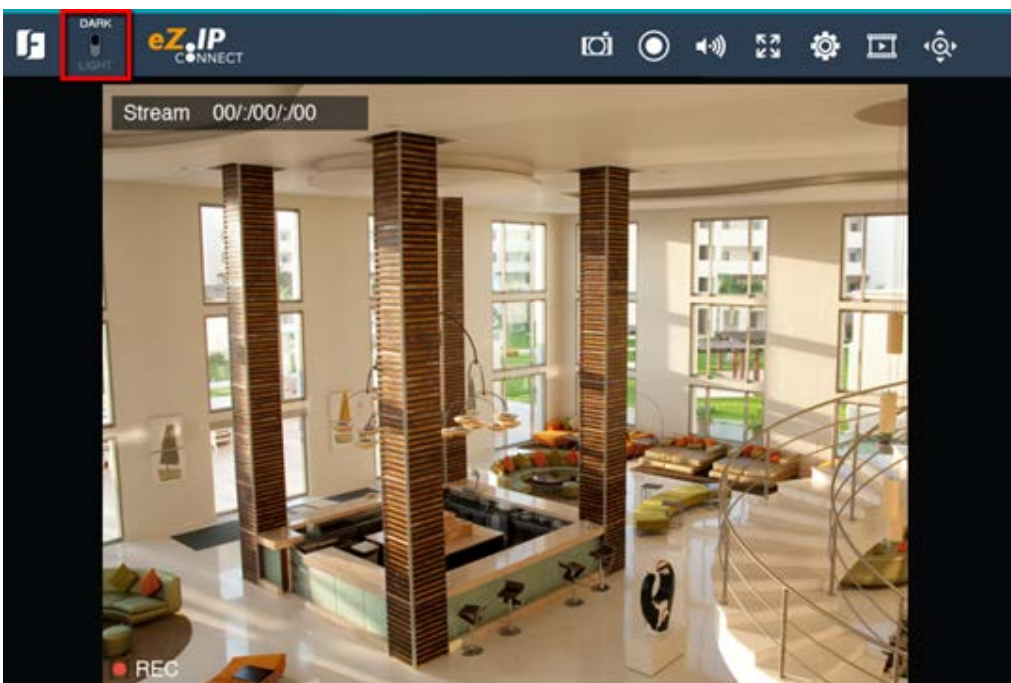

The Web User Interface is designed with two styles: **Dark** and **Light**. You can switch between the two styles by clicking the **UI Style Switch** button on the upper-left corner of the Live View window.

Light Style



Dark Style



Icon	Name: Descriptions
	<p>UI Style Switch: Click to switch the user interface style between Dark and Light.</p>
	<p>Snapshot: Click to take a snapshot. You can then save the image to the desired location of your computer.</p>
	<p>Recording: Click to start / stop live view recording to the computer. The recordings will be saved in MPEG4 format. You can use any players supporting MPEG4 format to play back the recordings. The default recording path is at C:\Record.</p> <p><u>Note:</u> For Windows 8 and above systems, you have to set up some settings on the IE to enable the recording function (see C. in 5.2 <i>Settings for Microsoft Internet Explorer</i>).</p>
	<p>Audio: Click to play the camera audio through the computer's speakers. You can slide the bar to adjust the volume. To turn on/off the audio function, click  on the slide bar.</p>
	<p>Full Screen: Click to display the live view in full screen. To return to the Live View window, press the Esc key on the keyboard.</p>
	<p>Setup: Click to enter to the camera settings page (see 7. <i>Settings</i>).</p>
	<p>Streaming: Click to switch between Main Stream and Sub Stream (see 5.6 <i>Switching Streams</i>). Note that to enable this function, you have to configure the camera stream settings in advance (see 7.2.2.1 <i>Video Codec Setting</i>).</p>
	<p>Digital Zoom: Click to display the Digital Zoom control panel for operating the Digital Zoom function (see 5.7 <i>Digital zoom Control Panel</i>).</p>

5.5 Switching Streams

The Streaming function allows users to switch between Main and Sub streams on the Live View. You can set up the Main stream and Sub stream to the Local or Remote connection type respectively. To enable the stream switching function on the Live View window, you have to configure the camera stream settings first (see 7.2.2.1 Video Codec Setting).

After configuring the camera stream settings, you can start using the Stream Switching function on the Live View window. Click the **Streaming** icon on the Live View window, the following switching buttons appears.

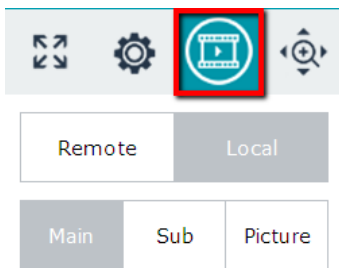

1. Select a connection type by clicking the **Remote** or **Local** button.
2. Select **Main** or **Sub** stream for the pre-setup Remote / Local type.
3. You can optionally click **Picture** to display the Live View in MJPEG codec.

5.6 Digital Zoom Window

Click the PTZ icon on the Live View window to operate the Digital Zoom function.

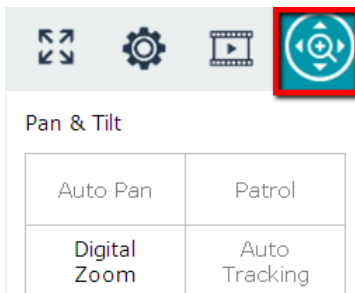

Digital Zoom

Click the **Digital Zoom** button and the Digital Zoom control window appears. Check **Enable digital zoom** to enable the Digital Zoom function. Slide the zoom factors bar to adjust the zoom size (Navigation Box size). You can then use your mouse to drag and move the Navigation Box around to have a close-up view within the area.

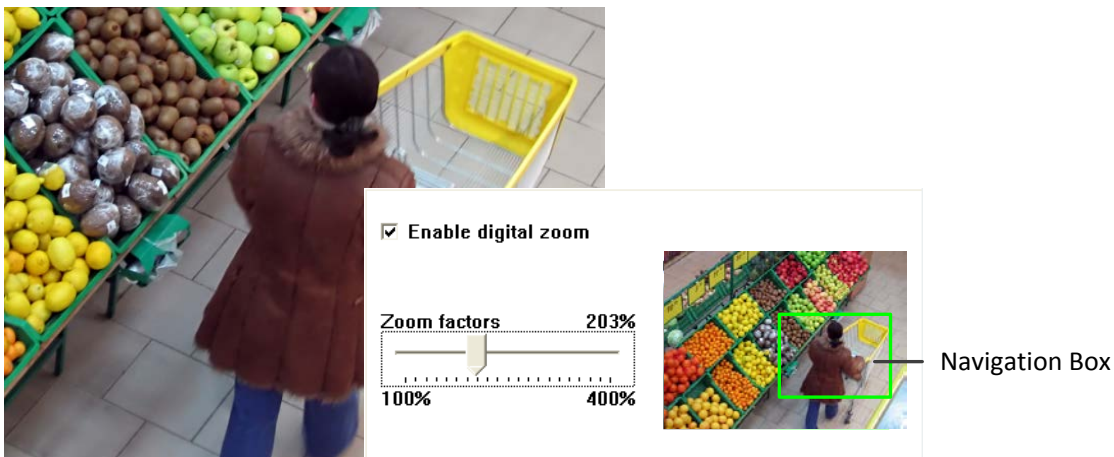

6. Playback

You can remotely play back the recordings stored in the on-camera micro SD card, NAS server, or locally play back the recordings stored in the computer.

6.1 Local Playback

You can archive the recordings from the Micro SD card on the camera to your computer, or record the camera live view along with audio to the computer, and then use any players supporting MOV (SD card recordings) or MPEG4 (Live View to PC recordings) format to play back the recordings.

To archive the recordings from the camera built-in micro SD card, please refer to [7.4.2 SD Card](#). Note that only the original Administrator: “**admin**” or “**user1**” is allowed to use this function. The recordings will be saved in MOV format. You can use any players supporting MOV format to play back the recordings.

To start recording the Live View to the computer, click the Recording button  on the Live View window. The recordings will be saved in MPEG4 format. You can use any players supporting MPEG4 format to play back the recordings. The default recording path is at **C:\Record**. To change the recording path, please refer to [7.3.3 Client Setting Record](#).

Note: For Windows 8 and above systems, you have to set up some settings on the IE to enable the recording function  (see [C](#) in [5.2 Settings for Microsoft Internet Explorer](#)).

6.2 Remote Playback

You can remotely play back the recordings stored in the NAS server or the micro SD card.

NAS Server:

To access to the NAS server and then play back the recordings stored in the NAS server, you have to enable the “Store at NAS” function and configure the NAS server settings first (see [7.3.2 The Record Type](#)).

Micro SD Card:

To use the function, you have to insert a micro SD card into the camera’s micro SD card slot. The card may also have to be formatted (see [7.4.2 SD Card](#)). Note that only the **original Administrator** (user1/admin) is allowed to play back the recordings stored in the SD card.

Note: It’s recommended to power off the camera when you remove/insert a micro SD card into the micro SD card slot.

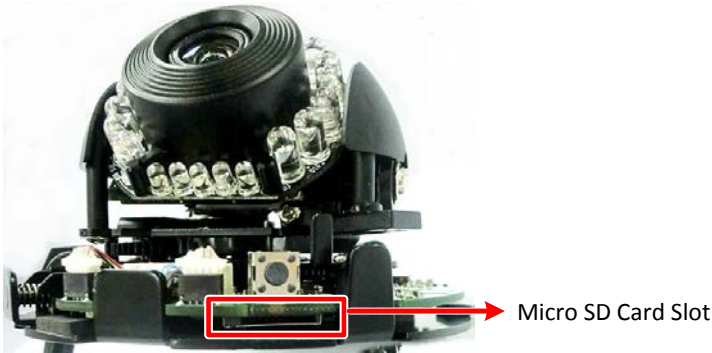

To start the remote playback function:

1. Enable the “Store at SD card” function and configure the recording settings (see 7.3.2 *The Record Type*).
2. Set up the NAS server settings to create a NAS server folder for the SD card recordings (see 7.4.2 *SD Card*).
3. Access to the SD card NAS server folder.
 - a. Enter the IP address of the IP camera or the NAS host name (refer to 7.4.1 *NAS Server Setting*) in the Address Bar of a folder, such as \\192.168.10.10 or \\storage.

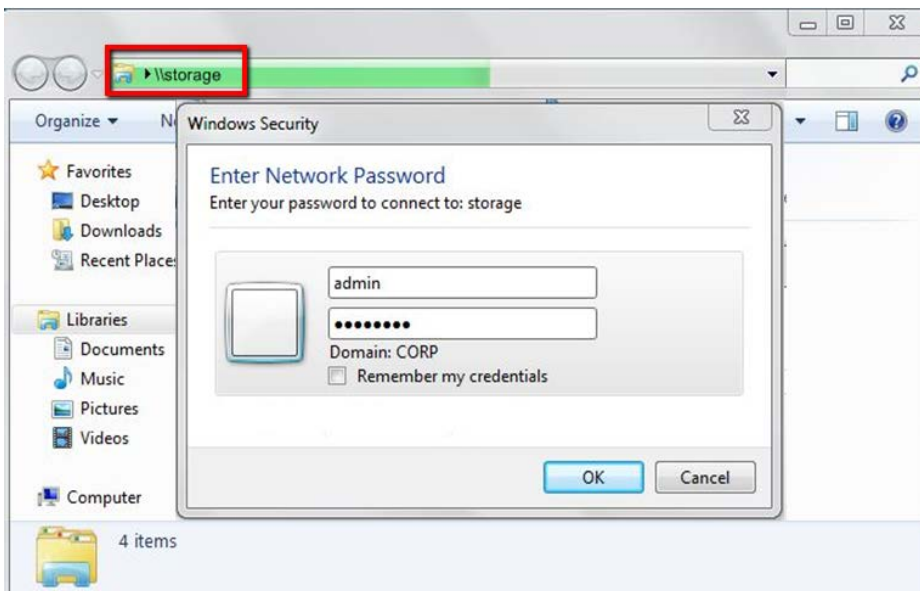

- b. Enter the user account and the password to access to the folder as below (only the original Administrator: “**admin**” or “**user1**” is accessible).

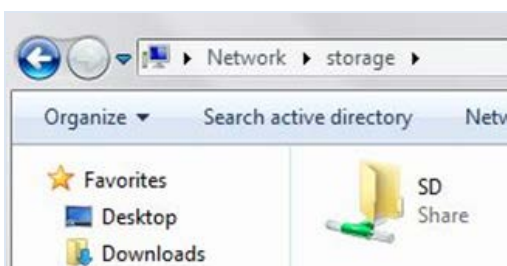

4. Use any players supporting MOV format to play back the recordings in the SD folder.

7. Settings

Click the **Setting** button  on the Live View window to enter the camera settings page. To go back to the Live View window, click the **Home** button .

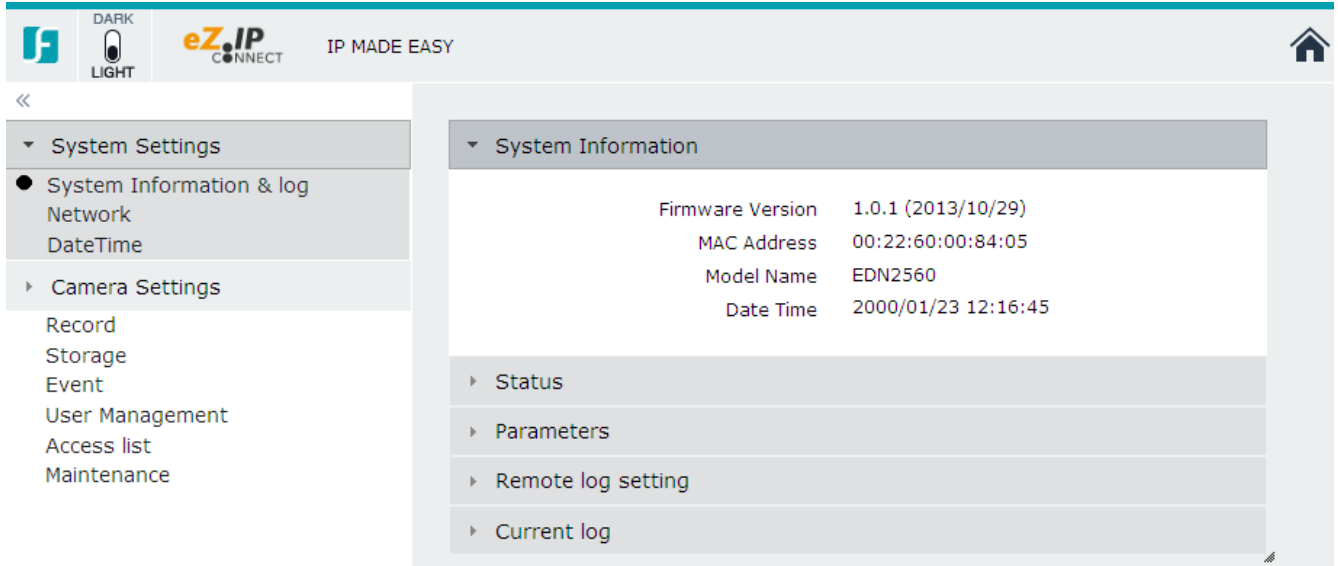

7.1 System Settings

7.1.1 System Information & Log

7.1.1.1 System Information

You can see the system information displayed on this page.

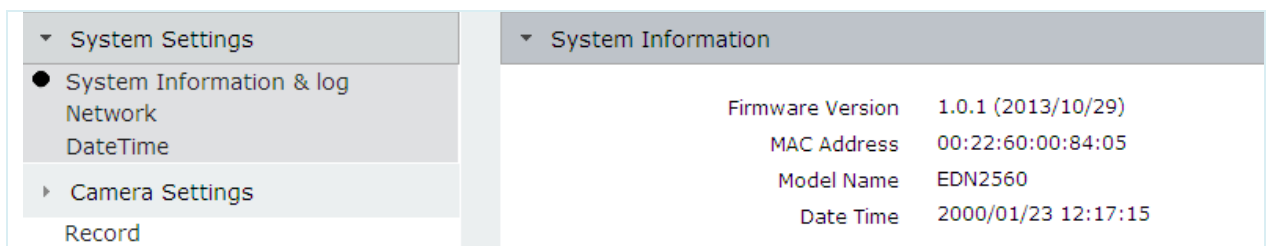

7.1.1.2 Status

You can see the network information displayed on this page.

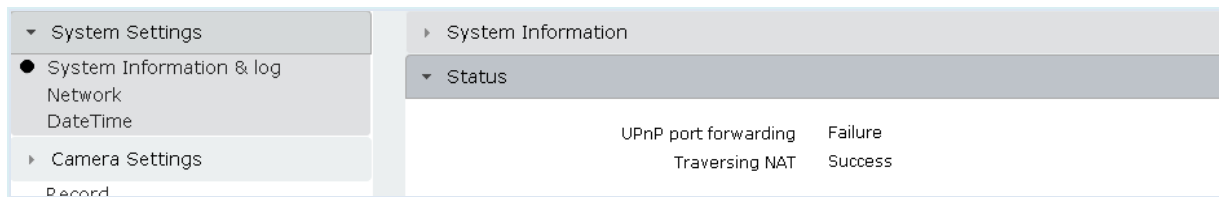

7.1.1.3 Parameters

The parameters information can be displayed on this page.

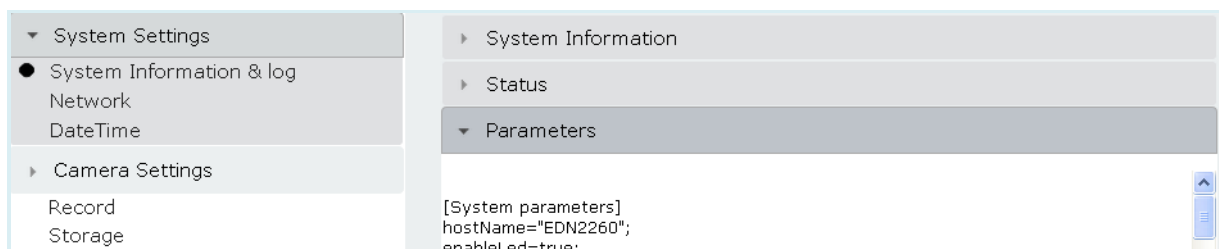

7.1.1.4 Remote Log Setting

You can enable/disable uploading log data to the remote server (RFC 3164-compliant). To upload log data to the FTP, select **Enable** in the Remote log field, type the IP address and port number of the remote server and then click the **Apply** button.

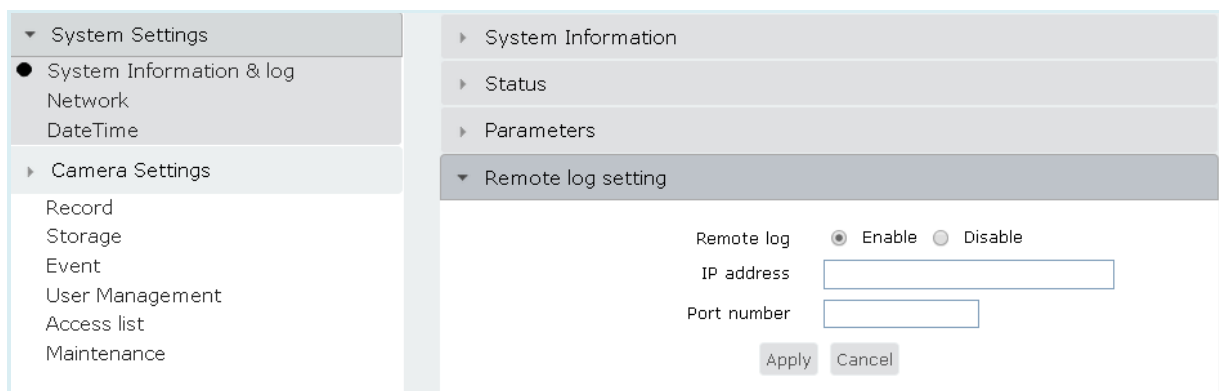

7.1.1.5 Current Log

The current log data is displayed on this page. You can click the **Export to HTML** button to save the log data to the desired storage location.

The screenshot displays a web interface for system settings. On the left is a navigation menu with categories: System Settings, System Information & log (selected), Network, DateTime, Camera Settings, Record, Storage, Event, User Management, Access list, and Maintenance. The main content area is titled 'System Information' and includes sub-sections: Status, Parameters, Remote log setting, and 'Current log' (expanded). The 'Current log' section shows a scrollable list of system messages from January 19, 2023, at 02:03:40. The logs include messages from syslogd, inetd, crond, and mDNSResponder. At the bottom of the log area is a button labeled 'Export to HTML'.

```

Jan 19 02:03:40 EDN2260 syslogd 1.5.0: restart.
Jan 19 02:03:42 EDN2260 inetd[1211]: can't open /usr/local/var/run/inetd.pid: No such file or directory
Jan 19 02:03:42 EDN2260 inetd[1211]: /etc/inetd.conf:39: bad wait type
Jan 19 02:03:42 EDN2260 crond[1223]: crond (busybox 1.10.4) started, log level 8
Jan 19 02:03:45 EDN2260 crond[1453]: crond (busybox 1.10.4) started, log level 8
Jan 19 02:03:50 EDN2260 syslog: [VENC_Capture] Start VENC_Capture process with Pid : 1637
Jan 19 02:03:50 EDN2260 syslog: Auto change IP Address to 192.168.0.99 .
Jan 19 02:03:50 EDN2260 udhcpc: deconfig
Jan 19 02:03:51 EDN2260 mDNSResponder: mDNSPlatformSendUDP got error 22 (Invalid argument) sending packet to 224.0.0.251 on interface 192.168.0.98/eth0/2
Jan 19 02:03:51 EDN2260 mDNSResponder: mDNSPlatformSendUDP got error 22 (Invalid argument) sending packet to 224.0.0.251 on interface 192.168.0.98/eth0/2
Jan 19 02:03:51 EDN2260 udhcpc: IP 192.168.32.140 netmask 255.255.255.0
Jan 19 02:03:51 EDN2260 udhcpc: router 192.168.32.254
Jan 19 02:03:52 EDN2260 udhcpc: dns 192.168.10.188 192.168.10.189
Jan 19 02:03:52 EDN2260 mDNSResponder: mDNSPlatformSendUDP got error 22 (Invalid argument) sending packet to 224.0.0.251 on interface 192.168.0.98/eth0/2
Jan 19 02:03:52 EDN2260 sysloa: UPNP Get external IP Address is 192.168.32.120
    
```

Export to HTML

7.1.2 Network

7.1.2.1 Protocol Setting

You can transmit the data stream from the IP cameras using the UDP, TCP or HTTP protocol through the remote/local network.

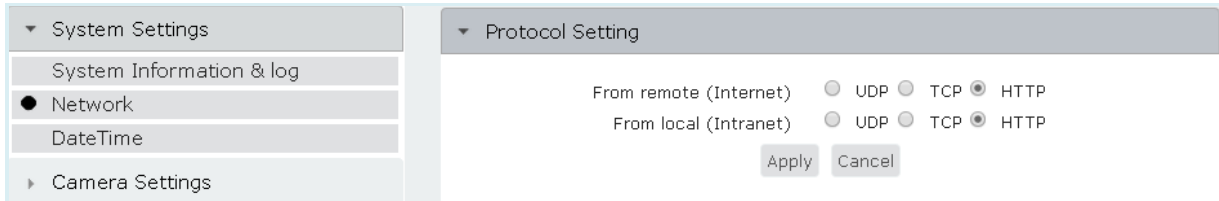

Select a protocol for the remote network and local network respectively. Click **Apply** to apply the changes or **Cancel** to cancel the changes and return to the previous settings.

- **UDP:** The UDP protocol allows for more real-time audio and video streams. However, some packets may be lost due to network burst traffic and images may be obscured.
- **TCP:** The TCP protocol guarantees the complete delivery of streaming data and thus provides better video quality. However, the real-time effect is not as good as that of the UDP protocol.
- **HTTP:** The HTTP protocol allows for less packet loss and produces a more accurate video display. The downside with this protocol is that the real-time effect is worse than that with the UDP protocol. By default, the camera is set up with HTTP for both remote and local network.

7.1.2.2 Network Setting

You can configure the networking setting on this page. By default, the camera uses DHCP to assign IP address. Click **Apply** to apply the changes or **Cancel** to cancel the changes and return to the previous settings.

【Network Setting】

Network Type:

- **DHCP:** This setting lets the camera use an automatically assigned (dynamic) IP address. This address can change under certain circumstances. For instance, when the camera’s network switch/hub has to be rebooted. Do not assign to the DHCP server the same IP addresses used for the other network cameras and PCs with unique IP addresses.
- **Static IP:** The user can manually set the Static IP address. This type of address is stable and cannot change, but the user has to make sure there are no address conflicts with other network-connected devices.

IP address: Type the IP address.

Subnet mask: Set up the subnet mask for your network, so that the IP camera will be recognized within the network. Example: 255.255.255.0.

Default router: Type the router IP.

Primary DNS server: Type the IP address of the DNS server provided by the ISP.

Secondary DNS server: Type the IP address of the secondary DNS server provided by the ISP.

- **PPPoE:** This is a DSL-connection application. The ISP will ask the user to input an account name and password. Contact your ISP for these details.

Network Type DHCP Static IP PPPoE

Account

Password

Confirm password

Note: If PPPoE is selected as the IP type, the supplied IP Utility program will not be able to detect the camera.

【UPnP Setup】

Select **Enable** for both UPnP Setup and UPnP port forwarding to enable the UPnP function.

Promoted by the UPnP Forum (Universal Plug and Play), the UPnP is a networking architecture providing compatibility among networked devices listed in the networked device table. Enable the UPnP function means you can directly connect the cameras listed in the networked device table by clicking on them.

UPnP Setup

UPnP Setup Enable Disable

UPnP port forwarding Enable Disable

Note:

1. For the UPnP function to work, an UPnP-enabled router is required.
2. The UPnP function may fail owing to the compatibility between the camera and the router.

【Port Parameters】

By default, the camera is set up with the following port numbers. In order to support the full functionality of the camera, you must open the port numbers (84, 443, 554) on the router for remote access to the IP camera. This function is available on most routers in the market and is often known as “Port Forwarding”. To set up Port Forwarding, please consult the manual of the router.

Note: In certain router models, it is possible that you will not be able to access the camera using DDNS while inside the router’s network. Please try using a PC located outside of your router’s network.

Port Parameters	
HTTP port	<input type="text" value="80"/>
HTTPS port	<input type="text" value="443"/>
RTSP port	<input type="text" value="554"/>
Video RTP port	<input type="text" value="54"/>
Video RTCP port	55
Audio RTP port	56
Audio RTCP port	57

【RTSP Stream Access Names】

You can transmit the audio/video stream from the IP camera using the RTSP (Real Time Streaming Protocol) on the network. Type the URL as “rtsp://61.30.125.43/liveN.sdp” for stream 1 and stream 2. The maximum length of the name is 19 digits.

RTSP stream access names	
Access name for stream1 with audio/video	<input type="text" value="live1"/> .sdp
Access name for stream2 with audio/video	<input type="text" value="live2"/> .sdp
<input type="button" value="Apply"/> <input type="button" value="Cancel"/>	

7.1.2.3 DDNS Setting

DDNS (Dynamic Domain Name System) is a service used to map a domain name to the dynamic IP address of a network device. You can set up the DDNS service for remote access to the IP camera. DDNS assigns a domain name (URL) to the IP camera, so that the user does not need to go through the trouble of checking if the IP address assigned by DHCP Server has changed. Once the IP is changed, the IP camera will automatically update the information to the DDNS to ensure it is always available for remote access.

Before enabling the following DDNS function, users should have applied for a host name from the DDS service provider’s website. We support two DDNS server providers, which you can see on the drop-down list of **Please select DDNS server**.

Note: We highly recommend that you use xxx.everfocusddns.com for the simplicity of setting up your IP cameras.

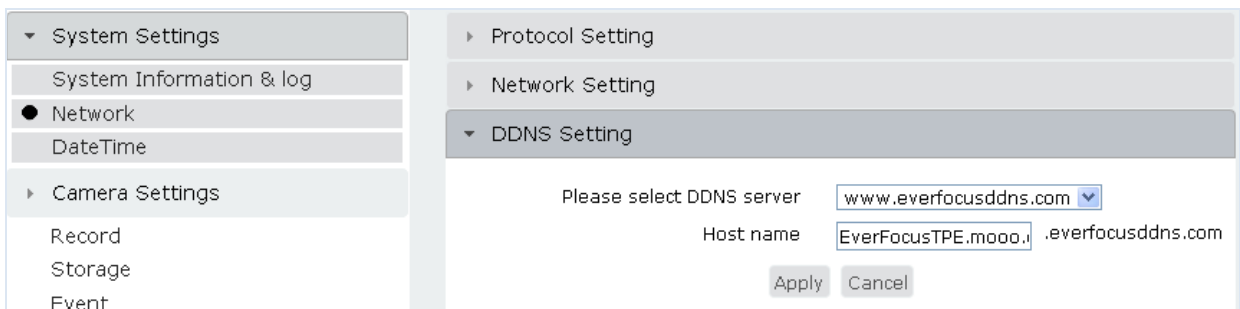

To use EverFocus DDNS server:

1. Apply a **free** host name from EverFocus DDNS server: Enter the Web page of EverFocus DDNS server (www.everfocusddns.com). Type a desired host name in the textbox.

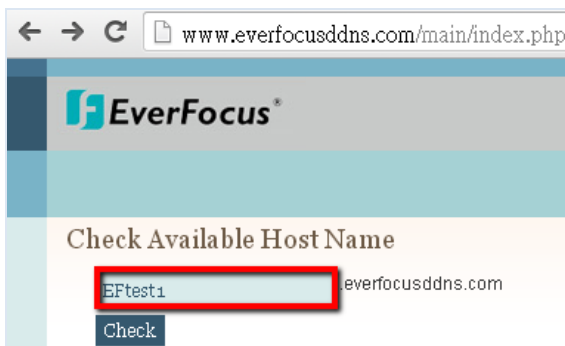

2. Click the **Check** button for the server to check whether the host name is available. If a message “xxx is available” shows, it means this host name is available and is registered for your use.

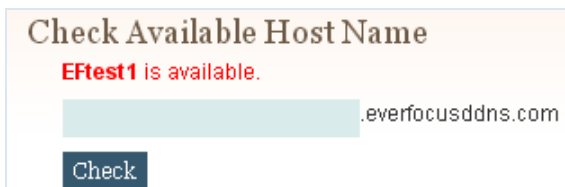

3. Set up the DDNS setting in the DDNS Setting field: Type the host name in the textbox and click the **Apply** button.

4. Open a browser, type the domain name “(host name).everfocusddns.com” in the address field and click the **Enter** button. The Live View window of the camera should be displayed.



You can also obtain a free host name if you select ip-discovery.com:

1. Type a desired host name and your e-mail address.
2. Click the **Apply** button to obtain the free host name.
3. Click the **Register** button. If the host name has been successfully created, a success message will be displayed in the DDNS registration result column and also sent to the setup e-mail address.

Note

The following port numbers is set up automatically at your router. Connect to the camera from Internet use the router's public IP address with the ports.

The following port numbers is needed to set up at your router's mapping table by yourself. Change the port values if needed. Make sure the values must be the same as that set up at your router's mapping table.

HTTP port	8080
HTTPS port	4434
RTSP port	3554
Video RTP port	54
Video RTCP port	55
Audio RTP port	56
Audio RTCP port	57

Register

DDNS registration result

You should receive the e-mail sent by ip-discovery.com and click on the link in the mail. By click on the link, let cameras with registering the same e-mail address to be a group when you log in ip-discovery.com.
The following is the DDNS service information:
 Host name <http://EFtest1.ip-discovery.com:80>
 User account for <http://ip-discovery.com>: EFtest1
 User password for <http://ip-discovery.com>: 11111111
 E-mail Eftaipei@everfocus.com.tw

4. Open a browser, type the domain name in the address field and click the **Enter** button. The Live View window of the camera should be displayed.

7.1.3 DateTime

7.1.3.1 Time Zone

You can select a time zone for the camera. Click **Apply** to apply the changes or **Cancel** to cancel the changes and return to the previous settings.

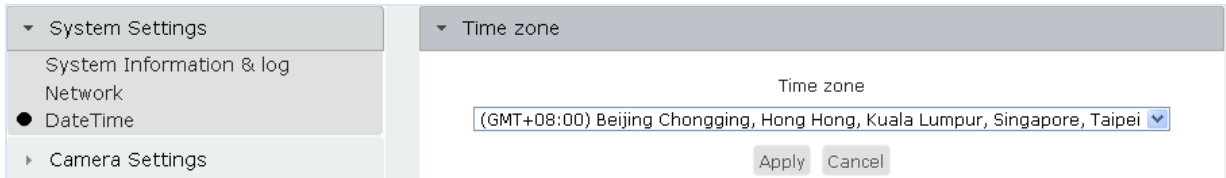

7.1.3.2 Daylight Saving

Select **One hour ahead** to turn the clock forward by one hour. Select **One hour behind** to turn the clock back an hour. Click **Apply** to apply the changes or **Cancel** to cancel the changes and return to the previous settings.

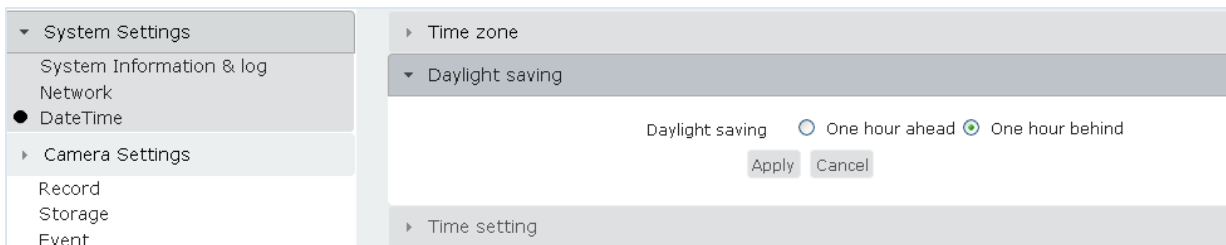

7.1.3.3 Time Setting

Set up the time for the camera. Click **Apply** to apply the changes or **Cancel** to cancel the changes and return to the previous settings.

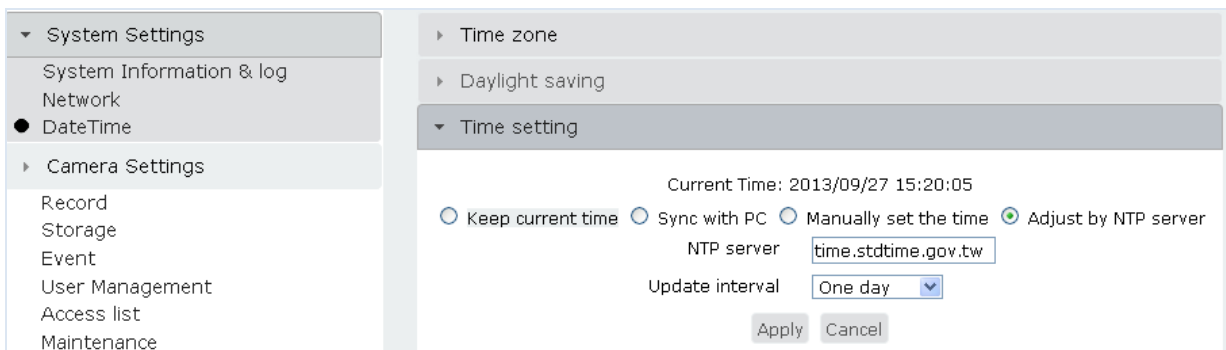

- **Keep current time:** Select to keep the camera default time.
- **Sync with PC:** Select to adjust the camera time by synchronizing with the computer.
- **Manually set the time:** Select to manually set up the camera time.
- **Adjust by NTP Server:** Type the Network Time Protocol server, if applicable. The camera time will be automatically adjusted by synchronizing with the NTP server.

7.2 Camera Settings

7.2.1 Camera

7.2.1.1 Camera Setting

You can configure the following camera settings. Click **Apply** to apply the changes or **Cancel** to cancel the changes and return to the previous settings.

- **Color mode:** Select **Color** to apply the camera video with color images or **Black and white** with black and white images.
- **Video orientation:** Check **Flip** to vertically rotate the video or **Mirror** to horizontally rotate the video.
- **Environment:** Select **Indoor** if the camera is placed in the indoor environment or **Outdoor** if the camera is placed in the outdoor environment.
- **Frequency:** Select **50hz** if you camera is using the PAL scanning system or **60hz** for the NTSC scanning system.

7.2.1.2 Video Setting

You can configure the following video settings.

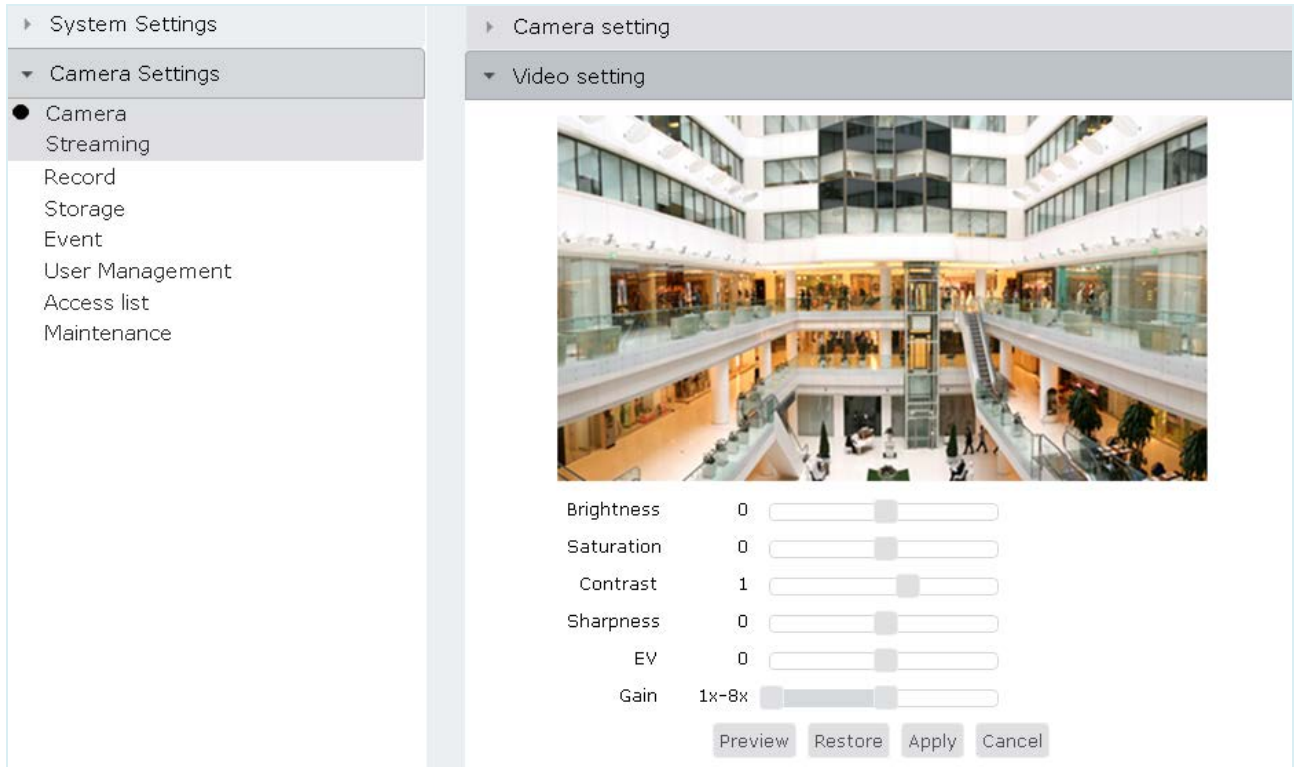

- **Brightness:** Adjust the image brightness level ranging between -5 and +5. The default value is set to 0.
- **Saturation:** Adjust the image saturation level ranging between -5 and +5. The default value is set to 0.
- **Contrast:** Adjust the image contrast level ranging between -5 and +5. The default value is set to 0.
- **Sharpness:** Adjust the image sharpness level ranging between -5 and +5. The default value is set to 0.
- **EV:** The Exposure value represents the expected target value of the luminance of the weighting result of AE windows in the image and its tolerance as offset.
- **Gain:** Adjust the sliders to control the max. and min. gain value respectively. Normally, the min. value is set to 1x for better image quality.

Click **Preview** to preview the video settings. Click **Restore** to restore to the default video settings. Click **Apply** to apply the changes or **Cancel** to cancel the changes and return to the previous settings.

7.2.1.3 WDR Setting

The WDR (Wide Dynamic Range) function provides clearer images when both of the very bright and dark areas simultaneously appear on the camera view. Select Enable to enable the WDR function. Slide the bar to adjust the WDR level. Click **Apply** to apply the changes or **Cancel** to cancel the changes and return to the previous settings.

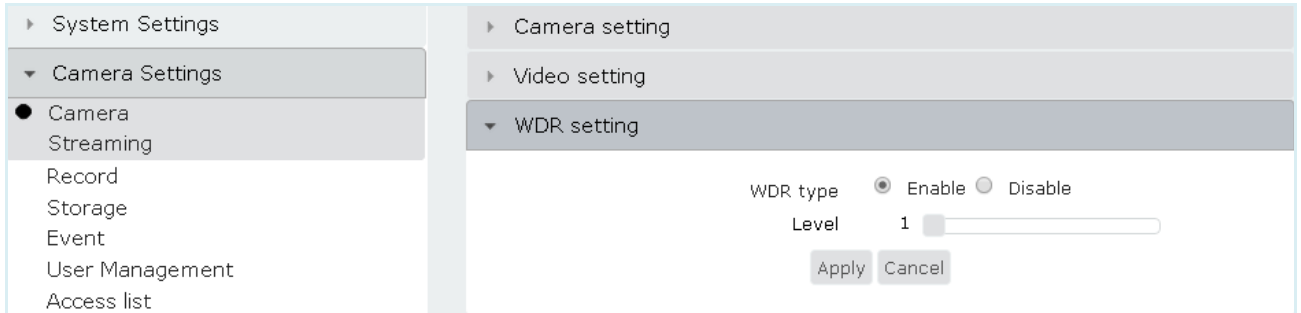

7.2.1.4 Infrared LED Setting

You can turn on/off the built-in IR LEDs. This function is very useful when the camera is installed under low illumination environment.

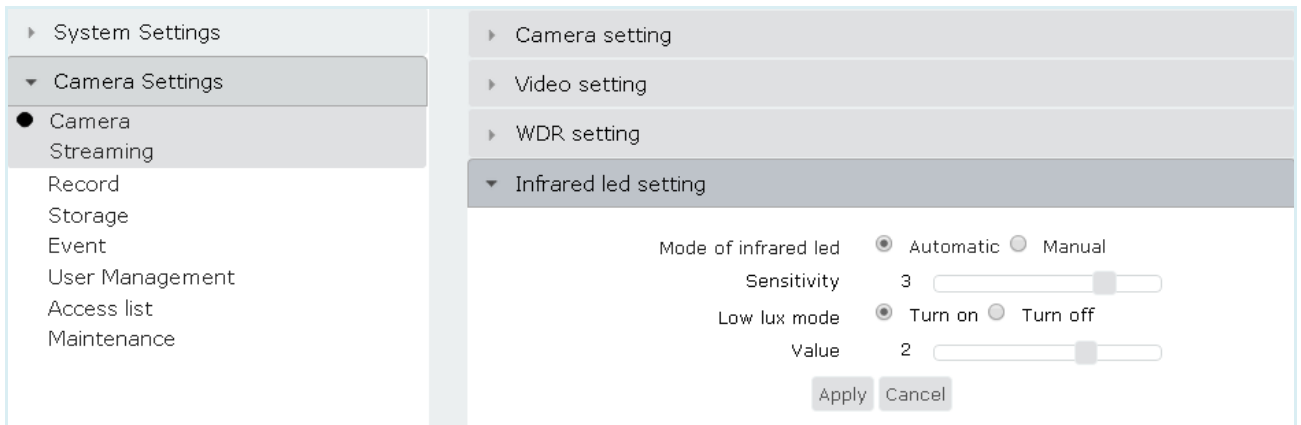

- **Mode of infrared led:** Select **Automatic** and adjust the sensitivity between 0 and 4, the IR LED will be automatically turn on based on the detected light level. Select **Manual** to manually turn on/ off the IR LED.
- **Low lux mode:** This function will improve the video quality when the environment is under low lux. Select **Turn on/Turn off** to enable/disable the function. Use the slider to adjust the value.

7.2.1.5 Microphone Setting

You can turn on/off the built-in microphone on this page. Select **Mute** to turn off the microphone. Select **Sound** to turn on the microphone and then slide the volume bar to adjust the microphone volume. Note that if you select Mute, the camera audio will not be played through the computer's speakers once you enable the Audio button  on the Live View window.

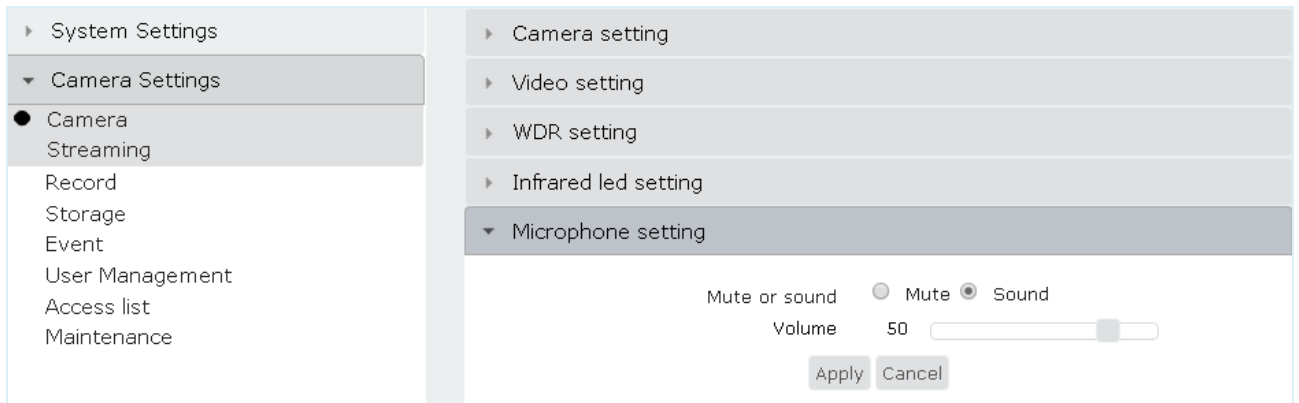

7.2.2 Streaming

7.2.2.1 Video Codec Setting

You can set up the Main stream (Stream 1) and Sub stream (Stream 2) to the Local or Remote connection type respectively and then further set up the video settings including codec and resolution to both streams. After configuring the camera stream settings, you can start using the Stream Switching function on the Live View window (see 5.6 Switching Streams). Click **Apply** to apply the changes or **Cancel** to cancel the changes and return to the previous settings.

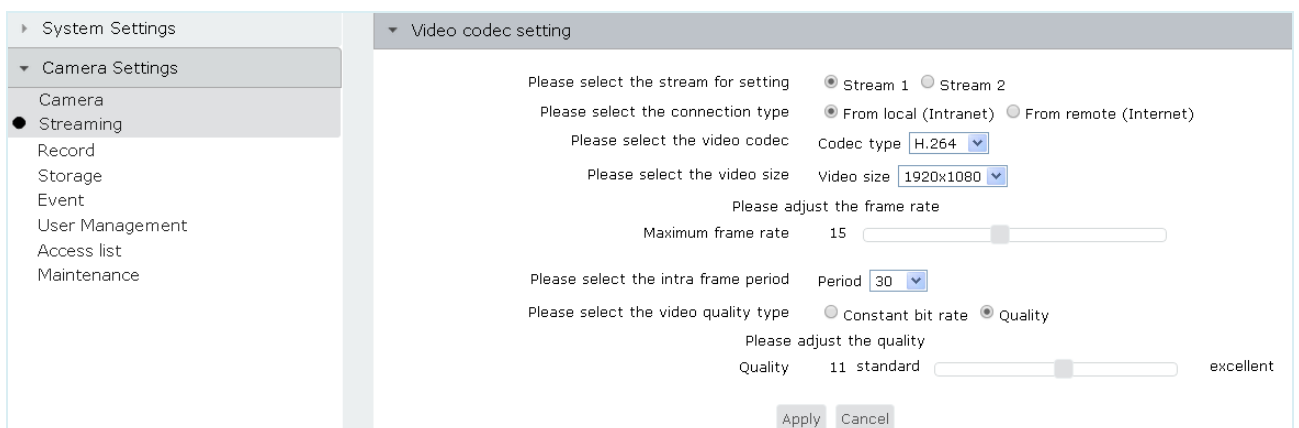

■ **Please select the stream for setting / Please select the connection type:**

You can set up the Main stream (Stream 1) and Sub stream (Stream 2) to the Local or Remote connection type respectively. And then further set up the video settings in the below fields. Click the **Apply** button after configuring the settings for each combination. The combinations include:

- Stream 1 + From local Stream 2 + From local
- Stream 1 + From remote Stream 2 + From remote

- **Please select the video codec:** Select a video codec for the selected stream. The options include H.264, MJPEG and MPEG4.
- **Please select the video size:** Select a video resolution for the selected stream. Note that for EDN2560, if 2560x1920 is selected for either stream 1 or stream 2, the other stream can only be set up with resolution lower than 2560x1920 with 15 fps for each resolution.
- **Maximum frame rate:** Select a max. frame rate for the selected stream. This limits the maximal refresh frame rate per second. The higher the frame rate, the smoother the video quality.
- **Please select the intra frame period:** Select a period (number of frames) for the camera to plant an “I-frame”. The shorter the period, the better the video quality, however, the higher network bandwidth consumption.
- **Please select the video quality type:** Select whether you want the stream to stream a:
 - Constant bit rate: Select the constant bit rate and then adjust the video quality from 20Kbps to 12Mbps.
 - Quality bit rate: Select Quality bit rate and then adjust the quality from 1 to 20.

7.2.2.2 Snapshot and Time Display Setting

You can select a resolution for the snapshot image. You can also enable the time and date overlay function to mark the time and date information on the video recordings and snapshot images. Click **Apply** to apply the changes or **Cancel** to cancel the changes and return to the previous settings. Note that checking the “add time and date on the picture/stream” will also display the Camera Name on the live view, video recordings and snapshot. To change Camera Name, please refer to *7.8.1 General Setting*.

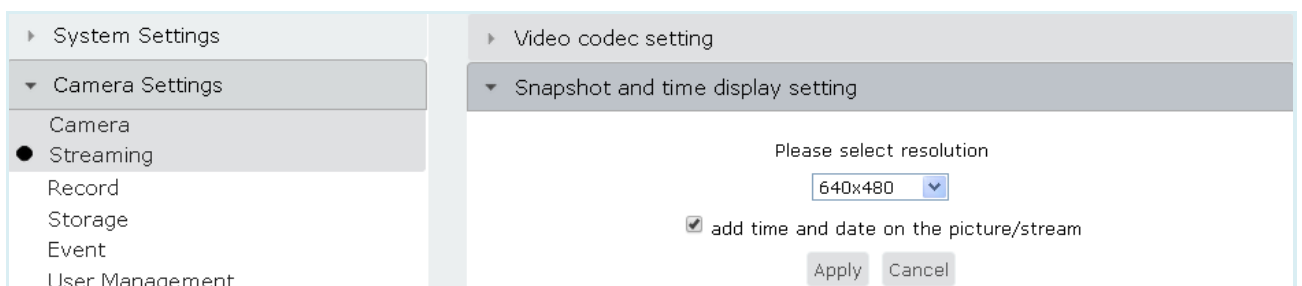

7.3 Record

7.3.1 The Record Storage is

This page displays the schedule record storage information such as storage location, and its total / used / available space. If you select **Store at NAS** in the **The Response Mode** setting option (see 7.3.2 *The Response Type*), this page will shows the NAS storage information as below.

<ul style="list-style-type: none"> ▶ System Settings ▼ Camera Settings <ul style="list-style-type: none"> Camera Streaming ● Record Storage 	<div style="background-color: #f0f0f0; padding: 5px;">▼ The record storage is</div> <table style="width: 100%; border-collapse: collapse;"> <tr> <td colspan="3" style="text-align: center;">Store at NAS</td> </tr> <tr> <td style="width: 60%;">Total space:</td> <td style="width: 20%;"></td> <td style="width: 20%; text-align: right;">0 B</td> </tr> <tr> <td>Used space:</td> <td></td> <td style="text-align: right;">0 B</td> </tr> <tr> <td>Free space:</td> <td></td> <td style="text-align: right;">0 B</td> </tr> </table>	Store at NAS			Total space:		0 B	Used space:		0 B	Free space:		0 B
Store at NAS													
Total space:		0 B											
Used space:		0 B											
Free space:		0 B											

If you select **Store at SD card** in the **The Response Mode** setting option (see 7.3.2 *The Response Type*), this page will shows the SD Card storage information as below.

<ul style="list-style-type: none"> ▼ System Settings <ul style="list-style-type: none"> System Information & log Network DateTime ▶ Camera Settings ● Record 	<div style="background-color: #f0f0f0; padding: 5px;">▼ The record storage is</div> <table style="width: 100%; border-collapse: collapse;"> <tr> <td colspan="3" style="text-align: center;">Store at SD card</td> </tr> <tr> <td style="width: 60%;">Total space:</td> <td style="width: 20%;"></td> <td style="width: 20%; text-align: right;">29.708 GB</td> </tr> <tr> <td>Used space:</td> <td></td> <td style="text-align: right;">53.266 MB</td> </tr> <tr> <td>Free space:</td> <td></td> <td style="text-align: right;">29.656 GB</td> </tr> </table>	Store at SD card			Total space:		29.708 GB	Used space:		53.266 MB	Free space:		29.656 GB
Store at SD card													
Total space:		29.708 GB											
Used space:		53.266 MB											
Free space:		29.656 GB											

7.3.2 The Record Type

You can set up the recording settings on this page.

Select **Enable** to display the following settings. Select **Disable** will hide the settings.

Note: If the schedule record is enabled, the **Event** function (see 7.5 Event) will be automatically disabled. You can only use either schedule record or the event record.

【The Schedule Mode】 You can set up the record schedule. Please select a desired recording schedule mode (**Every day / Week day / Schedule date**) for setting a record start / end time and date.

Every day: Enter a desired start / end time for everyday recording.

Week day: Enter a desired start / end time and select desired week days for recording.

Schedule date: Select a desired start / end day and enter a desired start / end time for recording.

【Record Parameters】 You can configure the recording source video stream, recording interval and file name.

Source: Select the desired video stream. The video stream can be configured in 7.2.2 Streaming.

The Recording Interval: The user can limit the size of each recording file here (in minutes). When a single recording file exceeds the time you set, the system will create a new file to save that data to.

Record Prefix File Name: Enter a name for the recording files. The maximum length is 20 digits.

- **Enable cyclic recording:** Check the box for overwriting recording file when the storage capacity is full.

【The Response Mode】 You can select to store the recordings either at NAS or at SD card.

Store at NAS:

The response mode

The response mode Store at NAS Store at SD card

NAS server address

Workgroup

NAS shared directory

User account

User password

Apply Cancel

- **NAS Server Address:** Enter the NAS server IP address.
- **Workgroup:** Enter the workgroup name of the NAS server.
- **NAS Shared Directory:** Enter the NAS shared directory path.
- **User Account:** Enter the user name of the NAS account.
- **User Password:** Enter the user password of the NAS account.

Click **Apply** to apply the changes or **Cancel** to cancel the changes and return to the previous settings.

Store at SD Card:

The response mode

The response mode Store at NAS Store at SD card

Apply Cancel

Select this option, you are able to use the SD card NAS server function, but only the Administrator account: “user1” or “admin” is able to use the SD card NAS server function, please refer to 7.4 Storage.

Note: Once you select the **Store at SD card** setting option, the SD card will not be able to be formatted, and the **Format** button will be grayed out in the 7.4.2 SD Card setting page. Therefore, please format the SD card before enabling this function.

Click **Apply** to apply the changes or **Cancel** to cancel the changes and return to the previous settings.

7.3.3 Client Setting Record

You can configure the recording path for the Live View recordings. The Live View recordings will be stored at the configured path of your computer.

Folder: Click **Browse** to select a directory for the recording files. The default recording directory is C:\Record.

File Name Prefix: Enter the name for the recording files.

- **Add date and time suffix to file name:** Check the box if you want to add the date and time information to the file name.

Note: Please check **Add date and time suffix to file name** box if you don't want to overwrite the recording files.

Click **Apply** to apply the changes or **Cancel** to cancel the changes and return to the previous settings.

7.4 Storage

Only the original Administrator “**user1**” or “**admin**” can access to and configure the Storage setting page. SD card inserted in the camera can be used as a NAS server.

Note: You need to check the **Save at SD card** box in The Response Mode in 7.3.2 *The Record Type* to be able to use this function.

7.4.1 NAS Server Setting

System Settings

- System Information & log
- Network
- DateTime

Camera Settings

- Record
- Storage**
- Event
- User Management
- Access list
- Maintenance

NAS server setting

Please select the NAS device

SD Card NAS server

Please input the NAS parameters

NAS host name

Workgroup

Apply Cancel

SD card

Total space: 31150592 KB
Used space: 95424 KB
Free space: 31055168 KB

Format

【NAS Server Setting】

SD Card NAS server: Check the box to enable the NAS server function of the SD card.

NAS host name: Enter a SD card NAS host name. Please enter only English letters; numbers and other language characters are not supported. The maximum length is 15 digits.

Workgroup: Enter a workgroup name of the SD card NAS server. The maximum length is 15 digits.

Click **Apply** to apply the changes or **Cancel** to cancel the changes and return to the previous settings.

7.4.2 SD Card

This page displays the storage status of the inserted SD card and the recording files at the SD card NAS server for downloading.

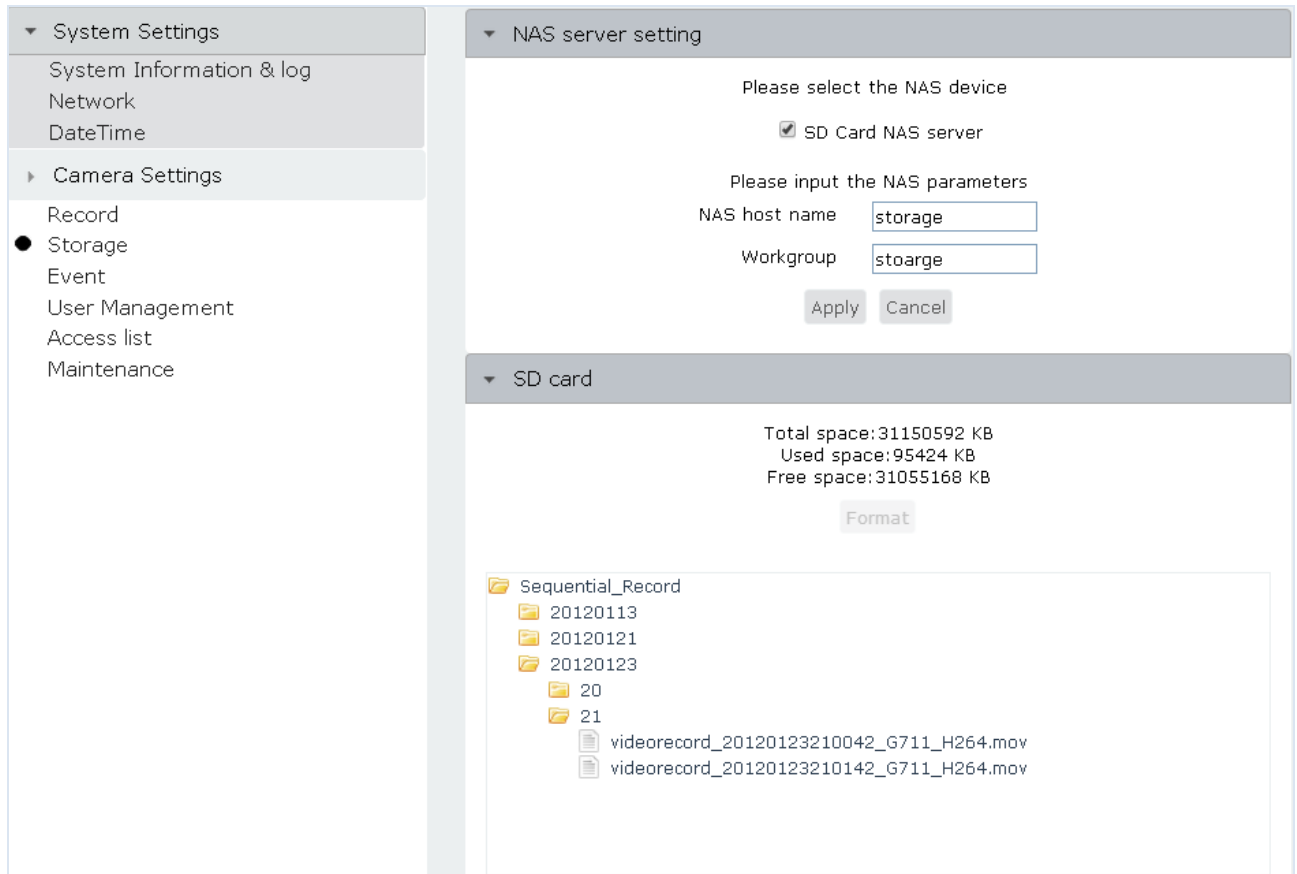

Total space: Displays the total storage capacity of the SD card.

Used space: Displays the used storage capacity of the SD card.

Free space: Displays the available storage capacity of the SD card.

Format: Click to format the SD card.

Note: Once you select the **Store at SD card** in The Response Mode setting option (refer to 7.3.2 *The Record Type*), the SD card will not be able to be formatted, and the **Format** button will be grayed out. Please select and apply **Store at NAS** (go to Record > The Record Type > The Response Mode) first, and then the format function can be used.

If you enable the **SD card NAS server** function, the recording files at the SD card will be displayed on the lower column of this page. Left-click the folder to display files, and left-click the file to archive the files.

To access to the SD card NAS server folder for editing files,

1. Enter the IP address of the IP camera or the NAS host name (refer to 7.4.1 NAS Server Setting) in the Address Bar of a folder, such as \\192.168.10.10 or \\storage.

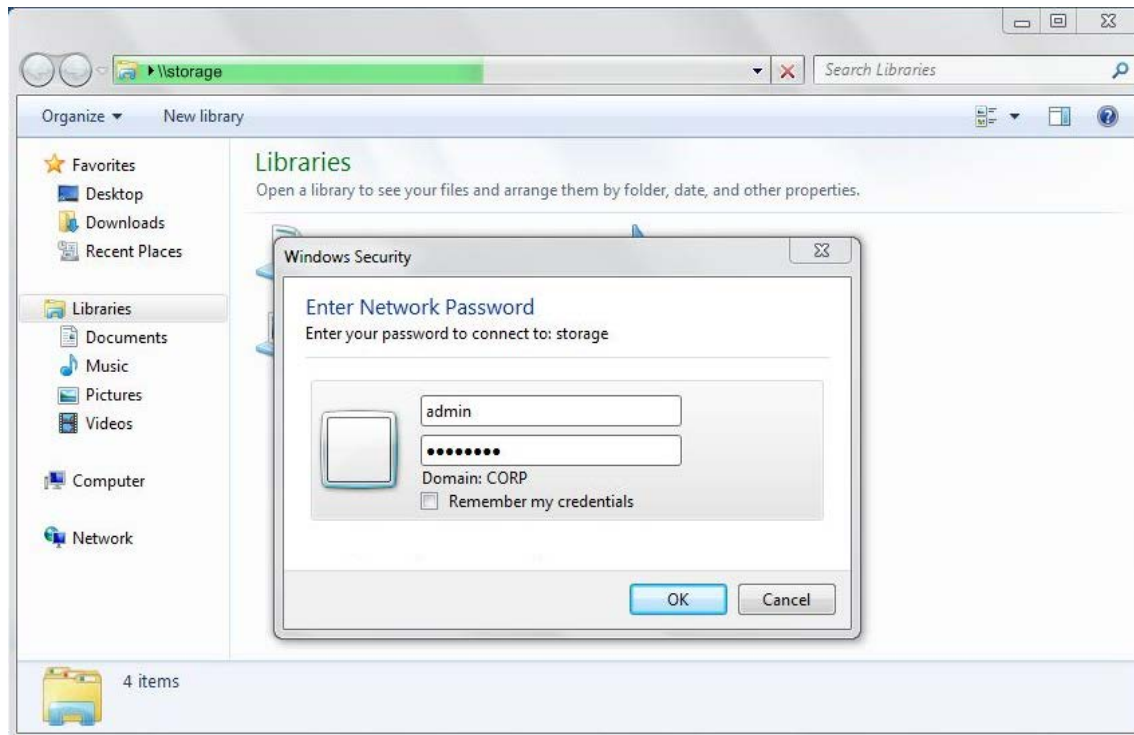

2. Enter the user account and the password to access to the folder as below (only for the original Administrator: **“admin”** or **“user1”** to use this function).

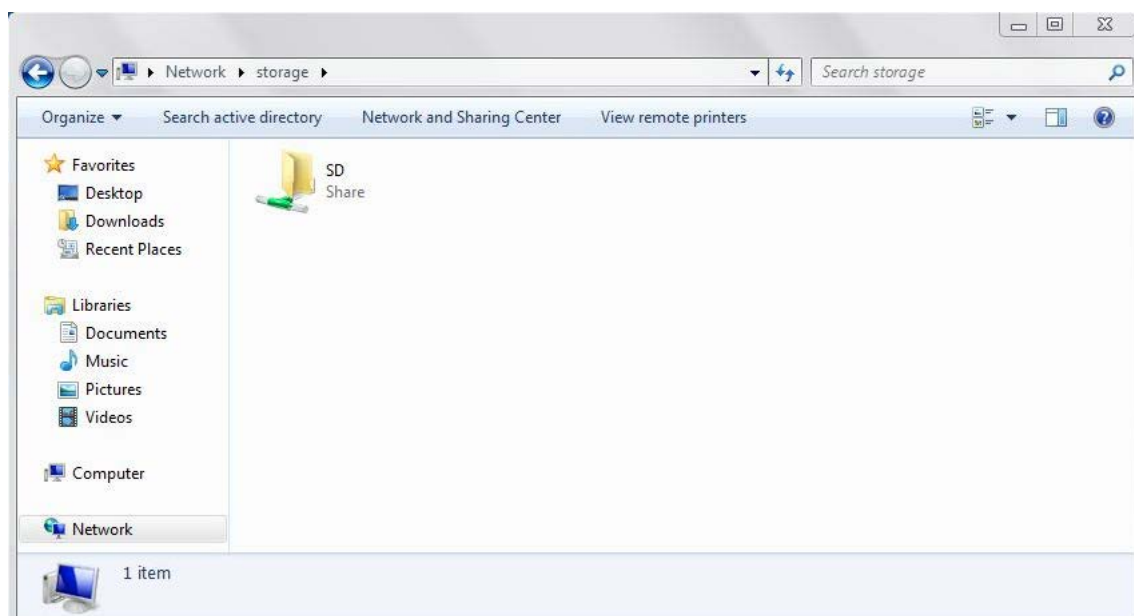

7.5 Event

You can set up the video motion detection event or periodical event to automatically notify the users when an event occurs. You can also set up a schedule to automatically record the videos when an event occurs.

Note: You need to disable the schedule record (please refer to 7.3.2 The Record Type) to be able to use this function.

7.5.1 Application Setting

Click **Enable** to display all the following settings for configuration.

- ▶ System Settings
- ▼ Camera Settings
 - Camera
 - Streaming
 - Record
 - Storage
 - Event
 - User Management
 - Access list
 - Maintenance

▼ Application setting

Application type Enable Disable

Schedule mode

Every day Week day Selected date

Start time

End time

Trigger mode

Video motion detection Periodically

Motion parameters



Windows Name

Object Size 5

Sensitivity 90

New Delete Save

Motion parameters

Detect next event after second(s) (value must > 3)

Media mode

System log Snapshot Record Message

Response mode

- Send a E-mail
- Upload to FTP server
- Store at NAS
- Upload to HTTP server
- Store at SD card

Apply Cancel

7.5.2 Schedule Mode

This schedule mode is only for event recording such as motion event or periodical recordings.

Schedule mode

Every day
 Week day
 Selected date

Start time

End time

Week Day

SUN
 MON
 TUE
 WED
 THU
 FRI
 SAT

Select a schedule mode (**Every day** / **Week day** / **Schedule date**) for event recording and set up a record start / end time and date.

Every day: Enter a desired start / end time for everyday recording.

Week day: Enter a desired start / end time and select desired week days for recording.

Schedule date: Select a desired start / end day and enter a desired start / end time for recording.

7.5.3 Trigger Mode

You can set up a trigger mode for the camera to send / save system logs, snapshots, recordings or messages. You can only select either the **Video motion detection** or the **Periodically** trigger mode.

Trigger mode

Video motion detection
 Periodically

Motion parameters



Windows Name

Object Size 5

Sensitivity 90

Motion parameters

Detect next event after second(s) (value must > 3)

【Video motion detection】 Select this to configure areas in which motion will be detected by the camera. Up to 16 areas can be configured.

To set up a motion area,

1. Drag the gray frame to a desired place and size.
2. Set up the following settings:

Windows Name: Type a name for the motion area.

Object Size: Slide the bar to set up the size of object which will be detected or not when it enters the configured motion area. This function is designed to prevent false detections caused by small objects.

Sensitivity: Set up the motion sensitivity for the grids. The larger the number, the higher the sensitivity.

3. **Detect next event after __ second(s):** Enter the time for the camera to detect the next event after the configured given time. Please note that you need to enter more than 3 seconds.

Click **New** to create a new motion area. Click **Delete** to delete the motion area. Click **Save** to save the configured motion areas.

Trigger mode

Video motion detection
 Periodically

period parameters

Detect next event after

second(s) (value must > 3)

【Periodically】 Select this to enable the camera to trigger actions periodically.

Detect next event after __ second(s): Enter a time for the camera to record after the configured given time. Please note that you need to enter more than 3 seconds.

7.5.4 Media Mode

Users can select a media mode (System log / Snapshot / Recording / Message) for the camera to send / upload / store to the configured place.

Media mode

System log Snapshot Record Message

【System log】 : Select this if you want to view the event-triggered system log information.

【Snapshot】 : Select this if you want to view the event-triggered snapshots (7 snapshots at a time).

Media mode

System log Snapshot Record Message

Please set snapshot parameters

Snapshot prefix file name

Add date and time suffix to file name

Snapshot prefix file name: Enter a name for the snapshot files. The maximum length is 20 digits.

- **Add date and time suffix to file name:** Check the box if you want to add the date and time information to the file name. Please check **Add date and time suffix to file name** box if you don't want to overwrite the snapshot files.

【Record】 : Select this if you want to view the event-triggered recording files (about 7-second video).

Media mode

System log Snapshot Record Message

Please set record parameters

Source

Record prefix file name

Add date and time suffix to file name

Enable cyclic recording

Source: Select a source stream for the video clips. There are three options, Stream 1, Stream 2 and Stream 3. You can configure the Stream 1 and Stream 2 settings in the Streaming setup (see 7.2.2 *Streaming*). The Stream 3 is fixed by the system, which is set up with H.264 and 640x480 resolution, and cannot be configured.

Snapshot prefix file name: Enter a name for the snapshot files. The maximum length is 20 digits.

- **Add date and time suffix to file name:** Check the box if you want to add the date and time information to the file name. Please check **Add date and time suffix to file name** box if you don't want to overwrite the recording files.
- **Enable cyclic recording:** Check the box for overwriting recording file when the storage capacity is full.

【Message】 : Select this if you want to view the event-triggered messages.

7.5.5 Response Mode

You can select multiple response modes for the camera to transmit the above selected media mode (System log / Snapshot / Recording / Message) for notification or backup use.

Response mode

Send a E-mail

E-mail security mode SMTP ▾

Server address

Server port 25

User account

User password

Sender email address

Recipient email address

E-mail subject Event from IP Cam..

E-mail body

Upload to FTP server

FTP server address

FTP server port 21

User account

User password

FTP folder name

Store at NAS

NAS server address

NAS shared directory

Workgroup

User account

User password

Upload to HTTP server

URL http://

Message trigger

User account

User password

Store at SD card

Apply
Cancel

Send an E-mail: Check this box to send the system logs, snapshots or recordings via email.

- **E-mail security mode:** Select an E-mail security mode.
- **Server address:** Input the sender's e-mail address, so that the receiver can recognize the sender when an event message is received.
- **Server port:** Enter the port number for SMTP. The default is 25.
- **User account:** Input the user's login ID.
- **User password:** Input the user's login password.

Note: If using the SMTP security mode, please don't input the User account and password.

- **Sender email address:** Input the sender's e-mail address, so that the receiver can recognize the sender when an event message is received.
- **Recipient email address:** Input the e-mail addresses for receiving an e-mail message when events occur. Please use ";" to separate multiple addresses.
- **E-mail subject:** Input the e-mail subject.
- **E-mail body:** Input the e-mail contents.

Upload to FTP: Check the box if you want the camera to upload the system logs, snapshots or recordings to the FTP server.

- **FTP server address:** Enter the IP address or the host name of the FTP server.
- **FTP server port:** Enter the port number for the FTP server. Default is 21.
- **User account:** Set FTP User's name.
- **User password:** Set FTP password.
- **FTP folder name:** Assign the recording path.

Store at NAS: Check the box if you want the camera to store the system logs, snapshots or recordings at the NAS server. For configuring the below settings, Please refer to the *7.3.4 The Recording Type* for .

- **NAS Server Address:** Enter the NAS server IP address.
- **Workgroup:** Enter the workgroup name of the NAS server.
- **NAS Shared Directory:** Enter the NAS shared directory path.
- **User Account:** Enter the user name of the NAS account.
- **User Password:** Enter the user password of the NAS account.

Upload to HTTP: Check the box if you want the camera to upload the system logs, snapshots, recordings or messages to HTTP.

- **URL:** Enter the URL of the HTTP server.
- **Message:** Enter the message contents.
- **User account:** Set HTTP User's name.
- **User password:** Set HTTP password.

Store at SD card: Check the box if you want the camera to store the system logs, snapshots or recordings at the SD card (This option will show up only if such a card has been inserted).

Note: Once you check the **Store at SD card** box, the SD card will not be able to be formatted, and the **Format** button will be grayed out in the *7.4.2 SD Card* setting page. Therefore, please format the SD card before enabling this function.

Click **Apply** to apply the above all settings or **Cancel** to cancel the changes and return to the previous settings.

7.6 User Management

This setting page is for the system administrator to set up its password and manage users.

7.6.1 Security Setting

The Administrator (only the original administrator account: “user1” or “admin”) is able to change and set up a new password of its own. It’s strongly recommended to configure a strong password to keep your account secure.

Select **Enable** to display the password settings below.

Admin password: Enter a strong password (the Administrator account named “user1 / admin” shared the same default password 11111111).

Confirm Admin password: Re-enter the password again to confirm.

Click **Apply** to apply the changes or **Cancel** to cancel the changes and return to the previous settings.

7.6.2 Manage User

The system administrator can create up to twenty user accounts on this page.

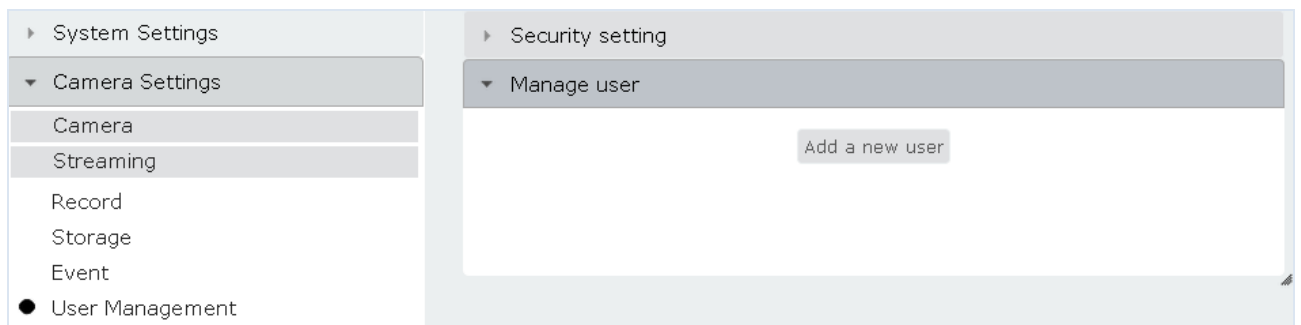

To add a new user:

Click the **Add a new user** button, and the **Add a new user** setting page will display as the following figure.

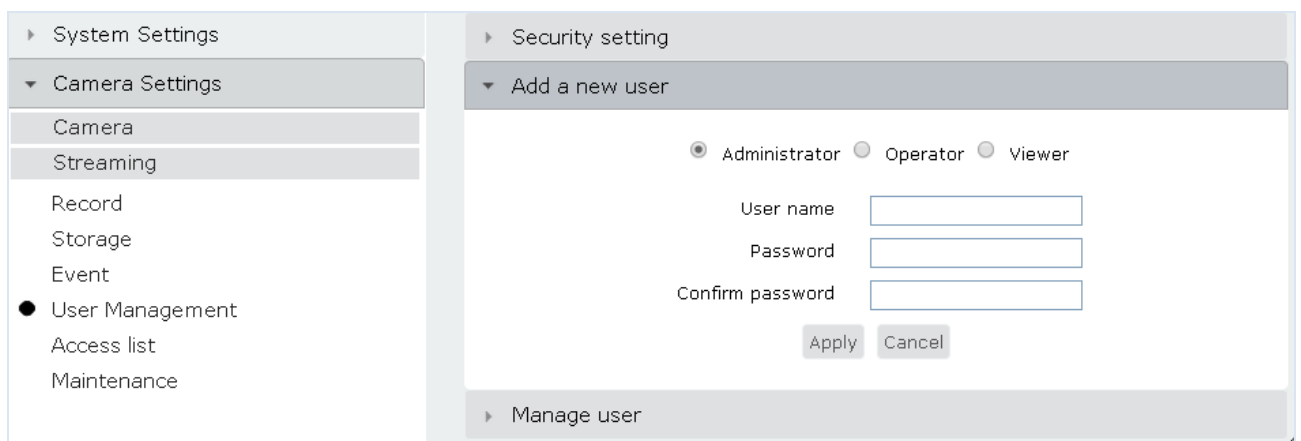

There are three kinds of user access levels (**Administrator / Operator / Viewer**) with different privileges respectively as blow. Please select a user access level, and set up its name and password. The maximum length of the user name is 49 digits.

The **Administrator** has full privilege to use and configure all the settings.

The **Operator** can operate all the functions on the live-view page and can access to the setting pages. However, the operator can only configure the below settings:

- Export system log (System Setting > System Information & Log > Current Log)
- Protocol Setting (System Setting > Network > Protocol Setting)
- Change Language (Maintenance > Language)

The **Viewer** can only view the live-view and change layout color of the live-view page.

Click **Apply** to apply the changes or **Cancel** to cancel the changes and return to the previous settings.

The added users will be shown on the **Manage user** page as below.

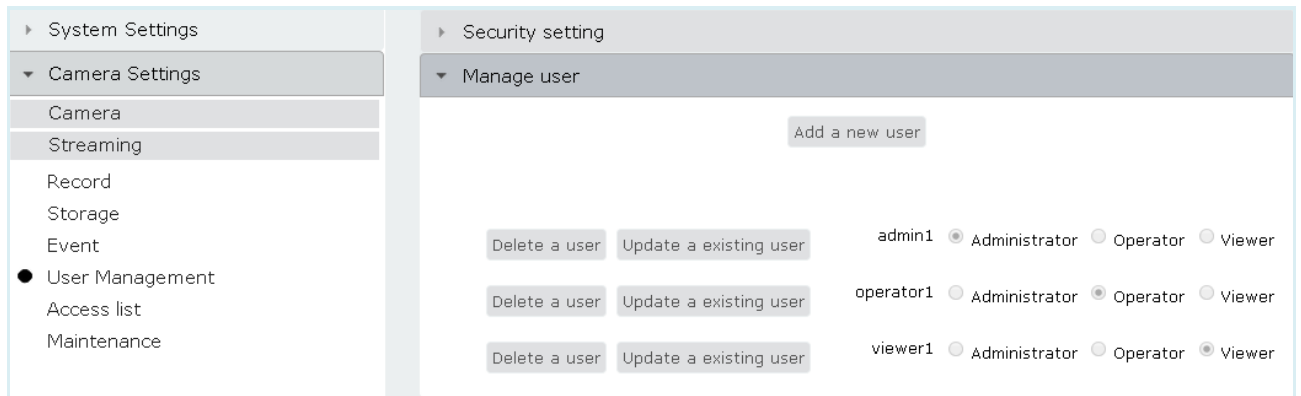

To modify the existing user:

Click the **Update a existing user** button, and you can modify the user’s access level / password on the following page. Please check the **Change Password** box first.

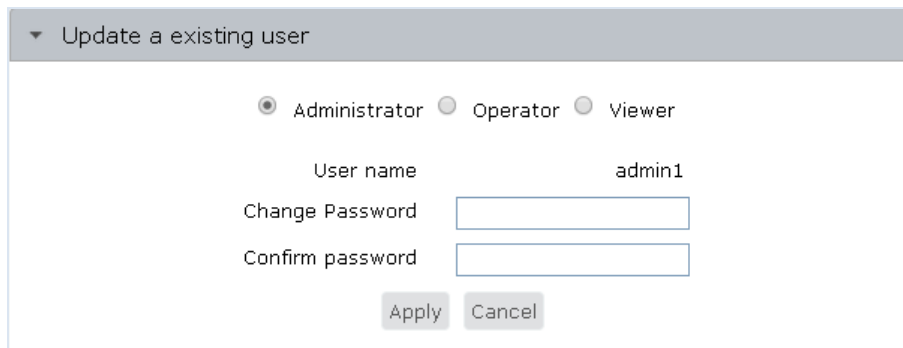

To delete the existing user:

Click the **Delete a user** button right next to the user account you want to delete.

7.7 Access List

7.7.1 Access List Setting

Use this page to specify IP addresses that are allowed / denied to access this camera. By default, any IP address can access the camera.

Note:

1. The user can only use either the **Allow** or **Deny** filter type because the allow and deny functions cannot work simultaneously.
2. Switching the configured filter type will erase all the previously added filter list, so please carefully decide which filter type you want to use before applying the setting.

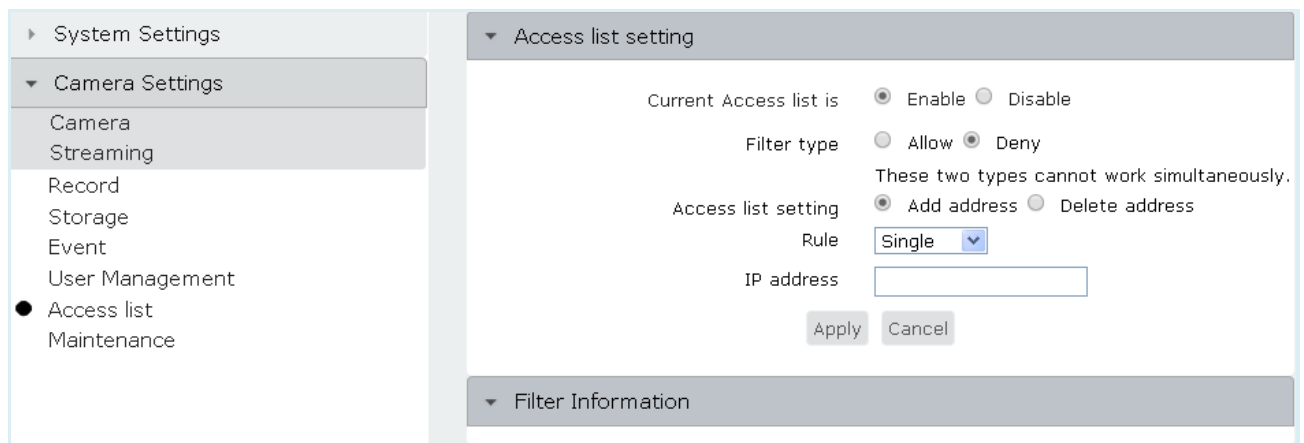

Current Access List is: Check Enable to display and configure the following settings.

Filter Type: Select **Allow** to allow the IP address configured below to access the camera. Select **Deny** to deny the IP addresses configured below from accessing the camera.

Access List Setting: Select **Add address** to add allowed or denied addresses. Select **Delete address** to delete the added allowed or denied addresses.

Rule: Select a network rule and then fill in the IP information in the below boxes.

- **Single:** Type a single IP address in the IP Address field below.
- **Network:** Type the IP address and subnet mask in the field below.
- **Range:** Type a range for the IP addresses.

Click **Apply** to apply the changes or **Cancel** to cancel the changes and return to the previous settings.

7.7.2 Filter information

The added IP address filter list will be shown on this page.

The screenshot shows the 'Access list setting' configuration page. On the left is a navigation menu with 'Access list' selected. The main content area is divided into two sections:

- Access list setting:**
 - Current Access list is: Enable Disable
 - Filter type: Allow Deny
 - These two types cannot work simultaneously.
 - Access list setting: Add address Delete address
 - Rule: Single (dropdown)
 - IP address: 192.168.11.11 (input field)
 - Buttons: Apply, Cancel
- Filter Information:**
 - ▶ IP Address: 192.168.11.11
 - ▶ IP Address: 192.168.11.60/20
 - ▶ IP Address: 192.168.11.20-192.168.11.30

Click **Delete address** to delete the added IP address respectively.

7.8 Maintenance

7.8.1 General Setting

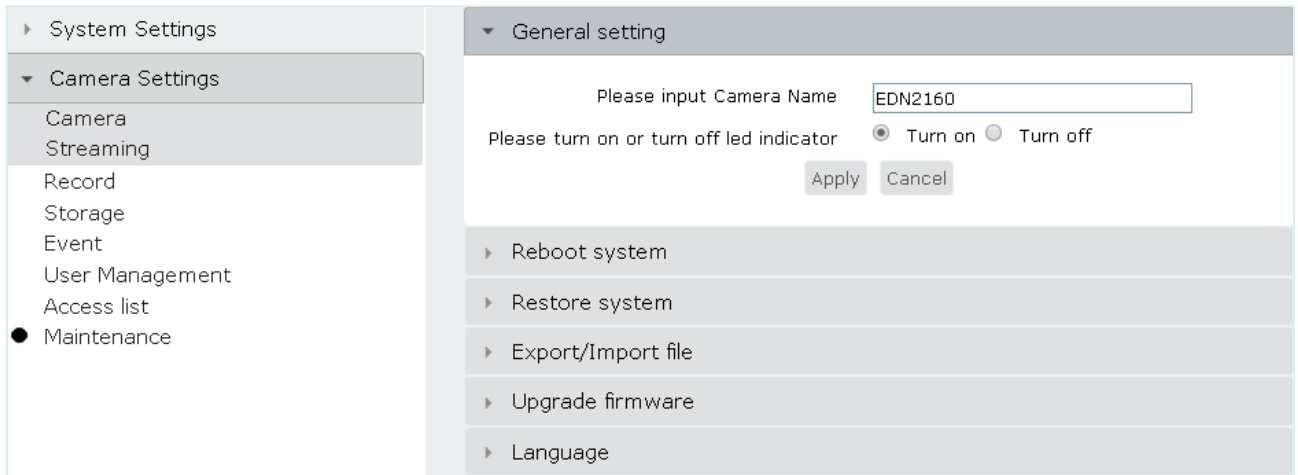

Please input Camera Name: Enter a name for the camera which will show on the upper-left side of the live-view page. Note that you can only input alphabetic and numeric characters or symbols in a maximum of 31 digits. Multilingual characters are not supported.

Please turn on or turn off led indicator: The red LED indicates the camera is powered while the blue LED indicates the camera is connected to the network. You can select to turn on or off both of the LED indicators.

Click **Apply** to apply the changes or **Cancel** to cancel the changes and return to the previous settings.

7.8.2 Reboot System

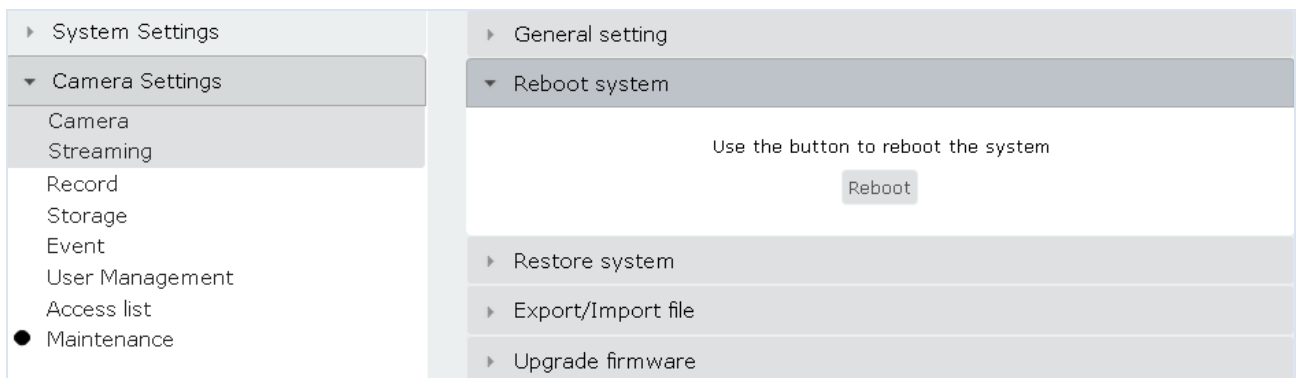

Reboot: Click to reboot the unit without changing any of the settings. Use this function if the unit is not behaving as expected.

7.8.3 Restore System

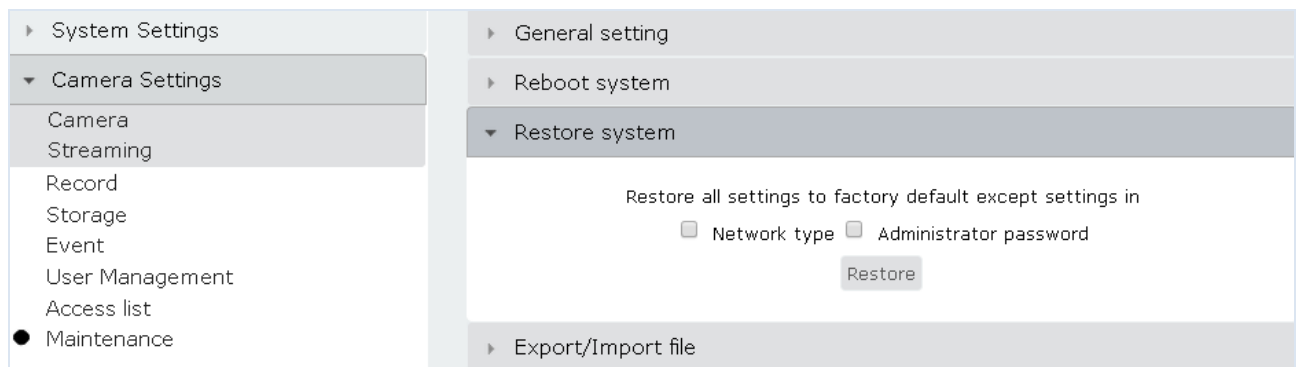

If you want to restore all settings except the network setting (the settings in *7.1.2 Network*), check the **Network type** box and click **Restore**.

If you want to restore all settings except the Administrator password (the settings in *7.6.1 Security Setting*), check the **Administrator password** box and click **Restore**.

You can also check both of the boxes to restore the all settings except the selected two settings.

Restore: Click to restore all settings to factory default.

7.8.4 Export / Import File

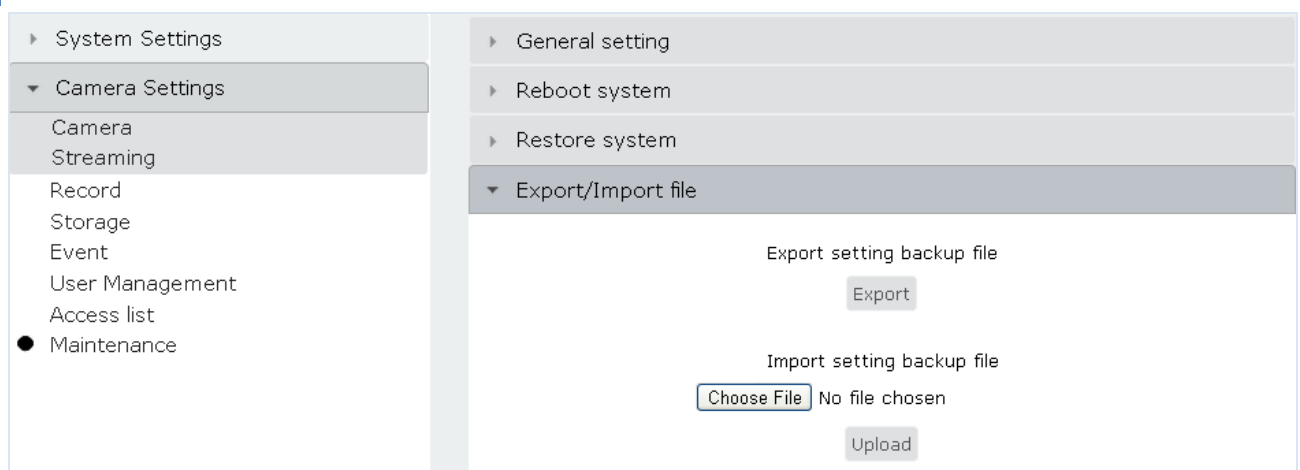

Export: To make a backup file of the machine’s current configurations, click this button to save all the configurations to a configuration file. This will enable the user to reload these configuration settings if the settings are changed and there is unexpected behavior.

Upload: To load a previously saved configuration, click the **Choose File** button to locate the saved configuration file (see above) and then click the **Upload** button. The system’s settings will be restored to the saved configuration.

7.8.5 Upload Firmware

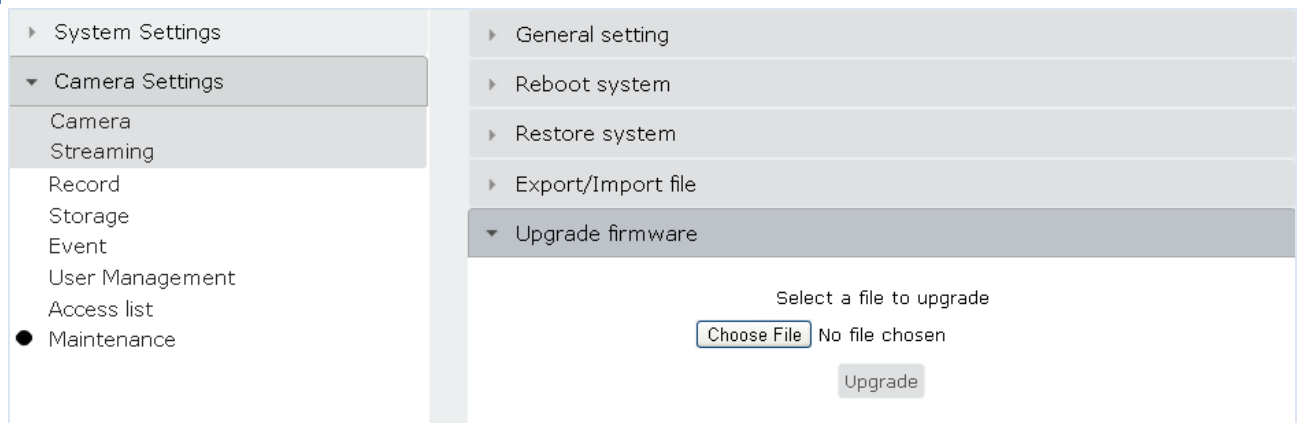

Upgrade: Click the **Choose File** button to find a previously prepared firmware upgrade file. Click the **Upgrade** button to install the new firmware.

7.8.6 Language

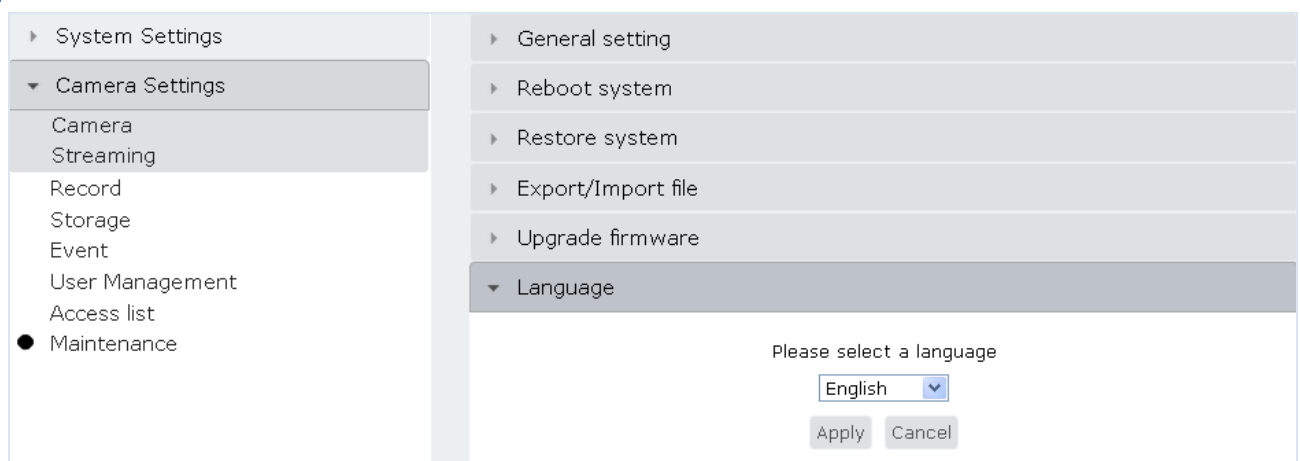

Please select a language: Select the language to be displayed on the Web interface of the IP camera. The default language is English.

Click **Apply** to apply the changes or **Cancel** to cancel the changes and return to the previous settings.

8. Upgrading Firmware Using IP Utility

You can upgrade the Firmware using the **IP Utility** software included in the software CD.

1. Install and then start the IPU program , the following IPU window appears. The IPU will automatically search the IP devices connected in the LAN.

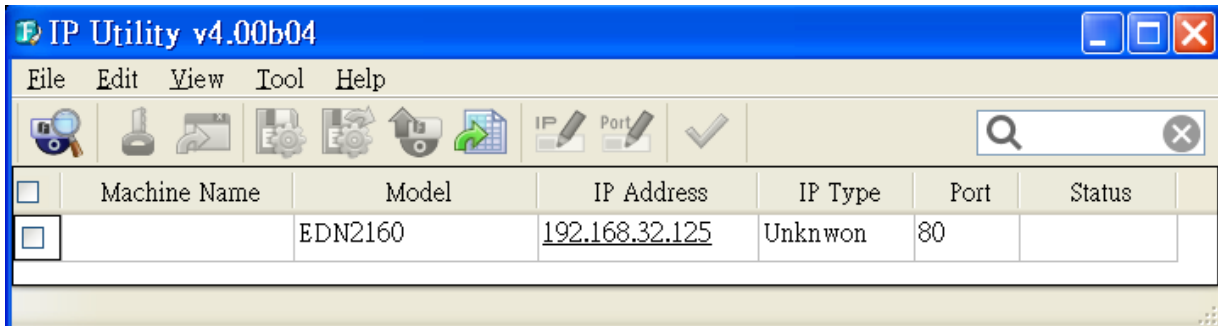

2. Log in the camera by checking the desired model and then click the **Log in**  icon. The Log in dialog box appears.

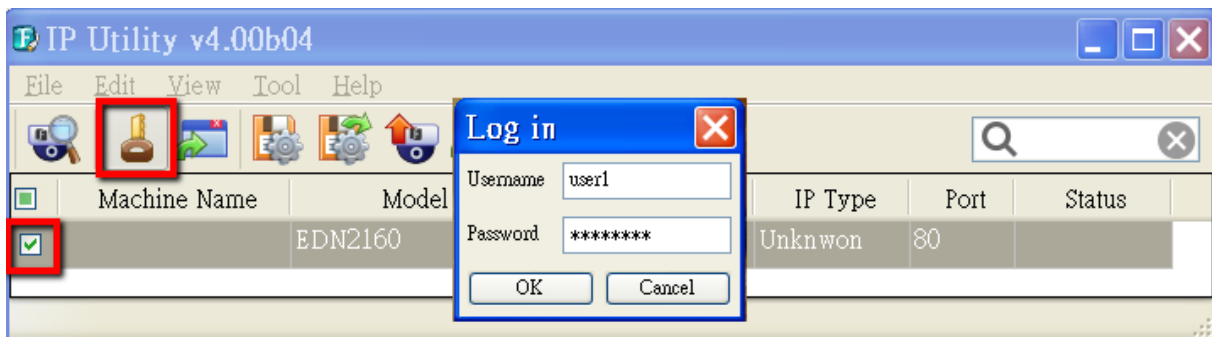

3. Type the Username and Password. Click the **OK** button, the **Login** status will displayed.

<input checked="" type="checkbox"/>	Machine Name	Model	IP Address	IP Type	Port	Status
<input checked="" type="checkbox"/>	EverFocus	EDN2160	192.168.32.125	DHCP	80	Login

Note:

1. The default user ID is **user1** or **admin** and the default password is **11111111**.
2. If you select more than one camera that has the same user ID / password, you will be able to log in several cameras at once.

4. Click the **Upgrade Firmware** button , a browsing window appears.

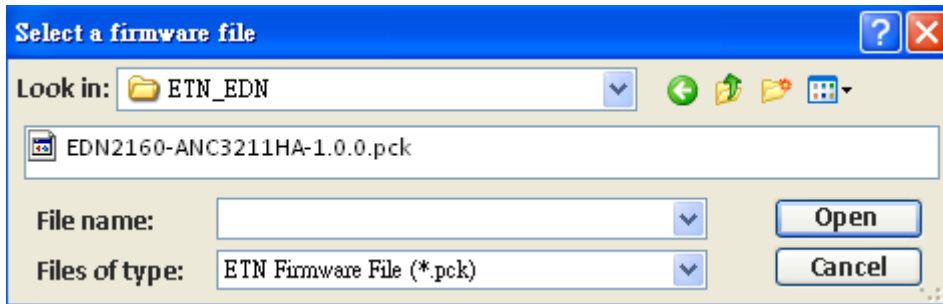

5. Select **EDN Firmware File (*.pck)** from the drop-down list and then select the **firmware file (.pck)** from your computer. The IPU will automatically upgrade the firmware and the count-down status appears.

<input type="checkbox"/>	Machine Name	Model	IP Address	IP Type	Port	Status
<input checked="" type="checkbox"/>	EverFocus	EDN2160	192.168.32.125	DHCP	80	Rebooting 152

Once the process of firmware upgrade and camera rebooting is complete, the Status will leave a blank column.

<input type="checkbox"/>	Machine Name	Model	IP Address	IP Type	Port	Status
<input checked="" type="checkbox"/>	EverFocus	EDN2160	192.168.32.125	DHCP	80	

Note: Up to 10 cameras can be simultaneously upgraded to the latest firmware. If you connect the cameras to a PoE switch, please make sure the Power Consumption of the PoE switch is sufficient.

9. Specifications

Model	EDN2160	EDN2260	EDN2560
Camera			
Image Sensor	1/4" color CMOS	1/2.7" color CMOS	1/3" color CMOS
Megapixel	1 MP	2 MP	5 MP
Max. Resolution	1280 x 800	1920 x 1080	2560 x 19200
Min. Illumination	0.5 Lux at F2.0		
Electronic Shutter	Auto (1/30 ~ 1/60,000)		
Scanning System	NTSC / PAL		
WDR	Yes		
AGC	Yes		
AWB	Yes		
Digital Zoom	4x		
Image Settings	Contrast, Brightness, Saturation, Sharpness, Mirroring of Images, Flip, Auto white balance, Auto Exposure control		
Event Trigger	Motion Detection		
Notification	E-mail notification		
IR Distance	10 m / 33 ft		
IR LED Quantity	19		
Lens			
Lens Type	Fixed IRIS		
Focal Length	4 mm		
Aperture	F2.0		
True Day / Night	Yes		
Video			
Video Compression	H.264, MPEG4 and MJPEG		H.264 and MJPEG
Resolution	NTSC	2560 x 1920 (EDN2560 only), 1920 x 1080 (for EDN2260/2560 only), 1280 x 1024 (for EDN2260 only), 1280 x 800, 1280 x 720 (for EDN2160 only), 704 x 576 (for EDN2160 only), 640 x 480, 320 x 240, 176 x144	
	PAL	2560 x 1920 (EDN2560 only), 1920 x 1080 (for EDN2260/2560 only), 1280 x 1024 (for EDN2260 only), 1280 x 800, 1280 x 720 (for EDN2160 only), 704 x 576 (for EDN2160 only), 640 x 480, 320 x 240, 176 x144	
Frame Rate	30 fps at 1280 x 800	30 fps at 1920 x 1080	10 fps at 2560 x 1920 30 fps at all other res.
S/N Ratio	> 50dB		

Audio			
Audio Capability		Audio input	
Audio Compression		G.711	
Interface		Built-in microphone	
Network			
Interface		10 / 100 Base-T Ethernet, LAN / PoE Cable	
Supported Protocols		TCP/IP, HTTP, SMTP, FTP, DDNS, UPnP, Telnet, NTP, PPPoE, DNS, DHCP, RTSP	
Security		Password protection, User privilege	
Mechanical			
Memory Card		One built-in micro SD / SDHC card slot * The camera only supports Micro SD/SDHC card up to 32GB in size.	
LAN / PoE Cable		RJ-45	
Power Cable		DC Jack; 12 VDC power input	
Camera Angle Adjustment	Pan	-100° ~ 100° (manual)	
	Tilt	20° ~ 90° (manual)	
General			
Power Source		12 VDC / PoE (IEEE802.3af, Class 3)	
Power Consumption (IR LEDs on)		12 VDC: 3.1W PoE: 3.2W	12 VDC: 4.1W PoE: 4.2W
Operating Temperature		0°C~40°C / 32°F~104°F	
Safety		CE, FCC	
Dimensions (Φ x H)		92 x 63 mm / 3.62" x 2.48"	
Weight		276 g / 0.61 lbs	
Language		English, French, German, Italian, Japanese, Portuguese, Simplified Chinese, Spanish, Traditional Chinese	

10. Troubleshooting

Error messages pop up

When these error messages pop up, follow the steps below to fix the problem.



1. To enter the Registry Editor of your computer: Click **Start** and type “**regedit**” in the *Search Program and Files* field.

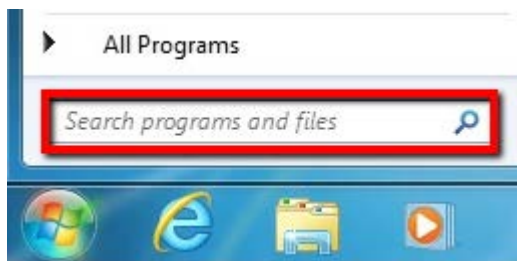

2. Click the **Enter** button, the Registry Editor window appears.

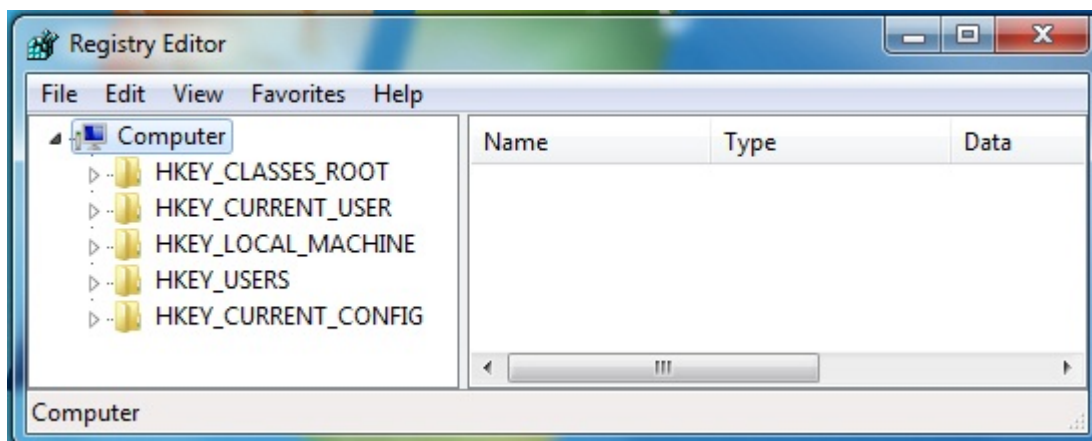

3. Find the **KeepAlive Timeout** Dword by following the path:

\HKEY_CURRENT_USER\Software\Microsoft\Windows\CurrentVersion\Internet Settings

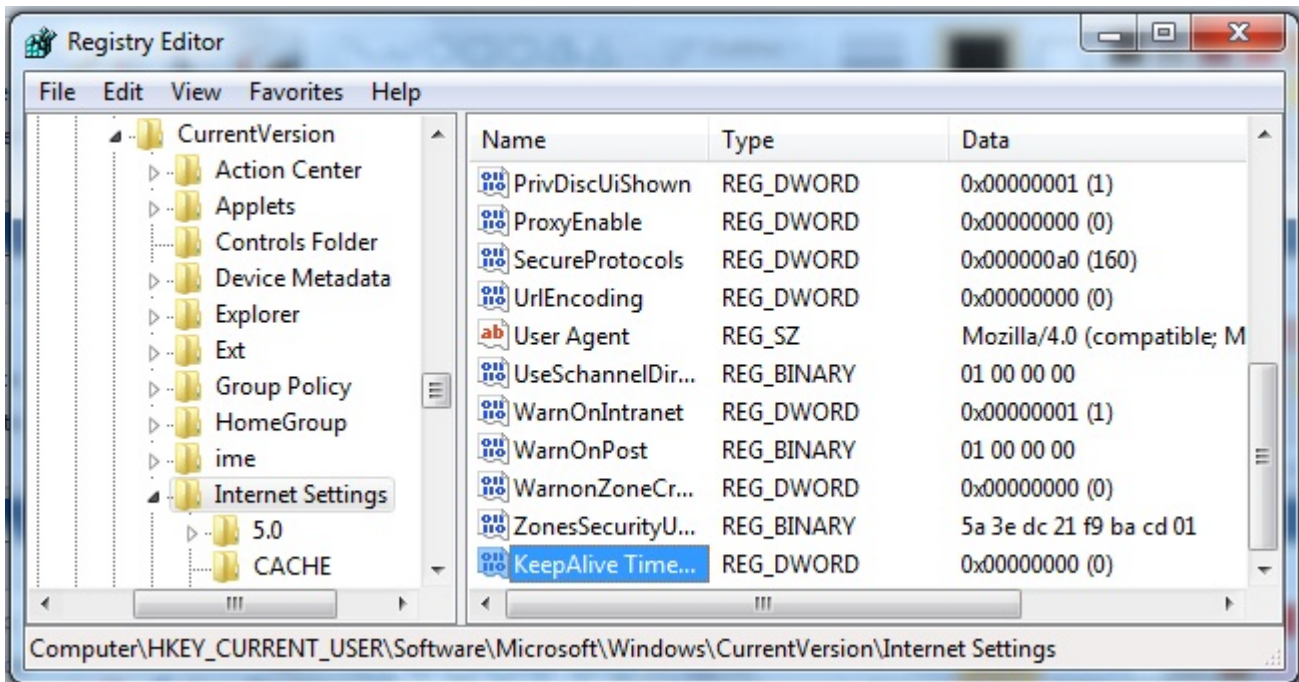

4. Double-click **KeepAlive Timeout** and this window appears.

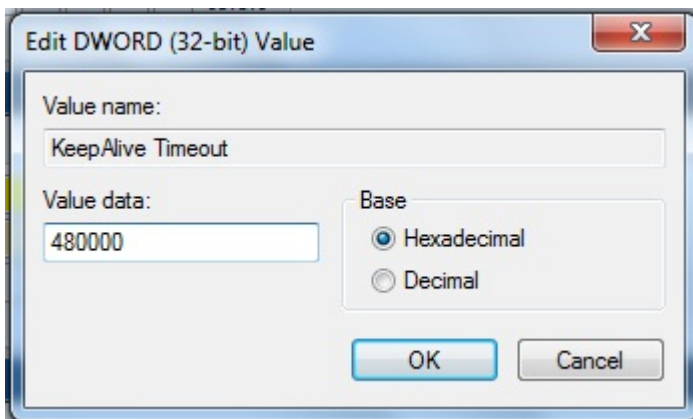

5. Change the Value data to **480000** and click **OK**.

EverFocus Electronics Corp.

EverFocus Taiwan:

12F, No.79, Sec. 1, Shin-Tai Wu Road,
Hsi-Chih, Taipei, Taiwan
TEL: +886 2 2698 2334
FAX: +886 2 2698 2380
www.everfocus.com.tw
marketing@everfocus.com.tw

EverFocus China - Beijing:

Room 609, Technology Trade Building,
Shangdi Information Industry Base,
Haidian District, Beijing 100085, China
TEL: +86 10 6297 3336~39
FAX: +86 10 6297 1423
www.everfocus.com.cn
marketing@everfocus.com.cn

EverFocus USA - California:

1801 Highland Avenue, Unit A, Duarte, CA 91010, USA
TEL: +1 626 844 8888
FAX: +1 626 844 8838
www.everfocus.com
sales@everfocus.com

EverFocus Japan:

5F, Kinshicho City Building, 2-13-4 Koto-Bashi, Sumida-Ku,
Tokyo, 130-0022, Japan
TEL: +81 3 5625 8188
FAX: +81 3 5625 8189
www.everfocus.co.jp
info@everfocus.co.jp

EverFocus India:

Suite 803, Housefin Bhavan, C-21,
Bandra Kurla Complex, Bandra (East),
Mumbai 400051, India
TEL: +91 22 6128 8700
FAX: +91 22 6128 8705
www.everfocus.in
sales@everfocus.in

EverFocus Europe - Germany:

Albert-Einstein-Strasse 1, D-46446
Emmerich, Germany
TEL: +49 2822 93940
FAX: +49 2822 939495
www.everfocus.de
sales@everfocus.de

EverFocus China - Shenzhen:

4F, No. 2, D4 Building, Wan Yelong
Industrial Park, Tangtou Road, Shiyan,
Baoan, Shenzhen, Guangdong 518101, China
TEL: +86 755 2765 1313
FAX: +86 755 2765 0337
www.everfocus.com.cn
marketing@everfocus.com.cn

EverFocus USA - New York:

415 Oser Avenue, Unit S, Hauppauge, NY 11788, USA
TEL: +1 631 436 5070
FAX: +1 631 436 5027
www.everfocus.com
sales@everfocus.com

EverFocus Europe - UK:

Unit 12, Spitfire Business Park,
Hawker Road, Croydon Surrey, CR0 4WD, UK
TEL: +44 20 8649 9757 / +44 845 430 9999
FAX: +44 20 8649 9907
www.everfocusuk.co.uk
salesuk@everfocus.com



Your EverFocus product is designed and manufactured with high quality materials and components which can be recycled and reused. This symbol means that electrical and electronic equipment, at their end-of-life, should be disposed of separately from your household waste. Please, dispose of this equipment at your local community waste collection/recycling centre. In the European Union there are separate collection systems for used electrical and electronic product. Please, help us to conserve the environment we live in!

Ihr EverFocus Produkt wurde entwickelt und hergestellt mit qualitativ hochwertigen Materialien und Komponenten, die recycelt und wieder verwendet werden können. Dieses Symbol bedeutet, dass elektrische und elektronische Geräte am Ende ihrer Nutzungsdauer vom Hausmüll getrennt entsorgt werden sollen. Bitte entsorgen Sie dieses Gerät bei Ihrer örtlichen kommunalen Sammelstelle oder im Recycling Centre. Helfen Sie uns bitte, die Umwelt zu erhalten, in der wir leben.

