

Magic Wand™ Portable Scanner

PDSWF-ST47-VP

User Manual



[VuPoint]®
Solutions

Table of Contents

| | | |
|------|---|-------|
| 1. | Key Features | 3 |
| 2. | Functional Parts | 3 |
| 3. | Explanation of the Status Icons..... | 5 |
| 4. | Using the Scanner..... | 5 |
| 4.1. | Charging up the Battery..... | 5 |
| 4.2. | Inserting a microSD Memory Card (not included)..... | 5 |
| 4.3. | Turn on/off the Scanner..... | 6 |
| 4.4. | How to Scan..... | 7 |
| 4.5. | How to Playback Image..... | 8 |
| 4.6. | Delete Single File..... | 9 |
| 4.7. | Setup Menu..... | 9 |
| | Scan Format | 10 |
| | Scan Quality | 10 |
| | Scan Color..... | 10 |
| | Language..... | 10 |
| | Date/Time | 10 |
| | Instant Preview..... | 10 |
| | Auto Off (Auto Power Off)..... | 10 |
| | Delete All (Delete All Files)..... | 11 |
| | Format the MicroSD Memory Card | 11 |
| | Device Information..... | 11 |
| 4.8. | How to Calibrate the Scanner..... | 11 |
| 5. | Connecting to Computer | 11 |
| 6. | Using the Wi-Fi® Function | 12 |
| 6.1 | Enabling the Wi-Fi® Function..... | 12 |
| 6.2 | Connecting to the Scanner via Wi-Fi® | 12-14 |
| 6.3 | Using the VuPoint Scanner App | 15 |
| 6.4 | Wi-Fi® Reset | 15 |
| 7. | Specifications | 16 |
| 8. | Computer System Minimum Requirements | 17 |
| 9. | Troubleshooting | 17 |





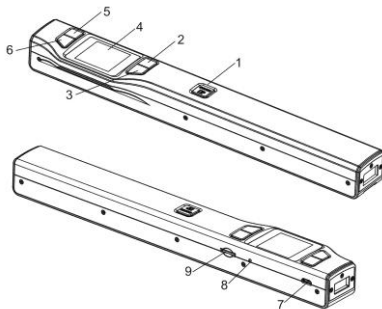

Getting to know your ST47 Portable Scanner

1. Key Features

- JPEG, PDF-A4 or PDF-Letter scan-format selection.
- Color or Monochromatic (mono) scan selection.
- 300 (LO) /600 (MI) /1050 (HI) DPI scan quality selection.
- Directly save JPG (JPEG)/PDF files to the microSD/microSDHC card.
- Support the microSD/microSDHC memory card up to 32GB.
- Color display to playback the scanned images.
- Built-in Wi-Fi® for file transfer.
- Supports Scan Direct function
- Wi-Fi® Scan Direct: Connect to smart device or tablet via Wi-Fi® and scan directly to smart device or tablet
- Compatible to Windows® XP, Windows® Vista™, Windows® 7, Windows® 8, and Mac OS® 10.5 or above (direct plug-in, driver installation not required)



2. Functional Parts



| | | |
|---|---|--|
| 1 |  | <p>Power On/ Off: Press and hold this key for 3 seconds to turn power on or off. When the scanner is powered on, press this button to start scanning, press this button again to stop.</p> <p>In Setup mode, press this button to confirm changes.</p> <p>In Playback mode, press this button to change the magnification between 4x, 8x and normal zoom.</p> |
| 2 |  | <p>Press this button to enter Playback mode;</p> <p>Press this button to return to the previous screen</p> <p>In Setup mode: Press this button to exit Setup mode.</p> |
| 3 |  | <p>Press this button to enter Setup Menu</p> <p>In Playback mode: Press this button to enter single file delete option.</p> <p>When zooming in under Playback mode: press this button to shift the functions of  and  between UP/DOWN and LEFT/RIGHT. Press and hold to turn Wi-Fi® on or off.</p> |
| 4 | LCD screen | Display scanning status, scanned image and scanner settings. |
| 5 |  | <p>Press this button to select JPG (JPEG), PDF-A (PDF-A4) or PDF-L (PDF-Letter) file format. The icon of the selected mode will be displayed on the LCD screen.</p> <p>In Setup mode: Press this button to move up the selection bar.</p> <p>In Playback mode: Press this button to preview the pervious image.</p> <p>When zooming in under Playback mode: press it to move to the upper/left portion of the image.</p> |
| 6 |  | <p>Press this button to select LO (300dpi), MI (600dpi) or HI (1050dpi) scan quality in DPI. The icon of the selected quality will be displayed on the LCD screen.</p> <p>In Setup mode: Press this button to move down the selection bar.</p> <p>In Playback mode: Press this button to preview the latter image.</p> <p>When zooming in under Playback mode: press it to move to the lower/right portion of the image.</p> |
| 7 | USB interface | Connect to a computer with the USB cable provided to view and transfer files. To charge the built-in battery with an optional AC/DC power adapter |
| 8 | Reset | Press to reset the scanner (Hardware reset) |
| 9 | microSD card slot | The microSD/microSDHC card storage location. |

3. Explanation of the Status Icons



| Item | Function | Description |
|------|-------------------------|---|
| 1 | File Format | JPG/PDF-A/PDF-L |
| 2 | Scan Resolution | LO: 300 DPI / MI: 600 DPI / HI: 1050 DPI |
| 3 | Battery Power Indicator |  Fully charged  Low battery. Recharge needed |
| 4 | Scan Color | COLOR/MONO |
| 5 | File Counter | Shows the number of scanned files in the microSD card |

4. Using the Scanner

4.1 Charging the Battery

Charge the built-in battery before using the scanner.

Charge time (while scanner is off): Approx. 2.5 hours.

Two charging methods:

1. By connecting to an AC/DC power adapter via the USB interface.
2. By connecting to a computer via USB cable (supplied).

Note:

Once the battery is fully charged while the scanner is off, battery indicator  will display on LCD screen for a short time and will turn off automatically.

4.2 Inserting a microSD Memory Card (not included)

To operate the scanner, you must insert a microSD Card (not supplied) to record and store your pictures. To insert the microSD memory card:

1. Turn OFF the scanner.
2. Insert the microSD card into the microSD card slot (with metal side facing upwards). Gently press in until the card is clicked in and latched.

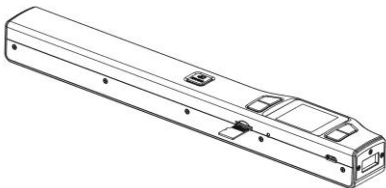

4.3 Turn on/off the Scanner

Turn on/off the scanner by pressing and holding  for 3 seconds.

Note:







If the scanner is turned on for the first time, it will enter Date & Time/Language setup mode. Once the Date & Time/ Language setting is completed, scanner will enter into standby mode.

By default, Auto-off feature is set to 3 minutes. If the Auto-off feature is set at "3 Min" (refer to section 4.7), the scanner will automatically turn off if scanning action is not detected within 3 minutes.

To set Date & Time/Language:

1. Press  to jump to next setting option: YEAR →MONTH →DATE →HOUR → MINUTE.

When setting up the value for MINUTE, press  to switch to the previous setting option until it reaches the YEAR option.

2. Press  or  to set the figure corresponding to each setting.
3. Press  to confirm and move to next setting.
4. After completing the setting for MINUTE, it will enter Language setup screen.
5. Press  or  to select your desired language.
6. Press  to confirm and enter into standby status.

4.4 How to Scan

Note: To scan, make sure your scanner is not connected to the computer.

1. Turn on your scanner by pressing and holding  for 3 seconds.
2. Place the document on a flat surface and hold down the document with one hand.
3. Place the scanner on the edge of the paper approximately 5/8 to 3/4 of an inch onto the edge of the paper to ensure the whole document can be scanned. Make sure to keep the scanning area within the scanning width indicators marked on the side of the scanner.



4. Hold the scanner flat against the material and then press  once to start the scanning process.



5. Slide the scanner across the document slowly, keeping your hand stable to get the best picture quality. During scanning, the scanning status icon will be displayed on the LCD screen to indicate scanning is in progress.







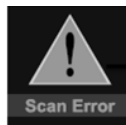

Once the scanner has reached the end of the document, press  again to stop scanning

Notes:









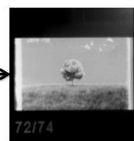
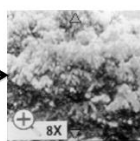
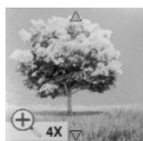

- If the scan is done too quickly or when there is any abnormal operation, "Scan Error" icon will display on the LCD screen. The image will still be saved after the scanning stops.
- If Instant Preview feature is set to "on", scan result will shortly be displayed on the LCD screen before the scanner returns to standby mode.
- When the memory card is full, the scanner is unable to scan more images. If you press the scan button under such situation, "Full" will flash rapidly on the File Counter of the LCD screen for 2 seconds.





4.5 How to Playback Image

1. Press  to enter Playback mode. The last scanned image will be displayed.
2. Press  or  to select your desired image. Press  to zoom into the image.  and  navigational indicators will appear on the screen.
3. Press  to change the magnification between 4x, 8x and normal zoom.



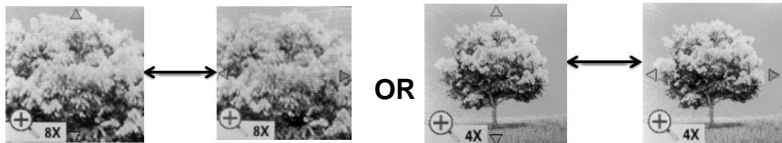





- Press  to view the upper portion of the image; Press  to view the lower portion of the image.
- Press  to shift  and  navigational functions to  and  Press  or  button to view the left or right portion of the image. Press  to change directions anytime.





- Press  to return to the previous Playback screen, press it again to return to standby mode.

Note: Images that exceeds 9MB file size cannot be magnified.





4.6 Delete Single File

| | |
|----|---|
| 1. | Press  to enter Playback mode. |
| 2. | Press  or  to select the file you want to delete. |
| 3. | Press  to enter Delete File setting. |
| 4. | Press  or  to select Yes or No. Select "Yes" to delete the current file in the microSD card. Select "No" to return to previous Playback screen. |
| 5. | Press  to confirm your selection and return to the previous Playback screen. |

4.7 Setup Menu

- Press  to enter Setup menu
- Press  or  to exit Setup menu.

Follow the below three steps to enter setup screen for each Menu item:





1. Press  to enter setup mode.
2. Press  or  to select the Menu item you want to set.
3. Press  to enter the setup screen.

| Menu items | Description | Options |
|---------------|--------------------|--|
| JPG/PDF | Scan Format | <ul style="list-style-type: none"> • JPG • PDF - A (A4) • PDF - L (Letter) |
| Quality | Scan Quality (DPI) | <ul style="list-style-type: none"> • Lo (300 DPI) • Mi (600 DPI) • Hi (1050 DPI) |
| Color | Scan Color | <ul style="list-style-type: none"> • Color • Mono |
| Language | Menu language | <ul style="list-style-type: none"> • English • Spanish • French • German • Italian • Dutch • Russian • Japanese • Traditional Chinese • Simplified Chinese |
| Date/Time | Date and Time | <ul style="list-style-type: none"> • Year • Month • Date • Hour • Minute |
| Inst. Preview | Instant preview | <ul style="list-style-type: none"> • On • Off |
| Auto Off | Auto Power Off | <ul style="list-style-type: none"> • Off • 3 Min |

| | | |
|-------------|--|---|
| Delete All | Delete All Files | <ul style="list-style-type: none"> • No • Yes |
| Format | Format the microSD Memory Card Note: All contents on microSD card will be erased during formatting | <ul style="list-style-type: none"> • No • Yes |
| Reset Wi-Fi | Reset the Wi-Fi settings | <ul style="list-style-type: none"> • No • Yes |
| Device Info | Device Information | / |

4.8 How to Calibrate the Scanner

Note: If the scanned images are too dark or too bright, you may need to calibrate your scanner by adjusting the white balance. Follow the below steps to perform calibration:

1. Wipe off any dirt on the surface of the scanning lens with the clean dry cloth provided.
2. Press  turn on the scanner. Place the scanner on the white area of the White Balance Calibration paper provided.
3. Press and hold  button. While holding the  button, press the  button and then release both buttons to enter into auto-calibration mode. The message "1. Calibration starts. Do not move the device!" will appear on LCD screen.
4. Do not move the scanner until "2. Scan the calibration sheet!" appears on the LCD screen. Start scanning the white area of the calibration paper by sliding the scanner across the paper (slide the scanner backwards if necessary).
5. "3. Calibration completed!" message will appear on the LCD screen when calibration is completed.
6. Press any button to power off the scanner.

5. Connecting to Computer

View your scanned files on your computer

You may also connect your scanner to your computer and view pictures on the computer monitor

1. Press and hold  to turn on your scanner, connect your scanner to your computer to enter into USB mode. "USB" icon will display on LCD screen.
2. Your computer will recognize the scanner as a "Removable Disk". Click "Open folder to view files" to view, import, copy, move or to delete scanned files.



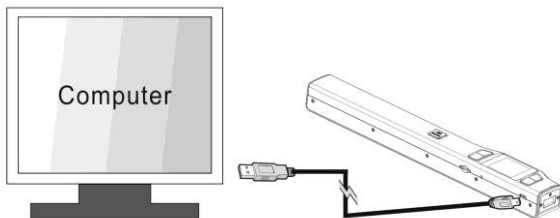

Note: If the Removable Device window did not launch automatically, go to your "My Computer/Computer" (PC) and find the device under Removable Storage.

6. Using the Wi-Fi® Function

6.1 Enabling the Wi-Fi® Function

View and transfer files from the scanner to your computer, laptop, smart device or tablets via Wi-Fi.

1. Turn on the scanner, then press and hold the  button. "Starting" will display on the screen.
2. Wait approximately 30 - 40 seconds for Wi-Fi® to initialize.
3. "Ready" will display on the screen once the Wi-Fi® finishes initializing.

Notes:

- The use of Wi-Fi® will consume a larger amount of battery. To preserve battery, it is suggested to turn off the Wi-Fi® when not in use.
- When Wi-Fi® is on, you will be unable to use the scanner to scan. Exception: Use of the SCAN Direct feature. Refer to section 6.3 to utilize the SCAN Direct function to scan files directly to your smart device.
- Calibration cannot be performed while using Wi-Fi®.



6.2 Connecting to the Scanner via Wi-Fi®

1. Turn on the Wi-Fi® by pressing and holding  button.
2. Go to the network setting on the computer/smart device and turn on the Wi-Fi®
3. When "Ready" indication is displayed on the scanner's screen, search for the "WIFISCAN" network in the computer/smart device setting
4. Enter "123456789" as the password to connect to the scanner



5. “Connected” will be display on the scanner’s screen once Wi-Fi® is connected on the device.
6. Open an Internet browser and enter “192.168.1.2” or “wifi.scan” in the address bar to enter the navigation page.

In the navigation page, all the scanned images will be shown on the browser in thumbnails. You can view and delete files stored in the scanner or change the scanner Wi-Fi® settings.

Note: If a new Wi-Fi® password is forgotten, it can be reset by using the Reset Wi-Fi® option in the Scanner settings. Refer to section 6.4

View files from an Internet Browser via Wi-Fi®

Click the “View” button to preview a single file.

Note: If a JPG format file exceeds 4MB, a notification “Image is too large” will be presented and the file cannot be previewed.



Delete files from Internet Browser via Wi-Fi®

Delete your selected files.

1. Click the “Delete” icon and a “Selected File(s)” window will appear.

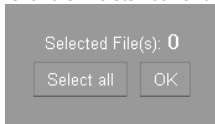

2. Check the files that you want to delete.



- Click the "OK" on the "Selected File(s)" window to delete the files.

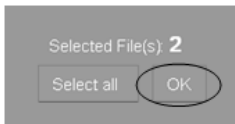

- Delete all files:

- In the "Selected File(s)" window, click "Select all" icon. All the files on current page will be checked.
Note: When the "Select all" option as been clicked, it will change to "Clear All". Choosing "Clear All" will remove the check marks.

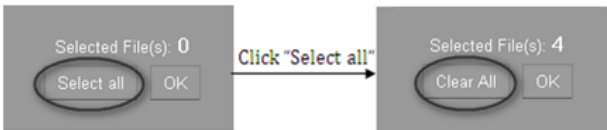

- Click "OK" to confirm selection

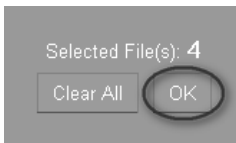

Change Scanner WiFi settings

In the navigation page, click "Scanner WiFi@ settings" to modify the default settings.

Note: When modifying the scanner Wi-Fi@ settings on a smart device, after clicking the "MENU" option, the "SCANNER WIFI SETTINGS" option will appear.

- Enter your new SSID, Password, IP Address and Domain Name in the blanks spaces.
- Click "Submit" to confirm your setting.
- After confirming changes to the Scanner Wi-Fi@ settings, restart the Wi-Fi@.

Note: Viewing error may occur when previewing larger file. Turn off the Wi-Fi@ and connect the scanner to a computer via USB cable to view the files.

6.3 Using the VuPoint Scanner App

Brief introduction of our App:

VuPoint Scanner App is a mobile application for both iOS™ and Android™ platforms, which connects your smart device with the portable scanner through Wi-Fi® connection.

VuPoint Scanner App allows you to check the scanner's battery status, Wi-Fi® connection status and upload status on your iOS™ or Android™ smart device. You can scan files directly to your smart device via the SCAN Direct feature, browse saved files on your scanner, sort the files by date, size or file form, view file details and rename the files.

You can save the scanned files to your smart device, add or delete tags on files, combine more than one file into one multi-page PDF file, log into your social media and share your file(s) to services such as Dropbox™ or Facebook™.

1. Search for VuPoint Scanner app via Google Play™ Store or App StoreSM.
2. Download and install the app onto your smart device.
3. Turn on the Wi-Fi® on the scanner.
4. Go to network setting on your smart device and enable the Wi-Fi®.
5. When "Ready" appears on the scanner's screen, search for the "WIFISCAN" network on the smart device
6. Enter password "123456789" to connect to the scanner.
7. Open your VuPoint Scanner app and it is ready for use.

6.4 Wi-Fi® Reset

You may reset the Wi-Fi® settings to default in the setup menu of the scanner. Be sure to insert a microSD card before starting the Wi-Fi® reset.

1. Turn on the scanner and enter the Setup menu. Select "Reset Wi-Fi®" at the bottom of the menu. Also refer to section 4.7 to enter the Reset Wi-Fi® menu.
2. After entering the Reset Wi-Fi® menu, a message "Reset the Wi-Fi® settings?" will be displayed on the screen. Select "Yes" to confirm and the message "Reset in progress!" will be displayed.
3. Once the reset is complete, "Reset completed!" will be displayed on the screen. Press any button to return to setup menu.

7. Specifications

| | | |
|---|---|--|
| Image sensor | Color Contact Image Sensor | |
| Resolution | Low resolution : 300x300 dpi Medium resolution: 600x600 dpi High resolution: 1050x1050 dpi | |
| Minimum scanning speed for Letter size document | Color High resolution Mono High resolution Color Medium resolution Mono Medium resolution Color Low resolution Mono Low resolution | 12.0 Seconds 10.0 Seconds 8.0 Seconds 6.0 Seconds 3.0 Seconds 2.0 Seconds |
| Capacity (Based on 1GB microSD card. Scan Letter size file, the quantity of scans varies depending on the content complexity) | Color High resolution Mono High resolution Color Medium resolution Mono Medium resolution Color Low resolution Mono Low resolution | 140 Scans (Min.) 150 Scans (Min.) 550 Scans (Min.) 600 Scans (Min.) 1580 Scans (Min.) 1600 Scans (Min.) |
| Scanner photo size | A4、A5、5R、4R、3R and smaller | |
| Scan width | Approx. 8.5" | |
| Scan length | 300DPI:125"(max);600DPI:60";1050DPI:50"(max) | |
| File format | JPEG/PDF | |
| LCD | Approx 1.5" Class* Color LCD | |
| Zoom | 4x, 8x | |
| Dimensions (LxHxW) | 10.5"×1.1"×1.5" | |
| Auto power off | 3 Minutes | |
| USB port | USB 2.0 high speed | |
| External memory | microSD/microSDHC card | |
| Standard battery | Built-in 700mAh Lithium-Poylmer | |
| Battery charge time | Approx. 2.5 hours | |
| Wi-Fi® | 802.11 b/g/n | |

8. Computer System Minimum Requirements

| | |
|------------------|--|
| Operating System | Windows® XP, Windows® Vista™, Windows® 7, Windows® 8, and Mac OS® 10.5 or above (direct plug-in, driver installation not required) |
| CPU | Pentium III or above |
| RAM | At least 256MB |
| Interface | USB port |

9. Troubleshooting

| Problem | Cause | Solution |
|---|--|---|
| Unable to turn on scanner | Low battery power | Recharge the battery |
| Pictures cannot be saved while you are scanning them | <ol style="list-style-type: none">1. The microSD card has not been installed2. Memory is full3. The microSD card has not been formatted properly | <ol style="list-style-type: none">1. Insert a microSD card2. Transfer the pictures from the scanner to the computer to create storage space in the memory card3. Please See Section 4.7 |
| "Scan Error" icon appears on the LCD screen | <ol style="list-style-type: none">1. Scanning speed is too quick2. microSD card speed is slow | <ol style="list-style-type: none">1. Rescan the document2. Replace original memory card with a higher class microSD card. (Class 6 or above recommended) |
| Computer does not recognize your scanner when connected(You cannot find your device under removable disk) | Connection failure | <ol style="list-style-type: none">1. Make sure all cable connections are secured2. Restart the computer if necessary |
| Blurry images | <ol style="list-style-type: none">1. The lens of scanner is dirty2. Contact Image Sensor aged | <ol style="list-style-type: none">1. Clean the lens with soft and dry cloth2. Recalibrate scanner. See section 4.8 |
| Black Images/Black or white vertical lines | <ol style="list-style-type: none">1. Scanner sensor's protective glass is dirty2. Calibration data is off-set | <ol style="list-style-type: none">1. Clean the sensor's protective glass with clean and soft dry cloth.2. Recalibrate scanner. See section 4.8 |
| Wi-Fi® connection | <ol style="list-style-type: none">1. Connection problem2. Battery is low | <ol style="list-style-type: none">1. Reconnect Wi-Fi®. See Section 62. Recharge the battery. See Section 4.1 |

Note: Model Number and Serial Number (S/N) is located on the packaging, instruction manual, on the product or inside the battery compartment. Please have this information ready before contacting tech support.

FCC (Federal Communications Commission)

This device complies with Part 15 of the FCC Rules.

Operation is subject to the following two conditions:

- (1) This device may not cause harmful interference, and
- (2) this device must accept any interference received, including interference that may cause undesired operation.

*Measured diagonally. Actual size is 1.48"; viewable area is 1.44"

Windows® XP, Windows® Vista™, Windows® 7, Windows® 8 are registered trademarks of Microsoft Corporation.

Mac OS® 10.5 and iOS™ is a registered trademark of Apple Inc. App Store™ is a service mark of Apple Inc.

Google Play™ and Android™ are registered trademarks of Google Inc.

Wi-Fi® is a registered trademark of the Wi-Fi® Alliance. Facebook™ is a registered trademark of Facebook, Inc.

Dropbox™ is a registered trademark of Dropbox, Inc. microSD and microSDHC logo is a trademark of SD-3C, LLC.

All trademarks are the property of their respective owner.



PDSWF-ST47-VP- _Manual_14-0417
AM-N47W-GB-VPS-1