

lenovo

Lenovo A7600

*Hardware
Maintenance
Manual*

A large, faint, light gray graphic of a hand holding a pen is positioned in the background, extending from the bottom left towards the right side of the page.

Note:

Before using this information and the product it supports, be sure to read the general information under “Notices” on page 78.

First Edition (February 2014)

© Copyright Lenovo 2014. All rights reserved.

LENOVO products, data, computer software, and services have been developed exclusively at private expense and are sold to governmental entities as commercial items as defined by 48 C.F.R. 2.101 with limited and restricted rights to use, reproduction and disclosure.

LIMITED AND RESTRICTED RIGHTS NOTICE: If products, data, computer software, or services are delivered pursuant to a General Services Administration “GSA” contract, use, reproduction, or disclosure is subject to restrictions set forth in Contract No. GS-35F-05925.

© 2014 Lenovo

Contents

About this manual	iv	Front view	73
Safety information	1	Rear view	74
General safety	2	Parts list	75
Electrical safety	3	Overall	75
Safety inspection guide	5	Screw	77
Handling devices that are sensitive to electro- static discharge	6	Notices	78
Grounding requirements	6	Trademarks	79
Safety notices: multilingual translations	7		
Laser compliance statement.....	14		
Important service information	16		
Strategy for replacing FRUs.....	16		
Important notice for replacing a system board	17		
Important information about replacing RoHS compliant FRUs	18		
General checkout	19		
What to do first	20		
Power system checkout	21		
Checking the Computer AC Charger	21		
Checking the internal battery status.....	22		
Related service information	23		
Security	23		
Power management	23		
Activating/Deactivating the Display	23		
Lenovo A7600	24		
Specifications	24		
FRU replacement notices.....	26		
Screw notices.....	26		
Removing and replacing an FRU	27		
1010 Rear cover and side keys.....	28		
1020 Battery pack.....	33		
1030 Battery holder	35		
1040 LCM FPC	37		
1050 Rear camera.....	41		
1060 Antenna and CAP sensor FPC assem- bly	43		
1070 SIM board FPC.....	49		
1080 SIM board	52		
1090 Main board	54		
1100 Front camera	64		
1110 Vibrator motor	65		
1120 Left speaker	66		
1130 Right speaker	69		
Locations.....	73		

About this manual

This manual contains service and reference information for the following Lenovo product:

- **Lenovo A7600**

Use this manual to troubleshoot problems.

The manual is divided into the following sections:

- The common sections provide general information, guidelines, and safety information required for servicing computers.
- The product-specific section includes service, reference, and product-specific parts information.

Important:

This manual is intended only for trained servicers who are familiar with Lenovo products. Use this manual to troubleshoot problems effectively. Before servicing a Lenovo product, make sure to read all the information under “Safety information” on page 1 and “Important service information” on page 16.

Safety information

This chapter presents the following safety information that you need to get familiar with before you service a Lenovo computer:

- “General safety” on page 2
- “Electrical safety” on page 3
- “Safety inspection guide” on page 5
- “Handling devices that are sensitive to electrostatic discharge” on page 6
- “Grounding requirements” on page 6
- “Safety notices: multilingual translations” on page 7
- “Laser compliance statement” on page 14

General safety

Follow these rules below to ensure general safety:

- Observe a good housekeeping in the area where the machines are put during and after the maintenance.
- When lifting any heavy object:
 1. Make sure that you can stand safely without slipping.
 2. Distribute the weight of the object equally between your feet.
 3. Use a slow lifting force. Never move suddenly or twist when you attempt to lift it.
 4. Lift it by standing or pushing up with your leg muscles; this action could avoid the strain from the muscles in your back. Do not attempt to lift any object that weighs more than 16 kg (35 lb) or that you think is too heavy for you.
- Do not perform any action that causes hazards to the customer, or that makes the machine unsafe.
- Before you start the machine, make sure that other service representatives and the customer are not in a hazardous position.
- Place removed covers and other parts in a safe place, keeping them away from all personnel, while you are servicing the machine.
- Keep your toolcase away from walk areas so that other people will not trip it over.
- Do not wear loose clothing that can be trapped in the moving parts of the machine. Make sure that your sleeves are fastened or rolled up above your elbows. If your hair is long, fasten it.
- Insert the ends of your necktie or scarf inside clothing or fasten it with the nonconductive clip, about 8 centimeters (3 inches) from the end.
- Do not wear jewelry, chains, metal-frame eyeglasses, or metal fasteners for your clothing.

Attention: Metal objects are good electrical conductors.
- Wear safety glasses when you are hammering, drilling, soldering, cutting wire, attaching springs, using solvents, or working in any other conditions that may be hazardous to your eyes.
- After service, reinstall all safety shields, guards, labels, and ground wires. Replace any safety device that is worn or defective.
- Reinstall all covers correctly before returning the machine to the customer.
- Fan louvers on the machine help to prevent the overheating of internal components. Do not obstruct fan louvers or cover them with labels or stickers.

Electrical safety

Observe the following rules when working on electrical equipments.

Important:

Use only approved tools and test equipments. Some hand tools have handles covered with a soft material that does not insulate you when working with live electrical currents.

Many customers have rubber floor mats near their machines that contain small conductive fibers to decrease electrostatic discharges. Do not use such kind of mat to protect yourself from electrical shock.

- Find the room emergency power-off (EPO) switch for disconnecting the switch or electrical outlet. If an electrical accident occurs, you can then operate the switch or unplug the power cord quickly.
- Do not work alone under hazardous conditions or near the equipment that has hazardous voltages.
- Disconnect all power before:
 - Performing a mechanical inspection
 - Working near power supplies
 - Removing or installing main units
- Before you start to work on the machine, unplug the power cord. If you cannot unplug it, ask the customer to power-off the wall box that supplies power to the machine, and to lock the wall box in the off position.
- If you need to work on a machine that has exposed electrical circuits, observe the following precautions:
 - Ensure that another person, familiar with the power-off controls, is near you.
Attention: Another person must be there to switch off the power, if necessary.
 - Use only one hand when working with powered-on electrical equipment; keep the other hand in your pocket or behind your back.
Attention: An electrical shock can occur only when there is a complete circuit. By observing the above rule, you may prevent a current from passing through your body.
 - When using testers, set the controls correctly and use the approved probe leads and accessories for that tester.
 - Stand on suitable rubber mats (obtained locally, if necessary) to insulate you from grounds such as metal floor strips and machine frames.

Observe the special safety precautions when you work with very high voltages; instructions for these precautions are in the safety sections of maintenance information. Be extremely careful when you measure the high voltages.

- Regularly inspect and maintain your electrical hand tools for safe operational condition.
- Do not use worn or broken tools and testers.
- Never assume that power has been disconnected from a circuit. First, check it to make sure that it has been powered off.

- Always look carefully for possible hazards in your work area. Examples of these hazards are moist floors, nongrounded power extension cables, power surges, and missing safety grounds.
- Do not touch live electrical circuits with the reflective surface of a plastic dental mirror. The surface is conductive; such touching can cause personal injury and machine damage.
- Do not service the following parts with the power on when they are removed from their normal operating places in a machine:
 - Power supply units
 - Pumps
 - Blowers and fans
 - Motor generatorsand similar units. (This practice ensures correct grounding of the units.)
- If an electrical accident occurs:
 - Caution: do not become a victim yourself.
 - Switch off the power.
 - Send the victim to get medical aid.

Safety inspection guide

The purpose of this inspection guide is to assist you in identifying potential unsafe conditions. As each machine was designed and built, required safety items were installed to protect users and service personnel from injury. This guide addresses only those items. You should use good judgment to identify potential safety hazards according to the attachment of non-Lenovo features or options not covered by this inspection guide.

If any unsafe conditions are present, you must determine how serious the apparent hazard could be and whether you can continue without first correcting the problem.

Consider these conditions and the safety hazards they present:

- Electrical hazards, especially primary power (primary voltage on the frame can cause serious or fatal electrical shock)
- Explosive hazards, such as a damaged CRT face or a bulging capacitor
- Mechanical hazards, such as loose or missing hardware

To determine whether there are any potential unsafe conditions, use the following checklist at the beginning of every service task. Begin the checks with the power off, and the power cord disconnected.

Checklist:

1. Check exterior covers for damage (loose, broken, or sharp edges).
2. Turn off the computer. Disconnect the power cord.
3. Check the power cord for:
 - a. A third-wire ground connector in good condition. Use a meter to measure third-wire ground continuity for 0.1 ohm or less between the external ground pin and the frame ground.
 - b. The power cord should be the type specified in the parts list.
 - c. Insulation must not be frayed or worn.
4. Check for cracked or bulging batteries.
5. Remove the cover.
6. Check for any obvious non-Lenovo alterations. Use good judgment as to the safety of any non-Lenovo alterations.
7. Check inside the unit for any obvious unsafe conditions, such as metal filings, contamination, water or other liquids, or signs of fire or smoke damage.
8. Check for worn, frayed, or pinched cables.
9. Check that the power-supply cover fasteners (screws or rivets) have not been removed or tampered with.

Handling devices that are sensitive to electrostatic discharge

Any computer part containing transistors or integrated circuits (ICs) should be considered sensitive to electrostatic discharge (ESD). ESD damage can occur when there is a difference in charge between objects. Protect against ESD damage by equalizing the charge so that the machine, the part, the work mat, and the person handling the part are all at the same charge.

Notes:

1. Use product-specific ESD procedures when they exceed the requirements noted here.
2. Make sure that the ESD protective devices you use have been certified (ISO 9000) as fully effective.

When handling ESD-sensitive parts:

- Keep the parts in protective packages until they are inserted into the product.
- Avoid contact with other people.
- Wear a grounded wrist strap against your skin to eliminate static on your body.
- Prevent the part from touching your clothing. Most clothing is insulative and retains a charge even when you are wearing a wrist strap.
- Use the black side of a grounded work mat to provide a static-free work surface. The mat is especially useful when handling ESD-sensitive devices.
- Select a grounding system, such as those listed below, to provide protection that meets the specific service requirement.

Notes:

The use of a grounding system to guard against ESD damage is desirable but not necessary.

- Attach the ESD ground clip to any frame ground, ground braid, or green-wire ground.
- When working on a double-insulated or battery-operated system, use an ESD common ground or reference point. You can use coax or connector-outside shells on these systems.
- Use the round ground prong of the ac plug on ac-operated computers.

Grounding requirements

Electrical grounding of the computer is required for operator safety and correct system function. Proper grounding of the electrical outlet can be verified by a certified electrician.

Safety notices: multilingual translations

The safety notices in this section are provided in English, French, German, Hebrew, Italian, Japanese, and Spanish.

Safety notice 1

Before the computer is powered on after FRU replacement, make sure all screws, springs, and other small parts are in place and are not left loose inside the computer. Verify this by shaking the computer and listening for rattling sounds. Metallic parts or metal flakes can cause electrical shorts.

Avant de remettre l'ordinateur sous tension après remplacement d'une unité en clientèle, vérifiez que tous les ressorts, vis et autres pièces sont bien en place et bien fixées. Pour ce faire, secouez l'unité et assurez-vous qu'aucun bruit suspect ne se produit. Des pièces métalliques ou des copeaux de métal pourraient causer un court-circuit.

Bevor nach einem FRU-Austausch der Computer wieder angeschlossen wird, muß sichergestellt werden, daß keine Schrauben, Federn oder andere Kleinteile fehlen oder im Gehäuse vergessen wurden. Der Computer muß geschüttelt und auf Klappergeräusche geprüft werden. Metallteile oder-splitter können Kurzschlüsse erzeugen.

לפני הפעלת המחשב לאחר החלפת FRU יש לוודא שכל הברזים, הקפיצים, וחלקים קטנים אחרים נמצאים במקומם ואינם חופשיים לזוז בתוך המחשב. כדי לוודא זאת, יש ללטלט את המחשב ולהקשיב לגילוי קולות שקשוק. חלקי או שבבי ממתכת עלולים לגרום לקצרים חשמליים.

Prima di accendere l'elaboratore dopo che é stata effettuata la sostituzione di una FRU, accertarsi che tutte le viti, le molle e tutte le altre parti di piccole dimensioni siano nella corretta posizione e non siano sparse all'interno dell'elaboratore. Verificare ciò scuotendo l'elaboratore e prestando attenzione ad eventuali rumori; eventuali parti o pezzetti metallici possono provocare cortocircuiti pericolosi.

FRUの交換後、コンピュータの電源を入れる前に、ねじ、バネ、その他の小さな部品がすべて正しい位置にあり、またコンピュータの内部で緩んでいないことを確認してください。これを確認するには、コンピュータを振って、カチャカチャと音がしないか確かめます。金属部品や金属破片はショートの原因になることがあります。

Antes de encender el sistema despues de sustituir una FRU, compruebe que todos los tornillos, muelles y demás piezas pequeñas se encuentran en su sitio y no se encuentran sueltas dentro del sistema. Compruébelo agitando el sistema y escuchando los posibles ruidos que provocarían. Las piezas metálicas pueden causar cortocircuitos eléctricos.

Safety notice 2

DANGER

Some standby batteries contain a small amount of nickel and cadmium. Do not disassemble a standby battery, recharge it, throw it into fire or water, or short-circuit it. Dispose of the battery as required by local ordinances or regulations. Use only the battery in the appropriate parts listing. Use of an incorrect battery can result in ignition or explosion of the battery.

Certaines batteries de secours contiennent du nickel et du cadmium. Ne les démontez pas, ne les rechargez pas, ne les exposez ni au feu ni à l'eau. Ne les mettez pas en court-circuit. Pour les mettre au rebut, conformez-vous à la réglementation en vigueur. Lorsque vous remplacez la pile de sauvegarde ou celle de l'horloge temps réel, veillez à n'utiliser que les modèles cités dans la liste de pièces détachées adéquate. Une batterie ou une pile inappropriée risque de prendre feu ou d'exploser.

Die Bereitschaftsbatterie, die sich unter dem Diskettenlaufwerk befindet, kann geringe Mengen Nickel und Cadmium enthalten. Sie darf nicht zerlegt, wiederaufgeladen, kurzgeschlossen, oder Feuer oder Wasser ausgesetzt werden. Bei der Entsorgung die örtlichen Bestimmungen für Sondermüll beachten. Beim Ersetzen der Bereitschafts- oder Systembatterie nur Batterien des Typs verwenden, der in der Ersatzteilliste aufgeführt ist. Der Einsatz falscher Batterien kann zu Entzündung oder Explosion führen.

סוללות המתנה מסיימות מכילות כמות קטנה של ניקל וקדמיום. אין לפרק סוללת המתנה, לטעון אותה מחדש, להשליך אותה לאש או למים או לקצר אותה. יש לשלול את הסוללה כדורש על ידי התקנות והחוקים המקומיים. יש להשתמש רק בסוללה המופיעה ברשימת החלקים המתאימה. שימוש בסוללה לא מתאימה עלול לגרום להצתה או התפוצצות של הסוללה.

Alcune batterie di riserva contengono una piccola quantità di nichel e cadmio. Non smontarle, ricaricarle, gettarle nel fuoco o nell'acqua né cortocircuitarle. Smaltirle secondo la normativa in vigore (DPR 915/82, successive disposizioni e disposizioni locali). Quando si sostituisce la batteria dell'RTC (real time clock) o la batteria di supporto, utilizzare soltanto i tipi inseriti nell'appropriato Catalogo parti. L'impiego di una batteria non adatta potrebbe determinare l'incendio o l'esplosione della batteria stessa.

予備バッテリーの中には少量のニッケルとカドミウムが含まれているものがあります。したがって、予備バッテリーの分解、再充電、火または水の中への投棄、またはショートさせることは決して行わないでください。バッテリーを廃棄する場合は地方自治体の条例に従ってください。適切なパーツ・リストにあるバッテリーだけを使用してください。誤ったバッテリーを使用すると、バッテリーが発火したり、爆発したりすることがあります。

Algunas baterías de reserva contienen una pequeña cantidad de níquel y cadmio. No las desmonte, ni recargue, ni las eche al fuego o al agua ni las cortocircuite. Deséchelas tal como dispone la normativa local. Utilice sólo baterías que se encuentren en la lista de piezas. La utilización de una batería no apropiada puede provocar la ignición o explosión de la misma.

Safety notice 3**⚠ DANGER**

The battery pack contains small amounts of nickel. Do not disassemble it, throw it into fire or water, or short-circuit it. Dispose of the battery pack as required by local ordinances or regulations. Use only the battery in the appropriate parts listing when replacing the battery pack. Use of an incorrect battery can result in ignition or explosion of the battery.

La batterie contient du nickel. Ne la démontez pas, ne l'exposez ni au feu ni à l'eau. Ne la mettez pas en court-circuit. Pour la mettre au rebut, conformez-vous à la réglementation en vigueur. Lorsque vous remplacez la batterie, veillez à n'utiliser que les modèles cités dans la liste de pièces détachées adéquate. En effet, une batterie inappropriée risque de prendre feu ou d'exploser.

Akkus enthalten geringe Mengen von Nickel. Sie dürfen nicht zerlegt, wiederaufgeladen, kurzgeschlossen, oder Feuer oder Wasser ausgesetzt werden. Bei der Entsorgung die örtlichen Bestimmungen für Sondermüll beachten. Beim Ersetzen der Batterie nur Batterien des Typs verwenden, der in der Ersatzteilliste aufgeführt ist. Der Einsatz falscher Batterien kann zu Entzündung oder Explosion führen.

מארו הסוללה מכיל כמות קטנה של ניקל וקדמיום. אין לפרק את מארו הסוללה, להשליך אותו לאש או למים או לקצר אותו. יש לשלק את מארו הסוללה הסוללה כנדרש על ידי התקנות החוקיות המקומיים. יש להשתמש רק בסוללה המופיעה ברשימת החלקים המתאימה בזמן החלפת מארו הסוללה. שימוש בסוללה לא מתאימה עלול לגרום לנזקה או התמוצות של הסוללה.

La batteria contiene piccole quantità di nichel. Non smontarla, gettarla nel fuoco o nell'acqua né cortocircuitarla. Smaltirla secondo la normativa in vigore (DPR 915/82, successive disposizioni e disposizioni locali). Quando si sostituisce la batteria, utilizzare soltanto i tipi inseriti nell'appropriato Catalogo parti. L'impiego di una batteria non adatta potrebbe determinare l'incendio o l'esplosione della batteria stessa.

バッテリー・パックには少量のニッケルが含まれています。バッテリー・パックを分解したり、火または水の中に投げ込んだり、ショートさせないでください。バッテリー・パックの廃棄にあたっては、地方自治体の条例または規則に従ってください。バッテリー・パックを交換するときは、適切なパーツ・リストにあるバッテリーだけを使用してください。誤ったバッテリーを使用すると、バッテリーが発火したり、爆発したりすることがあります。

Las baterías contienen pequeñas cantidades de níquel. No las desmonte, ni recargue, ni las eche al fuego o al agua ni las cortocircuite. Deséchelas tal como dispone la normativa local. Utilice sólo baterías que se encuentren en la lista de piezas al sustituir la batería. La utilización de una batería no apropiada puede provocar la ignición o explosión de la misma.

Safety notice 4

⚠ DANGER

The lithium battery can cause a fire, an explosion, or a severe burn. Do not recharge it, remove its polarized connector, disassemble it, heat it above 100°C (212°F), incinerate it, or expose its cell contents to water. Dispose of the battery as required by local ordinances or regulations. Use only the battery in the appropriate parts listing. Use of an incorrect battery can result in ignition or explosion of the battery.

La pile de sauvegarde contient du lithium. Elle présente des risques d'incendie, d'explosion ou de brûlures graves. Ne la rechargez pas, ne retirez pas son connecteur polarisé et ne la démontez pas. Ne l'exposez pas à une température supérieure à 100°C, ne la faites pas brûler et n'en exposez pas le contenu à l'eau. Mettez la pile au rebut conformément à la réglementation en vigueur. Une pile inappropriée risque de prendre feu ou d'exploser.

Die Systematterie ist eine Lithiumatterie. Sie kann sich entzünden, explodieren oder schwere Verbrennungen hervorrufen. Batterien dieses Typs dürfen nicht aufgeladen, zerlegt, über 100 C erhitzt oder verbrannt werden. Auch darf ihr Inhalt nicht mit Wasser in Verbindung gebracht oder der zur richtigen Polung angebrachte Verbindungsstecker entfernt werden. Bei der Entsorgung die örtlichen Bestimmungen für Sondermüll beachten. Beim Ersetzen der Batterie nur Batterien des Typs verwenden, der in der Ersatzteilliste aufgeführt ist. Der Einsatz falscher Batterien kann zu Entzündung oder Explosion führen.

סוללת הליתיום עלולה לגרום לשריפה, להתפוצצות או לכוויות קשות. אין לטעון אותה מחדש, לטלול את המחבר המקוטב שלה, לפרק אותה או לחמם אותה לטמפרטורה העולה על 100 מעלות צלזיוס. אין לשרוף את הסוללה ואין לחשוף את תוכן התא ללמיים. יש לטלול את הסוללה כנדרש בתקנות ובחוקים המקומיים. יש להשתמש רק בסוללה המופיעה ברשימת החלקים המתאימים. שימוש בסוללה אחרת עלול לגרום לסכנת שריפה או התפוצצות.

La batteria di supporto e una batteria al litio e puo incendiarsi, esplodere o procurare gravi ustioni. Evitare di ricaricarla, smontarne il connettore polarizzato, smontarla, riscaldarla ad una temperatura superiore ai 100 gradi centigradi, incendarla o gettarla in acqua. Smaltirla secondo la normativa in vigore (DPR 915/82, successive disposizioni e disposizioni locali). L'impiego di una batteria non adatta potrebbe determinare l'incendio o l'esplosione della batteria stessa.

リチウム・バッテリーは、火災、爆発、または重症のやけどを引き起こすことがあります。バックアップ・バッテリーの充電、その極性コネクタの取り外し、バッテリー本体の分解、100°C (212°F) 以上への加熱、焼却、電池の中身を水に浸すことはしないでください。バッテリーを廃棄する場合は地方自治体の条例に従ってください。適切なパーツ・リストにあるバッテリーだけを使用してください。誤ったバッテリーを使用すると、バッテリーが発火したり、爆発したりすることがあります。

La batería de respaldo es una batería de litio y puede provocar incendios, explosiones o quemaduras graves. No la recargue, ni quite el conector polarizado, ni la desmonte, ni caliente por encima de los 100°C (212°F), ni la incinere ni exponga el contenido de sus celdas al agua. Deséchela tal como dispone la normativa local.

Safety notice 5

If the LCD breaks and the fluid from inside the LCD gets into your eyes or on your hands, immediately wash the affected areas with water at least for 15 minutes. Seek medical care if any symptoms caused by the fluid are present after washing.

Si le panneau d'affichage à cristaux liquides se brise et que vous recevez dans les yeux ou sur les mains une partie du fluide, rincez-les abondamment pendant au moins quinze minutes. Consultez un médecin si des symptômes persistent après le lavage.

Die Leuchtstoffröhre im LCD-Bildschirm enthält Quecksilber. Bei der Entsorgung die örtlichen Bestimmungen für Sondermüll beachten. Der LCD-Bildschirm besteht aus Glas und kann zerbrechen, wenn er unsachgemäß behandelt wird oder der Computer auf den Boden fällt. Wenn der Bildschirm beschädigt ist und die darin befindliche Flüssigkeit in Kontakt mit Haut und Augen gerät, sollten die betroffenen Stellen mindestens 15 Minuten mit Wasser abgespült und bei Beschwerden anschließend ein Arzt aufgesucht werden.

אם מסך הנגיש הנוזלי (LCD) נשבר והנוזל מתוך המסך בא במגע עם עיניכם או ידיכם, שטפו את האזורים הנגועים מיד במים במשך 15 דקות לפחות. פנו לקבלת עזרה רפואית אם תסמינים הנובעים מהמגע עם הנוזל נמשכים לאחר השטיפה.

Nel caso che caso l'LCD si dovesse rompere ed il liquido in esso contenuto entrasse in contatto con gli occhi o le mani, lavare immediatamente le parti interessate con acqua corrente per almeno 15 minuti; poi consultare un medico se i sintomi dovessero permanere.

LCD が破損し、LCD 中の液体が目に入ったり、手に触れたりした場合は、液体が触れた部分を少なくとも 15 分間洗い流してください。洗い流した後に、液体によって何らかの症状が現れた場合は、医師の治療を受けてください。

Si la LCD se rompe y el fluido de su interior entra en contacto con sus ojos o sus manos, lave inmediatamente las áreas afectadas con agua durante 15 minutos como mínimo. Obtenga atención medica si se presenta algún

Safety notice 6

⚠ DANGER

To avoid shock, do not remove the plastic cover that protects the lower part of the inverter card.

Afin d'éviter tout risque de choc électrique, ne retirez pas le cache en plastique protégeant la partie inférieure de la carte d'alimentation.

Aus Sicherheitsgründen die Kunststoffabdeckung, die den unteren Teil der Spannungswandlerplatine umgibt, nicht entfernen.

כדי למנוע התחשמלות, אין להסיר את מכסה הפלסטיק המגן על חלקו התחתון של הכרטיס ההפוך.

Per evitare scosse elettriche, non rimuovere la copertura in plastica che avvolge la parte inferiore della scheda invertitore.

感電を防ぐため、インバーター・カードの下部を保護しているプラスチック・カバーを外さないでください。

Para evitar descargas, no quite la cubierta de plástico que rodea la parte baja de la tarjeta invertida.

Safety notice 7

⚠ DANGER

Though the main batteries have low voltage, a shorted or grounded battery can produce enough current to burn personnel or combustible materials.

Bien que le voltage des batteries principales soit peu élevé, le court-circuit ou la mise à la masse d'une batterie peut produire suffisamment de courant pour brûler des matériaux combustibles ou causer des brûlures corporelles graves.

Obwohl Hauptbatterien eine niedrige Spannung haben, können sie doch bei Kurzschluß oder Erdung genug Strom abgeben, um brennbare Materialien zu entzünden oder Verletzungen bei Personen hervorzurufen.

אף שהסוללות הראשיות הן בעלות מתח נמוך, סוללה מקוצרת או מוארקת עלולה להפיק זרם מספיק לגרימת כוויות או לרזתת חומרים דליקים.

Sebbene le batterie di alimentazione siano a basso voltaggio, una batteria in corto circuito o a massa può fornire corrente sufficiente da bruciare materiali combustibili o provocare ustioni ai tecnici di manutenzione.

メイン・バッテリーの電圧は低くても、ショートしたり、接地したバッテリーが、作業者にやけどを負わせたり、可燃物を燃やすだけの電流を発生させる場合があります。

Aunque las baterías principales tienen un voltaje bajo, una batería cortocircuitada o con contacto a tierra puede producir la corriente suficiente como para quemar material combustible o provocar quemaduras en el personal.

Safety notice 8

⚠ DANGER

Before removing any FRU, turn off the computer, unplug all power cords from electrical outlets, remove the battery pack, and then disconnect any interconnecting cables.

Avant de retirer une unité remplaçable en clientèle, mettez le système hors tension, débranchez tous les cordons d'alimentation des socles de prise de courant, retirez la batterie et déconnectez tous les cordons d'interface.

Die Stromzufuhr muß abgeschaltet, alle Stromkabel aus der Steckdose gezogen, der Akku entfernt und alle Verbindungskabel abgenommen sein, bevor eine FRU entfernt wird.

לפני שילוק FRU כלשהו, יש לכבות את המחשב, לנתק את כל כבלי החשמל ממשקני החשמל, להוציא את מאיזן הסוללה, וזו לנתק כבלי חיבור אחרים אם יש כאלה.

Prima di rimuovere qualsiasi FRU, spegnere il sistema, scollegare dalle prese elettriche tutti i cavi di alimentazione, rimuovere la batteria e poi scollegare i cavi di interconnessione.

FRU を取り外す前に、ThinkPad の電源を切って、すべての電源コードをコンセントから外してください。次に、バッテリー・パックを外し、相互接続ケーブルを外してください。

Antes de quitar una FRU, apague el sistema, desenchufe todos los cables de las tomas de corriente eléctrica, quite la batería y, a continuación, desconecte cualquier cable de conexión entre dispositivos.

Laser compliance statement

Some models of Lenovo computer are equipped from the factory with an optical storage device such as a CD-ROM drive or a DVD-ROM drive. Such devices are also sold separately as options. If one of these drives is installed, it is certified in the U.S. to conform to the requirements of the Department of Health and Human Services 21 Code of Federal Regulations (DHHS 21 CFR) Subchapter J for Class 1 laser products. Elsewhere, the drive is certified to conform to the requirements of the International Electrotechnical Commission (IEC) 825 and CENELEC EN 60 825 for Class 1 laser products.

If a CD-ROM drive, a DVD-ROM drive, or another laser device is installed, note the following:

CAUTION

Use of controls or adjustments or performance of procedures other than those specified herein might result in hazardous radiation exposure.

O uso de controles, ajustes ou desempenho de procedimentos diferentes daqueles aqui especificados pode resultar em perigosa exposição à radiação.

凡未在这里指明的任何控制用法、调整、行为，都会导致严重后果。

Pour éviter tout risque d'exposition au rayon laser, respectez les consignes de réglage et d'utilisation des commandes, ainsi que les procédures décrites.

Werden Steuer- und Einstellelemente anders als hier festgesetzt verwendet, kann gefährliche Laserstrahlung auftreten.

Az itt előírt eljárásoktól, beállításoktól és vezérlésektől eltérni a lézersugárzás veszélye miatt kockázatos!

L'utilizzo di controlli, regolazioni o l'esecuzione di procedure diverse da quelle specificate possono provocare l'esposizione a.

Использование элементов настройки и выполнение процедур иных, чем указано здесь, может привести к опасному радиационному облучению.

Použitie kontrol, úprav alebo iných vykonaní od iných výrobcov, ako je v tomto špecifikované, mohlo by mať za následok nebezpečenstvo vystavenia sa vyžiarovaniu.

本書で指定された内容以外のお客様による整備、調整、または手順を行った場合、レーザー光の放射の危険があります。

El uso de controles o ajustes o la ejecución de procedimientos distintos de los aquí especificados puede provocar la exposición a radiaciones peligrosas.

Opening the CD-ROM drive, the DVD-ROM drive, or any other optical storage device could result in exposure to hazardous laser radiation. There are no serviceable parts inside those drives. **Do not open.**

A CD-ROM drive, a DVD-ROM drive, or any other storage device installed may contain an embedded Class 3A or Class 3B laser diode. Note the following:

 **DANGER**

Emits visible and invisible laser radiation when open. Do not stare into the beam, do not view directly with optical instruments, and avoid direct exposure to the beam.

Radiação por raio laser ao abrir. Não olhe fixo no feixe de luz, não olhe diretamente por meio de instrumentos óticos e evite exposição direta com o feixe de luz.

开启时会有激光发射时，请勿直视激光光束，请勿直接查看视觉仪器，并且避免直接接触在激光光束之中。

Rayonnement laser si carter ouvert. Évitez de fixer le faisceau, de le regarder directement avec des instruments optiques, ou de vous exposer au rayon.

Laserstrahlung bei geöffnetem Gerät. Nicht direkt oder über optische Instrumente in den Laserstrahl sehen und den Strahlungsbereich meiden.

Kinyitáskor lézersugár! Ne nézzen bele se szabad szemmel, se optikai eszközökkel. Kerülje a sugárnyalábbal való érintkezést!

Aprendo l'unità vengono emesse radiazioni laser. Non fissare il fascio, non guardarlo direttamente con strumenti ottici e evitare l'esposizione diretta al fascio.

Открывая, берегитесь лазерного излучения.

Не смотрите на луч, не разглядывайте его с помощью оптических инструментов, а также избегайте прямого воздействия лазерного луча.

Keď je laserová jednotka otvorená. Vyhnite sa priamemu pohľadu a nehľadte priamo s optickými nástrojmi do lúča a vyhnite sa priamemu vystaveniu lúčov.

開けるとレーザー光が放射されます。光線を見つめたり、光学機械を使って直接見たりしないでください。

Radiación láser al abrir. No mire fijamente ni examine con instrumental óptico el haz de luz. Evite la exposición directa al haz.

Important service information

This chapter presents the following important service information:

- “Strategy for replacing FRUs” on page 16
 - “Important notice for replacing a system board” on page 17
- “Important information about replacing RoHS compliant FRUs” on page 18

Important:

BIOS and device driver fixes are customer-installable. The BIOS and device drivers are posted on the customer support site:
<http://consumersupport.lenovo.com/>.

Strategy for replacing FRUs

Before replacing parts:

Make sure that all software fixes, drivers, and BIOS downloads are installed before replacing any FRUs listed in this manual.

After a system board is replaced, ensure that the latest BIOS is loaded to the system board before completing the service action.

To download software fixes, drivers, and BIOS, follow the steps below:

1. Go to <http://consumersupport.lenovo.com/>.
2. Enter a serial number or select a product or use Lenovo smart downloading.
3. Select the BIOS/Driver/Applications and download.
4. Follow the directions on the screen and install the necessary software.

Use the following strategy to prevent unnecessary expense for replacing and servicing FRUs:

- If you are instructed to replace an FRU, but the replacement does not solve the problem, reinstall the original FRU before you continue.
- Some computers have both a processor board and a system board. If you are instructed to replace either of them, and replacing one of them does not solve the problem, reinstall that board, and then replace the other one.
- If an adapter or a device consists of more than one FRU, any of the FRUs may be the cause of the error. Before replacing the adapter or device, remove the FRUs one by one to see if the symptoms change. Replace only the FRU that changed the symptoms.

Attention: The setup configuration on the computer you are servicing may have been customized. Running Automatic Configuration may alter the settings. Note the current configuration settings (using the View Configuration option); then, when service has been completed, verify that those settings remain in effect.

Important notice for replacing a system board

Some components mounted on a system board are very sensitive. Improper handling can cause damage to those components, and may cause a system malfunction.

Attention: When handling a system board:

- Do not drop the system board or apply any excessive force to it.
- Avoid rough handling of any kind.
- Avoid bending the system board and hard pushing to prevent cracking at each BGA (Ball Grid Array) chipset.

Important information about replacing RoHS compliant FRUs

RoHS, The Restriction of Hazardous Substances in Electrical and Electronic Equipment Directive (2002/95/EC) is a European Union legal requirement affecting the global electronics industry. RoHS requirements must be implemented on Lenovo products placed on the market after June 2006. Products on the market before June 2006 are not required to have RoHS compliant parts. If the original FRU parts are non-compliant, replacement parts can also be non-compliant. In all cases if the original FRU parts are RoHS compliant, the replacement part must also be RoHS compliant.

Note: RoHS and non-RoHS FRU part numbers with the same fit and function are identified with unique FRU part numbers.

Lenovo plans to transit to RoHS compliance well before the implementation date and expects its suppliers to be ready to support Lenovo’s requirements and schedule in the EU. Products sold in 2005 and 2006 will contain some RoHS compliant FRUs. The following statement pertains to these products and any product Lenovo produces containing RoHS compliant FRUs.

RoHS compliant FRUs have unique FRU part numbers. Before or after the RoHS implementation date, failed RoHS compliant parts must always be replaced with RoHS compliant ones, so only the FRUs identified as compliant in the system HMM or direct substitutions for those FRUs may be used.

Products marketed before June 2006		Products marketed after June 2006	
Current or original part	Replacement FRU	Current or original part	Replacement FRU
Non-RoHS	Can be Non-RoHS	Must be RoHS	Must be RoHS
Non-RoHS	Can be RoHS		
Non-RoHS	Can sub to RoHS		
RoHS	Must be RoHS		

Note: A direct substitution is a part with a different FRU part number that is automatically shipped by the distribution center at the time of the order.

General checkout

This chapter presents the following information:

- “What to do first” on page 20
- “Power system checkout” on page 21

Before you go to the checkout, make sure to read the following important notes:

Important notes:

- **Only certified trained personnel can service the computer.**
- **Before replacing any FRU, read the entire page on removing and replacing FRUs.**
- **When you replace FRUs, use new nylon-coated screws.**
- **Be extremely careful during such write operations as copying, saving, or formatting.** Drives in the computer that you are servicing sequence might have been altered. If you select an incorrect drive, data or programs might be overwritten.
- **Replace an FRU only with another FRU of the correct model.** When you replace an FRU, make sure that the machine model and the FRU part number are correct by referring to the FRU parts list.
- **An FRU should not be replaced just because of a single, unreproducible failure.** Single failures can occur for a variety of reasons that have nothing to do with a hardware defect, such as cosmic radiation, electrostatic discharge, or software errors. Consider replacing an FRU only when a problem recurs. If you suspect that an FRU is defective, clear the error logs and run the test again. If the error does not recur, do not replace the FRU.
- **Be careful not to replace a nondefective FRU.**

What to do first

When you do return an FRU, you must include the following information in the parts exchange form or parts return form that you attach to it:

1. Name and phone number of servicer
2. Date of service
3. Date on which the machine failed
4. Date of purchase
5. Procedure index and page number in which the failing FRU was detected
6. Failing FRU name and part number
7. Machine type, model number, and serial number
8. Customer's name and address

Note for warranty: During the warranty period, the customer may be responsible for repair costs if the computer damage was caused by misuse, accident, modification, unsuitable physical or operating environment, or improper maintenance by the customer.

The following is a list of some common items that are not covered under warranty and some symptoms that might indicate that the system was subjected to stress beyond normal use.

Before checking problems with the computer, determine whether the damage is covered under the warranty by referring to the following list:

The following are not covered under warranty:

- LCD panel cracked from the application of excessive force or from being dropped
- Scratched (cosmetic) parts
- Distortion, deformation, or discoloration of the cosmetic parts
- Plastic parts, latches, pins, or connectors that have been cracked or broken by excessive force
- Damage caused by liquid spilled into the system
- Damage caused by the improper insertion of a PC Card or the installation of an incompatible card
- Improper disk insertion or use of an optical drive
- Diskette drive damage caused by pressure on the diskette drive cover, foreign material in the drive, or the insertion of a diskette with multiple labels
- Damaged or bent diskette eject button
- Fuses blown by attachment of a nonsupported device
- Forgotten computer password (making the computer unusable)
- Sticky keys caused by spilling a liquid onto the keyboard
- Use of an incorrect AC adapter on laptop products

The following symptoms might indicate damage caused by nonwarranted activities:

- Missing parts might be a symptom of unauthorized service or modification.
- If the spindle of a hard disk drive becomes noisy, it may have been subjected to excessive force, or dropped.

Power system checkout

To verify a symptom, follow the steps below:

1. Turn off the computer.
2. Remove the battery pack.
3. Connect the AC adapter.
4. Make sure that power is supplied when you turn on the computer.
5. Turn off the computer.
6. Disconnect the AC adapter and install the charged battery pack.
7. Make sure that the battery pack supplies power when you turn on the computer.

If you suspect a power problem, see the appropriate one of the following power supply checkouts:

- “Checking the Computer AC Charger” on page 21
- “Checking the internal battery status” on page 22

Checking the Computer AC Charger

When you use the computer AC Charger to charge the tablet but no power is charged, see the instructions in this topic to check the computer AC Charger.

To check the computer AC Charger, do the following:

1. Disconnect the micro-USB cable from the tablet.
2. Measure the output voltage across the connector marked B of the micro-USB cable. Refer to the following figure:

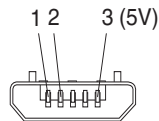

Pin	Voltage (V dc)
1	Ground
2	0
3	+5

Note: The output voltage across pin 3 of the micro-B connector might be different from the one you are servicing.

3. If the voltage is not correct, replace the micro-USB cable.
4. If the voltage is acceptable, replace the system board.

Checking the internal battery status

To check the battery status of the tablet, do either of the following:

- **Approximate information about the battery status**

Get the approximate status of the battery at any time by checking the battery status icon on the system bar in the upper-right corner of the screen. The shorter the green bar is, the less the battery power remains.

- **Accurate information about the battery status**

To get the accurate information about the battery status of the tablet, do the following:

1. Open the Android Settings screen.

To open the Android Settings screen, do either of the following:

- From the main Home screen, touch the Android Settings icon on Lenovo Launch Zone. The Android Settings screen is displayed.
- Pull down the application icon from the action bar and then touch Settings. The Android Settings screen is displayed.

2. Touch Battery in the Device section on the Android Settings screen.

3. The accurate percentage of the remaining battery power is shown on the screen.

Related service information

This chapter presents the following information:

- “Security” on page 23
- “Power management” on page 23

Security

Security settings include: SCREEN SECURITY, SIM CARD LOCK (3G version only), PASSWORDS, DEVICE ADMINISTRATION and CREDENTIAL STORAGE.

Power management

Note: Power management modes are not supported for APM operating system.

To reduce power consumption, the computer has three power management modes: screen blank, sleep (standby), and hibernation.

Activating/Deactivating the Display

With the display deactivated, press the Power button on the computer to activate the display. The computer display will then illuminate, indicating that it has been activated.

If you do not need to use your computer temporarily, you can press the Power button to deactivate the display. Your computer will then enter standby mode to save power.

Lenovo A7600

This chapter presents the following product-specific service references and product-specific parts information:

- “Specifications” on page 24
- “FRU replacement notices” on page 26
- “Removing and replacing an FRU” on page 27
- “Locations” on page 73
- “Parts list” on page 75

Specifications

The following table lists the specifications of the Lenovo A7600 tablet.

Table 1. Specifications

Feature	Description
Size & Weight	
Size	• 264.10mm x 176.54mm x 8.95mm
Weight	• Appr. 550g
System	
CPU	• 1.3GHz, Quad-core
Hardware Platform	• MTK 8382 (3G) / MTK 8121 (WiFi)
RAM	• 1GB
Storage Capacity	• 16GB / 32GB
LCD	• 10.1", 1,280 x 800 pixels
Integrated Camera	• Rear camera, CMOS, 5.0Mega pixels • Front camera, CMOS, 2.0Mega pixels
Battery	• 2-cell lithium battery, 6,340mAh
Operating System	
	• Android 4.2 (free support to one major version upgrade during lifecycle)
Network	
	• WCDMA (HSPA+ 21mb/s), EDGE

Ports	<ul style="list-style-type: none">• Micro-USB (USB 2.0), 5-pin• Earphone, 3.5mm• SIM card slot• T-flash card slot
Communication	<ul style="list-style-type: none">• WiFi, 802.11b/g/n• WiFi Direct• WiFi display• A-GPS (10s fast positioning)• Bluetooth 4.0• FM radio
Others	<ul style="list-style-type: none">• Gravity sensor• Hall sensor• Vibrator• Battery manager

FRU replacement notices

This section presents notices related to removing and replacing parts. Read this section carefully before replacing any FRU.

Screw notices

Loose screws can cause a reliability problem. In Lenovo computers, this problem is addressed with special nylon-coated screws that have the following characteristics:

- They maintain tight connections.
- They do not easily come loose, even with shock or vibration.
- They are harder to tighten.
- Each one should be used only once.

Do the following when you service this machine:

- Keep the screw kit in your tool bag.
- Always use new screws.
- Use a torque screwdriver if you have one.

Tighten screws as follows:

- **Plastic to plastic**

Turn an additional 90° after the screw head touches the surface of the plastic part:

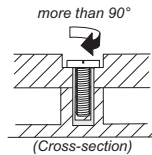

- **Logic card to plastic**

Turn an additional 180° after the screw head touches the surface of the logic card:

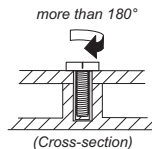

- **Torque driver**

If you have a torque screwdriver, refer to the "Torque" column for each step.

- Make sure that you use the correct screws. If you have a torque screwdriver, tighten all screws firmly to the torque shown in the table. **Never use a screw that you removed. Use a new one. Make sure that all screws are tightened firmly.**
- Ensure torque screwdrivers are calibrated correctly following country specifications.

Removing and replacing an FRU

This section presents exploded figures with the instructions to indicate how to remove and replace the FRU. Make sure to observe the following general rules:

1. Do not attempt to service any computer unless you have been trained and certified. An untrained person runs the risk of damaging parts.
2. Before replacing any FRU, review “FRU replacement notices” on page 26.
3. Begin by removing any FRUs that have to be removed before the failing FRU. Any of such FRUs are listed at the top of the section that describes the detailed removing and replacing procedure for the failing FRU. Remove them in the order in which they are listed.
4. Follow the correct sequence in the steps to remove the FRU, while referring to figures provided in the procedure.
5. When turning a screw to replace an FRU, turn it in the direction as given by the arrow in the figure.
6. When removing the FRU, move it in the direction as given by the arrow in the figure.
7. To put the new FRU in place, reverse the removal procedures and follow any of the notes that pertain to replacement. For information about connecting and arranging internal cables, see “Locations” on page 73.
8. When replacing an FRU, use the correct screw as specified in the procedures.

DANGER

Before removing any FRU, turn off the computer, unplug all power cords from electrical outlets, remove the battery pack, and then disconnect any of the interconnecting cables.

Attention: After replacing an FRU, do not turn on the computer until you have made sure that all screws, springs, and other small parts are in place and none are loose inside the computer. Verify this by shaking the computer gently and listening for rattling sounds. Metallic parts or metal flakes can cause electrical short circuits.

Attention: The system board is sensitive to, and can be damaged by, electrostatic discharge. Before touching it, establish personal grounding by touching a ground point with one hand or using an electrostatic discharge (ESD) strap (P/N 6405959) to remove potential shock reasons.

1010 Rear cover and side keys

1. Open the card slot cover of the tablet using a guitar pick.



Figure 1-1. Opening the card slot cover

2. Remove screw **1** in the card slot recess.



Figure 1-2. The screw in the card slot recess

Part No.	Screw (quantity)	Color	Torque
1	Phillips flat head screw (1)	black	N/A

Note:

The screw is sealed by the manufacturer for checking the warranty qualification of the product.

3. Hold the tablet in one hand and use a guitar pick to unlock the rear cover from the tablet along the joint line as shown in the figure below.

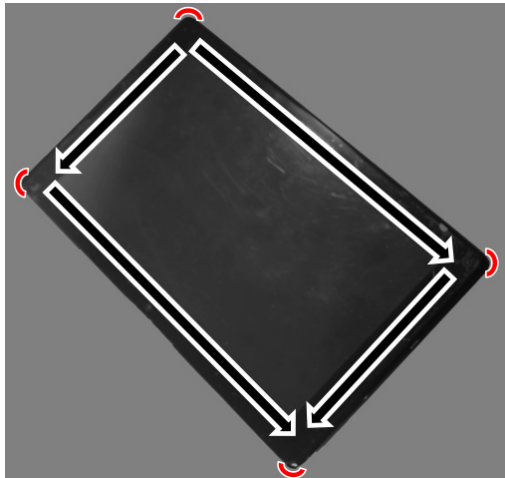

Figure 1-3. Unlocking the rear cover along the joint line

⚠ CAUTION:

Handle with care!

The rear cover can be damaged at its four corners!

Do not cut into the corners of the rear cover using the guitar pick or try to lift the rear cover off the tablet when the locks near the corners have not been disengaged.

4. Remove the rear cover.



Figure 1-4. The removed rear cover

5. Detach the power key from the rear cover using a pair of tweezers.

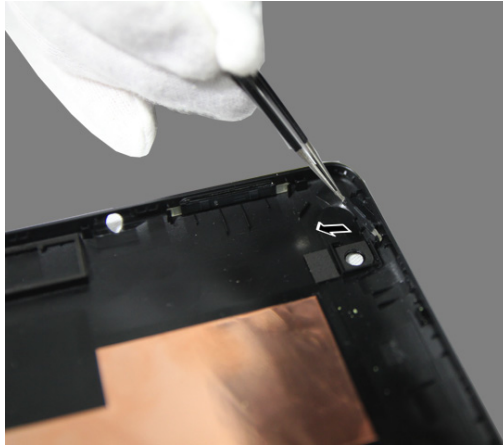

Figure 1-5. Detaching the power key

6. Remove the power key

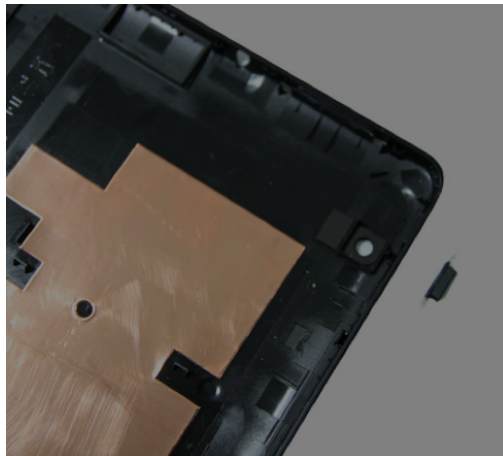

Figure 1-6. The removed power key

7. Detach the volume key from the rear cover using a pair of tweezers.

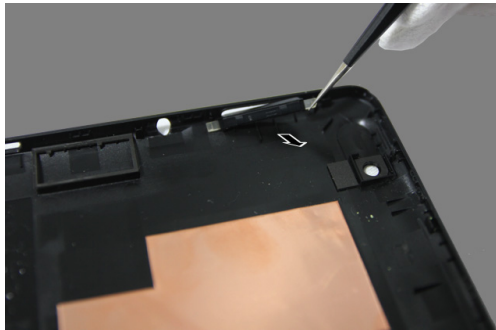

Figure 1-7. Detaching the volume key

8. Remove the volume key.

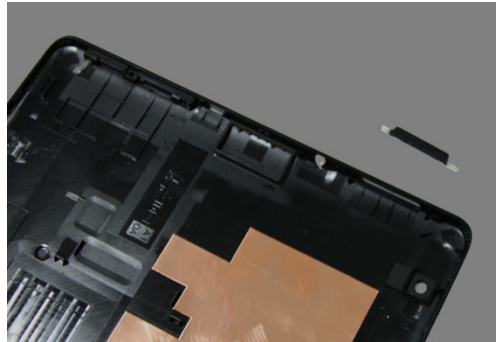

Figure 1-8. The removed volume key

1020 Battery pack

For access, remove the following FRUs:

- “1010 Rear cover and side keys” on page 28

⚠ CAUTION:

Risk of explosion if the battery is replaced with an incorrect type.

When replacing the lithium battery, use only the same or an equivalent type that is recommended by the manufacturer. The battery contains lithium and can explode if not properly used, handled, or disposed of.

Dispose of the used battery according to the instructions. Do not:

- Throw or immerse into water
- Heat to more than 100°C (212°F)
- Repair or disassemble

1. Pull out the plug of the battery pack from its connector on the main board by pulling it on both sides using two pairs of tweezers as shown in the figure below.



Figure 2-1. Pulling out the battery plug

2. Detach the battery pack from its seat by inserting a thin flat blade into the joint surface and then cutting along the joint line in the direction shown in the figure below.



Figure 2-2. Detaching the battery pack

3. Remove the battery pack from the front module of the tablet.

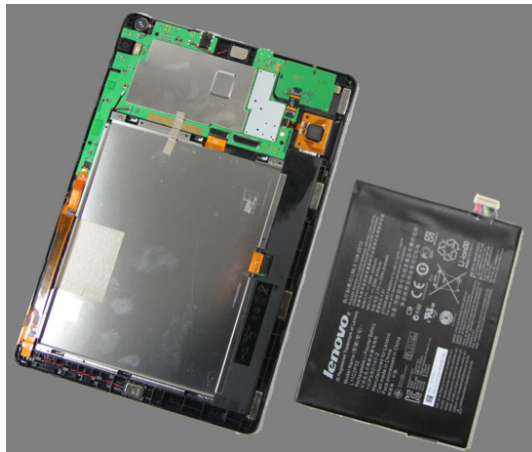

Figure 2-3. The removed battery pack

1030 Battery holder

For access, remove the following FRUs in order:

- “1010 Rear cover and side keys” on page 28
- “1020 Battery pack” on page 33

1. Peel off the conductive fabrics on the battery holder as shown in the figure below.

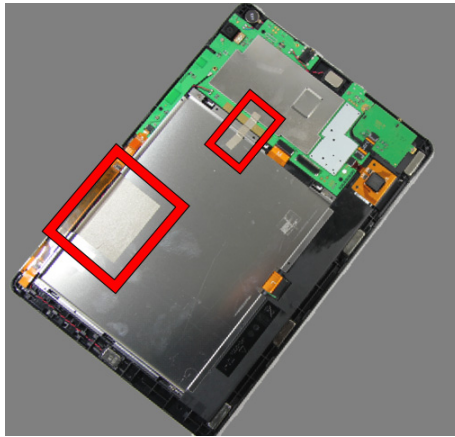

Figure 3-1. The conductive fabrics on the battery holder

2. Remove screws **1** on the battery holder.

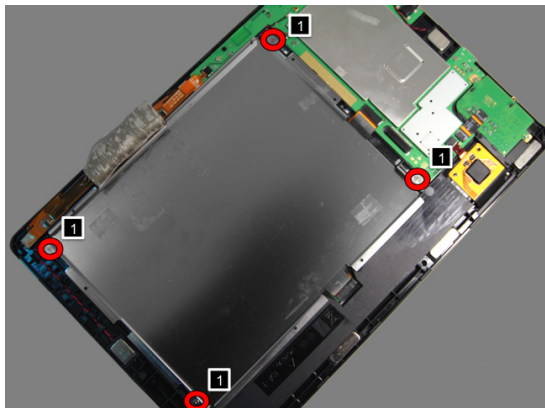

Figure 3-2. The screws on the battery holder

Part No.	Screw (quantity)	Color	Torque
1	Phillips flat head screw (4)	Silver	N/A

3. Remove the battery holder from the front module of the tablet.



Figure 3-3. The removed battery holder

1040 LCM FPC

For access, remove the following FRUs in order:

- “1010 Rear cover and side keys” on page 28
- “1020 Battery pack” on page 33
- “1030 Battery holder” on page 35

1. Peel off the mylar on the LCM FPC connector on the main board.

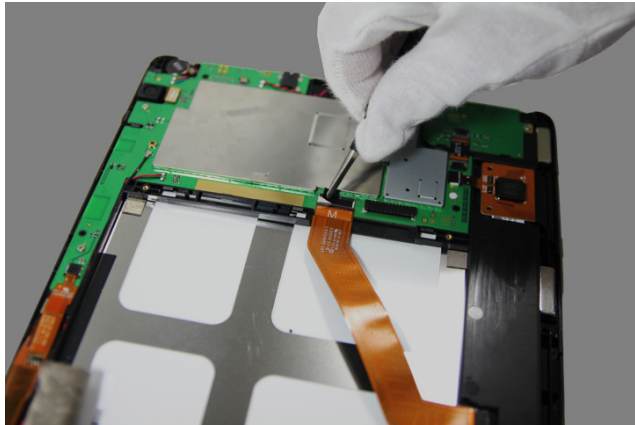

Figure 4-1. Peeling off the mylar

2. Unlock the above-mentioned LCM FPC connector using a guitar pick or a thin flat blade.

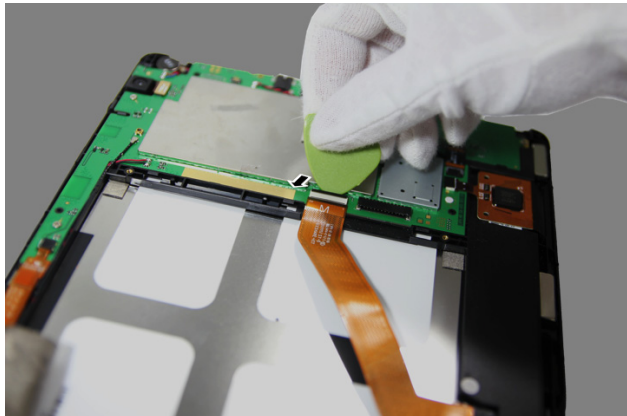

Figure 4-2. Unlocking the LCM FPC connector (on the main board)

3. Pull out the LCM FPC from the unlocked connector using a pair of tweezers.

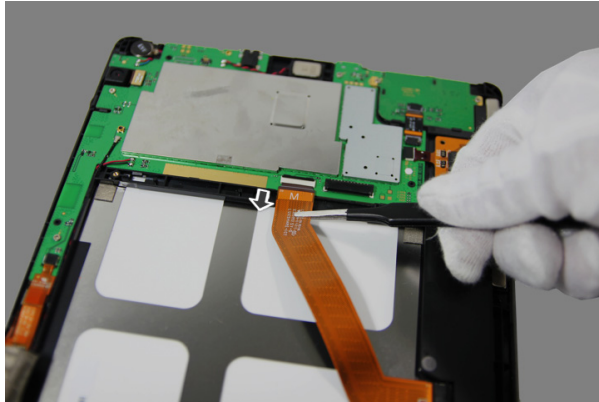

Figure 4-3. Pulling out the LCM FPC

4. Peel off the mylar on the LCM FPC connector on the front module.

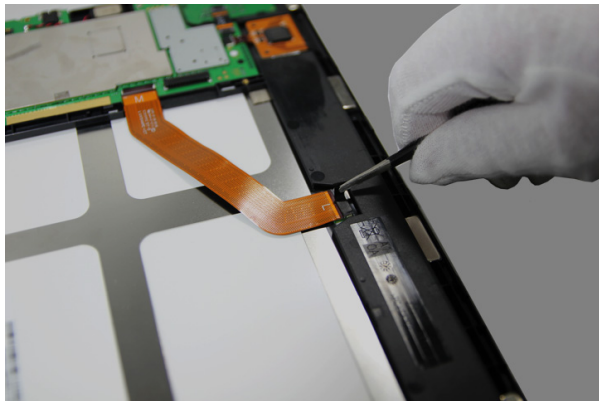

Figure 4-4. Peeling off the mylar

5. Unlock the LCM FPC connector mentioned in Step 4 using a guitar pick or a thin flat blade.

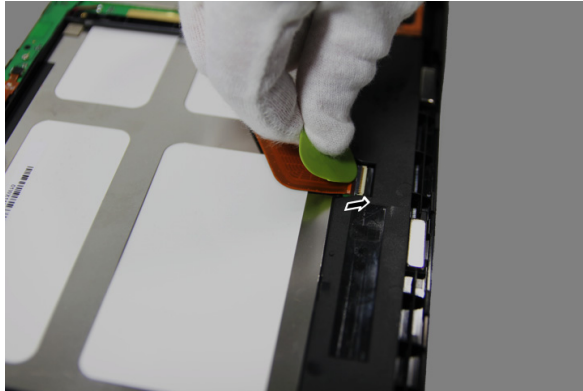

Figure 4-5. Unlocking the LCM FPC connector (on the front module)

6. Pull out the LCM FPC from the unlocked connector using a pair of tweezers.

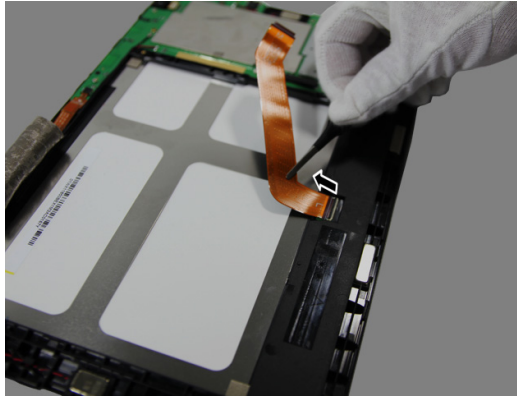

Figure 4-6. Pulling out the LCM FPC

The LCM FPC is now removed.

1050 Rear camera

For access, remove the following FRUs in order:

- “1010 Rear cover and side keys” on page 28
- “1020 Battery pack” on page 33

1. Detach the FPC of the rear camera from its connector on the main board using a thin flat blade or guitar pick.

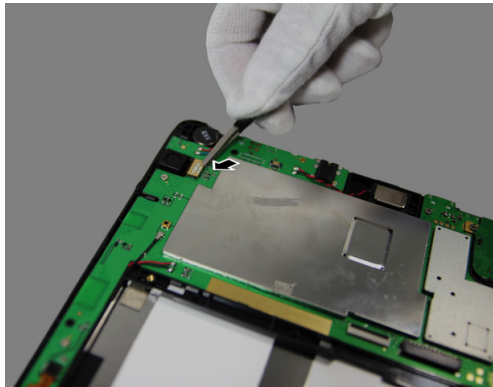

Figure 5-1. Detaching the FPC of the rear camera

2. Remove the rear camera from the tablet.

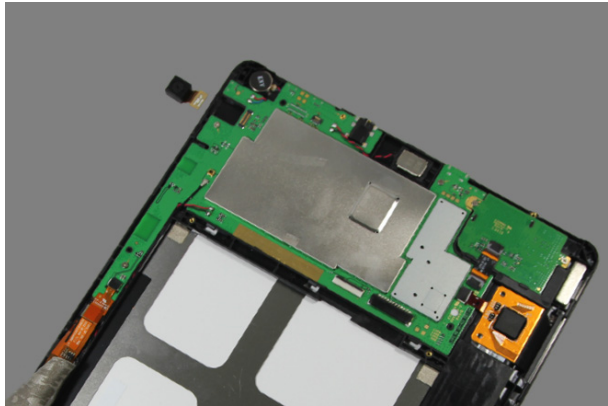
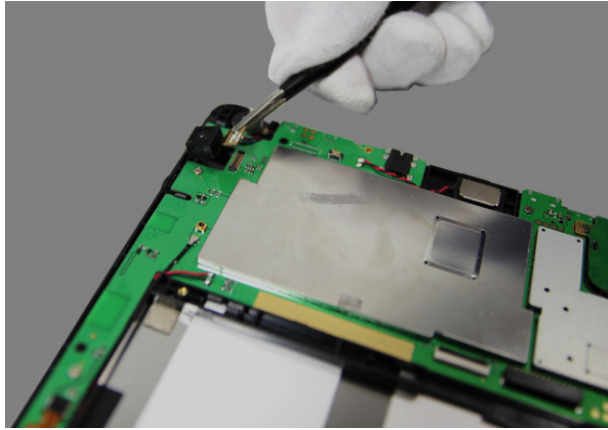

Figure 5-2. Removing the rear camera

1060 Antenna and CAP sensor FPC assembly

For access, remove the following FRUs in order:

- “1010 Rear cover and side keys” on page 28
- “1020 Battery pack” on page 33

1. Peel off the mylar on the CAP sensor FPC connector that is located on the main board.



Figure 6-1. Peeling off the mylar on the CAP sensor FPC connector

2. Unlock the CAP sensor FPC connector using a guitar pick.

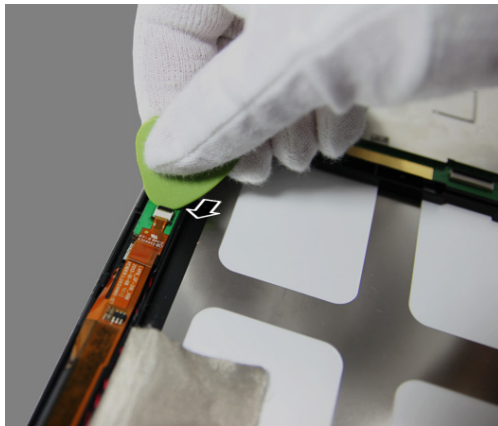

Figure 6-2. Unlocking the CAP sensor FPC connector

3. Pull out the CAP sensor FPC from its connector using a pair of tweezers.

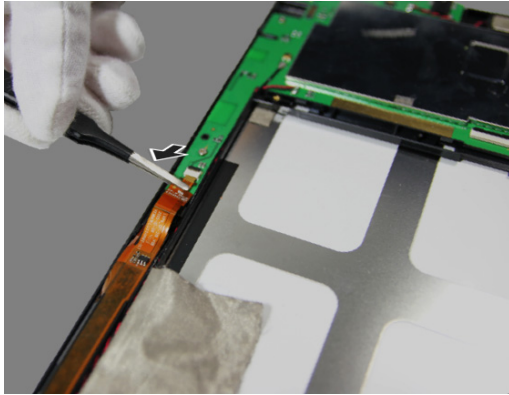

Figure 6-3. Pulling out the CAP sensor FPC

4. Remove screw **1** under the disconnected end of the CAP sensor FPC.

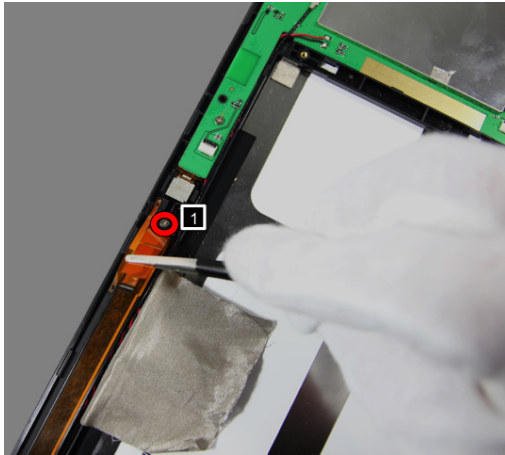

Figure 6-4. The screw under the CAP sensor FPC

Part No.	Screw (quantity)	Color	Torque
1	Phillips flat head screw (1)	Silver	N/A

5. Peel off the other end of the CAP sensor FPC from the antenna box.

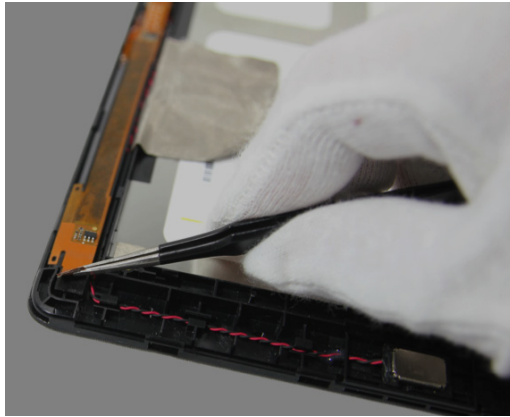

Figure 6-5. Peeling off the other end of the CAP sensor FPC

6. Remove screw **1** under the peeled-off end of the CAP sensor FPC.

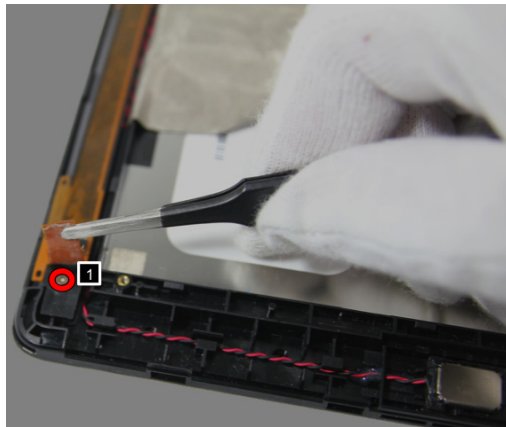

Figure 6-6. The screw under the CAP sensor FPC

Part No.	Screw (quantity)	Color	Torque
1	Phillips flat head screw (1)	Silver	N/A

7. Detach the RF cable from its connector on the main board using a guitar pick.

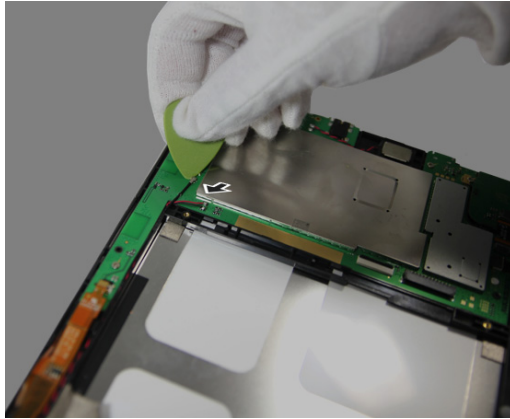

Figure 6-7. Detaching the RF cable

8. Take out the RF cable from the cable duct in the front module of the tablet.



Figure 6-8. Taking out the RF cable from the cable duct

9. Peel off the conductive fabric (shown in figure below) of the antenna from the battery holder.

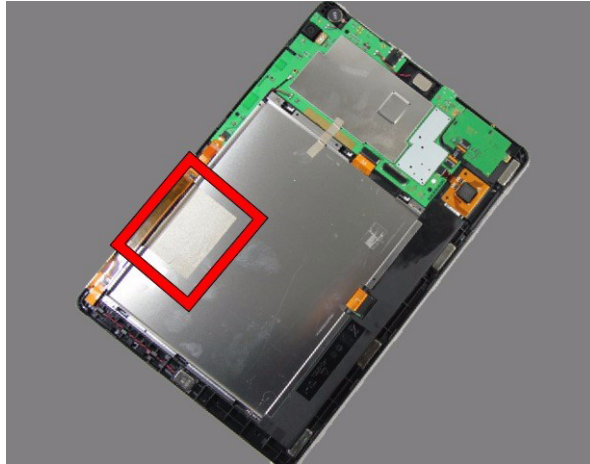

Figure 6-9. The conductive fabric of the antenna

10. Slowly remove the antenna and CAP sensor FPC assembly from the front module while keeping its conductive fabric clear of the cables of the right speaker.

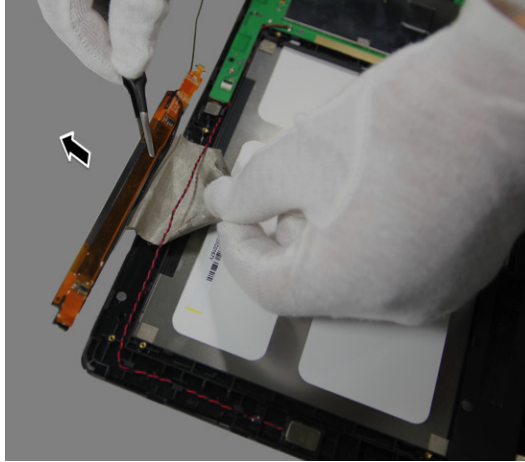

Figure 6-10. Removing the antenna and CAP sensor FPC assembly

The antenna and CAP sensor FPC assembly is now removed.

1070 SIM board FPC

For access, remove the following FRUs in order:

- “1010 Rear cover and side keys” on page 28
- “1020 Battery pack” on page 33

1. Peel off the mylar on the SIM board FPC connector on the SIM board.

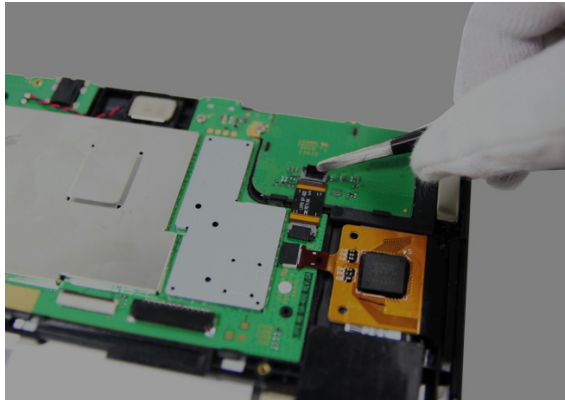

Figure 7-1. Peeling off the mylar at the SIM board end

2. Unlock the above-mentioned SIM board FPC connector using a guitar pick or a thin flat blade.

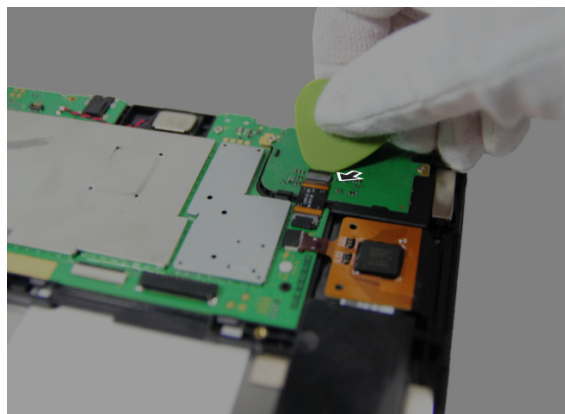

Figure 7-2. Unlocking the SIM board FPC connector (SIM board end)

3. Peel off the mylar on the SIM board FPC connector on the main board.

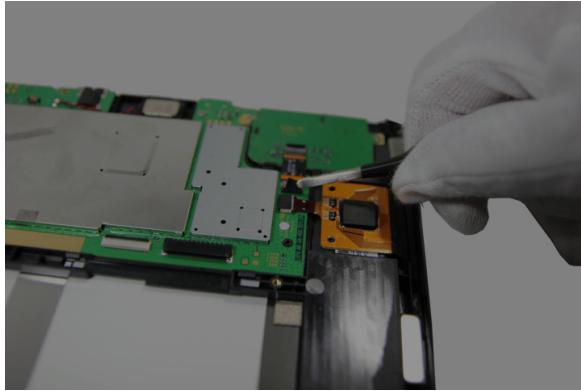

Figure 7-3. Peeling off the mylar at the main board end

4. Unlock the SIM board FPC connector on the main board using a guitar pick or a thin flat blade.

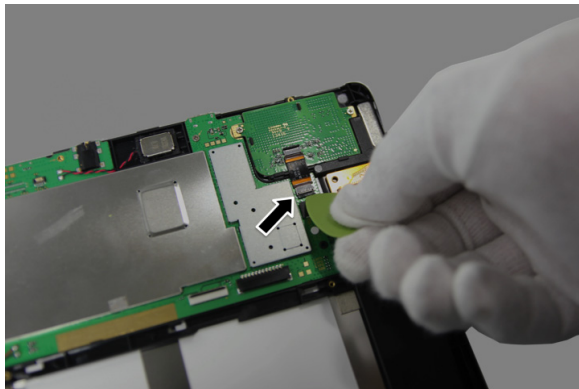

Figure 7-4. Unlocking the SIM board FPC connector (main board end)

5. Pull out the SIM board FPC from both connectors using a pair of tweezers.

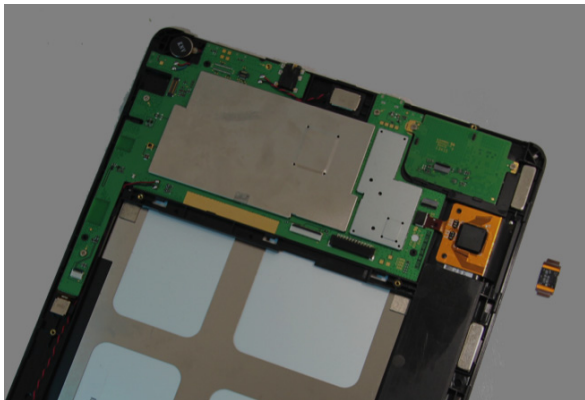
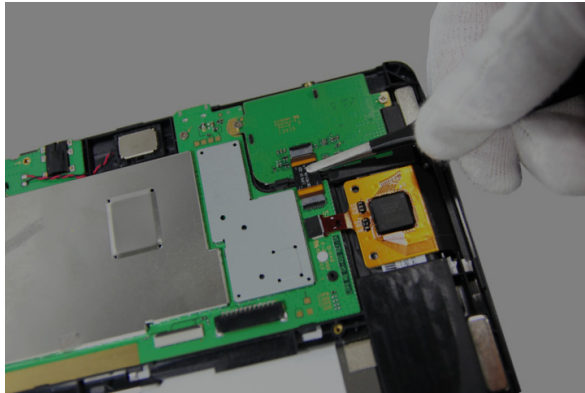

Figure 7-5. Pulling out the SIM board FPC

The SIM board FPC is now removed.

1080 SIM board

Important notices for handling PCB:

When handling PCB, bear the following in mind:

- Be careful not to drop the PCB onto a bench top that has a hard surface, such as surface made of metal, wood, or composite materials.
- Avoid rough handling of any kind.
- Make sure not to drop or stack the PCB in the whole process.
- Make sure to put the PCB only on surface covered with such materials as an ESD mat or conductive corrugated plate.

For access, remove the following FRUs in order:

- “1010 Rear cover and side keys” on page 28
- “1020 Battery pack” on page 33
- “1070 SIM board FPC” on page 49

1. Remove screws **1** on the SIM board.

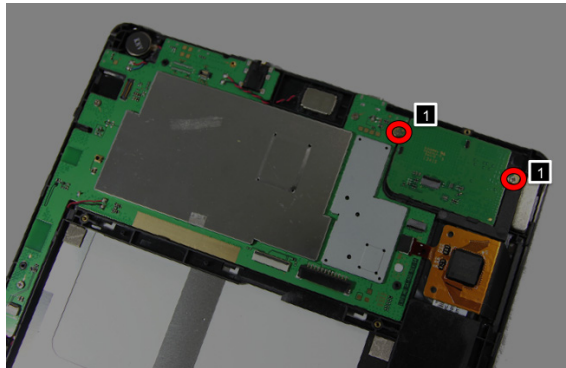

Figure 8-1. The screws on the SIM board

Part No.	Screw (quantity)	Color	Torque
1	Phillips flat head screw (2)	Silver	N/A

2. Remove the SIM board.

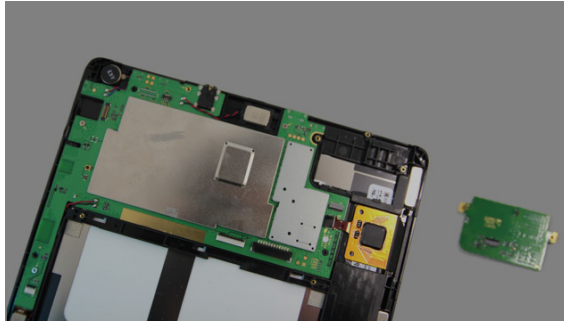

Figure 8-2. The removed SIM board

1090 Main board

Important notices for handling PCB:

When handling PCB, bear the following in mind:

- Be careful not to drop the PCB onto a bench top that has a hard surface, such as surface made of metal, wood, or composite materials.
- Avoid rough handling of any kind.
- Make sure not to drop or stack the PCB in the whole process.
- Make sure to put the PCB only on surface covered with such materials as an ESD mat or conductive corrugated plate.

For access, remove the following FRUs in order:

- “1010 Rear cover and side keys” on page 28
- “1020 Battery pack” on page 33
- “1030 Battery holder” on page 35
- “1040 LCM FPC” on page 37
- “1070 SIM board FPC” on page 49
- “1080 SIM board” on page 52

and

Detach the following FRUs from the main board:

- Rear camera (see Step 1 in “1050 Rear camera” on page 41)
- Antenna and CAP sensor FPC assembly (see Step 1 to 3 and Step 7 in “1060 Antenna and CAP sensor FPC assembly” on page 43)

1. Peel off the mylar on the TP FPC connector on the main board.

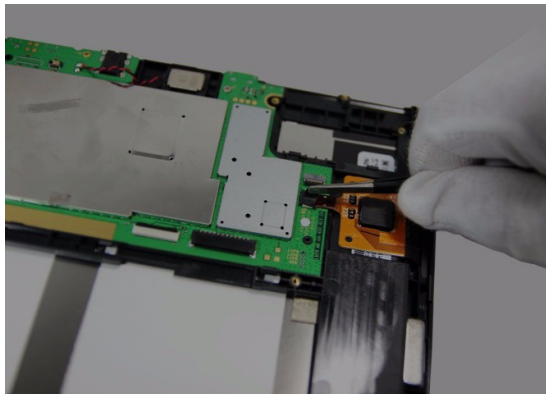

Figure 9-1. Peeling off the mylar on the TP FPC connector

2. Unlock the TP FPC connector using a guitar pick.

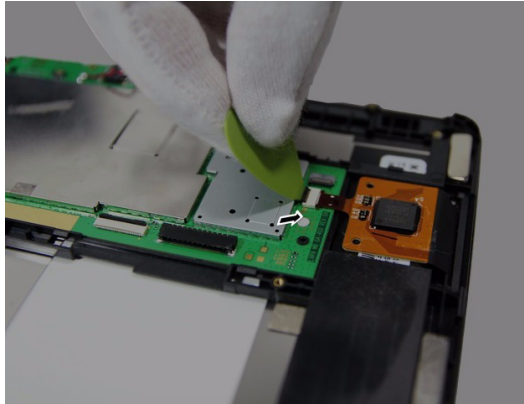

Figure 9-2. Unlocking the TP FPC connector

3. Pull out the TP FPC from its connector using a pair of tweezers.

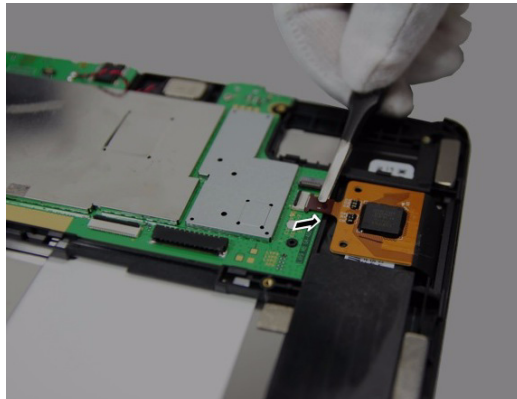

Figure 9-3. Pulling out the TP FPC

4. Desolder the wires of the vibrator motor from the main board at the position shown in the figure below.

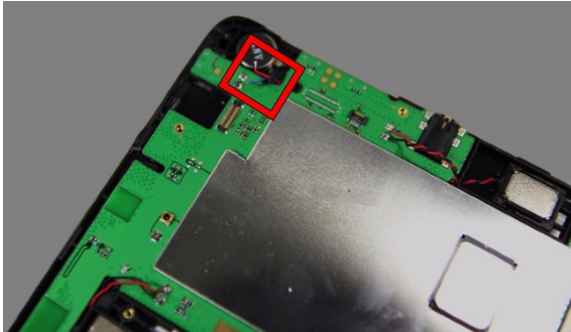
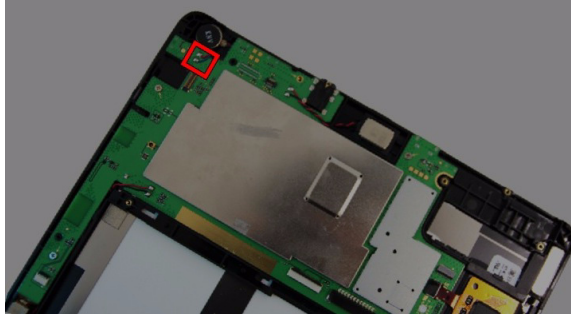

Figure 9-4. Desoldering the wires of the vibrator motor

5. Desolder the wires of the left speaker from the main board at the position shown in the figure below.

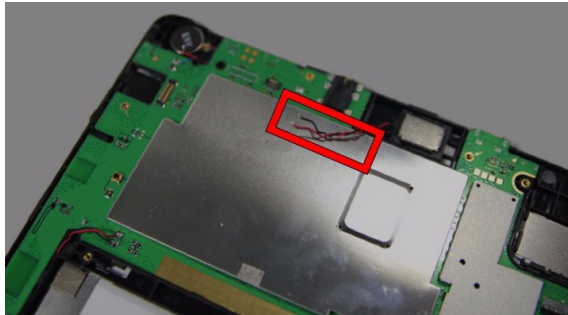
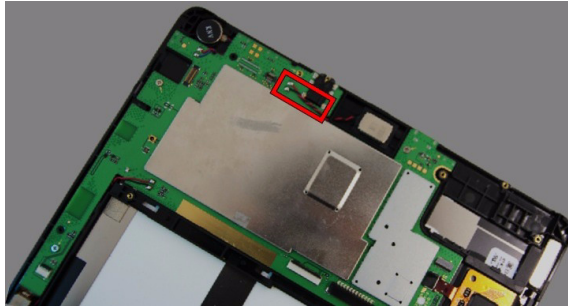

Figure 9-5. Desoldering the wires of the left speaker

6. Desolder the wires of the right speaker from the main board at the position shown in the figure below.

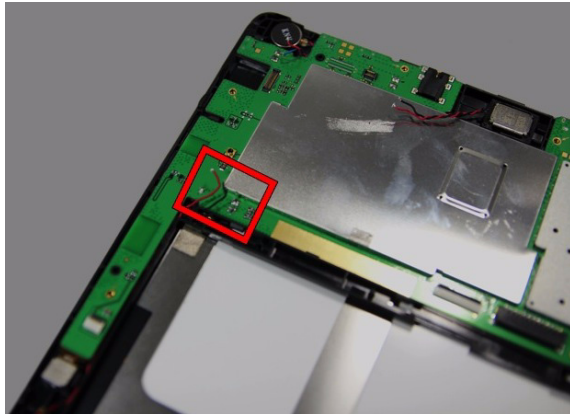
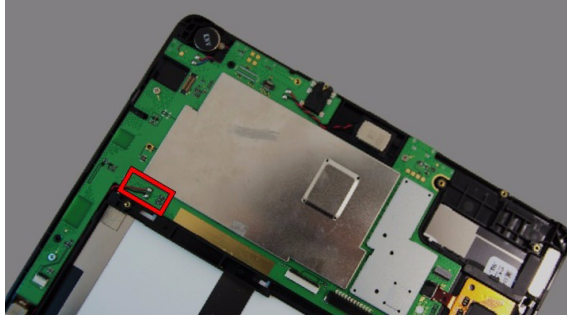

Figure 9-6. Desoldering the wires of the right speaker

7. Remove screws **1** on the main board.

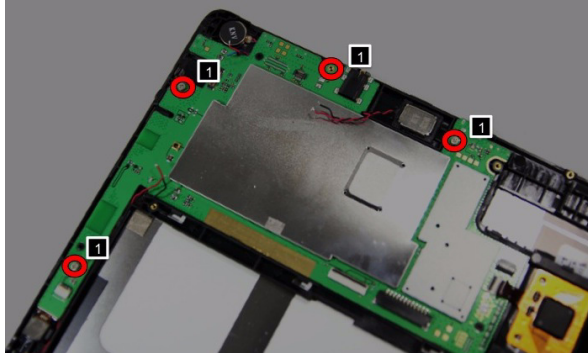

Figure 9-7. The screws on the main board

Part No.	Screw (quantity)	Color	Torque
1	Phillips flat head screw (4)	Silver	N/A

8. Release the main board from the lock at the position shown in the figure below.

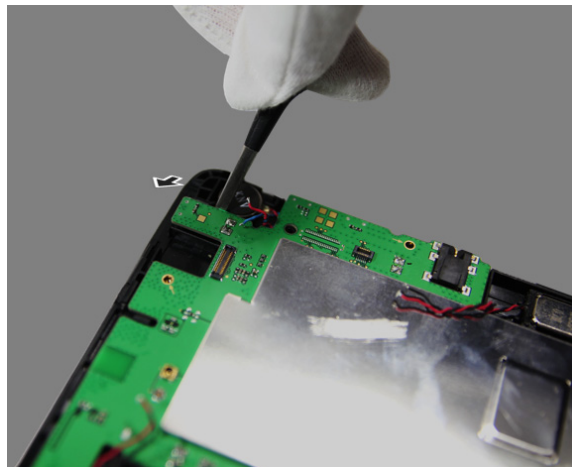

Figure 9-8. Releasing the lock of the main board (first place)

9. Release the main board from another lock at the position shown in the figure below.

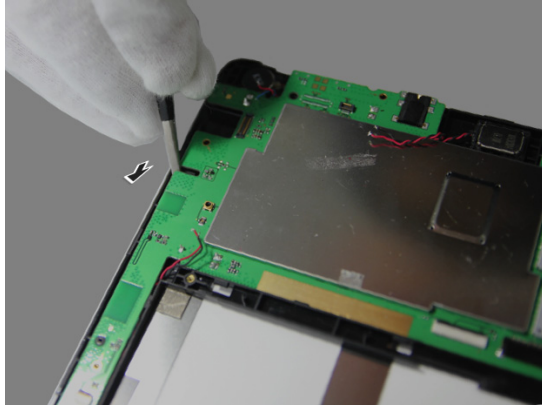

Figure 9-9. Releasing the lock of the main board (second place)

10. Lift the main board on the top side and then remove it from the front module in the direction shown in the figure below.

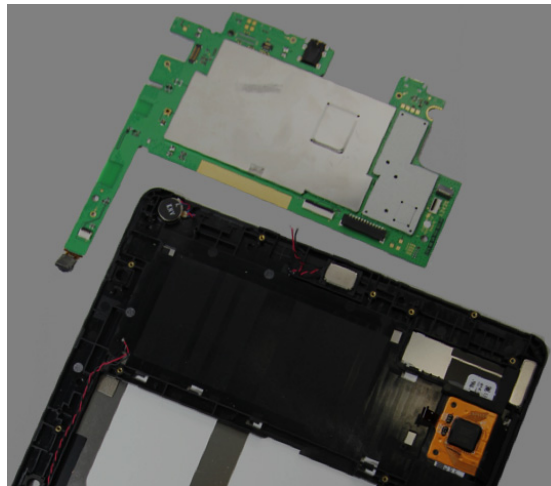
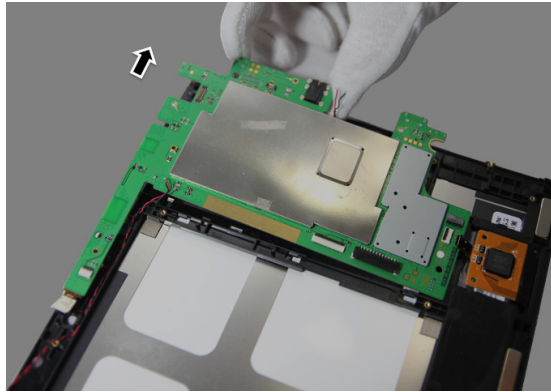

Figure 9-10. Removing the main board

11. Turn over the main board and then peel off the mylar on FPC connector of the front camera.

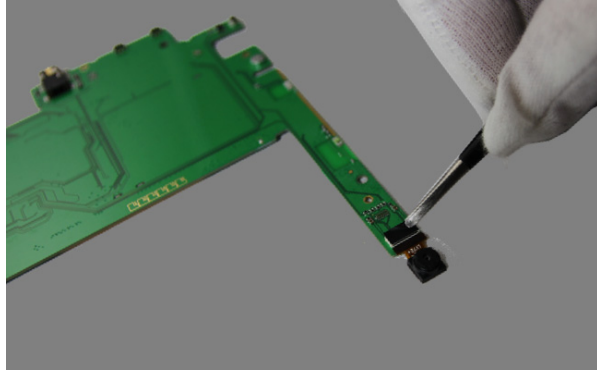

Figure 9-11. Peeling off the mylar on the FPC connector

12. Unlock the FPC connector of the front camera using a guitar pick.

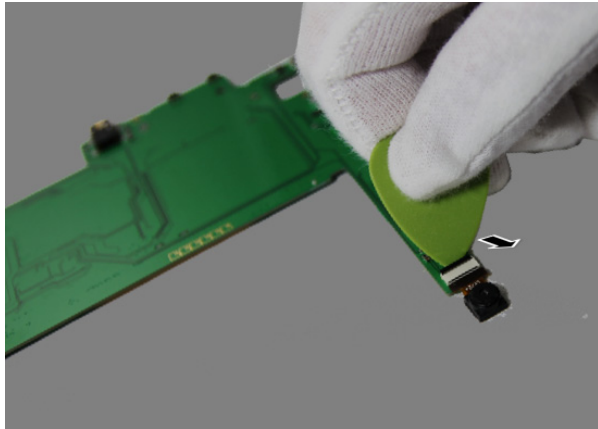

Figure 9-12. Unlocking the FPC connector of the front camera

13. Pull out the front camera from its connector using a pair of tweezers.

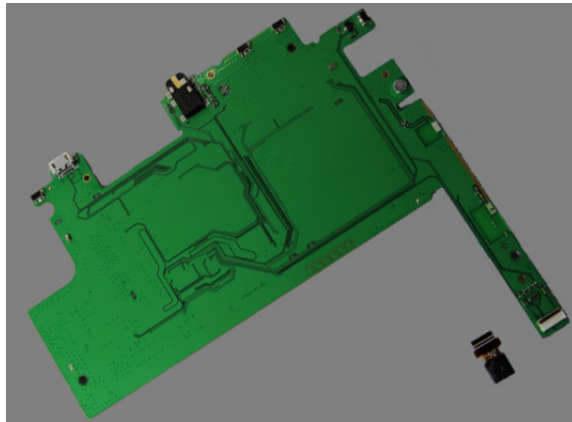
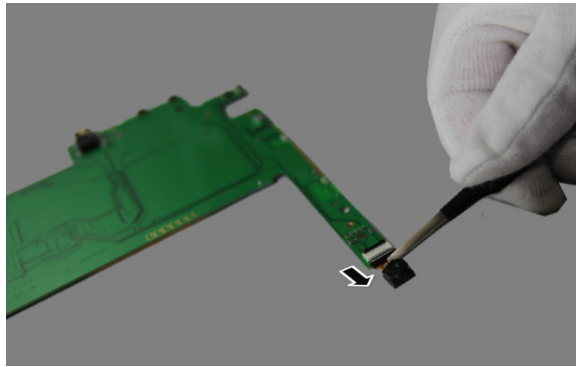

Figure 9-13. Pulling out the front camera

The main board is now separated from other components and removed from the tablet.

1100 Front camera

The procedure for removing the front camera is the same as that of the main board.

Please refer to “1090 Main board” on page 54.

1110 Vibrator motor

For access, remove the following FRUs in order:

- “1010 Rear cover and side keys” on page 28
- “1020 Battery pack” on page 33

1. Desolder the wires of the vibrator motor as described in Step 4 on page 56 in “1090 Main board”.
2. Detach the vibrator motor from its seat on the front module of the tablet using a thin flat blade.

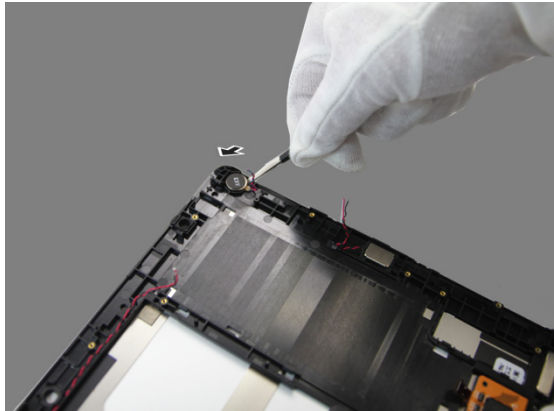

Figure 11-1 Detaching the vibrator motor

3. Remove the vibrator motor.

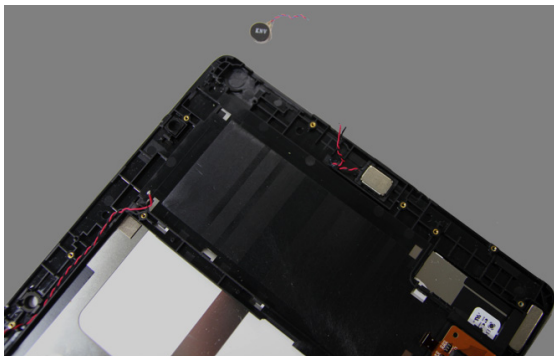

Figure 11-2 The removed vibrator motor

1120 Left speaker

For access, remove the following FRUs in order:

- “1010 Rear cover and side keys” on page 28
- “1020 Battery pack” on page 33
- “1030 Battery holder” on page 35
- “1040 LCM FPC” on page 37
- “1070 SIM board FPC” on page 49
- “1080 SIM board” on page 52

and

Detach the following FRUs in order:

- Rear camera (see Step 1 in “1050 Rear camera” on page 41)
- Antenna and CAP sensor FPC assembly (see Step 1 to 3 and Step 7 in “1060 Antenna and CAP sensor FPC assembly” on page 43)
- Main board with the front camera (see Step 1 to 10 in “1090 Main board” on page 54)

1. Remove the glue that is used to fix the wires of the left speaker using a thin flat blade.

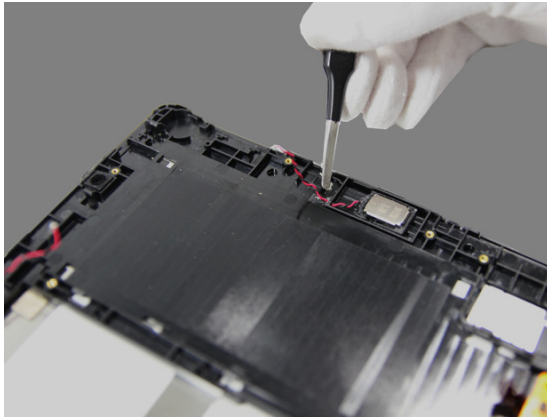

Figure 12-1 Removing the glue (left speaker)

2. Detach the left speaker from its seat on the front module of the tablet using a thin flat blade.

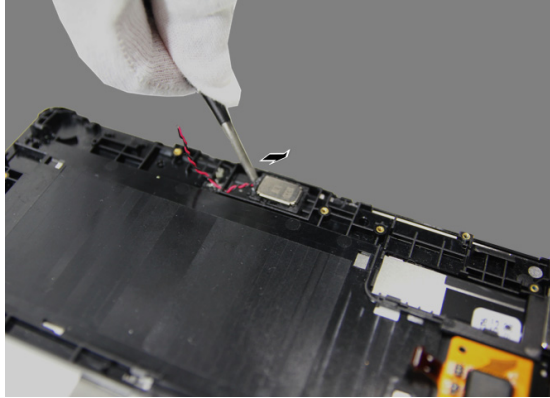

Figure 12-2 Detaching the left speaker

3. Slowly pull out the wires of the left speaker through the hole in the front module.



Figure 12-3 Pulling out the wires of the left speaker

4. Remove the left speaker.

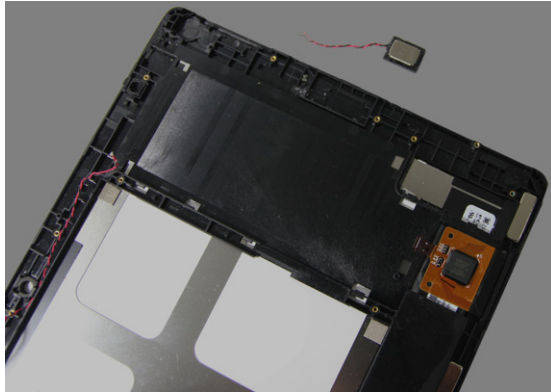

Figure 12-4 The removed left speaker

1130 Right speaker

For access, remove the following FRUs in order:

- “1010 Rear cover and side keys” on page 28
- “1020 Battery pack” on page 33
- “1030 Battery holder” on page 35
- “1040 LCM FPC” on page 37
- “1070 SIM board FPC” on page 49
- “1080 SIM board” on page 52

and

Detach the following FRUs in order:

- Rear camera (see Step 1 in “1050 Rear camera” on page 41)
- Antenna and CAP sensor FPC assembly (see Step 1 to 3 and Step 7 in “1060 Antenna and CAP sensor FPC assembly” on page 43)
- Main board with the front camera (see Step 1 to 10 in “1090 Main board” on page 54)

1. Slowly take out the wires of the right speaker from the wire duct in the front module.

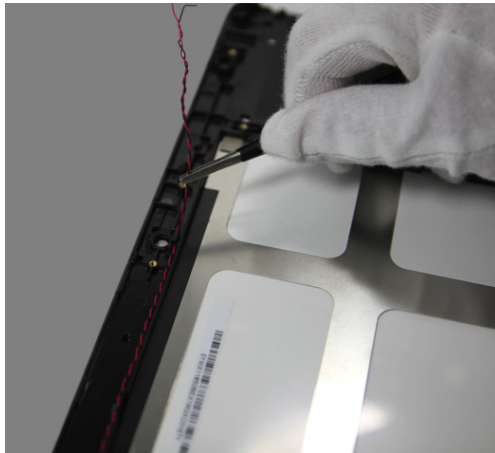

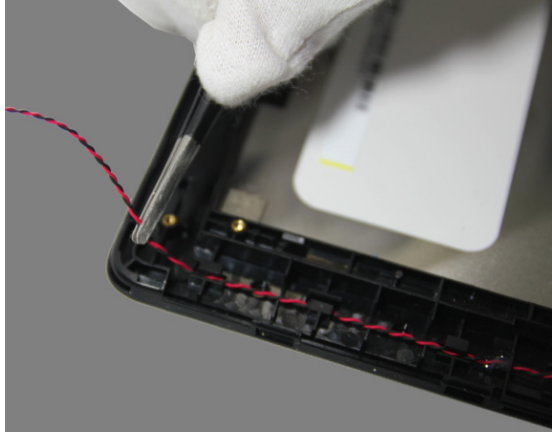

Figure 13-1 Taking out the wires from the wire duct

2. Remove the glue that is used to fix the wires of the right speaker using a thin flat blade.

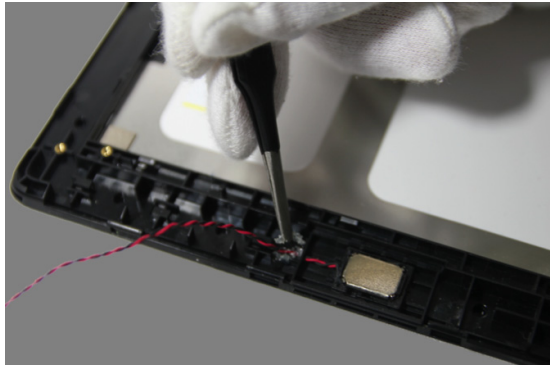

Figure 13-2 Removing the glue (right speaker)

3. Detach the right speaker from its seat on the front module of the tablet using a thin flat blade.

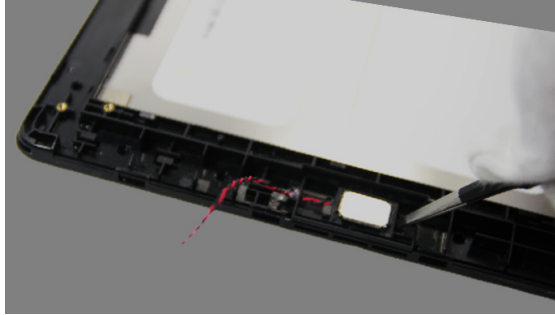

Figure 13-3 Detaching the right speaker

4. Slowly pull out the wires of the right speaker through the hole in the front module.

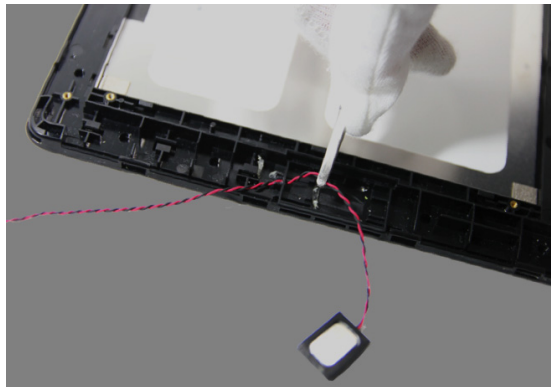

Figure 13-4 Pulling out the wires of the right speaker

5. Remove the right speaker.



Figure 13-5 The removed right speaker

Locations

Front view

- 1** Left speaker
- 2** Front camera
- 3** Right speaker



Rear view

- 4** Microphone
- 5** Rear camera
- 6** Power key
- 7** Volume key
- 8** Earphone socket
- 9** Micro-USB connection
- 10** SIM card slot
- 11** T-flash card slot



Parts list

This section presents the following service parts:

- “Overall” on page 75
- “Screw” on page 77

Overall

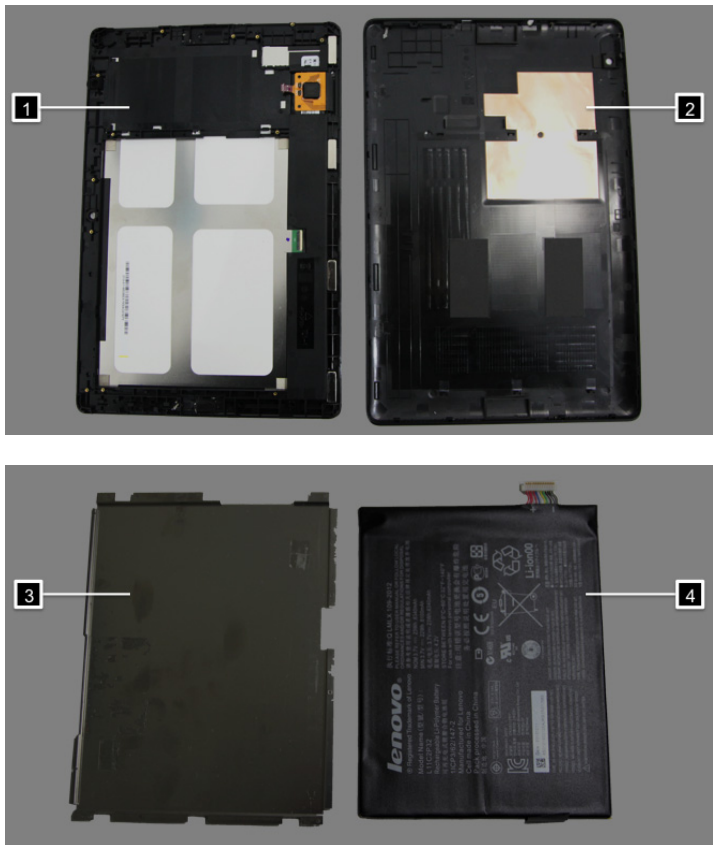

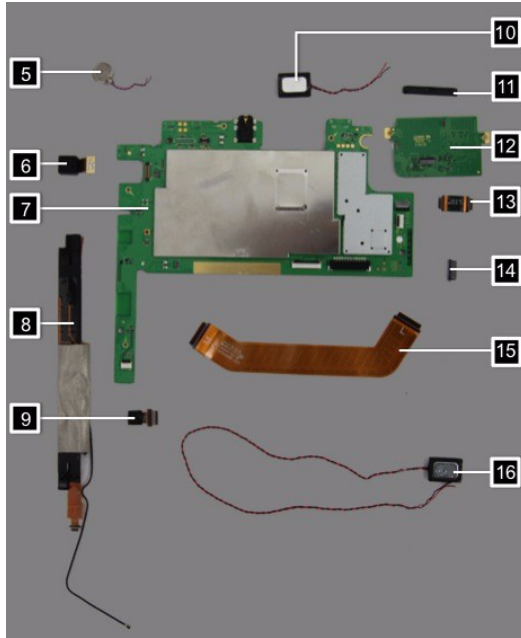

Table 1. Parts list—Overall

No.	FRU	FRU No.	CRU ID
1	A7600 front module (TP LCM assembly)	5D69A6MVWR	N
2	A7600 rear cover	5SR9A6MVXJ	N
3	A7600 battery holder	5M89A6MVX2	N
4	A7600 battery pack	5B19A4657R	N
5	A7600 vibrator motor	5M79A6MVWV	N
6	A7600 rear camera	5C29A4679V	N
7	A7600 main board	5B29A6MVWP	N
8	A7600 antenna and CAP sensor FPC assembly	5A39A6MVWX	N
9	A7600 front camera	5C29A6MVWW	N
10	A7600 left speaker	5B9A6MVXG	N
11	A7600 volume key	5B69A6MVXC	N
12	A7600 SIM board	5P69A6MVWS	N
13	A7600 SIM board FPC	5F79A6MVWT	N
14	A7600 power key	5B69A6MVXB	N
15	A7600 LCM FPC	5F79A6MVWU	N
16	A7600 right speaker	5B9A6MVXH	N

Screw

Table 2. Parts list—Screw

FRU	P/N	CRU ID
Phillips flat head screw, black	5M89A6MVWA	N
Phillips flat head screw, silver	5M89A6MVXD	N

Notices

Lenovo may not offer the products, services, or features discussed in this document in all countries. Consult your local Lenovo representative for information on the products and services currently available in your area. Any reference to a Lenovo product, program, or service is not intended to state or imply that only that Lenovo product, program, or service may be used. Any functionally equivalent product, program, or service that does not infringe any Lenovo intellectual property right may be used instead. However, it is the user's responsibility to evaluate and verify the operation of any other product, program, or service.

Lenovo may have patents or pending patent applications covering subject matter described in this document. The furnishing of this document does not give you any license to these patents.

LENOVO GROUP LTD. PROVIDES THIS PUBLICATION "AS IS" WITHOUT WARRANTY OF ANY KIND, EITHER EXPRESS OR IMPLIED, INCLUDING, BUT NOT LIMITED TO, THE IMPLIED WARRANTIES OF NON-INFRINGEMENT, MERCHANTABILITY OR FITNESS FOR A PARTICULAR PURPOSE. Some jurisdictions do not allow disclaimer of express or implied warranties in certain transactions, therefore, this statement may not apply to you.

This information could include technical inaccuracies or typographical errors. Changes are periodically made to the information herein; these changes will be incorporated in new editions of the publication. Lenovo may make improvements and/or changes in the product(s) and/or the program(s) described in this publication at any time without notice.

The products described in this document are not intended for use in implantation or other life support applications where malfunction may result in injury or death to persons. The information contained in this document does not affect or change Lenovo product specifications or warranties. Nothing in this document shall operate as an express or implied license or indemnity under the intellectual property rights of Lenovo or third parties. All information contained in this document was obtained in specific environments and is presented as an illustration. The result obtained in other operating environments may vary.

Lenovo may use or distribute any of the information you supply in any way it believes appropriate without incurring any obligation to you.

Any references in this publication to non-Lenovo Web sites are provided for convenience only and do not in any manner serve as an endorsement of those Web sites. The materials at those Web sites are not part of the materials for this Lenovo product, and use of those Web sites is at your own risk.

Any performance data contained herein was determined in a controlled environment. Therefore, the result obtained in other operating environments may vary significantly. Some measurements may have been made on development-level systems and there is no guarantee that these measurements will be the same on generally available systems. Furthermore, some measurements may have been estimated through extrapolation. Actual results may vary. Users of this document should verify the applicable data for their specific environment.

Trademarks

Lenovo and the Lenovo logo are trademarks of Lenovo in the United States or other countries, or both.

Other company, product, or service names may be trademarks or service marks of others.