

ServSwitch DKM Compact Extenders

Increase the distance between a source (computer, CPU) and its console (keyboard, monitor, mouse, and other peripheral devices).

Models available for CATx or fiber.



Contact Information

Order toll-free in the U.S. or for FREE 24/7 Technical Support: Call 877-877-BBOX
(outside U.S. call 724-746-5500)
www.blackbox.com • info@blackbox.com

Trademarks Used in this Manual

Trademarks Used in this Manual

Black Box and the Double Diamond logo are registered trademarks, and ServSwitch is a trademark, of BB Technologies, Inc.

Mac is a registered trademark of Apple Inc.

TOSLINK is a registered trademark of Toshiba Corp.

Any other trademarks mentioned in this manual are acknowledged to be the property of the trademark owners.

We're here to help! If you have any questions about your application or our products, contact Black Box Tech Support at **724-746-5500** or go to **blackbox.com** and click on "Talk to Black Box." You'll be live with one of our technical experts in less than 30 seconds.

Federal Communications Commission and Industry Canada Radio Frequency Interference Statements

This equipment generates, uses, and can radiate radio-frequency energy, and if not installed and used properly, that is, in strict accordance with the manufacturer's instructions, may cause interference to radio communication. It has been tested and found to comply with the limits for a Class A computing device in accordance with the specifications in Subpart B of Part 15 of FCC rules, which are designed to provide reasonable protection against such interference when the equipment is operated in a commercial environment. Operation of this equipment in a residential area is likely to cause interference, in which case the user at his own expense will be required to take whatever measures may be necessary to correct the interference.

Changes or modifications not expressly approved by the party responsible for compliance could void the user's authority to operate the equipment.

This digital apparatus does not exceed the Class A limits for radio noise emission from digital apparatus set out in the Radio Interference Regulation of Industry Canada.

Le présent appareil numérique n'émet pas de bruits radioélectriques dépassant les limites applicables aux appareils numériques de la classe A prescrites dans le Règlement sur le brouillage radioélectrique publié par Industrie Canada.

WEEE

The manufacturer complies with the EC Directive 2002/96/EG on the prevention of waste electrical and electronic equipment (WEEE). The device labels carry a respective marking.

RoHS

This device complies with the EC Directive 2002/95/EG on the Restriction of the use of certain Hazardous Substances in electrical and electronic equipment (RoHS).

Instrucciones de Seguridad (Normas Oficiales Mexicanas Electrical Safety Statement)

1. Todas las instrucciones de seguridad y operación deberán ser leídas antes de que el aparato eléctrico sea operado.
2. Las instrucciones de seguridad y operación deberán ser guardadas para referencia futura.
3. Todas las advertencias en el aparato eléctrico y en sus instrucciones de operación deben ser respetadas.
4. Todas las instrucciones de operación y uso deben ser seguidas.
5. El aparato eléctrico no deberá ser usado cerca del agua—por ejemplo, cerca de la tina de baño, lavabo, sótano mojado o cerca de una alberca, etc.
6. El aparato eléctrico debe ser usado únicamente con carritos o pedestales que sean recomendados por el fabricante.
7. El aparato eléctrico debe ser montado a la pared o al techo sólo como sea recomendado por el fabricante.
8. Servicio—El usuario no debe intentar dar servicio al equipo eléctrico más allá a lo descrito en las instrucciones de operación. Todo otro servicio deberá ser referido a personal de servicio calificado.
9. El aparato eléctrico debe ser situado de tal manera que su posición no interfiera su uso. La colocación del aparato eléctrico sobre una cama, sofá, alfombra o superficie similar puede bloquea la ventilación, no se debe colocar en libreros o gabinetes que impidan el flujo de aire por los orificios de ventilación.
10. El equipo eléctrico debe ser situado fuera del alcance de fuentes de calor como radiadores, registros de calor, estufas u otros aparatos (incluyendo amplificadores) que producen calor.
11. El aparato eléctrico deberá ser conectado a una fuente de poder sólo del tipo descrito en el instructivo de operación, o como se indique en el aparato.
12. Precaución debe ser tomada de tal manera que la tierra física y la polarización del equipo no sea eliminada.
13. Los cables de la fuente de poder deben ser guiados de tal manera que no sean pisados ni pellizcados por objetos colocados sobre o contra ellos, poniendo particular atención a los contactos y receptáculos donde salen del aparato.
14. El equipo eléctrico debe ser limpiado únicamente de acuerdo a las recomendaciones del fabricante.
15. En caso de existir, una antena externa deberá ser localizada lejos de las líneas de energía.
16. El cable de corriente deberá ser desconectado del cuando el equipo no sea usado por un largo periodo de tiempo.
17. Cuidado debe ser tomado de tal manera que objetos líquidos no sean derramados sobre la cubierta u orificios de ventilación.
18. Servicio por personal calificado deberá ser provisto cuando:
 - A: El cable de poder o el contacto ha sido dañado; u
 - B: Objetos han caído o líquido ha sido derramado dentro del aparato; o
 - C: El aparato ha sido expuesto a la lluvia; o
 - D: El aparato parece no operar normalmente o muestra un cambio en su desempeño; o
 - E: El aparato ha sido tirado o su cubierta ha sido dañada.

Safety Instructions

To ensure reliable and safe long-term operation of your DKM Compact Extender, please note the following guidelines:

Installation

- Only use in dry, indoor environments.
- The DKM Compact Extender and the power supply units can get warm. Do not situate them in an enclosed space without any airflow.
- Do not place the power supply directly on top of the device.
- Do not obscure ventilation holes.
- Only use power supplies originally supplied with the product or manufacturer-approved replacements. Do not use a power supply if it appears to be defective or has a damaged case.
- Connect all power supplies to grounded outlets. In each case, make sure that the ground connection is maintained from the outlet socket through to the power supply's AC power input.
- Do not connect the link interface to any other equipment, particularly network or telecommunications equipment.
- Take any required ESD precautions.

Repair

- Do not attempt to open or repair a power supply unit.
- Do not attempt to open or repair the DKM Compact Extender. There are no user-serviceable parts inside.
- If there is a fault, contact Black Box Technical Support at 724-746-5500 or info@blackbox.com.

Table of Contents

Contents

1. Specifications.....	8
1.1 Interfaces.....	8
1.1.1 DVI-D Single Link.....	8
1.1.2 DVI-I Single Link.....	8
1.1.3 USB-HID.....	8
1.1.4 USB 2.0 (transparent).....	8
1.1.5 RJ-45 (Interconnect).....	8
1.1.6 Fiber SFP Type LC (Interconnect).....	9
1.1.7 Serial Interface.....	9
1.1.8 Analog Audio Interface.....	9
1.1.9 Digital Audio Interface.....	10
1.2 Interconnect Cable.....	11
1.2.1 CATx.....	11
1.2.2 Fiber.....	12
1.3 Supported Peripherals.....	13
1.3.1 USB-HID Devices.....	13
1.3.2 USB 2.0 Devices.....	13
1.4 Connector Pinouts.....	13
1.5 Power Supply.....	18
1.6 Environmental Conditions.....	18
1.7 Size.....	18
1.8 Shipping Weight.....	18
2. Overview.....	19
2.1 Application.....	19
2.2 System Overview.....	19
2.3 Product Range.....	20
2.3.1 DKM Compact Transmitter and Receiver Units (CATx).....	20
2.3.2 DKM Compact Transmitter and Receiver Units (Fiber).....	21
2.3.3 Upgrade Kits.....	21
2.3.4 Accessories.....	22
2.4 Device Views.....	22
2.4.1 ACX1T-11-C/ACX1R-11-C (Single-Head, CATx).....	22
2.4.2 ACX1T-11-SM/ACX1R-11-SM (Single-Head, Fiber).....	23
2.4.3 ACX1T-12A-C/ACX1R-12A-C (Analog Audio/Serial, CATx).....	24
2.4.4 ACX1T-12A-SM/ACX1R-12A-SM (Analog Audio/Serial, Fiber).....	25
2.4.5 ACX1T-12D-C/ACX1R-12D-C (Digital Audio, CATx).....	26
2.4.6 ACX1T-12D-SM/ACX1R-12D-SM (Digital Audio, Fiber).....	27
2.4.7 ACX1T-13-C/ACX1R-13-C (USB 2.0 CATx).....	28
2.4.8 ACX1T-13-SM/ACX1R-13-SM (USB 2.0 Fiber).....	29
2.4.9 ACX1T-11V-C/ACX1R-11V-C (CATx with VGA).....	30
2.4.10 ACX1T-11V-SM/ACX1R-11V-SM (Fiber with VGA).....	31
2.4.11 ACX1T-22-C/ACX1R-22-C (Dual-Head CATx).....	32
2.4.12 ACX1T-22-SM/ACX1R-22-SM (Dual-Head Fiber).....	33
2.5 Status LEDs.....	34
2.5.1 Status Digital Audio (Option).....	35
2.5.2 Status USB-HID Add-On (Option).....	36
2.5.3 Status USB 2.0 (Option).....	37
2.5.4 Status VGA/DVI-I (Option).....	38

3. Installation	39
3.1 Package Contents.....	39
3.2 System Setup.....	40
3.2.1 KVM Extender Setup.....	40
3.2.2 Setup of Optional Modules.....	41
3.3 Example Applications	42
4. Configuration	44
4.1 Transmission Parameters.....	44
4.2 DDC Settings.....	44
4.3 Command Mode.....	44
5. Operation	46
6. Troubleshooting	47
6.1 Blank Screen.....	47
6.2 USB-HID	48
6.3 Serial Connection	49
6.4 Analog Audio.....	49
6.5 Digital Audio	50
6.6 USB-HID Add-On.....	51
6.7 USB 2.0 Upgrade Module	52
7. Technical Support.....	53
7.1 Contacting Black Box.....	53
7.2 Shipping and Packaging	53
8. Glossary	54

1. Specifications

1.1 Interfaces

1.1.1 DVI-D Single Link

The video interface supports the DVI-D protocol. All signals that comply with the DVI-D Single-Link specification can be transmitted. This includes, for example, monitor resolutions such as 1920 x 1200 @ 60 Hz, Full HD (1080p), or 2K HD (up to 2048 x 1152). Data rate is limited to 165 Megapixels per second (MPixel/s).

1.1.2 DVI-I Single Link

The video interface supports the DVI-I protocol. All analog (VGA) or digital (DVI) signals that comply with the DVI-I Single-Link specification can be transmitted. This includes monitor resolutions for VGA up to 1920 x 1200 @ 60 Hz, and monitor resolutions for DVI-I up to Full HD (1080p) or for DVI-D 2K HD (up to 2048 x 1152). Data rate is limited to 165 MPixel/s.

NOTE: Transmission of interlaced video signals, such as 1920 x 1080i, cannot be guaranteed.

1.1.3 USB-HID

Our devices with an USB-HID interface support a maximum of two devices compliant with the USB-HID protocol. Each USB-HID port provides a maximum current of 100 mA.

Keyboard

Compatible with most USB keyboards. Certain keyboards with additional functions may require custom firmware to operate. Keyboards with an integral USB hub (such as Mac® keyboards) are also supported.

Mouse

Compatible with most 2-button, 3-button, and scroll mice.

Other USB-HID devices

The proprietary USB emulation also supports certain other USB-HID devices, such as specific touch screens, graphics tablets, barcode scanners or special keyboards. Support cannot be guaranteed, however, for every USB-HID device.

NOTE: Only two USB-HID devices are supported concurrently, such as keyboard and mouse or keyboard and touch screen. A hub is allowed, but it does not increase the number of HID devices allowed. You can also use Extenders with an additional HID channel.

To support other USB "non-HID" devices, such as scanners, Web cams, or memory devices, choose our devices with transparent USB support.

1.1.4 USB 2.0 (transparent)

DKM Modular Extender models with transparent USB 2.0 support allow the connection of all types of USB 2.0 devices (without restriction). USB 2.0 data transfer is supported with high-speed USB (max. 480 Mbps).

Each USB 2.0 port provides a maximum current of 500 mA (high power).

1.1.5 RJ-45 (Interconnect)

For CATx device communications, the extender requires a 1000BASE-T connection.

Connector wiring must comply with EIA/TIA-568-B (1000BASE-T), with RJ-45 connectors at both ends. All four cable wire pairs are used.

NOTE: DKM Extenders do not support TCP/IP protocol: Do not run the extenders through network equipment such as routers, switches, or hubs.

1.1.6 Fiber SFP Type LC (Interconnect)

The communication of fiber devices is performed via Gigabit SFPs that have to be connected to suitable fibers fitted with type LC connectors (see Chapter 1.2.2).

NOTE: The correct function of the device can only be guaranteed with SFPs provided by Black Box.

CAUTION: SFP modules can be damaged by electrostatic discharge (ESD).

When handling, take care not to damage devices.

1.1.7 Serial Interface

The serial interface option supports a full-duplex transmission with a real hardware handshake up to a baud rate of 19,200.

The CON Unit is cabled as DTE (Data Terminal Equipment, such as CPU output) and can be connected directly to DCE (Data Communication Equipment) devices.

- A touch screen can be connected directly to the CON Unit.
- To connect to a serial printer (or any other DTE instead of DCE device), you need a null-modem cable (cross-over cable) between the CON Unit and the device.

Operation of several devices:

The serial interface transmits six signals (three for each direction). Normally, four of the six signals are handshake signals (in addition to RxD and TxD). The following configurations, however, are possible using special adapter splitting cables:

- Three single 2-wire transmissions.
- Two transmissions with a handshake signal.
- A serial mouse and a single 2-wire transmission.

In this case, choose X-ON/X-OFF software handshake for traffic control at the printer and PC.

Table 1-1. Serial interface specifications.

Specification	Description
Connection Format	DTE (Data Terminal Equipment)
Speed	Up to 19,200 baud
Data Format	Format independent
Data Transmission	<ul style="list-style-type: none"> • RxD (Receive Data) • TxD (Transmit Data)
Traffic Control	<p>The following signals are transmitted (hardware handshake):</p> <ul style="list-style-type: none"> • RTS (Request to Send) • CTS (Clear to Send) • DTR (Data Terminal Ready) • DSR (Data Set Ready)

1.1.8 Analog Audio Interface

The Analog Audio option supports a bidirectional stereo audio transmission, in nearly CD quality.

The audio interface is a “line level” interface and it is designed to transmit the signals of a sound card (or another “line level” device) as well as to allow the connection of active speakers to the CON Unit.

Chapter 1: Specifications

Stereo audio can be transmitted bidirectionally at the same time.

Connection of a microphone:

Connect the microphone to the “audio” input of the CON Unit. There are two ways to establish this connection:

- The output of the CPU Unit is connected with the microphone input of the sound card (red). Adjust the sound card to provide an additional amplification (20 dB).
- The output of the CPU Unit is connected to the audio input of the sound card (blue). Choose this connection if the microphone has its own pre-amplifier.

NOTE: The CON Unit can do the pre-amplification of the microphone as well. Open the CON Unit, locate the “MIC” jumper on the audio board and close the pins.

Table 1-2. Analog audio specifications.

Specification	Description
Transmission Format	Digitized virtually CD quality audio (16-bit, 38.4 kHz)
Signal Level	Line-level (5-volt pk-pk maximum)
Input Impedance	47 kOhm
Connections CPU Unit	(2) 3.5-mm stereo audio plug (audio in and audio out)
Connections CON Unit	(2) 3.5-mm stereo audio plug (audio in and audio out)

1.1.9 Digital Audio Interface

The digital audio option supports the unidirectional transmission of digital audio data.

Up to three sources can be connected to the CPU Unit. The active source is transmitted. If several sources are active, the XLR signal takes priority, otherwise the first active signal.

Up to three sinks can be connected to the CON Unit. The signal is available at all outputs concurrently.

DKM Compact Extenders with digital audio option include a built-in sample rate converter that provides predefined sample frequencies at the CON unit’s output.

The user can set the following parameters directly via a configuration file:

- Activate or deactivate sample rate converter
- Set sample frequency of the sample rate converter. The following sample frequencies are available:
 - 32.0 kHz
 - 44.1 kHz
 - 48.0 kHz
 - 96.0 kHz

Table 1-3. Digital audio interface specifications.

Specification	Description
Compatibility	AES/EBU, S/PDIF, EIAJCP1201, IEC 60958
Standards	Dolby digital, DTS, PCM
CPU Unit (Inputs)	<ul style="list-style-type: none"> • Mini XLR (AES/EBU; symmetrical lockable) • Coaxial (S/PDIF; RCA, Cinch) • Optical (S/PDIF, TOSLINK®)
CON Unit (Outputs)	<ul style="list-style-type: none"> • Mini XLR (AES/EBU; symmetrical, lockable) • Coaxial (S/PDIF, RCA, Cinch) • Optical (S/PDIF, TOSLINK)

1.2 Interconnect Cable

1.2.1 CATx

NOTE: A point-to-point connection is required. Operation with several patch fields is possible. Routing is only supported using ServSwitch DKM or ServSwitch DKM FX. Contact Black Box Technical Support at 724-746-5500 or info@blackbox.com. Routing over an active network component, such as an Ethernet hub, router, or switch, is not allowed.

- Avoid routing CATx cables along power cables.
- If the site has 3-phase AC power, make sure that CPU Unit and CON Unit are on the same phase.

CAUTION: To maintain regulatory EMC compliance, you must use correctly installed shielded CATx cable throughout the interconnection link. Also, all CATx cables need to carry ferrites on both cable ends close to the device.

Type of Interconnect Cable

The DKM Compact Extender requires interconnect cabling specified for Gigabit Ethernet (1000BASE-T). The use of solid-core (24 AWG), shielded, CAT5e (or better) is recommended.

Table 1-4. CATx interconnect cable specifications.

Parameter	Description
CATx solid-core cable 24 AWG	S/UTP (CAT5e) cable according to EIA/TIA-568-B. Four pairs of 24 AWG wires. Connection according to EIA/TIA-568-B (1000BASE-T).
CATx patch cable 26/8 AWG	S/UTP (CAT5e) cable according to EIA/TIA-568-B. Four pairs of 26/8 AWG wires. Connection according to EIA/TIA-568-B (1000BASE-T).

NOTE: You can use flexible cables (patch cables) type 26/8 AWG; but you'll only get half the maximum possible extension distance (Table 1-5).

Maximum Acceptable CATx Cable Length

Table 1-5. Maximum acceptable CATx cable length.

Cable Type	Maximum Length
Solid-conductor CATx cable	400 feet (140 m)
Stranded-conductor CATx cable	200 feet (70 m)

1.2.2 Fiber

A point-to-point connection is necessary. Operation with multiple patch panels is allowed. Routing over active network components, such as Ethernet hubs, switches, or routers, is not allowed.

Type of Interconnect Cable

(Cable notations according to VDE)

Table 1-6. Fiber cable specifications.

Cable Type	Description
Single-mode fiber 9 μm	<ul style="list-style-type: none">• Two 9-μm fibers• Indoor patch cable (EFN310-xxM-LCLC)
Multimode fiber 50 μm	<ul style="list-style-type: none">• Two 50-μm fibers• Indoor patch cable (EFN6020-xxxM)
Multimode fiber 62.5 μm	<ul style="list-style-type: none">• Two 62.5-μm fibers• Indoor patch cable (EFN110-xxxM-LCLC)

Table 1-7. Maximum acceptable fiber cable length.

Cable Type	Length
Single-mode fiber 9 μm	32,800 feet (10,000 m)
Multimode fiber 50 μm (OM3)	3280 feet (1000 m)
Multimode fiber 50 μm	1300 feet (400 m)
Multimode fiber 62.5 μm	650 feet (200 m)

NOTE: If you use single-mode SFPs with multimode fibers, you normally can double the maximum acceptable cable length.

Connector type

The Compact Extenders have fiber LC connectors.

1.3 Supported Peripherals

1.3.1 USB-HID Devices

The DKM Modular Extender will support most USB-HID devices, including the vast majority of keyboards and mice currently on the market. Many other kinds of HID devices such as bar-code scanners and touchscreens may also be compatible.

It is not possible to guarantee support for all available USB-HID devices. In certain cases, you may need custom firmware.

USB-HID (and other) devices that are not supported as standard will normally operate with our devices featuring transparent USB support.

NOTE: Concurrent operation of more than two USB-HID devices is not possible even if you use a USB hub.

1.3.2 USB 2.0 Devices

DKM Modular Extender models featuring a transparent USB 2.0 connection use Extreme USB Technology. This technology supports all types of USB 2.0 devices; however, we cannot guarantee compatibility with every device on the market. Please contact Black Box Technical Support at 724-746-5500 or info@blackbox.com if any issues are found.

1.4 Connector Pinouts

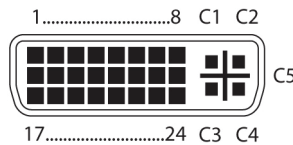

Figure 1-1. DVI-D connector.

Table 1-8. DVI-D single-link connector pinout.

Pin	Signal	Pin	Signal	Pin	Signal
1	TMDS data 2-	9	TMDS data 1-	17	TMDS data 0-
2	TMDS data 2+	10	TMDS data 1+	18	TMDS data 0+
3	TMDS data 2 GND	11	TMDS data 1 GND	19	TMDS data 0 GND
4	not connected	12	not connected	20	not connected
5	not connected	13	not connected	21	not connected
6	DDC input (SCL)	14	+5 VDC high impedance	22	TMDS clock GND
7	DDC output (SDA)	15	GND	23	TMDS clock +
8	Internal use	16	Hot plug recognition	24	TMDS clock -
C1	Internal use	—	—	C3	Internal use
C2	not connected	C5	GND	C4	Internal use

Chapter 1: Specifications

Connector DVI-I Single-Link

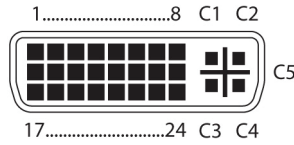

Figure 1-2. DVI-I connector.

Table 1-9. DVI-I single-link connector pinout.

Pin	Signal	Pin	Signal	Pin	Signal
1	TMDS data 2-	9	TMDS data 1-	17	TMDS data 0-
2	TMDS data 2+	10	TMDS data 1+	18	TMDS data 0+
3	TMDS data 2 GND	11	TMDS data 1 GND	19	TMDS data 0 GND
4	not connected	12	not connected	20	not connected
5	not connected	13	not connected	21	not connected
6	DDC input (SCL)	14	+5 VDC high impedance	22	TMDS clock GND
7	DDC output (SDA)	15	GND	23	TMDS clock +
8	V-sync	16	Hot plug recognition	24	TMDS clock -
C1	Red signal	—	—	C3	Blue signal
C2	Green signal	C5	GND	C4	H-sync

Connector USB Type B



Figure 1-3. USB Type B connector.

Table 1-10. USB Type B connector pinout.

Pin	Signal	Color
1	VCC (+5 VDC)	Red
2	Data -	White
3	Data +	Green
4	GND	Black

Connector USB Type A

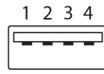

Figure 1-4. USB Type A connector.

Table 1-11. USB Type A connector pinout.

Pin	Signal	Color
1	VCC (+5 VDC)	Red
2	Data -	White
3	Data +	Green
4	GND	Black

Connector Mini USB Type B



Figure 1-5. Mini USB Type B connector.

Table 1-12. Mini USB Type B connector pinout.

Pin	Signal	Color
1	VCC (+5 VDC)	Red
2	Data -	White
3	Data +	Green
4	not connected	—
5	GND	Black

RJ-45 connector

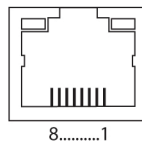

Figure 1-6. RJ-45 connector.

Table 1-13. RJ-45 connector pinout.

Pin	Signal	Pin	Signal
1	D1+	5	D3-
2	D1-	6	D2-
3	D2+	7	D4+
4	D3+	8	D4-

Chapter 1: Specifications

Fiber SFP Type LC

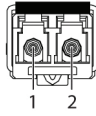

Figure 1-7. SFP Type LC connector.

Table 1-14. SFP Type LC connector pinout.

Pin	Signal
1	Data OUT
2	Data IN

Power Supply



Figure 1-8. Power supply label.

Table 1-15. Power supply connector pinout.

Pin	Signal
Inside	VCC (+5 VDC)
Outside	GND

DB9 (Serial)

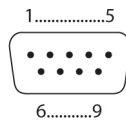

Figure 1-9. DB9 serial connector.

Table 1-16. DB9 serial connector pinout.

Pin	Signal	Pin	Signal
1	not connected	6	DTR
2	CTS	7	TxD
3	RTS	8	RxD
4	DSR	0	not connected
5	GND	—	—

3.5-mm Stereo Jack Plug



Figure 1-10. 3.5-mm stereo jack plug.

Table 1-17. 3.5-mm stereo jack plug pinout.

Pin	Signal
1	GND
2	Audio IN/OUT L
3	Audio IN/OUT R

RCA (Cinch)



Figure 1-11. RCA connector.

Table 1-18. RCA connector pinout.

Pin	Signal
1	GND
2	Data IN/OUT

Mini-XLR



Figure 1-12. Mini XLR connector.

Table 1-19. Mini XLR connector pinout.

Pin	Signal
1	GND
2	Data +
3	Data -

TOSLINK



Figure 1-13. TOSLINK connector.

Table 1-20. TOSLINK connector pinout.

Pin	Signal
1	Data IN/OUT

1.5 Power Supply

Power — Per unit: 5-VDC;

Single-head devices: 800 mA max.;

Dual-head devices: 1600 mA max.;

Optional modules: Analog audio/serial 300 mA max.,

Digital audio: 300 mA max.,

USB-HID: 300 mA max.;

USB 2.0 modules: 2500 mA max.;

VGA: 900 mA max.

1.6 Environmental Conditions

Temperature Tolerance — Operating: +41 to +113° F (+5 to +45° C)

Storage Temperature: -13 to +140° F (-25 to +60° C)

Relative Humidity (Max.) — 80% non-condensing

1.7 Size

CPU Unit/CON Unit — Single-head-only devices: *Only ACX1T-11-xx and ACX1R-11-xx, ACX1R-11V-xxxx: 4"H x 5.6"W x 1.1"D (10.3 x 14.3 x 2.9 cm);

Dual-head devices and single-head devices with optional modules: 4"H x 5.6"W x 1.7"D (10.3 x 14.3 x 4.3 cm)

**NOTE: Only for connection type: xx = C for CATx and xx = SM for Fiber Single-head devices.*

Shipping Box — All AC1XR: 6.5"H x 6.5"W x 4.7"D (16.5 x 16.5 x 12 cm)

All AC1XT: 8.2"H x 8.2"W x 6.5"D (21 x 21 x 16.5 cm)

1.8 Shipping Weight

CPU Unit/CON Unit — Single-head-only devices: 0.7 lb. (0.3 kg);

Dual-head devices and single-head devices with optional modules: 0.9 lb. (0.4 kg)

Shipping Box — Single-head-only devices: 4 lb. (1.8 kg);

Dual-head devices and Single-head devices with optional modules: 5.1 lb. (2.3 kg)

2 Overview

2.1 Application

The DKM Compact Extender is used to increase the distance between a source (computer, CPU) and its console (keyboard, mouse, and other peripheral devices). It's designed for use with CATx (twisted-pair) interconnect cables or fiber interconnect cables.

The DKM Compact Extender with CATx interconnect cables won't work between buildings where you should use a fiber optic based product instead.

The DKM Compact Extender with fiber interconnect cables also works with applications in environments that are difficult in electromagnetic aspects. Electromagnetic interference can limit the maximum distance and reliability.

The DKM Compact Extender is fully compatible with the DKM Modular Extender.

The unit is designed to work in point-to-point applications as well as through a ServSwitch DKM or ServSwitch DKM FX crosspoint switch.

2.2 System Overview

The DKM Compact Extender consists of at least one CPU Unit and one console unit (CON Unit).

The CPU module connects directly to the source (computer, CPU) using the supplied cables. The CON unit connects to the console (monitor, keyboard, and mouse). The CPU Unit and the CON unit communicate with each other through the interconnect cables. Figure 2-1 shows a typical system application. Table 2-1 describes the components shown in the diagram.

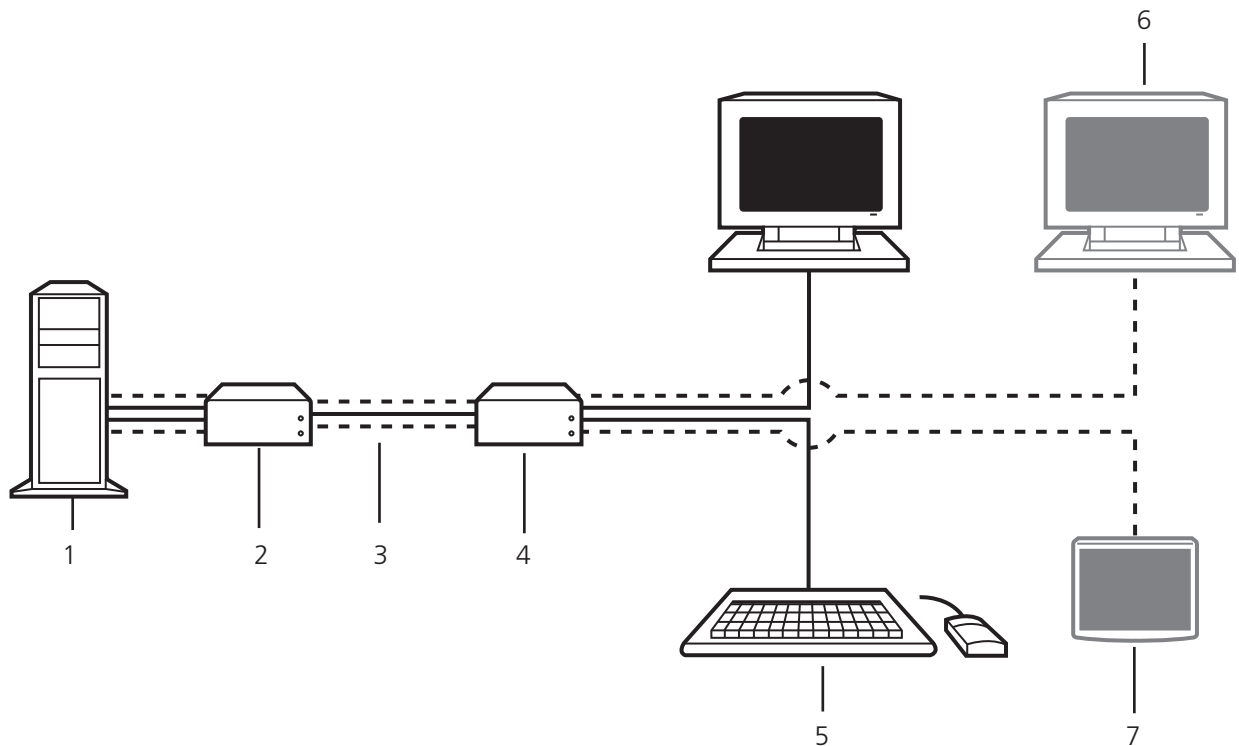

Figure 2-1. System diagram.

Table 2-1. System components.

Number	Component
1	Source (computer, CPU)
2	DKM Modular Extender CPU unit
3	Interconnect cable
4	DKM Modular Extender CON unit
5	Console (monitor, keyboard, mouse)
6	Second monitor (option, only with dual-head devices)
7	USB-HID devices (option, only with (4) USB-HID devices)

NOTE: See Section 3.3 for installation examples.

2.3 Product Range

2.3.1 DKM Compact Transmitter and Receiver Units (CATx)

Table 2-2. CATx units.

Part Number	Description
ACX1T-11-C	Single-head transmitter (CPU) unit for (1) DVI-D single link (up to 1920 x 1200 with (2) USB-HID ports
ACX1R-11-C	Single-head receiver (console [CON]) unit for (1) DVI-D single link (up to 1920 x 1200) with (2) USB-HID ports
ACX1T-13-C	Single-head transmitter (CPU) unit for DVD-I (VGA/DVI) single link (up to 1920 x 1200) with (2) USB-HID ports, (4) USB 2.0 ports
ACX1R-13-C	Single-head receiver (console [CON]) unit for DVI-I (VGA/DVI) single link (up to 1920 x 1200) with (2) USB-HID ports, (4) USB 2.0 ports
ACX1T-11V-C	Single-head transmitter (CPU) unit for DVI-I (VGA/DVI) single link (up to 1920 x 1200) with (2) USB-HID ports and IR remote control
ACX1R-11V-C	Single-head receiver (console [CON]) unit for DVI-I (VGA/DVI) single link (up to 1920 x 1200) with (2) USB-HID ports and IR remote control
ACX1T-12A-C	Single-head transmitter (CPU) unit for single link (up to 1920 x 1200) with (4) USB-HID ports, bidirectional analog audio
ACX1R-12A-C	Single-head receiver (console [CON]) unit for single link (up to 1920 x 1200) with (4) USB-HID ports, bidirectional analog audio
ACX1T-12D-C	Single-head transmitter (CPU) unit for single link (up to 1920 x 1200) with (4) USB-HID ports, unidirectional digital audio
ACX1R12D-C	Single-head transmitter (console [CON]) unit for single link (up to 1920 x 1200) with (4) USB-HID ports, unidirectional digital audio
ACX1T-22-C	Dual-head transmitter (CPU) unit for single link (up to 1920 x 1200) with (4) USB-HID ports, no audio
ACX1R-22-C	Dual-head receiver (console [CON]) unit for single link (up to 1920 x 1200) with (4) USB-HID ports, no audio

2.3.2 ServSwitch DKM Compact Extender Transmitter and Receiver Units, Fiber

Table 2-3. Fiber units.

Part Number	Description
ACX1T-11-SM	Single-head transmitter (CPU) unit for (1) DVI-D single link (up to 1920 x 1200 with (2) USB-HID ports
ACX1R-11-SM	Single-head receiver (console [CON]) unit for (1) DVI-D single link (up to 1920 x 1200) with (2) USB-HID ports
ACX1T-13-SM	Single-head transmitter (CPU) unit for DVD-I (VGA/DVI) single link (up to 1920 x 1200) with (2) USB-HID ports, (4) USB 2.0 ports
ACX1R-13-SM	Single-head receiver (console [CON]) unit for DVI-I (VGA/DVI) single link (up to 1920 x 1200) with (2) USB-HID ports, (4) USB 2.0 ports
ACX1T-11V-SM	Single-head transmitter (CPU) unit for DVI-I (VGA/DVI) single link (up to 1920 x 1200) with (2) USB-HID ports and IR remote control
ACX1R-11V-SM	Single-head receiver (console [CON]) unit for DVI-I (VGA/DVI) single link (up to 1920 x 1200) with (2) USB-HID ports and IR remote control
ACX1T-12A-SM	Single-head transmitter (CPU) unit for single link (up to 1920 x 1200) with (4) USB-HID ports, bidirectional analog audio
ACX1R-12A-SM	Single-head receiver (console [CON]) unit for single link (up to 1920 x 1200) with (4) USB-HID ports, bidirectional analog audio
ACX1T-12D-SM	Single-head transmitter (CPU) unit for single link (up to 1920 x 1200) with (4) USB-HID ports, unidirectional digital audio
ACX1R12D-SM	Single-head receiver (console [CON]) unit for single link (up to 1920 x 1200) with (4) USB-HID ports, unidirectional digital audio
ACX1T-22-SM	Dual-head transmitter (CPU) unit for single link (up to 1920 x 1200) with (4) USB-HID ports, no audio
ACX1R-22-SM	Dual-head receiver (console [CON]) unit for single link (up to 1920 x 1200) with (4) USB-HID ports, no audio

Table 2-4. Fiber kits.

Part Number	Description
ACX1K-11-SM	This kit contains (1) Single-head transmitter (CPU) unit for (1) DVI-D single link (up to 1920 x 1200 with (2) USB-HID ports (ACX1T-11-SM) and (1) Single-head receiver (console [CON]) unit for (1) DVI-D single link (up to 1920 x 1200) with (2) USB-HID ports (ACX1R-11-SM)

Part numbers for CPU Unit and CON Unit:

IMPORTANT! The part numbers for the CPU Unit and the CON Unit can be derived from the part number of the complete device.

- CPU Unit: ACX1T
- CON Unit: ACX1R
- Kit: (1) ACX1T plus (1) ACX1R

NOTE: All devices of the ACX1T/R DKM Compact Extender series are technically compatible with the devices of the DKM Modular Extenders (ACX1MT/R series).

NOTE: Currently only one ACX1K kit model is available: ACX1K-11-SM (described in Table 2-4 above).

2.3.3 Upgrade Kits

Table 2-5. Upgrade options.

Part Number	Description
ACS2209A-RMK	19"/1U rackmount kit to mount up to (3) head devices and (1) rackmount power supply (ACS2209-PS), or up to (4) devices.
ACS2209-PS	19" rackmountable power supply to feed up to (3) devices.
DRMVACU-S	DIN Rail Mount Kit

2.3.4 Accessories

Table 2-6. Accessories.

Part Number	Description
BC00200	6-foot (1.8-m) serial RS-232 cable
USB05-0006	6-foot (1.8-m) USB Type A to B cable
ACXMODH4-PS	100–240-VAC/5-VDC/5-A international power supply unit
ACXMODH2-PS	100–240-VAC/5-VDC/3-A international power supply unit
EVNDVI04-0006	6-foot (1.8-m) VGA cable (VGA to DVI-I)
EVNDVI02-0006	6-foot (1.8-m) DVI-D cable (DVI-D)
ACXSPL12	DVI-D splitter cable
EJ110-0005	5-foot (1.5-m) 3.5-mm stereo jack cable
EJ514-0005-MM	5-foot (1.5-m) RCA cable (Cinch male connector)
EFJ04-001M	3-foot (1-m) TOSLINK cable (F05 male connector)
Contact Tech Support at 724-746-5500 or info@blackbox.com.	6-foot (1.8-m) Mini-XLR cable (3-pole)

2.4 Device Views

2.4.1 ACX1T-11-C/ACX1R-11-C (Single-Head, CATx)

CPU unit, rear view

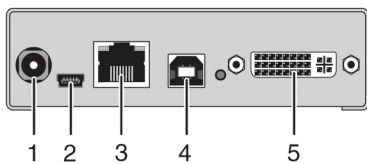

CON unit, rear view

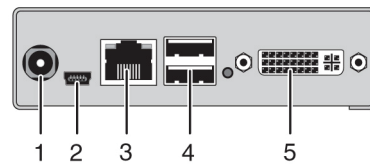

Figure 2-2. ACX1T-11-C (CPU unit) and ACX1R-11-C (CON unit).

Table 2-7. ACX1T-11-C/ ACX1R-11-C components.

CPU unit		CON unit	
1	Connect to 5-VDC power supply	1	Connect to 5-VDC power supply
2	Service port	2	Service port
3	Connect to interconnect cable	3	Connect to interconnect cable
4	To CPU: USB-HID	4	Connect to USB-HID devices
5	To CPU: DVI-D	5	Connect to DVI monitor

2.4.2 ACX1T-11-SM-/ACX1R-11-SM (Single-Head Fiber) and ACX1K-11-SM Kit



Figure 2-3. ACX1T-11-SM (CPU unit) and ACX1R-11-SM (CON unit).

Table 2-8. ACX1T-11-SM/ ACX1R-11-SM components.

CPU unit		CON unit	
1	Connect to 5-VDC power supply	1	Connect to 5-VDC power supply
2	Service port	2	Service port
3	Connect to interconnect cable	3	Connect to interconnect cable
4	To CPU: USB-HID	4	Connect to USB-HID devices
5	To CPU: DVI-D	5	Connect to DVI monitor

NOTE: ACX1K-11-SM kit contains BOTH of the items shown above (one ACX1T-11-SM and one ACX1R-11-SM).

2.4.3 ACX1T-12A-C/ACX1R-12A-C (Analog Audio/Serial, CATx)

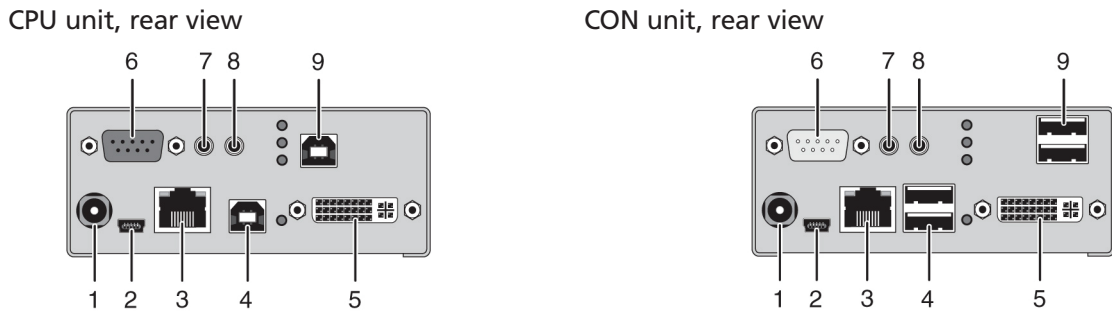

Figure 2-4. ACX1T-12A-C (CPU unit) and ACX1R-12A-C (CON unit).

Table 2-9. ACX1T-12A-C/ ACX1R-12A-C components.

CPU unit		CON unit	
1	Connect to 5-VDC power supply	1	Connect to 5-VDC power supply
2	Service port	3	Service port
3	Connect to interconnect cable	3	Connect to interconnect cable
4	To CPU: USB-HID 1	4	Connect to USB-HID devices 1
5	To CPU: DVI-D	5	Connect to DVI monitor
6	Connect to serial (DB9)	6	Connect to serial (DB9)
7	Audio IN	7	Audio OUT
8	Audio OUT	8	Audio IN
9	To CPU: USB-HID 2	9	Connect to USB-HID devices 2

2.4.4 ACX1T-12A-SM/ACX1R-12A-SM (Analog Audio/Serial, Fiber)

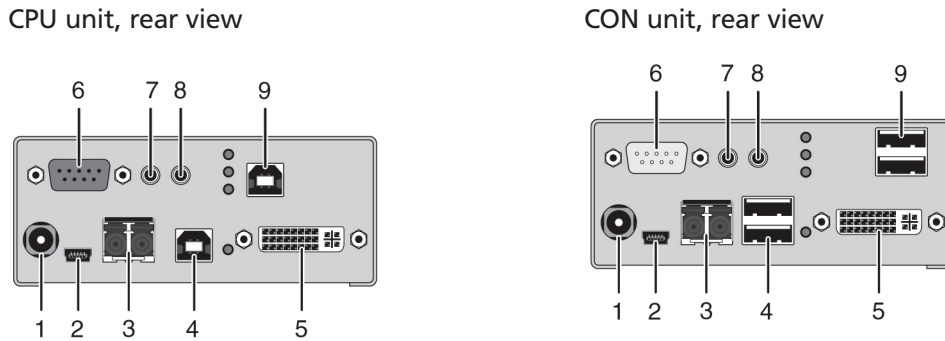

Figure 2-5. ACX1T-12A-SM (CPU unit) and ACX1R-12A-SM (CON unit).

Table 2-10. ACX1T-12A-SM/ACX1R-12A-SM module components.

CPU unit		CON unit	
1	Connect to 5-VDC power supply	1	Connect to 5-VDC power supply
2	Service port	3	Service port
3	Connect to interconnect cable	3	Connect to interconnect cable
4	To CPU: USB-HID 1	4	Connect to USB-HID devices 1
5	To CPU: DVI-D	5	Connect to DVI monitor
6	Connect to serial (DB9)	6	Connect to serial (DB9)
7	Audio IN	7	Audio OUT
8	Audio OUT	8	Audio IN
9	To CPU: USB-HID 2	9	Connect to USB-HID devices 2

2.4.5 ACX1T-12D-C/ACX1R-12D-C (Digital Audio, CATx)

CPU unit, rear view

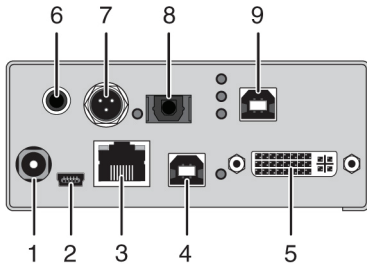

CON unit, rear view

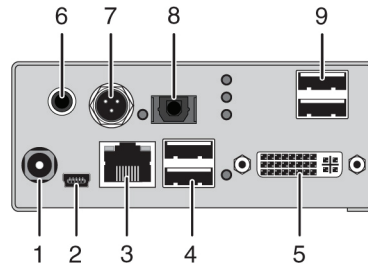

Figure 2-6. ACX1T-12D-C (CPU unit) and ACX1R-12D-C (CON unit).

Table 2-11. ACX1T-12D-C/ACX1R-12D-C module components.

CPU unit		CON unit	
1	Connect to 5-VDC power supply	1	Connect to 5-VDC power supply
2	Service port	3	Service port
3	Connect to interconnect cable	3	Connect to interconnect cable
4	To CPU: USB-HID 1	4	Connect to USB-HID devices 1
5	To CPU: DVI-D	5	Connect to DVI monitor
6	RCA input	6	RCA output
7	Mini-XLR input	7	Mini-XLR output
8	TOSLINK input	8	TOSLINK output
9	To CPU: USB-HID 2	9	Connect to USB-HID devices 2

2.4.6 ACX1T-12D-SM/ACX1R-12D-SM (Digital Audio, Fiber)

CPU unit, rear view

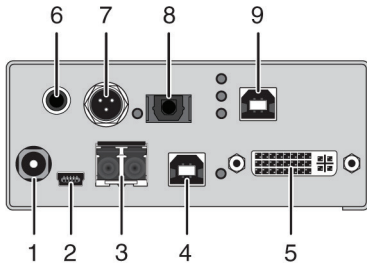

CON unit, rear view

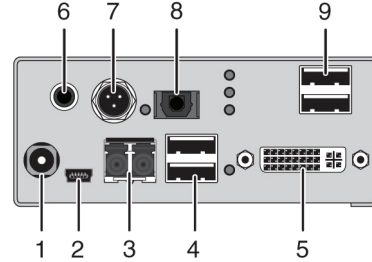

Figure 2-7. ACX1T-12D-SM (CPU unit) and ACX1R-12D-SM (CON unit).

Table 2-12. ACX1T-12D-SM/ACX1R-12D-SM module components.

CPU unit		CON unit	
1	Connect to 5-VDC power supply	1	Connect to 5-VDC power supply
2	Service port	3	Service port
3	Connect to interconnect cable	3	Connect to interconnect cable
4	To CPU: USB-HID 1	4	Connect to USB-HID devices 1
5	To CPU: DVI-D	5	Connect to DVI monitor
6	RCA input	6	RCA output
7	Mini-XLR input	7	Mini-XLR output
8	TOSLINK input	8	TOSLINK output
9	To CPU: USB-HID 2	9	Connect to USB-HID devices 2

2.4.7 ACX1T-13-C/ACX1R-13-C (USB 2.0 CATx)

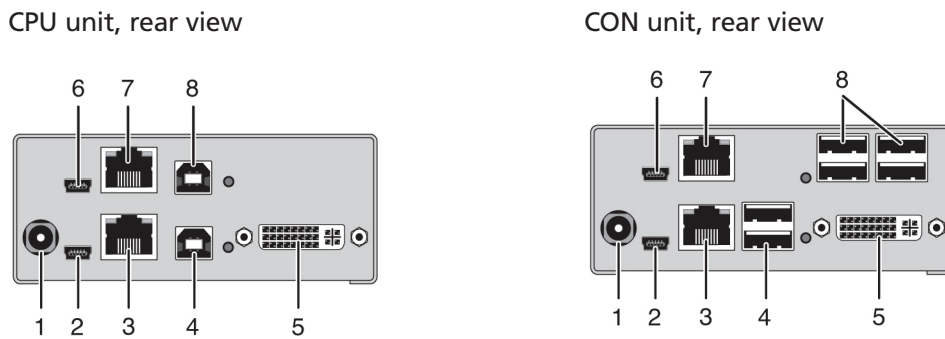

Figure 2-8. ACX1T-13-C (CPU unit) and ACX1R-13-C (CON unit).

Table 2-13. ACX1T-13-C/ACX1R-13-C module components.

CPU unit		CON unit	
1	Connect to 5-VDC power supply	1	Connect to 5-VDC power supply
2	Service port 1	3	Service port 1
3	Connect to interconnect cable	3	Connect to interconnect cable
4	To CPU: USB-HID	4	Connect to USB-HID devices
5	To CPU: DVI-D	5	Connect to DVI monitor
6	Service port 2	6	Service port 2
7	Connect to interconnect cable	7	Connect to interconnect cable
8	To CPU: USB 2.0	8	Connect to USB 2.0 devices

2.4.8 ACX1T-13-SM/ACX1R-13-SM (USB 2.0 Fiber)

CPU unit, rear view

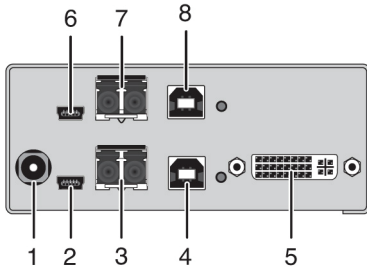

CON unit, rear view

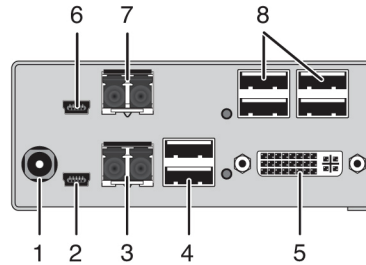

Figure 2-9. ACX1MT-ARH (CPU unit) and ACX1MR-ARH (CON unit).

Table 2-14. ACX1T-13-SM/ACX1R-13-SM module components.

CPU unit		CON unit	
1	Connect to 5-VDC power supply	1	Connect to 5-VDC power supply
2	Service port 1	3	Service port 1
3	Connect to interconnect cable	3	Connect to interconnect cable
4	To CPU: USB-HID	4	Connect to USB-HID devices
5	To CPU: DVI-D	5	Connect to DVI monitor
6	Service port 2	6	Service port 2
7	Connect to interconnect cable	7	Connect to interconnect cable
8	To CPU: USB 2.0	8	Connect to USB 2.0 devices

2.4.9 ACX1T-11V-C/ACX1R-11V-C (CATx with VGA)

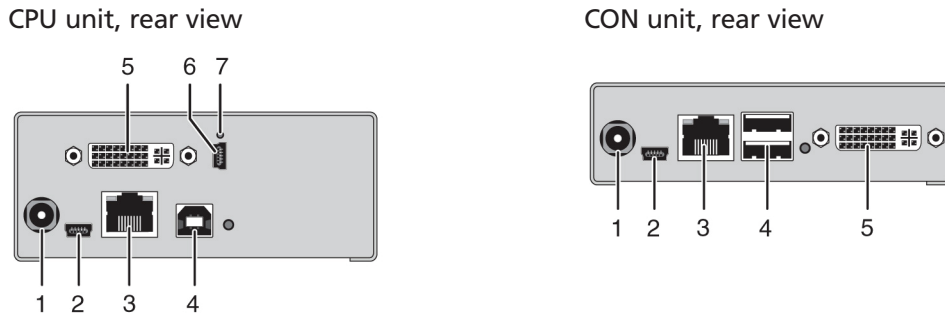

Figure 2-10. ACX1T-11V-C module (CPU unit) and ACX1R-11V-C module (CON unit), rear view.

Table 2-15. ACX1T-11V-C/ACX1R-11V-C rear components.

CPU unit		CON unit	
1	Connect to 5-VDC power supply	1	Connect to 5-VDC power supply
2	Service port (KVM)	3	Service port
3	Connect to interconnect cable	3	Connect to interconnect cable
4	To CPU: USB-HID	4	Connect to USB-HID devices
5	To CPU: DVI-I (VGA/DVI)	5	Connect to DVI monitor
6	Service port (DVI-U)	—	—
7	IR receiver for remote control	—	—

CPU unit, front view



CON unit, front view

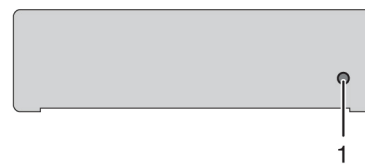

Figure 2-11. ACX1T-11V-C module (CPU unit) and ACX1R-11V-C module (CON unit), front view.

Table 2-16. ACX1T-11V-C/ACX1R-11V-C front components.

CPU unit		CON unit	
1	IR receiver for remote control	1	IR receiver for remote control

2.4.10 ACX1T-11V-SM/ACX1R-11V-SM (Fiber with VGA)

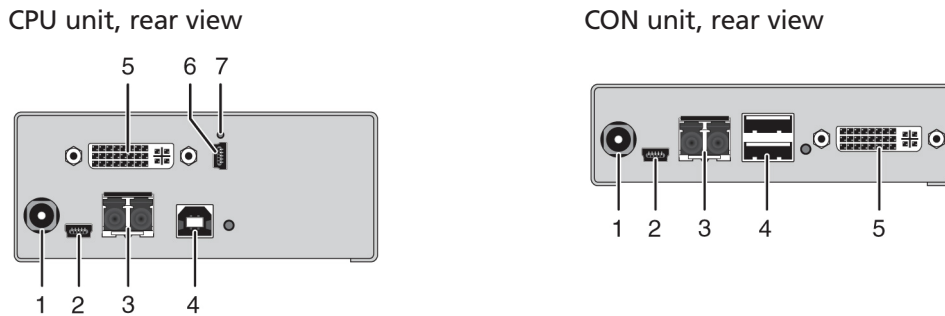

Figure 2-12. ACX1T-11V-SM (CPU unit) and ACX1R-11V-SM (CON unit), rear view.

Table 2-17. ACX1T-11V-SM/ACX1R-11V-SM rear components.

CPU unit		CON unit	
1	Connect to 5-VDC power supply	1	Connect to 5-VDC power supply
2	Service port (KVM)	3	Service port
3	Connect to interconnect cable	3	Connect to interconnect cable
4	To CPU: USB-HID	4	Connect to USB-HID devices
5	To CPU: DVI-I (VGA/DVI)	5	Connect to DVI monitor
6	Service port (DVI-U)	—	—
7	IR receiver for remote control	—	—

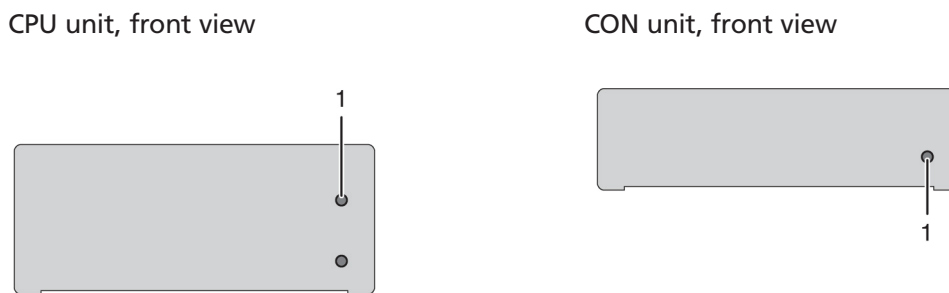

Figure 2-13. ACX1T-11V-SM module (CPU unit) and ACX1R-11V-SM module (CON unit), front view.

Table 2-18. ACX1T-11V-SM/ACX1R-11V-SM front components.

CPU unit		CON unit	
1	IR receiver for remote control	1	IR receiver for remote control

2.4.11 ACX1T-22-C/ACX1R-22-C (Dual-Head CATx)

CPU Module, rear view

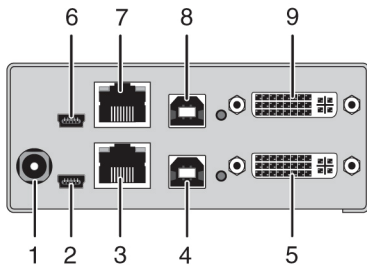

CON Module, rear view

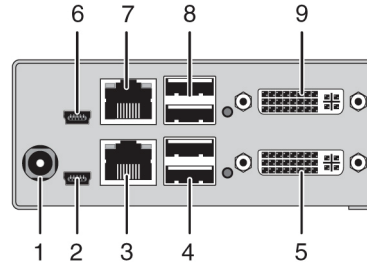

Figure 2-14. ACX1T-22-C (CPU unit) and ACX1R-22-C (CON unit).

Table 2-19. ACX1T-22-C/ACX1R-22-C components.

CPU unit		CON unit	
1	Connect to 5-VDC power supply	1	Connect to 5-VDC power supply
2	Service port 1	3	Service port 1
3	Connect to interconnect cable	3	Connect to interconnect cable
4	To CPU: USB-HID 1	4	Connect to USB-HID devices 1
5	To CPU: DVI-D 1	5	Connect to DVI monitor 1
6	Service port 2	6	Service port 2
7	Connect to interconnect cable	7	Connect to interconnect cable
8	To CPU: USB HID 2	8	Connect to USB-HID devices 2
9	To CPU: DVI-D 2	9	Connect to DVI monitor 2

2.4.12 ACX1T-22-SM/ACX1R-22-SM (Dual-Head Fiber)

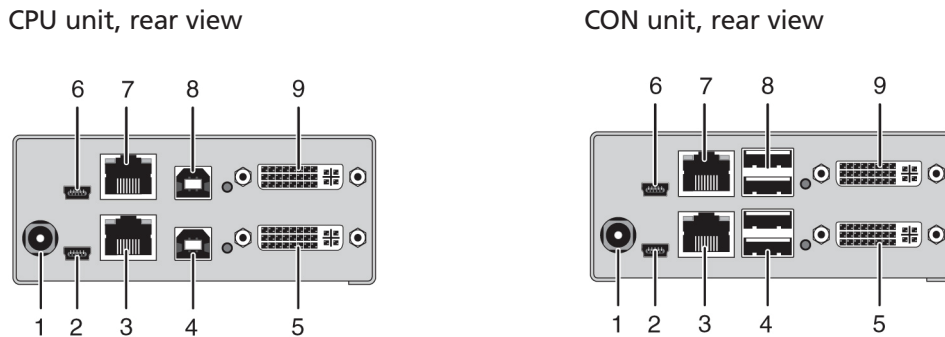

Figure 2-15. ACX1T-22-SM (CPU unit) and ACX1R-22-SM (CON unit).

Table 2-20. ACX1T-22-SM/ACX1R-22-SM components.

CPU unit		CON unit	
1	Connect to 5-VDC power supply	1	Connect to 5-VDC power supply
2	Service port 1	3	Service port 1
3	Connect to interconnect cable	3	Connect to interconnect cable
4	To CPU: USB-HID 1	4	Connect to USB-HID devices 1
5	To CPU: DVI-D 1	5	Connect to DVI monitor 1
6	Service port 2	6	Service port 2
7	Connect to interconnect cable	7	Connect to interconnect cable
8	To CPU: USB HID 2	8	Connect to USB-HID devices 2
9	To CPU: DVI-D 2	9	Connect to DVI monitor 2

2.5 Status LEDs

The KVM extender has a multicolor LED on both sides to indicate overall status. It also has two additional LEDs on the back side to indicate the connection status.

CPU Unit, CATx, rear view

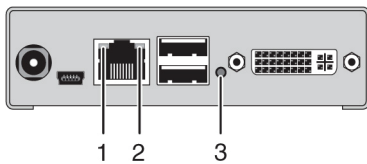

CPU Unit, Fiber, rear view

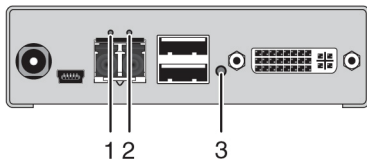

CON Unit, CATx or Fiber models, front view

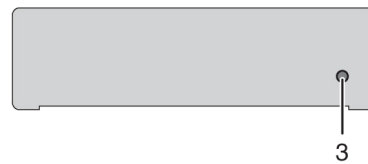

Figure 2-16. Status LEDs on the KVM extender.

Table 2-21. LED 1 and 2: Connection Status.

Position	LED	Status	Description
1	Failure LED (green)	Off	Connection available
		On or Flashing	Connection failure (flashing for about 20 seconds following a connection failure)
2	Status LED (green)	Flashing	No connection via interconnect cable
		On	Connection available

Table 2-22. LED 3: USB and Video Status.

Color	Description
Dark Red	Device ready
Red	Connection available
Blue	USB connection available
Green	Video available
Yellow	Connection and USB signal available, no video
Violet	Connection and video signal available, no USB signal
Light Blue	USB and video signal available, no connection
Turquoise	Connection, USB, and video signal available (operating status)

2.5.1 Status Digital Audio (Option)

The KVM extender with optional digital audio has a multicolor LED on the front side of the CPU Unit to indicate connection status. More information is available via on-screen display (OSD) (see the manual for the Media/DVI Converter [part number ACS411A-R2]).



Figure 2-17. Status digital audio (option)

Table 2-23. LED 1: Digital Audio Status.

LED color	Description
Red	No signal
Cyan	CPU Unit: S/PDIF signal (RCA) available
Violet	CPU Unit: AES/EBU signal (Mini-XLR) available
Blue	CPU Unit: S/PDIF signal (TOSLINK) available
Green	CON Unit: Signal available

2.5.2 Status USB-HID Add-On (Option)

The KVM extender with optional USB-HID has three LEDs on the rear side to indicate the connection status:

CPU Unit, rear view

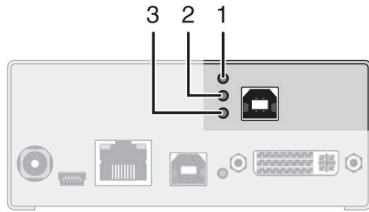

CON Unit, rear view

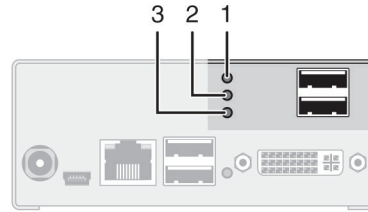

Figure 2-18. Status upgrade modules USB-HID.

Table 2-24. LED 1, 2, and 3: Status.

Position	LED	Status	Description
1, 2	Device LED (orange)	Off	No USB-HID device or not supported; USB device connected
		Flashing fast	USB-HID device active
		On	USB-HID device ready or DKM Modular Extender in command mode
3	Status LED (orange)	Off	<ul style="list-style-type: none"> No power supply voltage CPU Unit: DKM Modular Extender in command mode or no connection CON Unit: Keyboard in command mode
		Flashing slowly	CON Unit: DKM Modular Extender in command mode or no connection
		Flashing fast	Operating status

2.5.3 Status USB 2.0 (Option)

The KVM extender with optional USB 2.0 has a multicolor LED on both sides to indicate overall status. It also has two more LEDs on the back side to indicate the connection status.

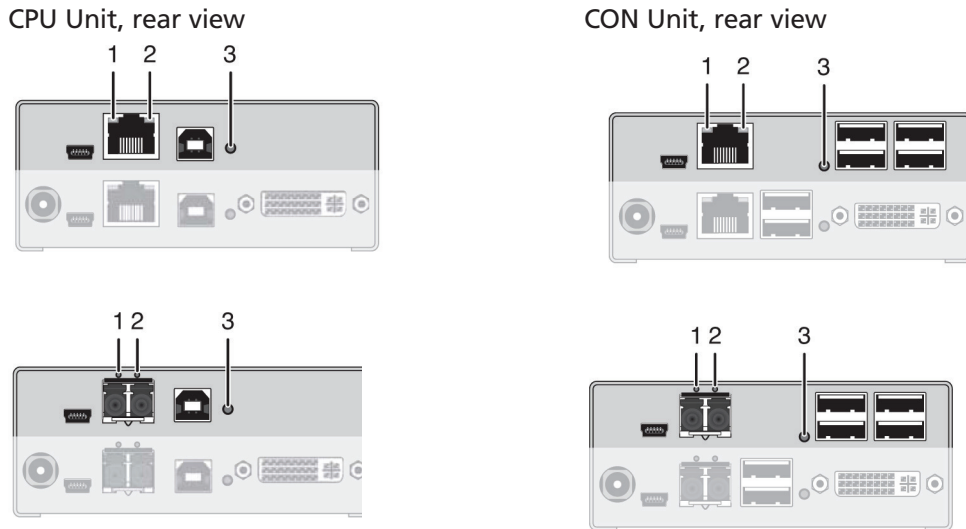

Figure 2-19. Status USB 2.0 (option).

Table 2-25. LEDs 1 and 2: Status.

Position	LED	Status	Description
1	Failure LED (green)	Off	Connection available
		On or flashing	Connection failure (flashing for about 20 seconds following a connection failure)
2	Status LED (green)	Off	No connection via interconnect cable
		On	Connection available

Table 2-26. LED 3: USB 2.0 Status.

LED color	Description
Red	Device ready
Green	Only connection available, no USB 2.0 signal
Green/turquoise flashing	Connection available, no USB 2.0 device connected (only CON unit)
Turquoise	Connection and USB 2.0 signal available (operating status)

2.5.4 Status VGA/DVI-I (Option)

The KVM extender with VGA/DVI-I input has a multicolor LED on the front side of the CPU unit to indicate connection status.



Figure 2-20. VGA/DVI-I option, front view, multicolor LED.

Table 2-27. LED 1: Connection Status VGA/DVI-I.

Color	Description
Dark Red	No video signal; monitor not detected
Red	Video signal not supported; monitor not detected
Green	Video signal supported; monitor not detected
Blue	No video signal; monitor detected
Violet	Video signal not supported; monitor detected
Light Blue	Video signal supported; monitor detected

3. Installation

3.1 Package Contents

Your extender package contains the following items. If anything is missing or damaged, please contact Black Box Technical Support at 724-746-5500 or info@blackbox.com.

- DKM Modular Extender pair (CPU Unit and CON Unit) in separate boxes
- (2) 5-VDC international power supply units
- (2) country-specific power cords
- Quick Start Guide

The Single-Head devices also include:

- (1) DVI video cable (6-ft. [1.8 m], DVI-D male-to-male)



Figure 3-1. DVI video cable.

- (1) USB cable (6-ft. [1.8 m], Type A to Type B)



Figure 3-2. USB cable.

The Dual-Head devices also include:

- DVI video cable (6-ft. [1.8-m], DVI-D male to male)



Figure 3-3. DVI cable.

- USB cable (6-ft. [1.8-m], Type A to Type B)



Figure 3-4. USB cable.

The Analog Audio/Serial option also includes:

- Serial cable (6-ft. [1.8-m], RS-232 male connector)



Figure 3-5. Serial cable.

- Stereo jack cable (5.2-ft. [1.6-m], 3.5-mm male connector)



Figure 3-6. Stereo jack cable.

Chapter 3: Installation

The Digital Audio option also includes:

- RCA cable (8.2-ft. [2.5-m], Cinch male connector)



Figure 3-7. RCA cable.

- TOSLINK cable (6-ft. [1.8-m], F05 male connector)



Figure 3-8. TOSLINK cable.

The USB-HID Add-on option also includes:

- USB cable (6-ft. [1.8-m] USB Type A to Type B)



Figure 3-9. USB cable.

The USB 2.0 Add-on option also includes:

- USB cable (6-ft. [1.8-m], USB Type A to Type B)



Figure 3-10. USB cable.

The VGA also includes (a DVI-I cable instead of a DVI-D cable):

- VGA cable (6-ft. [1.8-m], VGA male to DVI-I male)



Figure 3-11. USB cable.

- Infrared remote control

3.2 System Setup

NOTE: If you are a first-time user, we recommend that you set up the system with the CPU Unit and the CON Unit in the same room as a test setup. This will enable you to identify and solve any cabling problems, and experiment with your system more conveniently.

NOTE: Verify that interconnect cables, interfaces, and handling of the devices comply with the requirements described in this manual.

3.2.1 KVM Extender Setup

1. Switch off all devices.

CON Unit Installation

2. Connect your monitor(s), keyboard, and mouse to the CON Unit.
3. Connect the CON Unit with the interconnect cable(s).

4. Connect the 5-VDC power supply to the CON Unit.

CPU Unit Installation

5. Connect the source (computer, CPU) with the supplied cables to the CPU Unit. Make sure the cables are not strained.
6. Connect the CPU Unit to the interconnect cable(s).
7. Connect the 5-VDC power supply to the CPU Unit.
8. Power up the system.

NOTE: To power up the system, the following sequence is recommended: Monitor – CON Unit – CPU Unit – source.

NOTE: The KVM extender with VGA / DVI-I input is connected as mentioned above. For a complete and detailed description of the setup and configuration of the VGA option, see the Media/DVI Converter [part number ACS411A-R2] manual.

3.2.2 Setup of Optional Modules

You can hot-plug the modules.

Analog Audio/Serial Option:

1. Connect the audio source with the CPU Unit (for example, CPU audio output with audio input, CPU audio input with audio output).
2. Connect the audio output at the CON Unit with headphones or suitable speakers.
3. Connect the audio input at the CON Unit with a suitable microphone.

Digital Audio Option:

1. Connect the digital audio source with the suitable audio input of the CPU unit.
2. Connect the audio output of the CON Unit with suitable speakers or audio amplifiers.

NOTE: If several active sources are connected, Mini-XLR input takes priority. The audio signal is available at all outputs.

USB-HID Add-On Option:

1. Connect the CPU with the CPU Unit (USB-HID 2).
2. Connect the USB-HID devices with the CON Unit (Connect to USB-HID device 2).

USB 2.0 Add-On Option:

1. Connect the CPU with the CPU Unit (USB 2.0).
2. Connect the USB 2.0 devices with the CON Unit (Connect to USB 2.0 devices).

3.3 Example Applications

This section illustrates typical installations of DKM Modular Extenders:

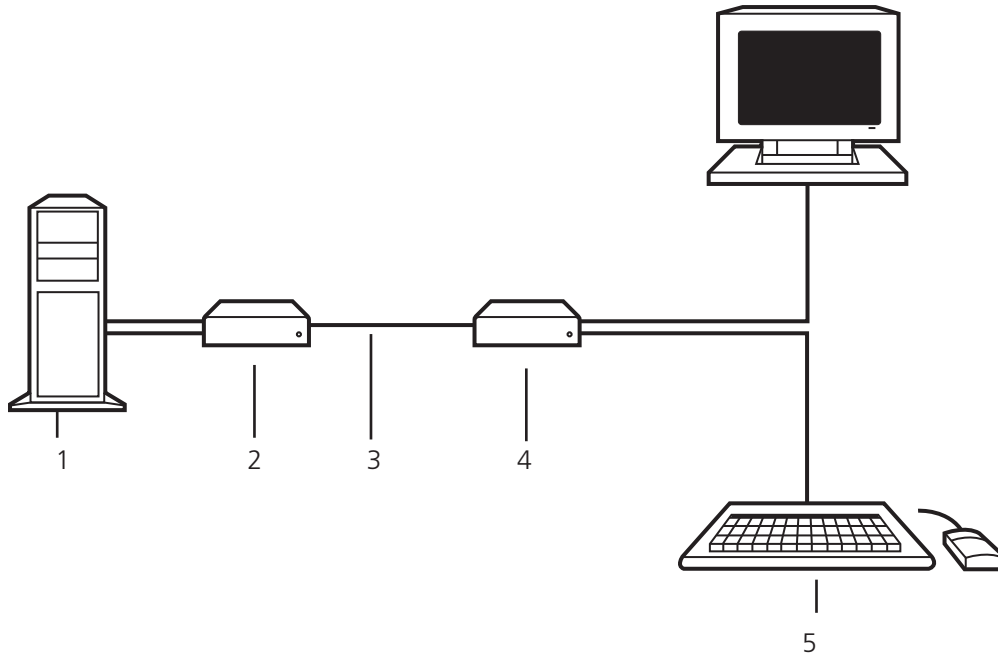

Figure 3-12. DKM Modular Extender (Single-Head).

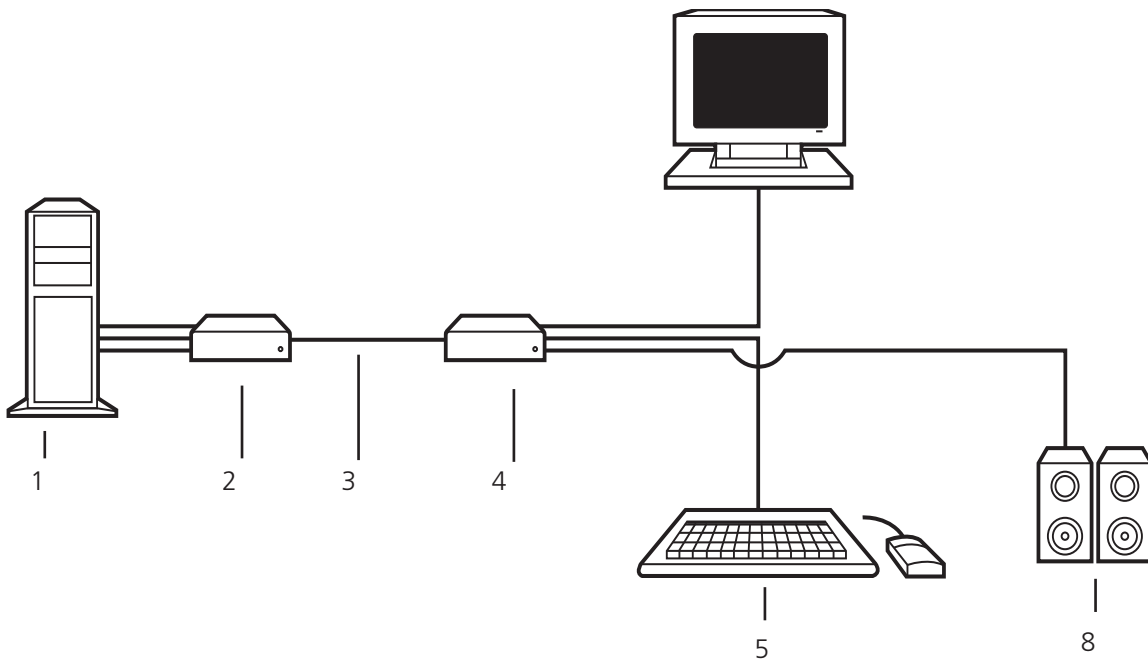

Figure 3-13. DKM Modular Extender (Single-Head with Digital/Analog Audio).

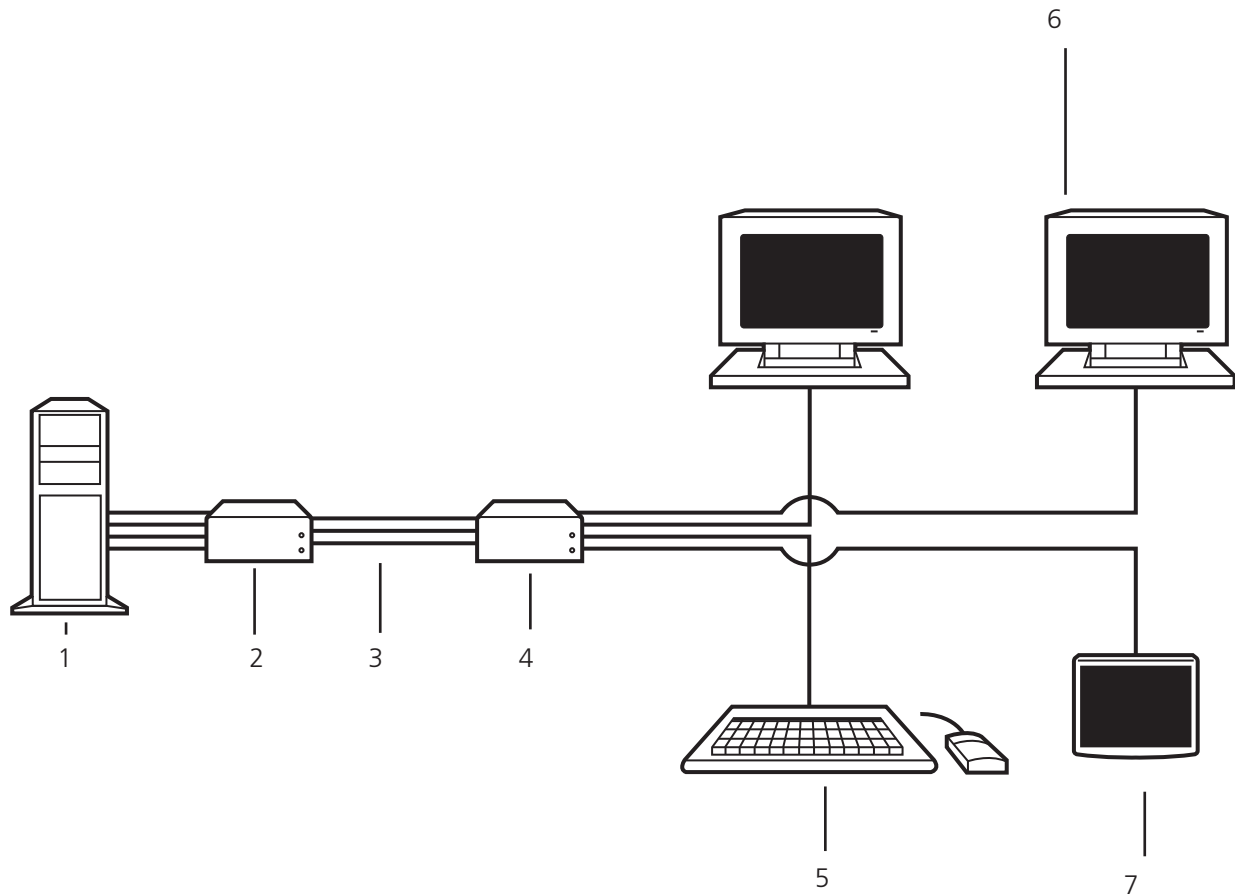

Figure 3-14. DKM Modular Extender (Dual-Head with 4x USB-HID).

Table 3-1. Components in Figures 3-12 through 3-14.

Number	Description
1	Source (computer, CPU)
2	DKM Modular Extender CPU Unit
3	Interconnect cable
4	DKM Modular Extender CON Unit
5	Console (keyboard, monitor, mouse)
6	Second monitor (option, only with Dual-Head devices)
7	USB-HID devices (option, only with [4] USB-HID devices)
8	Audio sink (optional, only with devices with analog audio/serial option or digital audio option)

4. Configuration

4.1 Transmission Parameters

The device operates with a proprietary compression method. In its default configuration, the device adapts dynamically to monitor resolution and image content. This configuration works in almost all conditions. Modify it only if image quality is not fully satisfactory.

NOTE: In exceptional cases, detached "frame droppings" (loss of single pictures) or color effects can appear.

4.2 DDC Settings

By default, the device sends the factory preset DDC information to the CPU. This information works in most cases.

During normal operation, you can download the console monitor's DDC information (see Chapter 5: Operation).

For special requirements, DDC information can be retrieved and uploaded as a binary file at both the CPU Unit and the CON Unit.

Connect your computer with a USB Mini cable to the CPU Unit's or CON Unit's service port.

You can now access the data area of the unit as a flash drive "Extender."

Uploading DDC Information

Copy the binary file containing your specific DDC information to the flash drive of the CPU Unit or CON Unit.

The current DDC information is replaced.

Retrieving DDC Information

Copy the file "DDC-EDID.bin" on the flash drive of the CPU Unit to your computer.

To open the binary file, you have to install a suitable software, for example, WinDDCwrite (Download), on your computer.

Reset to Factory DDC Information

Delete the file called "DDC-EDID.bin" on the flash drive of the CPU Unit. By deleting this file, the factory DDC Information is restored.

4.3 Command Mode

During normal use, the console keyboard functions in the usual manner. However, for all KVM Extenders with USB-HID support, you can set the keyboard into a Command Mode by using a specific "hotkey" sequence. While in Command Mode, several functions are performed via keyboard commands. To exit Command Mode, press <Esc>. While in Command Mode, the LEDs Shift and Scroll on the console keyboard will flash.

NOTE: In Command Mode, normal keyboard and mouse operation will cease. Only selected keyboard commands are available.

Table 4-1 lists the keyboard commands to enter and to exit Command Mode and to change the hotkey sequence.

Table 4-1. Keyboard commands.*

Function	Keyboard Command
Enter Command Mode	2x <Left-Shift>/Hotkey
Exit Command Mode	<Esc>
Change Hotkey sequence	<Left-Ctrl> + <Left-Shift> + <C>, <Hotkey code>, <Enter>

*See Table 4-2 for keyboard command sequences descriptions.

Table 4-2. Keyboard command sequences.

Keyboard Sequence	Description
<Key> + <Key>	Press keys simultaneously
<Key>, <Key>	Press keys successively
2x<Key>	Press key quickly, twice in a row (similar to a mouse-click)

You can change the hotkey sequence to enter Command Mode. Table 4-3 lists the hotkey codes for the available key sequences.

Table 4-3. Hotkey codes.

Hotkey Code	Hotkey
1	<Left-Ctrl> + <Left-Shift> + <i>
2	2x <Scroll>
3	2x <Left-Shift>
4	2x <Left-Ctrl>
5	2x <Left-Alt>
6	2x <Right-Shift>
7	2x <Right-Ctrl>
8	2x <Right-Alt>

5. Operation

Download of DDC Information

By default, data from the internal DDC list is reported to the source (computer, CPU). If these settings do not lead to a satisfying result, you can download and store the console monitor's DDC information internally. The devices must be configured accordingly (see Section 4.2).

On all KVM Extenders with USB-HID support, the user can load the DDC information of the console monitor via keyboard command under operating conditions.

1. Enter Command Mode with the "hotkey" (see Section 4.2).
2. Press the <a> key to download the DDC information of the console monitor.

The screen goes black for a short time.

At the same time Command Mode is closed and the keyboard LEDs return to previous status.

This re-adjusts the video mode. You should have optimal screen quality. The CPU should now show the console monitor as the current screen, together with the available video resolutions.

The DDC information of the console monitor was loaded once.

To re-load the DDC information, repeat the operation.

During DDC transfer, the status LEDs on both CON and CPU units flash while reading (CON unit) and copying (CPU unit) information.

6. Troubleshooting

6.1 Blank Screen

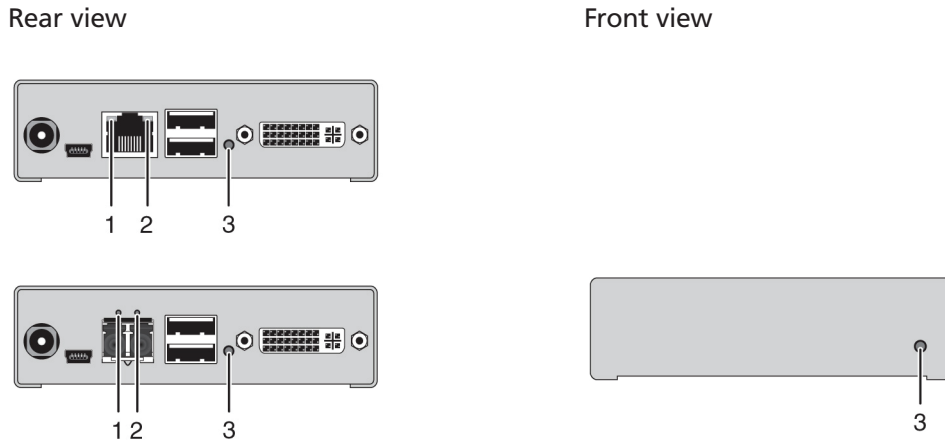

Figure 6-1. Blank screen.

Table 6-1. Blank screen troubleshooting.

Diagnosis	Possible Reason	Measure
LED 3 off	Power supply	<ul style="list-style-type: none"> • Check power supply units and the connection to the power network.
LED 1 on or LED 2 off	Connection between the CON unit and the CPU unit	<ul style="list-style-type: none"> • Check interconnect cables and connections.
CPU unit: LED 3 red or yellow	No video signal detected by source (computer, CPU)	<ul style="list-style-type: none"> • Check DVI-D cable to CPU. • Download DDC information from console monitors (see Chapter 5). Reboot CPU if necessary.
CON unit: LED 3 red or yellow	No monitor detected	<ul style="list-style-type: none"> • Check connection, length, and quality of the DVI-D cable to monitor; tighten cable thumbscrews.
	No video signal detected from CPU unit	<ul style="list-style-type: none"> • Check connection, length, and quality of the interconnect cables between the units. • Download DDC information from console monitors (see Chapter 5). Reboot CPU if necessary.

6.2 USB-HID

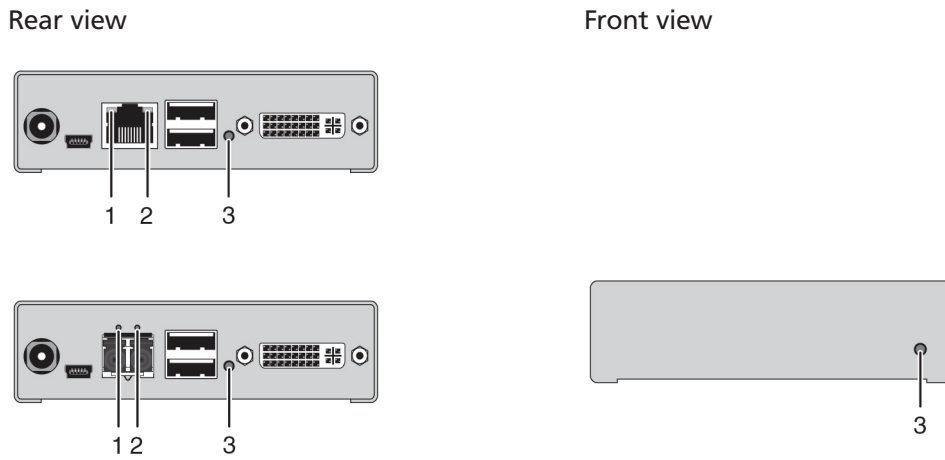

Figure 6-2. USB-HID.

Table 6-2. USB-HID troubleshooting.

Diagnosis	Possible Reason	Measure
Keyboard LEDs Shift and Scroll are blinking	Keyboard in command mode	<ul style="list-style-type: none"> • Press <Esc> to leave command mode
CPU unit: LED 3 green or violet	No USB connection to CPU	<ul style="list-style-type: none"> • Check connection of USB cable to CPU; select another USB port if necessary. • Remove USB and power cable and restart CPU. Connect power cable first.
CON unit: LED 3 green or violet	Problems with USB connection	<ul style="list-style-type: none"> • Check connection of USB cable to USB-HID device. • Remove DVI and power cable and restart CON unit. Connect power cable first.
USB device without function	No USB-HID device	<ul style="list-style-type: none"> • Connect USB-HID device.
	USB-HID device is not supported	<ul style="list-style-type: none"> • Contact Black Box Technical Support at 724-746-5500 or info@blackbox.com if necessary.

6.3 Serial Connection

Table 6-3. Serial connection troubleshooting.

Diagnosis	Possible Reason	Measure
Serial device not operational	Settings of the serial interface	<ul style="list-style-type: none"> • Check baud rate and general settings.
	No serial connection to CPU	<ul style="list-style-type: none"> • Check connection via serial cable.
	No serial connection to end device (for example, touchscreen, keyboard)	<ul style="list-style-type: none"> • Connect serial end device and switch it on. • Check connection via serial cable.
Touchscreen not operational	Hardware handshake	<ul style="list-style-type: none"> • Adjust serial interface to X-ON/X-OFF software handshake.

6.4 Analog Audio

Table 6-4. Analog audio troubleshooting.

Diagnosis	Possible Reason	Measure
CON unit: No signal at audio output	No audio connection to CPU/audio source	<ul style="list-style-type: none"> • Connect analog audio source. • Check audio cable.
	No signal	<ul style="list-style-type: none"> • Switch analog audio source on. • Activate analog output at CPU/audio source.
	No audio connection to audio sink (for example, speakers)	<ul style="list-style-type: none"> • Connect analog audio sink and switch it on. • Check connection of audio cable.
CPU unit: No signal at audio output (microphone)	No audio connection to audio source (microphone)	<ul style="list-style-type: none"> • Connect analog audio source (microphone). • Check connection of audio cable.
	No signal	<ul style="list-style-type: none"> • Switch analog audio source on. • Activate analog output at audio source.
	No audio connection to audio sink (for example, CPU)	<ul style="list-style-type: none"> • Check connection to CPU. • Check connection of audio cable. • Check audio configuration.

6.5 Digital Audio

CPU Unit, rear view

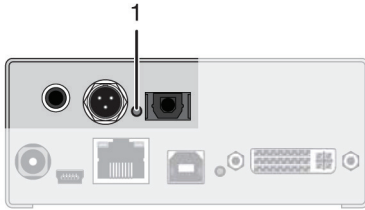

CON Unit, rear view

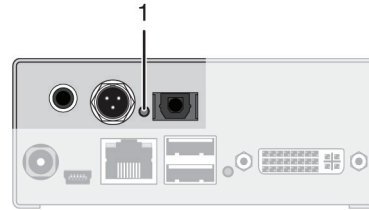

Figure 6-3. Digital audio option.

Table 6-5. Digital audio troubleshooting.

Diagnosis	Possible Reason	Measure
CPU unit: LED 1 red	No audio connection to CPU/audio source	<ul style="list-style-type: none"> • Connect digital audio source. • Check connection of audio cable.
	No signal	<ul style="list-style-type: none"> • Switch digital audio source on. • Activate digital output at CPU/audio source.
CON unit: LED 1 red	No audio connection to audio sink (for example, speakers)	<ul style="list-style-type: none"> • Connect digital audio sink. • Check connection of audio cable.
	No signal	<ul style="list-style-type: none"> • Check signal at CPU unit.
No signal/LEDs 1 OK	Digital silence at active audio source	<ul style="list-style-type: none"> • Check LEDs at CPU unit. • Check audio format. • Change audio input.

6.6 USB-HID Add-On



Figure 6-4. USB-HID Add-on.

Table 6-6. USB-HID Add-on troubleshooting.

Diagnosis	Possible Reason	Measure
LEDs 1 and 2 off	Device at higher/lower USB-HID port not detected	<ul style="list-style-type: none"> • Check connection of USB cable to USB-HID device. • Connect USB-HID device. • Contact Black Box Technical Support at 724-746-5500 or info@blackbox.com if necessary.
CPU unit: LED 3 off	Connection between CON unit and CPU unit	<ul style="list-style-type: none"> • Check interconnect cable and connectors.
CON unit: LED 3 off	Keyboard in command mode	<ul style="list-style-type: none"> • Press <Esc> to leave command mode.
CON unit: LED 3 flashing slowly	Connection between CON unit and CPU unit	<ul style="list-style-type: none"> • Check interconnect cable and connections.
	Keyboard in command mode	<ul style="list-style-type: none"> • Press <Esc> to leave command mode.

6.7 USB 2.0 Upgrade Module

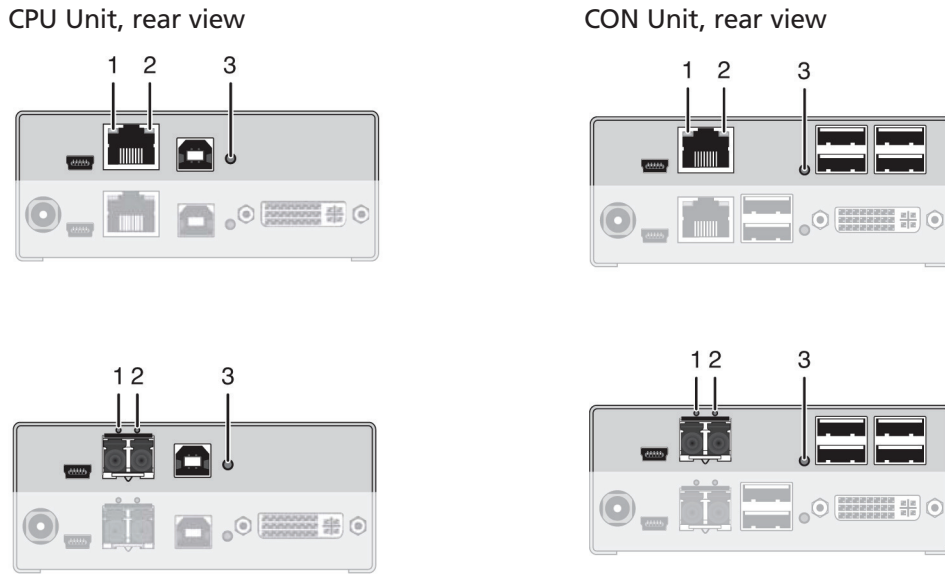

Figure 6-5. USB 2.0 upgrade module.

Table 6-7. USB 2.0 Upgrade Module troubleshooting.

Diagnosis	Possible Reason	Measure
CPU unit: All LEDs off	No connection to CPU	<ul style="list-style-type: none"> • Check connection USB cable to CPU; select another USB port if necessary. • Remove USB and power cable and restart CPU. Connect power cable first.
CON unit: LED 3 red	Connection between CON unit and CPU unit	<ul style="list-style-type: none"> • Check interconnect cable and connectors.
CON unit: LED 3 flashing green/turquoise and USB 2.0 device without function	No USB 2.0 device	<ul style="list-style-type: none"> • Connect USB 2.0 device.
	USB 2.0 device is not supported	<ul style="list-style-type: none"> • Check installation at the CPU. Also check to make sure the CPU has the necessary drivers. • New connection of the USB 2.0 device. • Contact Black Box Technical Support at 724-746-5500 or info@blackbox.com if necessary.

7. Technical Support

7.1 Contacting Black Box

If you determine that your ServSwitch DKM Compact Extender is malfunctioning, do not attempt to alter or repair the unit. It contains no user-serviceable parts. Contact Black Box Technical Support at 724-746-5500 or info@blackbox.com.

Before you do, make a record of the history of the problem. We will be able to provide more efficient and accurate assistance if you have a complete description, including:

- the nature and duration of the problem.
- when the problem occurs.
- the components involved in the problem.
- any particular application that, when used, appears to create the problem or make it worse.

7.2 Shipping and Packaging

If you need to transport or ship your ServSwitch DKM Compact Extender:

- Package it carefully. We recommend that you use the original container.
- If you are returning the unit, make sure you include everything you received with it. Before you ship for return or repair, contact Black Box to get a Return Authorization (RA) number.

8. Glossary

The following terms are commonly used in this guide or in video and KVM technology:

AES/EBU: Digital audio standard that is officially known as AES3. It's used to carry digital audio signals between devices.

CATx: Any CAT5e (CAT6, CAT7) cable

CGA: The Color Graphics Adapter (CGA) is an old analog graphic standard that displays up to 16 colors and at a maximum resolution of 640 x 400 pixels.

Component Video: The Component Video (YPbPr) is a high-quality video standard that consists of three independently and separately transmittable video signals: the luminance signal and two color difference signals.

Composite Video: The Composite Video is also called FBAS and it is part of the PAL TV standard.

CON Unit: Component of a DKM Modular Extender or Media Extender to connect to the console (monitor(s), keyboard and mouse; optionally also with USB 2.0 devices).

CPU Unit: Component of a DKM Modular Extender or Media Extender to connect to a source (computer, CPU).

DDC: The Display Data Channel (DDC) is a serial communication interface between monitor and source (computer, CPU). It can exchange data via a monitor cable and the operating system can install and configure a monitor driver automatically.

Access: A system to operate a source (computer, CPU) from two consoles.

Dual-Head: A system with two video connections.

Dual-Link: A DVI-D interface for resolutions up to 2560 x 2048 that transmits signals up to 330 MPixel/s (24-bit)

DVI: Digital video standard, introduced by the Digital Display Working Group (<http://www.ddwg.org>). Single Link and Dual Link standard are distinguished. The signals have TMDS level.

DVI-I: A combined signal (digital and analog) that allows running a VGA monitor at a DVI-I port—in contrast to DVI-D (see DVI).

Fiber: Single-mode or multimode fiber cables.

EGA: The Enhanced Graphics Adapter (EGA) is an old analog graphics standard, introduced by IBM in 1984. It uses a DB9 connector for connection.

FBAS: The analog color video baseband signal (FBAS) is also called Composite Video and it is part of the PAL TV standard.

Console: Keyboard, mouse and monitor.

KVM: Keyboard, video and mouse.

Mini-XLR: Industrial standard for electrical plug connections (3-pole) for the transmission of digital audio and control signals.

Multimode: 62.5 μ fiber cable or 50 μ fiber cable

OSD: The On-Screen-Display displays information or operates a device.

Quad-Head: A system with four video connections.

RCA (Cinch): A not standardized plug connection that transmits electrical audio and video signals, especially with coaxial cables.

SFP: Small Form-Factor Pluggables (SFPs) are pluggable interface modules for Gigabit connections. SFP modules are available for CATx and fiber interconnect cables.

S/PDIF: A digital audio interconnect that is used in consumer audio equipment over relatively short distances.

Single-Head: A system with one video connection.

Single Link: A DVI-D interface that supports resolutions up to 1920 x 1200 by transmitting signals up to 165 Megapixels per second (24-bit). Alternative frequencies are Full HD (1080p), 2K HD (2048 x 1080), and 2048 x 1152.

Single-mode: 9 μ fiber cable

S-Video (Y/C): The S-Video (Y/C) is a video format that transmits luminance and chrominance signals separately. It has a higher quality standard than FBAS.

TOSLINK: Standardized fiber connection system that digitally transmits audio signals (F05 plug connection).

Triple-Head: A system with three video connections.

USB-HID: USB-HID devices (Human Interface Device) allow for data input. There is no need for a special driver during installation; "New USB-HID device found" is reported. Typical HID devices include keyboards, mice, graphics tablets, and touchscreens. Storage, video, and audio devices are not HID.

VGA: Video Graphics Array (VGA) is a computer graphics standard with a typical resolution of 640 x 480 pixels and up to 262,144 colors. It follows the graphics standards MDA, CGA and EGA.

Black Box Tech Support: FREE! Live. 24/7.

Tech support the
way it should be.



Great tech support is just 60 seconds away at 877-877-2269 or blackbox.com.



About Black Box

Black Box provides an extensive range of networking and infrastructure products. You'll find everything from cabinets and racks and power and surge protection products to media converters and Ethernet switches all supported by free, live 24/7 Tech support available in 60 seconds or less.

© Copyright 2016. Black Box Corporation. All rights reserved.

acx1t-acx1r_user_rev2

877-877-2269 | blackbox.com