



User Guide (Ver. 2.2)

Models: Desktop - N4/8/16NS, N4/8/16NSP, N16NSF
 Wall Mount - N4/8/16WNS, N4/8/16WNSP

4/8/16 Channel Network Video Recorder



About This User's Guide

Before operating the unit, please read this user's guide thoroughly and retain it for future reference.

Cautions

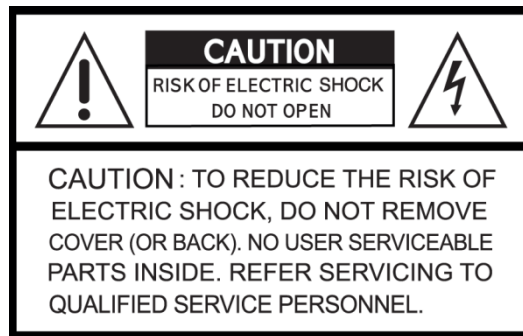

Explanation of Graphical Symbols



This symbol indicates the presence of important operating and maintenance (servicing) instructions in the literature accompanying the product.



This symbol indicates the presence of “dangerous voltage” within the product’s enclosure that may be of sufficient magnitude to constitute a risk of electric shock, property damage, personal injury, or death.

WARNING

To reduce a risk of fire or electric shock, do not expose this product to rain or moisture.

CAUTION

Changes or modifications not approved by the manufacture will void the warranty of the product.

Using an incompatible battery may increase the risk of fire or explosion.

Replace only with the same or equivalent type battery recommended by the manufacture.

Discard used batteries according to manufacturer’s instructions.

These precautions must be followed for safety reasons



Warning

- Do not use if the unit emits smoke.
- Do not disassemble the unit.
- Do not place any heavy or sharp objects on the unit.
- Do not place on uneven surface.
- Do not expose to shock or vibration.
- Do not move the unit when the unit is powered on.
- Do not block, and allow dust to accumulate in the air vents.
- Do not restrict airflow of the unit; doing so can damage the unit.
- Only qualified and experienced personnel should perform installation and servicing.
- Turn off the power of the NS when connecting Cameras, Audio or Sensor Cables.
- The manufacturer is not responsible for any damage caused by improper use of the product or failure to follow instructions for the product.
- The manufacturer is not responsible for any problems caused by or resulting from the user physically opening the NS for examination or attempting to repair the unit.
- For NSP models with the PoE Switch, it is strongly recommended that the 48V connector is inserted to the PoE Switch before the AC cable is attached to the adaptor.

Product Components

Please make sure the following components are included as specified below.

Desktop:

N4NS / N8NS / N16NS

N4NSP / N8NSP / N16NSP

N16NSF

Wall Mount:

N4WNS/ N8WNS / N16WNS

N4WNSP / N8WNSP / N16WNSP



Remote Control



Battery 1.5V (AAA x 2 EA)



Quick Setup Guide & User Guide

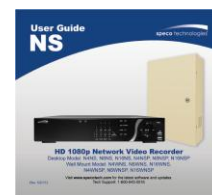
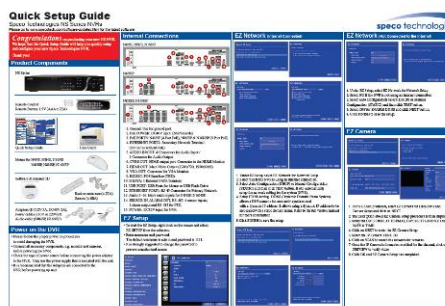

Mouse for NS



Software & Manual CD



Rack mount (x 2EA) & Screws (x 6EA)

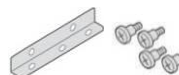

Power Adaptor

(DC12V 5A for NS)

& Power cable (110V or 220V)

Only power cable for N16NSF (AC 110V~240V)

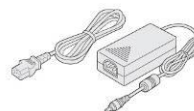

Power Adaptor

(DC48V 2A for POE)

& Power cable (110V or 220V)

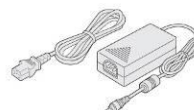

Audio Cable for NS



Specifications for NS/NSP

MODEL			N4NS	N8NS	N16NS	N4NSP	N8NSP	N16NSP
Video	Input	IP Cameras	4	8	16	4	8	16
		Max Bit Rate	20Mbps	40Mbps		20Mbps	40Mbps	
		Resolution	Max. 1920x1080					
	Output	Main Monitor	VGA and HDMI					
		Sub Monitor	CVBS (BNC)					
Audio	Input	IP Cam Audio	4	8	16	4	8	16
		RCA Input	4	8	16	4	8	16
	Output	RCA Output	1					
	Audio Codec		G.711					
Event	Sensor In	IP Cam Sensor	4	8	16	4	8	16
		Local Input	4 (Terminal Block)					
	Local Alarm Output (Terminal Block)		1					
	IP Camera Motion Detection		Yes					
Serial	RS-232C		Yes					
	RS-485		Yes					
Network	Private (IP Camera, Auto Connection)		10/100 Base-T	10/100/1000 Base-T		4 Port PoE		8 Port PoE
	LAN (Remote Access, IP Camera)		10/100 Base-T	10/100/1000 Base-T		10/100 Base-T		10/100/1000 Base-T
	Protocols		TCP/IP, UDP, DHCP, HTTP, NTP, SMTP, RTP, RTSP, ONVIF					
Recording	Compression		H.264 (Baseline, Main, High Profile)					
	Resolution & Frame Rate	D1	120fps	240fps	480fps	120fps	240fps	480fps
		1280x720	120fps	240fps	400fps	120fps	240fps	400fps
		1920x1080	100fps	192fps	192fps	100fps	192fps	192fps
	Recording Mode		Continuous / Motion / Sensor / Schedule / Manual					
	Pre Recording		Max. 20 Minutes					
	Post Recording		Max. 60 Seconds					
Playback	Search		Quick Search, Date/Time, Event, Archive, Log					
	Multi-Decoding		1, 4	1, 4, 8	1, 4, 8, 16	1, 4	1, 4, 8	1, 4, 8, 16
	Playback Speed		x0.25, x0.5, x2, x4, x8, x16, x32, x64					
Backup	Media		USB drive, External HDD, Network, DVD-R (via USB)					
	File Format		BMP, AVI, Proprietary Format					
	Large Backup		Yes (Max. 24 hours)					
Storage	HDD	1 HDD Max Size	3TB					
		Internal HDDs	3			2		
		e-SATA	1					
	USB	Front	2					
		Rear	1					

User I/F	Input Method	Front Buttons, IR, Mouse, Keyboard Controller	
Features	Dynamic DNS	Yes (Free DDNS)	
	Digital Zoom	Yes	
	DLS (Day Light Savings)	Yes	
	NTP (Network Time Protocol)	Yes	
	S.M.A.R.T.	Yes	
	Internal Beep	Yes	
	Multi-Language	Yes	
	e-mail Notification	Yes	
Network Access	3G Mobile	iPad / iPhone / Android	
	Web Viewer	Windows (IE, Chrome, Firefox, Safari), MAC(TBD)	
	PC Client	Single / Multi Client and CMS (64 channels)	
	Remote Setup and Upgrade	Yes	
Power	Total POE Budget	48W for the 4NSP, 96W for 8/16NSP	
	Power Supply Voltage	DC12V 5A	DC12V 5A & DC48V 2A
Temperature	Operating Temperature	41°F ~ 104°F (5°C ~ 40°C)	
	Storage Temperature	14°F ~ 122°F (-10°C ~ 50°C)	
Weight	Desktop Unit Weight (Gross weight)	Approximately 11 lbs	Approximately 12 lbs
	Wall Mount (Gross weight)	Approximately 16 lbs	Approximately 17 lbs
Dimension	Unit Dimension (W x D x H)	15"W x 13.4"D x 2.8"H (380mm x 340mm x 72mm)	
	Wall Mount (W x D x H)	13.5" x 3.5" x 17"	

Please note that specifications and unit exterior design are subject to change without notification.

Specifications for N16NSF

MODEL			N16NSF
Video	Input	IP Cameras	16
		Max Bit Rate	40Mbps
		Resolution	Max. 1920x1080
	Output	Main Monitor	VGA and HDMI
		Sub Monitor	CVBS (BNC)
Audio	Input	IP Cam Audio	16 (#1~#4: RCA, #5~#16: Audio Cable)
		RCA Input	16
	Output	RCA Output	1
	Audio Codec		G.711
Event	Sensor In	IP Cam Sensor	16
		Local Input	4 (Terminal Block)
	Local Alarm Output (Terminal Block)		1
	IP Camera Motion Detection		Yes
Serial	RS-485		Yes
Network	Private (IP Camera, Auto Connection)		16 Port PoE
	LAN (Remote Access, IP Camera)		10/100/1000 Base-T
	Protocols		TCP/IP, UDP, DHCP, HTTP, NTP, SMTP, RTP, RTSP, ONVIF
Recording	Compression		H.264 (Baseline, Main, High Profile)
	Resolution & Frame Rate	D1	480fps
		1280x720	400fps
		1920x1080	192fps
	Recording Mode		Continuous / Motion / Sensor / Schedule / Manual
	Pre Recording		Max. 20 Minutes
	Post Recording		Max. 60 Seconds
Playback	Search		Quick Search, Date/Time, Event, Archive, Log
	Multi-Decoding		1, 4, 8, 16
	Playback Speed		x0.25, x0.5, x2, x4, x8, x16, x32, x64
Backup	Media		USB drive, External HDD, Network
	File Format		BMP, AVI, Proprietary Format
	Large Backup		Yes (Max. 24 hours)
Storage	HDD	1 HDD Max Size	3TB
		Internal HDDs	Up to 2 HDDs
		e-SATA	1
	USB	Front	2
		Rear	1
User I/F	Input Method		Front Buttons, IR, Mouse, Keyboard Controller

Features	Dynamic DNS	Yes (Free DDNS)
	Digital Zoom	Yes
	DLS (Day Light Savings)	Yes
	NTP (Network Time Protocol)	Yes
	S.M.A.R.T.	Yes
	Internal Beep	Yes
	Multi-Language	Yes
	e-mail Notification	Yes
Network Access	3G Mobile	iPad / iPhone / Android
	Web Viewer	Windows (IE, Chrome, Firefox, Safari), MAC(TBD)
	PC Client	Single / Multi Client and CMS (64 channels)
	Remote Setup and Upgrade	Yes
Power	Total POE budget	200W
	Power Supply Voltage	AC 110V ~ 240V, 50/60Hz, Max 250W
Temperature	Operating Temperature	41°F ~ 104°F (5°C ~ 40°C)
	Storage Temperature	14°F ~ 122°F (-10°C ~ 50°C)
Weight	Desktop Unit Weight (Gross weight)	Approximately 14 lbs
	Wall Mount (Gross weight)	Approximately 19 lbs
Dimension	Unit Dimension (W x D x H)	15"W x 13.4"D x 2.8"H (380mm x 340mm x 72mm)

Please note that specifications and unit exterior design are subject to change without notification.

Table of Contents

1.	Main Features	12
2.	Initial Boot-up Process.....	13
2-1.	Initial Boot up and Basic Time Setup.....	13
2-2.	Setting up Daylight Savings Time.....	14
2-3.	Setting NTP (Network Time Protocol).....	14
2-4.	EZ SETUP	17
2-5.	PoE Port SETUP.....	19
2-6.	Non PoE Port SETUP.....	22
2-7.	IP Camera SETUP (through Web Viewer page)	22
2-8.	Dual Streaming.....	23
3.	Front and Rear Panels	24
3-1.	Desktop Front Panel	24
3-2.	Connectors	25
3-3.	Remote Control.....	27
4.	Setting up the NS	28
4-0.	Setup – Main Live Screen	28
4-1.	Setup – IP CAMERA	29
4-1-1.	SCAN Menu	31
4-1-2.	ONVIF SETUP Menu.....	32
4-2.	Setup – SYSTEM.....	34
4-3.	Setup – RECORD Mode	37
4-3-1.	Recording Schedules.....	39
4-4.	Setup – DEVICE Mode	40
4-4-1.	Digital Deterrent.....	42
4-4-2.	Keyboard Controller & PTZ Setup.....	43
4-4-3.	Motion Zone Setup	44
4-5.	Setup – DISPLAY Mode.....	45
4-6.	Setup – NETWORK Mode.....	46
4-6-1.	Network Types.....	47
4-6-2.	DDNS	47
4-6-3.	Network Port and Web Port	48
4-7.	Setup – USER MANAGEMENT Mode.....	49
4-8.	Setup – STORAGE Mode	51
4-9.	Setup - CONFIG Mode.....	53
4-9-1.	Firmware Upgrade.....	54
5.	Live, Search and Playback	55
5-1.	Live View	55
5-1-1.	PTZ Control	59
5-2.	Digital Zoom in Live and Playback Screen	60

5-3. SEARCH Screen.....	60
5-3-1. EZSearch	61
5-3-2. Time Line Search.....	62
5-3-3. Event Search.....	62
5-3-4. Go To First Time	63
5-3-5. Go To Last Time	63
5-3-6. Go To Specific Time	63
5-3-7. Archive List	63
5-3-8. Log List.....	64
5-4. Play Mode.....	64
6. Back Up	66
6-1. Still Image Backup onto USB Flash Drive.....	66
6-2. Video Backup onto USB Flash Drive during playback	66
6-2. EZCopy: Video Backup onto USB Flash Drive during playback.....	68
6-3. Transferring Still Images or Video from the ARCHIVE List.....	69
6-4. Playback of Backup Video.....	69
6-5-1. AVI Format.....	69
6-5-2. NSF Format.....	70
7. Network Access Using the Multi-Sites Network Viewer	71
7-1. Overview.....	71
7-2. PC Requirements.....	71
7-3. Installation of the Program	72
7-4. Live Window.....	73
7-4-1. Main User Interface	73
7-4-2. Control Buttons.....	73
7-5. Search and Playback Window.....	74
7-5-1. Main User Interface	74
7-5-2. Main Control Panel	75
7-6. Setup of SpecoTech Multi Client.....	76
7-6-1. General.....	76
7-6-2. Event	77
7-6-3. Record.....	78
7-6-4. Display	79
7-6-5. Language	80
7-6-6. About	80
7-7. Remote Setup	81
7-7-1. IP Camera	82
7-7-2. System	82
7-7-3. Record.....	84
7-7-4. Device	85
7-7-5. Display	86

7-7-6. Network	86
7-7-7. User Management	87
7-7-8. Storage	88
7-7-9. Remote Upgrade	88
7-7-10. Information	88
7-8. Operation	89
7-8-1. Addition, Delete, and Modify of NS Sites.....	89
7-8-2. Connect and Disconnect.....	91
7-8-3. Still-image Capture During Live	92
7-8-4. Recording Video on Local PC During Live	92
7-8-5. Local Playback and Remote Playback.....	94
7-8-6. AVI Backup during Playback.....	96
8. Network Access Using the Web-Browser Viewer	98
9. Network Access Using the Smart Phone Viewer	100
9-1. App Viewer for iPhone.....	100
9-1-1. Live.....	100
9-1-2.PTZ Control	101
9-1-3. Playback.....	102
9-2. App Viewer for Android Phone.....	103
9-2-1. Live.....	103
9-2-2. Playback.....	104
9-2-3.PTZ Control	104
APPENDIX: Network Connection - LAN.....	105
APPENDIX: Network Connection – Internet and DDNS	107
APPENDIX: E-SATA CONNECTION.....	110

1. Main Features

- Automatic IP Camera Detection and connection (Plug & Play)
- Easy Record, Copy and Setup
- Easy Search by Thumbnail Preview
- Easy Copy
- Easy Network
- Easy IP Camera Setup

NOTE: Under federal law, The Fourth Amendment to the U.S. Constitution, Title III of the Omnibus Crime Control and Safe Streets Act of 1968, as amended by the Electronic Communications Privacy Act of 1986 (18 U.S.C. § 2510, *et seq.*), and the Foreign Intelligence Surveillance Act of 1978 (50 U.S.C. 1801, *et seq.*) permit government agents, acting with the consent of a party to a communication, to engage in warrantless interceptions of telephone communications, as well as oral and electronic communications.

- Covert camera operation provides enhanced security and administrator control
- Dynamically programmable recording priority, motion detection, alarms and scheduling
- Simple and Easy Graphic User Interface
- Simple Scheduler
- HDMI Output
- VGA Output
- Password to secure installation authorization
- Network software supports 10/100Mbps
- USB 2.0 port for video clip exporting and easy firmware upgrade via USB Flash Drive

2. Initial Boot-up Process

2-1. Initial Boot up and Basic Time Setup

1. During the first boot up, the following logo will be displayed.



2. After the logo, select the language and set date and time as specified below.

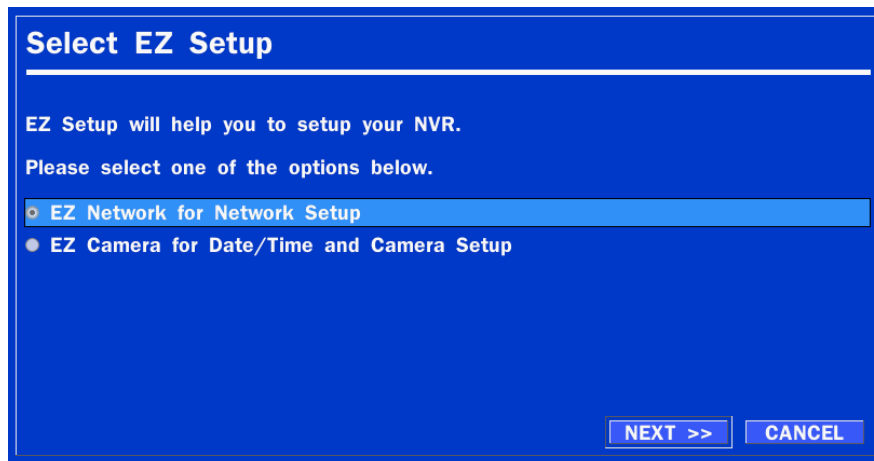

2-2. Setting up Daylight Savings Time

To enable Daylight Saving feature/NTP synchronization, take the following steps.

1. Enter the SETUP mode. The default Username is "ADMIN" and Password is "1111".



2. Go to SETUP > SYSTEM > DATE & TIME SETUP

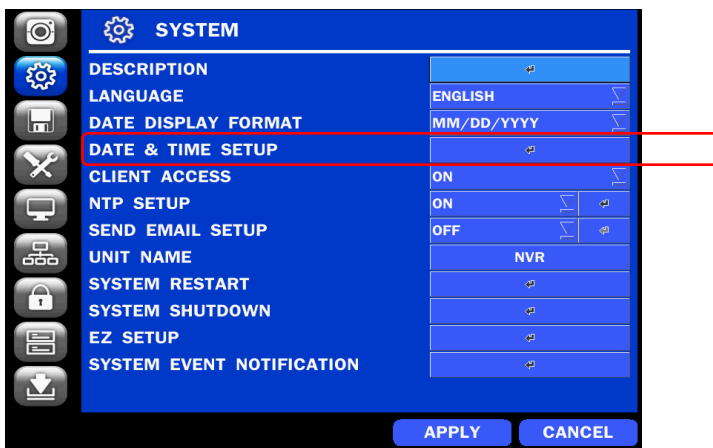

3. Select ON from the DAYLIGHT SAVING dropdown menu.



2-3. Setting NTP (Network Time Protocol)

1. SETUP > SYSTEM > NTP SETUP > ON

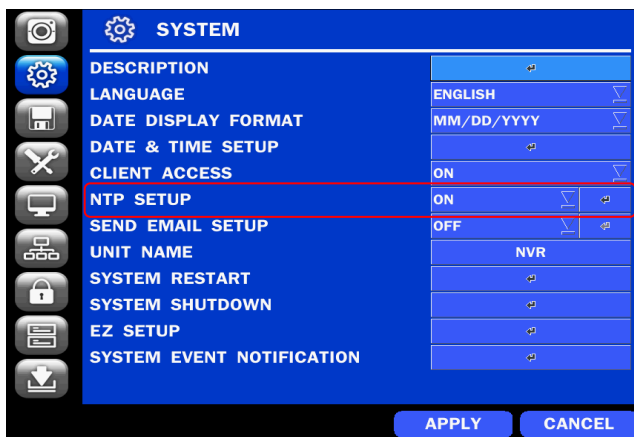

2. Select the proper TIME ZONE time.

PRIMARY SNTP SERVER: Pool.ntp.org
 SECONDARY SNTP SERVER: Time.nist.gov
 TIME ZONE: GMT -5:00 (Montreal/New York)
 CONNECTION MODE: TIME
 CONNECTION PERIOD: 03:00 AM

OK CANCEL

Table2.3.1. GMT Time Zone

	State	Standard Time	Daylight-Saving Time
AL	Alabama	GMT-6	GMT-5
AK	Alaska	GMT-9	GMT-8
AK	Alaska (Aleutian Islands)	GMT-10	NA
AZ	Arizona	GMT-7	NA
AZ	Arizona (Navajo)	GMT-7	GMT-6
AR	Arkansas	GMT-6	GMT-5
CA	California	GMT-8	GMT-7
CO	Colorado	GMT-7	GMT-6
CT	Connecticut	GMT-5	GMT-4
DC	District of Columbia	GMT-5	GMT-4
DE	Delaware	GMT-5	GMT-4
FL	Florida	GMT-5	GMT-4
FL	Florida (W)	GMT-6	GMT-5
GA	Georgia	GMT-5	GMT-4
HI	Hawaii	GMT-10	NA
ID	Idaho (N)	GMT-8	GMT-7
ID	Idaho (S)	GMT-7	GMT-6
IL	Illinois	GMT-6	GMT-5
IN	Indiana	GMT-5	GMT-4
IN	Indiana (SW / NW)	GMT-6	GMT-5
IA	Iowa	GMT-6	GMT-5
KS	Kansas	GMT-6	GMT-5
KS	Kansas (W)	GMT-7	GMT-6
KY	Kentucky (E)	GMT-5	GMT-4
KY	Kentucky (W)	GMT-6	GMT-5
LA	Louisiana	GMT-6	GMT-5
ME	Maine	GMT-5	GMT-4
MD	Maryland	GMT-5	GMT-4
MA	Massachusetts	GMT-5	GMT-4
MI	Michigan	GMT-5	GMT-4

MI	Michigan (W)	GMT-6	GMT-5
MN	Minnesota	GMT-6	GMT-5
MS	Mississippi	GMT-6	GMT-5
MO	Missouri	GMT-6	GMT-5
MT	Montana	GMT-7	GMT-6
NE	Nebraska	GMT-6	GMT-5
NE	Nebraska (W)	GMT-7	GMT-6
NV	Nevada	GMT-8	GMT-7
NH	New Hampshire	GMT-5	GMT-4
NJ	New Jersey	GMT-5	GMT-4
NM	New Mexico	GMT-7	GMT-6
NY	New York	GMT-5	GMT-4
NC	North Carolina	GMT-5	GMT-4
ND	North Dakota	GMT-6	GMT-5
ND	North Dakota (W)	GMT-7	GMT-6
OH	Ohio	GMT-5	GMT-4
OK	Oklahoma	GMT-6	GMT-5
OR	Oregon	GMT-8	GMT-7
OR	Oregon (E)	GMT-7	GMT-6
PA	Pennsylvania	GMT-5	GMT-4
RI	Rhode Island	GMT-5	GMT-4
SC	South Carolina	GMT-5	GMT-4
SD	South Dakota (E)	GMT-6	GMT-5
SD	South Dakota (W)	GMT-7	GMT-6
TN	Tennessee (E)	GMT-5	GMT-4
TN	Tennessee (W)	GMT-6	GMT-5
TX	Texas	GMT-6	GMT-5
TX	Texas (W)	GMT-7	GMT-6
UT	Utah	GMT-7	GMT-6
VT	Vermont	GMT-5	GMT-4
VA	Virginia	GMT-5	GMT-4
WA	Washington	GMT-8	GMT-7
WV	West Virginia	GMT-5	GMT-4
WI	Wisconsin	GMT-6	GMT-5
WY	Wyoming	GMT-7	GMT-6



NOTE: If you want the unit to automatically synchronize the local time, the Time Zone must be properly set according to your local time zone.

2-4. EZ SETUP

Quick installation Menu for NS and IP Camera Easy installation(Right-Click on the Main Screen)

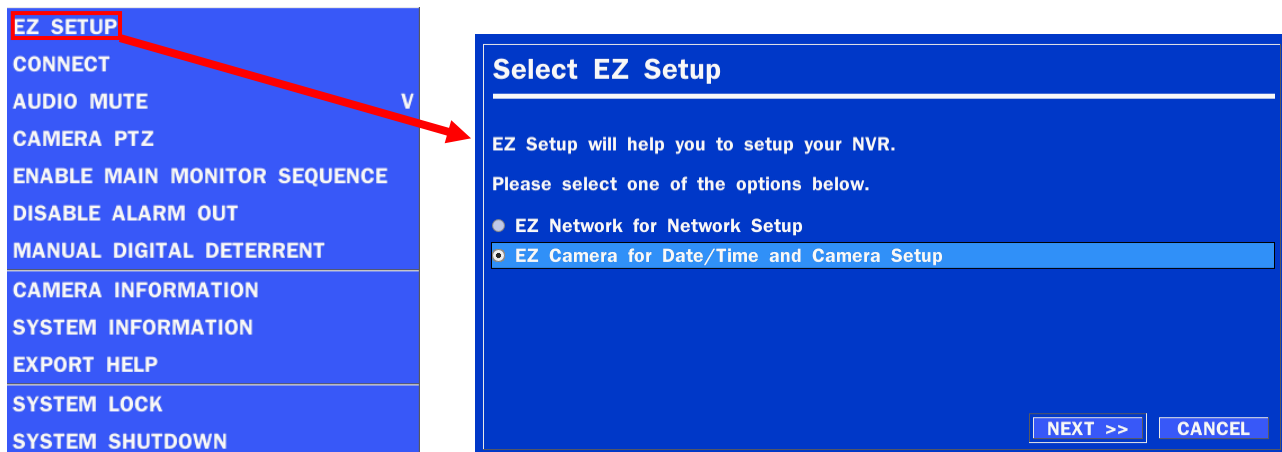

Figure 2.4. EZ Setup Screen

2.4.1. Setup DATE & TIME, IP CAMERA configurations.

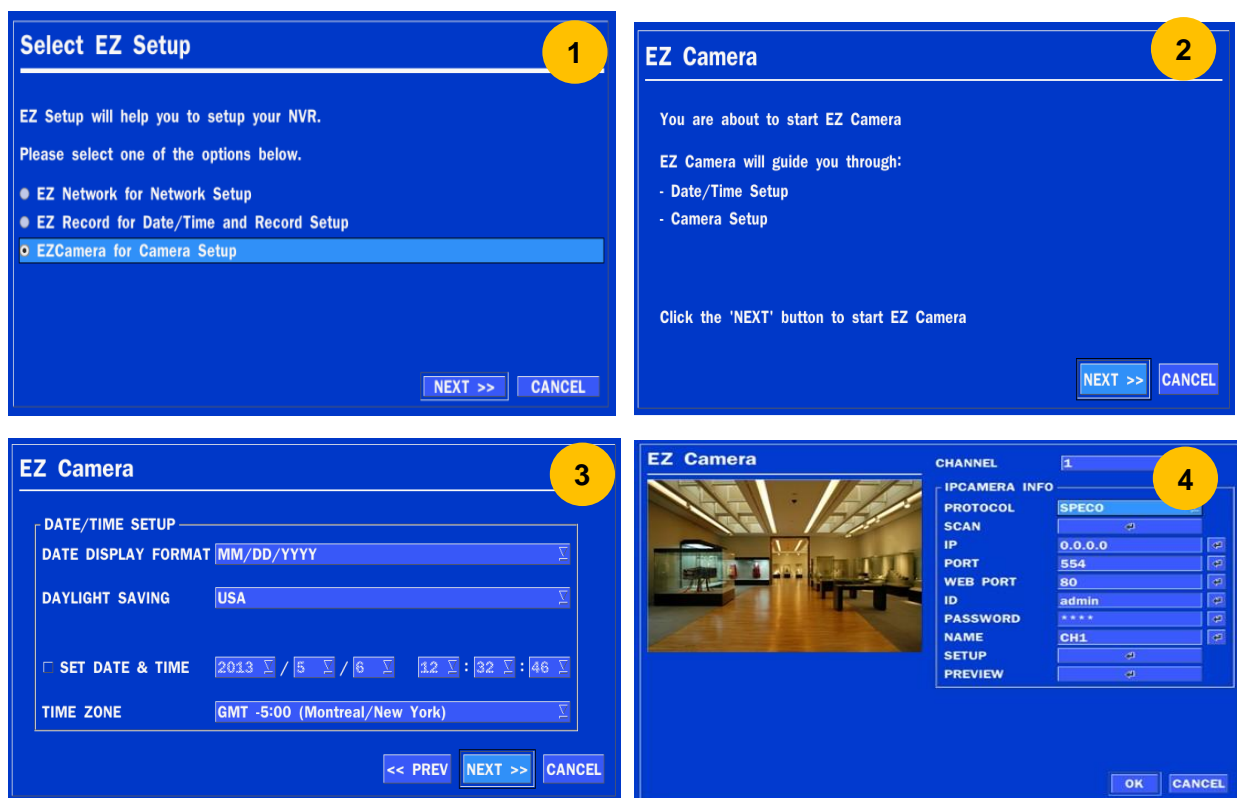

Figure 2.4.1. EZ CAMERA Setup Procedure

- ① Select EZ Camera for Date/Time and Camera Setup, Click NEXT to proceed.
- ② Description of EZ Camera Setup is displayed, Click NEXT to proceed.
- ③ Set up the Date/Time settings and click NEXT to get to the camera setup.
- ④ Configure individual cameras in the EZ Camera Setup.
 - Select the Channel to configure.
 - Select the Camera Protocol and then click on the scan button; this will scan the networks for any cameras from the particular protocol.
 - Select on the desired Camera from the list, and then check on register.

- If necessary, click on Preview to Preview the camera, or Setup to change camera settings.

2.4.2. EZ NETWORK

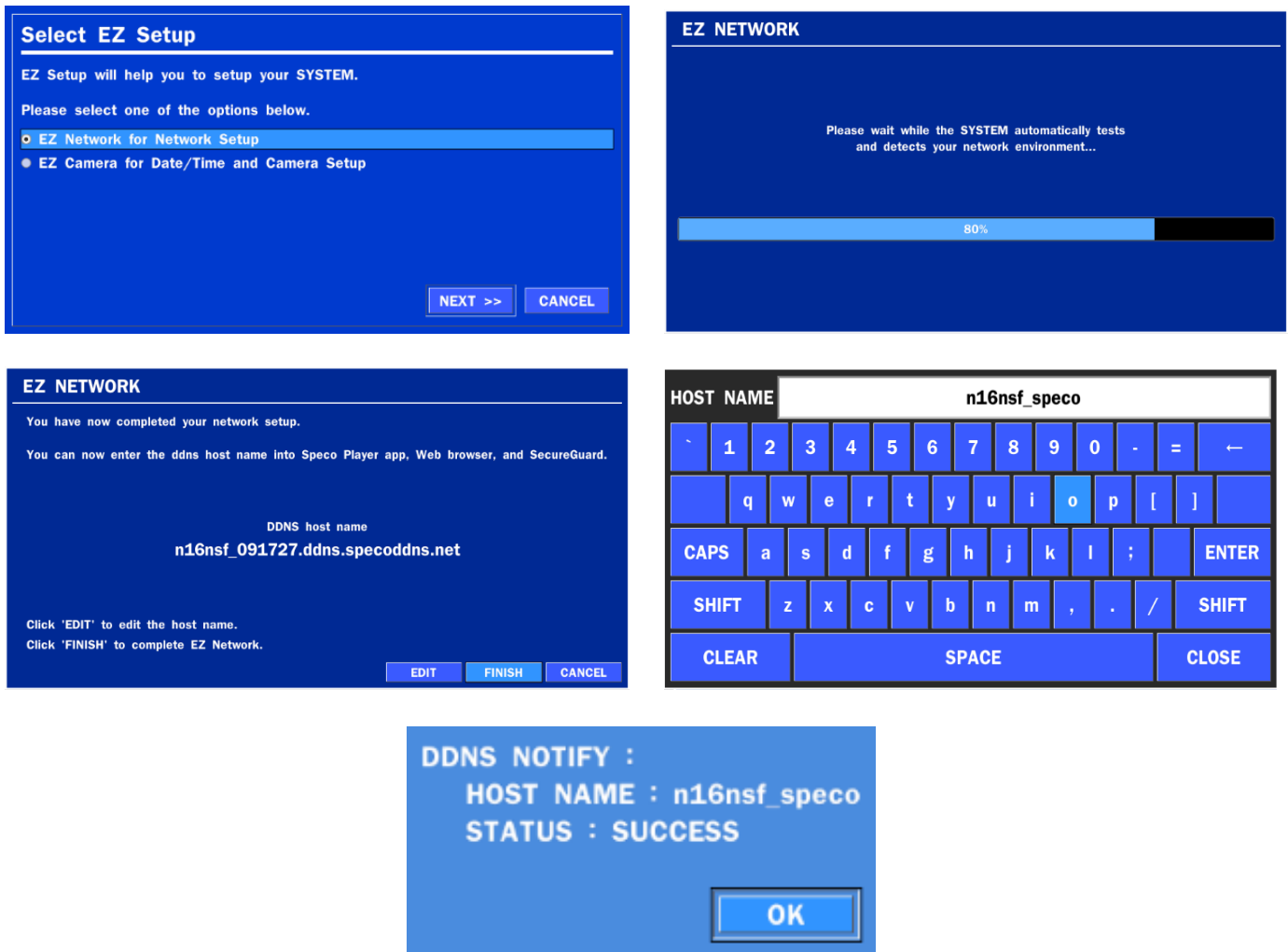

Figure 2.4.2. EZ NETWORK Setup Procedure

- ① Select EZ Network for Network Setup.
- ② It begins to test and detect the network environment automatically.
- ③ DDNS hostname will be setting up.
- ④ If needed, edit the hostname
- ⑤ When you finish EZ network setup and close the window, it displays the result.

2-5. PoE Port SETUP

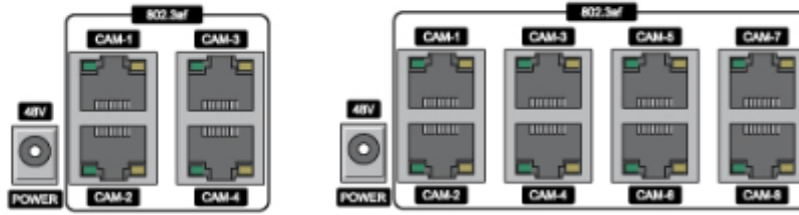

Figure 2.5.1 PoE Port (N4NSP / N8NSP & N16NSP)

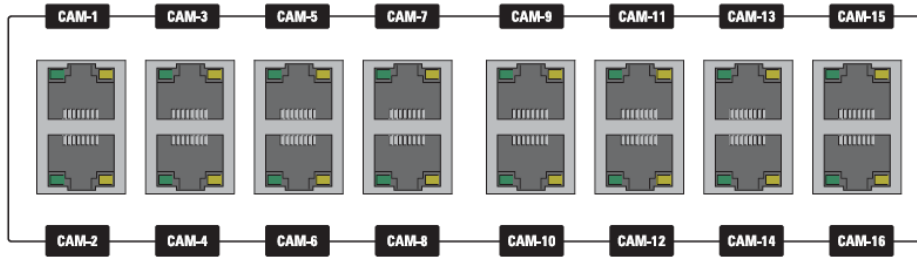

Figure 2.5.2 PoE Port (N16NSF)

2.5.1 Connecting the Camera(NSP Model)

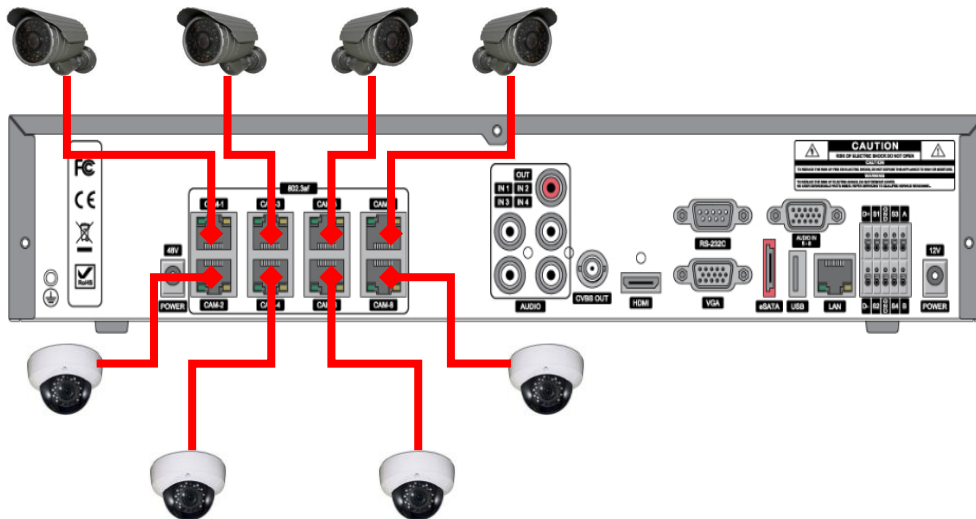

Figure 2.5.1.1 IP Camera Connection Diagram (N8NSP)

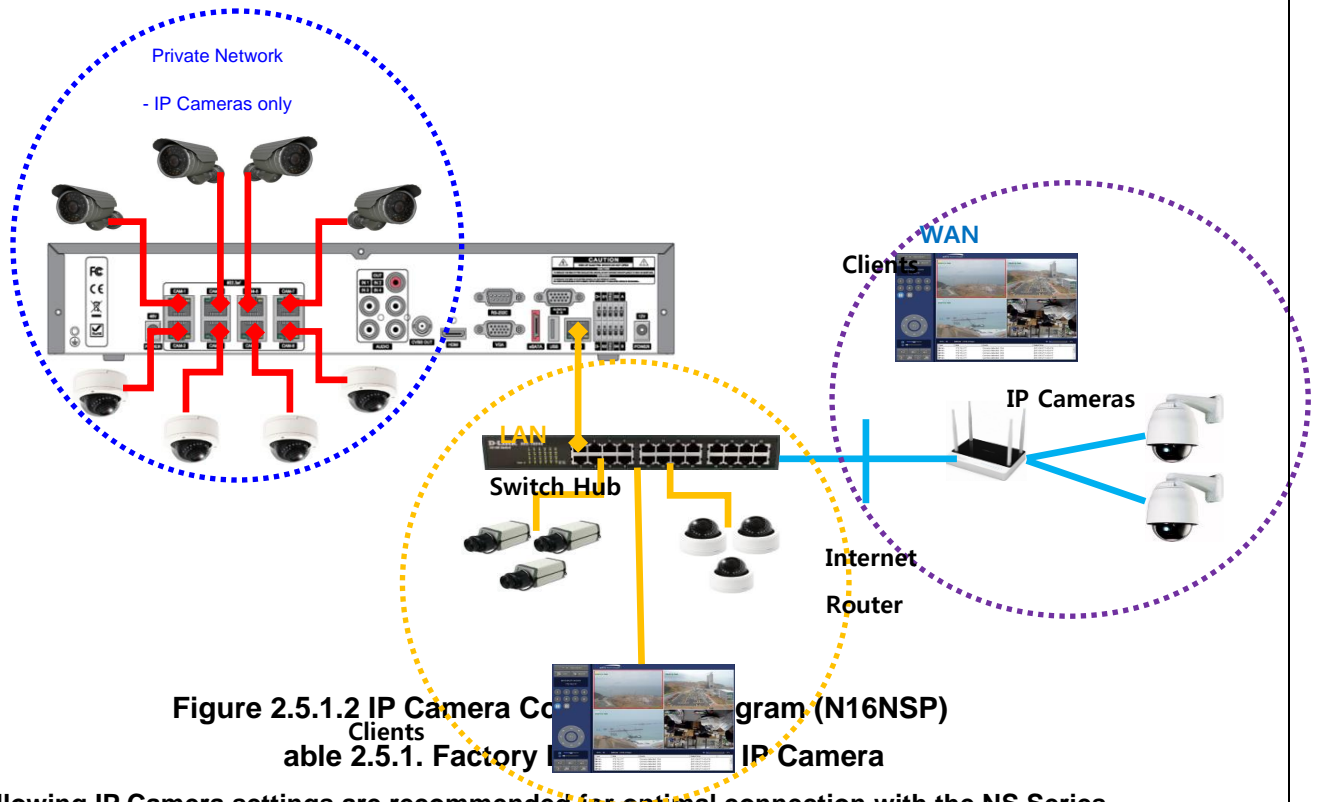

Figure 2.5.1.2 IP Camera Configuration (N16NSP)
Table 2.5.1. Factory Default IP Camera

The following IP Camera settings are recommended for optimal connection with the NS Series

Setup Items	Default	Description
Network Type	DHCP	The IP Camera must act as a DHCP client for the "Plug and Play".
Encoding Type	CBR	The "CBR" is recommended because of the internal buffer design of the NS Series
Resolution	1280x720	The maximum performance of the N16NS/NSP is 1080p@192fps or 720p@400fps. To get higher frame rates per channel, 1280x720 is the recommended resolution.
Frame Rate	25fps	The maximum performance of the N16NS/NSP is 720p@400fps. Therefore 25fps per channel is recommended. (25fps x 16 = 400fps)
Bit Rate	2Mbps	The maximum throughput of the N16NS/NSP is <u>40Mbps</u> . Therefore 2Mbps per channel is recommended. (2Mbps x 16 = 32Mbps)
Sub Stream	CIF 512Kbps	For "Dual Streaming", the sub stream should be turned on. And for the proper streaming through the WAN connection, CIF@512Kbps or lower bitrates per channel is recommended.

- The NSP Series features a "Plug and Play" function with a PoE Switch.
- The "Plug and Play" functionality requires the IP Camera to be in DHCP mode.
- The NS automatically assigns an IP Address to the IP Camera. (10.20.30.11 ~ 10.20.30.254)
- The NSP models will automatically map the camera on the PoE Port to the corresponding NVR channel number.
- The NSP PoE Port maximum power consumption [N4NSP – 48Watt, N8/16NSP – 96W]
- The NSF PoE Port Maximum power consumption [N16NSF – 200W]

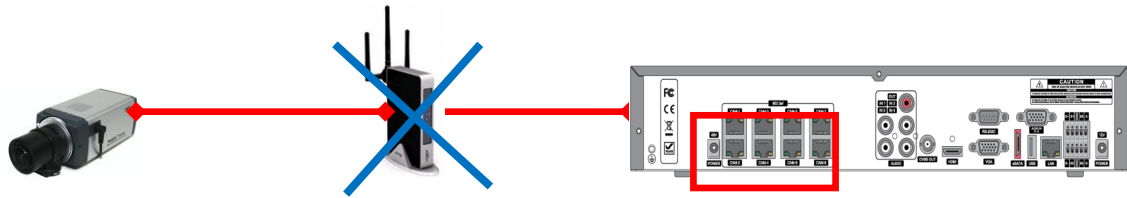

Figure 2.5.1.2. Incorrect connection with the PoE Ports

With the NSP Models, it is prohibited to connect a router to the POE Ports to connect the IP Camera, the NSP will not be able to find and connect to the camera. The LAN Port can be connected to a router, but not the PoE Ports.

2-6. Non PoE Port SETUP

2.6.1 Connecting the Camera (Non - PoE Model)

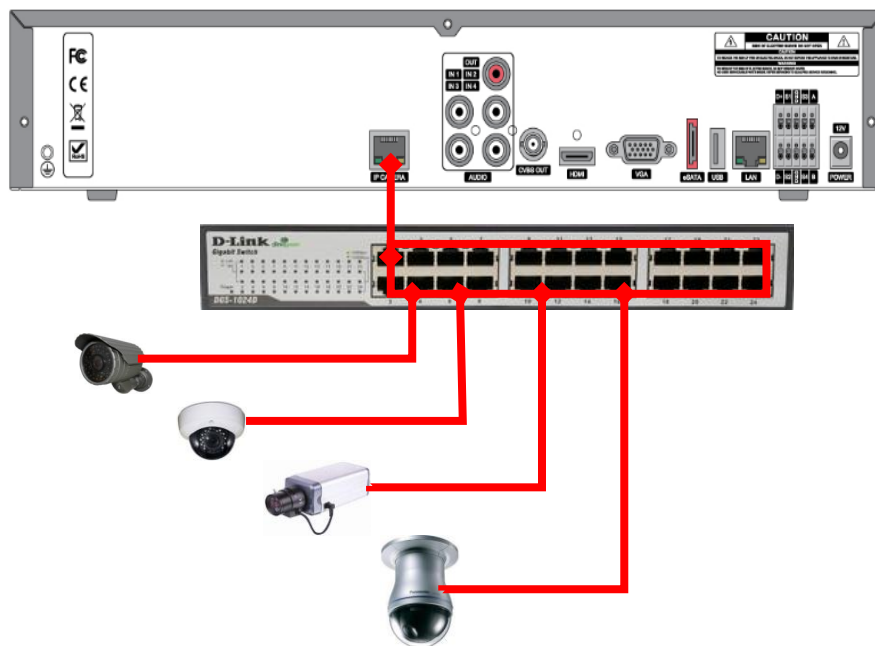
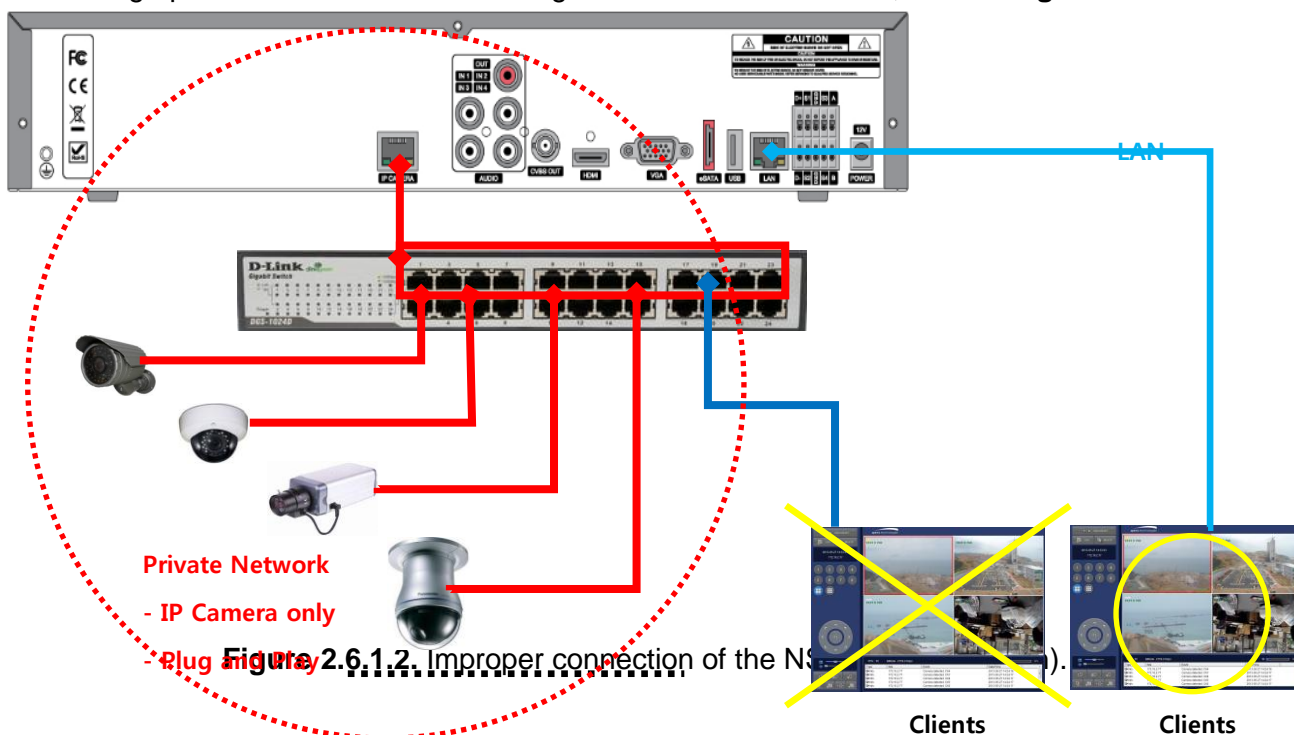

Figure 2.6.1.1. Proper connection example of the NS (Non PoE Switch).

- The NS Series features a "Plug and Play" function (on board PoE Switch not included).
- Setting up cameras can be done through the EZ CAMERA menu, refer to **Figure 2.4.1**.



Private Network
- IP Camera only
- Plug and Play

Figure 2.6.1.2. Improper connection of the NS (Non PoE Switch).

2-7. IP Camera SETUP (through Web Viewer page)

NS / NSP Series allow remote access to the IP Cameras through an "IP Camera Setup" menu. The PC Web Client features the "IP Camera Setup" menu that can be accessed remotely.



- ① Click the mouse right button
- ② Select "IP Camera Setup".
- ③ Select Channel Number.
- ④ It launches the camera's web setup page.

In order for the web pages to launch from the "IP Camera Setup" menu when accessed from the WAN, Ports 59011 to 59254 on the router must be port forwarded to the NVR. The local address of the NVR can be found in the system information

2-8. Dual Streaming

- High Quality (Main Profile) Video Stream is used for both Recording and Live Display.
- High Quality (Main Profile) Video Stream can be viewed through the network, when selected.
- Normal (Secondary) Quality Video Stream is used by default when viewing through the network.

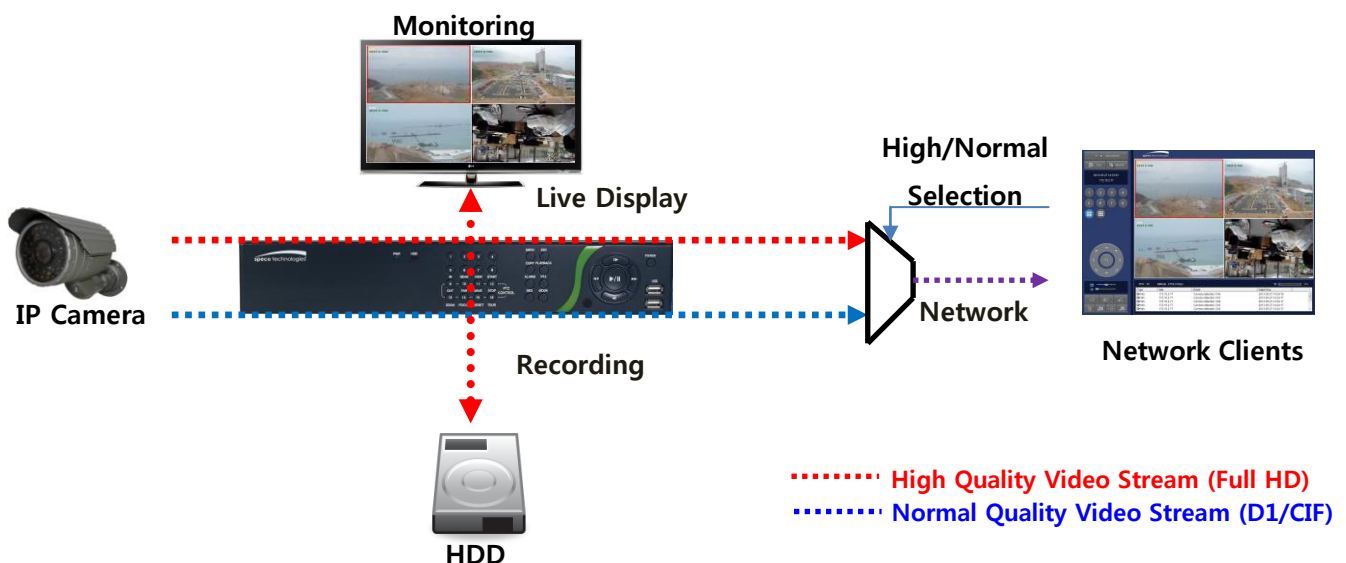

3. Front and Rear Panels

3-1. Desktop Front Panel









Figure 3.1.1. Desktop NS Front panel

Table 3.1.1. Front LED and Port of NS

Name	Description
POWER	LED light is on when power is applied to the system.
HDD	LED light is on when the system is recording video data.
USB Port	This USB port for archiving footage into a USB device. (USB 2.0)

Table 3.1.2. Front Buttons

Name	Description
Number1~16	Select a channel from CH1 to CH16.
	Buttons from 9 to 16 are used as function keys in PTZ control mode. To escaping PTZ mode, press the ESC button.
MENU	Enters the Setup Menu.
COPY	Takes a screenshot on Live and Backup button on Playback.
ALARM	Activates the external alarm device.
SEQ	Enable the sequence mode on Live.
ESC	Exits the current mode or cancel an operation.
PLAYBACK	Goes to search menu.
PTZ	Activate Pan, Tilt and Zoom menu operation.
MODE	Select the screen display mode (1x1, 2x2, 3x3, if applicable: 4x4, 1+7)
POWER	Initiates system shut down.
	LIVE mode – Up SEARCH mode - Jump 1min ahead on playback and 1 frame ahead on pause.
	LIVE mode – Right SEARCH mode - Control the play speed (Fast Forward).
	LIVE mode – Down SEARCH mode - Jump 1min back on playback and 1 frame back on pause.
	LIVE mode – Left SEARCH mode- Select the play speed (Rewind).
	LIVE mode – Select (Center) SEARCH mode - Play & Pause.

3-2. Connectors



- Do not power this system on before all the connections are completed.
- Make sure all the connections are properly secured. Faulty connection may result in the system being damaged.

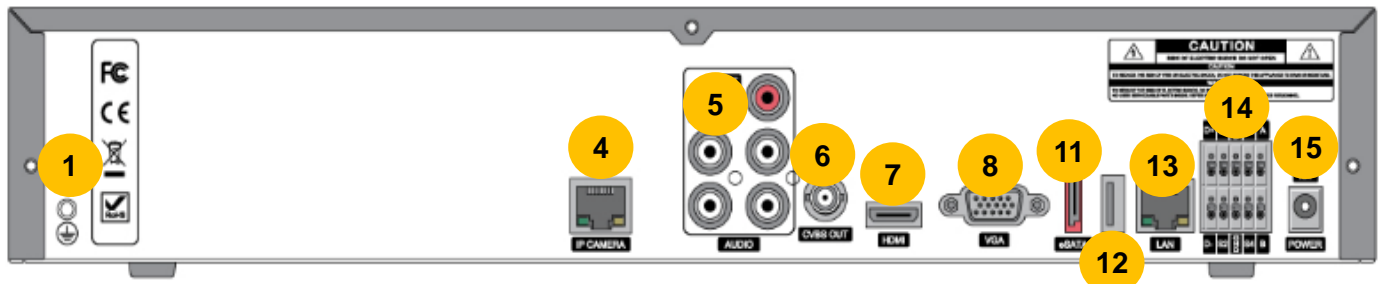

[N4/8/16NS]

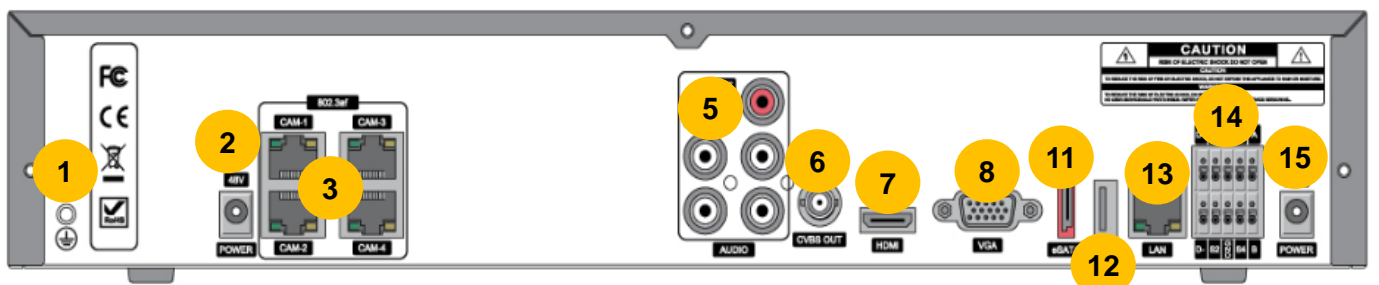

[N4NSP]

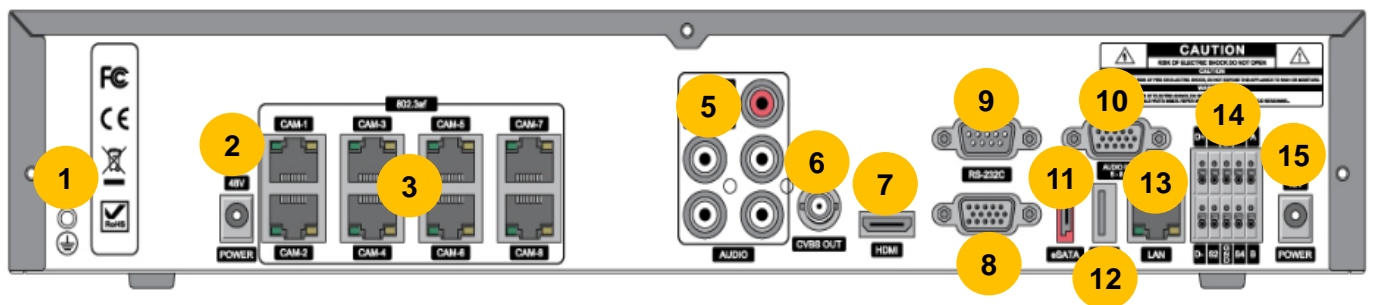

[N8/16NSP]

Figure 3.2.1. Connectors for NS/NSP

- ① Ground: Use for grounding.
- ② PoE POWER: DC48V input.(NSP Models)
- ③ PoE PORT: N4NSP (4 Port PoE), N8NSP/N16NSP(8 Port PoE)
- ④ ETHERNET PORT2: Network Second Terminal. No Internet access.(NS Series without PoE)
- ⑤ AUDIO IN/OUT: 4 Connectors for Audio Input / 1 Connector for Audio Output
- ⑥ CVBS OUT: MAIN – Composite Video Output.
- ⑦ HDMI OUT: HDMI output port, Connector to the HDMI Monitor, (1280x720, and 1920x1080).
- ⑧ VGA OUT: Connector for VGA Monitor, Main Video Output.
- ⑨ RS232C: POS Interface (TBD)
- ⑩ AUDIO Port: Audio inputs connections for channels 5-8 or 5-16 through external cable (N8NSP, N16NSP Models only).

- ⑪ E-SATA: 1 External SATA Terminal
- ⑫ USB PORT: Connector for USB Mouse or USB flash memory.
- ⑬ ETHERNET PORT1: RJ-45 Connector for LAN Connection, used for Internet Connection
- ⑭ SENSOR IN, ALARM OUT, RS-485: 4 sensor inputs, 1 alarm output and RS-485 for PTZ
- ⑮ POWER: DC12V input

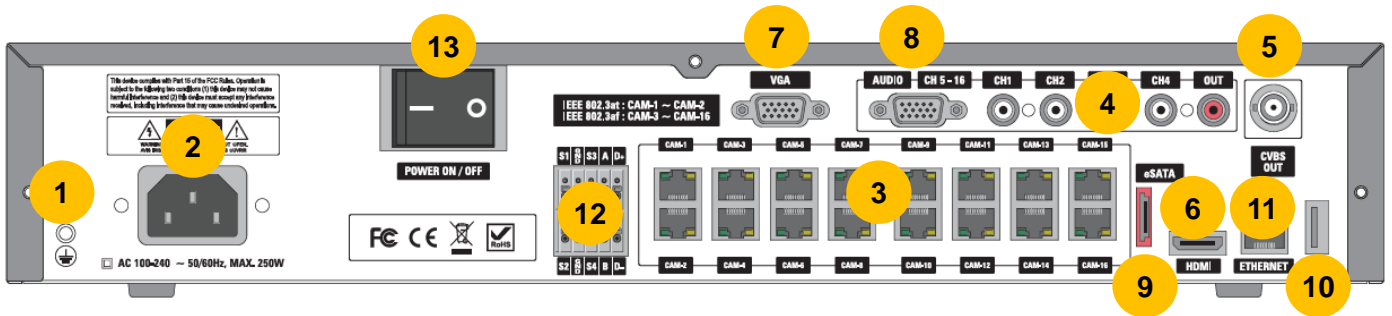
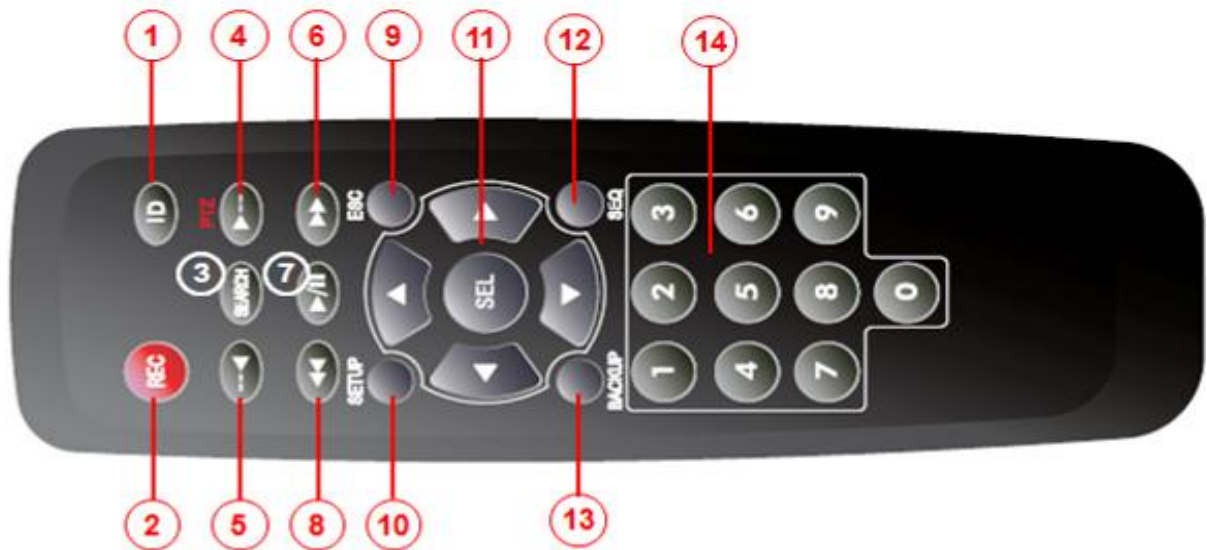

Figure 3.2.2. Connectors for N16NSF

- ① Ground: Use for grounding.
- ② POWER: Power Input (200W for PoE Power -First 2 channels at 802.3at, the rest 14 channels are 802.3af
- ③ PoE PORT: 16 Port PoE
- ④ AUDIO IN/OUT: 4 Connectors for Audio Input / 1 Connector for Audio Output
- ⑤ CVBS OUT: MAIN – Composite Video Output.
- ⑥ HDMI OUT: HDMI output port, Connector to the HDMI Monitor, (1280x720, and 1920x1080).
- ⑦ VGA OUT: Connector for VGA Monitor, Main Video Output.
- ⑧ AUDIO Port: Audio inputs connections for channels 5-8 or 5-16 through external cable (N8NSP, N16NSP Models only).
- ⑨ E-SATA: 1 External SATA Terminal
- ⑩ USB PORT: Connector for USB Mouse or USB flash memory.
- ⑪ ETHERNET PORT1: RJ-45 Connector for LAN Connection, used for Internet Connection
- ⑫ SENSOR IN, ALARM OUT, RS-485: 4 sensor inputs, 1 alarm output and RS-485 for PTZ
- ⑬ POWER SWITCH

3-3. Remote Control



- ① ID: Used to set up the remote control ID.
- ② REC: To enable or disable manual recording mode.
- ③ SEARCH: Goes to SEARCH menu for playback options.
- ④ F/ADV:
 - During Playback – Moves the playback forward by 60 seconds.
 - During Pause – Moves the playback forward by 1 frame.
- ⑤ F/REW:
 - During playback – Moves the playback backward by 60 seconds.
 - During Pause – Moves the playback backwards by 1 frame.
- ⑥ FF: Increases playback speed (fast forwards).
- ⑦ PLAY/PAUSE: To play or to pause the recording in playback mode
- ⑧ REW: Plays video backwards (rewinds), additional selection increases backwards playback speed.
- ⑨ ESC:
 - During Setup – Returns to the previous menu screen.
 - During Playback – Exits playback mode.
 - System lock – Locks the system when pressing ESC button for 5 seconds.
 - System unlock – Unlocks the system when pressing ESC button for 5 seconds.
- ⑩ SETUP: Opens up the SETUP menu.
- ⑪ Direction buttons: Used to move menu items or select a channel.
- ⑫ SEQ: Starts auto sequence the screen when in full screen mode. (Toggle)
- ⑬ BACKUP: Start the backup operations in live or playback mode.
- ⑭ 0~9: Used to select channel (1,2,3,..) or to setup a NS Remote ID.

4. Setting up the NS

The following sections detail the initial setup of the NS.



Menu screen will close if user input is not received within 5 minutes.

4-0. Setup – Main Live Screen

To enter the setup menu, right click on the mouse and select setup from the submenu or press the setup button on the remote control.

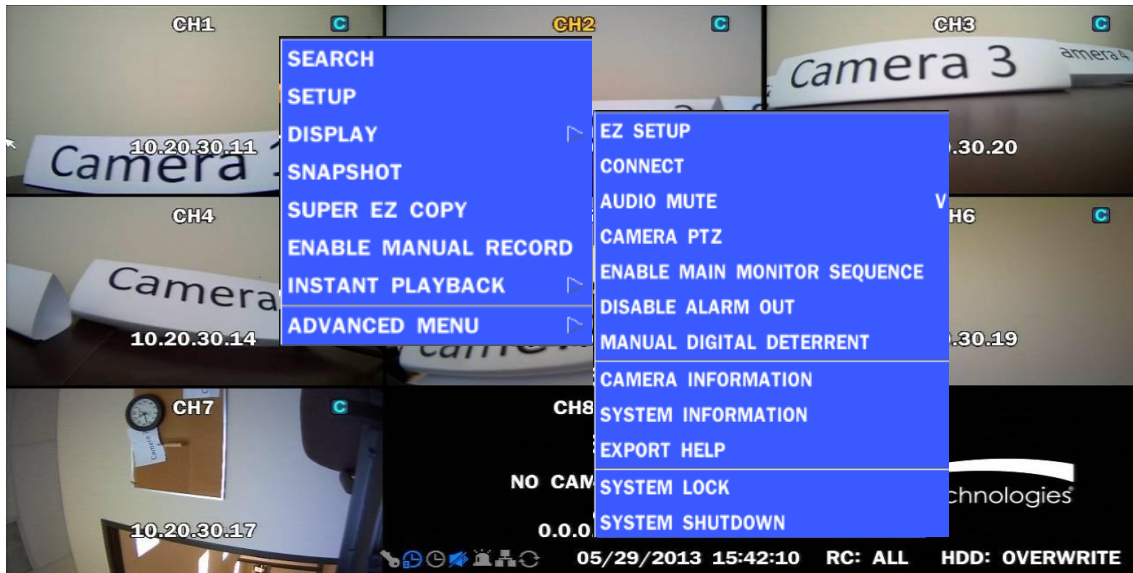
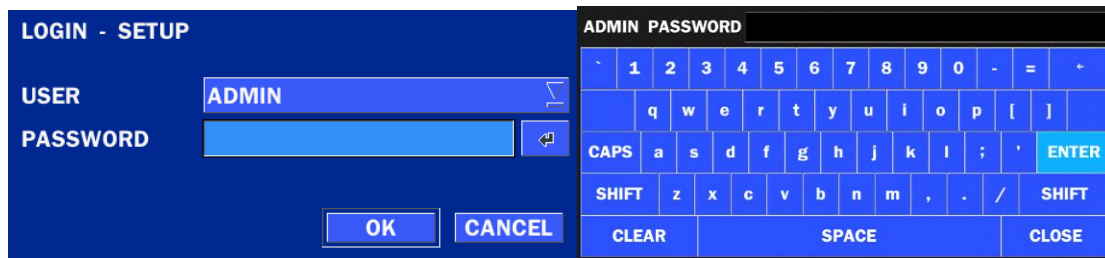

Table 4.0.1. Live Screen and Quick Operation Window



When the NS prompts the LOG-IN window, enter the PASSWORD using the virtual keyboard, or the front panel, or the remote control. For ADMIN, the factory default password is 1111. It is highly recommended to assign a new password to protect the system. User can assign a new password in SECURITY setup menu.

4-1. Setup – IP CAMERA

Press the SETUP button and enter the password. The IP Camera setup menu is displayed below.



Figure 4.1.1. IP Camera mode setup screen

Table 4.1.1. Menu items in IP CAMERA mode setup

Item	Description																																																															
CHANNEL	To manually connect each camera, click on the  to get this window:																																																															
	<table border="1"> <thead> <tr> <th></th> <th>PROTOCOL</th> <th>SCAN</th> <th>IP</th> <th>PORT</th> <th>WEB PORT</th> <th>OTHERS</th> </tr> </thead> <tbody> <tr> <td>9</td> <td>SPECO</td> <td><input checked="" type="checkbox"/></td> <td>172.16.2.66</td> <td>554</td> <td>80</td> <td></td> </tr> <tr> <td>10</td> <td>SPECO</td> <td><input type="checkbox"/></td> <td>0.0.0.0</td> <td>554</td> <td>80</td> <td></td> </tr> <tr> <td>11</td> <td>ONVIF</td> <td><input type="checkbox"/></td> <td>0.0.0.0</td> <td>554</td> <td>80</td> <td></td> </tr> <tr> <td>12</td> <td>SPECO</td> <td><input type="checkbox"/></td> <td>0.0.0.0</td> <td>554</td> <td>80</td> <td></td> </tr> <tr> <td>13</td> <td>SPECO</td> <td><input type="checkbox"/></td> <td>0.0.0.0</td> <td>554</td> <td>80</td> <td></td> </tr> <tr> <td>14</td> <td>SPECO</td> <td><input type="checkbox"/></td> <td>0.0.0.0</td> <td>554</td> <td>80</td> <td></td> </tr> <tr> <td>15</td> <td>SPECO</td> <td><input type="checkbox"/></td> <td>0.0.0.0</td> <td>554</td> <td>80</td> <td></td> </tr> <tr> <td>16</td> <td>SPECO</td> <td><input type="checkbox"/></td> <td>0.0.0.0</td> <td>554</td> <td>80</td> <td></td> </tr> </tbody> </table>		PROTOCOL	SCAN	IP	PORT	WEB PORT	OTHERS	9	SPECO	<input checked="" type="checkbox"/>	172.16.2.66	554	80		10	SPECO	<input type="checkbox"/>	0.0.0.0	554	80		11	ONVIF	<input type="checkbox"/>	0.0.0.0	554	80		12	SPECO	<input type="checkbox"/>	0.0.0.0	554	80		13	SPECO	<input type="checkbox"/>	0.0.0.0	554	80		14	SPECO	<input type="checkbox"/>	0.0.0.0	554	80		15	SPECO	<input type="checkbox"/>	0.0.0.0	554	80		16	SPECO	<input type="checkbox"/>	0.0.0.0	554	80	
	PROTOCOL	SCAN	IP	PORT	WEB PORT	OTHERS																																																										
9	SPECO	<input checked="" type="checkbox"/>	172.16.2.66	554	80																																																											
10	SPECO	<input type="checkbox"/>	0.0.0.0	554	80																																																											
11	ONVIF	<input type="checkbox"/>	0.0.0.0	554	80																																																											
12	SPECO	<input type="checkbox"/>	0.0.0.0	554	80																																																											
13	SPECO	<input type="checkbox"/>	0.0.0.0	554	80																																																											
14	SPECO	<input type="checkbox"/>	0.0.0.0	554	80																																																											
15	SPECO	<input type="checkbox"/>	0.0.0.0	554	80																																																											
16	SPECO	<input type="checkbox"/>	0.0.0.0	554	80																																																											
	Under the column labeled Type, Select IP Camera Manufacturer.																																																															
	<table border="1"> <thead> <tr> <th></th> <th>PROTOCOL</th> <th>SCAN</th> </tr> </thead> <tbody> <tr> <td>9</td> <td>SPECO</td> <td><input checked="" type="checkbox"/></td> </tr> <tr> <td>10</td> <td>SPECO</td> <td><input type="checkbox"/></td> </tr> <tr> <td>11</td> <td>ONVIF</td> <td><input type="checkbox"/></td> </tr> <tr> <td>11</td> <td>SPECO</td> <td><input type="checkbox"/></td> </tr> </tbody> </table>		PROTOCOL	SCAN	9	SPECO	<input checked="" type="checkbox"/>	10	SPECO	<input type="checkbox"/>	11	ONVIF	<input type="checkbox"/>	11	SPECO	<input type="checkbox"/>																																																
	PROTOCOL	SCAN																																																														
9	SPECO	<input checked="" type="checkbox"/>																																																														
10	SPECO	<input type="checkbox"/>																																																														
11	ONVIF	<input type="checkbox"/>																																																														
11	SPECO	<input type="checkbox"/>																																																														

SCAN: Double click the empty box to search IP camera on the local network.

IP	PORT	WEB PORT
192.168.78.11	554	80

Camera Scanning has been completed.

REFRESH REGISTER CANCEL

IP: Enter the address of IP camera to connect, or select from scanned list.

PORT: Enter the port number of IP camera to connect

WEB PORT: Enter the web port number of IP camera to connect

OTHERS: Change the IP camera setting. Double click the empty box and then Log-In box will be pop-up. (Enter ID and PASSWORD of IP Camera)

ID admin

PASSWORD ****

OK

PROTOCOL Select the [protocol for the IP Camera.](#)

SCAN Automatic IP Camera search on the local network.

IP Set up IP camera address.

PORT Set up the RTSP port of the IP Camera (default: 554)

WEB PORT Set up the web port of IP Camera (default: 80)

ID Enter ID of IP CAM

PASSWORD Enter the PASSWORD of IP CAM

4-1-1. SCAN Menu

Scan for IP Cameras on network using ONVIF/SPECO protocols.



Figure 4.1.2 IP CAMERA Setup Screen



Figure 4.1.3 Left Image using ONVIF Protocol SCAN, Right Image using SPECO Protocol SCAN

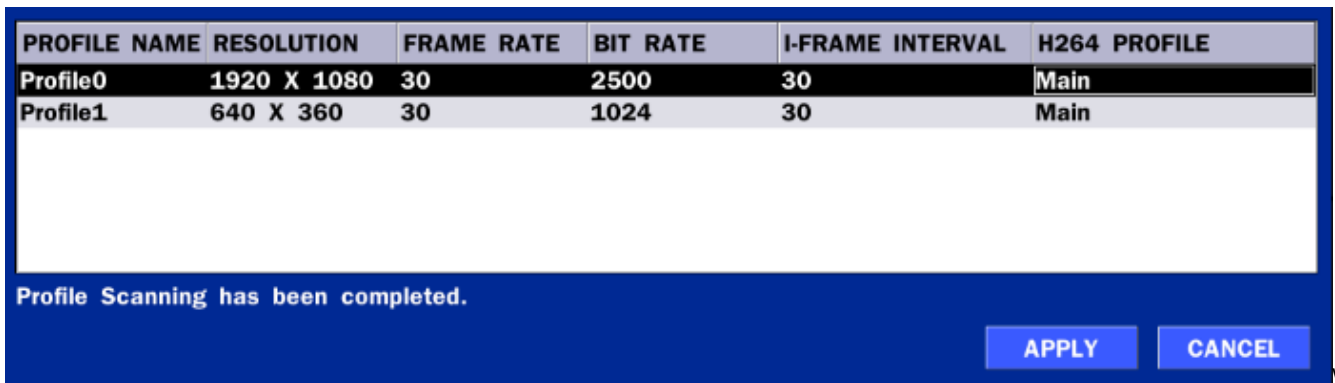

Figure 4.1.4 ONVIF Protocol Profile SCAN Image

- ① Select the protocol used by the IP Camera and then click the scan button.
- ② Select the IP Camera from the list and then click the register button.
- ③ After registering, the basic information is displayed.
- ④ IP cameras using ONVIF protocol require ID, Password and Profile to be correctly entered for proper operation.
- ⑤ SPECO protocols only require ID and Password to be correctly entered for proper operation. IP cameras using ONVIF protocol can have their Video, Network and System settings accessed and updated using the ONVIF setup menu.

(ONVIF Setup Menu may not be accessible depending on the ONVIF version used by the IP camera.)

4-1-2. ONVIF SETUP Menu



Figure 4.1.2 IP CAMERA Setup Screen (ONVIF)

The NS Series can search for IP Cameras that are conformant to ONVIF (Open Network Video Interface Forum). In order to search for ONVIF Cameras, the field associated with VENDOR has to be set to ONVIF. Click on the Box associated with SCAN to scan the networks for ONVIF Conformance cameras.



Figure 4.1.4 ONVIF Camera Scan Window

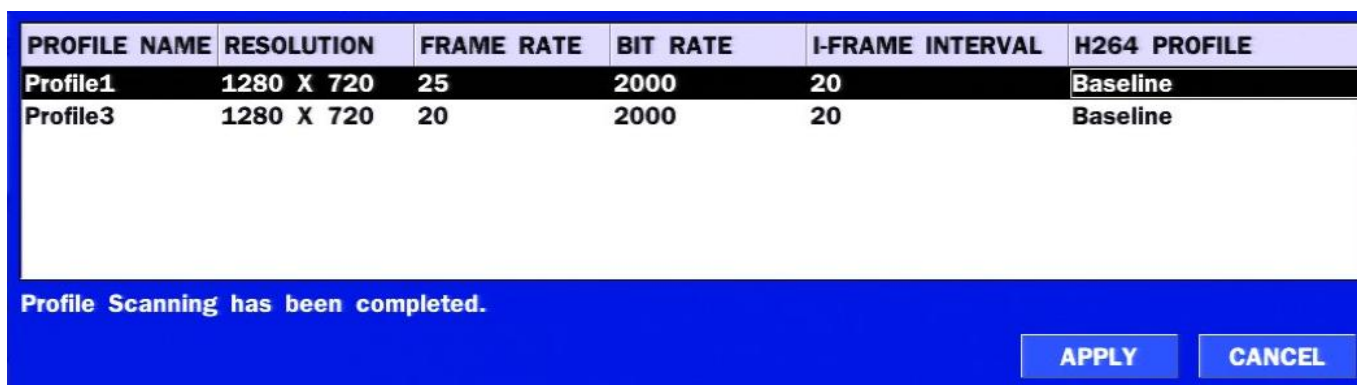

Figure 4.1.5 ONVIF Profile Scan Window

- ① Select ONVIF for Vendor and click the SCAN button.
- ② Select the camera on the list and then click the register button.
- ③ Then, PROFILE and ONVIF setting button will be displayed on the menu. Click PROFILE button and then the detail information of ONVIF will be searched and listed. **(If there is not one listed, the ONVIF protocol of IP CAM is not compatible with NVR and therefore not supported.)**

- ④ Double click the listed profile to apply.
- ⑤ Enter ID and PASSWORD of IP CAM. Registration is .completed.

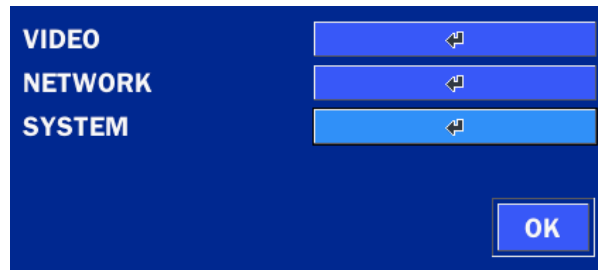
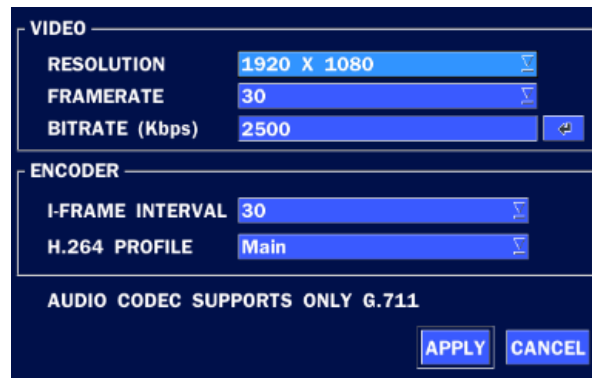

Figure 4.1.6 ONVIF Setup Window

Under ONVIF Setup, the following can be viewed and changed: VIDEO, NETWORK, SYSTEM settings.

Menu Item	Description
-----------	-------------

VIDEO	Video, Encoder to view and change to audio settings.
--------------	--



NETWORK	View and change Network settings.
----------------	-----------------------------------

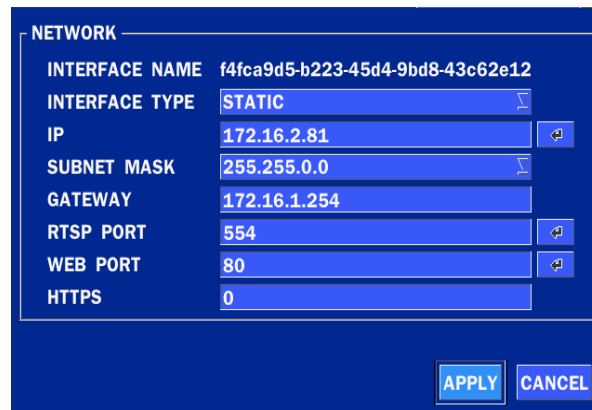

SYSTEM	System information and change your password, factory reset and the camera is rebooting.
---------------	---

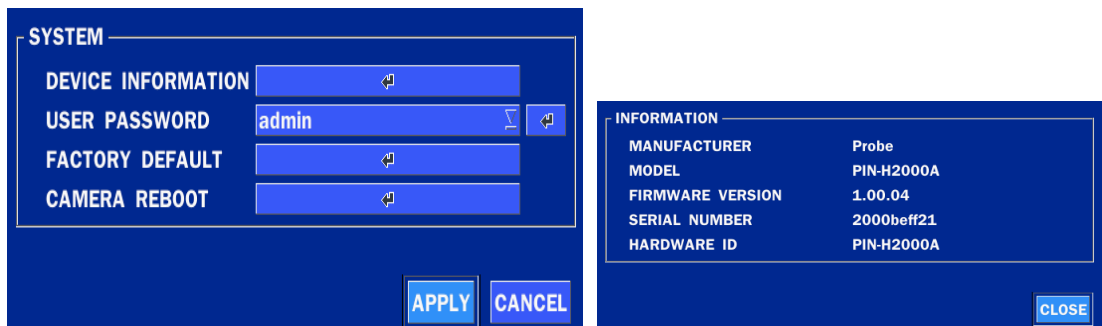

4-2. Setup – SYSTEM

In the SETUP menu, select the SYSTEM tab. Then, the SYSTEM menu is displayed as pictured below. Navigate through the menu items or change the settings using the mouse or the remote control.



Figure 4.2.1. SYSTEM Setup Screen

Table 4.2.1. Menu Items in SYSTEM Setup Screen

Item	Description
DESCRIPTION	Press the button to view the system information. (Software Version, Storage Size, IP Address, MAC Address and DDNS Status)
LANGUAGE	Select the display language using the mouse or the remote control. Once a language is selected, the display language will change.
DATE DISPLAY FORMAT	Select the date display format using the mouse or the remote control. Options are: MM/DD/YYYY, YYYY/MM/DD, DD/MM/YYYY, YYYY-MM-DD, MM-DD-YYYY, DD-MM-YYYY
DATE&TIME SETUP	Select the display date and time using the mouse or the remote control and press OK button to set the present date and time.
	Select DAYLIGHT SAVINGS using the mouse or the remote control and select the appropriate daylight savings time zone. The options are: OFF: Daylight saving is turned off. USA: Applies the USA daylight saving time. EU: Applies the EU daylight saving time.

- Select the GMT AREA using the mouse or the remote control.
- Set the time difference with the standard time using the mouse or the button.

OTHERS: If the time zone is neither USA nor EU, set the date and time of the daylight saving period.

- Select BEGIN or END.

Caution

- Do not set the start time to 23:00 for DLS.
- DLS cannot be applied if the date of BEGIN and END is the same.

CLIENT ACCESS

Enable/Disable remote access through the network.

NTP SETUP

NTP (Network Time Protocol) which synchronizes the time of the computer systems over variable-latency data networks.

PRIMARY SNTP SERVER: Input the address of the primary NTP time-server.

SECONDARY SNTP SERVER: Input the address of the secondary NTP time-server.

TIME ZONE: NTP synchronizes with GMT (Greenwich Mean Time) regardless of geography; user must select time difference from GMT.

CONNECTON MODE: Select the NTP time-server connection mode from TIME, INTERVAL, and ONCE.

CONNECTION PERIOD

- **TIME** – Refresh the time at the designated time (e.g. 1AM)
- **INTERVAL** – Every 1 hour ~ 24 hours
- **ONCE** – Synchronizes time only once. NTP will not synchronize unless the Connection Mode is changed.



NS sends E-MAIL Notification when the NTP server time is faster than the system time with below message.

“NTP server time is faster than the system time.

In this case, NTP server time is ignored to protect the user data.

User must set the time manually.

SYSTEM TIME: Mon Oct 10 13:46:49 2011

SERVER TIME: Mon Oct 10 13:33:12 2011

ID: NS

IP ADDRESS: 172.16.2.46

SEND EMAIL

SERVER TYPE	MANUAL	
MAIL SERVER		
MAIL PORT	25	
SECURE OPTION	NONE	
ID		
PASSWORD		
MAIL TO		
MAIL FROM		
	TEST	
	OK	CANCEL

SERVER TYPE: Select **GMAIL, HOTMAIL, AOL, YAHOO** or **MANUAL**)

MAIL SERVER: Enter the appropriate mail server information.

MAIL PORT: Assign Mail Port number.

SECURE OPTION: Select the secure mail server connection method. (**SSL** or **TLS**)

ID: Enter the appropriate mail server ID.

PASSWORD: Enter the appropriate mail server **PASSWORD**

MAIL TO: Enter the appropriate email address to enable sending e-mail reports using a virtual keyboard.

MAIL FROM: To set the email address sent to the destination host.

TEST : E-mail settings sent a test mail to the registered account

UNIT NAME

Name the NS (e.g. Factory)

This feature is to identify the name of the NS under the same network.

SYSTEM

Restart the system

RESTART

SYSTEM

Shut down the system

SHUTDOWN

EZ SETUP

Quick installation Menu for NS and IP Camera Easy installation

4-3. Setup – RECORD Mode

In the SETUP menu, select the RECORD tab. Then, the RECORD menu is displayed as pictured below. Navigate through the menu items or change the settings using the mouse or the remote control.



Figure 4.3.1. RECORD Setup Screen

Table 4.3.1. Menu Items in RECORD Setup Screen

Menu Item	Description
SITE	Select a channel for applying the following settings using the mouse or the remote control. To change the values of all channels, take the following steps. Select the button  to change the values of all channels.
RECORDING MODE	Assign the recording mode for the selected channel. Options are: Continuous, Motion, Schedule or Disable.

	RECORDING	PRE RECORD	POST EVENT REC	AUDIO
ALL	CONTINUOUS	1 MIN(S)	10 SEC(S)	OFF
1	CONTINUOUS	1 MIN(S)	10 SEC(S)	OFF
2	CONTINUOUS	1 MIN(S)	10 SEC(S)	OFF
3	CONTINUOUS	1 MIN(S)	10 SEC(S)	OFF
4	CONTINUOUS	1 MIN(S)	10 SEC(S)	OFF
5	CONTINUOUS	1 MIN(S)	10 SEC(S)	OFF
6	CONTINUOUS	1 MIN(S)	10 SEC(S)	OFF
7	CONTINUOUS	1 MIN(S)	10 SEC(S)	OFF
8	CONTINUOUS	1 MIN(S)	10 SEC(S)	OFF

SENSOR	Select the sensor setting for the selected channel.
RECORDING	
PRE RECORD	Enable/disable pre-event recording. Pre-event recording time is up to 20 minutes.
POST EVENT	Set the post event recording time duration for the specified channel.
RECORD	(10~30 seconds)
AUDIO	Enable/disable audio recording for the specified channel.
SCHEDULE	Set the recording schedule.

3-1. Recording Schedules

To setup a recording schedule, select SCHEDULE in the RECORD menu. Navigate through the menu items or change the settings using the mouse or the remote control.

Select CHANNEL > select NONE, CONTINUOUS or MOTION > Highlight area

To copy a schedule to a different channel, select the channel from the COPY SCHEDULE menu.

CHANNEL	1																							
	NONE	CONTINUOUS	MOTION	SENSOR	CLEAR																			
	0	1	2	3	4	5	6	7	8	9	10	11	12	13	14	15	16	17	18	19	20	21	22	23
SUN																								
MON																								
TUE																								
WED																								
THU																								
FRI																								
SAT																								

COPY SCHEDULE

CH 1 CH 2 CH 3 CH 4 ALL
 CH 5 CH 6 CH 7 CH 8
 CH 9 CH 10 CH 11 CH 12
 CH 13 CH 14 CH 15 CH 16

Figure 4.3.2. Schedule Recording Setup Screen

- **NONE:** Disable recording during selected timeframe (Highlighted in White)
- **CONTINUOUS:** CONTINUOUS recording (Highlighted in Green)
- **MOTION:** MOTION recording (Highlighted in Yellow)
- **SENSOR:** SENSOR recording (Highlighted in Red)
- **CLEAR:** Clears the schedule.

4-4. Setup – DEVICE Mode

In the SETUP menu, select the DEVICE tab. Then, the device menu is displayed as pictured below. Navigate through the menu items or change the settings using the mouse or the remote control.

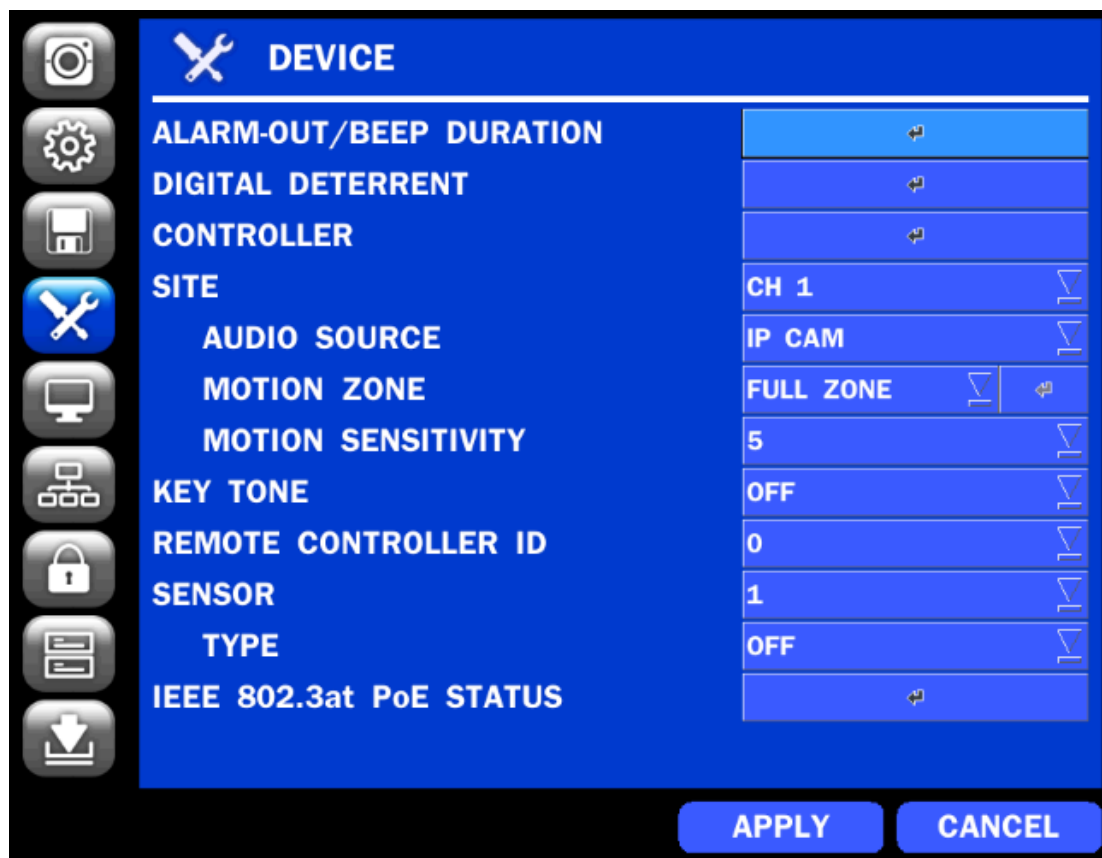

Figure 4.4.1. DEVICE Setup Screen

Table 4.4.1. Menu Items in DEVICE Setup Screen

Item	Description
ALARM OUT / BEEP DURATION	Only one Alarm-out is available. Set alarm dwell time from 5 to 60 seconds or infinite.
DIGITAL DETERRENT	Setup schedule and audio recordings for Digital Deterrent.
CONTROLLER & PTZ	Set the PTZ baud rate, protocol, and ID.
SPOT-OUT	Display the channels triggered by an event (Refer to 4.4.4)
SITE	Select specified channel for motion zone setup.

MOTION ZONE	Select either Full Zone or Partial Zone for motion detection.
MOTION SENSITIVITY	Set the motion sensitivity for the selected channel. Control the motion sensitivity from 1 to 9. (9 – Highest sensitivity, 1 – Lowest sensitivity)
KEY TONE	Enable/disable key tone from front panel usage.
REMOTE CONTROL ID	Set the remote control ID. 1. Select ID. 2. Input the remote control ID number. 3. An icon will indicate on the Live Screen if the remote control ID is synchronized. The options are from 0 to 99
SENSOR	Select the type of each sensor. Option is Off, Normal Open or Normal Close.

IEE 802.3af PSE STATUS (N4/8/16NSP, N16NSF Models) PoE (Power Over Ethernet) Status Monitoring Menu

IEEE 802.3at PoE STATUS						
PORT	STATUS	FAULT	VOLTAGE (V)	CURRENT (mA)	POWER (mW)	CAMERA RESTART
1	SEARCHING	NO FAULT	0	0	0	
2	SEARCHING	NO FAULT	0	0	0	
3	SEARCHING	NO FAULT	0	0	0	
4	SEARCHING	NO FAULT	0	0	0	
5	SEARCHING	NO FAULT	0	0	0	
6	SEARCHING	NO FAULT	0	0	0	
7	SEARCHING	NO FAULT	0	0	0	
8	SEARCHING	NO FAULT	0	0	0	
9	SEARCHING	NO FAULT	0	0	0	
10	SEARCHING	NO FAULT	0	0	0	
11	SEARCHING	NO FAULT	0	0	0	
12	SEARCHING	NO FAULT	0	0	0	
13	SEARCHING	NO FAULT	0	0	0	
14	SEARCHING	NO FAULT	0	0	0	
15	SEARCHING	NO FAULT	0	0	0	
16	SEARCHING	NO FAULT	0	0	0	
TOTAL				0	0	ALL

RELOAD **CLOSE**

4-4-1. Digital Deterrent

Trigger audio message via motion detection or sensor.

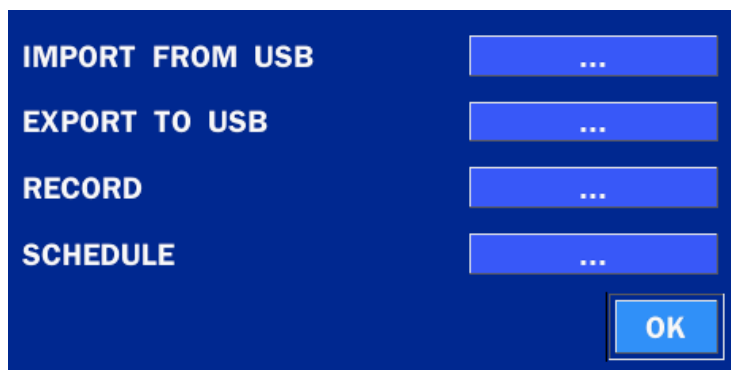
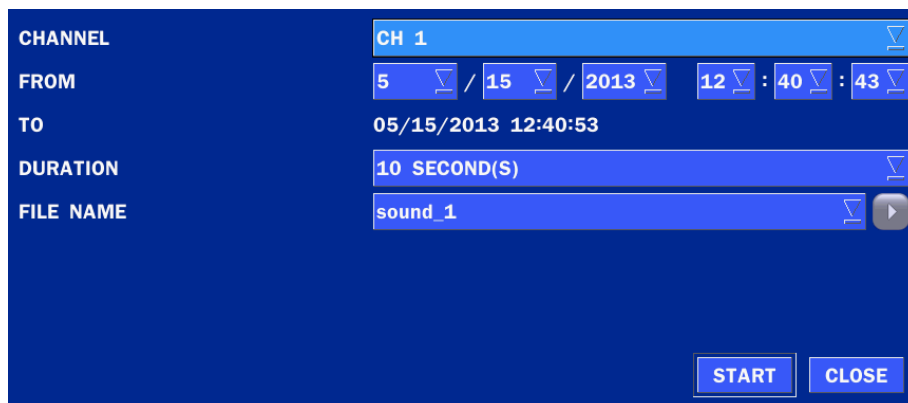

Figure 4.4.2. Digital Deterrent setup screen

Table 4.4.2. Item for Digital Deterrent Setup Screen

Item	Description
IMPORT FROM USB	Import up to 8 sound files from USB.
EXPORT TO USB	Export the sound file to USB
RECORD	Select a channel and set up the date and the duration. And, select the sound file to play.



SCHEDULE

Schedule the sound file considering the expected situation.

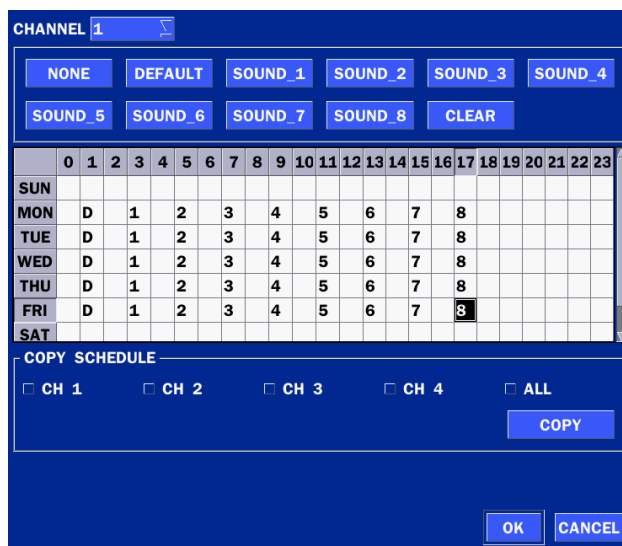

4-4-2. Keyboard Controller & PTZ Setup

To control the PTZ functions of the camera, connect the PTZ controller to the RS-485 port on the back of the chassis with CAT5 (or equivalent) cable.

- ① Connect the RS-485 cables of PTZ camera to the RS-485 port on the rear panel.

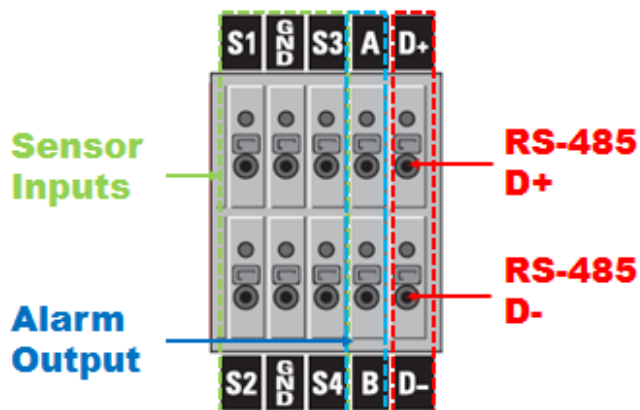

Figure 4.4.2.1. Device Mode Setup Screen

- ② Open the PTZ sub menu by selecting the submenu button.

CONTROLLER	---	▽
SPEED	9600	▽
ID	0	▽
CHANNEL	1	▽
CAMERA	---	▽
SPEED	9600	▽
ID	0	▽

OK CANCEL

Figure 4.4.2.2. PTZ Control Setup Screen

Note: Connect PTZ cameras that support RS-485 directly to the RS-485 port. If the camera is controlled through an RS-232C interface, use an RS-232C to RS-485 to RS-232C signal converter.

Use the PTZ setup screen to select the following options for the camera PTZ controller:

- **CHANNEL:** Channel connected to a PTZ device
- **CAMERA:** Protocol Type
- **SPEED:** 19200, 14400, 9600, 4800, 2400 (Baud rate)
- **ID:** 0-63

Controller (Keyboard Controller): If a PTZ controller is used, select a controller protocol from Controller menu. Set SPEED (Baud Rate) and ID number.

4-4-3. Motion Zone Setup

Select MOTION ZONE using the mouse or the remote control and select either PARTIAL ZONE or FULL ZONE using the mouse control. The default value is FULL ZONE.

If FULL ZONE is selected, the motion zone grid screen is not displayed. Only set the level of sensitivity for MOTION SENSITIVITY.

FULL ZONE: The motion sensor is active on the whole screen.

PARTIAL ZONE: The motion sensor is active in the set detection frame.

Select the motion detection position using the mouse or the remote control. Then left click on the mouse or left click and drag the mouse pointer to select or deselect the area. Highlighted area indicates the partial motion detection zone. Press the ESC button or right click on the mouse to return to the previous menu.

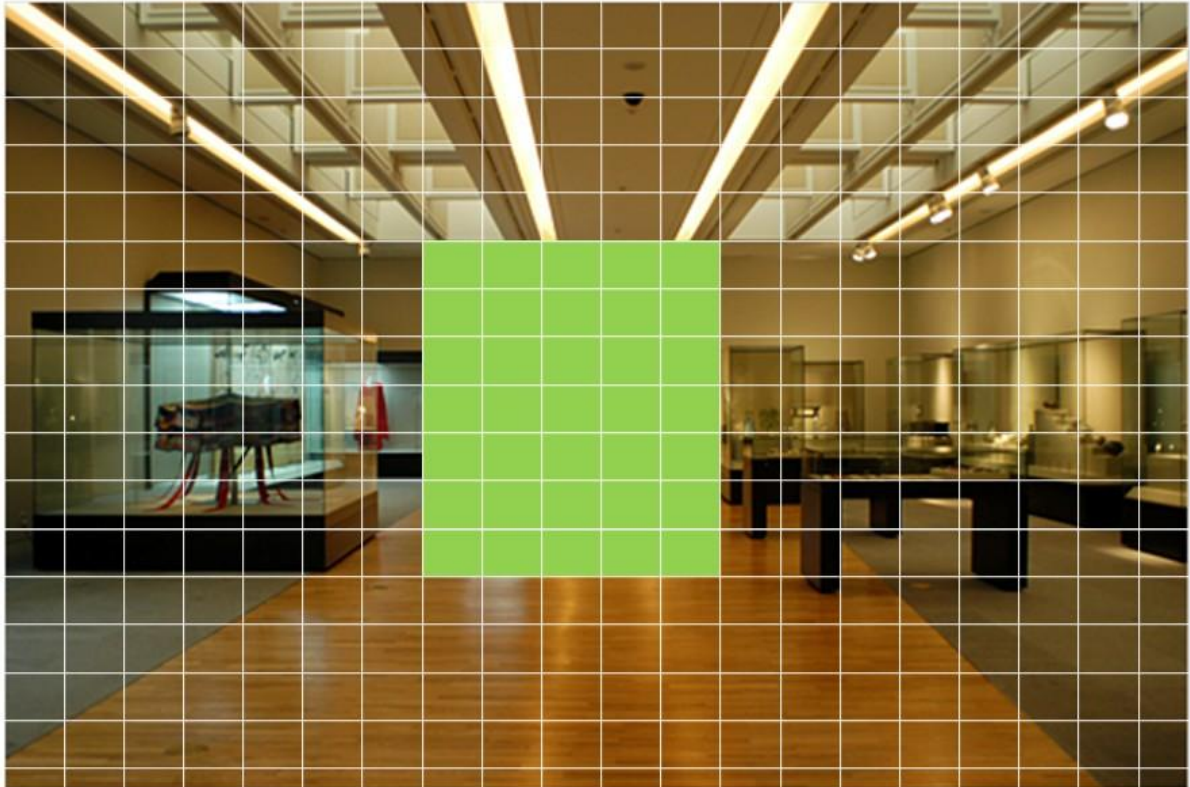

Figure 4.4.4. Motion Zone Grid Screen

4-5. Setup – DISPLAY Mode

In the SETUP menu, select the DISPLAY tab. Then, the DISPLAY menu is displayed as pictured below. Navigate through the menu items or change the settings using the mouse or the remote control. To return to the previous setup menu screen, press the ESC button.

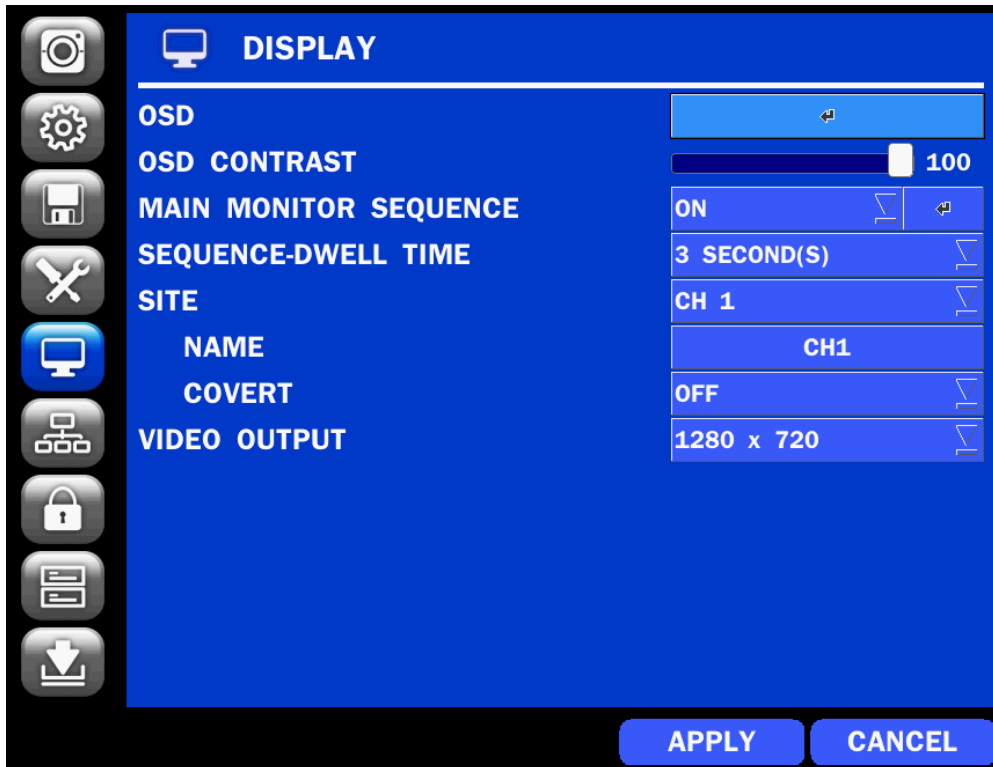

Figure 4.5.1. DISPLAY Setup Screen

Table 4.5.1. Menu Items in DISPLAY Setup Screen

Item	Description
OSD	Enable/Disable on-screen-display. (Channel Name, Video Loss, Status Bar / Icon)
OSD CONTRAST	Set the visibility level of the On Screen Display (OSD) (0~100)
MAIN MONITOR SEQUENCE	Enable/Disable sequential display of video in full screen mode.
SEQUENCE DWELL TIME	Set the dwell time of each, single channel display in sequential display mode (3~60 seconds)
SITE	Select a channel to apply the name and covert settings change using the mouse or the remote control. Select a channel to apply the following settings using the mouse.
NAME	Set the channel name. Press the right square button and set the channel name and select OK using the mouse. The name can be made up to 36 characters.
COVERT	Enable/disable display of the specified video channel in live display.
VIDEO OUTPUT	Select 1280x720 or 1920x1080.

4-6. Setup – NETWORK Mode

Select the NETWORK tab. Then, the network menu is displayed as pictured below. Navigate through the menu items or change the settings using the mouse or the remote control.

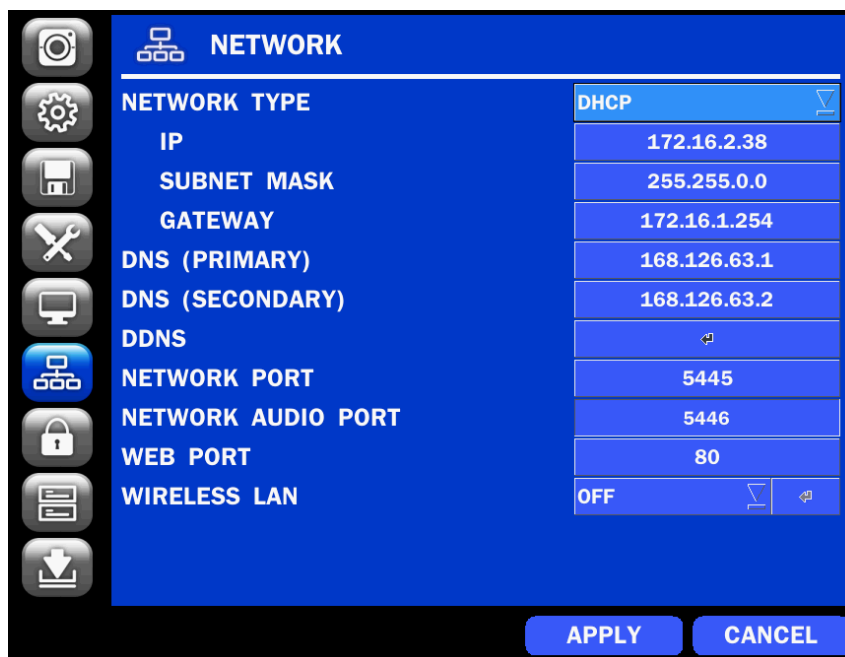

Figure 4.6.1. NETWORK Setup Screen

Table 4.6.1. Menu Items in NETWORK Setup Screen

Item	Description
NETWORK TYPE	DHCP: ZS will automatically retrieve an IP address. STATIC: Network information must be manually configured.
IP	Enter IP address that is assigned for the ZS
SUBNET MASK	Enter Subnet Mask that is assigned for the ZS
GATEWAY	Enter Gateway that is assigned for the ZS.
DNS (PRIMARY)	Enter Primary DNS address that is assigned for the ZS
DNS (SECONDARY)	Enter Secondary DNS address that is assigned for the ZS
DDNS	Dynamic Domain Name System (DDNS) allows a DNS name to be constantly synchronized with a dynamic IP address. In other words, it allows using a dynamic IP address to be associated with a static domain name so others can connect to it by the static name. Enable/disable using domain name address through DDNS server.
NETWORK PORT	Enter the port number.
NETWORK AUDIO PORT	Display the network audio port (NETWORK PORT + 1).
WEB PORT	Enter the port number for connection using web.
WIRELESS LAN	Wireless networks can be configured(option)

4-6-1. Network Types

4-6-1-1. DHCP

An IP address is automatically assigned by the DHCP server, which automatically assigns the IP address and other parameters to new devices.

4-6-1-2. STATIC

IP address, Subnet Mask, Gateway, and DNS are manually assigned by the user.

- IP ADDRESS: The fixed IP address of the NS unit.
- SUBNET MASK: The subnet mask for the LAN.
- GATEWAY: The IP address of the Gateway.
- DNS (PRIMARY) The primary address of Domain Name Server
- DNS (SECINDARY): The secondary address of Domain Name Server



NOTE

Unless DNS is properly set, the DDNS and the e-mail features will not work.

4-6-2. DDNS

DDNS (Dynamic Domain Name System) allows a DNS name to be constantly synchronized with a dynamic IP address. It allows using a dynamic IP address to be associated with a static domain name.

Once the setting is completed, the DDNS address will be:

<http://hostname.ddns.specoddns.net>

For example, if you enter the host name as “NS”, then the address will be:

<http://NS.ddns.specoddns.net>

Select NETWORK>DDNS. The menu displays as below.

ENABLE DDNS	OFF
HOST NAME	hostname
SUBMIT/UPDATE	OFF
ezDDNS	OFF

APPLY CLOSE

Figure 4.6.2. NETWORK Setup Screen – DDNS

Table 4.6.2. DDNS

Item	Description
ENABLE DDNS	Turn DDNS on/off
HOST NAME	This item allows the user to setup a domain name manually, using virtual keyboard displays as shown.
SUBMIT/UPDATE	When manual host name input is done, move the cursor to this item and select ON to submit the settings.
ezDDNS	Enable/disable ezDDNS to register the host name automatically.

4-6-3. Network Port and Web Port

Connecting NS/NSP through a common IP sharing device, each NS must be assigned a unique TCP port number for access from outside the LAN. This port number is displayed on NETWORK>NETWORK PORT Setup MENU.



NOTE:

If you access the NS only within the same LAN, the TCP port number does not need to be changed.

Network access beyond a router

To access NS beyond a router (firewall), you must open the proper TCP ports for live/playback streaming, for commands, for remote backup, and for audio streaming. If these ports are not opened properly, you can't access the NS beyond a router.



- **For live/playback streaming, for commands, for remote backup:** Open the port number on NETWORK>NETWORK PORT menu. The default port number is 5445.
- **For bi-directional audio:** Open the port number on NETWORK AUDIO PORT. The default port number is [NETWORK PORT number + 1].
- **For web-viewer downloading and remote firmware upgrading:** Open the port number on NETWORK>WEB PORT menu. The default port number is 80.
- **For IP Camera Setup through web viewer:** Forward ports 59011 ~ 59254 to the NVR.

4-7. Setup – USER MANAGEMENT Mode

In the SETUP menu, select the USER MANAGEMENT tab. Then, the USER MANAGEMENT menu is displayed as pictured below. Navigate through the menu items or change the settings using the mouse or the remote control.

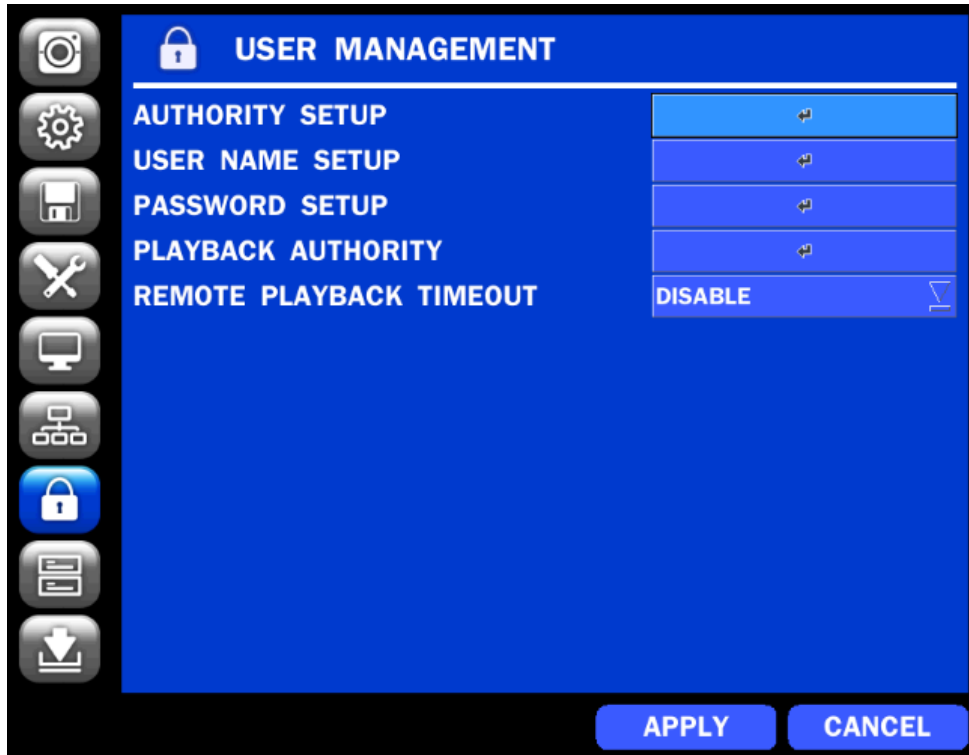

Figure 4.7.1. USER MANAGEMENT Setup Screen

Table 4.7.1. Menu Items in USER MANAGEMENT Setup Screen

Item	Description
AUTHORITY SETUP	Only the Admin will have access to the menu.
PASSWORD CHECK:	Select the Checkbox to enable the functions or leave the Checkbox blank to disable the functions.
	<ul style="list-style-type: none"> • SETUP: Enable/Disable of access to Setup • PB: Enable/Disable of access to Playback • PTZ: Enable/Disable of access to PTZ Control • REC OFF: Enable/Disable of manual Record • NETWORK: Enable/Disable of access to Network
	Selected Checkbox: The NS will ask for a password when the given function is selected for all users.
	Blank Checkbox: The NS will not ask for a password when the given function is selected for all users.

	PASSWORD	SETUP	PB	PTZ	REC OFF	NETWORK
PASSWORD CHECK		<input checked="" type="checkbox"/>	<input checked="" type="checkbox"/>	<input checked="" type="checkbox"/>	<input checked="" type="checkbox"/>	<input checked="" type="checkbox"/>
ADMIN	1111	<input checked="" type="checkbox"/>	<input checked="" type="checkbox"/>	<input checked="" type="checkbox"/>	<input checked="" type="checkbox"/>	<input checked="" type="checkbox"/>
USER1	1111	<input checked="" type="checkbox"/>	<input checked="" type="checkbox"/>	<input checked="" type="checkbox"/>	<input checked="" type="checkbox"/>	<input checked="" type="checkbox"/>
USER2	1111	<input checked="" type="checkbox"/>	<input checked="" type="checkbox"/>	<input checked="" type="checkbox"/>	<input checked="" type="checkbox"/>	<input checked="" type="checkbox"/>
USER3	1111	<input checked="" type="checkbox"/>	<input checked="" type="checkbox"/>	<input checked="" type="checkbox"/>	<input checked="" type="checkbox"/>	<input checked="" type="checkbox"/>

ADMIN, USER1, USER2, USER3:

Selected Checkbox: The user can access the function.

Blank Checkbox: The user can not access the function.

USER NAME Change the name of USER1, USER2 and USER3.

SETUP ● Click "ENTER" after naming.

PASSWORD Passwords can be changed for ADMIN, USER1, USER2 and USER3.

SETUP Select USER PASSWORD using the mouse or the remote control. Select username and enter the current password. And, enter a new password, enter the same password again to confirm and select OK. Then the message "PASSWORD CHANGED" is displayed.



The factory default password is **1111**.

It is highly recommended to assign a new password to protect the system.

PLAYBACK Set authority level of playback on each user.

AUTHORITY **Checked box:** authorized to playback. **Blank check box:** no authority.

	1	2	3	4	5	6	7	8	9	10	11	12	13	14	15	16
ADMIN	<input checked="" type="checkbox"/>	<input checked="" type="checkbox"/>	<input checked="" type="checkbox"/>	<input checked="" type="checkbox"/>	<input checked="" type="checkbox"/>	<input checked="" type="checkbox"/>	<input checked="" type="checkbox"/>	<input checked="" type="checkbox"/>	<input checked="" type="checkbox"/>	<input checked="" type="checkbox"/>	<input checked="" type="checkbox"/>	<input checked="" type="checkbox"/>	<input checked="" type="checkbox"/>	<input checked="" type="checkbox"/>	<input checked="" type="checkbox"/>	<input checked="" type="checkbox"/>
USER1	<input checked="" type="checkbox"/>	<input checked="" type="checkbox"/>	<input checked="" type="checkbox"/>	<input checked="" type="checkbox"/>	<input checked="" type="checkbox"/>	<input checked="" type="checkbox"/>	<input checked="" type="checkbox"/>	<input checked="" type="checkbox"/>	<input checked="" type="checkbox"/>	<input checked="" type="checkbox"/>	<input checked="" type="checkbox"/>	<input checked="" type="checkbox"/>	<input checked="" type="checkbox"/>	<input checked="" type="checkbox"/>	<input checked="" type="checkbox"/>	<input checked="" type="checkbox"/>
USER2	<input checked="" type="checkbox"/>	<input checked="" type="checkbox"/>	<input checked="" type="checkbox"/>	<input checked="" type="checkbox"/>	<input checked="" type="checkbox"/>	<input checked="" type="checkbox"/>	<input checked="" type="checkbox"/>	<input checked="" type="checkbox"/>	<input checked="" type="checkbox"/>	<input checked="" type="checkbox"/>	<input checked="" type="checkbox"/>	<input checked="" type="checkbox"/>	<input checked="" type="checkbox"/>	<input checked="" type="checkbox"/>	<input checked="" type="checkbox"/>	<input checked="" type="checkbox"/>
USER3	<input checked="" type="checkbox"/>	<input checked="" type="checkbox"/>	<input checked="" type="checkbox"/>	<input checked="" type="checkbox"/>	<input checked="" type="checkbox"/>	<input checked="" type="checkbox"/>	<input checked="" type="checkbox"/>	<input checked="" type="checkbox"/>	<input checked="" type="checkbox"/>	<input checked="" type="checkbox"/>	<input checked="" type="checkbox"/>	<input checked="" type="checkbox"/>	<input checked="" type="checkbox"/>	<input checked="" type="checkbox"/>	<input checked="" type="checkbox"/>	<input checked="" type="checkbox"/>

REMOTE Disconnect the remote playback after the specific time (Disable, 5min, 10min, 15 min,
PLAYBACK 30min, 60min.
TIMEOUT

4-8. Setup – STORAGE Mode

In the SETUP menu, select the STORAGE tab. Then, the STORAGE menu is displayed as pictured below. Navigate through the menu items or change the settings using the mouse or the remote control.



Figure 4.8.1. STORAGE Setup Screen

Table 4.8.1. Menu Items in STORAGE Setup Screen

Item	Description
OVERWRITE	When enabled, the NS will continue recording and overwrite the oldest existing recorded data once the hard drive is full. When disabled, recording will stop once the hard drive is full.
 DISK FORMAT	Once clicked, the user will have to confirm to format the Hard Drive. After confirming, the NS will reboot, and the format sequence will load. The format sequence allows user to select which HDDs to format. Caution: It is recommended to archive any data that you may need in the future before formatting the hard drive.
DISK INFO	Hard drive information. Displays the following information:

HDD SIZE : 5221 GB (FREE : 4097 GB)
HDD LAST TIME : 07-11-2012 16:16:00

	MODEL NAME	TEMPERATURE	HEALTH (GOOD/NORMAL/BAD)
HDD 1	WDC WD20EURS-73S48Y0	42 C (107 F)	GOOD
HDD 2	WDC WD20EVDS-63T3B0	48 C (118 F)	GOOD
HDD 3	WDC WD20EVDS-63T3B0	48 C (118 F)	GOOD
HDD 4			
HDD 5			
HDD 6			

OK

DETAIL

**RECORDING
LIMIT**

Enable recording limit : The amount of data recorded in HDD will be limited to the most recent number of days as set by "RECORDING LIMIT DAYS" .

Disable recording limit : When **OVERWRITE** is **ON**, DVR will continue to record when HDD is full and overwrite older data. When **OVERWRITE** is **OFF**, DVR will stop recording when the HDD is full.

**RECORDING
LIMIT DAYS**

Set the recording limit days. (1- 90 days)

If the RECORDING LIMIT DAYS are set to 1, the data will be overwritten after 24 hours.

4-9. Setup - CONFIG Mode

In the SETUP menu, select the CONFIG tab. Then, the configuration menu is displayed as pictured below. Navigate through the menu items or change the settings using the mouse or the remote control.



Figure 4.9.1. CONFIGURATION Setup Screen

Table 4.9.1. CONFIGURATION Setup

Item	Description
EXPORT TO USB	User can save the current configuration settings of the NS to a USB flash drive. Plug in the USB flash on the front panel and press the button to start the export process.
IMPORT FROM USB	User can upload the configuration of the NS to another NS using the USB Flash drive. Plug in the USB flash drive on the front panel and press the button to start the import process.
LOAD DEFAULT	Select this option to reset the system to the default settings. The following settings such as Language, NS ID, Security User Authentication, Security User P/W, Date format, DLS settings, Network settings, HDD overwrite, Limit recording, HDD serial number, and HDD ERROR time will not be included.
LOAD FACTORY DEFAULT	Press the button to reset the system to the factory default settings.
SOFTWARE UPGRADE	Upgrade software to the latest version. After connecting USB flash drive to USB port on the NS, click SEARCH. It will automatically find the upgrade file.

4-9-1. Firmware Upgrade

1. Create a new folder named “upgrade” in the USB flash drive root directory.
2. Create sub-folder for each model under “upgrade” folder and copy each firmware.
 - “n4ns” for N4NS and N4NSP: “main_n4ns_speco_*.*)_201****”
 - “n8ns” for N8NS and N8NSP: “main_n8ns_speco_*.*)_201****”
 - “n16nsf” for N16NSF: “main_n16nsf_speco_*.*)_201****”

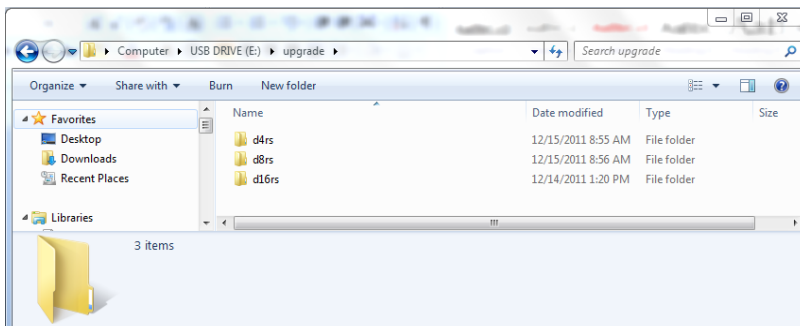

3. Plug in the USB flash drive on the rear panel.
4. Navigate to CONFIG menu of SETUP.
5. Select SOFTWARE UPGRADE.
6. Follow the procedure from Figure 4.9.2 to Figure 4.9.4.

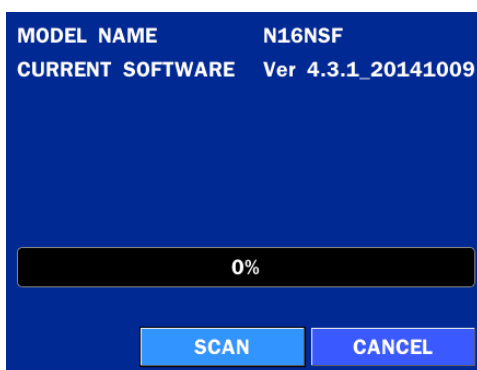

Figure 4.9.2

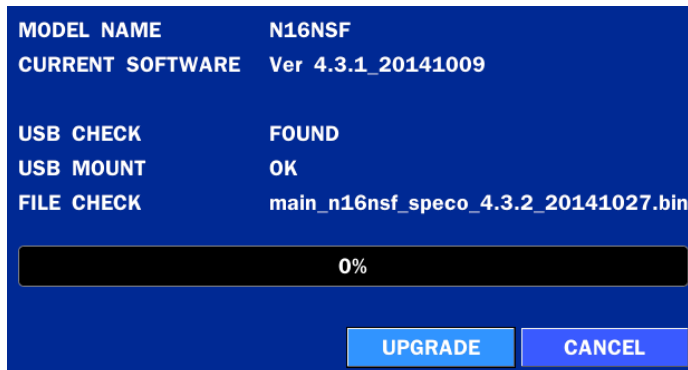

Figure 4.9.3

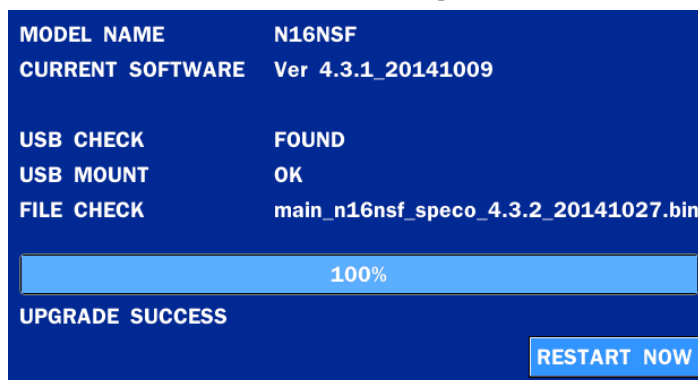

Figure 4.9.4

NOTICE



1. If selecting REBOOT LATER, the upgraded software will not be applied until the system reboots.
2. If selecting REBOOT NOW when the USB flash drive is plugged, the following message will pop up: Remove the USB flash drive and select OK.

5. Live, Search and Playback

5-1. Live View

In the Live screen, video inputs from the cameras are displayed as they are configured in the Display Setup screen. Various On-Screen Display (OSD) symbols, which indicate the status of the NS, are described in Table 5.1.1.

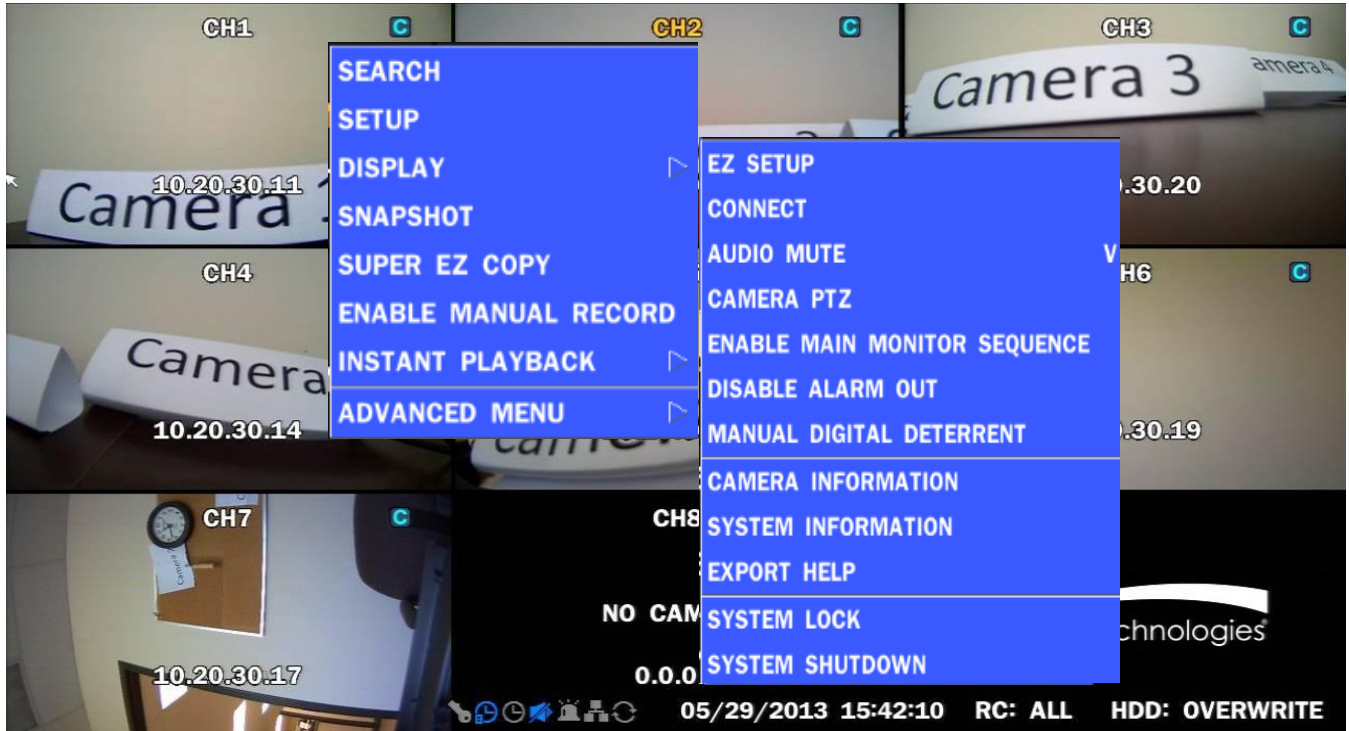















Figure 5.1.1. Live Screen and Quick Operation Window

Table 5.1.1. Status Indicator Icons in Live Viewing Screen

Icon	Description
	Indicates the NS is locked. Note) to unlock, right click on the live view screen and click on Unlock.
	Audio mute. To select audio output, press the Audio after click the right button on the mouse. Toggle from Audio 1 to 4, mute in order.
	Indicates that alarm is set. To set the alarm function, press the Alarm button on the front panel.
	Indicates that alarm output is activated.
	Event indicator. When there is an event (motion recording, video loss, HDD fail, S.M.A.R.T), this icon will be highlighted.
	Indicates that a network client is connected to the NS.

	Indicates that sequencing mode is enabled.
	Displays the current date and time.
RC: ALL	Remote control ID display. If a remote ID is not set, the message "ALL" is displayed.
 15%	Displays the amount of recording on the hard disk from 0-99%.
	Indicates that HDD is recycled.
	Continuous recording in progress.
	Manual recording in progress. To set the Manual recording mode, press the Record button on the front panel.
	Motion alarm recording in progress.
	Sensor recording in progress.

Right click the mouse, and the quick operation window will be displayed as below.

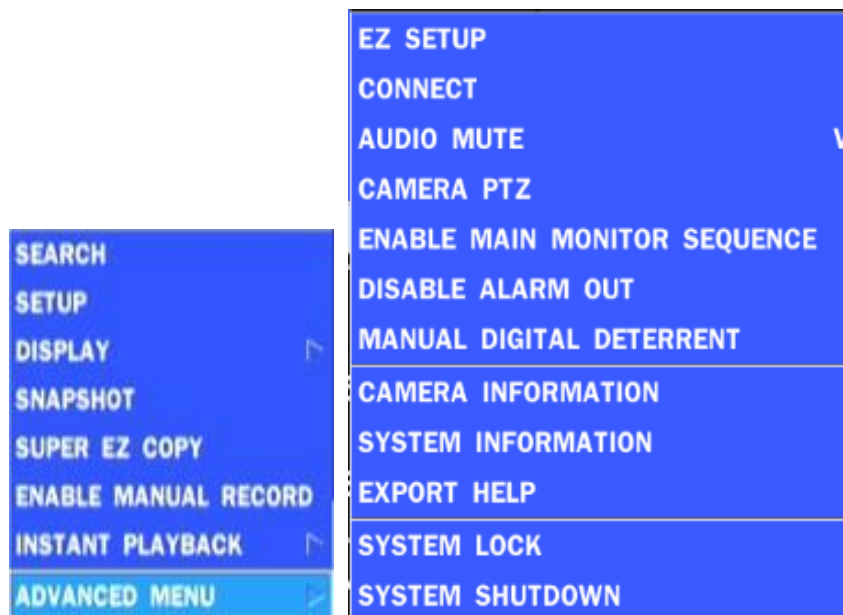
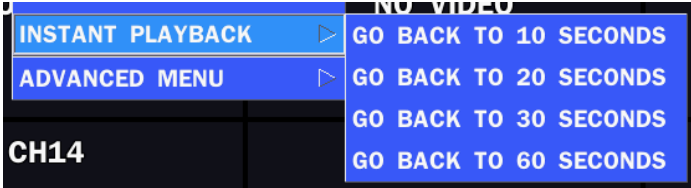

Figure 5.1.2. Quick Operation Window

Table 5.1.2. Menu Items in Quick Operation Window

Icon	Description
SEARCH	Search button. Click this button to enter the search menu.
SETUP	Select this option to enter the Setup menu.
DISPLAY	Select between different multi-view display formats.
SNAPSHOT	Capture pictures and store as BMP files

SUPER EZ COPY	Select this option to start EZ Copy Wizard.
ENABLE MANUAL RECORD	Manual Record button. Click this button to enable manual recording.
INSTANT PLAYBACK	Instantly playback 10 to 60 seconds of recorded data.  Recommended to be used with record mode set to CONTINUOUS.

ADVANCED MENU

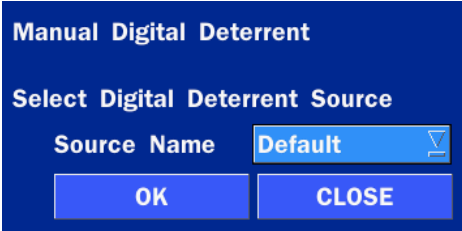
EZ SETUP	Select this option to start EZ Setup Wizard.
CONNECT	Select this option to disconnect/connect from IP Camera.
AUDIO MUTE	Select this option to mute audio on all channels.
CAMERA PTZ	Pop up the PTZ user interface.
ENABLE MAIN MONITOR SEQUENCE	Sequence button. Click this button to use a sequence function.
DISABLE ALARM OUT	Click this button to enable/disable Alarm outputs
MANUAL DIGITAL DETERRENT	Select this option to manually trigger any of the saved Digital Deterrent messages. 

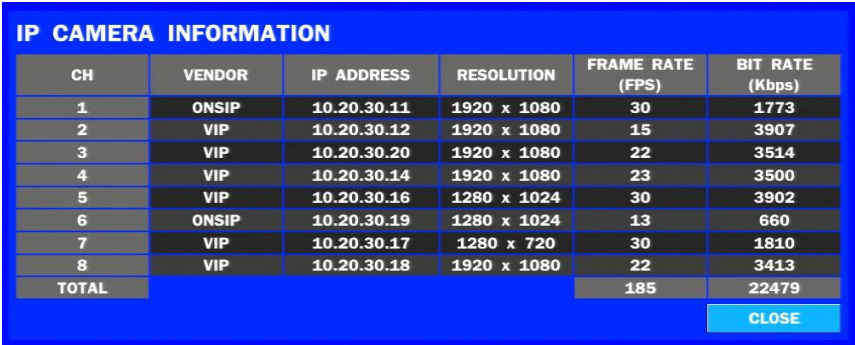
CAMERA INFORMATION	Press the button to view the record setting of a selected channel. 
---------------------------	--

SYSTEM INFORMATION	Press the button to view the system information.
---------------------------	--



EXPORT HELP Displays window with instructions for exporting video.

SYSTEM Locks the system from unauthorized user access.

LOCK

SYSTEM Select this option to shutdown system.

SHUTDOWN

5-1-1. PTZ Control

Table 5.1.3. Menu Items in PTZ Control Window

Item	Description
INITIALIZE	Initialize the PTZ settings of the selected camera
PAN/TILT	Select PAN/TILT using the ▲▼◀ and ▶ button, then press SEL . Adjust the tilt (UP/DOWN) & pan (LEFT/RIGHT) position using the ▲▼◀ and ▶ buttons.
ZOOM/FOCUS	Select ZOOM/FOCUS using the ▲▼◀ and ▶ buttons, then press SEL . Adjust the zoom (UP/DOWN)/ focus (LEFT/RIGHT) position using the ▲▼◀ and ▶ buttons.
OSD	Select OSD to enter the menu. Control keys are Right, Left, UP, Down, Select, Far (REW KEY), and Near (FF KEY). Press the ESC button to return to the previous menu. Press the PTZ button to close the OSD menu.
AUTOSCAN	Press the right key (▶) to start auto scan. Press the left key (◀) to stop auto scan.
PRESET	Select PRESET, and then press the left key (◀). A number input window will appear. Set the number (3 digits) using the number key, and then press the SEL to confirm the preset number for the current position. Press the right key (▶) and enter the number (3digits) to go to the preset position.
TOUR	Select TOUR and press the right (▶) key. A number input window will open. Select a number (1 digit) using a number key, and then press SEL to start the tour. Press the left (◀) key to stop the tour. Preset the number of the tour group in the OSD menu.
NO.	For the TOUR and PRESET menu.
	Press ESC to return to the main menu



5-2. Digital Zoom in Live and Playback Screen

NS series supports Digital Zoom feature during live and playback mode.

1. Double click the target channel.

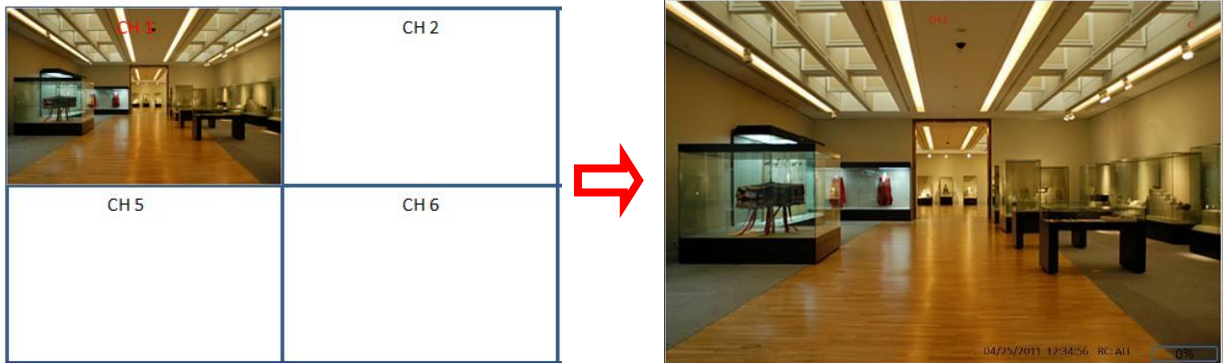

2. Click the left button of the mouse and drag to make rectangular shape.

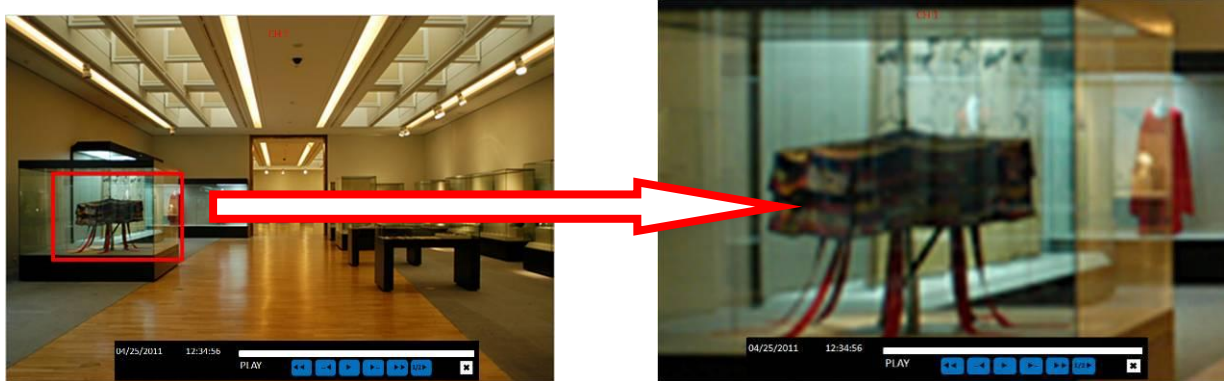

5-3. SEARCH Screen

To enter the search screen menu, select SEARCH menu on the screen using the mouse or press SEARCH icon on live screen.

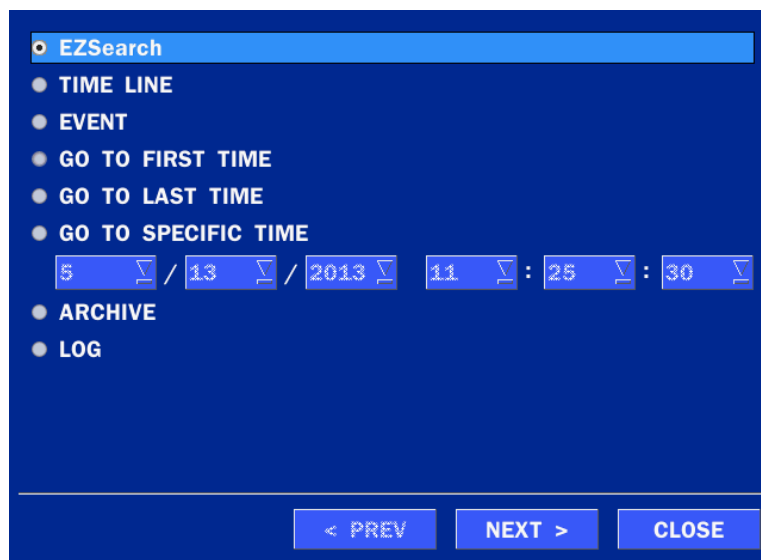

Figure 5.3.1. Search Screen

There are 7 playback options provided in the search menu, such as EZSEARCH, TIME LINE (Calendar), EVENT, GO TO FIRST TIME, GO TO LAST TIME, GO TO SPECIFIC TIME, ARCHIVE, and LOG on the screen.

5-3-1. EZSearch

The EZSearch window is used to find stored video with ease using the thumb nail playback screen.



Figure 5.3.2. Calendar Screen

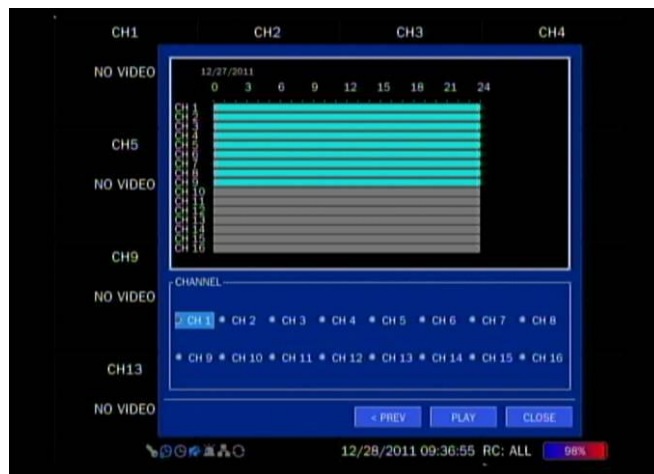

Figure 5.3.3. Channel Selection Screen



Figure 5.3.4. 24 Hourly Thumbnail Screen

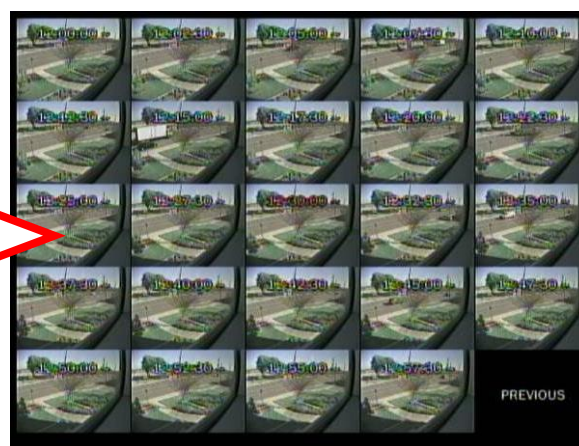

Figure 5.3.5. Minute Thumbnail Screen



Figure 5.3.6. Play Mode Screen

1. When the EZSearch menu is selected, the user can see a calendar, which displays recorded dates with highlights. Select a specific date on a calendar.
2. Select a channel from Channel Selection Screen. Then, 24 Hourly Thumbnail Search screen displays.
3. Select the hourly thumbnail. Then, Minute Thumbnail Search screen displays.
4. Select the thumbnail of minutes that you want to playback.

5-3-2. Time Line Search

The CALENDAR Search window is used to find the stored video by using the time line bar.



Figure 5.3.7. Calendar Screen

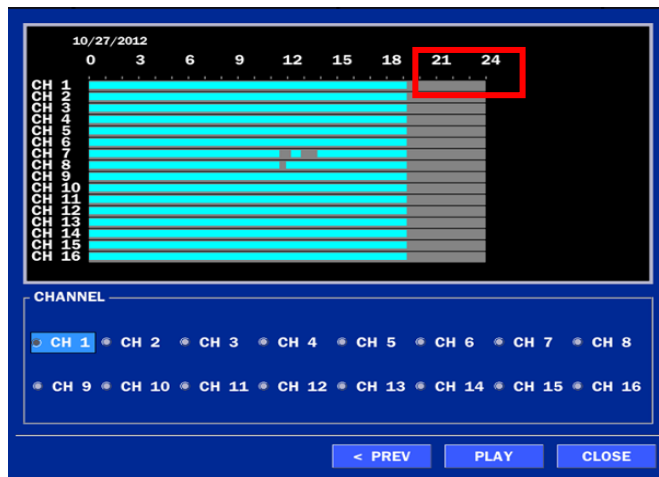

Figure 5.3.8. Time-Line Search Screen

When the Timeline menu is selected, the user can see a calendar, which displays recorded dates with highlights. Select a specific date and time. Click and drag the red time indicator bar to the desired hour. User can select a specific minutes using a button in the above red box. Press the PLAY button after selecting the specific time. Press the PREV to return to the SEARCH window.

5-3-3. Event Search

The Event Search window is used to find stored video.

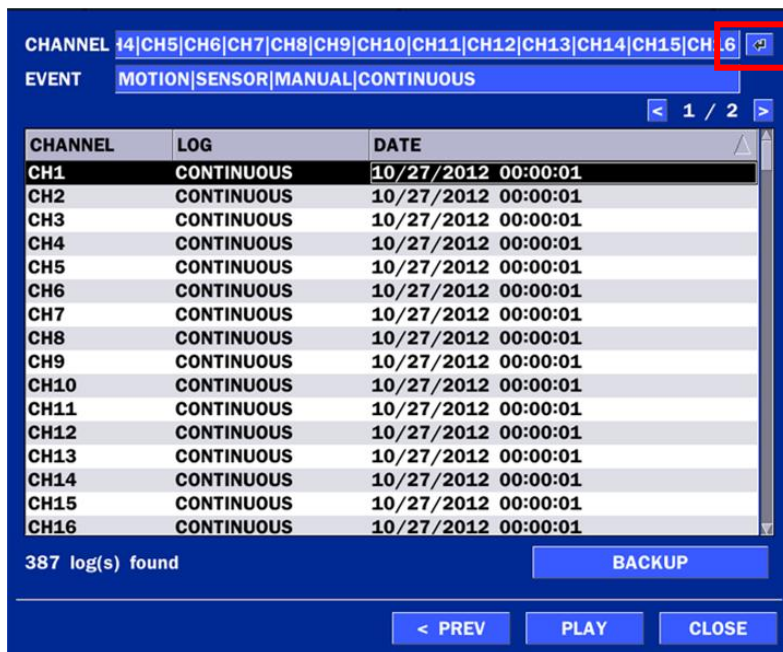

Figure 5.3.9. Event Search Screen

When the Event menu is selected, the user can see a calendar, which has recorded data. Select a specific date and the event log will be displayed. Press the PLAY button to playback the data or the SAVE button to save the data after selecting the specific data. User can find a data of the specific channel and event using a button in the above red box as following Figure 5.3.10. Press the PREV to return to the SEARCH window.

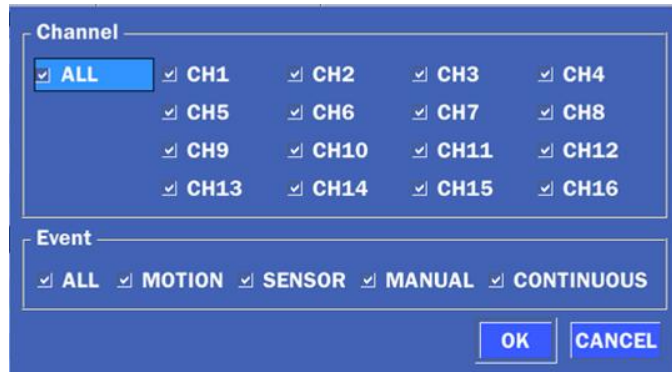

Figure 5.3.10. Event Search Screen

5-3-4. Go To First Time

User can access from the oldest recorded data on the NS hard drive by selecting GO TO FIRST TIME on the SEARCH window. Press the PREV to return to the SEARCH window.

5-3-5. Go To Last Time

User can access from the last minute recorded data on the NS hard drive by selecting GO TO LAST TME on the SEARCH window. Press the PREV to return to the SEARCH window.

5-3-6. Go To Specific Time

User can search for video data from a specific instance by setting the date and time in the GO TO SPECIFIC TIME menu. Use the mouse or the remote control to change the date and time value and press the PLAY button after setting. If there is no video data in the set date and time, No Data Exist message displays.

5-3-7. Archive List

The ARCHIVE Search window is used to find previously stored video or images.

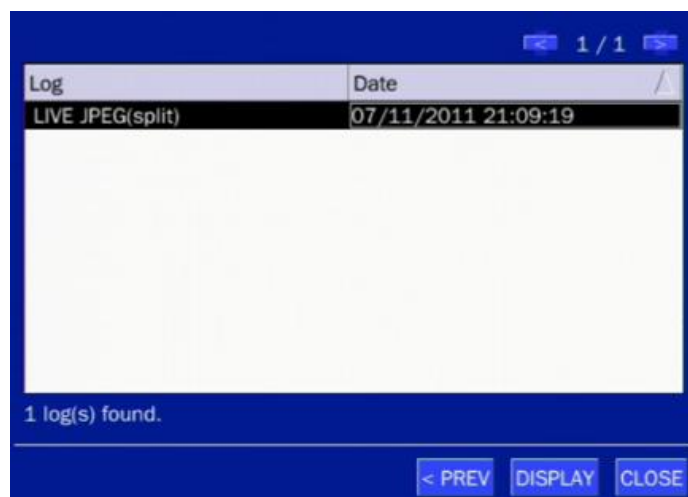

Figure 5.3.11. Archive Search Screen

When the Archive menu is selected, the user can see a calendar, which has recording data. Select a specific date and then the archived data will be displayed. Press the Display button to view the still image or the first frame of the selected video, then the user can save the selected data.

5-3-8. Log List

You can access the LOG list search screen by selecting LOG on the SEARCH window.

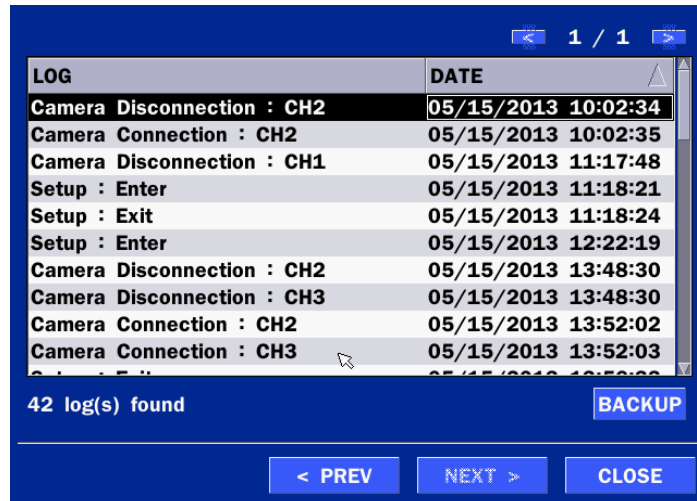

Figure 5.3.12. Log List Screen

When the Log menu is selected, the user can see a calendar, which has a log data. Select a specific date and press NEXT button, and then the log data will be displayed. Press the SAVE button to save the data and then the data is saved as a text file format.

5-4. Play Mode









During playback of a recorded event, the mode changes from SEARCH to PLAY. While in PLAY mode, user may return to the SEARCH screen by pressing the X button on the status bar.



Figure 5.4.1. Play Mode Screen

The following status bar hides automatically and appears again if a mouse pointer is positioned to the bottom of the screen.

Table 5.4.1. Button Functions in PLAY Mode

Button	Description
	<ul style="list-style-type: none"> • 2x, 4x, 8x, 16x, 32x speeds at 2x2 screen display mode. • 2x, 4x, 8x, 16x speeds at 3x3 screen display mode. • 2x, 4x, 8x speeds at the 4x4 screen display mode. • Single Channel backward playback speed 1x, 2x, 4x, 8x, 16x, 32x, 64x
	Jump/Step backward. The playback position moves 60 seconds backward.
	Press to play or pause recorded video.
	Jump/Step forward. Playback position moves 60 seconds forward.
	<ul style="list-style-type: none"> • 2x, 4x, 8x, 16x, 32x speeds at 2x2 screen display mode • 2x, 4x, 8x, 16x speeds at 3x3 screen display mode. • 2x, 4x, 8x speeds at the 4x4 screen display mode. • Single Channel forward playback speed 1x, 2x, 4x, 8x, 16x, 32x, 64x
	Slow Mode play. Forward playback speed x1/4, x1/2
	Press to backup the video.
	EZCopy button.
	Return to the previous menu screen, search window, or exit from the Menu.

6. Back Up

6-1. Still Image Backup onto USB Flash Drive

Still images can be captured and archived onto a USB flash drive or an USB external hard drive in live mode or while playing back recorded video.

1. Select a specific channel, which wants to backup on live screen.
2. When you press SNAPSHOT button on Quick operation window, the media selection window screen will display.

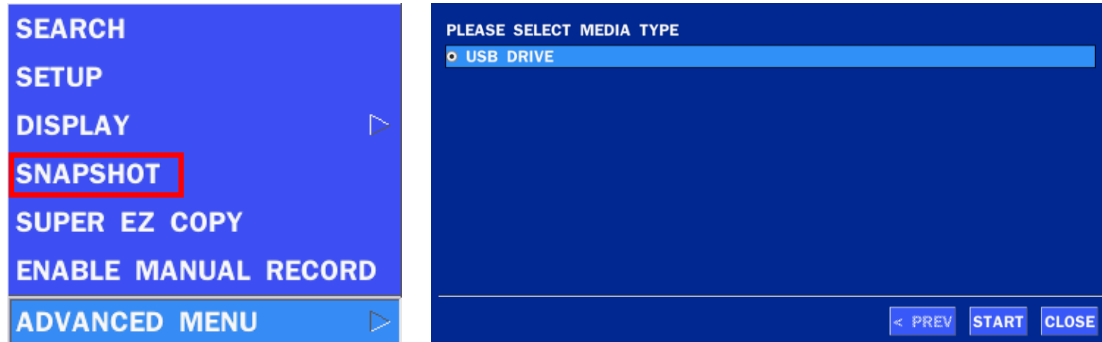

3. Once you press START button, the system will capture a still image and archive onto a USB flash drive.



NOTICE

USB Flash Drive must be in FAT32 file format.

6-2. Video Backup onto USB Flash Drive during playback

Video can be captured and archived onto the USB flash drive or a hard drive while playing back the recorded video. In playback mode, press the  BACKUP button to launch the backup function.

1. When you press  BACKUP button on the selected channel or all channels, the DVR will ask whether to archive a Still Image, a NSF or AVI and select the proper media type.

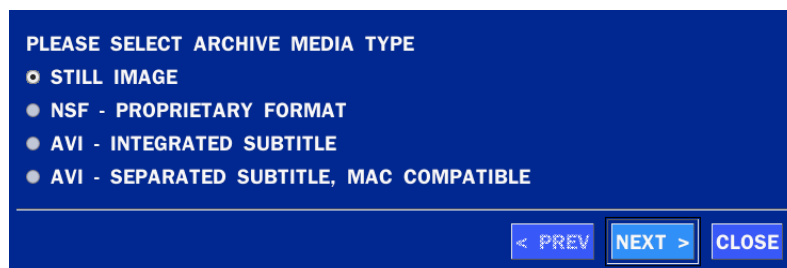

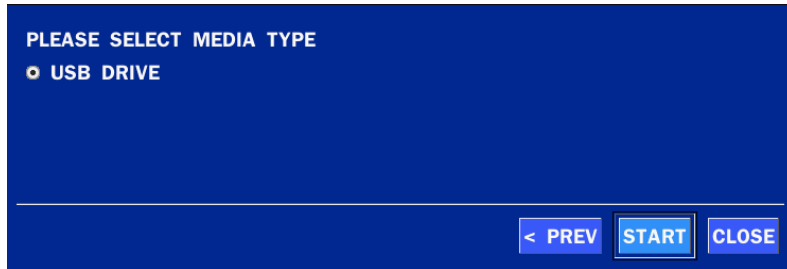

2. Select USB STICK-DRIVE (Flash Drive) to back up less than an hour.
Select USB HDD (Large Backup) to back up from 1 hour to 24 hours.

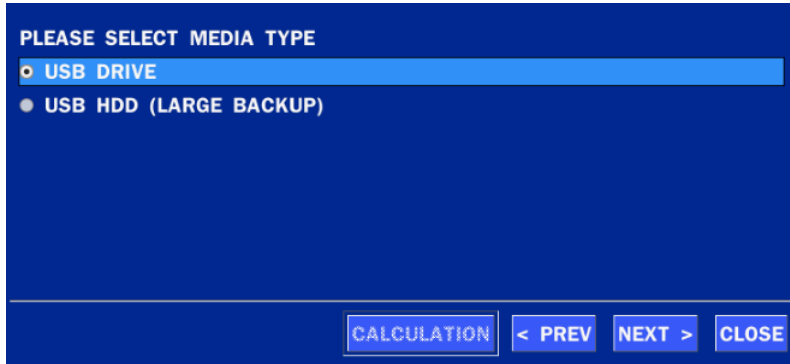

3. Once you select the channel and duration, the system will start to archive the data to the USB drive.

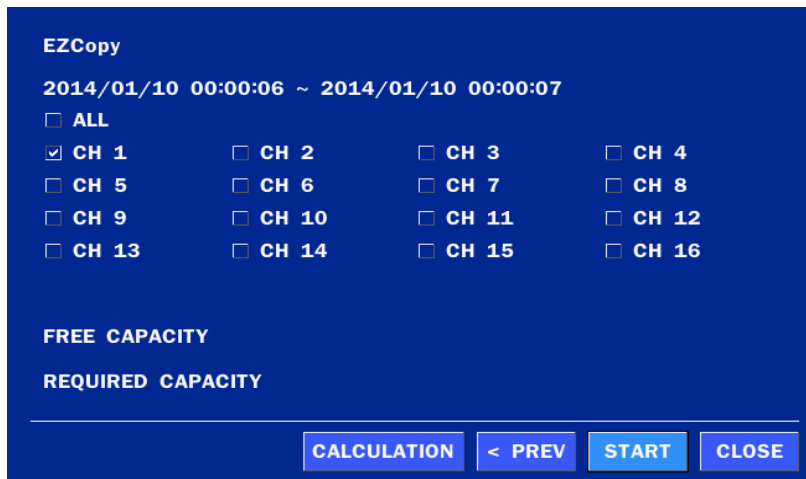

4. The following image shows the progress of archiving the data.

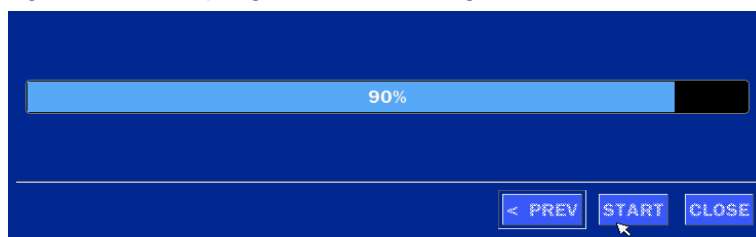

5. The following shows the image to complete the backup. Select lose to return to the previous screen.

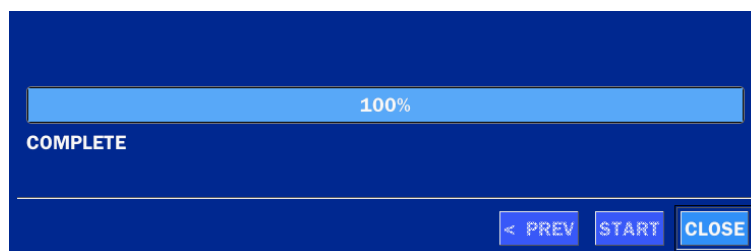

6-2. EZCopy: Video Backup onto USB Flash Drive during playback

Using EZCopy feature, Video can be easily archived onto the USB flash drive or a hard drive.

In playback mode, press the  **EZCOPY** button to launch the backup function.

1. Press EZCOPY button on the selected channel or all channels.

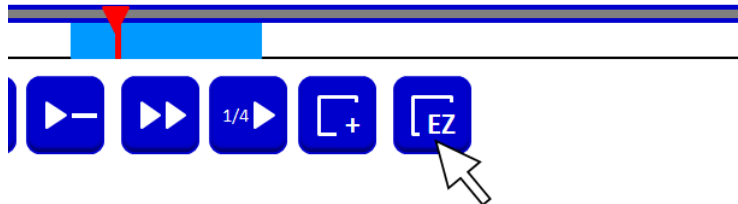

2. Then, EZCOPY START time will display.

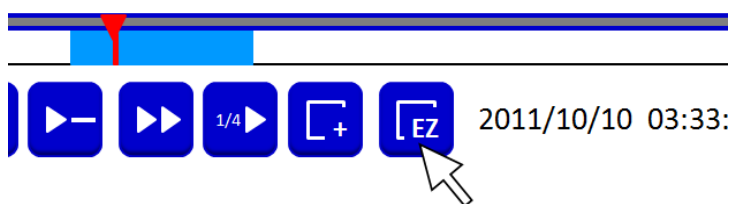

3. Move  time bar cursor to the time of end of backup and press EZCOPY button. Then, EZCOPY STOP time will display.

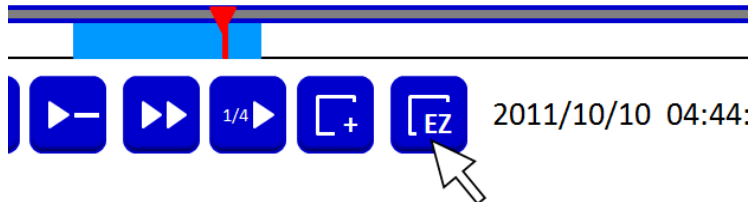

4. EZCOPY window will display. The NS will ask whether to archive a Still Image, a NSF or AVI.

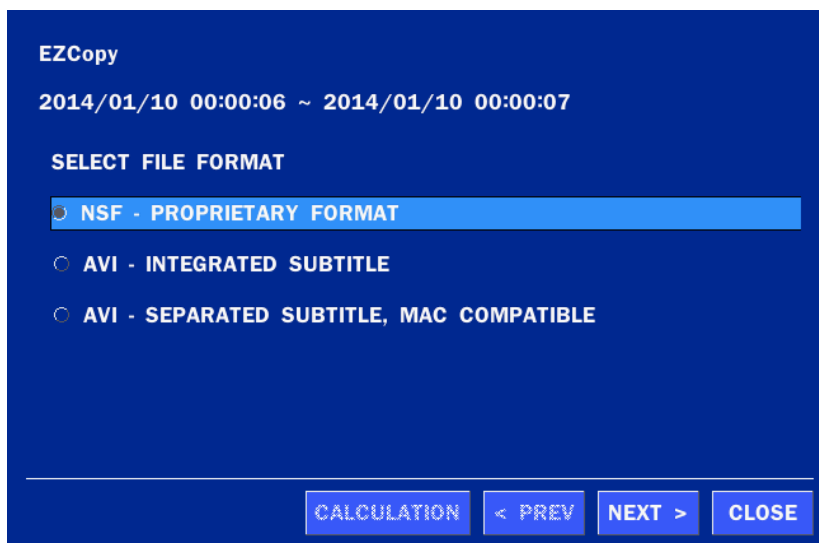

5. After backup format is selected, also select media type and channel(s) to archive the data to the media.

6-3. Transferring Still Images or Video from the ARCHIVE List

The stored data in the hard drive can be found in the ARCHIVE list in the SEARCH window.

User can back up still images or video into the storage device from the ARCHIVE list.

1. Select the date to begin searching and navigate through the days using the mouse or the remote control.
2. Once you have selected the date, press the NEXT button to open the list of stored data.
3. Use the mouse or the remote control to scroll through the archive list.
4. Select a list of stored events in the archive list.
5. Once the desired event has been selected, press the DISPLAY button to view the still image or the first frame of the selected video.
6. Press the BACKUP button to launch the archiving function in playback mode.
7. Press the CLOSE button to return to the SEARCH window.

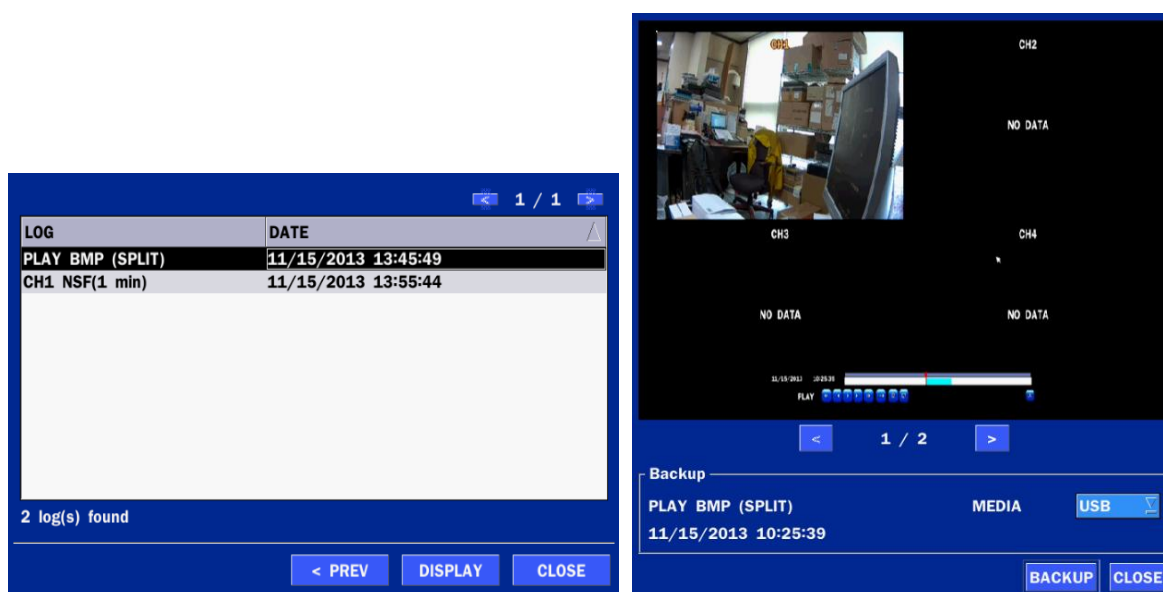

Figure 6.3.1. Archive Search Screen

6-4. Playback of Backup Video

6-5-1. AVI Format

AVI format: AVI format video can be played back by Window Media Player™ or other media player that is compatible with AVI format video.

1. Please install the NS copies “UMS Decoder Filter” folder on USB flash drive with the video.

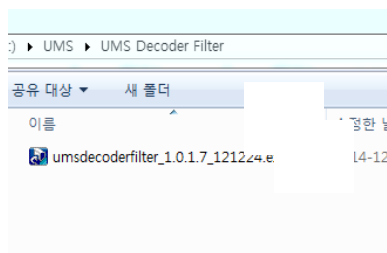

2. Otherwise, the video and time stamp over video can't be properly playback and displayed on Window Media Player™.



Timestamp On AVI. The subtitle is embedded to the video clip file.

The subtitle is embedded to the AVI file. To display a subtitle, user should install a special filter called "UMSDecoderFilter".

6-5-2. NSF Format

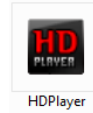

NSF format: NSF format video can be played back using the HDPlayer that the NS copies to "NSPlayer" folder on USB flash drive with video. Use the mouse scroll to use digital zoom in and out feature.

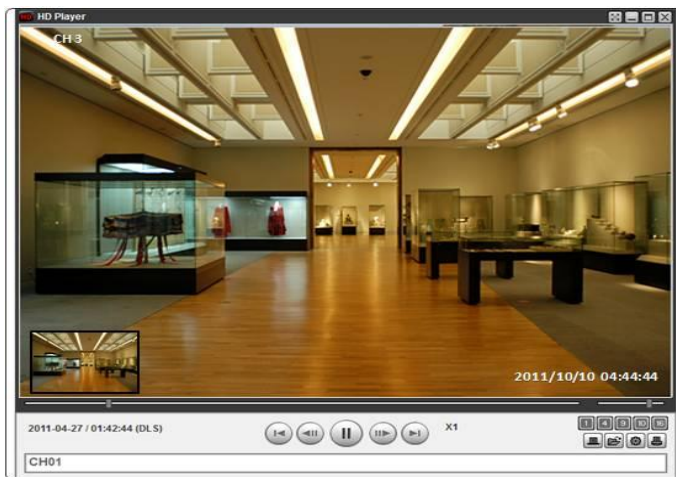

7. Network Access Using the Multi-Sites Network Viewer

7-1. Overview

The SpecoTech Multi Client is a multiple site monitoring client software with; video, audio, and alarm signals from the NS over the network. The SpecoTech Multi Client does not limit the number of NS units to register. The program displays up to 16 NS units and supports dual monitors.

On the program, user may control PTZ cameras on the NS. By attaching a microphone and speaker system to devices on site, the user may make bi-directional audio communication over the network.

7-2. PC Requirements

Minimum PC Requirements

CPU	Intel Core i3
	1.8Ghz
Memory	2GB DDR2
VGA	512MB
Resolution	1280x720
Disk Space	1GB
OS	Windows 2000, XP Professional, XP Home, Vista, 7 (NOTE: Not all versions of Vista and 7 are supported)
Network	10/100Base T
Others	Direct X 9.0c or Higher

Recommended PC Requirements

CPU	Intel Core i5
	2Ghz or higher.
Memory	4GB DDR3 or higher.
VGA	512MB or higher.
Resolution	1920x1080
Disk Space	1GB
OS	Windows 2000, XP Professional, XP Home, Vista, 7 (NOTE: Not all versions of Vista and 7 are supported)
Network	10/100/1000Base T
Others	Direct X 10 or higher.

Before installing the program, check the PC specifications. The NS remote software may not perform correctly if the PC does not meet the minimum requirements.

7-3. Installation of the Program

1. Insert the provided CD in the CD drive and double-click “SpecoTech Multi Client (XXXX).exe”

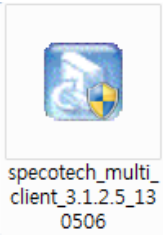

2. Select a destination folder and click “Next”.

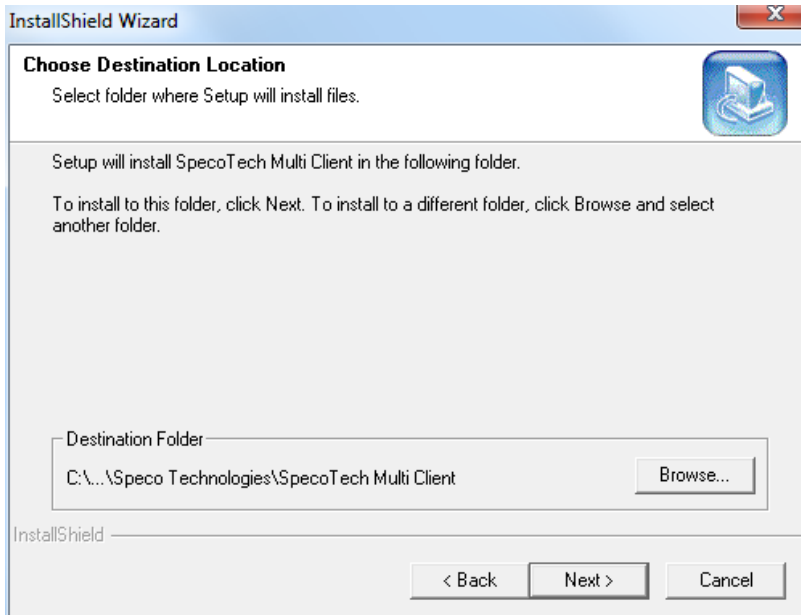

3. Select the program folder and click “Next”.

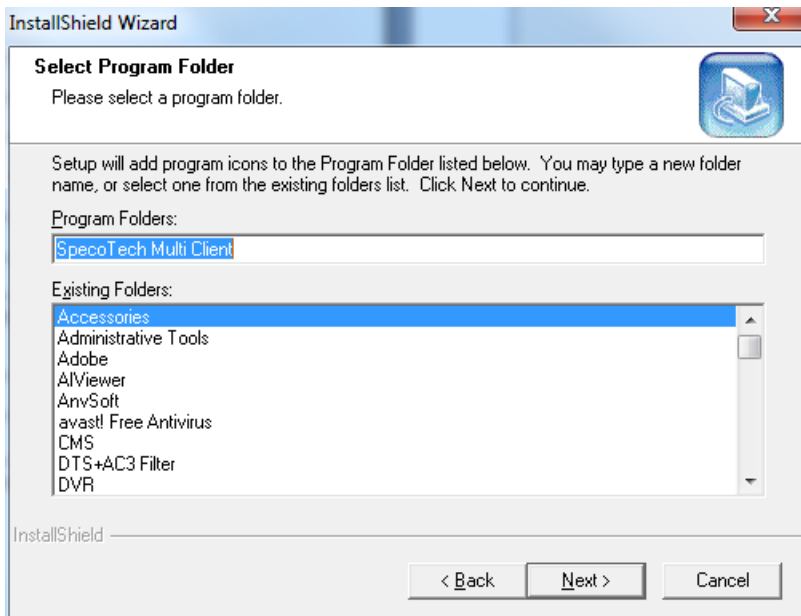

4. The installation status screen is displayed.
5. After the installation is completed, “**SpecoTech Multi Client**” icon displays on the desktop screen.









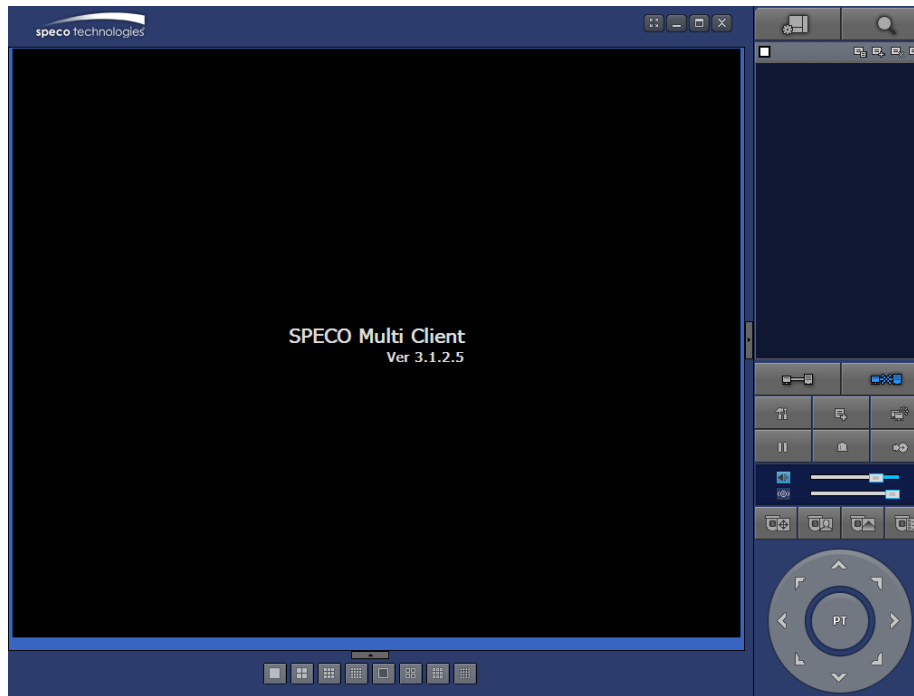

7-4. Live Window



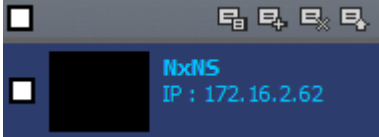



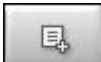

When installation is completed, double click the “SpecoTech Multi Client” icon on your desktop to start the program.

7-4-1. Main User Interface

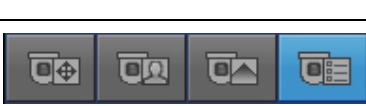

7-4-2. Control Buttons

Button	Description
 LOCAL PLAYBACK	Click this icon to run a playback window to search and play videos that are recorded in the local PC.
 REMOTE PLAYBACK	Click this icon to run a playback window to search and play videos that are recorded in the remote NS.
 SITE MANAGEMENT	<ul style="list-style-type: none">  THUMBNAIL REFRESH: Click this icon to refresh and renew thumbnail image of the connected sites.  SITE ADDITION: Click this icon to open 'Site Addition' window.  SITE DELETE: Click this icon to delete site from the index window, after disconnect a site.  NET FINDER: Select the site from the index window and click this icon to modify the information of specific site.
 CONNECT	Click this icon to connect the selected site/sites.
 DISCONNECT	Click this icon to disconnect the selected site/sites.

 SETUP	Click this icon to setup configuration of MULTI CLIENT.
 CAPTURE	Click this icon to capture a still image.
 EVENT LIST	Opens list of events logged by Multi Client.
 PAUSE	Click this icon to play/pause live video.
 ALARM ON	Click this icon to turn on/off alarm outputs.
 RECORD ON	Enable or disable recording of live video to local disk, which has set in setup menu.
 AUDIO	Use the volume control bar to set the audio level.
 MIC	Use the microphone volume control bar to set the micro phone level.
 PRESET/TOUR/SCAN/MENU	User can control PRESET/TOUR/SCAN/MENU
 CHANNEL SPLIT	To select the numbers of display channel/channels (Single, quad, 9 channels, and 16 channels) of highlighted site.
 NS SITE SPLIT	To select the numbers of NS/NSs (1 NS, 4 NSs, 9 NSs, 16 NSs) on main display screen.







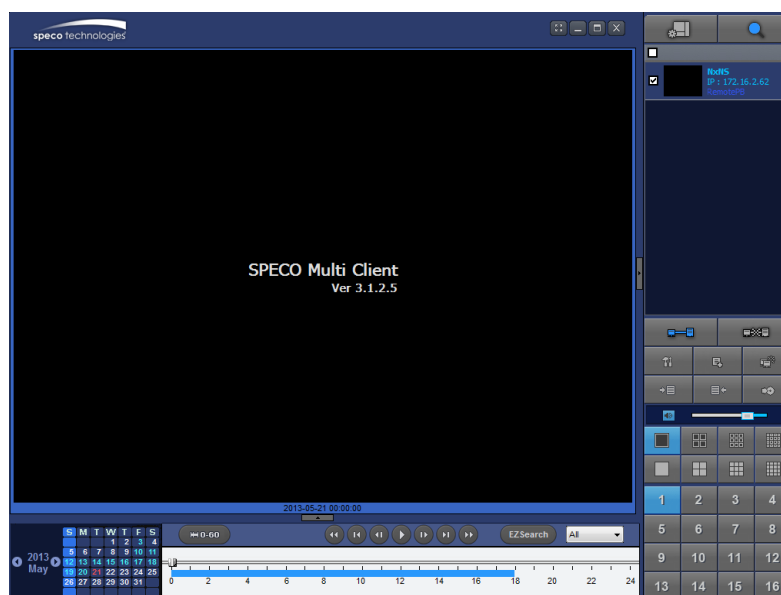





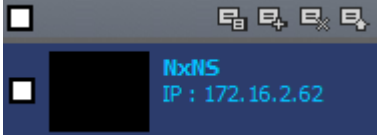





7-5. Search and Playback Window







7-5-1. Main User Interface

You can access to search window by clicking the search icon (Local Playback / Remote Playback) on the upper right of the Live Window.

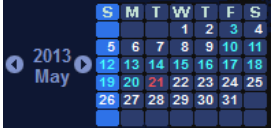

7-5-2. Main Control Panel

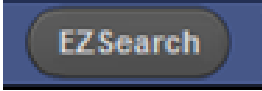
Button	Description
 LOCAL PLAYBACK	Click this icon to run a playback window to search and play videos that are recorded in the local PC.
 REMOTE PLAYBACK	Click this icon to run a playback window to search and play videos that are recorded in the remote NS.
	<p> THUMBNAIL REFRESH: Click this icon to refresh and renew thumbnail image of the connected sites.</p> <p> SITE ADDITION: Click this icon to open 'Site Addition' window.</p> <p> SITE DELETE: Click this icon to delete site from the index window, after disconnect a site.</p> <p> NET FINDER: Select the site from the index window and click this icon to modify the information of specific site.</p>
 CONNECT	Click this icon to connect the selected site/sites.
 DISCONNECT	Click this icon to disconnect the selected site/sites.
 SETUP	Click this icon to setup configuration of SpecoTech Multi Client.
 CAPTURE	Click this icon to capture a still image.
 EVENT LIST	Opens list of events logged by Multi Client.
 EZCopy Start	Click this icon to set the beginning time for backup of the recorded video in AVI format.
 EZCopy End	Click this icon to set the ending time for backup of the recorded video in AVI format.
 BACKUP	Click this icon to backup the recorded video in AVI format.
 AUDIO	Use the volume control bar to set the audio level.
	To select the numbers of NS/NSs (1 NS, 4 NSs, 9 NSs, 16 NSs) on main display screen.
	To select the numbers of display channel/channels (Single, quad, 9 channels, and 16 channels) of highlighted site.

	To select the channel to playback.
	The calendar shows dates with recorded video in color.
	To display the recorded data of selected channel or all channels on a time line scale.
	To change a timeline scale from 24 hours to 60 minutes. The timeline shows recorded data in color on the bar. You can adjust the timeline scale and move it to the time you wish to playback. Then click the play icon to display the recorded video.
	Playback buttons.
	Thumbnail search over the network. - List the thumbnail 24images from 00:00 to 23:00. - Select one of 24 images every 150sec for an hour. - Then play the tile * Click the "PREVIOUS" button to go the previous step.
	Digital Zoom Window in Live and Playback. (Only available in Single Channel Viewing)

7-6. Setup of SpecoTech Multi Client

Click the setup icon  to setup the configuration of Multi Client software. The SETUP window is displayed as below.

7-6-1. General

Security Option: Set a password for security options. Select security options and set a password.

Then when you access any of selected functions, you need to enter the password.

You can also set the save path for capturing and backup.

Save Path: Specify the location to save captured still image for Capture and Backup data.

Miscellaneous

Automatic Reconnection: If enabled, the software will automatically try to reconnect to the last successful IP address. But, when CLIENT ACCESS is OFF on the NS, the software will not try to reconnect even if it is enabled.

Always On Top: If enabled, the software display will be continuously on the top of other windows.

Time Format: Change the way the Client software displays the time.

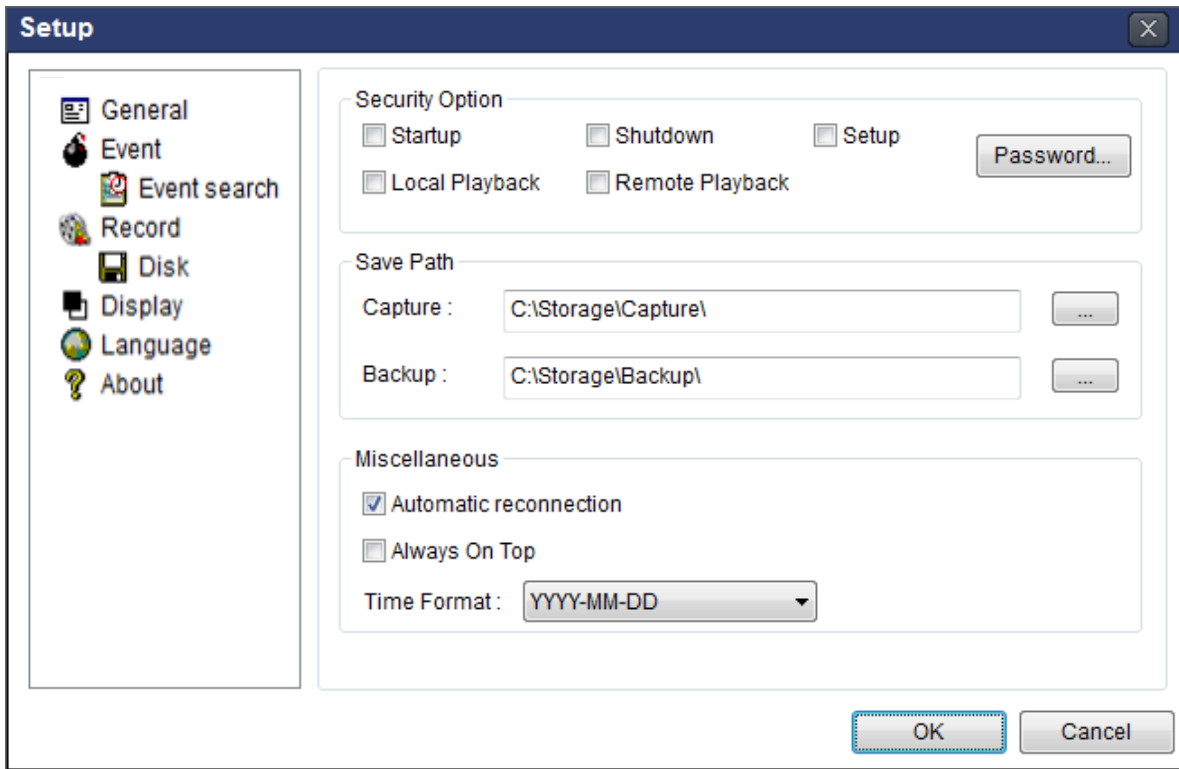

7-6-2. Event

Event log can be archived and searched.

Event Log: Specify the location to save event logs and select event to archive.

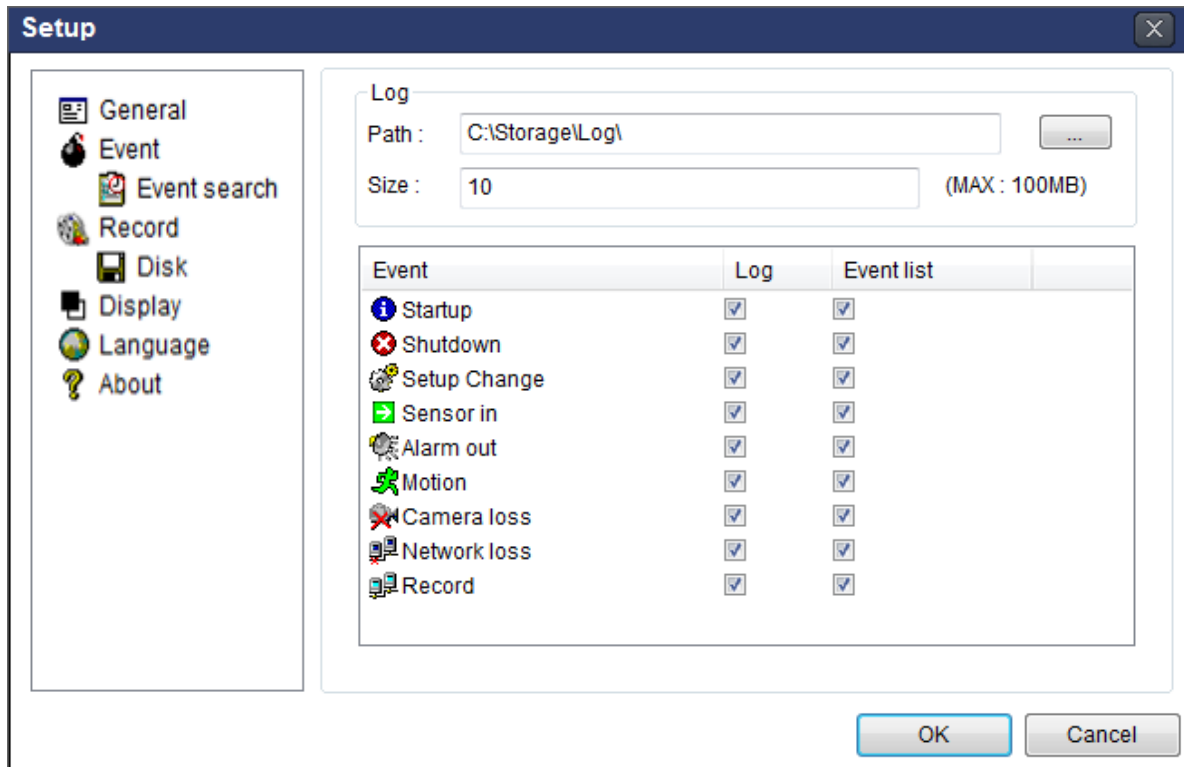

Event Search: Event log can be searched from the selected time.

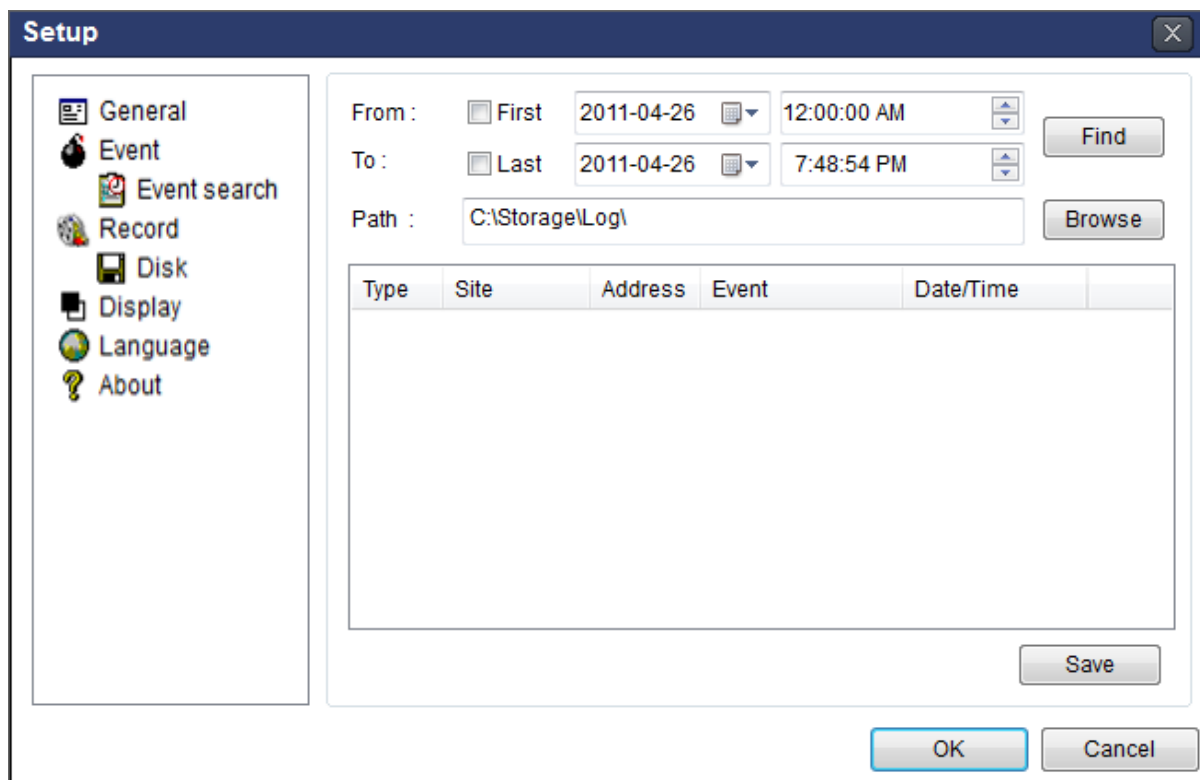

7-6-3. Record

Record Setup: You can set the recording conditions as the following; Always, Event, or Auto record. And you can also select target NS/NSs and channel/channels. When you set the recording condition to event, you can set event for motion or alarm with duration.

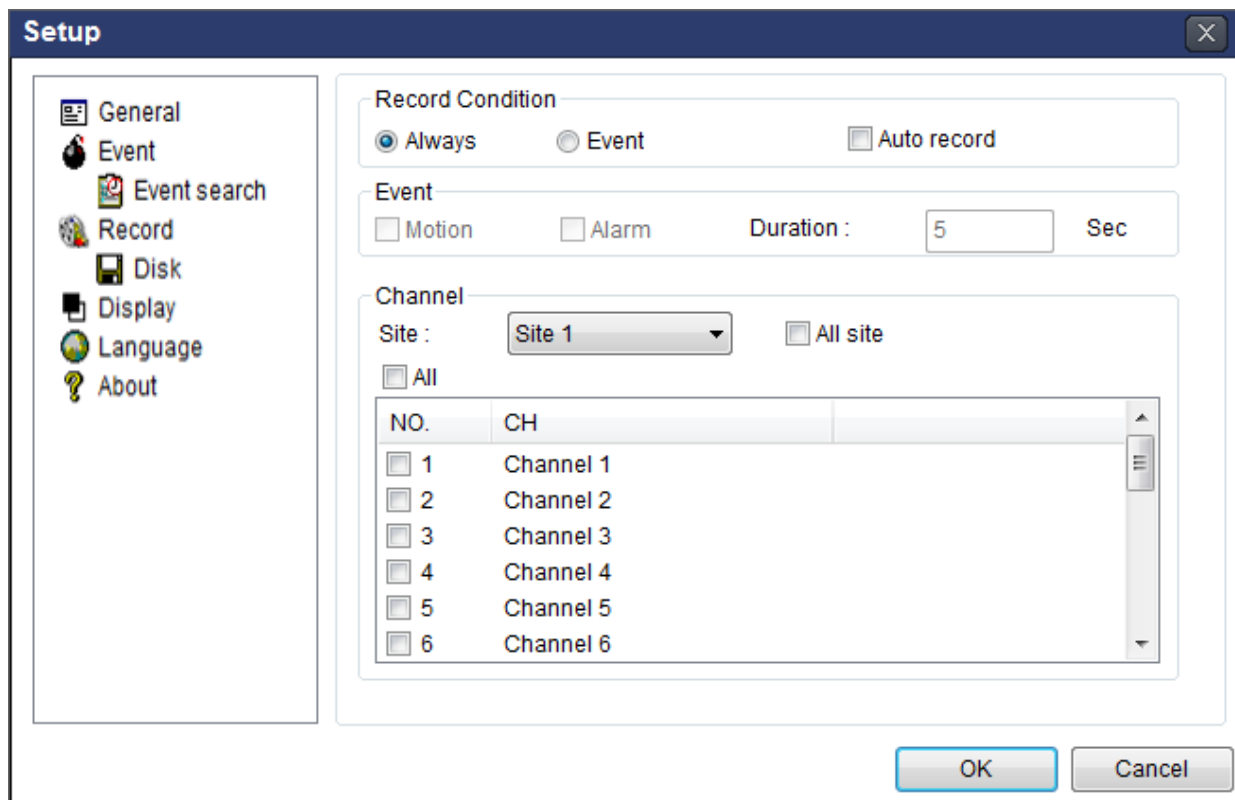

Record Local Storage Setup: You can select the local disk to record and the amount of disk space you want to allow the program to use for recording. You can also select the option to overwrite data or stop recording when the maximum amount of disk space is full.

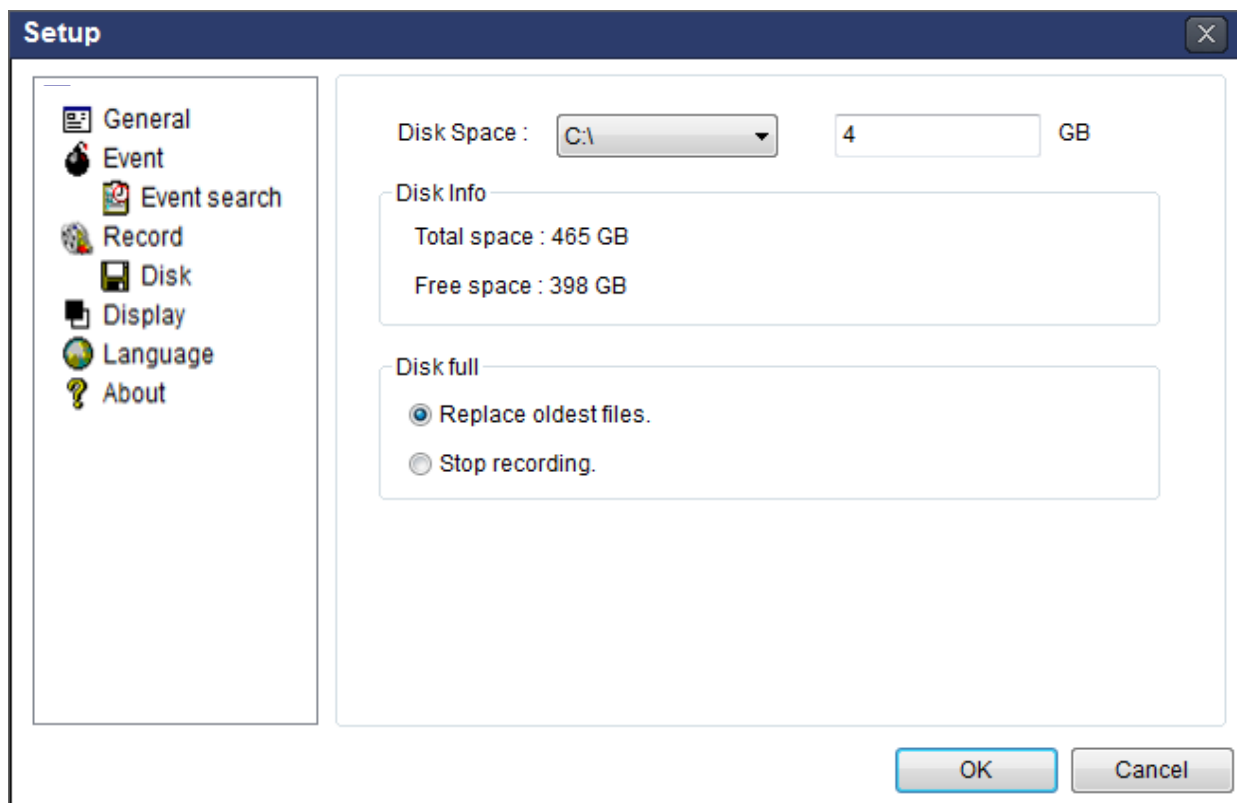

7-6-4. Display

You can select the OSD (On Screen Display) to be displayed.

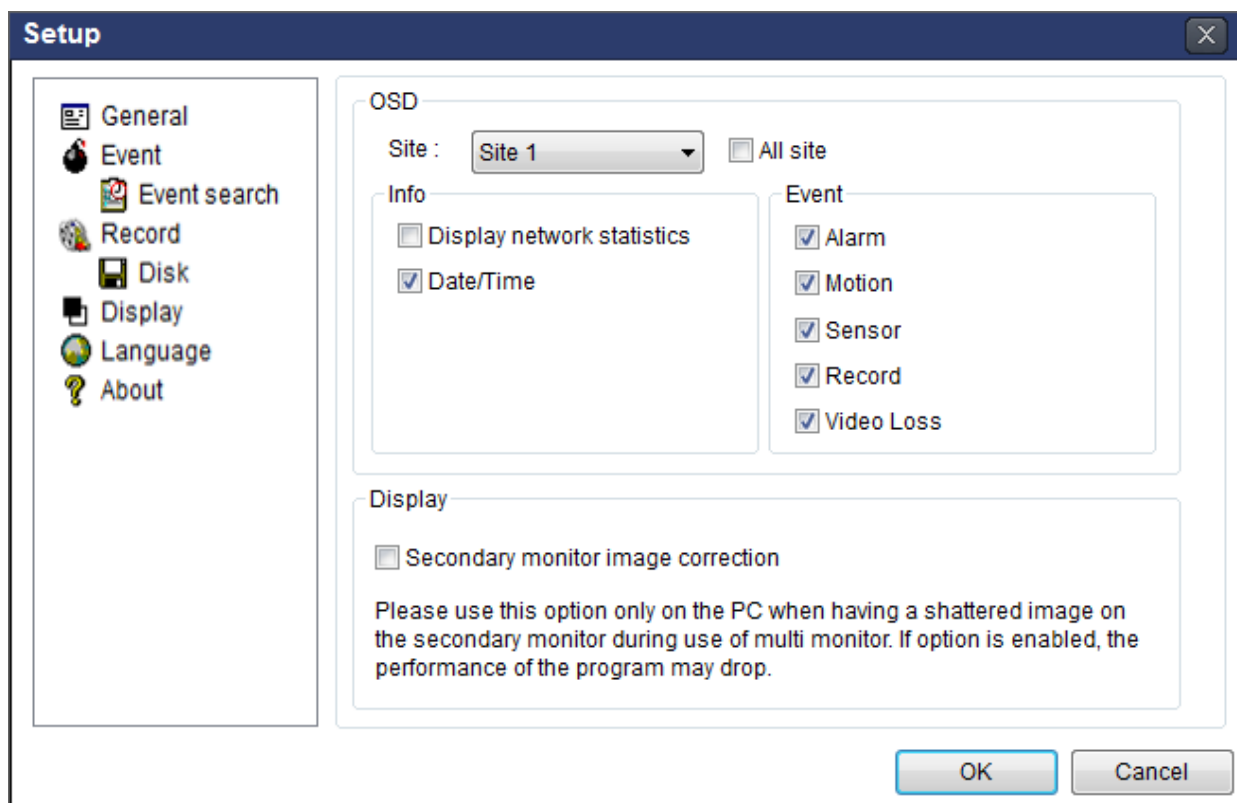

7-6-5. Language

English, French and Spanish is selectable.

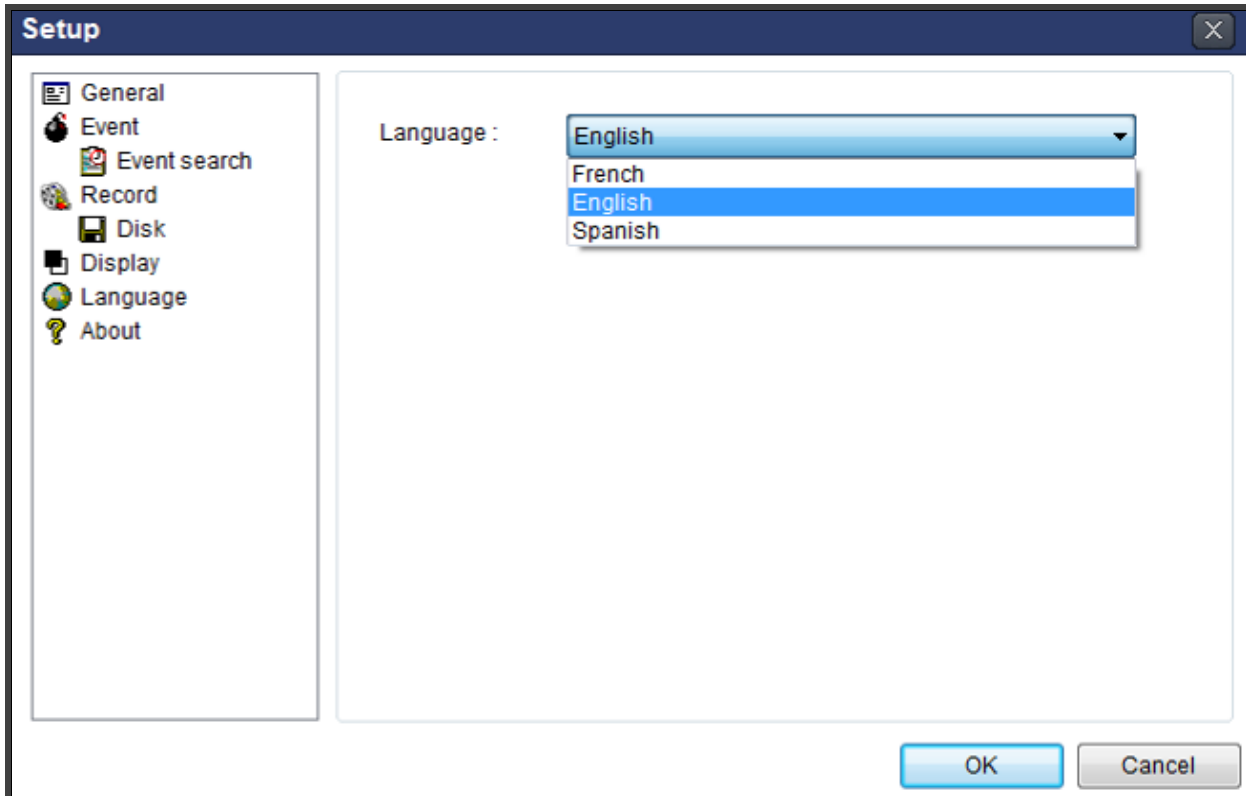

7-6-6. About

“About” provides network client version information.

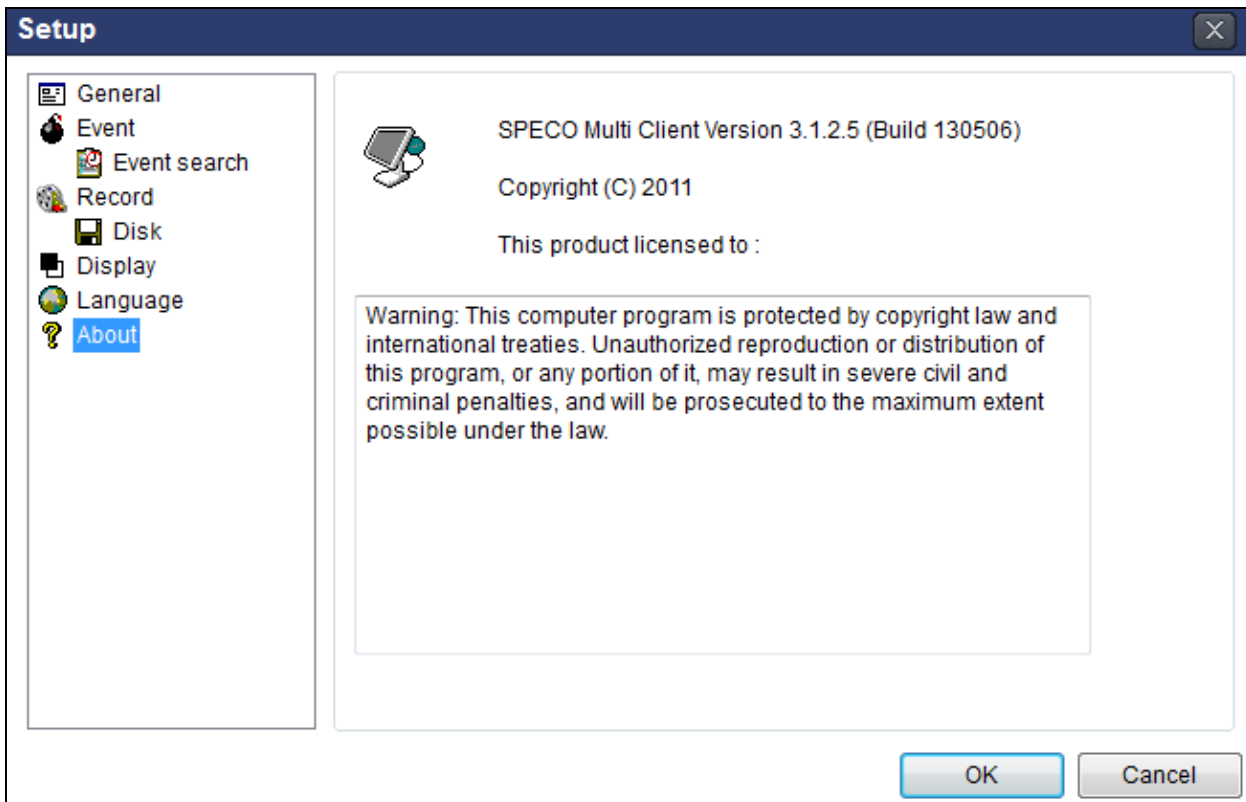

7-7. Remote Setup

The menu settings for the NS unit can be set over network.

Put the cursor of the mouse on the channel, which is connected to the site and right click on the mouse to open the submenu. Then the following window is displayed as below. Select the **REMOTE SETUP**.

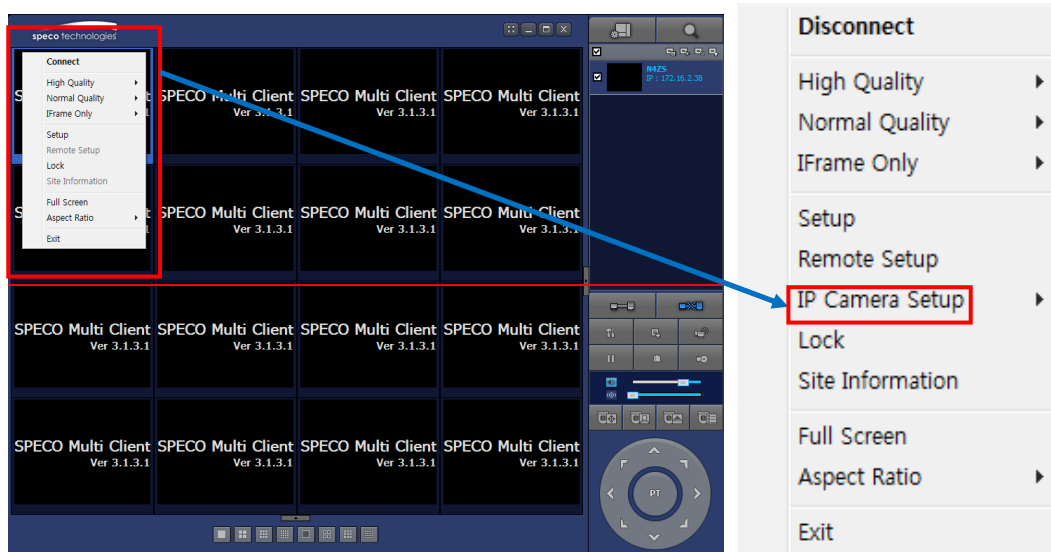

Then the setup window is displayed. The specified menu screen is displayed on the upper left of the screen. Enter the password of the NS when prompted. (NOTE: The default password is 1111)
Setting is the same as with the NS menu setting. Refer to the corresponding pages for details on the setting items.



NOTICE

Web Setup is prohibited when NS is in local Setup Menu.

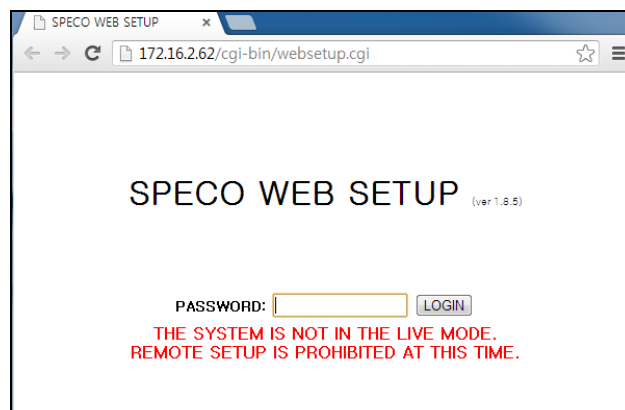

7-7-1. IP Camera

Select **IP Camera** to set system and time settings

SPECO WEB SETUP

(ver 1.10.9)

IP CAMERA	SYSTEM	RECORD	DEVICE	DISPLAY	NETWORK	USER MANAGEMENT	STORAGE	UPGRADE
INFORMATION								
CHANNEL	CH9							
PROTOCOL	ONSIP							
IP	0.0.0.0							
PORT	554							
WEB PORT	80							
ID	admin							
PASSWORD	1234							

7-7-2. System

Select **System** to set system and time settings.

IP CAMERA	SYSTEM	RECORD	DEVICE	DISPLAY	NETWORK	USER MANAGEMENT	STORAGE	UPGRADE	INFORMATION
DATE DISPLAY FORMAT	MM/DD/YYYY								
TIME DISPLAY FORMAT	24-HOUR FORMAT								
TIME ZONE	GMT -5:00 (Montreal/New York)								
DAYLIGHT SAVING	USA								
SET DATE & TIME	SET DATE & TIME								
CLIENT ACCESS	<input checked="" type="radio"/> ON <input type="radio"/> OFF								
NTP SETUP	ON								
PRIMARY SNTP SERVER	Pool.ntp.org								
SECONDARY SNTP SERVER	Time.nist.gov								
TIME ZONE	GMT -5:00 (Montreal/New York)								
CONNECTION MODE	TIME								
CONNECTION PERIOD	03:00 AM								
SEND EMAIL SETUP	OFF								
SERVER TYPE	MANUAL								
MAIL SERVER									
MAIL PORT	25								
SECURE OPTION	NONE								
ID									
PASSWORD									
MAIL TO									
MAIL FROM									
SEND MAIL TEST	APPLY MAIL SETTING & TEST								
UNIT NAME	NVR								
SYSTEM RESTART	SYSTEM RESTART								

- **DATE DISPLAY FORMAT:** Select the date display format.
- **TIME DISPLAY FORMAT:** Select the time display format.
- **TIME ZONE:** Select the TIME ZONE.
- **DAYLIGHT SAVING:** Select the area for DAYLING SAVING TIME
- **SET DATE & TIME**

For the date & time changes to be applied, the system will reboot.

If the users change the time back to the past, it will not show "TIME MISMATCH" message unlike on the local system. The data on the duplicated period time will be deleted without WARNING.

- **CLIENT ACCESS:** Enable/Disable remote access through network client software.
- **NTP SETUP:** Sets whether to synchronize the time using NTP server or not.
 - **Primary SNTP Server:** Input the NTP primary server address.
 - **Secondary SNTP Server:** Input the NTP secondary server address.
 - **Time Zone:** Select the time zone.
 - **Connection Mode:** Select the connection mode to NTP time server.
- **SEND E-Mail SETUP:** Sets whether to enable/disable e-mail sending function.
 - **SEVER TYPE:** Select GMAIL, HOTMAIL, AOL, YAHOO or MANUAL)
 - **MAIL SERVER:** Input the SMTP server name as well as the user ID and password.
 - **MAIL PORT:** Mail port setting.
 - **SEURE OPTION:** Select a secure mail server connection. **(SSL or TLS)**
 - **ID :** Email User ID
 - **PASSWORD :** Email User Password
 - **MAIL TO:** Input the appropriate email address to enable sending e-mail reports
 - **MAIL FROM (Return Mail Address):** Set the source e-mail address to be notified to the destination.
- **SEND MAIL TEST :** E-mail settings sent a test mail to the registered account
- **UNIT NAME:** Name the HS
- **SYSTEM RESTART :** Restart the system
- **SYSTEM EVENT NOTIFICATION**

SYSTEM EVENT NOTIFICATION

DISK EVENT SETUP			
HEALTH CHECK			
PERIOD	DAILY		
	FRST	SUN	0 H
HDD TEMPERATURE	60°C 140°F		
HDD BAD SECTORS	10%		
HDD ALMOST FULL	90%		
VIDEO CLIP SETUP			
PRE RECORD	2 SECOND(S)		
POST RECORD	1 SECOND(S)		
EVENTS AND NOTIFICATION			
	ALARM-OUT	BEEP	E-MAIL
HEALTH CHECK	-	-	YES
RESTART	-	-	YES
SHUTDOWN	-	-	YES
PANIC RECORD	-	-	YES
ALARM-IN	NO	-	NO
MOTION DETECTION	NO	-	NO
NO CONNECTION	NO	NO	NO
HDD TEMPERATURE	1	YES	NO
HDD BAD SECTORS	-	-	YES
HDD ALMOST FULL	-	-	YES
HDD FULL	-	-	YES
HDD FAILURE	NO	NO	YES

RELOAD APPLY

Allows the user to set EVENT NOFICIATION ON or OFF

- **HEALTH CHECK**
(Allows the user to set MAIL STATUS periodically) : DAILY or WEELY or MONTHLY
- HDD TEMPERATURE

- HDD BAD SECTOR
- HDD ALMOST FULL
- **VIDEO CLIP SETUP:** Setting the duration for pre and post recording.
- **EVENTS AND NOTIFICATION**
 - HEALTH CHECK / RESTART / SHUTDOWN / PANIC RECORD:
Enable Email Notification in the event a problem occurs with the NS.
 - ALARM-IN : Enable Email Notification when the camera detects sensor
 - MOTION DETECTION : Enable Email Notification when the camera detects motion
 - NO CONNECTION: Enable Email, Beep and Alarm output Notification when the camera signal is lost.
 - HDD TEMPERATURE : Enable Email Beep and Alarm output Notification when the HDD reaches the maximum temperature
 - HDD BAD SECTOR : Enable Email Notification when the HDD has bad sectors.
 - HDD ALMOST FULL : Enable Email Notification when the HDD is almost full.
 - HDD FULL : Enable Email Notification when the HDD is full.
 - HDD FAILURE : Enable Email, Beep and Alarm output Notification when the HDD fails.

7-7-3. Record

Select **RECORD** tab to set the recording conditions.

The screenshot shows the RECORD configuration page. The 'RECORD' tab is active. The settings are as follows:

- SITE:** CH1
- RECORDING MODE:** CONTINUOUS
- SENSOR RECORDING:** All sensors are disabled (indicated by '-' in the dropdowns).
- PRE RECORD:** 1 MINUTE(S)
- POST EVENT RECORD:** 10 SECOND(S)
- AUDIO:** OFF
- SCHEDULE:** NONE

Below the settings is a calendar grid for scheduling recording. The grid has columns for hours (0-23) and rows for days of the week (SUN-SAT). All cells in the grid are currently empty, indicating no scheduled recording.

These settings apply to the specified channel only.

- Recording Setup
 - **RECORDING MODE:** CONTINUOUS, SCHEDULE, MOTION
 - **PRE RECORD:** Sets whether to perform or not pre recording.
 - **POST EVENT RECORD:** Sets the duration of the event recording.
 - **AUDIO:** Sets whether to perform or not audio recording.
 - **SCHEDULE:** Sets the schedule recording.

7-7-4. Device

Select **Device** to set device settings of the NS

IP CAMERA	SYSTEM	RECORD	DEVICE	DISPLAY	NETWORK	USER MANAGEMENT	STORAGE	UPGRADE	INFORMATION															
ALARM-OUT				1						▼														
ALARM DURATION				INFINITE						▼														
TYPE				NORMAL OPEN						▼														
DIGITAL DETERRENT																								
FILE UPLOAD										UPLOAD														
CHANNEL				CH1						▼														
SOUND TYPE				NONE						▼														
	0	1	2	3	4	5	6	7	8	9	10	11	12	13	14	15	16	17	18	19	20	21	22	23
SUN																								
MON																								
TUE																								
WED																								
THU																								
FRI																								
SAT																								

- ALARM OUT:** Set the sensor, motion, and video loss for triggering alarm relay.
 HDD Error and Video Loss can be set for triggering a beeping sound
 The following settings can be changed to trigger an alarm output.
 - ALARM DURATION**
- DIGITAL DETERRENT:** The schedule of digital deterrent can be set and a sound file can be uploaded to the NS.
 To set up schedule, select **CHANNEL** > select **SOUND TYPE** > select Area.
 - CHANNEL:** Select the Channel to configure audio input
 - SOUND TYPE:** Select the sound type.

CONTROLLER	---	▼				
SPEED	9600	▼				
ID	0	▼				
CHANNEL	CH1	▼				
AUDIO SOURCE	IP CAM	▼				
KEY TONE	<input checked="" type="radio"/> ON <input type="radio"/> OFF					
REMOTE CONTROLLER ID	0	▼				
SENSOR	1	▼				
TYPE	OFF	▼				
IEEE 802.3af PoE STATUS						
PORT	STATUS	FAULT	VOLTAGE (V)	CURRENT (mA)	POWER (mW)	RESTART
1	SEARCHING	NO FAULT	0	0	0	RESTART
2	SEARCHING	NO FAULT	0	0	0	RESTART
3	SEARCHING	NO FAULT	0	0	0	RESTART
4	SEARCHING	NO FAULT	0	0	0	RESTART
5	SEARCHING	NO FAULT	0	0	0	RESTART
6	SEARCHING	NO FAULT	0	0	0	RESTART
7	SEARCHING	NO FAULT	0	0	0	RESTART
8	SEARCHING	NO FAULT	0	0	0	RESTART
9	SEARCHING	NO FAULT	0	0	0	RESTART
10	SEARCHING	NO FAULT	0	0	0	RESTART
11	SEARCHING	NO FAULT	0	0	0	RESTART
12	SEARCHING	NO FAULT	0	0	0	RESTART
13	SEARCHING	NO FAULT	0	0	0	RESTART
14	SEARCHING	NO FAULT	0	0	0	RESTART
15	SEARCHING	NO FAULT	0	0	0	RESTART
16	SEARCHING	NO FAULT	0	0	0	RESTART
TOTAL				0	0	RESTART ALL

RELOAD APPLY

- CONTROLLER:** Set the controller speed, type and ID.
- KEYTONE:** Sets On or Off of Key Tone.

- **REMOTE CONTROLLER ID:** Sets an ID number of which remote control to receive commands.
- **SENSOR:** Select the type of sensor.
- **IEEE 802.3af PSE Status:** Table showing the status of all PoE devices connected to the NSP.

7-7-5. Display

Select the **DISPLAY** tab to set the DISPLAY conditions.

Setting	Value
OSD	<input checked="" type="radio"/> ON <input type="radio"/> OFF
CHANNEL NAME	<input type="radio"/> ON <input checked="" type="radio"/> OFF
NO CONNECTION	<input type="radio"/> ON <input checked="" type="radio"/> OFF
STATUS BAR / ICON	<input type="radio"/> ON <input checked="" type="radio"/> OFF
RECORD MODE	<input type="radio"/> ON <input checked="" type="radio"/> OFF
IP ADDRESS / FPS	IP
OSD CONTRAST	100
MAIN MONITOR SEQUENCE	<input type="radio"/> ON <input checked="" type="radio"/> OFF
SEQUENCE-DWELL TIME	3 SECOND(S)
SITE	CH1
NAME	CH1
COVERT	OFF

RELOAD APPLY

These settings apply to all channels.

- **OSD:** Sets whether to display or not date and time as well as channel number on the screen.
- **OSD CONTRAST:** Adjust the character contrast on the screen.
- **MAIN MONITOR SEQUENCE:** Setting for automatically switching the displayed video.
- **SEQUENCE DWELL TIME:** Sets the interval for automatically switching the screens.
- **SITE:** Name, Covert (These settings apply to the specified channel only).

7-7-6. Network

NETWORK TYPE	DHCP
IP	172.16.2.32
SUBNET MASK	255.255.0.0
GATEWAY	172.16.1.254
DNS (PRIMARY)	168.126.63.1
DNS (SECONDARY)	168.126.63.2
DDNS	
ENABLE DDNS	OFF
HOST NAME	hostname
SUBMIT/UPDATE	OFF
ezDDNS	OFF
NETWORK PORT	5445
NETWORK AUDIO PORT	5446
WEB PORT	80
WIRELESS LAN	OFF
IP ADDRESS	192.168.50.1
SSID	MY_SSID
KEY (8~15 CHARACTERS)	12345678

RELOAD APPLY

- **NETWORK TYPE (Cannot be altered remotely)**
 - **STATIC:** The address setting mode is manual. Input IP, Gateway, Subnet Mask, and DNS IP.

- **DHCP:** The address setting mode is automatic.
- **DDNS:** Set whether to use DDNS service or not
 - **HOST NAME:** Allows the user to setup a domain name manually
 - **SUMBIT/UPDATE:** Select ON to submit the settings
 - **ezDDNS:** Enable ezDDNS to register the host name automatically
- **NETWORK PORT:** When connecting multiple NSs to the network, set a unique port number.
- **NETWORK AUDIO PORT:** Display the network audio port (NETWORK PORT + 1).
- **WEB PORT:** Set a web server port number.
- **WIRELESS LAN :** Wireless networks can be configured(option)
 - **IP ADDRESS:** Wireless IP Address
 - **SSID(Service set identifier):** Wireless Network ID
 - **KEY(8~15 Characters):** Wireless Network Password

7-7-7. User Management

Select the **USER MANAGEMENT** tab to set the DISPLAY conditions.

AUTHORITY SETUP

	PASSWORD	SETUP	PB	PTZ	REC OFF	NETWORK
PASSWORD CHECK		<input type="checkbox"/>	<input type="checkbox"/>	<input type="checkbox"/>	<input type="checkbox"/>	<input type="checkbox"/>
ADMIN	****	<input checked="" type="checkbox"/>	<input checked="" type="checkbox"/>	<input checked="" type="checkbox"/>	<input checked="" type="checkbox"/>	<input checked="" type="checkbox"/>
USER1	****	<input checked="" type="checkbox"/>	<input checked="" type="checkbox"/>	<input checked="" type="checkbox"/>	<input checked="" type="checkbox"/>	<input checked="" type="checkbox"/>
USER2	****	<input checked="" type="checkbox"/>	<input checked="" type="checkbox"/>	<input checked="" type="checkbox"/>	<input checked="" type="checkbox"/>	<input checked="" type="checkbox"/>
USER3	****	<input checked="" type="checkbox"/>	<input checked="" type="checkbox"/>	<input checked="" type="checkbox"/>	<input checked="" type="checkbox"/>	<input checked="" type="checkbox"/>

USER NAME SETUP
 NEW USER NAME: USER1
PASSWORD SETUP
 CHANGE: ADMIN
 NEW PASSWORD: KEEP
 CONFIRM PASSWORD: [Empty field]
PLAYBACK AUTHORITY

	1	2	3	4	5	6	7	8	9	10	11	12	13	14	15	16
ADMIN	<input checked="" type="checkbox"/>	<input checked="" type="checkbox"/>	<input checked="" type="checkbox"/>	<input checked="" type="checkbox"/>	<input checked="" type="checkbox"/>	<input checked="" type="checkbox"/>	<input checked="" type="checkbox"/>	<input checked="" type="checkbox"/>	<input checked="" type="checkbox"/>	<input checked="" type="checkbox"/>	<input checked="" type="checkbox"/>	<input checked="" type="checkbox"/>	<input checked="" type="checkbox"/>	<input checked="" type="checkbox"/>	<input checked="" type="checkbox"/>	<input checked="" type="checkbox"/>
USER1	<input checked="" type="checkbox"/>	<input checked="" type="checkbox"/>	<input checked="" type="checkbox"/>	<input checked="" type="checkbox"/>	<input checked="" type="checkbox"/>	<input checked="" type="checkbox"/>	<input checked="" type="checkbox"/>	<input checked="" type="checkbox"/>	<input checked="" type="checkbox"/>	<input checked="" type="checkbox"/>	<input checked="" type="checkbox"/>	<input checked="" type="checkbox"/>	<input checked="" type="checkbox"/>	<input checked="" type="checkbox"/>	<input checked="" type="checkbox"/>	<input checked="" type="checkbox"/>
USER2	<input checked="" type="checkbox"/>	<input checked="" type="checkbox"/>	<input checked="" type="checkbox"/>	<input checked="" type="checkbox"/>	<input checked="" type="checkbox"/>	<input checked="" type="checkbox"/>	<input checked="" type="checkbox"/>	<input checked="" type="checkbox"/>	<input checked="" type="checkbox"/>	<input checked="" type="checkbox"/>	<input checked="" type="checkbox"/>	<input checked="" type="checkbox"/>	<input checked="" type="checkbox"/>	<input checked="" type="checkbox"/>	<input checked="" type="checkbox"/>	<input checked="" type="checkbox"/>
USER3	<input checked="" type="checkbox"/>	<input checked="" type="checkbox"/>	<input checked="" type="checkbox"/>	<input checked="" type="checkbox"/>	<input checked="" type="checkbox"/>	<input checked="" type="checkbox"/>	<input checked="" type="checkbox"/>	<input checked="" type="checkbox"/>	<input checked="" type="checkbox"/>	<input checked="" type="checkbox"/>	<input checked="" type="checkbox"/>	<input checked="" type="checkbox"/>	<input checked="" type="checkbox"/>	<input checked="" type="checkbox"/>	<input checked="" type="checkbox"/>	<input checked="" type="checkbox"/>

REMOTE PLAYBACK TIMEOUT: DISABLE

RELOAD APPLY

- **AUTHORITY SETUP:** Select which users have access to each function, password check can be implemented for each function accessed.
- **USER NAME SETUP:** Select which Username to change
 - **NEW USER NAME:** Input the new username
- **PASSWORD SETUP:** Select Username to change Password
 - **CHANGE:** Select whether to KEEP or CHANGE the current password.
 - **NEW PASSWORD:** Input NEW Password if CHANGE was selected.
 - **CONFIRM PASSWORD:** Input NEW Password again to confirm.
- **PLAYBACK AUTHORITY:** User can select which users have access to which channels.

7-7-8. Storage

Select **Storage** to configure recording settings such as overwriting the hard disk and the setting a storage period for the recording data.

The screenshot shows the 'STORAGE' tab selected in the navigation menu. The page displays the following settings:

OVERWRITE	<input type="radio"/> ON <input checked="" type="radio"/> OFF
DISK INFO	
HDD SIZE :	435 GB (FREE : 434 GB)
HDD LAST TIME :	01/01/1970 01:00:00
HDD 1	
MODEL NAME	Hitachi HDS721050CLA382
TEMPERATURE	22 Celsius (71 Fahrenheit)
HEALTH (GOOD/NORMAL/BAD)	GOOD
REALLOCATED SECTORS	0
CURRENT PENDING SECTORS	0
UNCORRECTABLE SECTORS	0
SPIN RETRY SECTORS	0
RECORDING LIMIT	OFF
RECORDING LIMIT DAYS	30 DAY(S)

Buttons: RELOAD, APPLY

- **OVERWRITE:** Select on to continue recording by overwriting when the hard disk becomes full.
- **RECORD LIMIT:** Sets whether to limit or not the recording data storage period.

7-7-9. Remote Upgrade

SPECO WEB SETUP (ver 1.8.8)

The screenshot shows the 'UPGRADE' tab selected in the navigation menu. The page displays the following information:

Model Name : N8NS
Current Software : Ver 3.7.4_20130524

Browse...

UPGRADE

Shows the current Firmware version installed on NS.

- **Browse:** Select BROWSE to locate the firmware file.
- **Upgrade:** Select UPGRADE to upgrade the firmware of the NS.

7-7-10. Information

The screenshot shows the 'INFORMATION' tab selected in the navigation menu. The page displays the following information:

MODEL NAME	N18NSF
SOFTWARE VERSION	Ver 4.3.2_20141027
STORAGE SIZE	435 GB
NETWORK TYPE	DHCP
IP ADDRESS	172.16.2.32
MAC ADDRESS	00:02:89:09:17:27
NVR ID	NVR
REMOTE CONTROLLER ID	0

Buttons: RELOAD, APPLY

Displays general information about the NS.

7-8. Operation

7-8-1. Addition, Delete, and Modify of NS Sites

7-8-1-1. Addition of Sites

1. Click  SITE ADDITION button. And then the following window will be displayed as below.

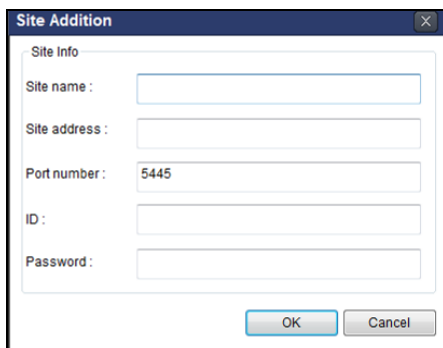

The 'Site Addition' dialog box contains the following fields and controls:

- Site Info section
- Site name: [text input field]
- Site address: [text input field]
- Port number: [text input field with value 5445]
- ID: [text input field]
- Password: [text input field]
- OK button
- Cancel button

- **Site Name:** Input a name that properly describes a site.
 - **IP Address:** Input IP address (Public IP address of a router that NS is connected.) or Domain name
 - **Port Number: Default Port Number is “5445”.**
 - **ID:** Input ID of NS. **Default ID is “admin”.**
 - **Password:** Input network password of NS. **Default Password is “1111”.**
2. Click OK button. And then the registered site is added on the directory window.

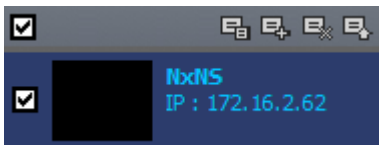

7-8-1-2. Deleting a Site

1. Select the site/sites to delete from the directory window.

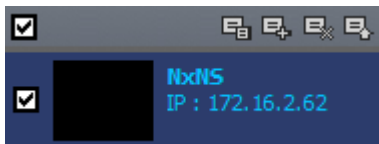

2. Click  SITE DELETE button. And then the selected site/sites is/are deleted.

7-8-1-3. Modify of Sites

1. Select the site/sites to modify from the directory window.

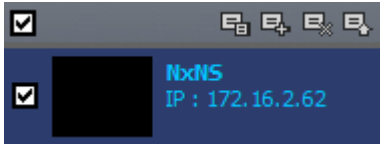

2. Click  NET FINDER button. And then the following window will be displayed as below.

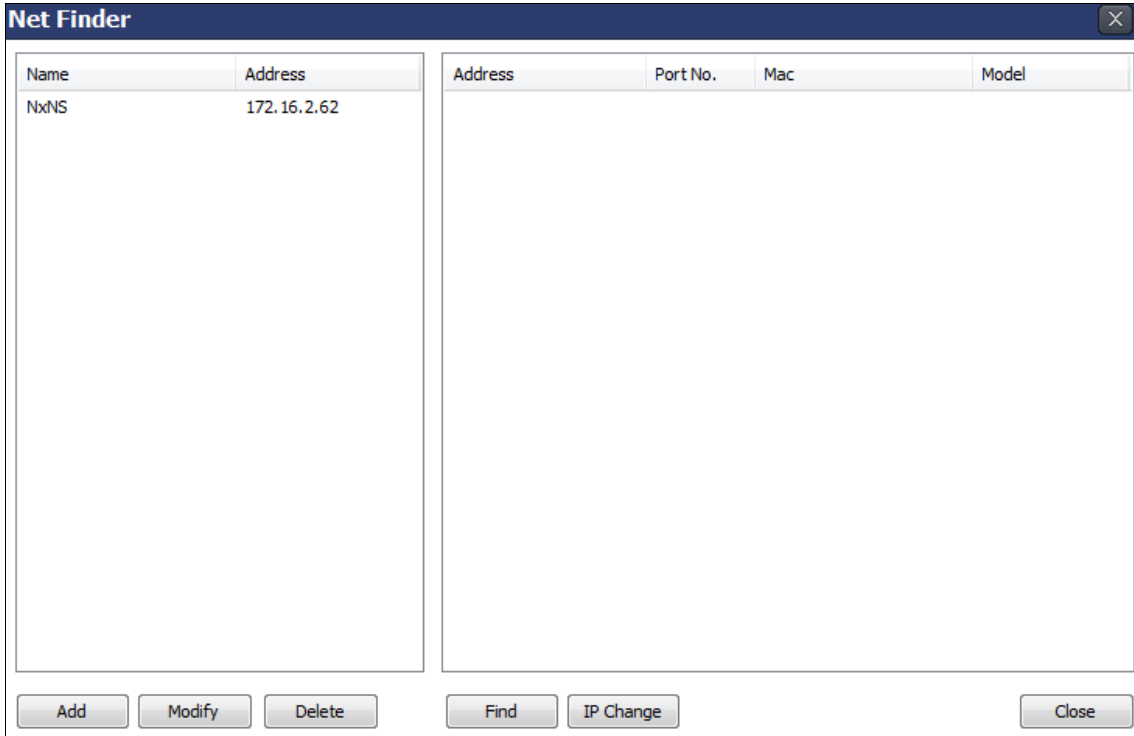

3. Click MODIFY button. And then the modified information is displayed as below.

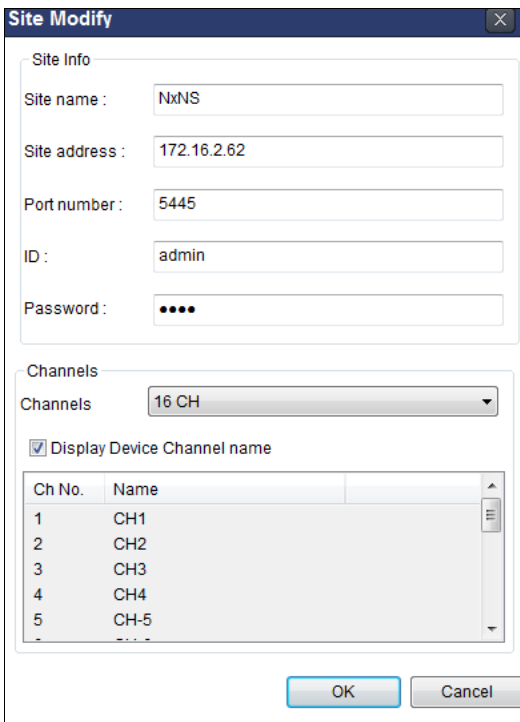

7-8-2. Connect and Disconnect

7-8-2-1. Connect

1. Select site/sites to connect from the directory window.

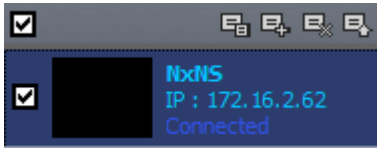

2. Click  CONNECT button, and then site/sites displays/display as connected.

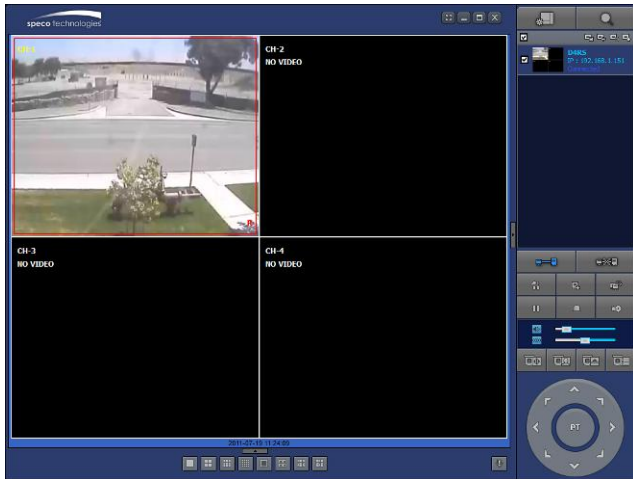

7-8-2-2. Disconnect

1. Select site/sites to disconnect from the directory window.

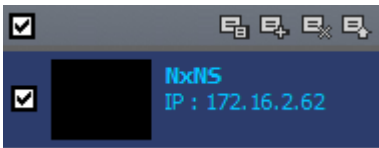

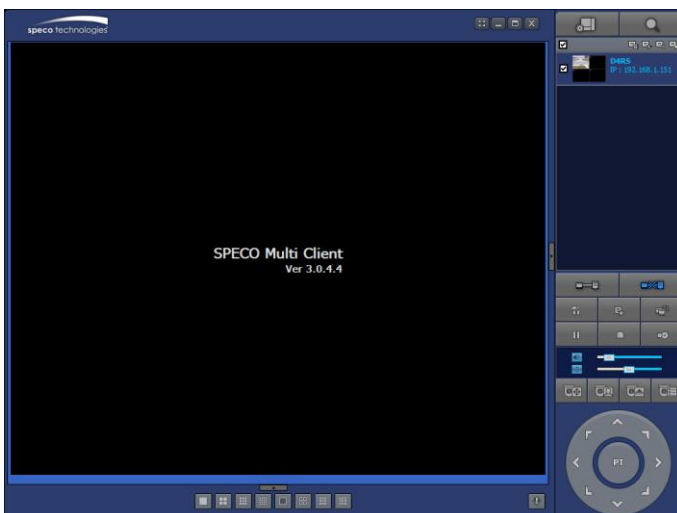

2. Click  DISCONNECT button, and then selected site/sites disconnected.

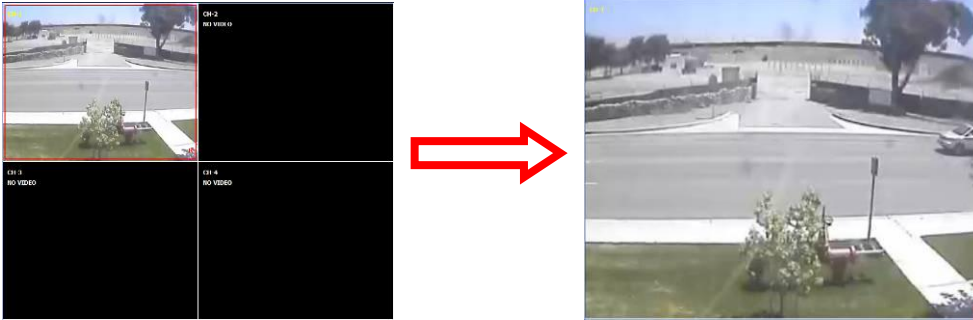

7-8-3. Still-image Capture During Live

1. Double-click a channel to capture from the display screen. (Otherwise all channels will be captured.)



2. Click  CAPTURE button. And then a Capture window will be displayed as below.

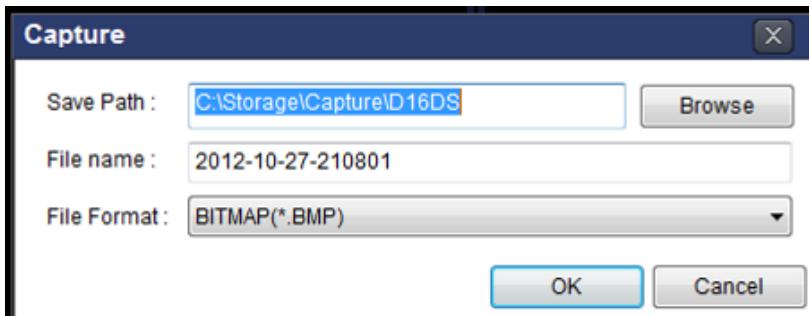

3. Set Save Path, File Name, and File Format. And then click OK button.

4. Still image is saved as set in Capture window.

7-8-4. Recording Video on Local PC During Live

1. Click  SETUP button. And then a setup window will be displayed as below.

2. Select Record and set the values.

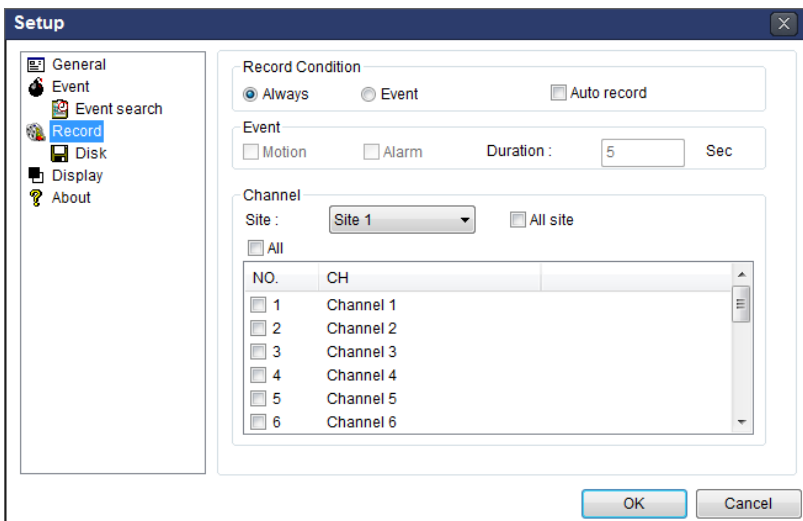

3. Select Disk and set the values.

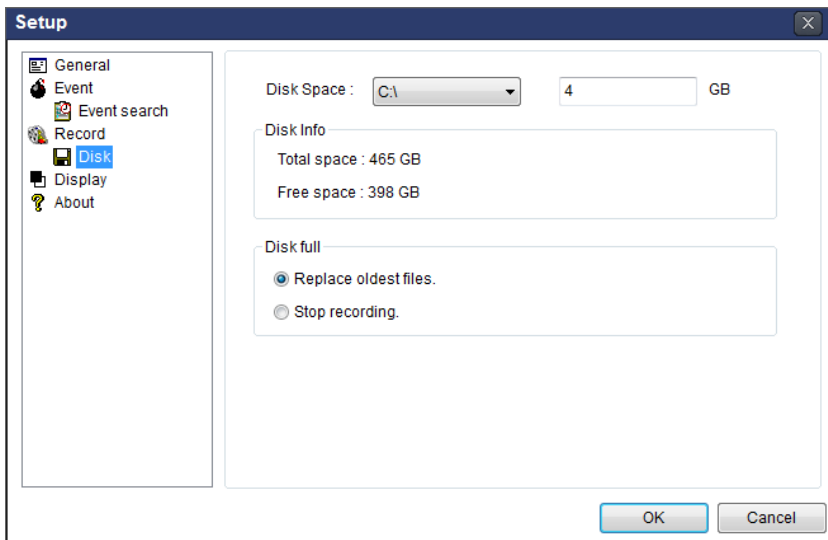

4. Click  RECORD ON button. And the color of button is changed.

5. Live video data is recorded as set in Record and Disk setup. These video data can be searched and play-backed with Local Playback.

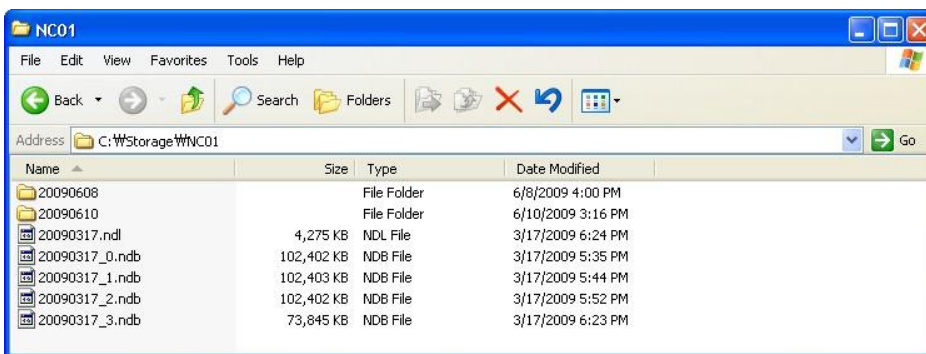

7-8-5. Local Playback and Remote Playback

7-8-5-1. Playback of Recorded Video on a Local PC

1. Click  LOCAL PLAYBACK. And then Playback Window will be displayed over the Live Window.

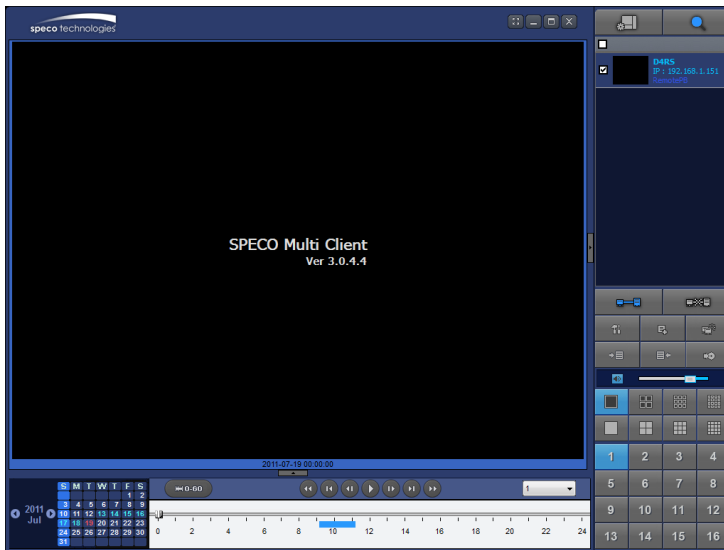

2. Select site/sites to connect from the directory window.

3. Click  CONNECT button. And then Green bar displays on Search calendar and timeline scale window.

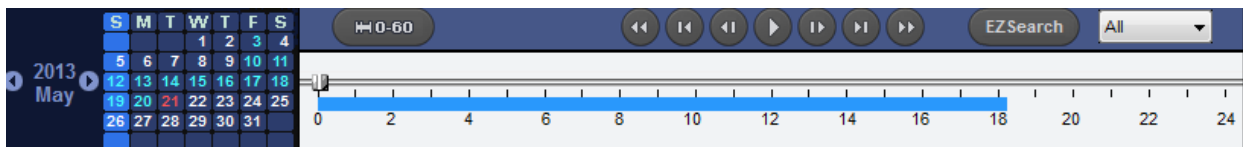

6. Move the marker on the timeline scale to where there is video data and press the PLAY button.



7. Video data that is recorded on local PC will be play-backed.

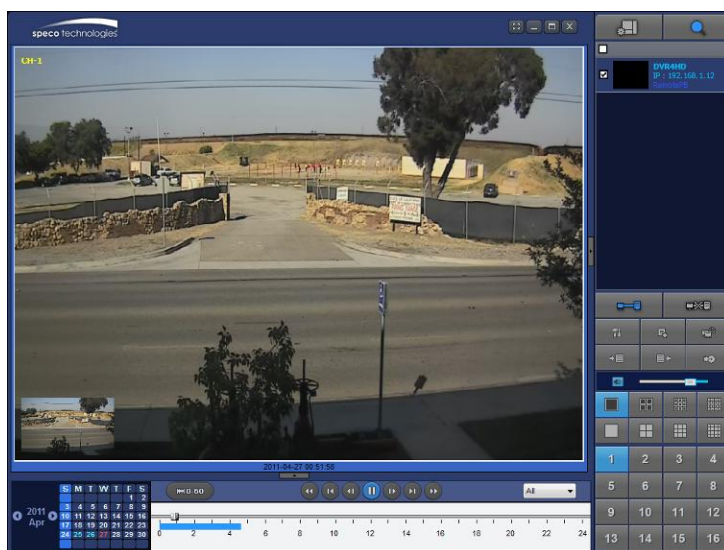

8. Use the mouse scroll to digitally zoom in and out from a single channel display.

7-8-5-2. Playback of Recorded Video on Remote NS

1. Click  REMOTE PLAYBACK. And then Playback Window will be displayed over the Live Window.

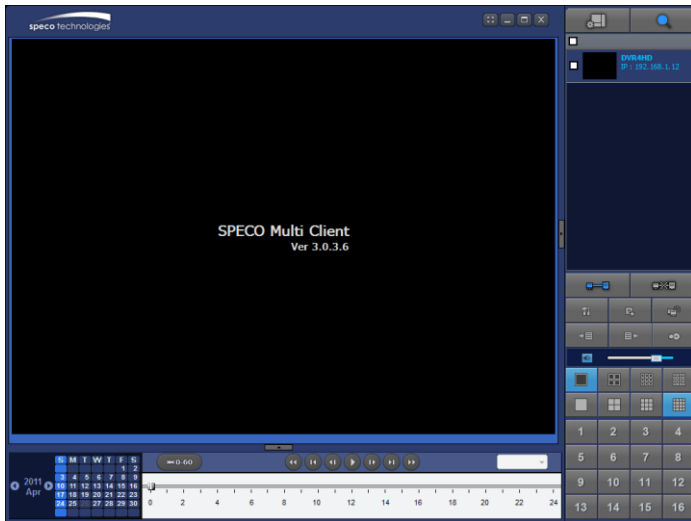

2. Select the site to connect from the directory window.

3. Click  CONNECT. And then Green bar displays on Search calendar and timeline scale window.

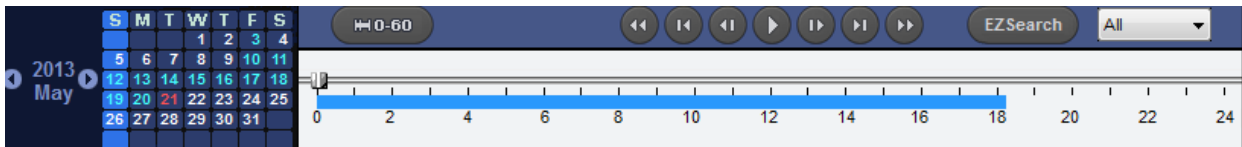

4. Move the marker on the timeline scale to where there is video data and press the PLAY button.

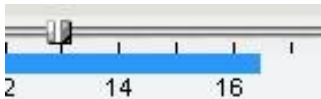

5. Video data that is recorded on the remote NS is play-backed.

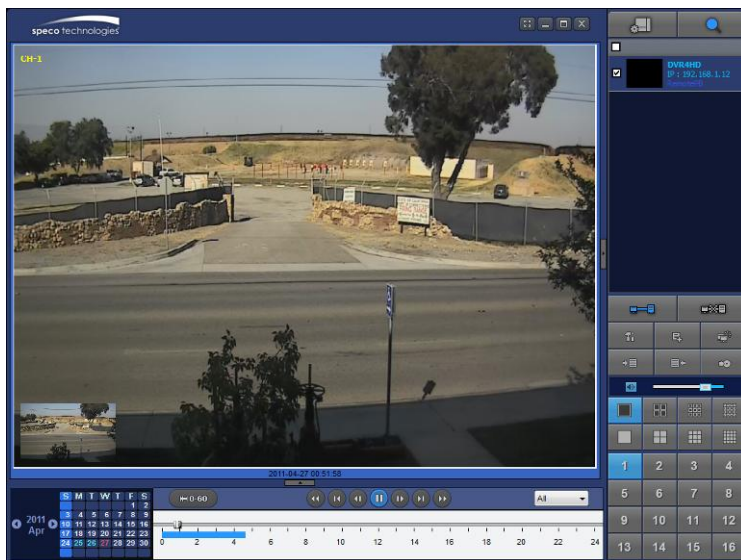

7-8-6. AVI Backup during Playback

You can back up the recorded videos in AVI format during playback.

1. Double-click the target channel to backup.
2. Select the beginning time by using the search calendar and timeline scale bar.

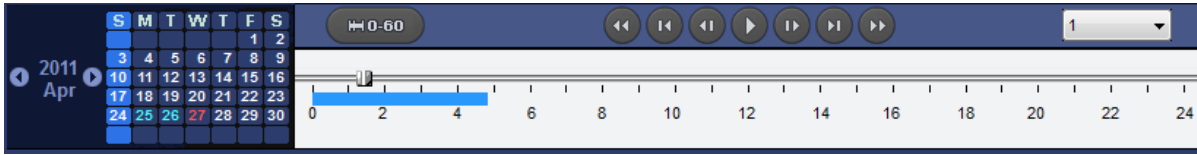

3. Click  EZCOPY START button on the timeline scale to select the beginning point of the backup.

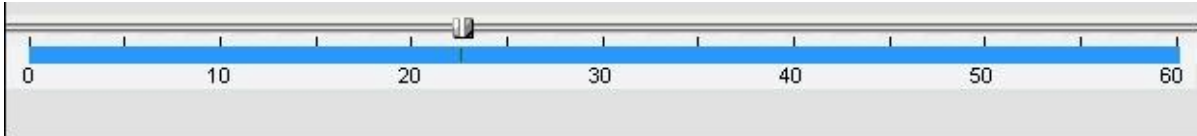

4. Click  EZCOPY END button on the timeline scale to select the ending point of the backup. Then, the selected starting point and the ending point on the timeline scale bar will be marked in green.

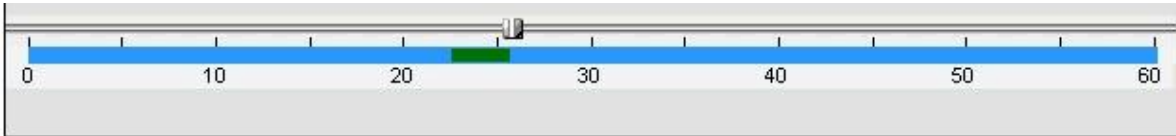

5. Click  BACKUP. And then the BACKUP window will be displayed as below.

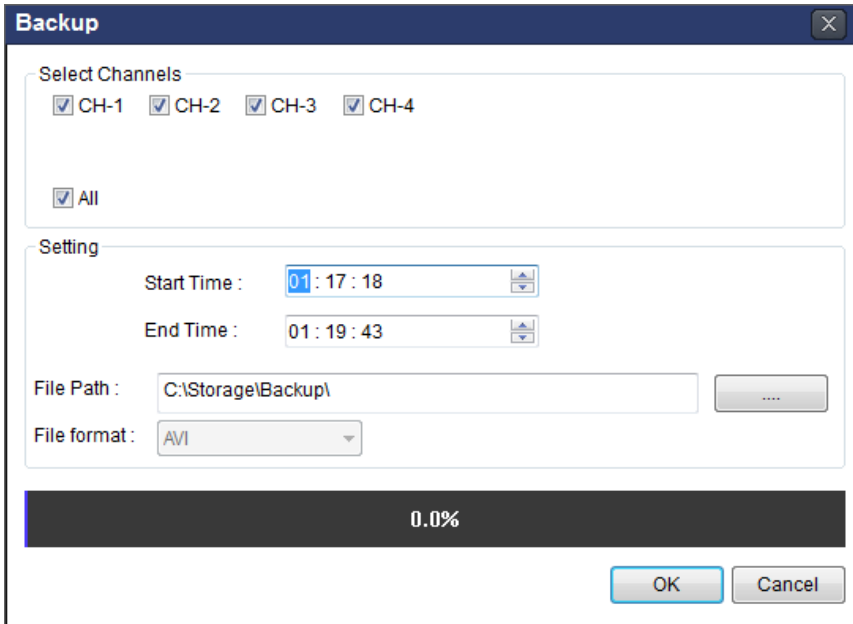

6. You can also set the beginning time and ending time on this window. After selecting a channel for backup, click the OK button. The backup will begin.

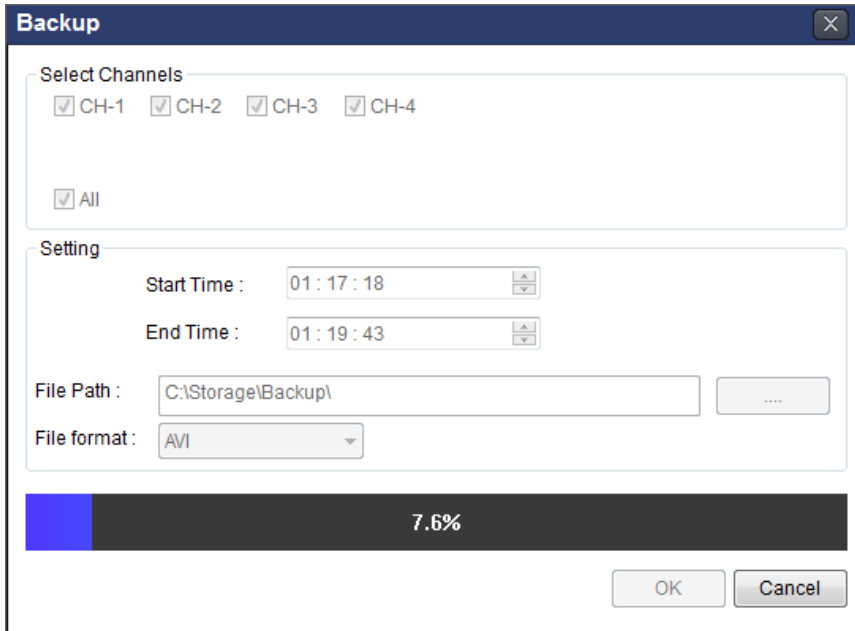

7. AVI video data is recorded as set in AVI Backup window. AVI format video can be played back by using Window Media Player™ or other media player that is compatible with AVI format video.

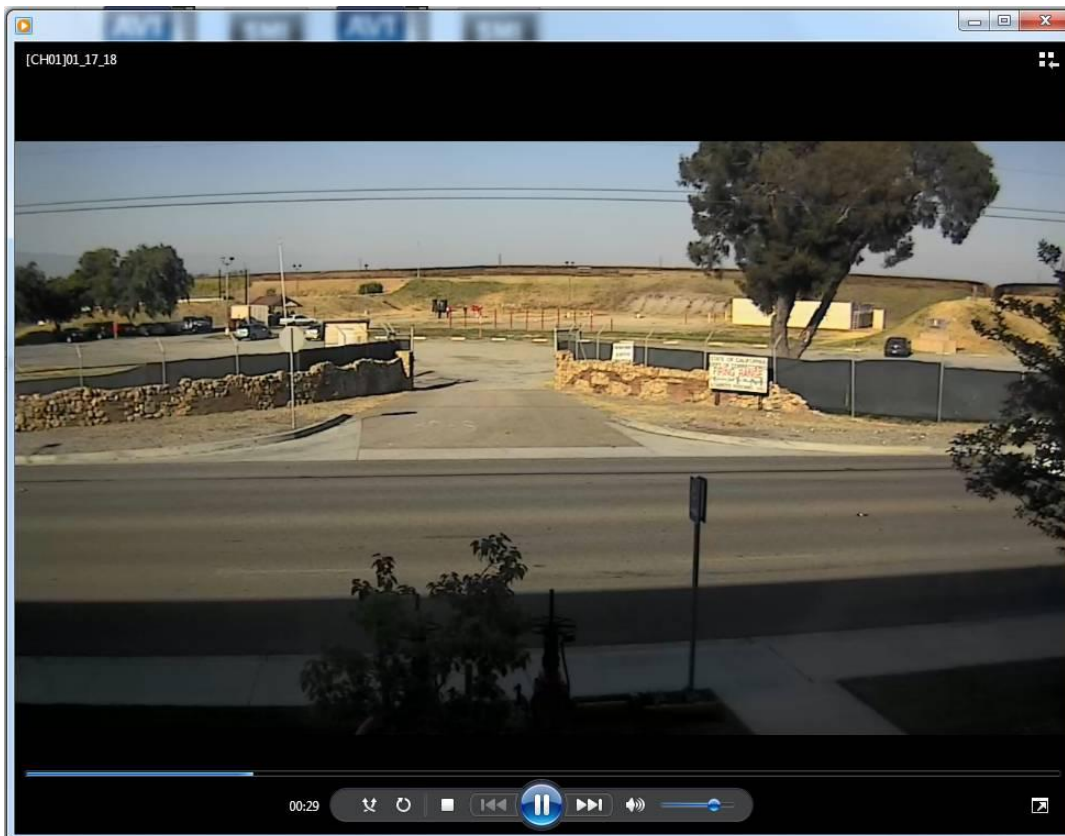

8. Network Access Using the Web-Browser Viewer

The NS provides a live remote monitoring feature by web-browser viewer. (NOTE: Web-Browser is only available for Internet Explorer)

1. Check the IP address of the NS from SETUP>SYSTEM>DESCRIPTION>IP ADDRESS or
2. Input the IP address or Domain name address that you pre-registered.



3. Click this bar. Then the dialog box is displayed.



4. Click "Install" to download and install the ActiveX control.

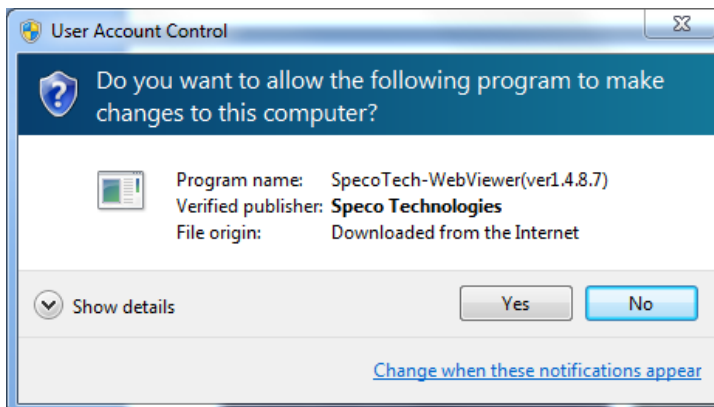

5. The Web Browser Viewer will be displayed as below after the ActiveX installation

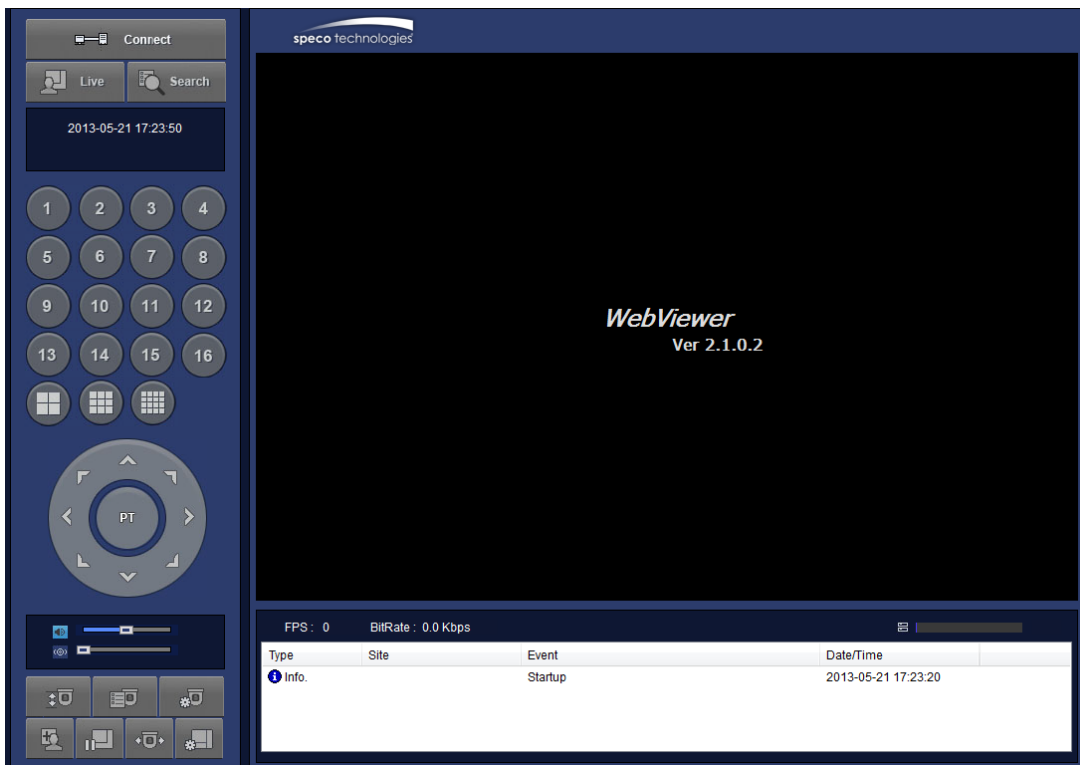

6. Click the CONNECT button on the Left upper corner of web-viewer. Then "Connect" dialog is displayed.

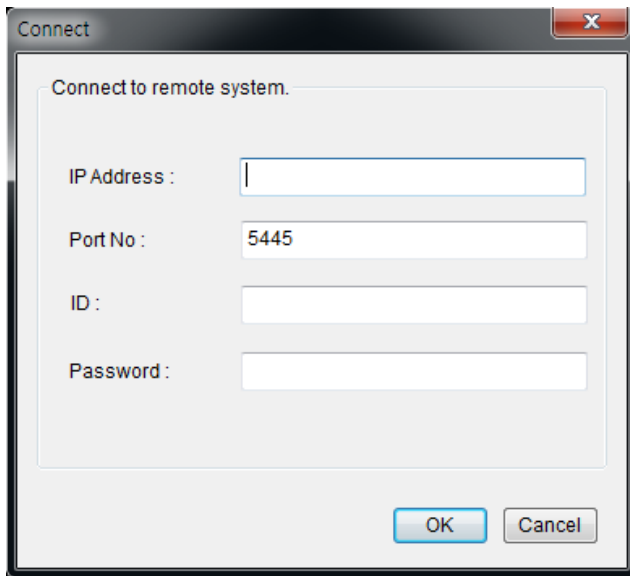

- **Site Name:** Input a name that properly describes a site.
 - **IP Address:** Input IP address (Public IP address of a router that NS is connected.) or Domain name
 - **Port Number: Default Port Number is “5445”.**
 - **ID:** Input ID of NS. **Default ID is “admin”.**
 - **Password:** Input network password of NS. **Default Password is “1111”.**
7. Then the cameras connected to the NS are displayed on the screen.
 8. Use mouse scroll to digitally zoom in and out from a single channel display.

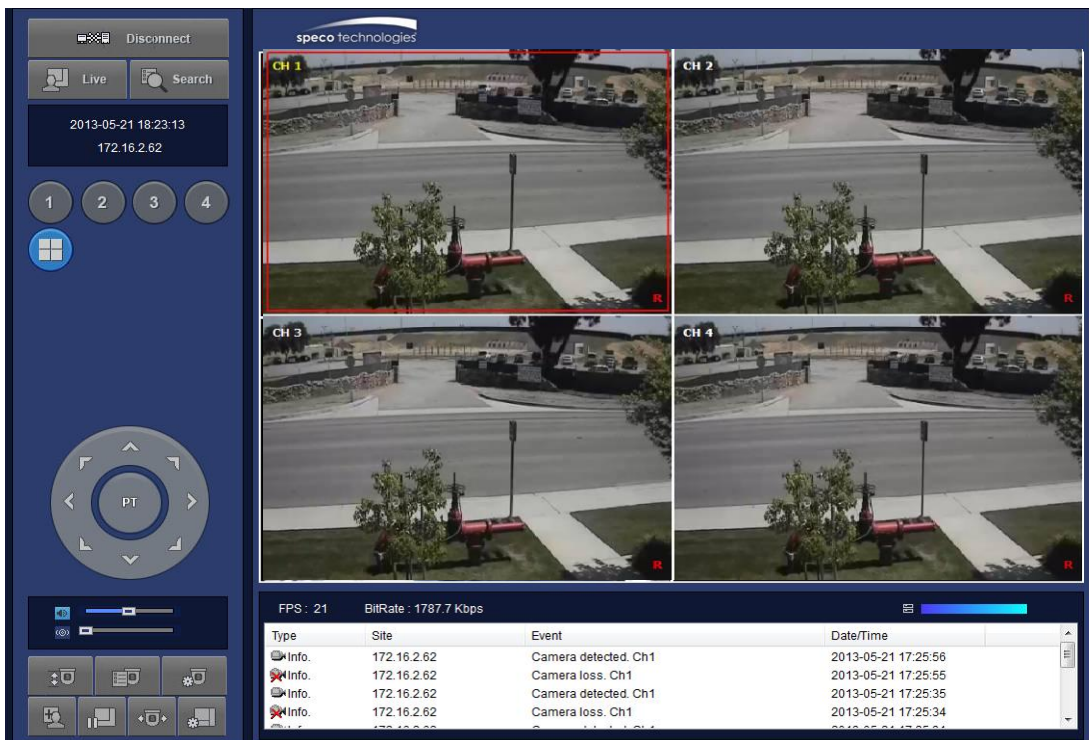

9. Network Access Using the Smart Phone Viewer



Notice

Data Usage applied without Wi-Fi connection. Please check with your Phone Carrier.

9-1. App Viewer for iPhone

1. Enter the Apple iTunes Store.



2. Search "Speco Player" in the App Store.



Notice

SPECO Player is for the NS, NSL, VS, HS, DS, RS and HD series DVRs. SPECO VIEWER is not compatible with the T Series DVR's (TH, TN or TL) or the PC Series

9-1-1. Live

1. Open the installed "Speco Player" App and click  button to add a remote device.
2. Enter the site name, IP or DDNS address, Network Port number (default 5445), ID(default admin) and Password (default 1111). Then, click "Save" button.

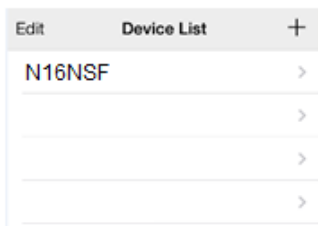

* Note: Network Port and Web Port must be forwarded before adding a new site.

3. Select a registered device and select LIVE. Then click "CONNECT" button.



- The app will display the selected channel(s). Double tap the channel screen to switch 1 channel display to 4, 8, 10, 16 channels split display depending on the DVR.

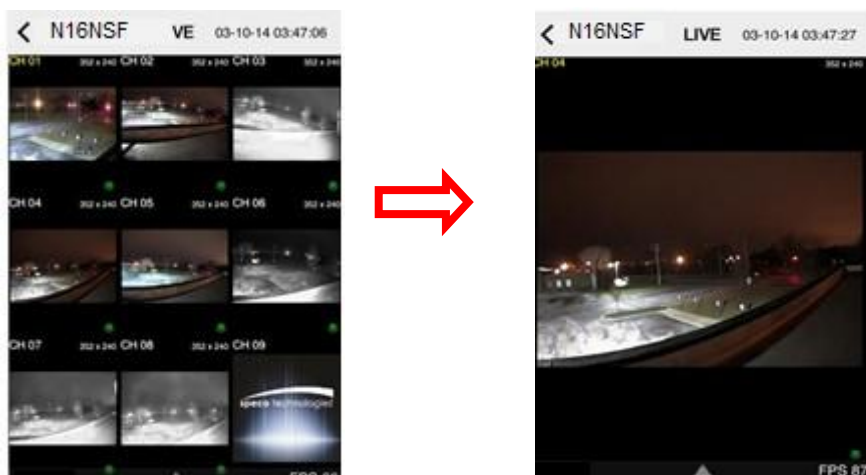

- To select the display mode(1, 4, 9, 10 or 16 split display), tap the arrow menu button



- Drag and drop channels
Touch and drag one channel to the other channel to swap the channel location. To swap the channel, drag a channel to another channel.
- Digital Zoom In-Out
Double tap on the desired channel to view in 1channel mode. Then use the iPhone zoom feature using two fingers to pinch the screen to zoom in or out on the video image. User can also move the zoomed image around by touching the desired spot and dragging the zoom image.

9-1-2.PTZ Control

To control the PTZ functions of the camera, tap the menu button. Then PTZ menu icons will display. Using the PTZ icon on the screen, control PTZF control.



9-1-3. Playback

1. Select Mode as 'Playback'  and click 'CONNECT' button. Then select Date & Time and click PLAY button.

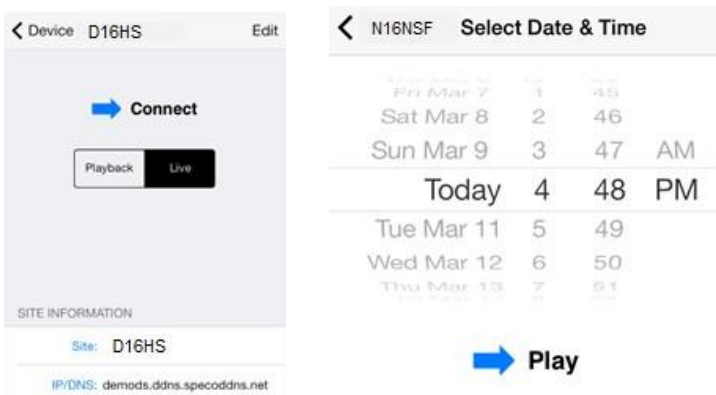

2. The app will display the selected channel(s). Double tap the channel screen to switch 1 channel display to 4, 8, 10, 16 channels split display depending on the DVR.

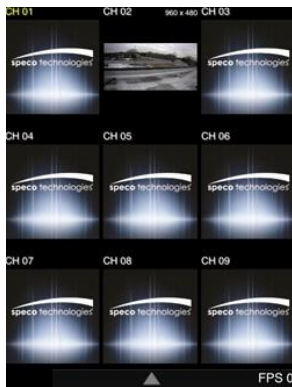

3. Tap the menu button. Then Playback menu icons will display.



9-2. App Viewer for Android Phone

1. Enter the Android Market.

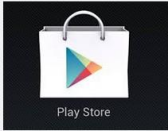

2. Search “Speco Player” in the Android Market and install the “Speco Player” app.



Notice

SPECO Player is for the NS, NSL, DS, RS, WRS and HD series. SPECO VIEWER is not compatible with the T Series NS’s (TH, TN or TL) or the PC Series.

9-2-1. Live

1. Open the installed “Speco Player” App and select the Live Preview. Then click the menu button of the phone to add a remote device.
2. Select the registered device and select LIVE VIEW and select up to 4 channels or ALL CHANNELS to monitor. Then click START button.

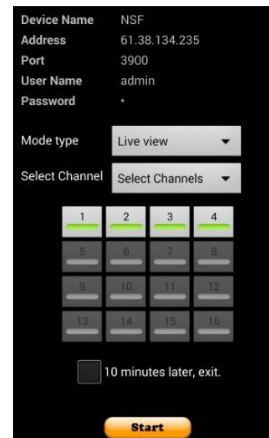
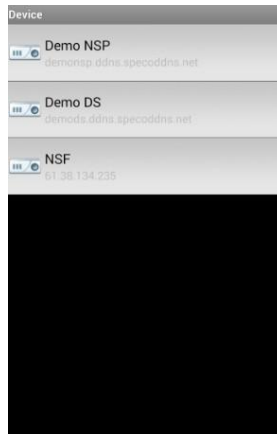
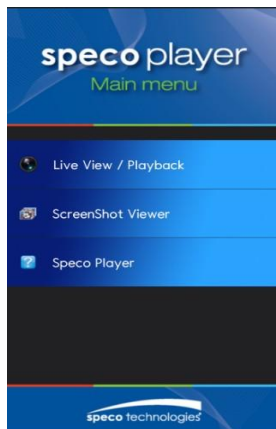

3. The app will display the selected channel(s). Double tap the channel screen to switch 1 channel display to 4 channels split display.



9-2-2. Playback

1. Select the registered device and select PLAYBACK and select up to 4 channels or ALL CHANNELS to search. Then click START button. As soon as setting the date and time to search, the app will start the playback.

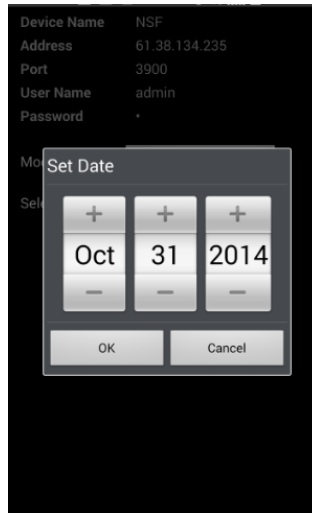
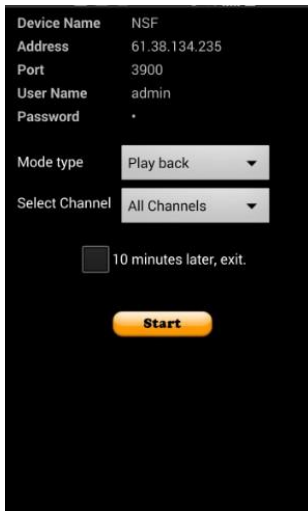

2. The app will display the selected channel(s). Double tap the channel screen to switch 1 channel display to 4 channels split display.



9-2-3.PTZ Control

To control the PTZ function of the camera, tap the channel screen, then the channel name will be highlighted in Yellow. Using the PTZ menu icons on the screen, control PTZF.

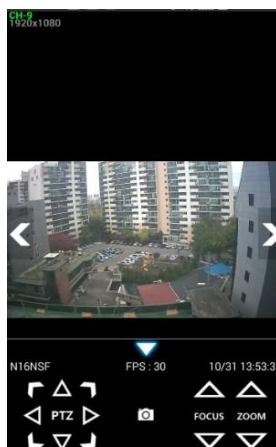

APPENDIX: Network Connection - LAN

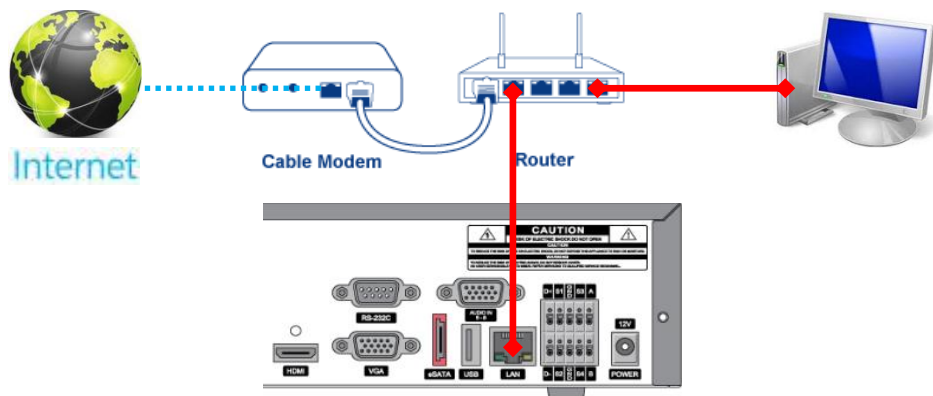

1. Install the network client software from the supplied CD.
2. Check the IP address from SETUP > SYSTEM > DESCRIPTION or SETUP > NETWORK of NS.



3. Run the network client software.

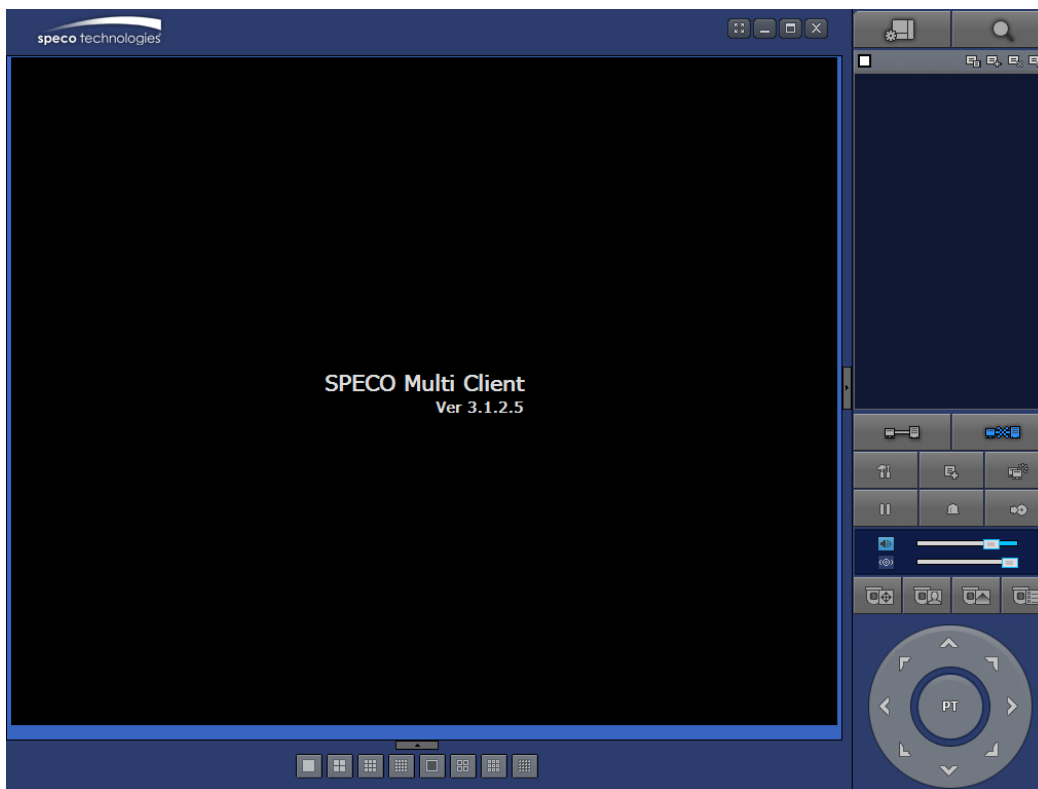

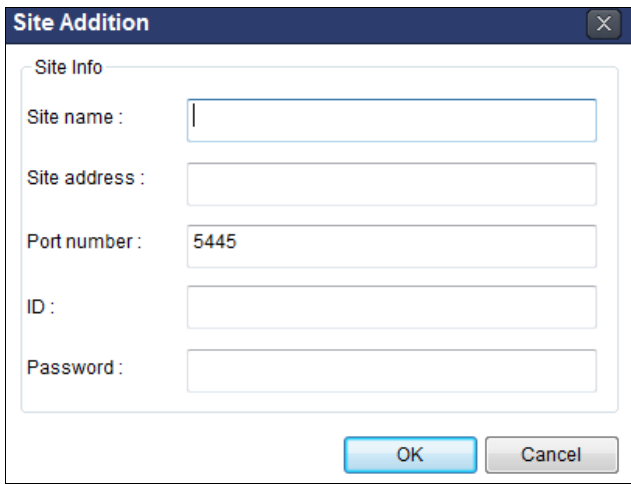

Site Addition

Site Info

Site name :

Site address :

Port number :

ID :

Password :

OK Cancel

4. Input Site Name, Site Address (IP address), Port Number, and Password on the connect window.

- **Site Name:** Input a name that properly describes a site.
- **IP Address:** Input IP address
- **Port Number: Default Port Number is “5445”.**
- **ID:** Input ID of NS. **Default ID is “admin”.**
- **Password:** Input network password of NS. **Default Password is “1111”.**

5. Select a site by checking the box, and Press  button to connect to the site.

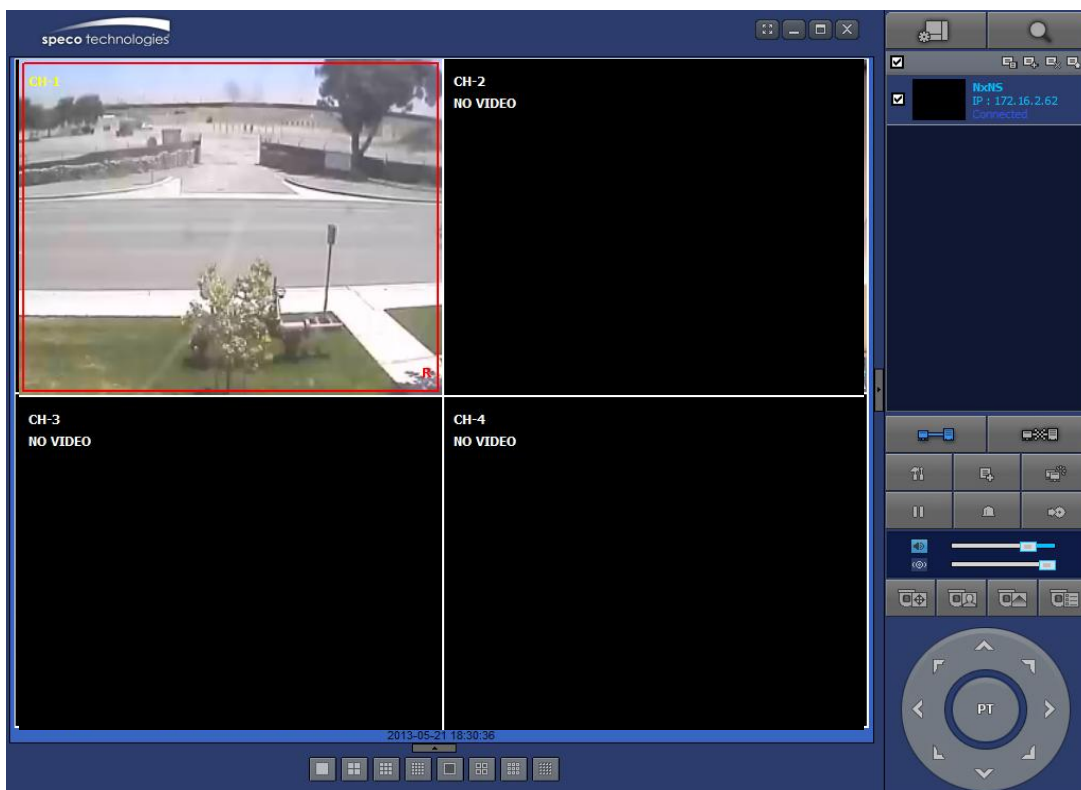

APPENDIX: Network Connection – Internet and DDNS

Dynamic Domain Name System (DDNS) allows a domain name to be constantly synchronized with a dynamic IP address. A current dynamic IP address is being associated with a static domain name.

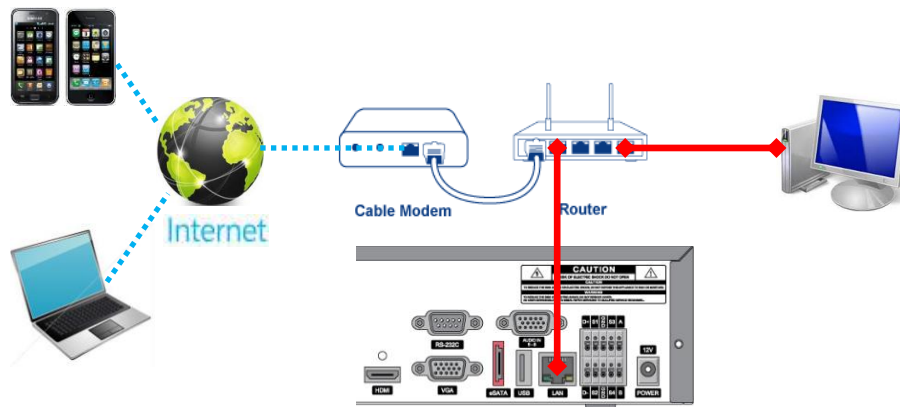

1. Go to SETUP>NETWORK>DDNS and set the DDNS SERVER to ON.

ENABLE DDNS	ON
HOST NAME	hostname
SUBMIT/UPDATE	OFF
ezDDNS	OFF
APPLY CLOSE	

If you set **ezDDNS** to ON, the host name is automatically generated and registered.

2. Go to SETUP>NETWORK>DDNS>HOST NAME. Manually enter a domain name using the virtual keyboard and click ENTER button.

HOST NAME	hostname														
~	1	2	3	4	5	6	7	8	9	0	=	←			
	q	w	e	r	t	y	u	i	o	p	[]			
CAPS	a	s	d	f	g	h	j	k	l	;	'	ENTER			
SHIFT	z	x	c	v	b	n	m	,	.	/	SHIFT				
CLEAR	SPACE										CLOSE				

3. When a manual host name is completed, Go to SETUP>NETWORK>DDNS>SUBMIT/UPDATE and select ON to submit the settings on the SPECODD DNS.

Once the setting is completed, the DDNS address will be:

<http://hostname.ddns.specoddns.net>

For example, if you enter the host name as "NS", then the address will be:

<http://NS.ddns.specoddns.net>

- When DDNS setting is done, click the APPLY button. Otherwise DDNS setting will not be applied.
- When you exit SETUP menu, DDNS NOTIFY window will pop up.

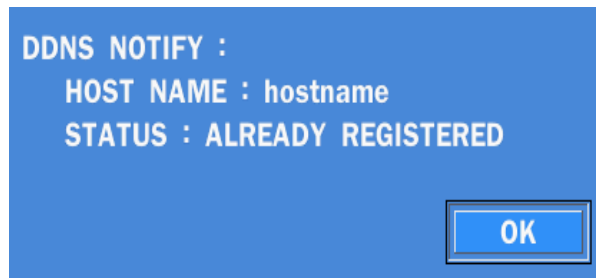
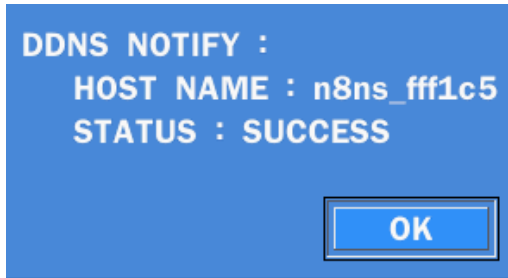

- DDNS registration status can be checked from SYSTEM INFORMATION or SETUP>SYSTEM>DESCRIPTION>DDNS STATUS
- Check the NETWORK PORT (Default: 5445), WEB PORT (Default: 80), and the IP Address of the NS from SETUP>NETWORK.

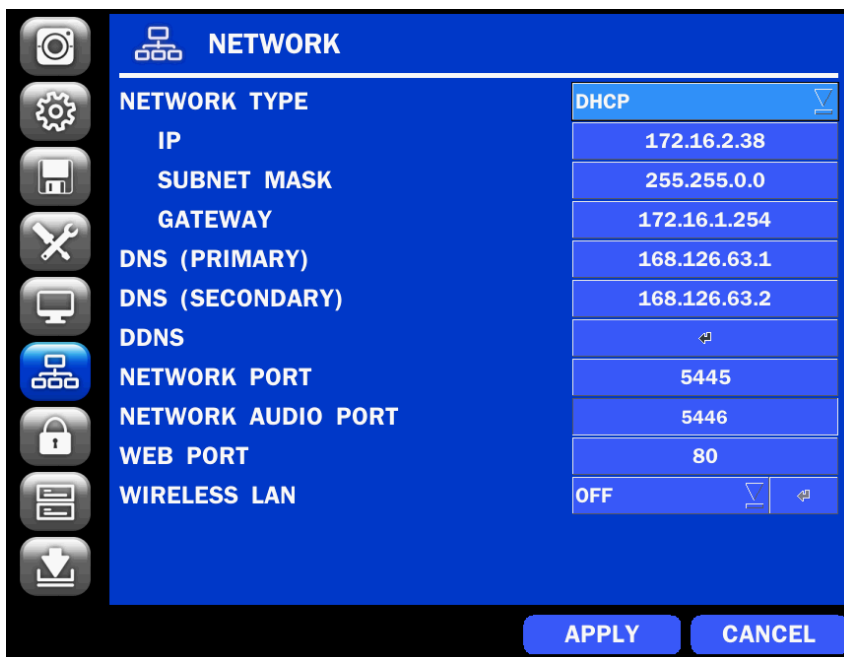

- Port forward the NETWORK PORT (Default: 5445) and WEB PORT (Default: 80) of the private IP Address of the NS on the network router.



Please refer to the user manual and guide for the detailed steps for port forwarding for specific router model.

- Run the network client software.

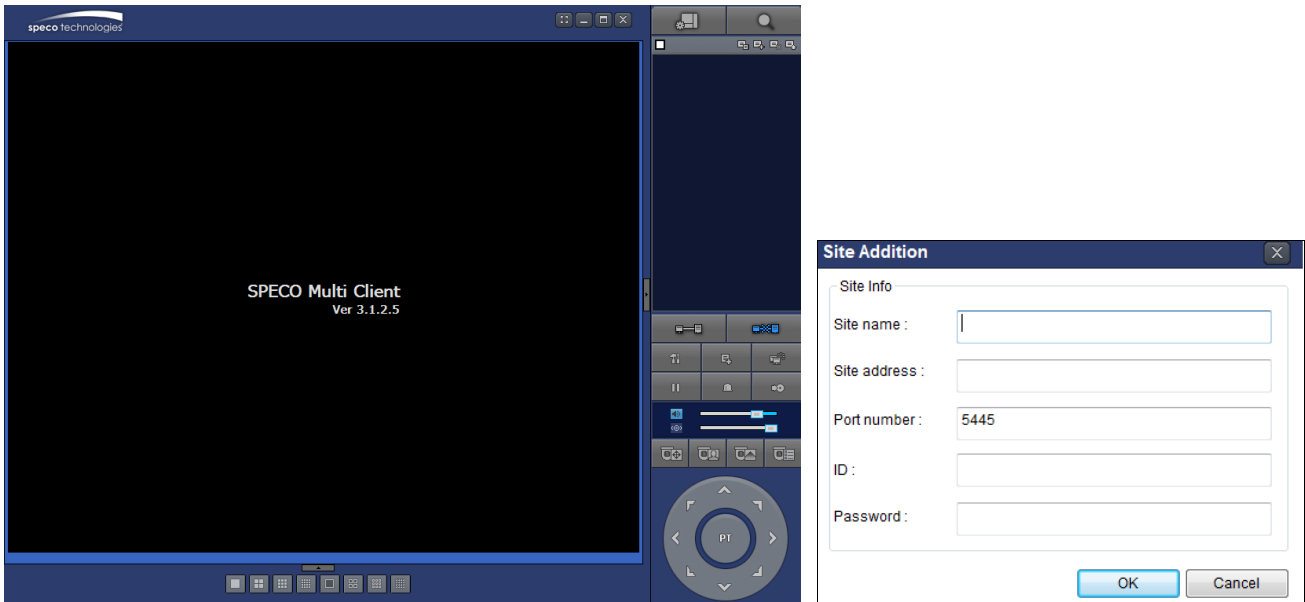

10. Input Site Name, Site Address (IP address), Port No., and Password on the connect window.

- **Site Name:** Input a name that properly describes a site.
- **IP Address:** Domain name or Public IP address of a router that NS is connected.
- **Port Number: Default Port Number is “5445”.**
- **ID:** Input ID of NS. **Default ID is “admin”.**
- **Password:** Input network password of NS. **Default Password is “1111”.**

11. And select the OK button. Then, press  button after checking the left check box.

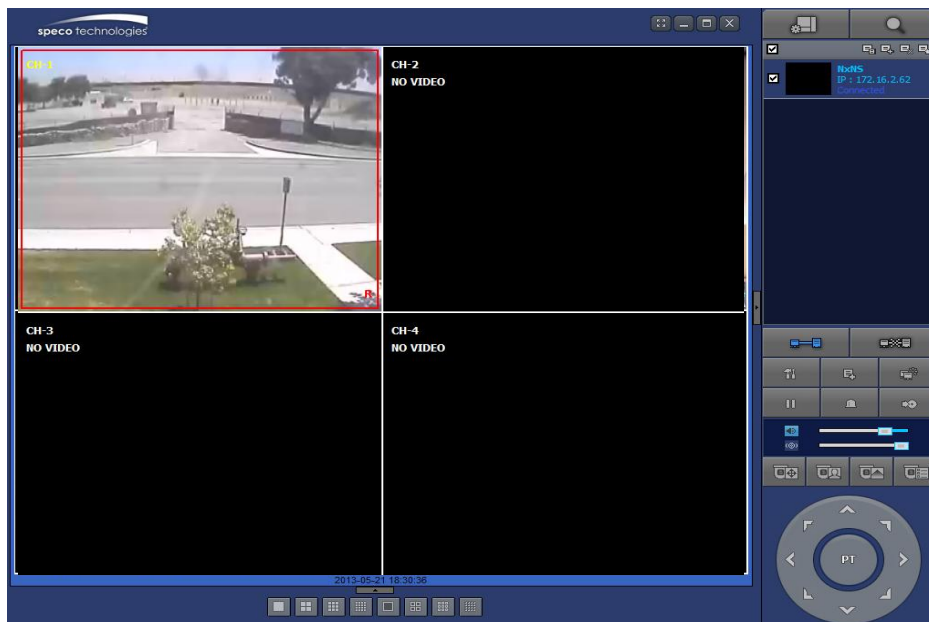

APPENDIX: E-SATA CONNECTION



**Please read the following instructions before using the E-SATA port.
Failure to do so may cause serious damage to the recorded video.
SPECO is not responsible for data loss caused by improper usage.**

- Use **ONLY** a new HDD or a HDD that is approved for the unit.
- Turn off the NS before plugging the E-SATA HDD.
- **DO NOT** disconnect the E-SATA port while the NS power is on.
- The purpose of the E-SATA port is to extend recording capacity.
- Once connected, **DO NOT** remove or disconnect the E-SATA port from the NS.
- The E-SATA port is does not support the hot swappable function.