

EHN Plus Series

Outdoor Vandal Proof IP Dome Camera

User's Manual



Copyright © EverFocus Electronics Corp,
Release Date: October, 2012



Copyright © 2012 EverFocus Electronics Corp.

All rights reserved. No part of the contents of this manual may be reproduced or transmitted in any form or by any means without written permission of the EverFocus Electronics Corporation.

EverFocus

12F, No.79, Sec. 1, Shin-Tai Wu Road,

Hsi-Chih, Taipei, Taiwan

TEL: +886 2 2698 2334

FAX: +886 2 2698 2380

www.everfocus.com.tw

October, 2012

Regulatory Notices

About this document

All the safety and operating instructions should be read and followed before the unit is operated. This manual should be retained for future reference. The information in this manual was current when published. The manufacturer reserves the right to revise and improve its products. All specifications are therefore subject to change without notice.

FCC Notice "Declaration of Conformity Information"

This equipment has been tested and found to comply with the limits for a Class A digital device, pursuant to part 15 of the FCC Rules. These limits are designed to provide reasonable protection against harmful interference in a residential installation. This equipment generates, uses and can radiate radio frequency energy and, if not installed and used in accordance with the instructions, may cause harmful interference to radio communications. However, there is no guarantee that interference will not occur in a particular installation. If this equipment does cause harmful interference to radio or television reception, which can be determined by turning the equipment off and on, the user is encouraged to try to correct the interference by one or more of the following measures:

- Reorient or relocate the receiving antenna.
- Increase the separation between the equipment and receiver.
- Connect the equipment into an outlet on a circuit different from that to which the receiver is connected.
- Consult the dealer or an experienced radio/TV technician for help.

Warning: Changes or modifications made to this equipment, not expressly approved by EverFocus or parties authorized by EverFocus could void the user's authority to operate the equipment.

This device complies with part 15 of the FCC Rules. Operation is subject to the following two conditions:

- (1) This device may not cause harmful interference, and
- (2) This device must accept any interference received, including interference that may cause undesired operation.

EverFocus Electronics Corp.

12F, No. 79, Sec. 1, Shin-Tai Wu Rd., Hsi-Chi,
Taipei Hsien, Taiwan, R.O.C.

EHN Plus Series cameras comply with CE and FCC.

Safety Notice

-These limits are designed to provide reasonable protection. This equipment generates, uses and can radiated radio frequency energy and, if not installed and used in accordance with the instructions, may cause harmful interference to radio communications. However, there is no guarantee that interference will not occur in a particular installation. If this equipment does cause harmful interference to radio or television reception, which can be determined by turning the equipment off and on, the user is encouraged to try to correct the interference by one or more of the following measures: -Reorient or relocate the receiving antenna.

-Increase these separations between the equipment and receiver.

-Connect the equipment into an outlet on a circuit different from that to which the receiver is connected.

-Consult the dealer or an experienced radio/TV technician for help.

The changes or modifications not expressly approved by the party responsible for compliance could void the user's authority to operate the equipment.



To reduce risk of fire or electric shock, do not expose this appliance to rain or moisture.



Do not attempt to disassemble the appliance. To prevent electric shock, do not remove screws or covers. There are no user-serviceable parts inside. Contact qualified service personnel for maintenance. Handle the appliance with care. Do not strike or shake, as this may damage the appliance.



Do not use strong or abrasive detergents when cleaning the appliance body. Use a dry cloth to clean the appliance when it is dirty. When the dirt is hard to remove, use a mild detergent and wipe gently.



Do not operate the appliance beyond its specified temperature, humidity or power source ratings. Do not use the appliance in an extreme environment where high temperature or high humidity exists. The input power source for this appliance is DC 12V & PoE. Use the appliance at a temperature between -40°C ~ 55°C / -40°F ~ 131°F (DC 12V) / -20°C ~ 55°C / -4°F ~ 131°F (PoE) and humidity between 0% ~ 90%.



Use only the recommended power supplies. Power supplies must comply with the requirement of the latest version of IEC60950-1. Substitutions may damage the unit or cause a fire or shock hazard.



Electrostatic-sensitive device. Use proper CMOS/MOSFET handling precautions to avoid electrostatic discharge.



Installation should be performed by qualified service personnel only in accordance with the National Electrical Code or applicable local codes.

Terms and Trademark

Ethernet, Internet Explorer, Linux, Microsoft, Windows, WWW are registered trademarks of the respective holders. Other product names appearing in this User's Guide may be trademarks or registered trademarks of their respective holders. Java™ and all Java-related logos and trademarks are trademarks or registered trademarks of Sun Microsystems, Inc. in the United States and other countries.

Support

If the unit ever needs to be repaired or serviced, the customer should contact the nearest EverFocus Electronics Corp. Service Center for return authorization and shipping instructions.

CONTENTS

1. Introduction	1
2. Overview	2
3. Features.....	3
4. Installation	4
4.1 Packing List.....	4
4.2 Optional Accessories.....	4
4.3 Terminal Block.....	5
4.4 Important Notice for the Installation.....	6
4.5 Basic Installation	6
5. Accessing the User Interface.....	13
5.1 Assigning an IP Address	13
5.2 Settings for Microsoft Internet Explorer	15
5.3 Connecting the Camera to the Network.....	17
5.4 Live View Window.....	19
6. Playback	22
6.1 Remote Playback Using Playback Page	22
6.2 Setting Up the Playback Function	24
6.2.1 Preparing the SD Card.....	24
6.2.2 Testing the Playback Function.....	24
6.3 Playing Back Using ARV Viewer.....	26
7. Settings.....	27
7.1 System Info.....	27
7.1.1 Information	27
7.1.2 Log.....	28
7.2 User Config.....	29
7.2.1 Live View Config.....	29
7.2.2 Recording/Snapshot	30
7.2.3 Language	31
7.3 Network	32
7.3.1 Network	32
7.3.2 DDNS.....	34
7.3.3 SMTP / FTP.....	36

7.3.4	HTTPS	38
7.3.5	SNMP.....	41
7.3.6	Network Alarm.....	41
7.4	Video	42
7.4.1	Multi Streaming	42
7.4.2	Camera	44
7.4.3	Advanced	46
7.4.4	ROI (Region of Interest)	53
7.4.5	Privacy Mask	54
7.5	Audio	56
7.6	User	57
7.6.1	User Information.....	57
7.6.2	IP Address Filter	59
7.7	Event	60
7.7.1	Event Settings.....	60
7.7.2	Motion Detection.....	63
7.7.3	Tamper Detection	64
7.7.4	Alarm I/O.....	64
7.7.5	Schedule.....	65
7.8	System	66
7.8.1	Date/Time	66
7.8.2	Daylight Saving.....	67
7.8.3	SD Card.....	67
7.8.4	Maintenance	68
8.	Upgrading Firmware Using IP Utility	70
9.	Specifications	72
Appendix	74
A.	Adjustment Rings	74

1. Introduction

The EHN Plus series is an outdoor vandal proof IP dome delivering image quality of up to 3-megapixel. The camera is equipped with a P-Iris, which enables the camera to automatically and precisely control the Iris opening in all lighting conditions for optimal depth of field and image quality including sharpness and clarity.

The EHN Plus series supports both H.264 and MJPEG compression formats. The IP66-rating and vandal proof housing make it suitable for outdoor use. The IR LEDs are also implemented for infrared illumination in night vision applications.

The EHN Plus series features the Wide Dynamic Range (WDR) function, which can provide clear images even under back light circumstances where intensity of illumination can vary excessively. A built-in SDHC card slot and Power over Ethernet (IEEE 802.3at) features are also provided. You can power the camera over the network or by connecting the camera to a 12V DC power supply. Since the EHN Plus series conforms to ONVIF / PSIA for compatibility with other network video devices, it interoperates with a wide variety of hardware and software systems.

The EHN Plus Series Models

Model Name	Megapixel	P-Iris	WDR
EHN3160 Plus	1.3 MP	Yes	Yes
EHN3260 Plus	2 MP	Yes	Yes
EHN3340 Plus	3 MP	Yes	No

System Requirement

Before installing, please check that your computer meets this system requirement.

- Operating System: Microsoft Windows XP / Vista (32-bit) / 7 (32-bit)
- Microsoft Internet Explorer 7 or above

Note: For using the Internet Explorer, some settings are required. Please refer to *5.2 Settings for Microsoft Internet Explorer*.

2. Overview

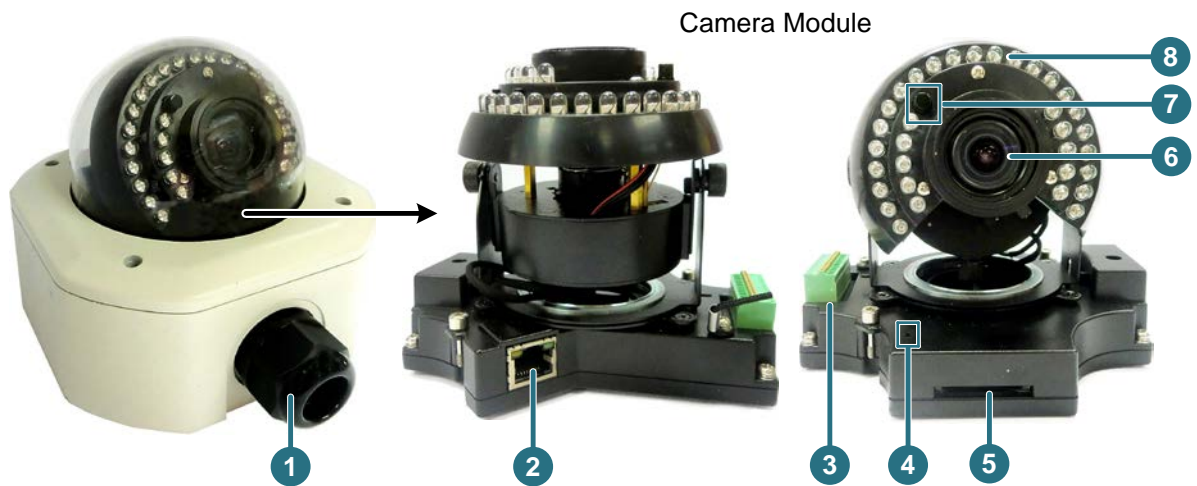

No.	Item Name	Descriptions
1	Cable Gland	Equipped with three plugs inserted in the cable conduits for waterproofing.
2	LAN / PoE	Connects to a 10/100 Ethernet or PoE.
3	Terminal Block	A 12-pin terminal block. See 4.3 <i>Terminal Block</i> .
4	Reset Button	Resets all configurations to the factory default settings.
5	SD / SDHC Slot	For inserting an SD / SDHC card
6	Lens	Varifocal lens with P-Iris control.
7	Light Sensor	Detects lights.
8	IR LEDs	33 IR LEDs for infrared illumination in night vision applications.

3. Features

- 1/3" Panasonic CMOS sensor (for EHN3160 Plus / 3260 Plus)
1/2.8" Sony CMOS sensor (for EHN3340 Plus)
- Triple streams (stream 1 / 2 / 3 from H.264 or MJPEG)
- Up to 30 fps at 1920 x 1080
Supports 15 fps at 2048 x 1536 (only for EHN3340 Plus)
- Built-in P-Iris
- Built-in SD / SDHC card slot
- Removable IR-cut filter for Day / Night function
- 3-axis mechanism (pan / tilt / rotate)
- One alarm input and output
- Two-way audio
- TV-out
- IP66 rating
- Wide Dynamic Range (for EHN3160 Plus / 3260 Plus)
- Digital Slow Shutter (DSS)
- 2D / 3D Dynamic Noise Reduction (DNR)
- Motion detection
- 10x digital zoom
- Privacy mask
- DC 12V / PoE

4. Installation

4.1 Packing List



Please check that there is no missing item in the package before installing.

- EHN Plus Series Camera x 1
- Base Plate Screw x 4
- Screw Anchor x 4
- Hexagon Screwdriver x 1
- Desiccant Bag x 2
- Inner Paper x 1
- Software CD x 1
- Quick Installation Guide x 1

Note: Contact the shipper if any items appear to have been damaged in the shipping process. If any items are missing, notify your EverFocus Electronics Corp. Sales Representative or Customer Service Branch. Please also keep the shipping carton for possible future use.

4.2 Optional Accessories

You can use the optional accessories to expand the capabilities and versatility of the camera. Please contact your dealer for more information.

<ul style="list-style-type: none"> • One Adapter Plate with 4 Screws 	<p>The Adapter Plate is designed for wiring the cables through the bottom of the camera case. For details on how to wire the cables through the bottom of the camera, please refer to <i>4.5 Basic Installation</i>.</p>
<ul style="list-style-type: none"> • L-Shaped Mounting Bracket 	<p>To prevent the camera from being damaged by direct sunlight, it is strongly recommended to use the L-Shaped Mounting Bracket to mount the camera to the wall. For details on mounting the camera to the wall using the L-Shaped Mounting Bracket, please refer to <i>4.5 Basic Installation</i>.</p>

4.3 Terminal Block

The I/O terminal block, located on the camera module, can be used to develop applications for alarm input and output, two-way audio, TV-output or a variety of other functions.

Note:

1. You can unplug the terminal block from the camera module for easier wiring.
2. Microphones with external power supplies are required.

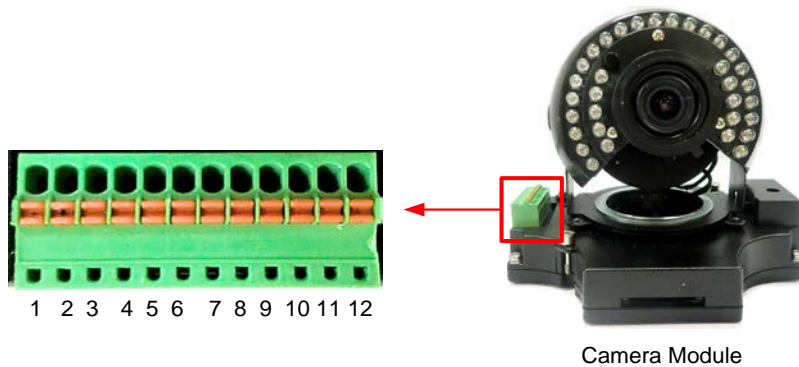

Pin Assignment

No.	Functions	No.	Functions
1	12V DC Input	7	Line Input C
2	Digital GND	8	Audio GND
3	Alarm Output C	9	Audio Output
4	Alarm COM C	10	Audio GND
5	Alarm Input C	11	CVBS Output
6	Digital GND	12	Digital GND

4.4 Important Notice for the Installation

If you want to mount the camera on the wall where direct sunlight may occur, it is strongly recommended to mount the camera using the L-Shaped Mounting Bracket to prevent the camera from being damaged by direct sunlight.



4.5 Basic Installation

Follow the steps below to install the EHN Plus IP camera to the wall.

To mount the camera to the wall and connect the cables to the related devices:

1. Unscrew the four screws and remove the cover from the camera.



2. Unscrew the four screws and remove the Base Plate from the Camera Case.

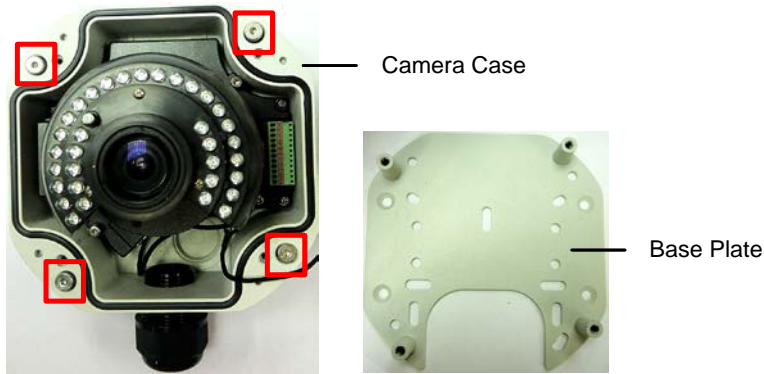

3. Unscrew the two screws and take out the camera module.

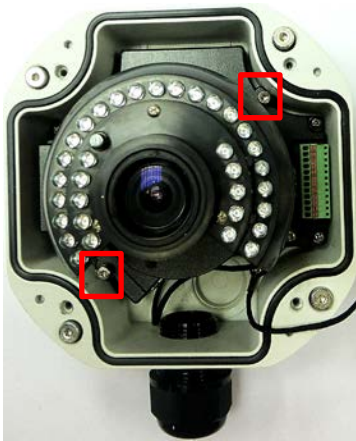

4. Screw the Base Plate to the wall / Wiring Box using the supplied four screws.

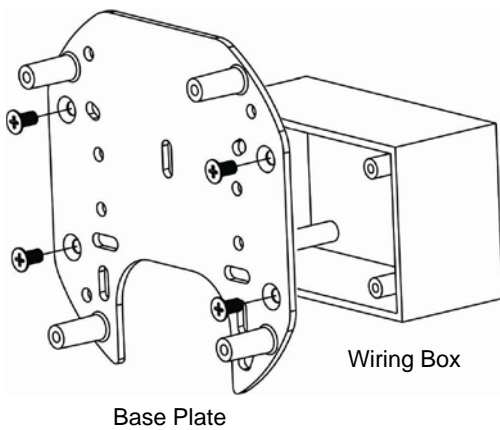

If you want to **wire the cables through the bottom of the Camera Case**, follow the steps below:

- a. Remove the Circle Plate on the bottom of the Camera Case. You can simply loosen the Circle Plate using a coin.

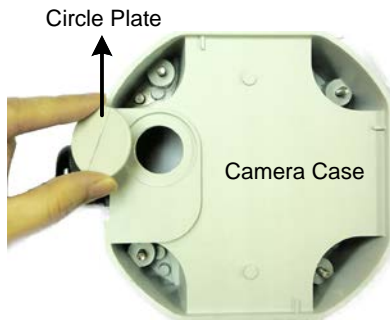

- b. Loosen and remove the Cable Gland from the Camera Case. Screw the Cable Gland to the hole on the bottom of the Camera Case.



- c. Screw the Circle Plate to the side hole on the camera Case.



- d. Screw an Adapter Plate between the Base Plate and Wiring Box.

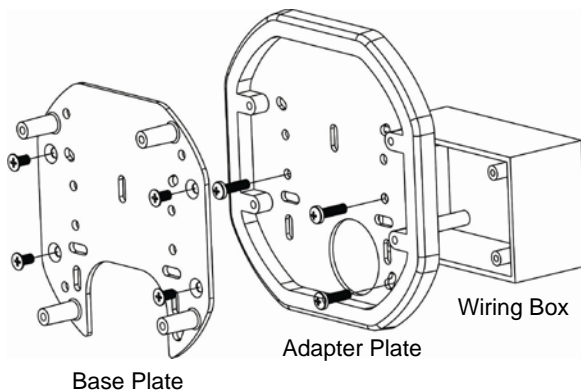

5. Screw the Camera Case back to the Base Plate.

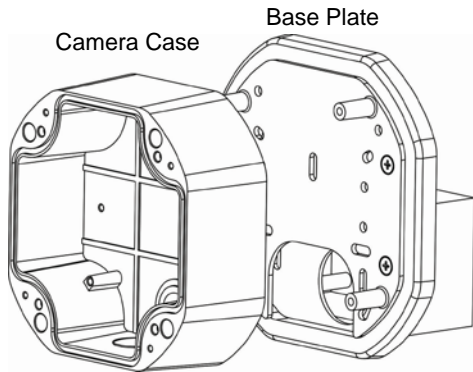

6. Insert the network / PoE cable or the additional cables through the Cable Gland. Up to three cables can be inserted. Note that except the network / PoE cable, additional wires have to be bundled into a cable with diameter ranging from 5.3mm to 6.4mm (see **Step d** below).

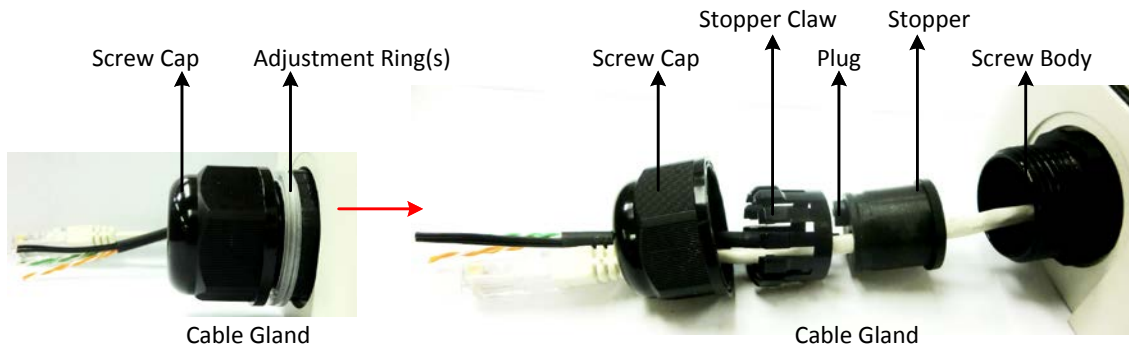

- a. Remove the black Adjustment Ring if you are using a Cat 5 network cable. Note that the four Adjustment Rings, including one black and three transparent rings, are attached on the Cable Gland. **If you are using a Cat 6 network cable, you can ignore this step.** For details on the Adjustment Rings, please refer to *10.1 Adjustment Rings*.

- Transparent x 3 (1 mm thickness)
- Black x 1 (0.5 mm thickness)



- b. Remove the Plug(s) from the Stopper (depends on the number of cables inserted). One Cable Conduit can only be inserted with one cable.

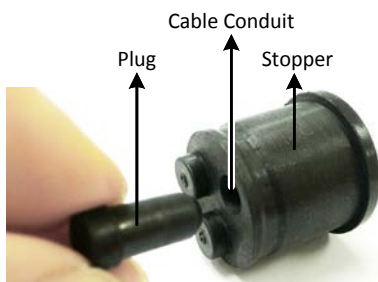

- c. Insert the network / PoE cable through the Cable Conduit, if your network / PoE cable already has a RJ-45 connector, then you can use the Slitted Cable Conduit.

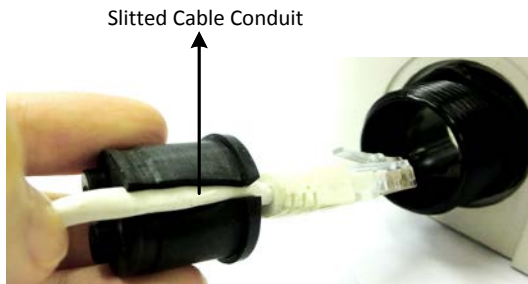

- d. Optionally insert the additional wires, such as power (if you want to power the camera through a 12V DC power source), alarm and audio cables, through the other Cable Conduit. Note that one Cable Conduit can only be inserted with one cable. The Cable Conduit has been tested to support cable diameter between 5.3mm and 6.4mm. Please refer to the image below to bundle the loose wires before inserting to the Cable Conduit.

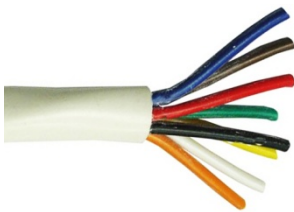

- e. Tighten the Screw Cap all the way to the Adjustment Ring(s).
- f. **Due to the variable cable diameters, for better waterproofing, it is strongly recommended that you apply silicon sealants to the inner Screw Cap.**



- 7. Connect the network / PoE cable to the LAN / PoE port on the camera module.
- 8. If you have inserted additional wires, connect the wires to the terminal block. Please refer to *4.3 Terminal Block* for pin assignment.

9. Optionally insert an SD / SDHC card to the card slot.



10. Stick the supplied 2 desiccant bags inside the camera case.

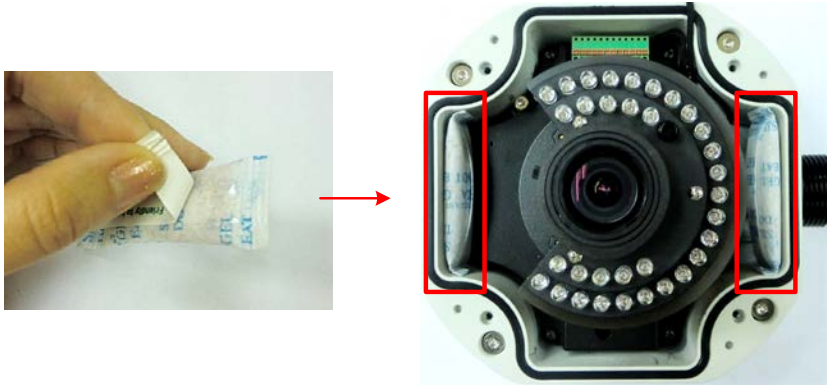

Note: It is highly recommended to replace the desiccant bags every time when you open the camera.

11. Place and screw the camera module back to the camera case.
12. Access the camera live view for adjusting camera lens and angles. For details on how to access the camera live view, see 5. *Accessing the User Interface*.
 - a. To adjust camera lens, use the **Zoom / Focus** screws.

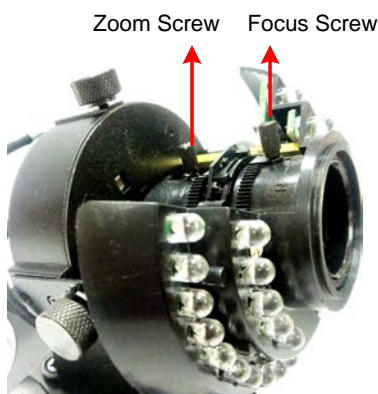

b. To adjust the camera to a desired angle:

Pan Adjustment: Simply turn left / right for the top camera module.



Tilt Adjustment: Using the two tilt screws.

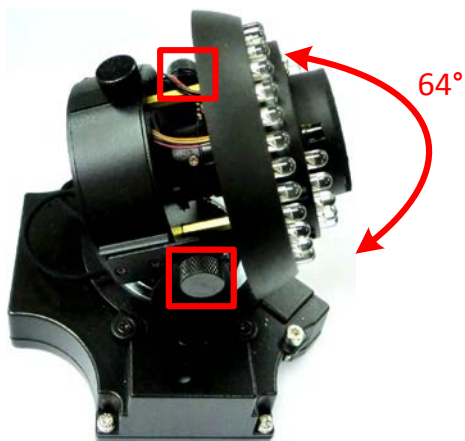

Rotational Adjustment: Using the rotate screw.

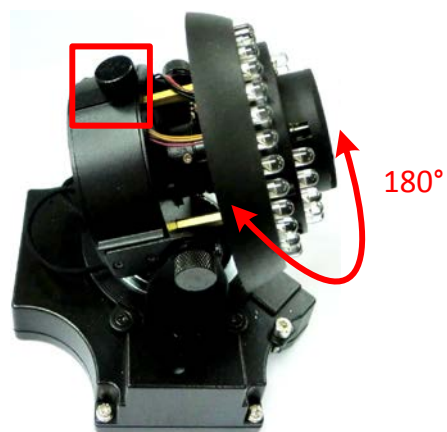

13. Screw the cover back to the camera case.

5. Accessing the User Interface

This section explains how to access the Web interface of the camera for configuration.

5.1 Assigning an IP Address

You have to assign an IP address for your camera to be accessible. To assign an IP address to the camera, use the **IP Utility (IPU)** software included in the software CD. Please connect the IP camera in the same LAN of your computer.



1. Install and then start the IPU program . The following dialog box appears.

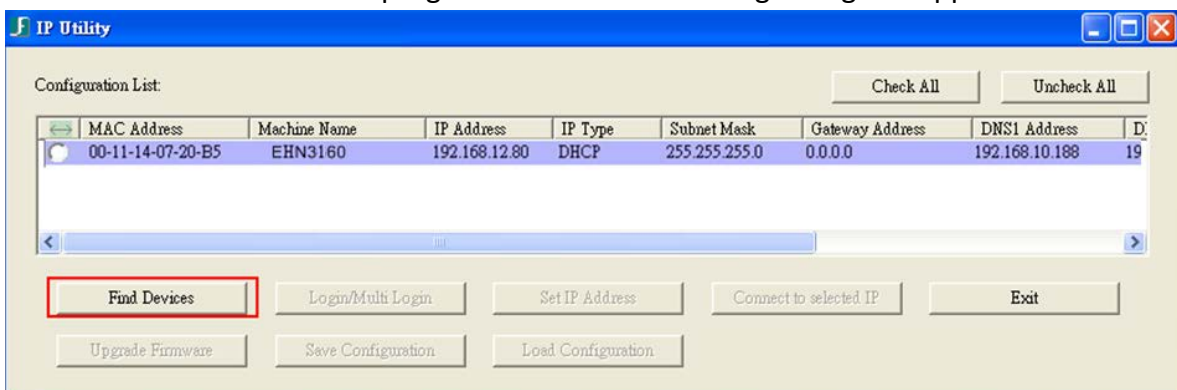

2. Click **Find Devices** to search the cameras connected in the LAN. The default network values of the cameras will be displayed. By default, the network protocol of the camera is **DHCP**.
3. To configure the network settings, select a camera and then click **Login/Multi Login** to log in.

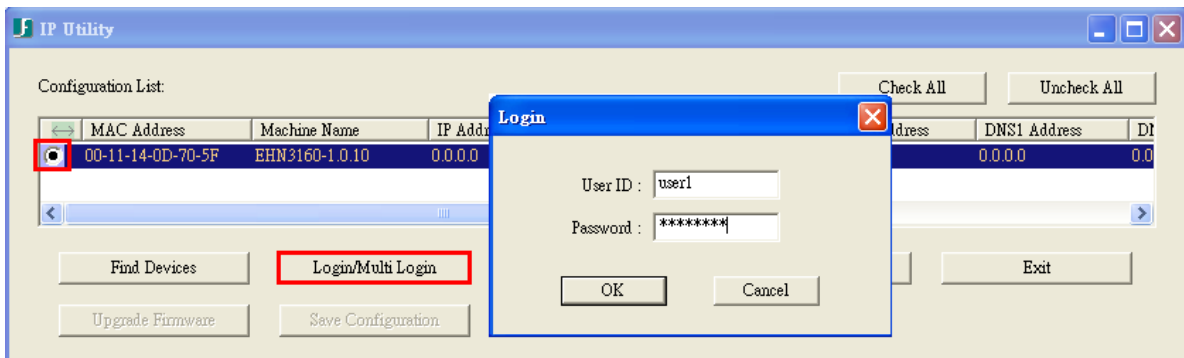

4. Type the user ID and password. Click **OK**.

Note:

1. The default user ID is **user1** and the default password is **11111111**.
2. If you select more than one camera that has the same user ID / password, you will be able to log in several cameras at once.

- To change the IP address, double-click the IP Address of the camera. Type a new IP address and then click **Set IP Address** to save the settings.

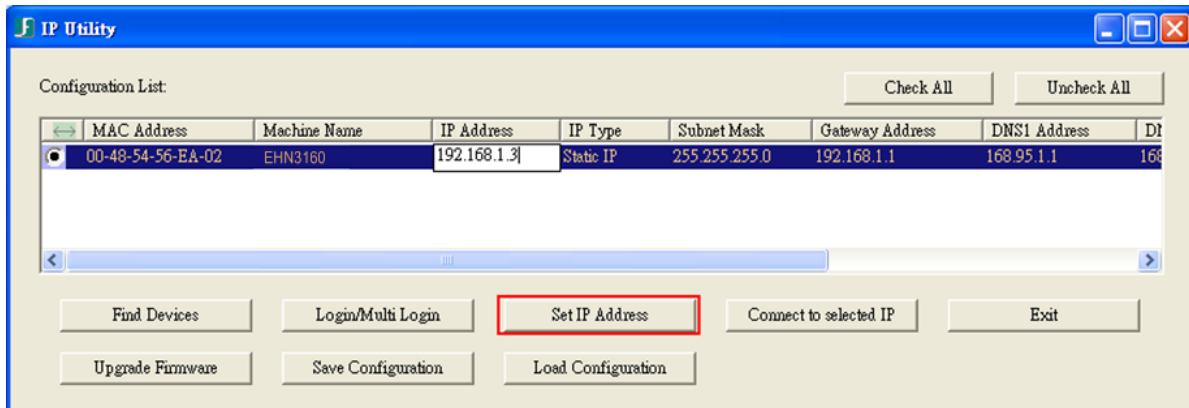

You can also change the other settings by double-clicking the values. After configuring the values, click **Save Configuration**.

Note: Most networks uses DHCP to assign IP addresses, if you are unsure of your network settings, please consult your network administrators for configuration details.

- To access the camera, highlight the camera and click **Connect to Selected IP**. The Internet Explorer window pops up.
- Type the user ID and password to log in. The Live View window of the camera appears.

Note: You might be required to download **ActiveX**, which is required to view the camera feed. If asked, click "Yes". For more details on setting up the Microsoft Internet Explorer, please refer to *5.2 Settings for Microsoft Internet Explorer*.

5.2 Settings for Microsoft Internet Explorer

To enable Remove Live View, Firmware Upgrade and ActiveX Prompt on Internet Explorer, some settings have to be complete. Please follow the steps below:

1. On the computer, click Start > Control Panel > System and Security > Action Center (click Change User Account Control Settings), the **User Account Control Settings** window appears. Adjust the slide bar to **Never Notify** and then click **OK**. Restart your computer if requested.

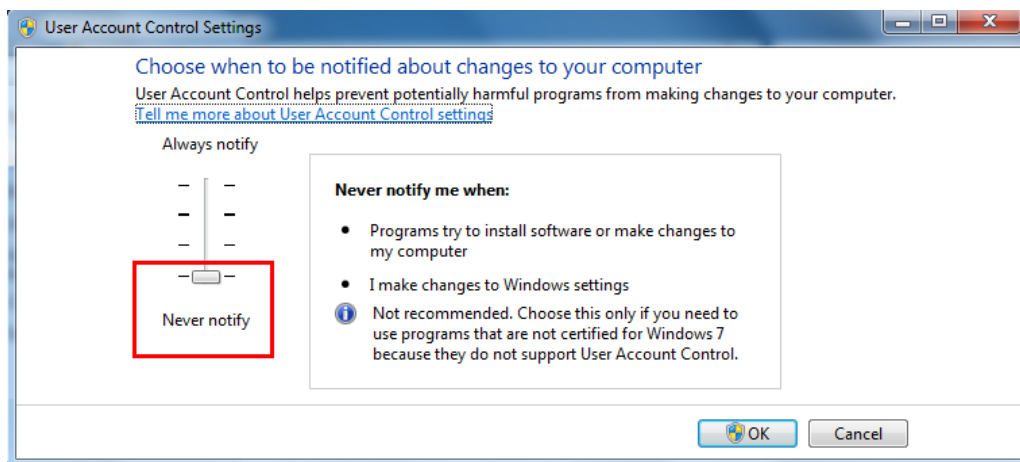

2. Open the Internet Explorer, click Tools > Internet Options > Security Tab > Custom Level, the **Security Settings** windows appears.

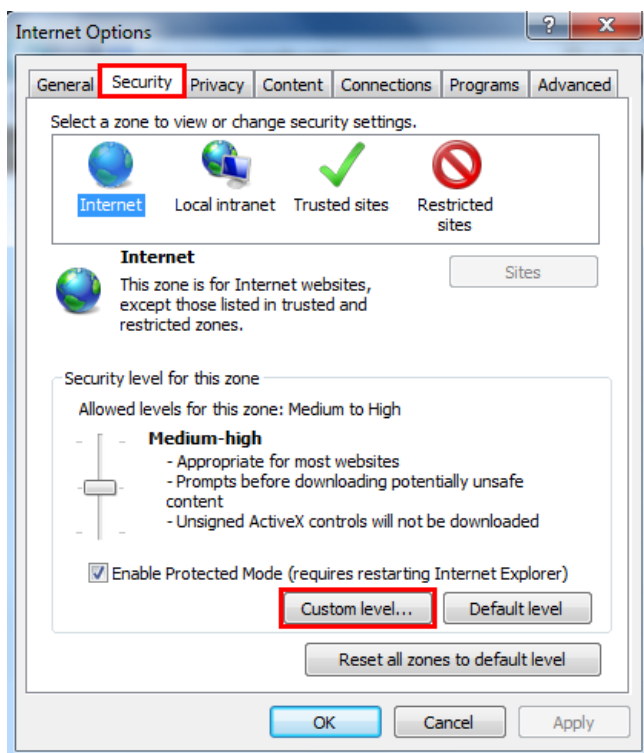

3. In the **Download unsigned ActiveX controls** field, select **Prompt**. In the **Include local directory path when uploading files to a server** field, select **Enable**. Click **OK**.

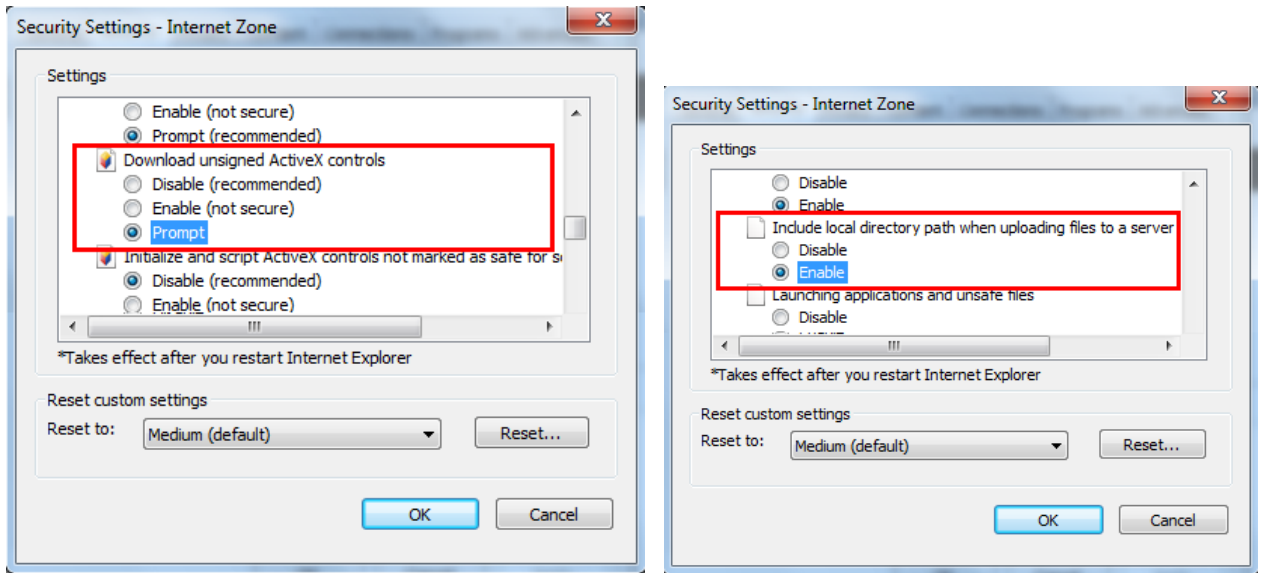

4. In the Internet Options window, click the **Advanced** tab and then disable **Enable memory protection to help mitigate online attacks**. Click **OK**.

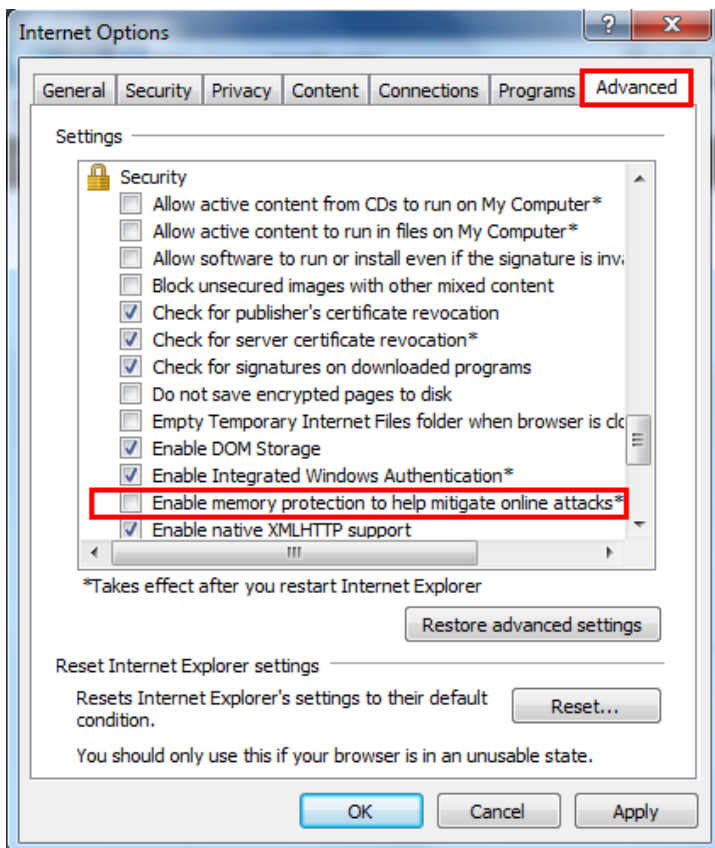

5.3 Connecting the Camera to the Network

There are three methods to connect the IP camera to the network: **Router or LAN Connection, Direct High-Speed Connection** and **One-to-One Connection**.

Router or LAN connection

This is the most common connection in which the IP camera is connected to a router and allows multiple users on and off site to see the IP camera on a LAN/WAN (Internet). The camera must be assigned an IP address that is compatible with its LAN. By setting up port forwarding on the router, you can remotely access the cameras from outside of the LAN via the Internet. To remotely access the Web interface of the IP camera, please refer to 7.3.2 DDNS. To set up port forwarding, please consult the manual of the router.

Router or LAN Connection

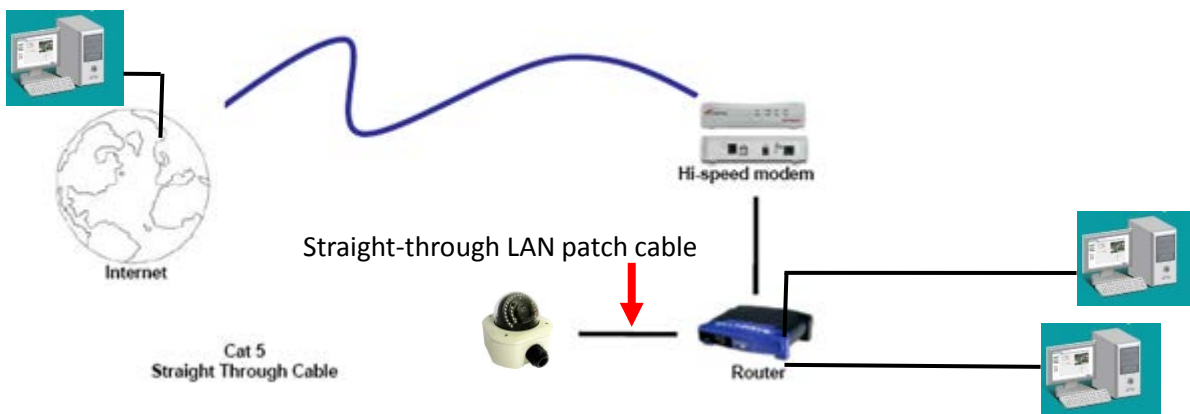

Right: Pinout of a straight-through cable.

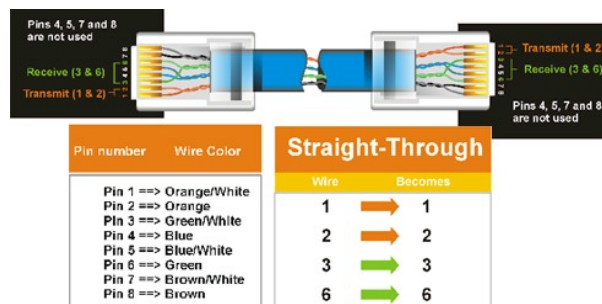

Direct High-Speed Connection

In a Direct High-Speed Connection, the camera connects directly to a modem without the need for a router. You need to set the static or dynamic WAN IP address assigned by your ISP (Internet Service Provider) in the camera’s configuration web pages. To access the camera, just type “http://xxx”, where xxx is the IP address given by your ISP. If you have a dynamic IP address, this connection may require that you use DDNS for a reliable connection. Please refer to 7.3.2 DDNS.

Direct High Speed Modem Connection

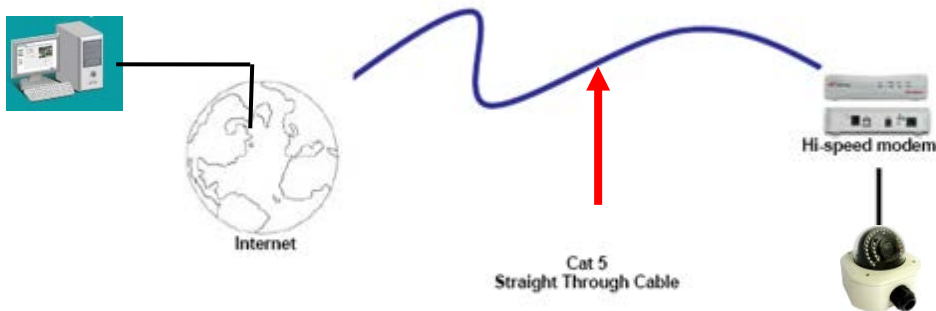

One-to-One Connection (Directly from PC to IP Camera)

You can connect directly without using a switch, router or modem. However, only the PC connected to the camera will be able to view the IP camera. You will also have to manually assign a compatible IP address to both the computer and the IP camera. Unless the PC has another network connection, the IP camera will be the only network device visible to the PC. See the diagram below:

Simple One to One Connection



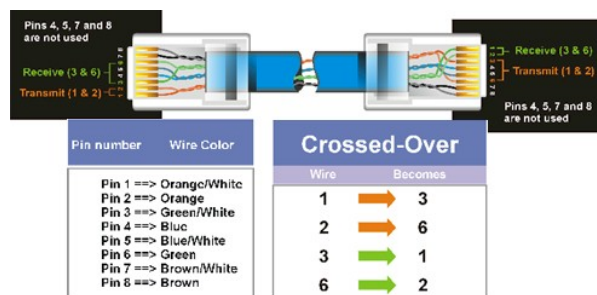

Right: Pinout of a crossed-over cable.

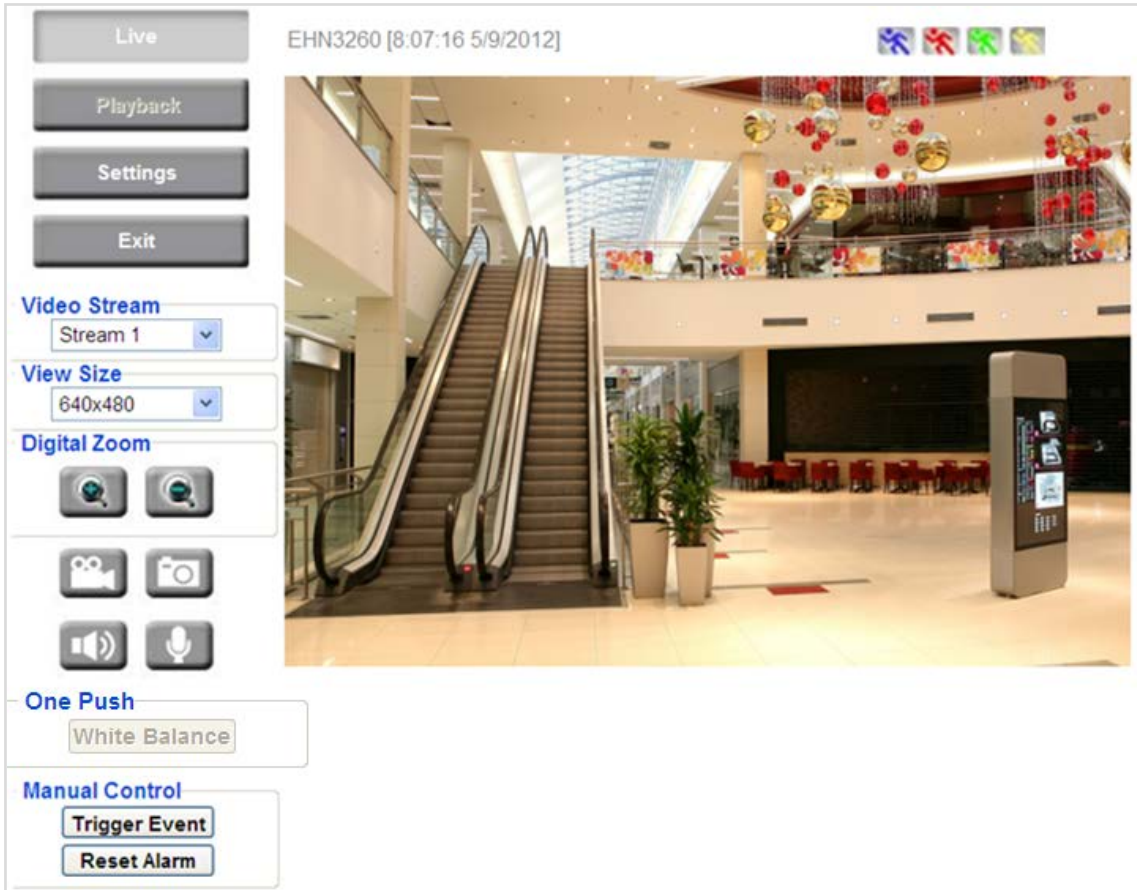

5.4 Live View Window



1. Press the  button to display the "Live View" window. Double-click on the image to show a full-screen display, double-click again or press ESC to return to the normal display. *If you experience video feed lag time (if connected via Internet), you can reduce the resolution or limit the number of streams. See 7.4.1 Multi Streaming.*

2. Press the  button to play the recorded data directly from the on-camera SD card *(for this function to become active, you have to insert an SD card in the camera's SD card slot. See 7.8.3 SD Card.*

3. Press the  button to enter the Settings page. On the Settings page, there are 8 submenu sections: [System Info], [User Config], [Network], [Video], [Audio], [User], [Event] and [System]. Click on the section buttons to open their configuration fields. See the Settings section below for more information.

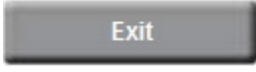
4. Press the  button to exit the system and close this browser page.

5. **Video Stream**

Select the Video Stream (Stream 1, Stream 2 or Stream 3) that will be displayed in the video box on the right. Stream 2 and Stream 3 are only selectable if you have enabled the stream. The default setting is Stream 1 only. See *7.4.1 Multi Streaming*.

6. **View Size**

Use this to select the appropriate view size and shape of the video box on the right. A smaller size might increase transmission speed and video quality.

7. **Digital Zoom**  

Click the Zoom In / Zoom Out buttons or roll the mouse wheel to zoom in / out the camera live view up to 10x. Clicking on a magnified image will re-center the image around that point.

8. **Record** 

The Record button is used to record the current video stream. Click the Record button to start / stop recording. This icon is only for one-minute video recording. To record long-period recordings, please set a recording schedule (see *7.7.5 Schedule*). The location on your computer, where the image files will be saved to, and file size can be specified in the submenu (see *7.2 User Config*).

9. **Snapshot** 

Click the Snapshot button to save a snapshot of the video image currently being displayed. The location on your computer where the snapshot data will be saved can be specified in “Settings > User Config > Recording / Snapshot” (see *7.2 User Config*).

10. **Play Audio / Transmit Audio**  

Click the “Play Audio” (speaker) and “Transmit Audio” (microphone) buttons to switch the sound on/off for the speaker and microphone, respectively (if such external devices have been connected to the camera).

11. One Push

This function is only available for EHN3160 Plus / 3260 Plus. The **One Push** button can be displayed on the live view window by enabling the **Show One Push Buttons** function on the User Config < Live View Config Setting page (see 7.2.1 *Live View Config*). To enable the button (turned from faded to clear), on the Video < Advanced Setting page, select **One Push** from the White Balance Settings Mode drop-down list, and click the **Apply** button. Once this is done, pressing the One Push button on the Live View Window will instruct the camera to adjust the white balance settings, and these settings will be active until the button is pushed again. This is like a “semi-automatic” way to adjust white balance to suit the user, if the Auto or Manual mode does not give the result the user wants.

12. Manual Control

– Trigger Event 

Press the “Trigger Event” button to trigger an event directly from the Live View window. If you have configured an event (in the Event submenu) that will trigger a reaction (like a recording) when a *Manual Trigger* event occurs, clicking this button will trigger that reaction. You can select what that reaction will be. You can, for instance, set the camera to record the audio/video feed to the SD card on board the camera. You can then click on the Playback button to open the Playback page and search for and play all such recordings that had been stored on the card. Such event actions will be effective once they have been configured in the “Event” menu (see 7.7 *Event*).

– Reset Alarm 

Press the “Reset Alarm” button to reset the alarm output remotely.

13. Status Display (info line that can be placed above video box or at bottom of page)

This shows the name of the camera that is currently active or being configured, current date/time and current frame rate. You can activate these info displays in the Settings > User Config page (see 7.2 *User Config*).

14. Event signal icons (above video screen)

When an alarm or motion event is triggered, a signal icon will appear at the top right of the Live View window to alert the user.

Alarm event icon  : When an alarm is triggered, this icon appears.

Motion detection icons  : The colors of these motion event icons correspond to the colors of the motion trigger areas you have configured in the Motion Detection submenu (see 7.7.2 *Motion Detection*).

Recording icon  : When the camera is recording to a PC-based folder, this icon appears.

6. Playback

You can remotely play back the recordings stored in the on-camera SD card on the Web interface, or play back the recordings stored in the computer using the **ARV Viewer** included in the software CD.

Playback is designed as a quick way to check recent recordings that were triggered by Events that were configured to “Record to SD Card” in the Settings > Event > Event Settings page (see 7.7.1 *Event Settings*).

Note: Note that the Playback page is only accessible once the on-camera SD card is inserted and active.

6.1 Remote Playback Using Playback Page

On the Live View Window, click the Playback button  to open the Playback page.

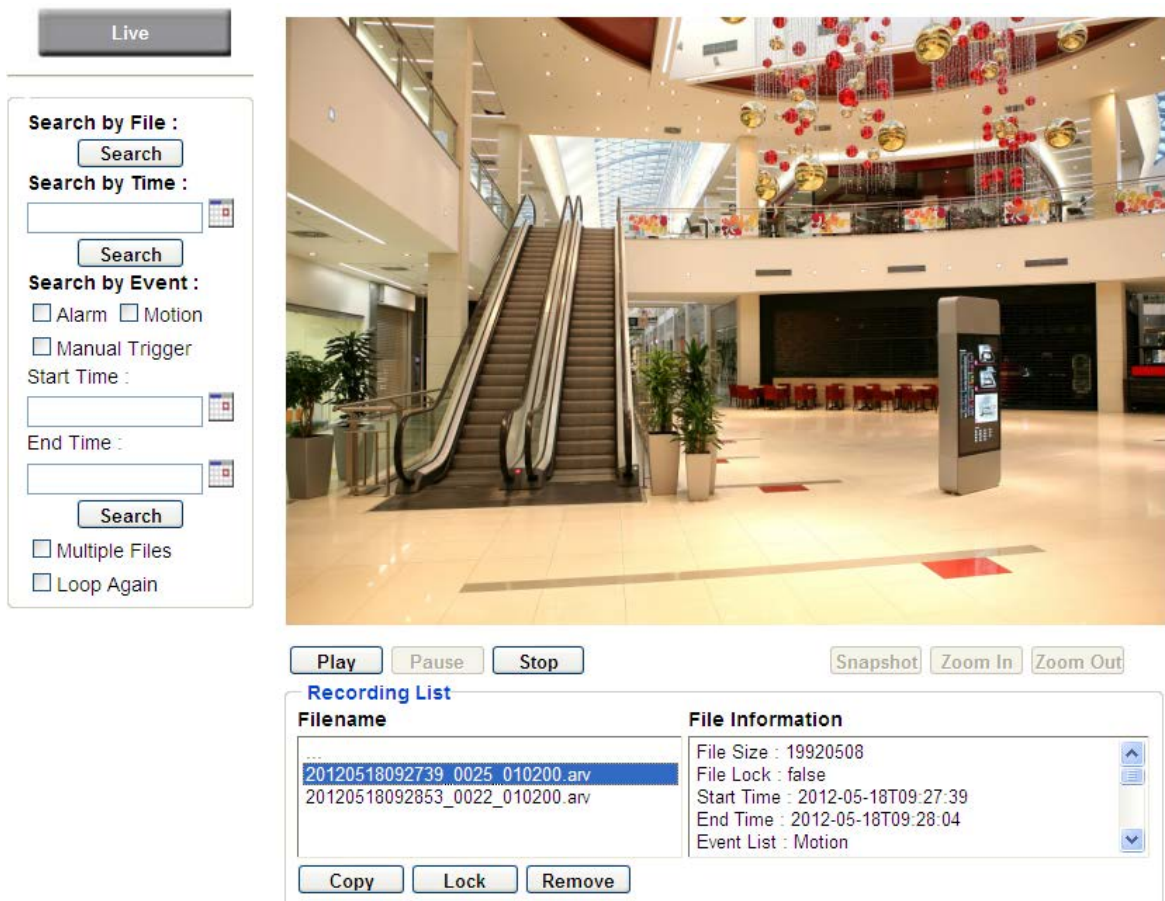

The screenshot displays the playback interface. On the left is a search panel with the following sections:

- Search by File :** Includes a 'Search' button.
- Search by Time :** Includes a text input field and a 'Search' button.
- Search by Event :** Includes checkboxes for 'Alarm', 'Motion', and 'Manual Trigger'. Below these are 'Start Time' and 'End Time' input fields with calendar icons, and a 'Search' button.
- At the bottom of the search panel are checkboxes for 'Multiple Files' and 'Loop Again'.

The main video window shows a mall interior with escalators and festive decorations. Below the video are playback controls: 'Play', 'Pause', 'Stop', 'Snapshot', 'Zoom In', and 'Zoom Out'.

Below the controls is a 'Recording List' table:

Filename	File Information
20120518092739_0025_010200.arv	File Size : 19920508
20120518092853_0022_010200.arv	File Lock : false
	Start Time : 2012-05-18T09:27:39
	End Time : 2012-05-18T09:28:04
	Event List : Motion

At the bottom of the recording list are 'Copy', 'Lock', and 'Remove' buttons.

Search by File: Click the Search button to search for all recording files on the on-camera SD card. Search results will be displayed in the Filename area.

Search by Time: Click the calendar icon and select the date and time from which you want to search until the present moment. Click search to get your search results, which will be displayed in the Filename area.

Search by event: Click the type of Event recordings you want to search for (Alarm, Motion, Manual Trigger) and then click the calendar icons to select the Start Time date/time and the End Time date/time of your search. Click Search to get your search results, which will be displayed in the Filename area.

Multiple Files: Check this box if you want the video player to play all the files in the selected folder. The files will be displayed in the Filename area.

Loop Again: Check this box if you want the video player to play the selected file over and over again.

Play: Once you have opened the file's folder and have clicked on the file to highlight it, its details will be displayed in the File Information area. You can now click Play to play that specific file.

Pause: Click this button to pause the playback.

Stop: Click this button to stop the playback.

【Recording List】

Filename: This area will display a list of search results (recording files and folders). Folders (named with the recorded date) will be displayed first. Click on the folder and click on each subfolder until the recording files (.arv) in that folder is listed.

File Information: Click a file on the Filename list, the selected file information will be listed.

Copy: Click this button to copy the selected file to the computer-based folder of your choice. A browsing box will open so that you can search for the folder of your choice. You can use the ARV Viewer to play back the recordings restored in your computer. For details on ARV Viewer, see 6.3 *Playing Back Using ARV Viewer*.

Lock: Click this button to lock the selected file. This will protect that file from being overwritten during any overwrite procedure. The file will thus be saved on the SD card indefinitely. *However, the file will still be deleted if the SD card is ever formatted.*

Remove: Click this button to delete the selected file.

6.2 Setting Up the Playback Function

Note that the Playback function will not be active until the user has inserted an SD card in the camera's SD card slot. The card may also have to be formatted in the Settings submenu.





6.2.1 Preparing the SD Card

Once you insert a functional SD card into the slot, the Playback button on the Live page should become active within seconds (see section 6.2.2 below – the grey letters should turn white). **IF NOT**, do the following:

1. From the Live page, click Settings > System > SD Card. If no card has been inserted yet, the *Remove* button should be faded, indicating that no card is being detected. (If a card is inserted, and the *Remove* button is still faded, pull the card out and re-insert it.)
2. Slide the card into the slot until it clicks into position.
3. The *Remove* button should become active within a few seconds, indicating the card is active.
4. If the *Remove* button stays faded, click the *Format* button to format the card. NOTE: All data on the disk will be deleted if the *Format* button is clicked.

6.2.2 Testing the Playback Function

1. Once the SD card is detected by the system, the button  (inactive) will turn to  (active).
2. **To optionally test the Playback function**, set up a “Manual Trigger” Recording Event by clicking Settings > Event > Event Settings.

3. Click the “Add” button on the middle right side of the page to open an “Add Event” box.
4. Give the event a name, like “Test 1”.
5. In the “Event Triggered by” field, click on Manual Trigger.
6. Below this, check “Enable This Event”, “Enable Post-trigger Buffer”, and “Record to SD Card”.
7. To save your settings, click OK, or close the box by clicking on the red x icon at top right of the box (in which case you will be asked if you want to save the data, to which you should reply OK). The box will close and the new event will be listed in the list area of the Event Settings page.
8. Look at the “Post-trigger Buffer” at the bottom to make sure the buffer time is set to 10 seconds.
9. Click “Apply” to make sure all settings are saved.
10. Click the Live button to go back to the Live page.
11. Get ready to click the Trigger Event button at the bottom of the page. Before you do, see if you can find something in the view screen that will give you a visual time marker. For instance, if you can get your hand in front of the camera’s lens, get ready to count down on your fingers.
12. Click the Trigger Event button and slowly count down on your fingers in front of the lens (if you are able to do so – if not, try to find visual cues on the view screen that will help you to mark the moment you pushed the trigger). The recording period will be as long as the buffer time you selected – the default period is 10 seconds.
13. Click the Playback button to open the Playback page.
14. There are different ways to search for recording files on the camera’s SD card (i.e. the Playback memory). For a recent recording like your test event, simply click the “Search” button under the “Search by File” header.
15. If the SD card is active and formatted correctly, the recording folder’s name (the recording day’s date) will appear in the Filename box at the bottom. Click on this folder to open it. If there are sub-folders, click on the bottom one (the most recent would be at the bottom) until you can click on a file that cannot open to another sub-level and shows data in the File Information box to the right. This would be the file of the most recent recording event.
16. To play this file, click the Play button below the video box. The test footage you have recorded should start playing. Play time should be 10 seconds if you left the Post-trigger Buffer as 10 seconds.

6.3 Playing Back Using ARV Viewer

You can play back the recordings stored in the computer using the **ARV Viewer**  included in the software CD. To store the recordings in the computer, please refer to **Recording List > Copy** in 6.1 *Remote Playback using Playback Page*.

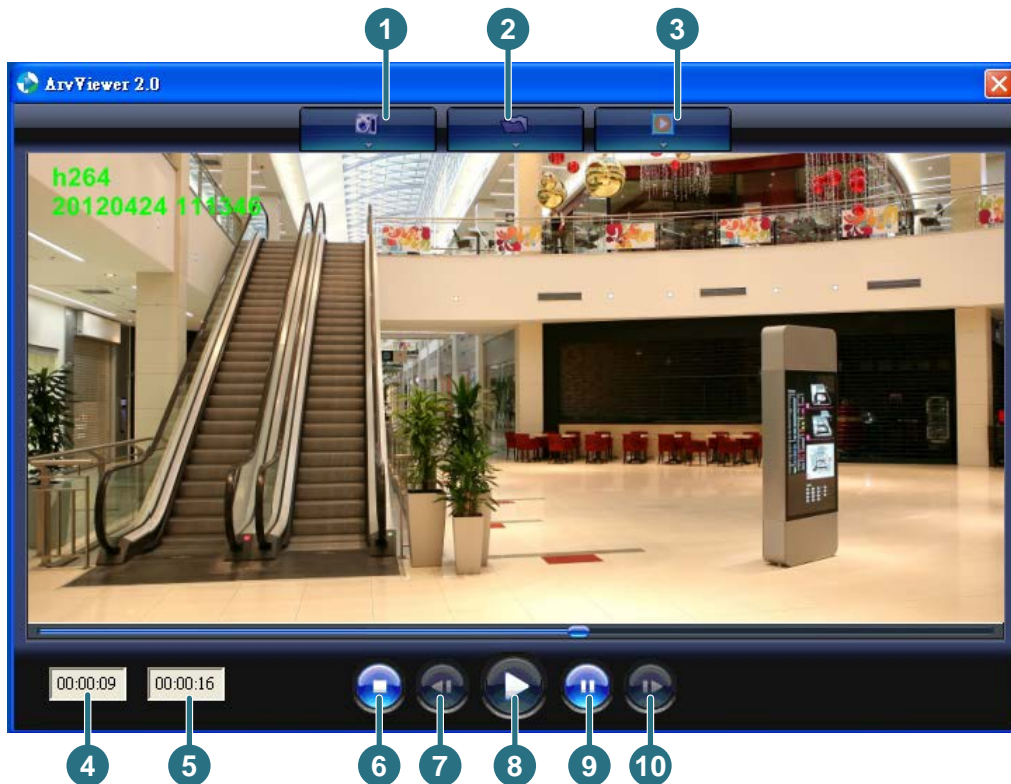

No.	Item Name	Descriptions
1	Snapshot	Click to take and save a snapshot.
2	Load File	Click to load the recordings for playing back.
3	Convert ARV to AVI	Convert the recording from ARV format to AVI format.
4	Playback Time	Display the playback time.
5	Total Time of Recording	Display the total time of the recording.
6	Stop	Click to stop playing the recording.
7	Step Reverse	Click to display the previous frame.
8	Play	Click to play back the recording.
9	Pause	Click to pause the recording.
10	Step Forward	Click to display the next frame.

7. Settings

Click the Settings button on the Live View Window to enter the settings submenu. There are nine buttons on the left-side of the submenu: Live, System Info, User Config, Network, Video, Audio, User, Event and System. Click the Live button can go back to the Live View Window.

7.1 System Info

The System Information and System Log can be checked on this page. Click the top tab of the one you want to see.

7.1.1 Information

Click the Information tab, the following dialog box appears. These values cannot be changed on this page, and are for reference only.

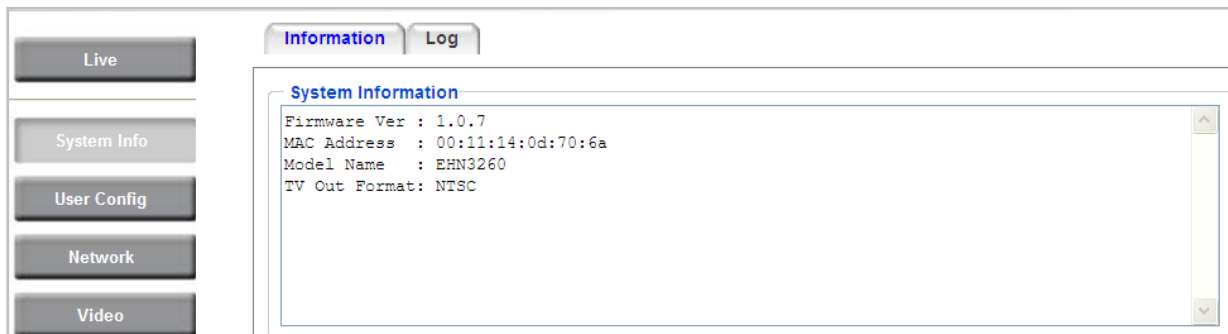

7.1.2 Log

Click the Log tab, the following dialog box appears. The sequence number, date, time and event messages of the log event will be displayed in the System Log field. The log will display the last 256 log events. Click the Export button to export the system log event list into a “.txt” file and select the location where the exported log file will be saved to.

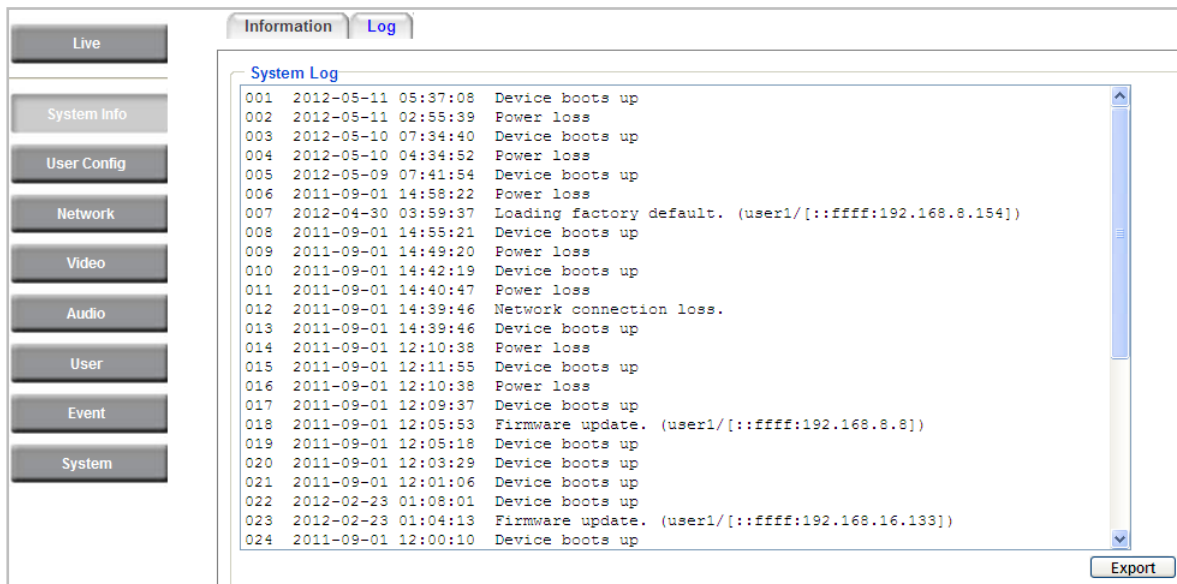

7.2 User Config

Each user can set a different configuration for his/her Live page here. These settings will be applied to the logged-in user’s Live page every time he/she logs in.

7.2.1 Live View Config

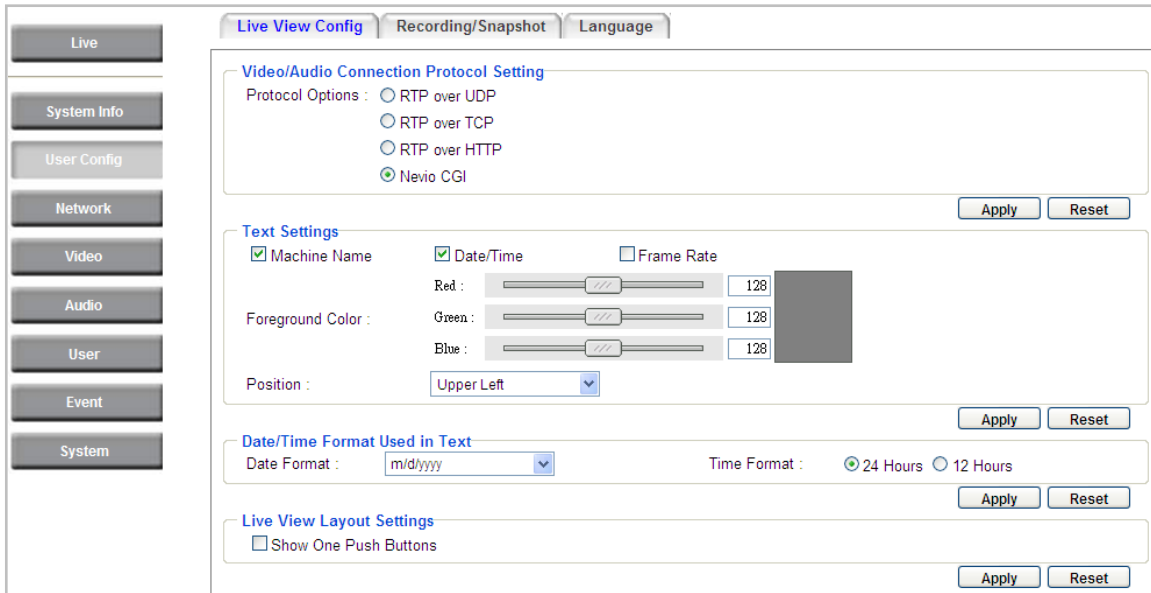

【Video/Audio Connection Protocol Setting】 You can transmit the data stream from the IP cameras using the RTSP (Real Time Streaming Protocol) on the network. The RTSP is a protocol that allows you to access video streams by using the compatible media players. Click **Apply** to apply the changes or **Reset** to reset without saving the changes.

- **RTP over UDP:** The RTSP protocol uses UDP for camera data stream transmission.
- **RTP over TCP:** The RTSP protocol uses TCP for camera data stream transmission.
- **RTP over HTTP:** The RTSP protocol uses HTTP for camera data stream transmission.
- **Nevio CGI:** This is EverFocus’ protocol designed for EverFocus’ IP devices. Select this protocol for camera data stream transmission.

【Text Settings】 Check the box of each option (**Machine name, Date/Time, Frame Rate**) to display this info on the Live View Page.

Foreground Color: Slide the Red, Green and Blue bars to create your preferred text color for the info text line.



Position: Select the position where the text will be displayed. Choose from Upper Left / Lower Right / Lower Left.

Click **Apply** to apply the changes or **Reset** to reset without saving the changes.

【Date/Time Format Used in Text】 Click the dropdown menu to select **date/time format** from the listed options. Click on the desired hour format. Click **Apply** to apply the setting changes or **Reset** to reset without saving the change.

【Live View Layout Settings】 Check the “Show One Push Buttons” boxes if you want to display the show these buttons on the Live View Window. Uncheck these boxes to hide these buttons. This function is only available for EHN3160 Plus / 3260 Plus.

7.2.2 Recording/Snapshot

This configures where your **Record Button** and **Snapshot Button** ( ) files will be saved if you click one of these buttons. Selectable folders will be on the computer only, not on the on-camera SD card.

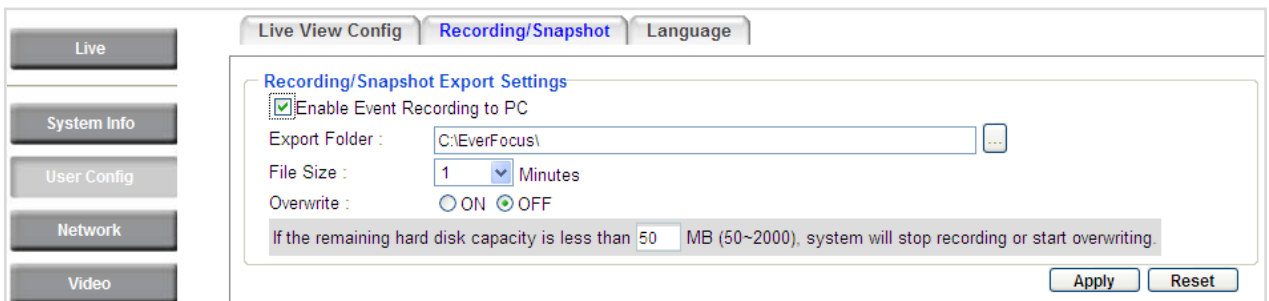

【Recording / Snapshot Export Settings】

Enable Event Recording to PC: Checking this box will let the system save **Record/Snapshot Button** recordings to the folder configured below on the user’s PC.

Export Folder: Select the Export folder for the action above by clicking on the browse (...) button, and then select the desired folder.

File size: The user can limit the size of each recorded file here (in minutes). When a single recording file exceeds the time you set, the system will create a new file to save that data to.

Overwrite: Select “ON” for overwriting recording/snapshot file when the disk storage capacity is full. The user can set the storage capacity limitation in the in-sentence field in the gray box below the Overwrite setting: “If the remaining hard disk capacity is less than ____ MB (50~2000), system will stop recording or start overwriting. “

Click **Apply** to apply the setting changes or **Reset** to reset without saving the changes.

7.2.3 Language

Select the language to be displayed on the Web interface of the IP camera. The default language is English.

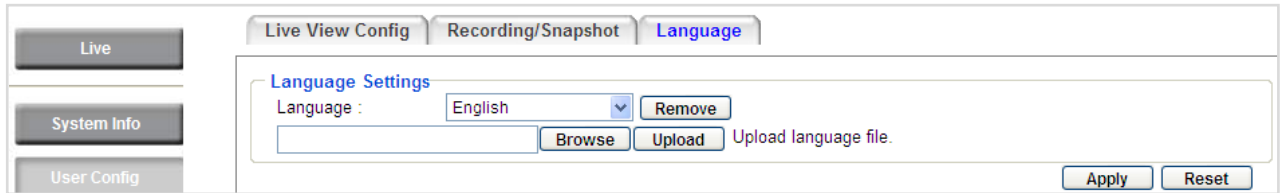

To add a new language not listed in the current Language list, click the **Browse** button to locate the new language file (.evb) on your computer and then click the **Upload** button. Updated language files might be available on the manufacturer’s website. Contact your vendor if required.

Click **Apply** to apply any changes or **Reset** to reset without saving the changes.

Note: Uploading a new language file will cause the system to reboot automatically. Please create a new network connection to the IP camera when the reboot is complete.

7.3 Network

This page covers network-related settings, including Network, DDNS, SMTP/FTP, HTTPS, SNMP, and Network Alarm.

7.3.1 Network

The following information is required to configure the network settings. Contact your network administrator or your internet service provider to get the info.

The screenshot shows the Network configuration page with the following details:

- IP Settings:**
 - IP Type: DHCP (dropdown)
 - IP Address: 192.168.12.118
 - Subnet Mask: 255.255.255.0
 - Gateway: 192.168.12.1
 - Primary DNS: 192.168.10.188
 - Secondary DNS: 192.168.10.189
 - Username: (empty)
 - Password: (empty)
 - IPv6:
 - IP Address: (empty) / (empty)
 - Gateway: (empty)
 - Primary DNS: (empty)
- Port Settings:**
 - HTTP Port: 80
 - HTTPS Port: 443
 - RTSP Port: 554
- Multicast Settings:**
 - Enable Multicast:
 - Multicast IP: 239.238.144.162
 - Port: 50000
 - Time to Live: 5

【IP Settings】

IP Type: Refer to the network administrator for these settings of the server. **Default:** DHCP

- **DHCP:** This setting lets the system use an automatically assigned (dynamic) IP address. This address can change under certain circumstances. For instance, when the camera's network switch/hub has to be rebooted. Do not assign to the DHCP server the same IP addresses used for the other network cameras and PCs with unique IP addresses.
- **Static IP:** The user can manually set the Static IP address. This type of address is stable and cannot change, but the user has to make sure there are no address conflicts with other network-connected devices.
- **PPPoE:** This is a DSL-connection application. The ISP will ask the user to input a username and password. Contact your ISP for these details.

Note: If PPPoE is selected as the IP type, the supplied IP Utility program will not be able to detect the device.

IP address: When DHCP is not used, the user needs to manually enter the IP address of the camera. Do not enter an IP address that is already used for your computer or other network cameras.

Subnet Mask: This field is used to set the subnet mask for your network, so that the IP camera will be recognized within the network. Example: 255.255.255.0. When DHCP is selected, the DHCP server will assign this value automatically.

Gateway: This field is used to set the gateway for your network so that the IP camera will be recognized within the network. When DHCP is selected, the DHCP server will assign this value automatically.

Primary DNS: Enter the IP address of the DNS server if this is provided by an ISP.

Secondary DNS: If your ISP provided you with a secondary DNS address, please enter it here.

Username: Enter the account's username (used only for PPPoE).

Password: Used only for PPPoE.

IPv6: Enter the IPv6 details in this area, if this applies to your system.

Click **Apply** to apply the setting changes or **Reset** to reset without saving the change.

【Port Settings】 Enter the HTTP, HTTPS and RTSP port numbers and click **Apply** to save.

【Multicast Settings】 Enable if required, fill in the setting options and click **Apply** to save.

7.3.2 DDNS

DDNS (Dynamic Domain Name System) is a service used to map a domain name to the dynamic IP address of a network device. You can set up the DDNS service for remote access to the IP camera.

DDNS assigns a domain name (URL) to the IP camera, so that the user does not need to go through the trouble of checking if the IP address assigned by DHCP Server has changed. Once the IP is changed, the IP camera will automatically update the information to the DDNS to ensure it is always available for remote access.

Before enabling the following DDNS function, user should have applied for a host name from the DDS service provider’s website. We support these four DDNS server providers: www.everfocusddns.com, www.sitelutions.com, www.dyndns.com, and www.no-ip.com

Note: We highly recommend that you use xxxx.everfocusddns.com for the simplicity of setting up your IP cameras.

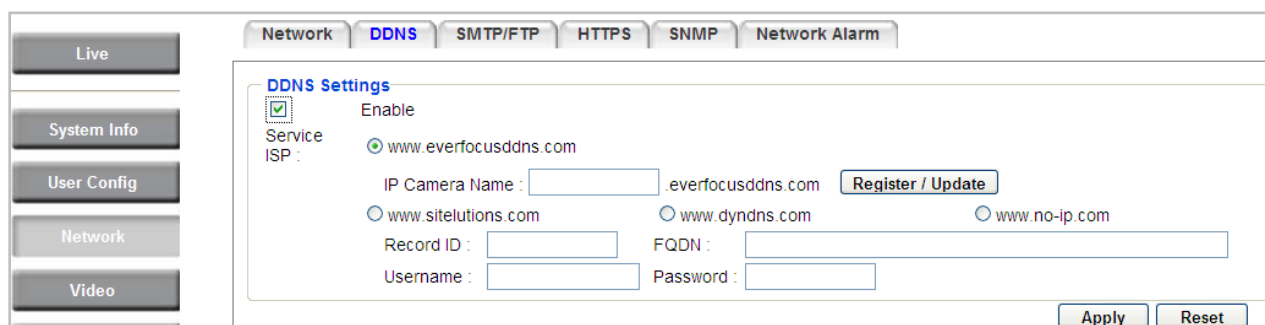

【DDNS Settings】

Enable: Check this box to enable the DDNS function.

Service ISP: You can either apply for a host name from **EverFocus** or **other DDNS server providers**. If you choose the EverFocus DDNS server, you can obtain a free host name from EverFocus.

- **From EverFocus:** To obtain a free host name from EverFocus, type a desired host name in the textbox, click the **Register / Update** button, and then click the **Apply** button.
- **From other DDNS server providers:** To obtain a domain name from one of the three DDNS server providers, you have to register your name with the provider first, and then select the provider and fill in the required information. Please refer to the specific DDNS company’s website for further information.

Record ID: Type the record ID if provided by the DDNS server provider.

FQDN: Type the fully qualified domain name applied from the DDNS server provider. For example, xxxx.dyndns.com

Username / Password: Type the login account of your DDNS server provider.

Click **Apply** to apply the setting changes or **Reset** to reset without saving the changes.

Note:

1. In order to support the full functionality of the camera, you must open the port numbers (80, 554, 443) on the router for remote access to the IP camera. This function is available on most routers in the market and is often known as “Port Forwarding”. To set up Port Forwarding, please consult the manual of the router.
2. In certain router models, it is possible that you will not be able to access the camera using DDNS while inside the router’s network. Please try using a PC located outside of your router’s network.

Default Ports on all EverFocus IP cameras:

HTTP: 80

RTSP: 554

HTTPS: 443

7.3.3 SMTP / FTP

【Set SMTP Server (email)】 This area is for configuring the mail server that is used to send e-mail notifications from the camera to predefined addresses via SMTP. Note that to enable e-mail notification function, you have to check the **Send Mail Notification** item on the Event dialog box (see 7.7.1 Event Settings).

SMTP Server: Enter the IP address or the host name of the SMTP server used to send e-mails.

SMTP Port: Enter the port number for SMTP. The default is 25.

Authentication: Check this box if the SMTP server requires authentication (user/password).

User name: Input the user’s login ID if the SMTP server requires authentication.

Password: Input the user’s login password if the SMTP server requires authentication.

Receiver Address: Input the e-mail addresses for receiving an e-mail message when an EVENT is enabled and triggered. Please use “;” to separate multiple addresses.

Sender Address: Input the sender’s e-mail address, so that the receiver can recognize the sender when an Event message is received.

Attach Image: Check this box if you want to attach an image when an alarm is triggered or an IP camera detects events.

Send Test Email: Click the **Test** button to send a testing email to the assigned address.

Click **Apply** to apply the setting changes or **Reset** to reset without saving the changes.

【Set FTP Server】 The settings relating to the FTP server used to transmit the alarm images can be configured here. Note that to enable uploading images to the FTP server function, you have to check the **Upload to FTP** item on the Event dialog box (see 7.7.1 Event Settings).

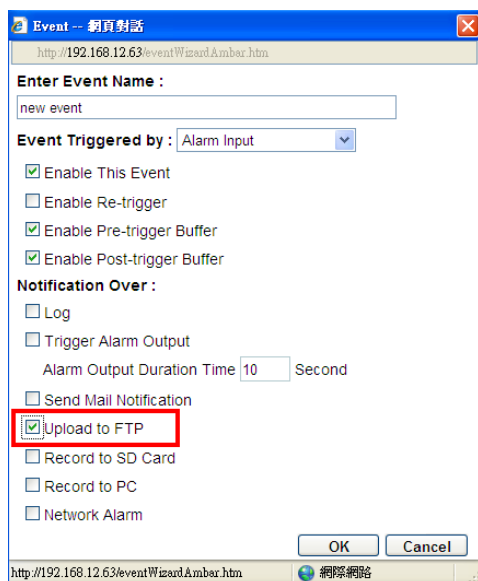

FTP Server: Enter the IP address or the host name of the FTP server.

FTP Port: Enter the port number for the FTP server. Default is 21.

Recording Path: Assign the recording path.

User Name: Set FTP User’s name.

Password: Set FTP password.

PASV mode: Check to enable Passive mode. Passive mode is normally enabled. If a connection cannot be established, uncheck "PASV Mode".

Test FTP Server: Click the **Test** button to send a testing file to the assigned FTP server.

Click **Apply** to apply the setting changes or **Reset** to reset without saving the changes.

7.3.4 HTTPS

Hypertext Transfer Protocol Secure (HTTPS) is a combination of the Hypertext Transfer Protocol and the SSL/TLS protocol and provides encrypted communication and secure identification of a network web server.

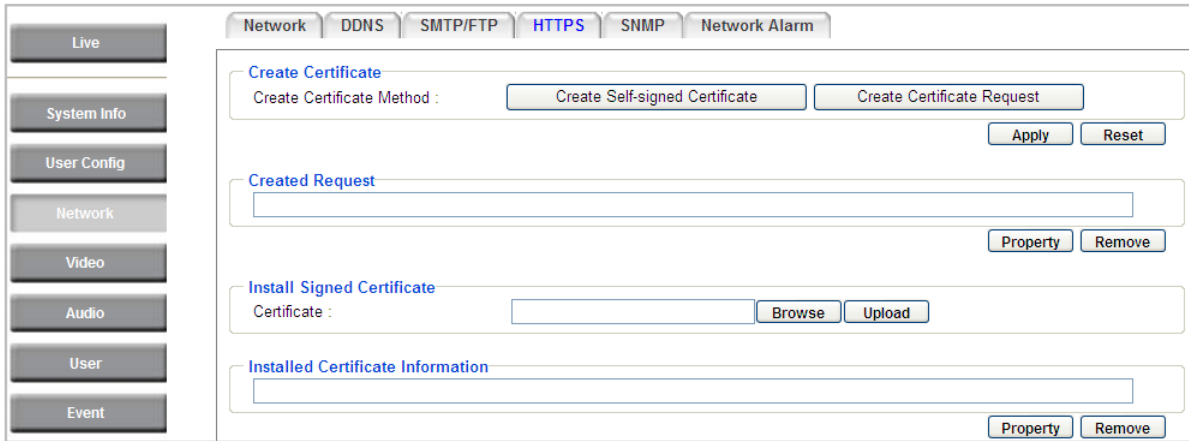

Before using the HTTPS function for communication with the IP camera, a Certificate must be created first. There are two ways to create and install a certificate: **Create Self-Signed Certificate** and **Create Certificate Request**.

Create Self-Signed Certificate

Please note that even though self-signed certificates are free and offer some protection, true security is only implemented after the installation of a signed certificate issued by a certificate authority.

1. Click the **Create Self-Signed Certificate** button, the following dialog appears.



2. Type the required Certificate information and then click the **Apply** button. The subject line will be displayed in the Installed Certificate Information field.

Installed Certificate Information

C=TW,ST=Taipei,L=Taipei,O=EF,OU=SPD,CN=EF-SPD

3. Click the **Property** button, a pop-up window appears to display the details of the certificate.

HTTP -- 網頁對話

http://192.168.12.95/networkHttpWizard.htm

Validity

Not Valid Before :

Not Valid After :

Subject :

Certificated (PEM format)

```

-----BEGIN RSA PRIVATE KEY-----
MIICXQIBAAKBgQDwiyuqZfWImh8O+Ado9z1zrP0tL7ND7C1od8xx4NjnGffwbeRR
007Lo6x2OEgQLO4QxByjddKYzwlh8xTqGUiM+inziCLO2Fq4sndG868KOaEc48Rv
z41nehTnmU6Y90iDv0CiZG6JsvBeUqIxuIGXSPne15R1wZ7GnZQ7Gw/7QIDAQAB
AoGAElKOZx4QDawEjQW3tEow2OUz214FhES99tMMPP4D6DC6kQkBJ881JaUTzIDf
/qmnpzzn2x1r3+sG7I+TAK8picQm/zj4TVS31M3h6oRLH3jPIeLEn+spkojE2p4W
neWBGiYnN3VOMaXXdCWJxnHn/vPKu1/jvg6ZveFKhJPYqs0CQQDtr2d0ut2ajq13
A44Wyn/yOkSooQwDlEmfXpYwhf+y+xkmgEt0f2tUaHDyFelw/JlmpQKKIao7+rXk
ykZcraQXAKEA5xNGU2S6FFmeSgZtnO1Ppo536OB11xtSh6cyVG41m8CByfkCgkXi
8gLxhSAVZubPWGQvDoNS1gMx+Z1LW1EOGwJBAMASXqgV2b5eTgE+/jOrYE1+iL08
Z1j9HAGNjhdOEmKkGhshI0+c55+p8b5rGuAFPa9oa++RLLzhsm8K9/490ECQFg6
XMy01fP1NTqfHxS264Wduhz5qPBkU0PSS/4+wktA2o2CfTm+c2OSS1Q7YICUujB2
uBzjeXprZ+Z0aHhQX2oCQQCTnB2TlhG5Er+MdQ5fP976wRmLs5RWqrVFNbCv+HzC
zIjGpenv63FGz5THVZ89i2QN8IIj4ISN1C9Fg7sVK4/t
-----END RSA PRIVATE KEY-----
-----BEGIN CERTIFICATE-----
MIIDezCCAuSgAwIBAgIUAkoc7T1uM/5dMA0GCsGqGSIB3DQEBBQUAMIGMMQswCQYD
VQQGEwJUVzEPMA0GA1UECBMGVGFpcGVPMQ8wDQYDVQQHEwZUYWlwZWkxZjBjZjBj
BAoTAKVGMQswCgYDVQQLEwNTUEQxZDZANBgNVBAMTBkVGLVNVQRDEpMCCGCSqGSIb3
DQEJARYaZWY2dGZpcGVPQVZ2ZXJmb2N1cy5jb20udHcwHhcNMTIwOTIyMDYyMTEw
-----END CERTIFICATE-----
    
```

4. To optionally create and install other certificates, remove the existing one by clicking the **Remove** button to erase the certificate.
5. On the Web page, change the address from “http://” to <https://> in the address bar and press Enter on the keyboard. Some Security Alert dialogs will pop up. Click **OK** or **Yes** to enable HTTPS.

Create Certificate Request

You can apply for an official certificate from an issuing Certificate Authority.

1. Click the **Create Certificate Request** button, the following dialog appears.

Create Certificate

Create Certificate Method :

Country Name :

State or Province Name :

Locality Name :

Organization Name :

Organization Unit Name :

Common Name :

Email Address :

Validity : days

2. Type the required Certificate information and then click the **Apply** button. The subject line will be displayed in the Created Request field

Created Request

C=TW,ST=Taipei,L=TPE,O=EF,OU=EF,CN=EF

3. Click the **Property** button, a pop-up window appears to display the details of the certificate.



4. To optionally create and install other certificates or request, remove the existing one by clicking the **Remove** button to erase the certificate or request.
5. Copy the contents of the Certificate request (in PEM format) and paste it to the certificate request field on the Web page of the 3rd-party certification authority such as Symantec VeriSign. Wait for the certificate authority to issue an SSL/TLS certificate and then download the issued certificate on your computer.
6. In the Install Signed Certificate field, click the **Browse** button to search for the issued certificate, and then click the **Upload** button to import the certificate. Once the certificate has been uploaded, this field will show the subject line of the certificate.

7.3.5 SNMP

The default values for SNMP v1/v2/v2c and SNMP v3 are already filled in. Click either of the Enable buttons to enable either of the two. Make your changes as desired. Click on the Trap Address field to enter the digits, if required.

The screenshot shows the 'Set SNMP Server' configuration page. It features a sidebar with navigation buttons: Live, System Info, User Config, Network, Video, Audio, User, Event, and System. The main content area has tabs for Network, DDNS, SMTP/FTP, HTTPS, SNMP, and Network Alarm. Under the 'Set SNMP Server' heading, there are two sections: 'Enable SNMP v1/v2/v2c' and 'Enable SNMP v3'. The v1/v2/v2c section includes fields for Read-Only Community (public), Read-Write Community (private), Trap Community (efipcam), and Trap Address (0.0.0.0). The v3 section includes fields for Read-Only Username (efsnmpuser), Read-Only Auth. Method (MD5), Read-Only Auth. Key (masked), Read-Only Privacy Method (none), Read-Only Privacy Key (empty), Read-Write Username (efsnmpadmin), Read-Write Auth. Method (MD5), Read-Write Auth. Key (masked), Read-Write Privacy Method (DES), and Read-Write Privacy Key (masked). 'Apply' and 'Reset' buttons are at the bottom right.

7.3.6 Network Alarm

This function works with EverFocus’s CMS software, e.g. the PowerCon or the Power Video Plus. For the setting details, please refer to the CMS network alarm protocol.

The screenshot shows the 'Set Network Alarm' configuration page. It features the same sidebar as the previous screenshot. The main content area has tabs for Network, DDNS, SMTP/FTP, HTTPS, SNMP, and Network Alarm. Under the 'Set Network Alarm' heading, there are fields for Protocol (UDP), Port No (1600), Unique ID (000000001), and three Server IP address fields (Server 1, Server 2, Server 3), all set to 0.0.0.0. 'Apply' and 'Reset' buttons are at the bottom right.

7.4 Video

The settings relating to video such as streaming, camera OSD can be configured on this page. The "Video" page has five tabs: Multi-streaming, Camera, Advanced, ROI and Privacy Mask.

7.4.1 Multi Streaming

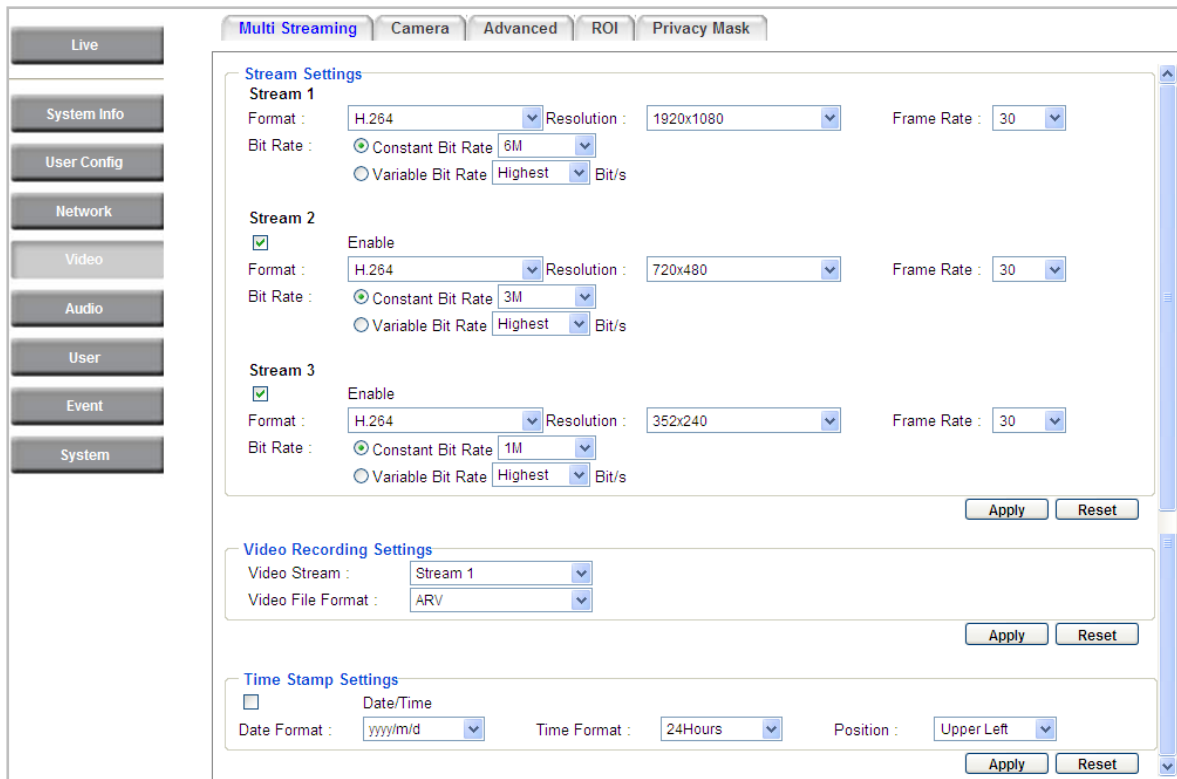

【Stream Settings】 This IP camera can output three video streams simultaneously. For each of these streams, the user can set the compression format, resolution, bit rate, and frame rate individually. Stream 1 is always enabled for live view. To enable Stream 2 and/or Stream 3, check the “Enable” box the header of each stream.

Note: If you connect to the camera via the Internet and experience a delay (lag time) in the video feed, try to reduce the number of streams and the quality and resolution of the streams – but keep the frame rate at its maximum.

Format: Select the encoding format – H.264 or MJPEG.

Resolution: Select the most suitable resolution for your needs.

Frame Rate: Select from 1 to 30 fps.

Bit Rate: If required, select whether you want the stream to stream a **Constant Bit Rate** or a **Variable Bit Rate**, and set the values of whichever option you choose.

Click **Apply** to apply the setting changes or **Reset** to reset without saving the changes.

【Video Recording Settings】 Select the stream you want to configure and then select whether you want the recording files of that stream to be saved in AVI or ARV format. Click **Apply** to apply the setting changes or **Reset** to reset without saving the changes.

【Time Stamp Settings】 You can select the Date/Time format, position, and add the setting to the streaming.

Click **Apply** to apply the changes, or **Reset** to reset without saving the changes.

7.4.2 Camera

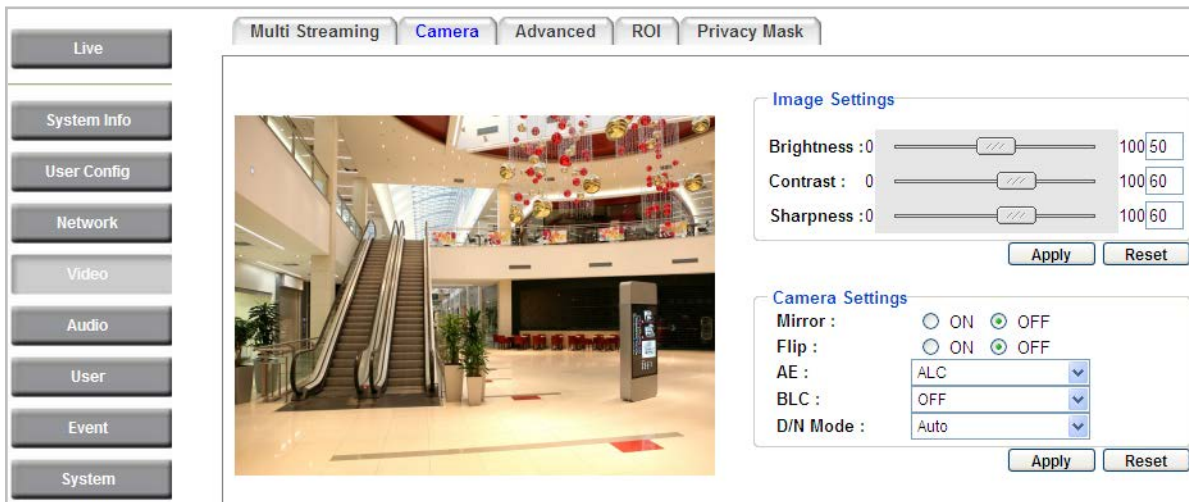

【Image Settings】 Set the Brightness, Saturation, Contrast or Sharpness of the image. Click **Apply** to apply the changes, or **Reset** to reset without saving the changes.

【Camera Settings】

Mirror: Switch Mirror ON to rotate the image horizontally around a vertical axis.

Flip: Switch Flip ON to rotate the image vertically around a horizontal axis.

AE: There are two options:

- **ALC:** Selecting Automatic Light Control allows the camera circuitry to either take bright spots more into consideration (peak), bringing out detail in bright areas, or less into consideration (average) bringing out detail in shadows.
- **AES:** Selecting Auto Electronic Shutter disables the Shutter setting below this setting. In this mode, the camera measures the light level and decides whether it needs more or less light and then automatically adjusts the shutter speed accordingly.

BLC: Back Light Compensation (BLC) is used to make the subject appear clearer when it is set against a bright background.

- **OFF:** Select to switch Back Light Compensation functions off.
- **(ON)BLC:** The BLC can increase the exposure of a dark area surrounded by a brighter area, HLC can decrease the exposure of bright areas surrounded by darker areas. This enables the camera to better display information that would otherwise have been “whited out”, like a license plate between two bright headlights on a dark road.
- **(ON)HLC:** The Highlight-Suppression BLC is used to reduce the brightness of light sources in a specific area. It is activated only in a low illumination environment to minimize the effects of glare from bright lights such as spotlights, street lights or headlights in the field of view.

WDR: The **Wide Dynamic Range (WDR)** function provides clearer images when both of the very bright and dark areas simultaneously appear on the camera view. There are four value options: OFF, Low, Middle and High. Note that when WDR is ON, some parts of the image may appear solarized. This is normal for WDR, and is not a camera malfunction. This function is only available for EHN3160 Plus / 3260 Plus.

D/N Mode

- **Auto:** Select to let the camera automatically switch to Night mode (black and white) when the light levels fall to a specified level, and back to Day mode (color) when the light levels rise to a specified level.
- **Day:** Select to keep the camera in Day mode (color), even in nighttime.
- **Night:** Select to keep the camera in Night mode (black and white), even in daytime.

7.4.3 Advanced

Multi Streaming
Camera
Advanced
ROI
Privacy Mask

Live

System Info

User Config

Network

Video

Audio

User

Event

System



Camera Settings

Exposure Settings (AE)

Mode : ALC

IRIS : 0 100 20

Shutter : 1/60

AGC : Middle

Slow Shutter : OFF

Brightness : 0 100 50

WDR : OFF

Visibility Enhancement : OFF

BLC Settings

Mode : OFF

Noise Reduction Settings

2D DNR : OFF

3D DNR : ON

3D Start AGC : 0 100 10

3D End AGC : 0 100 5

3D Level : 0 100 26

Smart NR : ON

White Balance Settings

Mode : Auto Push

Red : 0 100 50

Blue : 0 100 50

Day/Night Settings

Mode : Auto

IR Smart Settings

Mode : ON

Level : 0 100 8

Mirror : OFF

Flip : OFF

Negative : OFF

Sharpness Settings

Level : 0 100 60

Resolution Enhancement : ON

Contrast : 0 100 60

Monitor Settings

Type : LCD

LCD Gamma : Auto

LCD Blue Gain : 0 100 50

LCD Red Gain : 0 100 50

Color Space Standard : YUV709

Apply
Reset

【 Camera Settings 】

Lens (IRIS Control): Select **DC** or **Manual** for IRIS control. This function is only available for EHN3260 Plus.

Exposure Settings (AE): This setting is used to adapt to the amount or type of light used by the camera. The functions vary among models.

Mode:

- **ALC:** Selecting Automatic Light Control to allow the camera circuitry to either take bright spots more into consideration (peak), bringing out detail in bright areas, or less into consideration (average) bringing out detail in shadows.
- **AES:** Selecting Auto Electronic Shutter to enable the Slow Shutter setting below this setting. In this mode, the camera measures the light level and decides whether it needs more or less light and then automatically adjusts the shutter speed accordingly.
- **Manual:** Select this option to manually set up the Shutter (Manual) and AGC (Manual) values.

Iris (P-Iris): Specify the size of the Iris opening here. For P-Iris setting, you have to select **AES** mode and then adjust the Iris level to enable greater depth of field, and improve image sharpness and clarity. The lower the level, the wider the Iris is opened, which allows the camera to receive larger amount of light with shorten depth of field.

Without P-Iris Set Up



The object in the front is vague.

With P-Iris Set Up



Both objects in the front and back are clear.

Shutter: If enabled, this setting lets you set the shutter speed yourself (measured in fractions of a second).

AGC: Set the Auto Gain Control limit here. The lower the AGC level, the lower the video signal and the noise. However, the image will be darker under low-light condition with IR-off if you set up the Iris to the maximum level.

Slow Shutter: This option can be switched on if the Shutter (speed) setting is 1/30. This function is only available for EHN3260 Plus / 3340 Plus.

Flickerless: If the Mode field in the Exposure Settings (AE) area has been set to AES, then this option becomes available. Choose between OFF, 50HZ, 60HZ, 50HZ (High Luminance) or 60HZ (High Luminance). This function is only available for EHN3340 Plus.

EV Setting: Set up the Exposure Value. Note the brightness of the screen changes when you change the EV value. This function is only available for EHN3340 Plus.

AE Response: Set up the Auto Exposure Response time. This function is only available for EHN3340 Plus.

AE Weighting Area: Select an AE Weighting area. Each setup AE Weighting Area is configured with the appropriate brightness level on the center and the surrounding areas. This function is only available for EHN3340 Plus.

Brightness: Set the image brightness here.

AE Reference: Set the Auto Exposure value here. This function is only available for EHN3160 Plus.

Black Level: Set the Black level here. This function is only available for EHN3340 Plus.



WDR: The **Wide Dynamic Range (WDR)** function provides clearer images when both of the very bright and dark areas simultaneously appear on the camera view. There are four value options: OFF, Low, Middle and High. Note that when WDR is ON, some parts of the image may appear solarized. This is normal for WDR, and is not a camera malfunction. This function is only available for EHN3160 Plus / 3260 Plus.

Visibility Enhancement: (OFF/Low/Middle/High) Images in foggy or rain environments or in environments with a very strong luminous intensity have a dynamic range that is significantly lower than ordinary images. The user can use this Visibility Enhancement setting to “DEFOG” the image if such “FOGGING” is an issue. This function is only available for EHN3260 Plus.

BLC Settings: Back Light Compensation (BLC) is used to make the subject appear clearer when it is set against a bright background.

- **OFF:** Select to switch Back Light Compensation functions off.
- **Back Light:** The Back Light function is useful when the background of the subject is very bright and the subject itself is dark. Select Back Light and adjust the slide bar to the left / right for setting up the back light value. The higher the value, the more the backlight compensation.
- **Front Light:** This function is useful when the bright highlights, such as flashlight or car headlights, appear on the camera view. Select Front Light and adjust the slide bar to the left / right for setting up the front light value. The higher the value, the more the highlight compensation.

- **(ON) BLC:** This option is useful when the background of the subject is very bright and the subject itself is dark. The BLC will measure the light of the image center and the lens iris will automatically set for optimal image quality.

For EHN3160 Plus: Select **ON (BLC)**, the  button next to the Mode drop-down list will be active (see image below). Click the  button, the green setup areas appear on the left screen. Click on the areas to enable / disable the BLC function. The selected areas (in green) will be applied with the BLC function.

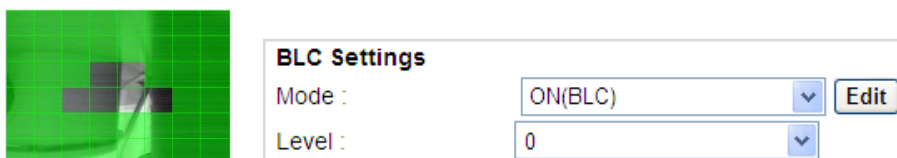

For EHN3260 Plus:

You can configure one area to apply the BLC function. Select **ON (BLC)**, the setup buttons appears (see image below). Select Low / Middle / High from the BLC Gain drop-down list. To set up a BLC area, click the **Edit Area** button and then click on the blue color tab to turn your mouse cursor into a blue pen. Move the cursor to the position on the right screen where you want the BLC rectangle to start and then click. Move your cursor to the position (diagonally opposing corner) where you want the BLC rectangle to end and then click. The blue area will be applied with the BLC function.

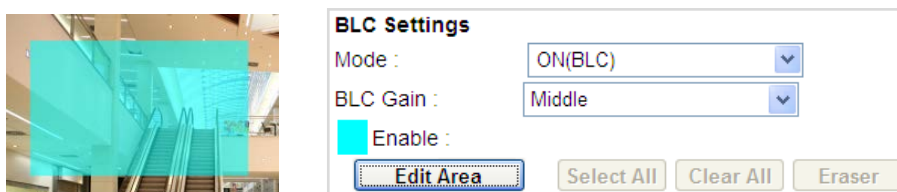

- **(ON) HLC:** This option is only available when you select AES Mode in the Exposure Settings (AE) field. This function is useful when the bright highlights, such as flashlight or car headlights, appear on the camera view. The higher the value, the more the highlight compensation.

For EHN3160 Plus: Select **ON (HLC)**, and then select a level from the drop-down list. The higher the level, the more the highlight compensation.

For EHN3260 Plus:

HLC Level: Select a level for the HLC setting. The higher the level, the more the highlight compensation.

HLC Mode: Select All Day / Night mode to apply the HLC function.

HLC Black Mask: Select On / Off to apply the black mask on the selected areas. The over-exposure portions within the selected areas will be applied with the black mask.

Color Tabs: You can set up four HLC areas with different colors. To set up a HLC area, click the **Edit Area** button and then click on the color tab to turn your mouse cursor into a pen of that color. Move the cursor to the position on the right screen where you want the HLC rectangle to start and then click. Move your cursor to the position (diagonally opposing corner) where you want the HLC rectangle to end and then click. Select ON from the color tab drop-down list. The rectangular area with the selected color will be applied with the HLC function.

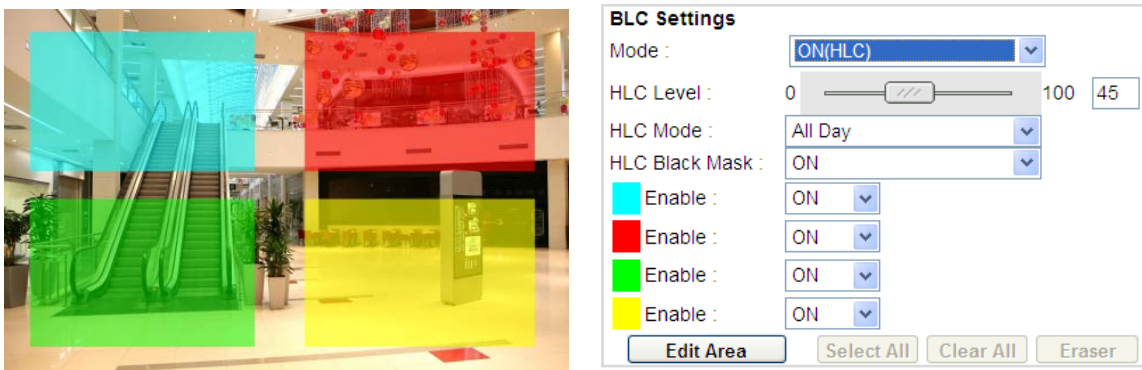

Noise Reduction Settings: This limits the amount of digital “video noise” that is usually found in any video stream, and helps to reduce file size. The higher the level, the more the reduction.

For EHN3160 Plus / 3340 Plus:

Select **ON / OFF** to enable / disable the Noise Reduction function. Or select **Auto** to let the camera automatically enable / disable the Noise Reduction function. Slide the Level bar to set up the level. The higher the level, the more the reduction.

For EHN3260 Plus:

2D DNR: Select ON to enable the 2D DNR function.

3D DNR: Select ON to enable the 3D DNR function. You can further set up the following settings.

- **3D Start AGC:** Set up the AGC level to automatically start the 3D NR function.
- **3D End AGC:** Set up the AGC level to automatically stop the 3D NR function.
- **3D Level:** Set up the 3D DNR level.
- **Smart NR:** Select ON to enable the Smart NR function. The 3D NR function will be automatically turned on when a motion event occurs.

White Balance Settings: Select the mode that delivers the best quality image for the camera's light environment. There are five options: Auto, Manual, Indoor, Outdoor, One Push.

- **Auto:** Select to let the camera automatically adjust the White Balance. In the Auto mode the camera computes the white balance value output using color information from the entire screen. It outputs the proper value using the color temperature radiating from a black subject based on a range of value from 3000 to 7500K.
- **Manual:** Select to adjust the Red and Blue values yourself in the fields below this field.
- **One Push:** Select to enable the **Push** button next to the Mode drop-down field. This will allow you to force the camera to readjust the white balance every time you push the **Push** button. The lens will hold the same focal position until the next trigger command is received. This function helps to prevent incorrect focusing in dark environments. This function is only available for EHN3160 Plus / 3260 Plus.
- **Manual Temperature:** Select to use the optimized Red and Blue settings. You can also optionally adjust the Manual Level below this field for setting up the color temperature. The higher the value, the more the color temperature. This function is only available for EHN3340 Plus.

Day/Night Settings:

- **Auto:** Select to let the camera automatically switch to Night mode (black and white) when the light levels fall to a specified level, and back to Day mode (color) when the light levels rise to a specified level.
- **Day:** Select to keep the camera in Day mode (color), even in nighttime.
- **Night:** Select to keep the camera in Night mode (black and white), even in daytime.

IR Smart Settings: Select ON and set up the level to enhance the image quality when the images are over exposure. This function is useful when the camera is in the Night mode. This function is only available for EHN3260 Plus.

Saturation: Set the saturation value. This function is only available for EHN3160 Plus.

Mirror: Switch Mirror ON to rotate the image horizontally around a vertical axis.

Flip: Switch Flip ON to rotate the image vertically around a horizontal axis.

Negative: Switch this setting ON to view a color negative version of the video image. This is useful at night or when viewing temperature-sensitive images.

Monitor Type: Select a gamma value from Set 1, Set 2 or Set 3. This function is only available for EHN3160 Plus.

Sharpness Settings: Select the sharpness level of the image. A low sharpness level will deliver a softer, less detailed image. A high level will deliver a sharp, highly detailed image. Switch Resolution Enhancement ON to enable the resolution enhancement function.

(Auto) Contrast: Select the contrast level of the image.

Suppress Function: This function is only available for EHN3340 Plus.

Aperture Compensation Suppression: (OFF/Low/Middle/High) This setting can be activated to suppress luminance noise when the AGC level increases.

Chroma Suppression: (OFF/Low/Middle/High) This setting can be activated to suppress chrominance noise when the AGC level increases.

Ygamma: (gamma 2.2/standard/contrast enhance/high light range mode L/High light range mode H). Select the Ygamma value for the video quality of the monitor. This function is only available for EHN3340 Plus.

Monitor Settings: For EHN3160 Plus, select a gamma value from Set 1, Set 2 or Set 3. For EHN3260 Plus, user can use this field to optimize video quality for his or her specific type of monitor – LCD or CRT.

Color Space Standard: The options are YUV601 for SD and YUV709 for HD. These define the color space standard required to convert an RGB picture to a YUV picture. Generally, YUV601 is used for Standard Definition (720P) devices and the YUV709 is used for High Definition (1080P) devices.

Click **Apply** to save all changes. Click **Reset** to cancel all changes.

7.4.4 ROI (Region of Interest)

The Region of Interest (ROI) function allows users to set up multiple regions within an image with better quality and less distortion than the rest of the image. You can use this function together with the Digital Zoom function on the Live View Page to get a better image result. Up to eight ROIs can be configured in the ROI settings page.

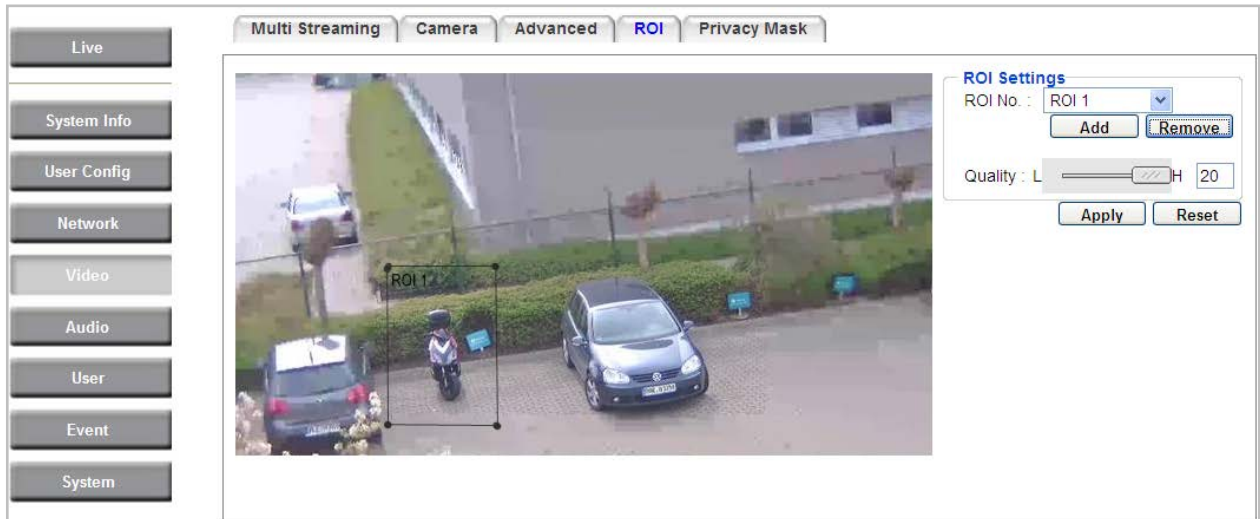

To set up an ROI region:

1. Select an ROI number from the ROI No. drop-down list.
2. Click the **Add** button, the mouse cursor will turn into a pen when you move it over the live image on the left.
3. Move the cursor to the position where you want the ROI rectangle to start and then click. Move the cursor to the position (diagonally opposing corner) where you want the ROI rectangle to end and then click.
4. Slide the Quality bar to set up the quality value.
5. Click the **Apply** button to apply the settings, or click the **Reset** button to reset without saving the settings.

7.4.5 Privacy Mask

The Privacy Mask can block out sensitive areas from view, covering the areas with colored or black and white boxes in both live view and recorded clips. This feature is useful when users' don't want the sensitive information visible. Up to four Privacy Masks can be configured.

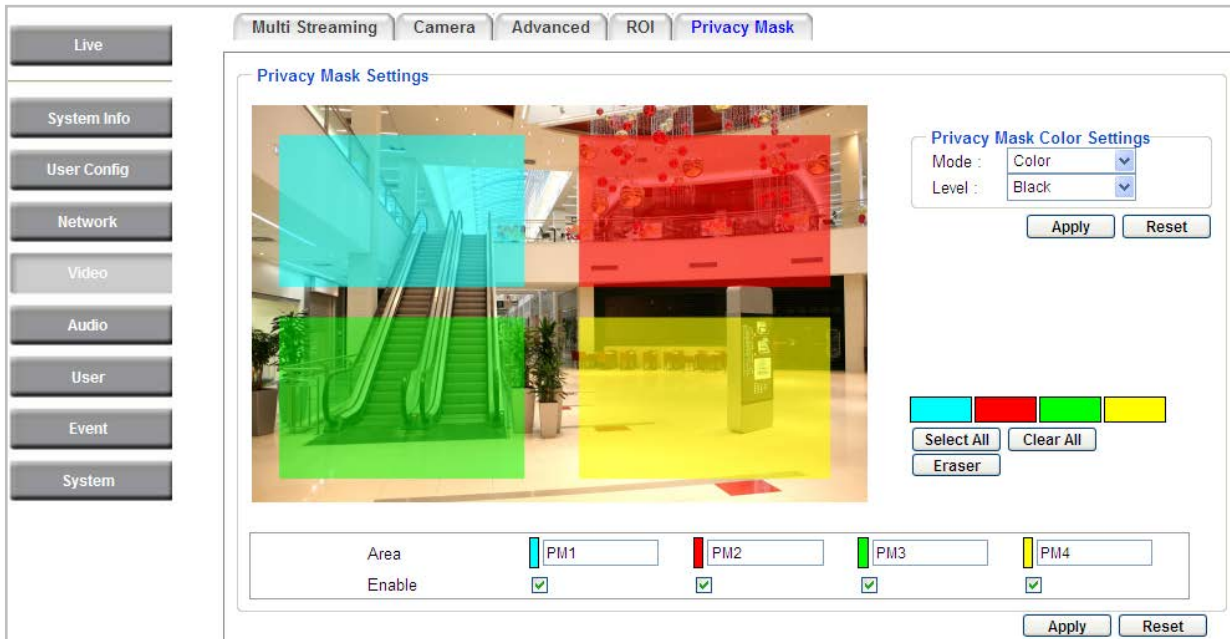

【 Privacy Mask Color Settings 】 The modes vary among camera models.

Mode: Click **Color** to make the masks appear as colored rectangles on the screen. Click **B/W** to make the masks appear as gray rectangles on the screen. Click **Mosaic** to make the masks appear as mosaic-effect rectangles on the screen.

Level: Select the color of the masks if you selected Color Mode. Select the level of grayness of the masks if you selected B/W Mode. Select the level of small/middle/large if you selected Mosaic Mode.

Click **Apply** to apply the settings, or click **Reset** to reset without saving the settings.

Color Tabs : Click on a color tab to turn your mouse cursor into a pen of that color. You can now create a block of that color on the video screen. Move your cursor to the position where you want your mask rectangle to start and then click. Move your cursor to the position (diagonally opposing corner) where you want your mask rectangle to end and then click. The rectangular area with the selected color will appear. The live image will display the rectangular area with the color you selected. If you want to create another mask, use one of the other three colors. Each color denotes a different mask area. Only one block per color is allowed. As the number of colors suggests, you can configure up to four blocks.

Select All: Click to turn the whole screen into a mask area.

Clear All: Click to delete all configured mask blocks.

Eraser: Click to turn the mouse cursor into an eraser to delete any block you click on.

Area: Shows the color and number of the block.

Enable: Check this box to enable the related mask block.

Click **Apply** to apply the changes, or click **Reset** to reset without saving the changes.

7.5 Audio

The EHN Plus series IP camera can transmit audio to your computer if you have connected an external microphone to its audio Input cable. It can also receive audio input from you and transmit it via an external speaker, if you have connected such a speaker to its audio Output cable.

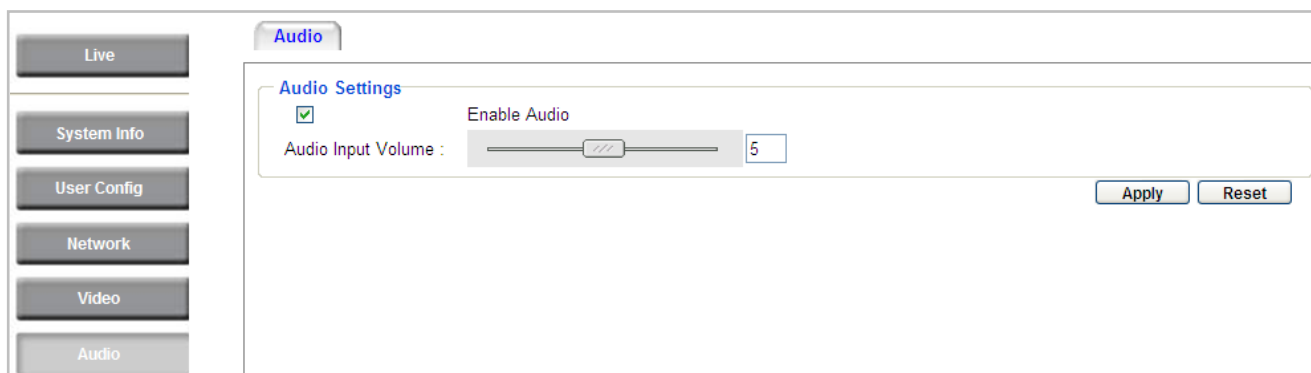

Check the Enable Audio box to enable the camera’s audio function. The camera will now act as a digital bridge (via the IP network) between any connected audio input device and any connected audio device.

Adjust the Audio Input Volume if you have external audio input devices (microphones) connected to the camera and if there are problems with the sound input being too low or high.

Click **Apply** to save all settings, or click **Reset** to cancel.

7.6 User

7.6.1 User Information

The system administrator can create up to ten user accounts on this page.

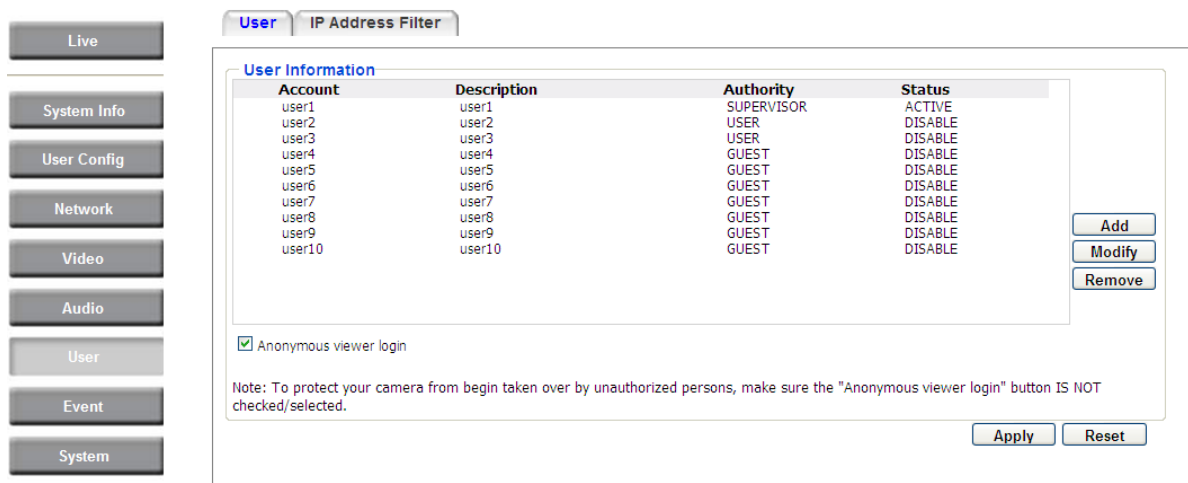

To set up a user account:

1. Highlight a user account and click the **Modify** button. The following dialog box appears.

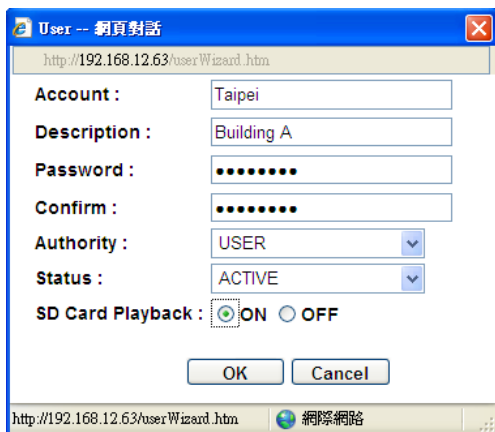

2. Type the account name, account description and password for the account. Type the password again in the Confirm field.
3. Select an authority level for the user account from the Authority drop-down list.
 - **Supervisor / Administrator:** The only difference between a supervisor and administrator is that a supervisor can edit an administrator’s account and password, but an administrator cannot edit the supervisor’s account and password. Multiple administrators can be configured, but there can be only one supervisor. The supervisor and administrators all have unrestricted access to the Settings submenus and can determine the registration of all other users.

- **User:** A user can view the Live View page and view the system, network, video, and audio information. A user can only adjust the User Config page settings. The user does not have access to the User, Event and System pages.
 - **Guest:** The lowest level of access, which only allows the user access to the Live View page.
4. Select **Active** or **Disable** from the Status drop-down list to active or disable the user account.
 5. Click **On** in the SD Card Playback field to allow the user to access the SD card playback function.
 6. Click **OK**.
 7. Click **Apply** to save all the settings.

7.6.2 IP Address Filter

Use this page to specify IP addresses that are not allowed to access this camera. By default, any IP address can access the camera.

Note: The Allowed List addresses only become relevant when the Denied List contains a network or range, and the supervisor wants to allow one or more IP addresses within that excluded range or network. In such a scenario, the user would enter the excluded range or network in the Denied List, and enter the exceptions in the Allowed List.

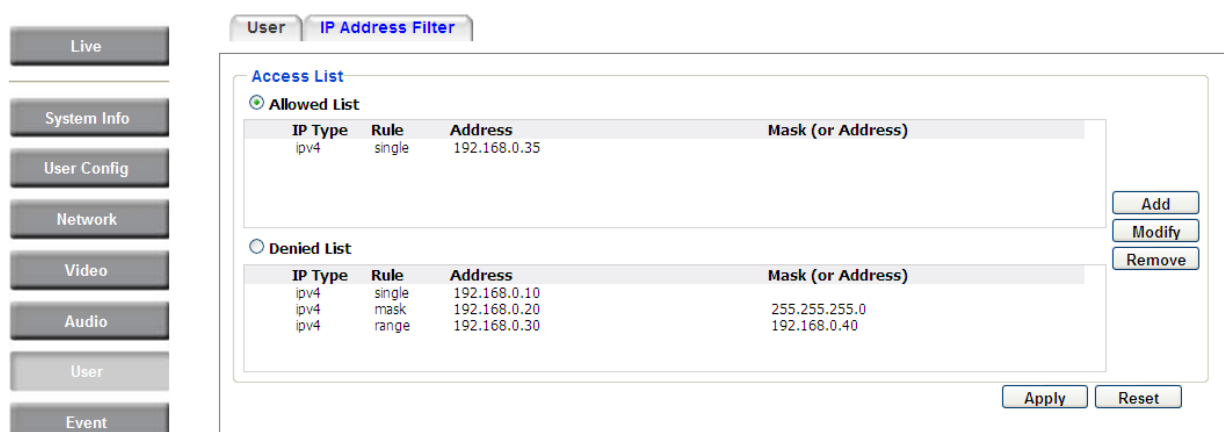

To set up the IP Address Filter:

1. Select Denied List. Click the Add button, the following dialog box appears.



2. Select an IP type from the IP Type drop-down list.
3. Select a network rule from the Rule drop-down list, type the IP address and click **OK**.
 - Single:** Type a single IP address in the IP Address field below.
 - Network:** Type the IP address and subnet mask in the field below.
 - Range:** Type a range for the IP addresses.
4. If you have set up an IP range in **Step 3**, you can optionally set up the Allowed List to allow one or more IP addresses within the setup IP range to access the IP camera.
5. Click **Apply**.

7.7 Event

You can set up the Motion Detection event, Tamper Detection event or the Alarm I/O to automatically notify the users when an event occurs or an alarm is triggered. You can also set up a schedule to automatically record the videos when an event occurs or an alarm is triggered.

7.7.1 Event Settings

You can create a total of ten event or alarm settings page in the Event List

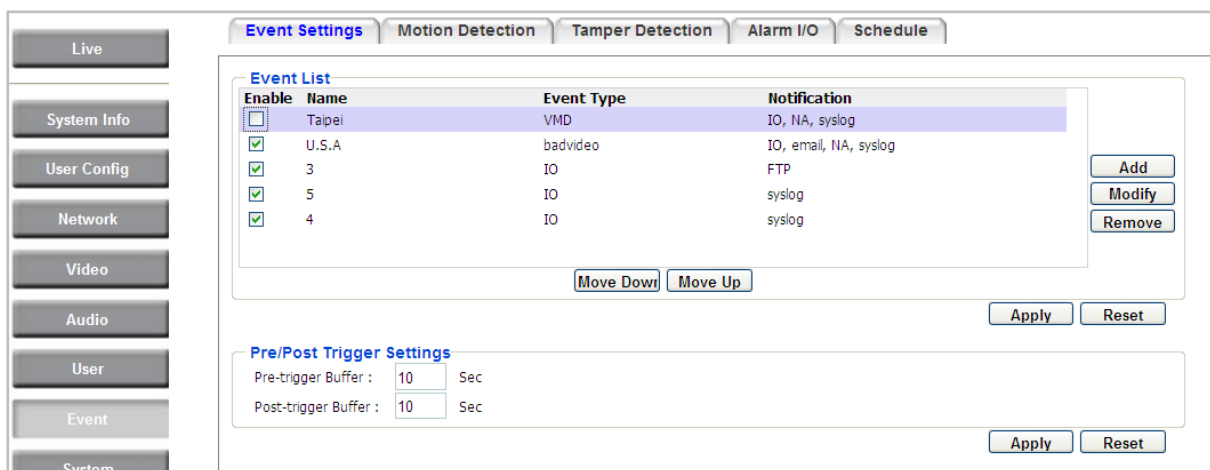

【Event List】

Click the **Add** button, and the following Event Configuration Window appears.

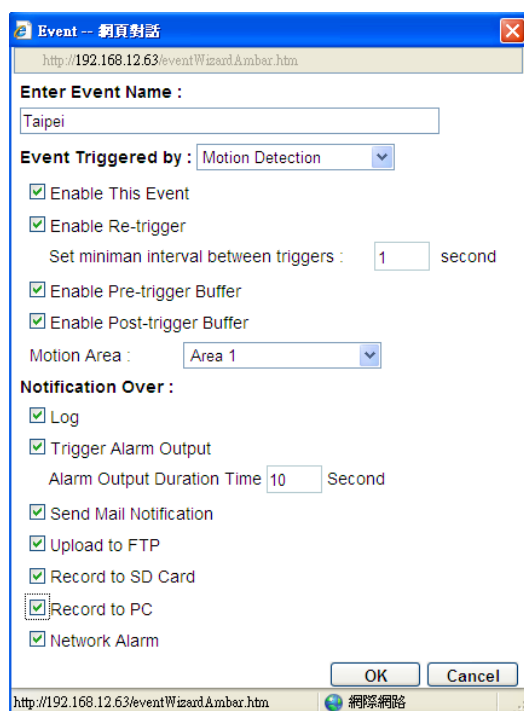

Enter Event Name: Type an event name.

Event Triggered by: Select an event or alarm type for the to-be-specified-below reaction/s.

Alarm Input: Select this if you want a reaction trigger coming from any external, connected sensor to activate a to-be-specified-below reaction/s via the camera system. Make sure that a suitable device is actually connected to the alarm input relay.

Manual Trigger: Select this option if you want to manually trigger the alarm by clicking the **Trigger Event** button on the Live View Page.

Motion Detection: Select this option if you want motion in a specified part of the camera's viewing rectangle (the screen image) to trigger the to-be-specified-below reaction/s.

Tampering Detection: Select this option if you want the camera's tampering detection sensor to trigger the to-be-specified-below reaction/s.

Schedule Recording: Select this option if you want the Schedule Recording periods configured in the recording schedule (the Settings > Event > Schedule page) to activate this event. In this scenario, a preconfigured event reaction like a log entry will list the start and end times of each period. Actual recording will only be triggered if the event is preconfigured to do so.

- **Enable This Event:** Select to activate the event.
- **Enable Re-trigger:** Click to set a minimum time after the event is triggered before the event can be triggered again.
- **Enable Pre-trigger Buffer:** Click if you want the Event reaction (as selected in the "Notification Over" field below) to be the activation of the video recording function, and if you want the recording to include the video feed from the time period (configurable on the previous "Event Settings" page) just before the Event trigger occurred.
- **Enable Post-trigger Buffer:** Click if you want the Event reaction (as selected in the Notification Over field) to be the activation of the video recording function, and if you want the recording to include the video feed from a time period (configurable on the Event Settings page) just after the Event trigger occurred.
- **Motion Area:** Select a setup motion detection area from the drop down list. Note this function only becomes relevant after the Motion Detection areas have been set up (see 7.7.2 *Motion Detection*).

Notification Over: Select the desired notification types from the following items.

- **Log:** Click if you want the camera to list the event's details in its log if the event is triggered.
- **Trigger Alarm Output:** Click if you want the camera to relay the event reaction to a device attached to the alarm relay output wire and then set up the alarm output duration time.

- **Send Mail Notification:** Click if you want the camera to send an Event notification email to the email address entered in the Set SMTP Server(email) field of the Network > SMTP/FTP page, if the Event occurs (see 7.3.3 SMTP / FTP).
- **Upload to FTP:** Click if you want the camera to upload recorded footage to the FTP server entered in the Set SMTP Server(email) field of the Network > SMTP/FTP page, if the Event occurs (see 7.3.3 SMTP / FTP).
- **Record to SD Card:** Click if you want the camera to start recording its video feed (when the event occurs) on an on-camera SD Card (if such a card has been inserted).

Note: The recording will only be as long as the combined Pre- and Post-trigger Buffers, so make sure you enable at least one of these buffers, especially the Post-trigger Buffer.

- **Record to PC:** Check this box if you want the camera to start recording its video feed (when the event occurs) on the same folder on the same PC as configured on the User Config > Recording/Snapshot page (if such a folder has been enabled and configured).

Note: The recording will only be as long as the combined Pre- and Post-trigger Buffers (and for as long as the event trigger is happening – e.g. a motion is detected), so make sure you enable at least one of these buffers, especially the Post-trigger Buffer.

- **Network Alarm:** Check this box if you want the camera to send a network alarm signal (when the event occurs) to the CMS servers configured on the Network > Network Alarm page (see 7.3.6 Network Alarm).

Click **OK** to save all settings, or click **Cancel** to cancel.

【Pre/Post Trigger Settings】

Pre-trigger Buffer: Select the duration for the buffer. This will determine the amount of footage (length of time) before the event trigger moment that will be included in an event-triggered video recording, if that buffer and video recording has been enabled in the Event Configuration Window.

Post-trigger Buffer: Select the duration for the buffer. This will determine the amount of footage (length of time) after the event trigger moment that will be included in an event-triggered video recording, if that buffer and video recording has been enabled in the Event Configuration Window.

Click **Apply** to save all settings, or click **Reset** to cancel.

7.7.2 Motion Detection

Use this page to configure up to four areas in which motion will be detected. When a motion is detected by the camera, the motion detection icon  will appear at the top right of the Live page to alert the user. This function can also be linked with correctly configured Events to trigger Event reactions like the activation of video recording periods, snapshots, alarms, etc.



Color Tabs : Click on a color tab to turn your mouse cursor into a pen of that color. You can now create a block of that color on the video screen. Move your cursor to the position where you want your detection rectangle to start and then click. Move your cursor to the position (diagonally opposing corner) where you want your detection rectangle to end and then click. The rectangular area with the selected color will appear. This block will be an area inside which the camera will detect motion. If you want to create another detection area, use one of the other three palette colors. Each color denotes a different detection area. Only one block per color is allowed. As the number of colors suggests, you can configure up to four blocks.

Select All: Click to turn the whole screen into a motion detection area.

Clear All: Click to delete all configured motion detection blocks.

Eraser: Click to turn your mouse cursor into an eraser to delete any block you click on.

Area: Shows the color and number/ID of the block.

Enable: Check this box to enable the related motion detection block.

Sensitivity: Set the sensitivity of the motion detection sensor function.

Click **Apply** to save all settings, or click **Reset** to cancel.

7.7.3 Tamper Detection

Use this page to set the number of seconds that an alarm signal will be active if the device is physically tampered (moved, covered up, or out of focus).

- Event Settings
- Motion Detection
- Tamper Detection**
- Alarm I/O
- Schedule

Tamper Detection Settings

Trigger Duration Time sec.

7.7.4 Alarm I/O

Use this page to set the type of trigger input and the type of output contact for each of the camera's two configurable alarm channels.

- Event Settings
- Motion Detection
- Tamper Detection
- Alarm I/O**
- Schedule

Alarm Settings

Input 1 Triggering Type : ▼

Output 1 Contact Type : ▼

7.7.5 Schedule

Use this page to configure a schedule for periods during which the camera should deactivate all user-activated Events (gray Deselect periods), or when the camera should deactivate all user-activated Events, except Schedule Recording (SR) events (blue Schedule Recording-only periods), or when the camera should deactivate only SR events (red Event Recording-only periods), or when it should enable all activated Events (yellow periods).

Event Settings Motion Detection Tamper Detection Alarm I/O **Schedule**

Schedule Settings

Event Recording ■
 Schedule Recording ■
 Event + Schedule ■
 Deselect ■

	00	01	02	03	04	05	06	07	08	09	10	11	12	13	14	15	16	17	18	19	20	21	22	23
Sun	■	■	■	■	■	■	■	■	■	■	■	■	■	■	■	■	■	■	■	■	■	■	■	■
Mon	■	■	■	■	■	■	■	■	■	■	■	■	■	■	■	■	■	■	■	■	■	■	■	■
Tue	■	■	■	■	■	■	■	■	■	■	■	■	■	■	■	■	■	■	■	■	■	■	■	■
Wed	■	■	■	■	■	■	■	■	■	■	■	■	■	■	■	■	■	■	■	■	■	■	■	■
Thu	■	■	■	■	■	■	■	■	■	■	■	■	■	■	■	■	■	■	■	■	■	■	■	■
Fri	■	■	■	■	■	■	■	■	■	■	■	■	■	■	■	■	■	■	■	■	■	■	■	■
Sat	■	■	■	■	■	■	■	■	■	■	■	■	■	■	■	■	■	■	■	■	■	■	■	■

Apply Reset

Event Recording: Click this button to make every hour block you click on red. A red block represents an Event Recording-only block, which represents an hour when the camera will deactivate all preconfigured, activated Schedule Recording events and keep all the other activated events active.

Schedule Recording: Click this button to make every hour block you click on blue. A blue block represents a Schedule Recording-only block, which represents an hour when the camera will deactivate all other preconfigured, activated events and keep only the preconfigured, activated Schedule Recording events active.

Event + Schedule: Click this button to make every hour block you click on yellow. A yellow block represents an hour in which all activated events, including Schedule Recording events, will be active.

Deselect: Click this button to make every hour block become grey. A grey block represents an hour in which **all** activated events, including Schedule Recording events, will be **inactive**.

Click **Apply** to save all settings, or click **Reset** to cancel.

7.8 System

You can set up the system’s time and SD card settings, and to do maintenance and reset actions like reboots and upgrades.

7.8.1 Date/Time

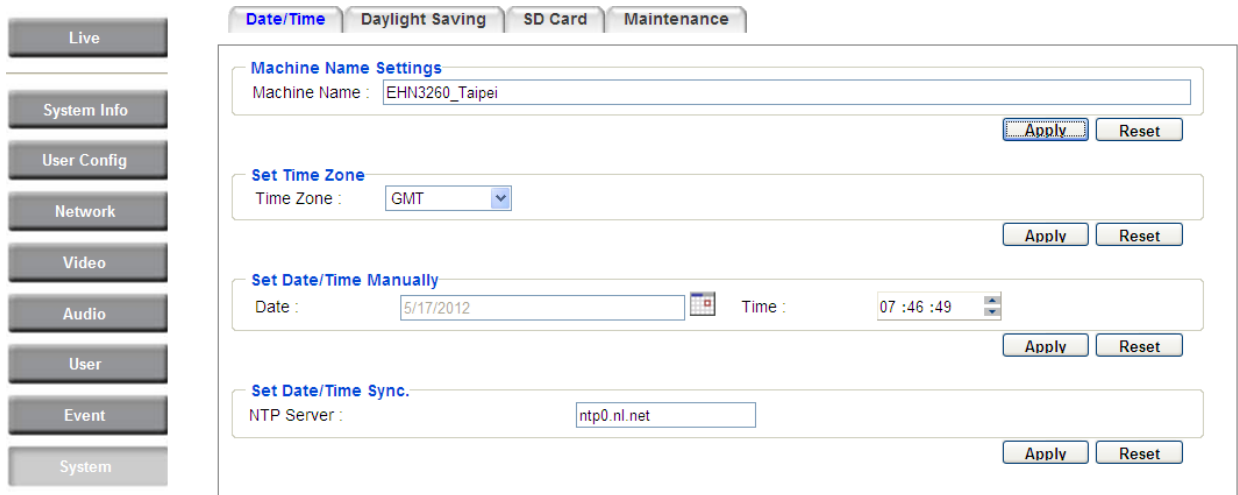

【Machine Name Settings】 If required, enter a new name for the machine. This name will be visible in the Machine Name field of the IP Utility software, which is included in the software CD.

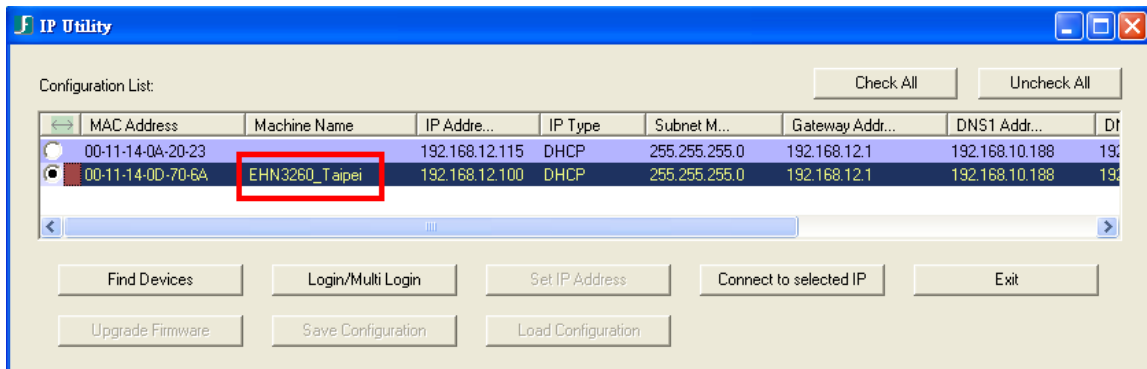

【Set Time Zone】 Set the time zone of the camera’s location.

【Set Date/Time Manually】 Set the date/time here if you won’t be using an NTP server to update the date/time (see below).

【Set Date/Time Sync.】 Enter the Network Time Protocol server, if applicable. The camera’s time will be automatically adjusted by synchronizing with the NTP server.

Click **Apply** to save all settings, or click **Reset** to cancel.

7.8.2 Daylight Saving

Click **Enable Daylight Saving** to enable this schedule, and select the dates when the region’s daylight saving period begins and ends. Click **Apply** to save all settings, or click **Reset** to cancel.

7.8.3 SD Card

Use this page to prepare the system for safely removing the SD Card from its slot.

【Setup SD Card】

Notification: Select the percentage of storage space that should be left on the card before the camera notifies you of the impending storage shortage or overwrite.

Event Recording: Select if you want Event Recording only, FTP Backup only, or both.

Overwrite: Click **ON** if you want the card to start writing over recorded footage when its memory is full. Click **OFF** if you want the card to stop recording new footage when its memory is full.

【SD Card Utility】

Capacity: This shows you how much card memory has been used and how much memory capacity remains on the card.

Remove: Click this button before removing the card from the system.

Format: Click this button to format the card. All data saved on the SD card will be removed if the card is formatted.

7.8.4 Maintenance

Date/Time
Daylight Saving
SD Card
Maintenance

Maintenance Server

Reboot the IP camera.

Resets all parameters, except for the IP, time zone and daylight saving parameters, to the original factory settings.

Resets all parameters to the original factory settings.

Save/Load Configuration Server

Save all configuration to a config. file.

Use a saved config. file to return the unit to a previous configuration.

Save/Load Video Configuration Server

Save video configuration to a config. file.

Use a saved config. file to return the unit to a previous configuration.

Upgrade Firmware

Upgrade the EHN3260 with the latest firmware.

Note: Do not disconnect power to the unit during upgrade. The unit will reboot automatically after the upgrade has completed. (1-5 minutes.)

【Maintenance Server】

Reboot: Click this button to reboot the unit without changing any of the settings. Use this function if the unit is not behaving as expected.

Restore: Click this button to restart and reset most of the current settings to their factory default values. The only settings that will not be changed to default are:

- IP settings
- DDNS settings

Default: The **Default** button should be used with caution. Pressing this button will return all of the camera's settings, including the IP address, to the factory default values. The camera will then have to be reconfigured.

【Save/Load Configuration Server】

Save: To make a backup file of the machine's current configurations, press **Save** to save all the configurations to a config. file. This will enable the user to reload these configuration settings if the settings are changed and there is unexpected behavior.

Load: To load a previously saved configuration, press the **Browse** button to locate the saved config. file (see above) and then click the **Load** button. The system's settings will be restored to the saved configuration.

【Save/Load Video Configuration Server】

Save: To make a backup file of the machine’s video configurations, press **Save** to save the video configurations to a config. file. This will enable the user to reload these configuration settings if the settings are changed and there is unexpected behavior.

Load: To load a previously saved video configuration, press the **Browse** button to locate the saved config. file (see above) and then click the **Load** button. The system’s settings will be restored to the saved video configuration.

【Upgrade Firmware】 Click the **Browse** button to find a previously prepared firmware upgrade file. Click **Upgrade** to install the new firmware.

Note:

1. Do not disconnect power to the unit during the upgrade sequence. The unit will reboot automatically after the upgrade has completed (1-5 minutes).
2. During the upgrade process, all event recording actions will be stopped. Event recording actions will resume after the camera is rebooted.
3. If the “File Error, Please re-login!!!” warning message appears when upgrading the firmware, please try the following instructions:
 - a. Go to Internet Explorer > Tools > Internet Option > Security > Custom.
 - b. Find and enable the **Include local directory path when uploading files to a server**.

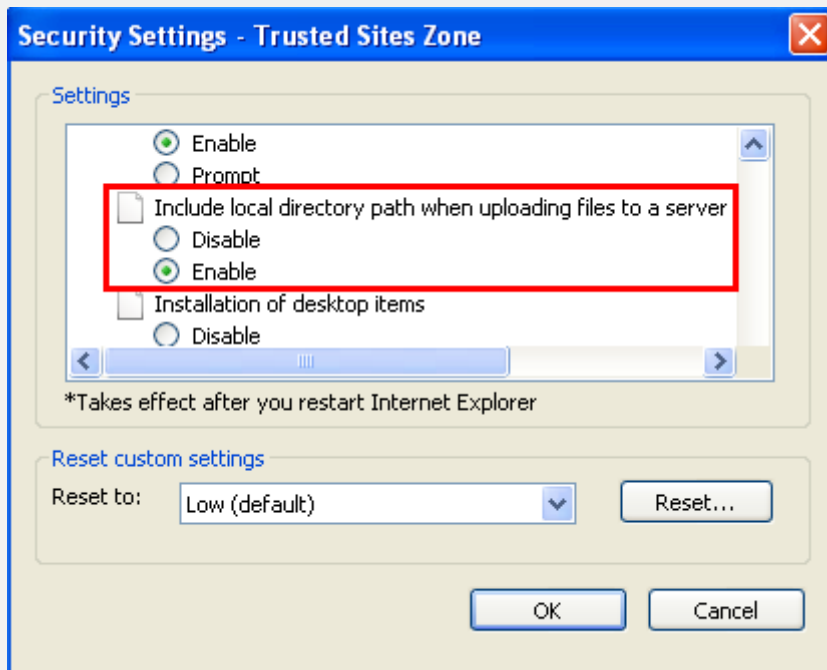

8. Upgrading Firmware Using IP Utility

You can upgrade the Firmware using the **IP Utility** software included in the software CD.

1. Install and then start the **IP Utility** . The following dialog box appears.

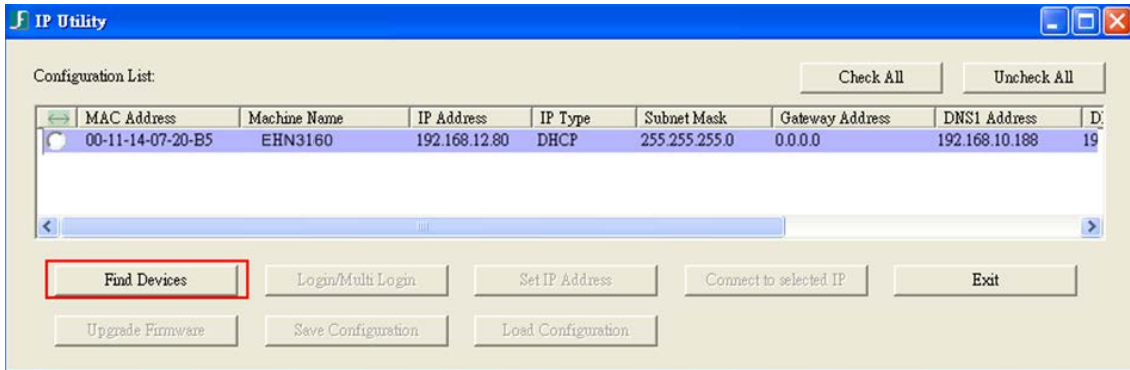

2. Click **Find Devices** to search the cameras connected in the LAN. The default network values of the cameras will be displayed. By default, the network protocol of the camera is **DHCP**.
3. Click **Login/Multi Login** to log in the camera.

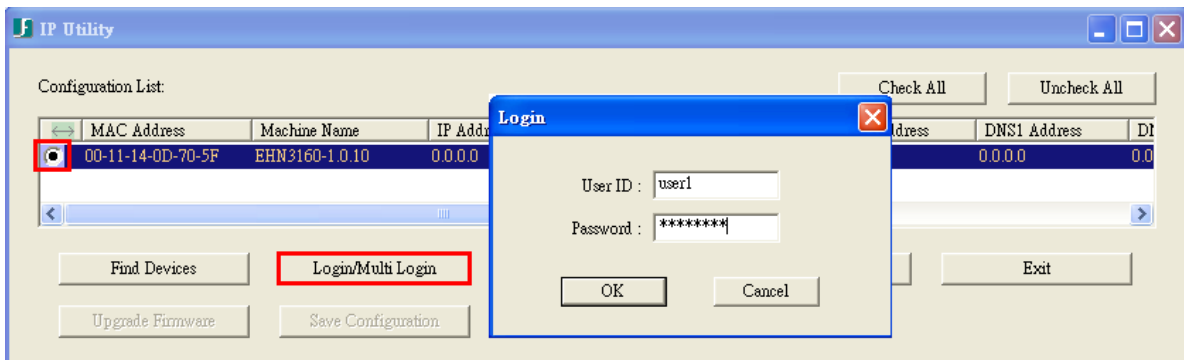

4. Type the user ID and password. Click **OK**.

Note:

1. The default user ID is **user1** and the default password is **11111111**.
2. If you select more than one camera that has the same user ID / password, you will be able to log in several cameras at once.

- Highlight the camera and then click Upgrade Firmware. A browsing window appears.

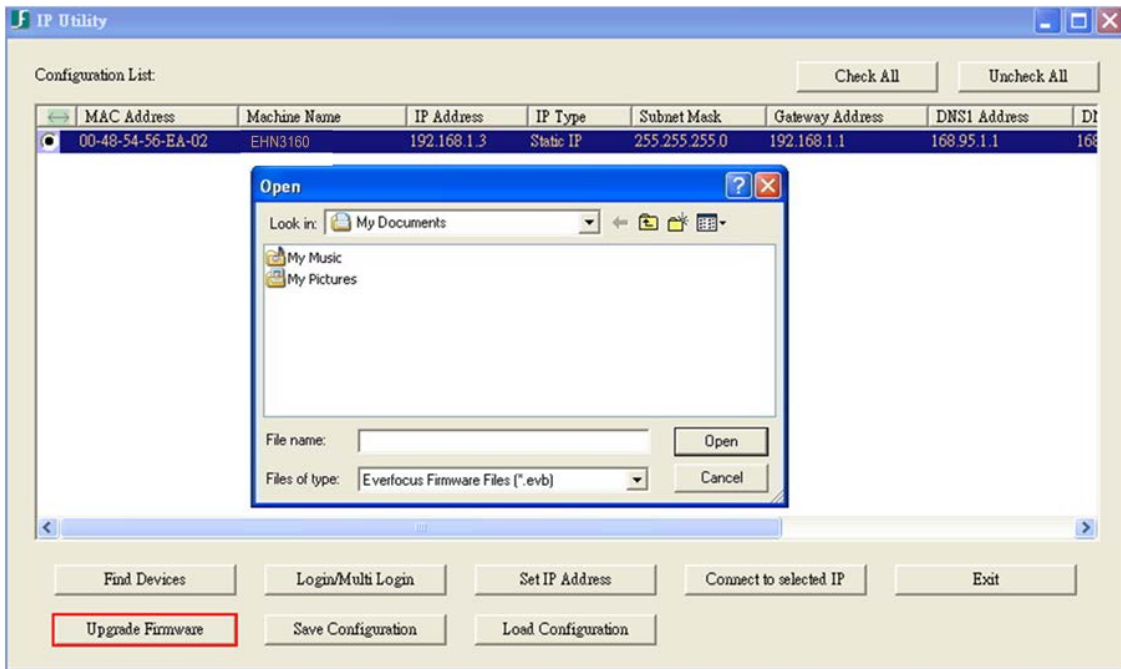

- Select the **firmware file (.evb)** and then click **Open**. The IP Utility will automatically upgrade the firmware.

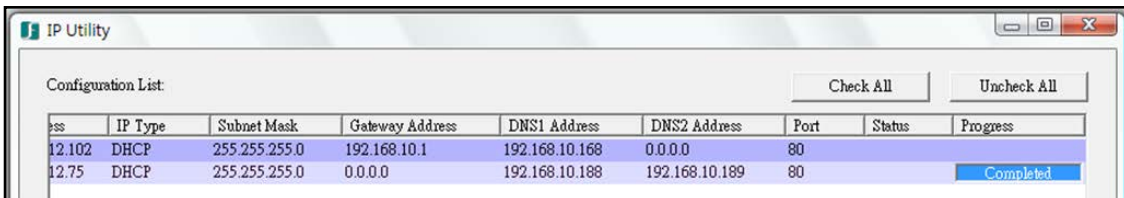

The camera will reboot once the update is complete. Click **Find Devices**, the new firmware version should be displayed in the last part of the Machine Name.

9. Specifications

Model	EHN3160 Plus		EHN3260 Plus		EHN3340 Plus	
Camera						
Image Sensor	1/3" Panasonic CMOS		1/3" Panasonic CMOS		1/2.8" Sony CMOS	
Megapixel	1.3 MP		2 MP		3 MP	
Picture Elements (H x V)	1280 x 1024		1944 x 1092		2048 x 1536	
Min. Illumination	0 lux at F1.2 (IR on)					
Electronic Shutter	8.5 ~ 1/60,000 sec.		2 ~ 1/50,000 sec.		1 ~ 1/10,000 sec.	
Scanning System	NTSC / PAL					
WDR	Yes		Yes		No	
BLC	Yes					
Gain Control	Yes					
White Balance	Yes					
Lens						
Lens Type	Varifocal					
Focal Lens	3 ~ 9 mm					
P-Iris	Yes					
Day / Night	Yes (with removable IR-cut filter)					
Angle of View	Horizontal	121.2° ~ 38.1°				
	Vertical	62.1° ~ 21.3°				
IR Distance	30 m / 98 ft					
IR LED Quantity	33					
Video						
Video Compression	H.264 and MJPEG					
Resolution	NTSC	2048 x 1536, 1920 x 1200 (for EHN3340 Plus only) 1920 x 1080 (for EHN3260 Plus / 3340 Plus only) 1280 x 1024, 1280 x 720, 1024 x 768, 720 x 480, 704 x 480, 640 x 480, 352 x 240, 320 x 240, 160 x 120				
	PAL	2048 x 1536, 1920 x 1200 (for EHN3340 Plus only) 1920 x 1080 (for EHN3260 Plus / 3340 Plus only) 1280 x 1024, 1280 x 720, 1024 x 768, 720 x 576, 704 x 576, 640 x 480, 352 x 288, 320 x 288, 160 x 120				
Frame Rate	30 fps at 1280 x 1024		30 fps at 1920 x 1080		15 fps at 2048 x 1536	

Audio			
Audio Streaming	Two-way audio		
Audio Compression	G.711		
Network			
Interface	10 / 100 Base-T Ethernet, RJ-45 socket		
Supported Protocols	HTTP, TCP / IP, FTP, SMTP, DHCP, DNS, DDNS, NTP		
Bandwidth control	Min. 64 k Byte/sec adjustable		
Mechanical			
Camera Angle Adjustment	Pan	360°	
	Tilt	64°	
	Rotate	180°	
Connector	Power	DC 12V, PoE	
	Ethernet	RJ-45	
	Memory Card	One SD / SDHC card slot	
Terminal Block	Audio In/Out	Phone jack	
	Alarm	1 in 1 out triggered by intelligent event and external input	
General			
Power Source	12V DC / PoE (802.3at)		
Power Consumption (IR LEDs On)	10.56W (DC 12V) / 13.11W (PoE)	11.1W (DC 12V) / 13.76W (PoE)	10.08W (DC 12V) / 12.28W (PoE)
Operating Temperature	-40°C ~ 55°C / -40°F ~ 131°F (DC 12V) -20°C ~ 55°C / -4°F ~ 131°F (PoE)		
Humidity	0% ~ 90% (no condensation)		
Safety	CE, FCC		
Protection Classification	IP66 rating		
Dimensions (L x W x H)	149 x 149 x 125.9 mm / 5.9 x 5.9 x 5 in		
Weight	1.68 kg / 3.7 lbs		

Appendix

A. Adjustment Rings

The four Adjustment Rings, including one black and three transparent rings, attached on the Cable Gland are used to tighten the cable gland for better waterproofing. The Cable Gland is designed with three cable conduits for inserting the cables. You can insert a network cable (Cat 5 or Cat 6) through one of the three conduits. And use the spare two conduits for inserting additional cables. Please refer to the table below to verify the number of Adjustment Rings used.

Adjustment Rings

- Transparent x 3 (1mm thickness)



- Black x 1 (0.5mm thickness)

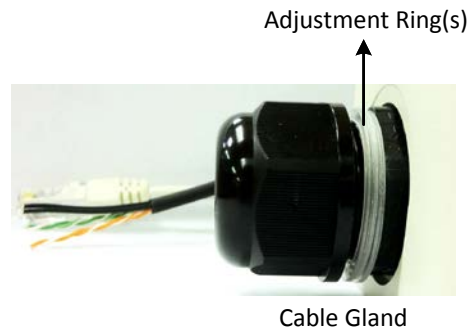

Number of Cable used	Cable Type & Diameter	Number of Adjustment Ring Used
One	One Cat 5 (Φ 5.3mm)	Three Transparent Rings
	One Cat 6 (Φ 6.4mm)	Three Transparent Rings + One Black Ring
Two	One Cat 5 (Φ 5.3mm) + One Additional Cable	Three Transparent Rings
	One Cat 6 (Φ 6.4mm) + One Additional Cable	Three Transparent Rings + One Black Ring
Three	One Cat 5 (Φ 5.3mm) + Two Additional Cable	Three Transparent Rings
	One Cat 6 (Φ 6.4mm) + Two Additional Cables	Three Transparent Rings + One Black Ring

** If you are using one / two / three cables (with Φ5.3mm), use three transparent rings.

** If you are using one / two / three cables (with Φ6.4mm), use three transparent rings and one black ring.

EverFocus Electronics Corp.

EverFocus Taiwan:

12F, No.79, Sec. 1, Shin-Tai Wu Road,
Hsi-Chih, Taipei, Taiwan
TEL: +886 2 2698 2334
FAX: +886 2 2698 2380
www.everfocus.com.tw
marketing@everfocus.com.tw

EverFocus China - Beijing:

Room 609, Technology Trade Building,
Shangdi Information Industry Base,
Haidian District, Beijing 100085, China
TEL: +86 10 6297 3336~39
FAX: +86 10 6297 1423
www.everfocus.com.cn
marketing@everfocus.com.cn

EverFocus USA - California:

1801 Highland Avenue, Unit A, Duarte, CA 91010, USA
TEL: +1 626 844 8888
FAX: +1 626 844 8838
www.everfocus.com
sales@everfocus.com

EverFocus Japan:

5F, Kinshicho City Building, 2-13-4
Koto-Bashi, Sumida-Ku, Tokyo, 130-0022, Japan
TEL: +81 3 5625 8188
FAX: +81 3 5625 8189
www.everfocus.co.jp
info@everfocus.co.jp

EverFocus India:

Suite 803, Housefin Bhavan, C-21,
Bandra Kurla Complex, Bandra (East),
Mumbai 400051, India
TEL: +91 22 6128 8700
FAX: +91 22 6128 8705
www.everfocus.in
sales@everfocus.in

EverFocus Europe - Germany:

Albert-Einstein-Strasse 1, D-46446
Emmerich, Germany
TEL: +49 2822 93940
FAX: +49 2822 939495
www.everfocus.de
info@everfocus.de

EverFocus China - Shenzhen:

4F, No. 2, D4 Building, Wan Yelong
Industrial Park, Tangtou Road, Shiyan,
Baoan, Shenzhen, Guangdong 518101, China
TEL: +86 755 2765 1313
FAX: +86 755 2765 0337
www.everfocus.com.cn
marketing@everfocus.com.cn

EverFocus USA - New York:

415 Oser Avenue, Unit S, Hauppauge, NY 11788, USA
TEL: +1 631 436 5070
FAX: +1 631 436 5027
www.everfocus.com
sales@everfocus.com

EverFocus Europe - UK:

Unit 12, Spitfire Business Park,
Hawker Road, Croydon Surrey, CR0 4WD, UK
TEL: +44 20 8649 9757 / +44 845 430 9999
FAX: +44 20 8649 9907
www.everfocusuk.co.uk
salesuk@everfocus.com



Your EverFocus product is designed and manufactured with high quality materials and components which can be recycled and reused. This symbol means that electrical and electronic equipment, at their end-of-life, should be disposed of separately from your household waste. Please, dispose of this equipment at your local community waste collection/recycling centre. In the European Union there are separate collection systems for used electrical and electronic product. Please, help us to conserve the environment we live in!

Ihr EverFocus Produkt wurde entwickelt und hergestellt mit qualitativ hochwertigen Materialien und Komponenten, die recycelt und wieder verwendet werden können. Dieses Symbol bedeutet, dass elektrische und elektronische Geräte am Ende ihrer Nutzungsdauer vom Hausmüll getrennt entsorgt werden sollen. Bitte entsorgen Sie dieses Gerät bei Ihrer örtlichen kommunalen Sammelstelle oder im Recycling Centre. Helfen Sie uns bitte, die Umwelt zu erhalten, in der wir leben.



P/N: 4605PH3160B020A-Ver.D