



HP Compaq LA2006x, LA2206x, and LA2306x LED Backlit LCD Monitors

User Guide

© 2010, 2011 Hewlett-Packard
Development Company, L.P.

Microsoft, Windows, and Windows Vista are either trademarks or registered trademarks of Microsoft Corporation in the United States and/or other countries.

The only warranties for HP products and services are set forth in the express warranty statements accompanying such products and services. Nothing herein should be construed as constituting an additional warranty. HP shall not be liable for technical or editorial errors or omissions contained herein.

This document contains proprietary information that is protected by copyright. No part of this document may be photocopied, reproduced, or translated to another language without the prior written consent of Hewlett-Packard Company.

Second Edition (June 2011)

Document Part Number: 630579-002

About This Guide

This guide provides information on setting up the monitor, installing drivers, using the on-screen display menu, troubleshooting and technical specifications.

 **WARNING!** Text set off in this manner indicates that failure to follow directions could result in bodily harm or loss of life.

 **CAUTION:** Text set off in this manner indicates that failure to follow directions could result in damage to equipment or loss of information.

 **NOTE:** Text set off in this manner provides important supplemental information.

Table of contents

1 Product Features	1
HP LCD Monitors	1
2 Safety and Maintenance Guidelines	3
Important Safety Information	3
Maintenance Guidelines	3
Cleaning the Monitor	4
Shipping the Monitor	4
3 Setting Up the Monitor	5
Unfolding the Monitor Pedestal Base	5
Rear Components	6
Connecting the Cables	7
Adjusting the Monitor	9
Turning on the Monitor	11
Connecting USB Devices	12
Removing the Monitor Pedestal Base	13
Mounting the Monitor	14
Locating the Rating Labels	15
Installing a Cable Lock	15
4 Operating the Monitor	16
Software and Utilities	16
The Information File	16
The Image Color Matching File	16
Installing the .INF and .ICM Files	17
Installing from the CD	17
Downloading from the Worldwide Web	17
Using the Auto-Adjustment Function	18
Front Panel Controls	19
Adjusting the Monitor Settings	20
Using the On-Screen Display Menu	20
OSD Menu Selections	21
Optimizing Image Performance	25
Using the HP Display Assistant Utility	26
Identifying Monitor Conditions	26

Sleep Timer Mode	27
Appendix A Troubleshooting	29
Solving Common Problems	29
Online Technical Support	30
Preparing to Call Technical Support	30
Appendix B Technical Specifications	31
LA2006x Model	31
LA2206x Model	32
LA2306x Model	33
Recognizing Preset Display Resolutions	35
LA2006x Model	35
LA2206x Model	35
LA2306x Model	36
Entering User Modes	37
Energy Saver Feature	37
Appendix C Agency Regulatory Notices	38
Federal Communications Commission Notice	38
Modifications	38
Cables	38
Declaration of Conformity for Products Marked with the FCC Logo (United States Only)	38
Canadian Notice	39
Avis Canadien	39
European Union Regulatory Notice	39
German Ergonomics Notice	40
Japanese Notice	40
Korean Notice	40
Power Cord Set Requirements	40
Japanese Power Cord Requirements	40
Product Environmental Notices	41
ENERGY STAR® Qualification	41
Materials Disposal	41
Disposal of Waste Equipment by Users in Private Household in the European Union	42
HP Recycling Program	42
Chemical Substances	42
Restriction of Hazardous Substances (RoHS)	42
Turkey EEE Regulation	43

1 Product Features

HP LCD Monitors

The LCD (liquid crystal display) monitors have an active matrix, thin-film transistor (TFT) panel. The monitor models and features include:

- LA2006x model, 50.8 cm (20-inch) diagonal viewable area display with 1600 x 900 resolution, plus full-screen support for lower resolutions; includes custom scaling for maximum image size while preserving original aspect ratio
- LA2206x model, 54.6 cm (21.5-inch) diagonal viewable area display with 1920 x 1080 resolution, plus full-screen support for lower resolutions; includes custom scaling for maximum image size while preserving original aspect ratio
- LA2306x model, 58.4 cm (23-inch) diagonal viewable area display with 1920 x 1080 resolution, plus full-screen support for lower resolutions; includes custom scaling for maximum image size while preserving original aspect ratio
- Non-glare panel with an LED backlight that provides better clarity and consumes less energy than traditional CCFL backlights
- Wide viewing angle to allow viewing from a sitting or standing position, or moving side-to-side
- Tilt capability
- Pivot capability to rotate display to portrait mode
- Swivel and height adjustment capabilities
- Removable stand for flexible monitor panel mounting solutions
- Video signal input to support VGA analog with VGA signal cable provided
- Video signal input to support DVI digital with DVI-D signal cable provided
- Video signal input to support DisplayPort digital (DisplayPort cable not provided)
- USB 2.0 hub with one upstream port (connects to the computer) and two downstream ports (connects to USB devices)
- USB cable provided to connect the monitor's USB hub to the USB connector on the computer
- Supports an optional HP speaker bar
- Plug and play capability if supported by the system
- Privacy filter slots to insert filters (purchased separately) to block side screen viewing
- Security slot provision on rear of monitor for optional cable lock
- Cable management feature for placement of cables and cords
- On-Screen Display (OSD) adjustments in several languages for easy setup and screen optimization
- HP Display Assistant for adjusting monitor settings
- Theft deterrence software

- HDCP copy protection on DVI and DisplayPort inputs
- Software and documentation CD that includes monitor drivers and product documentation
- Energy saver feature to meet requirements for reduced power consumption
- Energy Star® qualified
- Intelligent Management AssetControl
- Compliant with the following regulated specifications:
 - European Union CE Directives
 - Swedish TCO Requirements

2 Safety and Maintenance Guidelines

Important Safety Information

A power cord is included with the monitor. If another cord is used, use only a power source and connection appropriate for this monitor. For information on the correct power cord set to use with the monitor, refer to the [Power Cord Set Requirements on page 40](#).

⚠ WARNING! To reduce the risk of electric shock or damage to the equipment:

- Do not disable the power cord grounding feature. The grounding plug is an important safety feature.
- Plug the power cord in a grounded (earthed) outlet that is easily accessible at all times.
- Disconnect power from the product by unplugging the power cord from the electrical outlet.

For your safety, do not place anything on power cords or cables. Arrange them so that no one may accidentally step on or trip over them. Do not pull on a cord or cable. When unplugging from the electrical outlet, grasp the cord by the plug.

To reduce the risk of serious injury, read the *Safety and Comfort Guide*. It describes proper workstation, setup, posture, and health and work habits for computer users, and provides important electrical and mechanical safety information. This guide is located on the Web at <http://www.hp.com/ergo> and/or on the documentation CD, if one is included with the monitor.

⚠ CAUTION: For the protection of the monitor, as well as the computer, connect all power cords for the computer and its peripheral devices (such as a monitor, printer, scanner) to some form of surge protection device such as a power strip or Uninterruptible Power Supply (UPS). Not all power strips provide surge protection; the power strips must be specifically labeled as having this ability. Use a power strip whose manufacturer offers a Damage Replacement Policy so you can replace the equipment, if surge protection fails.

Use the appropriate and correctly sized furniture designed to properly support your HP LCD monitor.

⚠ WARNING! LCD monitors that are inappropriately situated on dressers, bookcases, shelves, desks, speakers, chests, or carts may fall over and cause personal injury.

Care should be taken to route all cords and cables connected to the LCD monitor so that they can not be pulled, grabbed, or tripped over.

Maintenance Guidelines

To enhance the performance and extend the life of the monitor:

- Do not open the monitor cabinet or attempt to service this product yourself. Adjust only those controls that are covered in the operating instructions. If the monitor is not operating properly or has been dropped or damaged, contact an authorized HP dealer, reseller, or service provider.
- Use only a power source and connection appropriate for this monitor, as indicated on the label/back plate of the monitor.
- Be sure the total ampere rating of the products connected to the outlet does not exceed the current rating of the electrical outlet, and the total ampere rating of the products connected to the cord does not exceed the rating of the cord. Look on the power label to determine the ampere rating (AMPS or A) for each device.

- Install the monitor near an outlet that you can easily reach. Disconnect the monitor by grasping the plug firmly and pulling it from the outlet. Never disconnect the monitor by pulling the cord.
- Turn the monitor off when not in use. You can substantially increase the life expectancy of the monitor by using a screen saver program and turning off the monitor when not in use.



NOTE: Monitors with a “burned-in image” are not covered under the HP warranty.

- Slots and openings in the cabinet are provided for ventilation. These openings must not be blocked or covered. Never push objects of any kind into cabinet slots or other openings.
- Do not drop the monitor or place it on an unstable surface.
- Do not allow anything to rest on the power cord. Do not walk on the cord.
- Keep the monitor in a well-ventilated area, away from excessive light, heat or moisture.
- When removing the monitor stand, you must lay the monitor face down on a soft area to prevent it from getting scratched, defaced, or broken.

Cleaning the Monitor

1. Turn off the monitor and unplug the power cord from the back of the unit.
2. Dust the monitor by wiping the screen and the cabinet with a soft, clean antistatic cloth.
3. For more difficult cleaning situations, use a 50/50 mix of water and Isopropyl alcohol.



CAUTION: Spray the cleaner onto a cloth and use the damp cloth to gently wipe the screen surface. Never spray the cleaner directly on the screen surface. It may run behind the bezel and damage the electronics.

CAUTION: Do not use cleaners that contain any petroleum based materials such as benzene, thinner, or any volatile substance to clean the monitor screen or cabinet. These chemicals may damage the monitor.

Shipping the Monitor

Keep the original packing box in a storage area. You may need it later if you move or ship the monitor.

3 Setting Up the Monitor

To set up the monitor, ensure that the power is turned off to the monitor, computer system, and other attached devices, then follow the instructions below.

Unfolding the Monitor Pedestal Base

1. Lift the monitor from its box and place it face down on a flat surface.
2. Hold down the monitor base with one hand (1) then grasp the top of the stand with the other hand and unfold the display head 90 degrees (2).

⚠ CAUTION: Do not touch the surface of the LCD panel. Pressure on the panel may cause non-uniformity of color or disorientation of the liquid crystals. If this occurs the screen will not recover to its normal condition.

Figure 3-1 Unfolding the Monitor Pedestal Base



📝 NOTE: When the monitor is unfolded for the first time, the display head is locked from adjusting to a full-height position. To adjust the display head to full height, press down on the display head to unlock it then pull up on the display head to raise it to the full-height position. Refer to step 3 in [Adjusting the Monitor on page 9](#).

Rear Components

Figure 3-2 Rear Components

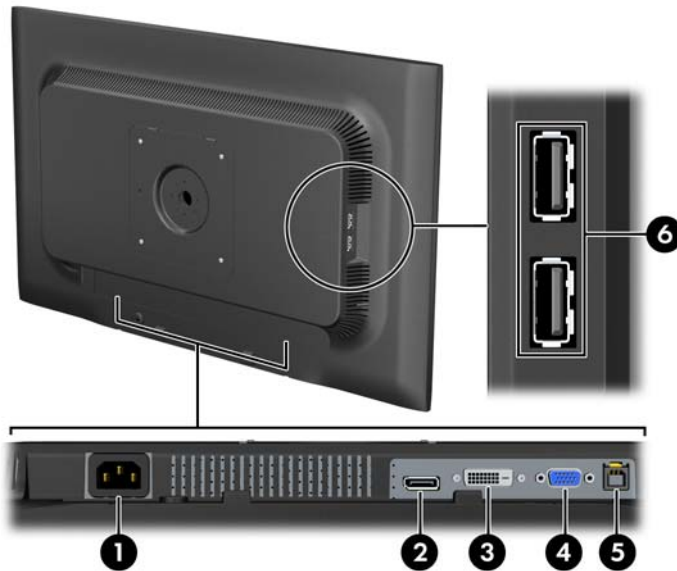

Component	Function
1 AC Power Connector	Connects the AC power cord to the monitor.
2 DisplayPort	Connects the DisplayPort cable (not included) to the monitor.
3 DVI-D	Connects the DVI-D cable to the monitor.
4 VGA	Connects the VGA cable to the monitor.
5 USB Upstream Connector	Connects the USB hub cable to the monitor's USB hub connector and to a host USB port/hub.
6 USB Downstream Connectors (2)	Connects optional USB devices to the monitor.

Connecting the Cables

1. Place the monitor in a convenient, well-ventilated location near the computer.
2. Remove the cable management clip from the pedestal by pulling outward on the two sides of the clip (1) then lifting the clip off the pedestal (2).

Figure 3-3 Removing the Cable Management Clip

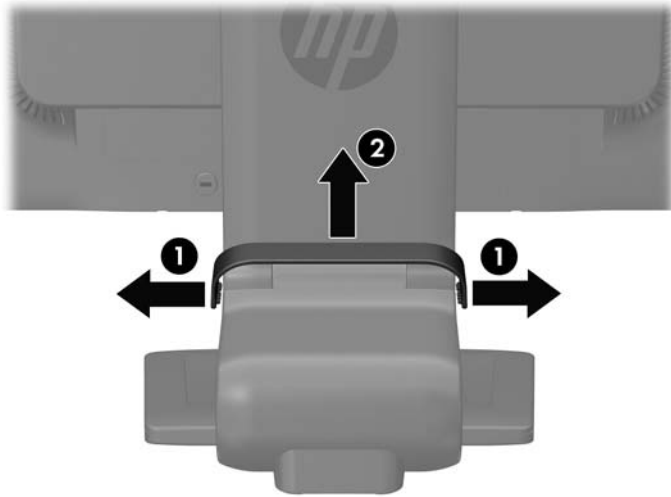

3. Connect a VGA signal cable, DVI-D signal cable, or DisplayPort signal cable.

 **NOTE:** The monitor is capable of supporting either analog or digital input. The video mode is determined by the video cable used. The monitor will automatically determine which inputs have valid video signals. The inputs can be selected by pressing the [+ / source](#) button on the front panel or through the On-Screen Display (OSD) feature by pressing the [Menu](#) button.

- For analog operation, use the VGA signal cable provided. Connect the VGA signal cable to the VGA connector on the rear of the monitor and the other end to the VGA connector on the computer.
 - For DVI digital operation, use the DVI-D signal cable provided. Connect the DVI-D signal cable to the DVI connector on the rear of the monitor and the other end to the DVI connector on the computer.
 - For DisplayPort digital operation, use a DisplayPort signal cable (not provided). Connect the DisplayPort signal cable to the DisplayPort connector on the rear of the monitor and the other end to the DisplayPort connector on the computer.
4. Connect one end of the provided USB cable to the USB hub connector on the rear panel of the computer, and the other end to the upstream USB connector on the monitor.

5. Connect one end of the power cord to the AC power connector on the back of the monitor, and the other end to an electrical wall outlet.

Figure 3-4 Connecting the Cables

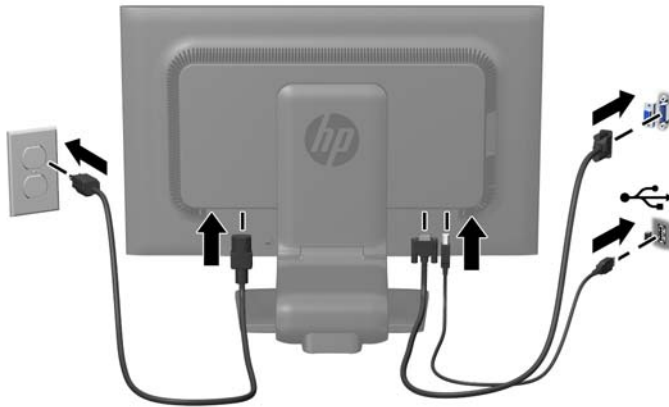

⚠ WARNING! To reduce the risk of electric shock or damage to the equipment:

Do not disable the power cord grounding plug. The grounding plug is an important safety feature.

Plug the power cord into a grounded (earthed) electrical outlet that is easily accessible at all times.

Disconnect power from the equipment by unplugging the power cord from the electrical outlet.

For your safety, do not place anything on power cords or cables. Arrange them so that no one may accidentally step on or trip over them. Do not pull on a cord or cable. When unplugging from the electrical outlet, grasp the cord by the plug.

6. Secure the cables in place with the cable management clip. Press the clip straight down on the curved neck of the pedestal ensuring that the tabs on the sides of the clip snap into the slots on the pedestal.

Figure 3-5 Installing the Cable Management Clip

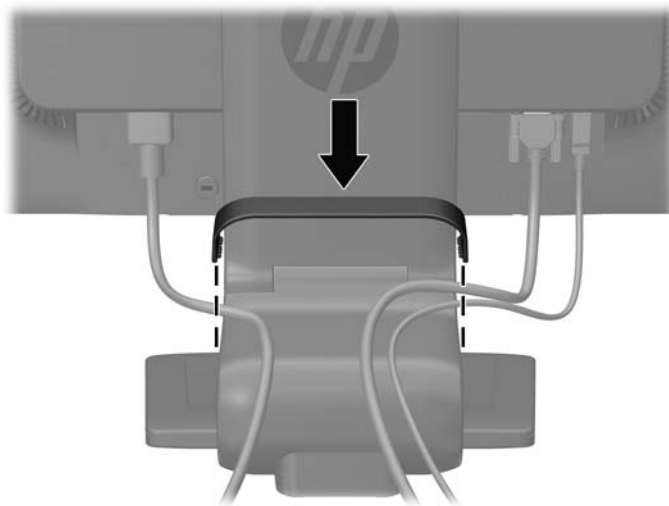

Adjusting the Monitor

 **NOTE:** Your monitor model may look different than the model in the following illustrations.

1. Tilt the monitor's panel forward or backward to set it to a comfortable eye level.

Figure 3-6 Tilting the Monitor



2. Swivel the monitor to the left or right for the best viewing angle.

Figure 3-7 Swiveling the Monitor



3. Adjust the monitor's height to a comfortable position for your individual workstation. The monitor's top bezel edge should not exceed a height that is parallel to your eye height. A monitor that is positioned low and reclined may be more comfortable for users with corrective lenses. The monitor should be repositioned as you adjust your working posture throughout the work day.



 **NOTE:** When the monitor is unfolded for the first time, the display head is locked from adjusting to a full-height position. To adjust the display head to full height, press down on the display head to unlock it then pull up on the display head to raise it to the full-height position.

Figure 3-8 Adjusting the Height



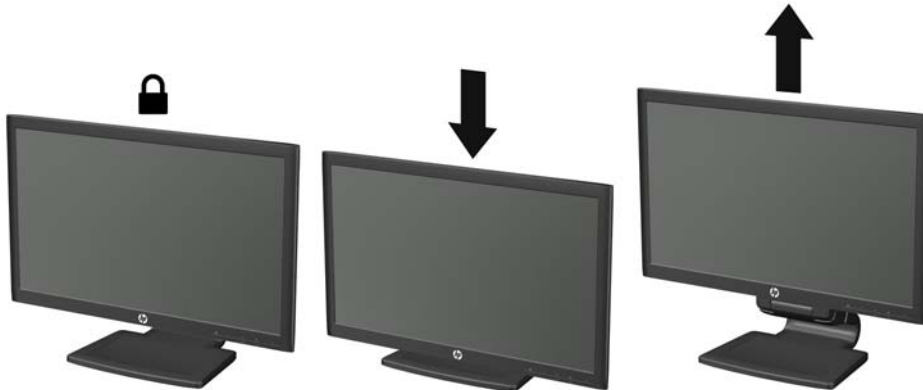

4. Pivot the monitor from landscape to portrait orientation viewing to adapt to your application.
 - a. Adjust the monitor to full height position and tilt the monitor back to full tilt position (1).
 - b. Pivot the monitor clockwise 90° from landscape to portrait orientation (2).

 **CAUTION:** If the monitor is not in full height and full tilt position when pivoting, the bottom right corner of the monitor panel will come in contact with the base and potentially cause damage to the monitor.

If you are adding an optional speaker bar to the monitor, install it after pivoting the monitor. The speaker bar will come in contact with the base when pivoting and potentially cause damage to the monitor or speaker bar.

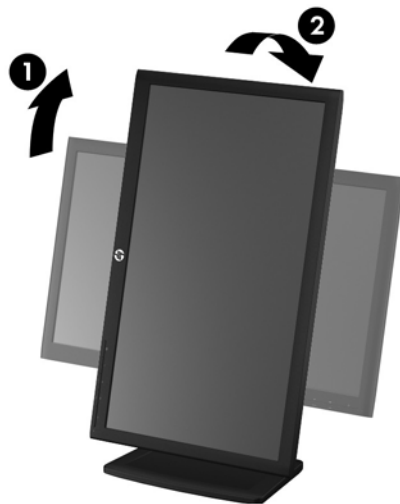
Figure 3-9 Pivoting the Monitor



 **NOTE:** To view information on the screen in portrait mode, you can install the HP Display Assistant software included on the software and documentation CD. The position of the OSD menu can also be rotated to portrait mode. To rotate the OSD menu, access the OSD menu by pressing the **Menu** button on the front panel, select **OSD Control** from the menu, then select **Rotate OSD**.

Turning on the Monitor

1. Press the power button on the computer to turn it on.
2. Press the power button on the front of the monitor to turn it on.

 **CAUTION:** Burn-in image damage may occur on monitors that display the same static image on screen for a prolonged period of time.* To avoid burn-in image damage on the monitor screen, you should always activate a screen saver application or turn off the monitor when it is not in use for a prolonged period of time. Image retention is a condition that may occur on all LCD screens. Monitors with a “burned-in image” are not covered under the HP warranty.

* A prolonged period of time is 12 consecutive hours of non-use.

 **NOTE:** If pressing the power button has no effect, the Power Button Lockout feature may be enabled. To disable this feature, press and hold the monitor power button for 10 seconds.

NOTE: You can disable the power LED in the OSD menu. Press the **Menu** button on the front of the monitor, then select **Management > Bezel Power LED > Off**.

When the monitor is powered on, a Monitor Status message is displayed for five seconds. The message shows which input (DisplayPort, DVI, or VGA) is the current active signal, the status of the auto-switch source setting (On or Off; factory default is On), the default source signal (factory default is DisplayPort), the current preset display resolution, and the recommended preset display resolution.

The monitor automatically scans the signal inputs for an active input and uses that input for the display. If two or more inputs are active, the monitor will display the default input source. If the default source is not one of the active inputs, then the monitor will display the highest ranking priority input in the following order: DisplayPort, DVI, then VGA. You can change the default source in the OSD by pressing the front panel **Menu** button and selecting **Source Control > Default Source**.

Connecting USB Devices

USB connectors are used to connect devices such as a digital camera, USB keyboard, or USB mouse. Two USB connectors are located on the side panel of the monitor.

 **NOTE:** You must connect the USB hub cable from the monitor to the computer to enable the USB 2.0 ports on the monitor. Refer to Step 4 in [Connecting the Cables on page 7](#).

Figure 3-10 Connecting USB Devices



Removing the Monitor Pedestal Base

You can remove the monitor panel from the pedestal base to install the panel on a wall, a swing arm, or other mounting fixture.

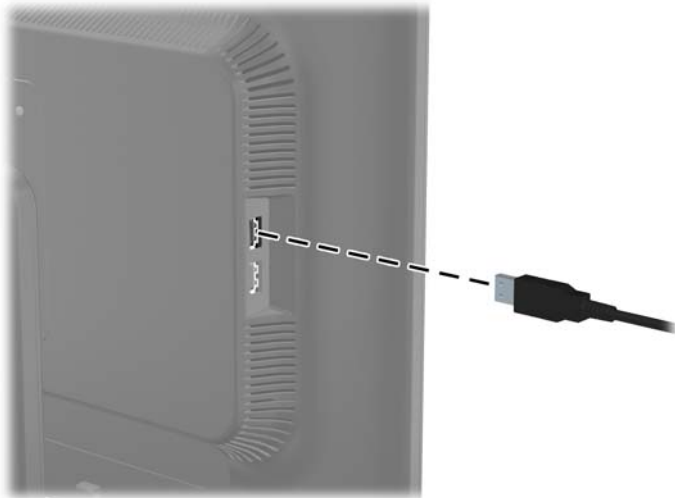
⚠ CAUTION: Before beginning to disassemble the monitor, be sure the monitor is turned off and the power and signal cables are both disconnected. Also disconnect all USB cables connected to the monitor.

1. Disconnect and remove the signal, power, and USB cables from the monitor.
2. Lay the monitor face down on a flat surface covered by a clean, dry cloth.
3. Pivot the base 45 degrees clockwise and remove the screw from the back of the monitor, then pivot the base 45 degrees counter-clockwise and remove the other screw from the back of the monitor.

Figure 3-11 Removing the Pedestal Base Screws



4. Rotate the base of the monitor up (1) then pull it back (2) to unhinge the tabs on the monitor stand from the slots in the monitor.

Figure 3-12 Removing the Pedestal Base

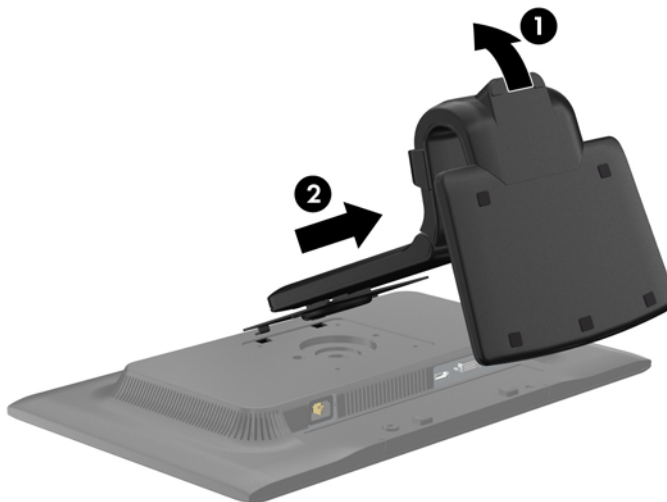

Mounting the Monitor

The monitor panel can be attached to a wall, swing arm, or other mounting fixture.

 **NOTE:** This apparatus is intended to be supported by UL or CSA Listed wall mount bracket.

1. Remove the monitor panel from the pedestal base. Refer to [Removing the Monitor Pedestal Base on page 13](#).

 **CAUTION:** This monitor supports the VESA industry standard 100 mm mounting holes. To attach a third-party mounting solution to the monitor, four 4 mm, 0.7 pitch, and 10 mm long screws are required. Longer screws must not be used because they may damage the monitor. It is important to verify that the manufacturer's mounting solution is compliant with the VESA standard and is rated to support the weight of the monitor display panel. For best performance, it is important to use the power and video cables provided with the monitor.

2. To attach the monitor to a swing arm, insert four 10mm screws through the holes on the swing arm plate and into the mounting holes on the monitor.

Figure 3-13 Mounting the Monitor

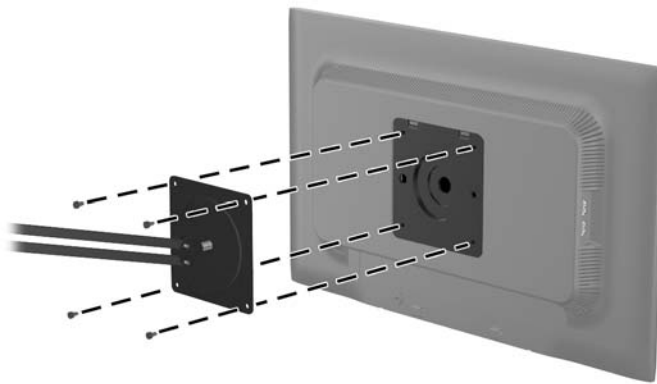

To attach the monitor to other mounting fixtures, follow the instructions included with the mounting fixture to ensure that the monitor is safely attached.

3. Reconnect the cables to the monitor panel.

Locating the Rating Labels

The rating labels on the monitor provide the spare part number, product number, and serial number. You may need these numbers when contacting HP about the monitor model. The rating labels are located on the rear panel of the monitor display head.

Figure 3-14 Locating the Rating Labels



Installing a Cable Lock

You can secure the monitor to a fixed object with an optional cable lock available from HP.

Figure 3-15 Installing a Cable Lock

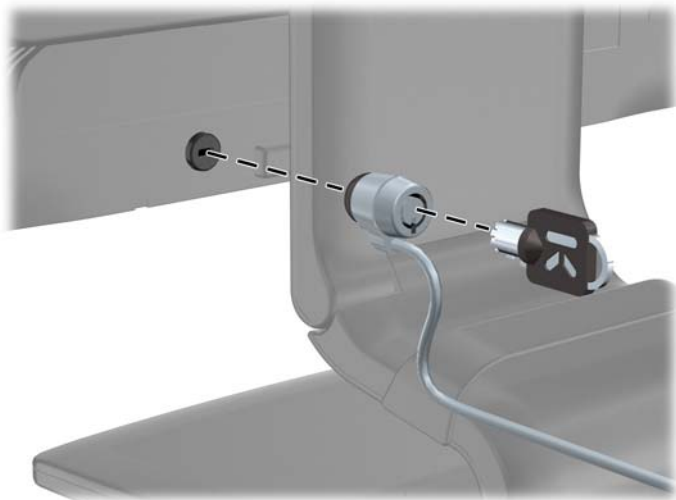

4 Operating the Monitor

Software and Utilities

The CD that comes with the monitor contains files you can install on the computer:

- an .INF (Information) file
- an .ICM (Image Color Matching) file
- auto-adjustment pattern utility
- additional software for the monitor model



NOTE: If the monitor does not include a CD, the .INF and .ICM files can be downloaded from the HP monitors support Web site. See [Downloading from the Worldwide Web on page 17](#) in this chapter.

The Information File

The .INF file defines monitor resources used by Microsoft Windows operating systems to ensure monitor compatibility with the computer's graphics adapter.

This monitor is Microsoft Windows Plug and Play compatible and the monitor will work correctly without installing the .INF file. Monitor Plug and Play compatibility requires that the computer's graphic card is VESA DDC2-compliant and that the monitor connects directly to the graphics card. Plug and Play does not work through separate BNC type connectors or through distribution buffers/boxes.

The Image Color Matching File

The .ICM files are data files that are used in conjunction with graphics programs to provide consistent color matching from monitor screen to printer, or from scanner to monitor screen. This file is activated from within graphics programs that support this feature.



NOTE: The ICM color profile is written in accordance with the International Color Consortium (ICC) Profile Format specification.

Installing the .INF and .ICM Files

After you determine that you need to update, you can install the .INF and .ICM files from the CD or download them.

Installing from the CD

To install the .INF and .ICM files on the computer from the CD:

1. Insert the CD in the computer CD-ROM drive. The CD menu is displayed.
2. View the **Monitor Driver Software Readme** file.
3. Select **Install Monitor Driver Software**.
4. Follow the on-screen instructions.
5. Ensure that the proper resolution and refresh rates appear in the Windows Display control panel.



NOTE: You may need to install the digitally signed monitor .INF and .ICM files manually from the CD in the event of an installation error. Refer to the Monitor Driver Software Readme file on the CD.

Downloading from the Worldwide Web

To download the latest version of .INF and .ICM files from the HP monitors support Web site:

1. Refer to <http://www.hp.com/support> and select the country region.
2. Follow the links for the monitor to the support page and download page.
3. Ensure the system meets the requirements.
4. Download the software by following the instructions.

Using the Auto-Adjustment Function

You can optimize the screen performance for the VGA (analog) input by using the **OK/auto** button on the monitor and the auto-adjustment pattern software utility on the CD provided.

Do not use this procedure if the monitor is using a DVI or DisplayPort input. If the monitor is using a VGA (analog) input, this procedure can correct the following image quality conditions:

- Fuzzy or unclear focus
- Ghosting, streaking or shadowing effects
- Faint vertical bars
- Thin, horizontal scrolling lines
- An off-center picture

To use the auto-adjustment feature:

1. Allow the monitor to warm up for 20 minutes before adjusting.
2. Press the **OK/auto** button on the monitor front panel.
 - You can also press the **Menu** button, then select **Image Control > Auto-Adjustment** from the OSD Main Menu. Refer to [Adjusting the Monitor Settings on page 20](#) in this chapter.
 - If the result is not satisfactory, continue with the procedure.
3. Insert the CD in the disc drive. The CD menu is displayed.
4. Select **Open Auto-Adjustment Software**. The setup test pattern is displayed.
5. Press the **OK/auto** button on the monitor front panel to produce a stable, centered image.
6. Press the **ESC** key or any other key on the keyboard to exit the test pattern.

Front Panel Controls

Figure 4-1 Monitor Front Panel Controls

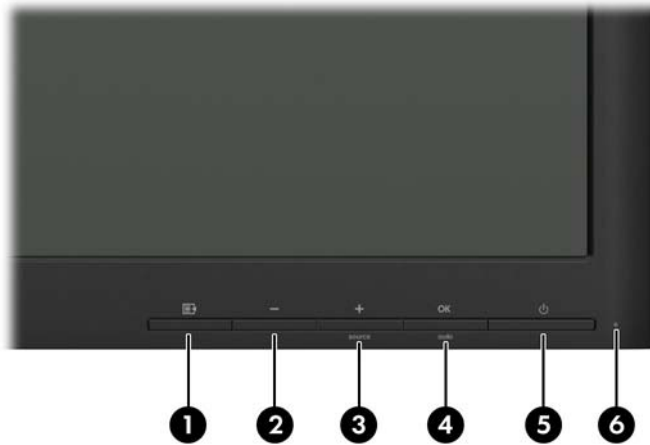







Table 4-1 Monitor Front Panel Controls

Control	Function
1 	Menu Opens, selects or exits the OSD menu.
2 	Minus If the OSD menu is on, press to navigate backward through the OSD menu and decrease adjustment levels.
3  source	Plus/source If the OSD menu is on, press to navigate forward through the OSD menu and increase adjustment levels. If the OSD menu is inactive, press to activate the source button that chooses the video signal input (VGA, DVI, or DisplayPort)
4 	OK/auto If the OSD menu is on, press to select the highlighted menu item. If the OSD menu is inactive, press to activate the auto adjustment feature to optimize the screen image.
5 	Power Turns the monitor on or off.
6	Power LED Blue = Fully powered. Amber = Sleep mode. Flashing Amber = Sleep Timer mode.

Adjusting the Monitor Settings

The monitor settings can be adjusted from the On-Screen Display (OSD) menu or from the HP Display Assistant utility.

 **NOTE:** If there is a problem with the display settings, try resetting the settings to the factory defaults by opening the OSD and selecting **Factory Reset** from the OSD menu.

Using the On-Screen Display Menu

Use the On-Screen Display (OSD) to adjust the screen image based on your viewing preferences. To access the OSD, do the following:

1. If the monitor is not already on, press the **Power** button to turn on the monitor.
2. To access the OSD Menu, press the **Menu** button on the monitor's front panel.
3. To navigate through the OSD Menu, press the **+** (Plus) button on the monitor's front panel to scroll up, or the **-** (Minus) button to scroll in reverse.
4. To select an item from the OSD Menu, use the **+** or **-** buttons to scroll to and highlight your selection, then press the **OK** button to select that function.
5. Adjust the item using the **+** or **-** buttons on the front panel to adjust the scale.
6. After adjusting the function, select **Save and Return**, or **Cancel** if you don't want to save the setting, then select **Exit** from the Main Menu.

 **NOTE:** If the buttons remain untouched for 10 seconds while displaying a menu, the OSD automatically saves all changes and exits.

OSD Menu Selections

The following table lists the On-Screen Display (OSD) menu selections and their functional descriptions. After changing an OSD menu item, and if the menu screen has these options, you may choose to:

- **Cancel**—to return to the previous menu level.
- **Save and Return**—to save all changes and return to the OSD Main Menu screen. This Save and Return option is only active if you change a menu item.

Table 4-2 OSD Menu











Icon	Main Menu	Submenu	Description
	Brightness	Adjustable scale	Adjusts the brightness level of the screen. The factory default range is 90.
	Contrast	Adjustable scale	Adjusts the contrast level of the screen. The factory default range is 80.
	Color		Selects the screen color. The factory default is 6500K or Custom Color, depending on the model.
		Warm (5000K)	Changes color to slightly reddish white.
		Standard (6500K)	Uses standard colors (default).
		Cool (9300K)	Changes color to slightly blueish white.
		Custom (RGB)	Selects and adjusts your own color scales: <ul style="list-style-type: none"> • Red Color - sets your own red color levels • Green Color - sets your own green color levels • Blue Color - sets your own blue color levels
	Image Control		Adjusts the screen image. (VGA input only)
		Auto Adjustment	Automatically adjusts the screen image.
		Clock	Minimizes any vertical bars or strips visible on the screen background. Adjusting the Clock will also change the horizontal screen image.
		Clock Phase	Adjusts the focus of the display. This adjustment allows you to remove any horizontal noise and clear or sharpen the image of characters.
		Horizontal Position	Adjusts the position of the screen image left and right.
		Vertical Position	Adjusts the position of the screen image up and down.
		Custom Scaling	Selects the method on how displayed information on the monitor will be formatted. Select: <ul style="list-style-type: none"> • Fill to Screen - image fills the entire screen and may look distorted or elongated because of non-proportional scaling of height and width. • Fill to Aspect Ratio - image is sized to fit the screen and maintains proportional image.

Table 4-2 OSD Menu (continued)

Icon	Main Menu	Submenu	Description
		Sharpness	Adjusts the screen image to look sharper or soft.
		Dynamic Contrast Ratio	Turns Dynamic Contrast Ratio On or Off. The factory default is Off.
	OSD Control		Provides a menu for adjusting the on-screen display (OSD) controls.
		Horizontal OSD Position	Changes the viewing position of the OSD menu to the left or right area of the screen. The factory default range is 50.
		Vertical OSD Position	Changes the viewing position of the OSD menu to the top or bottom area of the screen. The factory default range is 50.
		OSD Transparency	Adjust to view the background information through the OSD.
		OSD Timeout	Sets the time duration in seconds that the OSD is visible after the last button is pressed. The range is 5 – 60 seconds. The factory default is 30 seconds.
		Rotate OSD	Rotates the OSD menus and messages to support the monitor's pivot feature. The choices are Landscape and Portrait.
	Management		Selects the OSD and power management features of the monitor.
		Power Saver	Enables the power saving feature. Select: <ul style="list-style-type: none"> • On • Off The factory default is On.
		Power On Recall	Restores power to the monitor following an unexpected removal of power. Select: <ul style="list-style-type: none"> • On • Off The factory default is On.
		Mode Display	Displays the resolution, refresh rate and frequency information on the screen each time the OSD Main Menu is accessed. Select: <ul style="list-style-type: none"> • On • Off The factory default is On.

Table 4-2 OSD Menu (continued)













Icon	Main Menu	Submenu	Description
		Monitor Status	<p>Displays the operating status of the monitor each time the monitor is powered on. Select the location to display the status to:</p> <ul style="list-style-type: none"> • Top • Middle • Bottom • Off <p>The factory default is Top.</p>
		DDC/CI Support	<p>Allows the computer to control some OSD menu features such as brightness, contrast and color temperature. Set to:</p> <ul style="list-style-type: none"> • On • Off <p>The factory default is On.</p>
		Bezel Power LED	<p>Turns off the power LED on the front panel of the monitor. The factory default is On.</p>
		Sleep Timer	<p>Provides the timer adjustment menu options:</p> <ul style="list-style-type: none"> • Set Current Time—sets the current time in hours and minutes • Set Sleep Time—sets the time you want to place the monitor in sleep mode • Set on Time—sets the time you want the monitor to wake up from sleep mode • Timer—sets the Sleep Timer feature On or Off. The default setting is Off. • Sleep Now—immediately sets the monitor to enter sleep mode
	Language		<p>Selects the language in which the OSD menu is displayed. The factory default is English.</p>
	Information		<p>Selects and displays important information about the monitor.</p>
		Current Settings	<p>Provides the current input video mode.</p>
		Recommended Settings	<p>Provides the recommended resolution mode and refresh rate for the monitor.</p>
		Serial Number	<p>Reports the serial number of the monitor. The serial number is needed if contacting HP technical support.</p>
		FW Version	<p>Reports the firmware version of the monitor.</p>
		Backlight Hours	<p>Reports the total hours of backlight operation.</p>
		Service Support	<p>http://www.hp.com/support</p>
	Factory Reset		<p>Returns all OSD menu settings and DDC/CI controls to the factory default settings, except the Language.</p>

Table 4-2 OSD Menu (continued)

Icon	Main Menu	Submenu	Description
	Source Control		Selects the video input signal. DP (DisplayPort) is the factory default.
		DisplayPort	Selects DisplayPort as the video input signal.
		DVI	Selects DVI as the video input signal.
		VGA	Selects VGA as the video input signal.
		Default Source	Selects the default or primary video input signal when the monitor is connected to two active and valid video sources. The monitor will automatically determine the video format. The choices are: <ul style="list-style-type: none"> • DisplayPort • DVI • VGA The factory default is DisplayPort.
		Auto-Switch Source	Turns the system's automatic video signal input to On or Off. The factory default is On.
		Source Detection	This option is displayed in the OSD when a DisplayPort input is selected. You can set Source Detection to: <ul style="list-style-type: none"> • Always Active • Low Power The factory default is Low Power.
	Exit		Exits the OSD menu screen.

Optimizing Image Performance

Two controls in the on-screen display can be adjusted to improve image performance: Clock and Clock Phase.

 **NOTE:** The Clock and Clock Phase controls are adjustable only when using an analog input. These controls are not adjustable for digital inputs.

The Clock must first be set correctly since the Clock Phase settings are dependent on the main Clock setting. Use these controls only when the auto-adjustment function does not provide a satisfactory image.

- **Clock**—Increases/decreases the value to minimize any vertical bars or stripes visible on the screen background.
- **Clock Phase**—Increases/decreases the value to minimize video flickering or blurring.

 **NOTE:** When using the controls, you will obtain the best results by using the auto-adjustment pattern software utility provided on the CD.

When adjusting the Clock and Clock Phase values, if the monitor images become distorted, continue adjusting the values until the distortion disappears. To restore the factory settings, select **Yes** from the **Factory Reset** menu in the on-screen display.

To eliminate vertical bars (Clock):

1. Press the **Menu** button on the monitor's front panel to open the OSD Menu, and then select **Image Control > Clock**.
2. Press the **+** (Plus) or **-** (Minus) buttons on the monitor's front panel to eliminate vertical bars. Press the buttons slowly so that you do not miss the optimum adjustment point.

Figure 4-2 Clock Adjustment



3. After adjusting the Clock, if blurring, flickering, or bars appear on the screen, proceed to adjust the Clock Phase.

To remove flickering or blurring (Clock Phase):

1. Press the **Menu** button on the monitor's front panel to open the OSD Menu, and then select **Image Control > Clock Phase**.
2. Press the **+** (Plus) or **-** (Minus) buttons on the monitor's front panel to eliminate flickering or blurring. Flicking or blurring may not be eliminated depending on your computer or graphics controller card installed.

Figure 4-3 Clock Phase Adjustment



To correct screen position (Horizontal Position or Vertical Position):

1. Press the **Menu** button on the monitor's front panel to open the OSD Menu, and then select **Image Control > Horizontal Position** and/or **Vertical Position**.
2. Press the **+** (Plus) or **-** (Minus) buttons on the monitor's front panel to properly adjust the position of the image in the display area of the monitor. The Horizontal Position shifts the image left or right; the Vertical Position shifts the image up and down.

Figure 4-4 Horizontal or Vertical Position Adjustment

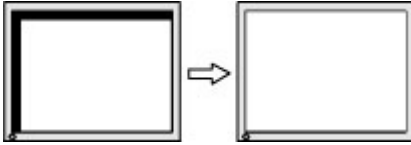

Using the HP Display Assistant Utility

HP Display Assistant, included on the software and documentation CD, is a software utility that guides you through the tuning process with easy to understand instructions and background patterns designed for each monitor control. It provides:

- Accurate screen calibration through the use of step-by-step instruction Wizards to obtain the best overall image quality.
- Software control of the monitor image and color settings to eliminate dependence on the monitor's front panel buttons and On-Screen Display (OSD) menu.
- Defined preset display settings for each individual user in a multi-user environment.
- Multiple preset display settings for a single user based on content and ambient lighting.
- Asset Management and Power Management capabilities that include remote control for individual or a group of displays on the domain from a centralized console application.

The HP Display Assistant Utility has two modes of operation: Wizard and OSD mode. The preferred method of use is Wizard mode, which takes you through a step-by-step process to accurately calibrate the monitor. This method relies on a sequence of steps that will obtain the best display results when completed.



NOTE: Refer to the HP Display Assistant user guide for additional information about the software.

Identifying Monitor Conditions

Special messages will appear on the monitor screen when identifying the following monitor conditions:

- **Monitor Status**—When the monitor is powered on or when the input source signal is changed, a Monitor Status message is displayed for five seconds. The message shows which input is the current active signal, the status of the auto-switch source setting (On or Off), the default source signal, the current preset display resolution, and the recommended preset display resolution.
- **Input Signal Out of Range—Change resolution setting to 1600 x 900 – 60Hz**—Indicates the monitor does not support the input signal because the resolution and/or refresh rate are set higher than the monitor supports (model LA2006x).
- **Input Signal Out of Range—Change resolution setting to 1920 x 1080 – 60Hz**—Indicates the monitor does not support the input signal because the resolution and/or refresh rate are set higher than the monitor supports (models LA2206x and LA2306x).

- **No Source Signal**—Indicates the monitor is not receiving a video signal from the PC on the monitor video input connector. Check to determine if the PC or input signal source is off or in the power saving mode.
- **Auto Adjustment in Progress**—Indicates the auto-adjustment function is active.
- **Monitor Going to Sleep**—Indicates the screen display is entering a sleep mode.
- **Check Video Cable**—Indicates the video cable is not properly connected to the computer.
- **OSD Lockout**—The OSD can be enabled or disabled by pressing and holding the **Menu** button on the front panel for 10 seconds. If the OSD is locked, the warning message **OSD Lockout** displays for ten seconds.
 - If the OSD is locked, press and hold the **Menu** button for 10 seconds to unlock the OSD.
 - If the OSD is unlocked, press and hold the **Menu** button for 10 seconds to lock the OSD.
- **Power Button Lockout**—Indicates the power button is locked. If the power button is locked, the warning message **Power Button Lockout** displays.
 - If the power button is locked, press and hold the power button for 10 seconds to unlock the power button function.
 - If the power button is unlocked, press and hold the power button for 10 seconds to lock out the power button function.
- **Dynamic Contrast Ratio On**—Indicates that Dynamic Contrast Ratio has been turned on. This occurs if Dynamic Contrast Ratio is turned on in the **Image Control** OSD menu.
- **Dynamic Contrast Ratio Off**—Indicates that Dynamic Contrast Ratio has been turned off. This occurs if Dynamic Contrast Ratio is turned off in the **Image Control** OSD menu.
- **Theft Mode Enabled**—Indicates that theft deterrence mode has been activated. Theft deterrence is an optional feature that can be set up in HP Display Assistant. Theft deterrence mode is triggered if both the power and display cables have been disconnected from the monitor, the monitor is reconnected to a different computer, and the theft deterrence PIN number is not entered within the elapsed time. When the monitor is in theft deterrence mode, all front panel buttons are disabled other than the power button.

Sleep Timer Mode

The Sleep Timer mode is an energy-saving feature that enables you to set a time for the monitor to power on and off at the same time every day. This also extends the life of the backlight bulbs in the monitor. The Sleep Timer has five settings:

- Set Current Time
- Set Sleep Time
- Set On Time
- Timer: On/Off
- Sleep Now

To set the timer:

1. Press the **Menu** button on the monitor front panel to display the **OSD Menu**.
2. Scroll down and highlight **Management**.
3. Press the **OK** button to select **Management**.

4. Scroll down and highlight and select **Sleep Timer > Set Current Time**.



NOTE: You must set the current local time before you reset the time for **Sleep Time** or **On Time**. Note that the time is displayed in a 24-hour clock format. For example, 1:15 p.m. is displayed as 13 hours 15 minutes.

A power failure or loss of power to the monitor will cause the timer to reset to 00:00. If this occurs, you will need to reset the sleep timer mode.

5. Press the **OK** button once to enter the adjustment mode for hours.
6. Press the - (Minus) or + (Plus) button to adjust the hour.
7. Press the **OK** button again to enter the time for minutes.
8. Press the - (Minus) or + (Plus) button to adjust the minutes.
9. Press the **OK** button to lock in the time chosen.
10. After setting the current time, the highlight automatically skips to **Set Sleep Time**. Repeat steps 6 through 9 to set **Sleep Time**.
11. If you do not want to set **Sleep Time**, press the **OK** button twice, then select **Save and Return** to exit the menu.
12. After setting **Sleep Time**, the highlight automatically skips to **Set On Time**. Repeat steps 6 through 9 to set **On Time**.
13. Set the **Timer mode** to **On** to activate the **Sleep Timer** settings.
14. When you are finished, select **Save and Return** to exit the menu.

The fifth selection, **Sleep Now**, turns the monitor backlights off immediately and stays in sleep mode until the next **On Time** activates or a monitor button is pressed.

A Troubleshooting

Solving Common Problems

The following table lists possible problems, the possible cause of each problem, and the recommended solutions.

Problem	Possible Cause	Solution
Screen is blank.	Power cord is disconnected.	Connect the power cord.
	Power button on front panel of the monitor is turned off.	Press the front panel power button. NOTE: If pressing the power button has no effect, press and hold the power button for 10 seconds to disable the power button lockout feature.
	Video cable is improperly connected.	Connect the video cable properly. Refer to Setting Up the Monitor on page 5 for more information.
	Screen blanking is active.	Press any key on the keyboard or move the mouse to inactivate the screen blanking utility.
Screen image appears distorted; text is fuzzy or blurred; image quality is degraded.	The computer's graphics card resolution is set lower or higher than the monitor's native resolution.	Set the computer's display resolution to the same mode as the monitor's recommended native screen resolution to provide the best picture quality.
Image appears blurred, indistinct, or too dark.	Brightness and contrast are too low.	Press the OK/auto button on the front panel. If this does not correct the image, press the Menu button to open the OSD Menu, and adjust the brightness and contrast scales as needed.
Image is not centered	Position may need adjustment.	Press the Menu button to access the OSD menu. Select Image Control/Horizontal Position or Vertical Position to adjust the horizontal or vertical position of the image.
Check Video Cable is displayed on screen.	Monitor video cable is disconnected.	Connect the appropriate video cable (DisplayPort, DVI, or VGA) between the computer and monitor. Be sure that the computer power is off while connecting the video cable.
Input Signal Out of Range. Change Settings to 1600 x 900 @ 60Hz (LA2006x model) OR Input Signal Out of Range. Change Settings to 1920 x 1080 @ 60Hz (LA2206x and LA2306x models).	Video resolution and/or refresh rate are set higher than what the monitor supports.	Restart the computer and enter Safe Mode. Change the settings to a supported setting (see Recognizing Preset Display Resolutions on page 35). Restart the computer so that the new settings take effect.
The monitor is off but it did not seem to enter into a low-power sleep mode.	The monitor's power saving control is disabled.	In the monitor's OSD menu, select Management > Power Saver . The control should be set to On to allow the monitor to enter into low-power modes.
OSD Lockout is displayed.	The monitor's OSD Lockout function is enabled.	Press and hold the Menu button for 10 seconds to disable the OSD Lockout function.
Power Button Lockout is displayed.	The monitor's Power Button Lockout function is enabled.	Press and hold the Power button for 10 seconds to unlock the power button function.

Online Technical Support

For the online access to technical support information, self-solve tools, online assistance, community forums of IT experts, broad multivendor knowledge base, monitoring and diagnostic tools, go to <http://www.hp.com/support>.

Preparing to Call Technical Support

If you cannot solve a problem using the troubleshooting tips in this section, you may need to call technical support. Have the following information available when you call:

- Monitor model number
- Monitor serial number
- Purchase date on invoice
- Conditions under which the problem occurred
- Error messages received
- Hardware configuration
- Name and version of the hardware and software you are using

B Technical Specifications

 **NOTE:** All specifications represent the typical specifications provided by HP's component manufacturers; actual performance may vary either higher or lower.

LA2006x Model

Table B-1 LA2006x Specifications

Display	50.8 cm wide screen	20 inches wide screen
Type	TFT LCD	
Viewable Image Size	50.8 cm diagonal	20-inch diagonal
Tilt	-5 to 30°	
Swivel	-180 to 180°	
Maximum Weight (Unpacked)	5.48 kg	12.1 lbs
Dimensions (include base)		
Height (highest position)	41.8 cm	16.46 inches
Height (lowest position)	31.63 cm	12.45 inches
Depth	21.63 cm	8.52 inches
Width	48.36 cm	19.04 inches
Maximum Graphic Resolution	1600 x 900 (60 Hz) analog input 1600 x 900 (60 Hz) digital input	
Optimum Graphic Resolution	1600 x 900 (60 Hz) analog input 1600 x 900 (60 Hz) digital input	
Text Mode	720 x 400	
Dot Pitch	0.2768 (H) x 0.2768 (W) mm	
Pixels Per Inch	91.8 PPI	
Horizontal Frequency	24 to 83 kHz	
Vertical Refresh Rate	50 to 76 Hz	
Environmental Requirements Temperature		
Operating Temperature	5 to 35° C	41 to 95° F
Storage Temperature	-20 to 60° C	-4 to 140° F
Relative Humidity	20 to 80%	
Power Source	100 – 240 VAC 50/60 Hz	

Table B-1 LA2006x Specifications (continued)

Altitude:		
Operating	0 to 5000 m	0 to 16,400 feet
Storage	0 to 12192 m	0 to 40,000 feet
Measured Power Consumption:		
Full Power	34.0 watts	
Typical Settings	29.0 watts	
Energy Star® Test Methods	24.5 watts	
Sleep	0.5 watts	
Switch Off	0.5 watts	
Input Terminal	One VGA connector with cable included; one DVI connector with cable included; one DisplayPort connector (cable not included)	

LA2206x Model

Table B-2 LA2206x Specifications

Display	54.61 cm wide screen	21.5 inches wide screen
Type	TFT LCD	
Viewable Image Size	54.61 cm diagonal	22-inch diagonal
Tilt	-5 to 30°	
Swivel	-180 to 180°	
Maximum Weight (Unpacked)	6.0 kg	13.24 lbs
Dimensions (include base)		
Height (highest position)	43.87 cm	17.27 inches
Height (lowest position)	33.35 cm	13.13 inches
Depth	22.72 cm	8.94 inches
Width	51.8 cm	20.39 inches
Maximum Graphic Resolution	1920 x 1080 (60 Hz) analog input 1920 x 1080 (60 Hz) digital input	
Optimum Graphic Resolution	1920 x 1080 (60 Hz) analog input 1920 x 1080 (60 Hz) digital input	
Text Mode	720 x 400	
Dot Pitch	0.248 (H) x 0.248 (W) mm	
Pixels Per Inch	102 PPI	
Horizontal Frequency	24 to 94 kHz	
Vertical Refresh Rate	50 to 76 Hz	

Table B-2 LA2206x Specifications (continued)

Environmental Requirements Temperature		
Operating Temperature	5 to 35° C	41 to 95° F
Storage Temperature	-20 to 60° C	-4 to 140° F
Relative Humidity	20 to 80%	
Power Source	100 – 240 VAC 50/60 Hz	
Altitude:		
Operating	0 to 5000 m	0 to 16,400 feet
Storage	0 to 12192 m	0 to 40,000 feet
Measured Power Consumption:		
Full Power	38 watts	
Typical Settings	33 watts	
Energy Star® Test Methods	25 watts	
Sleep	0.5 watts	
Switch Off	0.5 watts	
Input Terminal	One VGA connector with cable included; one DVI connector with cable included; one DisplayPort connector (cable not included)	

LA2306x Model

Table B-3 LA2306x Specifications

Display	58.42 cm wide screen	23 inches wide screen
Type	TFT LCD	
Viewable Image Size	58.42 cm diagonal	23–inch diagonal
Tilt	-5 to 30°	
Swivel	-180 to 180°	
Maximum Weight (Unpacked)	6.8 kg	15.0 lbs
Dimensions (include base)		
Height (highest position)	46.62 cm	18.37 inches
Height (lowest position)	35.11 cm	13.83 inches
Depth	24.95 cm	9.83 inches
Width	55.15 cm	21.73 inches
Maximum Graphic Resolution	1920 x 1080 (60 Hz) analog input 1920 x 1080 (60 Hz) digital input	
Optimum Graphic Resolution	1920 x 1080 (60 Hz) analog input 1920 x 1080 (60 Hz) digital input	

Table B-3 LA2306x Specifications (continued)

Text Mode	720 × 400	
Dot Pitch	0.265 (H) x 0.265 (W) mm	
Pixels Per Inch	95.8 PPI	
Horizontal Frequency	24 to 94 kHz	
Vertical Refresh Rate	50 to 76 Hz	
Environmental Requirements Temperature		
Operating Temperature	5 to 35° C	41 to 95° F
Storage Temperature	-20 to 60° C	-4 to 140° F
Relative Humidity	20 to 80%	
Power Source	100 – 240 VAC 50/60 Hz	
Altitude:		
Operating	0 to 5000 m	0 to 16,400 feet
Storage	0 to 12192 m	0 to 40,000 feet
Measured Power Consumption:		
Full Power	40 watts	
Typical Settings	35 watts	
Energy Star® Test Methods	33.1 watts	
Sleep	0.5 watts	
Switch Off	0.5 watts	
Input Terminal	One VGA connector with cable included; one DVI connector with cable included; one DisplayPort connector (cable not included)	

Recognizing Preset Display Resolutions

The display resolutions listed below are the most commonly used modes and are set as factory defaults. This monitor automatically recognizes these preset modes and they will appear properly sized and centered on the screen.

LA2006x Model

Table B-4 Factory Preset Modes

Preset	Pixel Format	Horz Freq (kHz)	Vert Freq (Hz)
1	640 × 480	31.469	59.94
2	720 × 400	31.469	70.087
3	800 × 600	37.879	60.317
4	1024 × 768	48.363	60.004
5	1280 × 720	45.0	60.0
6	1280 × 1024	63.981	60.02
7	1440 × 900	55.935	59.887
8	1600 × 900	60.0	60.0

Table B-5 High Definition Video Formats

Preset	Timing Name	Pixel Format	Horz Freq (kHz)	Vert Freq (Hz)
1	480p	720 × 480	31.469	60
2	576p	720 × 576	31.25	50
3	720p50	1280 × 720	37.5	50
4	720p60	1280 × 720	45	60

LA2206x Model

Table B-6 Factory Preset Modes

Preset	Pixel Format	Horz Freq (kHz)	Vert Freq (Hz)
1	640 × 480	31.469	59.940
2	720 × 400	31.469	70.087
3	800 × 600	37.879	60.317
4	1024 × 768	48.363	60.004
5	1280 × 720	45.00	59.94
6	1280 × 1024	63.981	60.02
7	1440 × 900	55.935	59.887

Table B-6 Factory Preset Modes (continued)

8	1680 × 1050	65.29	59.954
9	1920 × 1080	67.50	60.00

Table B-7 High Definition Video Formats

Preset	Timing Name	Pixel Format	Horz Freq (kHz)	Vert Freq (Hz)
1	480p	720 × 480	31.469	60
2	576p	720 × 576	31.25	50
3	720p50	1280 × 720	37.5	50
4	720p60	1280 × 720	45	60
5	1080p50	1920 × 1080	56.25	50
6	1080p60	1920 × 1080	67.5	60

LA2306x Model

Table B-8 Factory Preset Modes

Preset	Pixel Format	Horz Freq (kHz)	Vert Freq (Hz)
1	640 × 480	31.469	59.940
2	720 × 400	31.469	70.087
3	800 × 600	37.879	60.317
4	1024 × 768	48.363	60.004
5	1280 × 720	45.00	60.00
6	1280 × 1024	63.981	60.02
7	1440 × 900	55.935	59.887
8	1680 × 1050	65.29	59.954
9	1920 × 1080	67.5	60.00

Table B-9 High Definition Video Formats

Preset	Timing Name	Pixel Format	Horz Freq (kHz)	Vert Freq (Hz)
1	480p	720 × 480	31.469	60
2	576p	720 × 576	31.25	50
3	720p50	1280 × 720	37.5	50
4	720p60	1280 × 720	45	60
5	1080p50	1920 × 1080	56.25	50
6	1080p60	1920 × 1080	67.5	60

Entering User Modes

The video controller signal may occasionally call for a mode that is not preset if:

- You are not using a standard graphics adapter.
- You are not using a preset mode.

If this occurs, you may need to readjust the parameters of the monitor screen by using the on-screen display. Your changes can be made to any or all of these modes and saved in memory. The monitor automatically stores the new setting, then recognizes the new mode just as it does a preset mode. In addition to the factory preset modes, there are at least 10 user modes that can be entered and stored.

Energy Saver Feature

The monitors support a reduced power state. The reduced power state will be entered into if the monitor detects the absence of either the horizontal sync signal and/or the vertical sync signal. Upon detecting the absence of these signals, the monitor screen is blanked, the backlight is turned off, and the power light is turned amber. When the monitor is in the reduced power state, the monitor will utilize .5 watts of power. There is a brief warm up period before the monitor will return to its normal operating mode.

Refer to the computer manual for instructions on setting energy saver features (sometimes called power management features).



NOTE: The above power saver feature only works when connected to computers that have energy saver features.

By selecting the settings in the monitor's Energy Saver utility, you can also program the monitor to enter into the reduced power state at a predetermined time. When the monitor's Energy Saver utility causes the monitor to enter the reduced power state, the power light blinks amber.

C Agency Regulatory Notices

Federal Communications Commission Notice

This equipment has been tested and found to comply with the limits for a Class B digital device, pursuant to Part 15 of the FCC Rules. These limits are designed to provide reasonable protection against harmful interference in a residential installation. This equipment generates, uses, and can radiate radio frequency energy and, if not installed and used in accordance with the instructions, may cause harmful interference to radio communications. However, there is no guarantee that interference will not occur in a particular installation. If this equipment does cause harmful interference to radio or television reception, which can be determined by turning the equipment off and on, the user is encouraged to try to correct the interference by one or more of the following measures:

- Reorient or relocate the receiving antenna.
- Increase the separation between the equipment and the receiver.
- Connect the equipment into an outlet on a circuit different from that to which the receiver is connected.
- Consult the dealer or an experienced radio or television technician for help.

Modifications

The FCC requires the user to be notified that any changes or modifications made to this device that are not expressly approved by Hewlett Packard Company may void the user's authority to operate the equipment.

Cables

Connections to this device must be made with shielded cables with metallic RFI/EMI connector hoods to maintain compliance with FCC Rules and Regulations.

Declaration of Conformity for Products Marked with the FCC Logo (United States Only)

This device complies with Part 15 of the FCC Rules. Operation is subject to the following two conditions:

1. This device may not cause harmful interference.
2. This device must accept any interference received, including interference that may cause undesired operation.

For questions regarding the product, contact:

Hewlett Packard Company

P. O. Box 692000, Mail Stop 530113

Houston, Texas 77269-2000

Or, call 1-800-HP-INVENT (1-800 474-6836)

For questions regarding this FCC declaration, contact:

Hewlett Packard Company

P. O. Box 692000, Mail Stop 510101

Houston, Texas 77269-2000

Or, call (281) 514-3333

To identify this product, refer to the Part, Series, or Model number found on the product.

Canadian Notice

This Class B digital apparatus meets all requirements of the Canadian Interference-Causing Equipment Regulations.

Avis Canadien

Cet appareil numérique de la classe B respecte toutes les exigences du Règlement sur le matériel brouilleur du Canada.

European Union Regulatory Notice



Products bearing the CE marking comply with the following EU Directives:

- Low Voltage Directive 2006/95/EC
- EMC Directive 2004/108/EC
- Ecodesign Directive 2009/125/EC, where applicable

CE compliance of this product is valid if powered with the correct CE-marked AC adapter provided by HP.

Compliance with these directives implies conformity to applicable harmonized European standards (European Norms) that are listed in the EU Declaration of Conformity issued by HP for this product or product family and available (in English only) either within the product documentation or at the following web site: <http://www.hp.eu/certificates> (type the product number in the search field).

The compliance is indicated by one of the following conformity markings placed on the product:

	For non-telecommunications products and for EU harmonized telecommunications products, such as Bluetooth® within power class below 10mW.
	For EU non-harmonized telecommunications products (If applicable, a 4-digit notified body number is inserted between CE and !).

Please refer to the regulatory label provided on the product.

The point of contact for regulatory matters is: Hewlett-Packard GmbH, Dept./MS: HQ-TRE, Herrenberger Strasse 140, 71034 Boeblingen, GERMANY.

German Ergonomics Notice

HP products which bear the “GS” approval mark, when forming part of a system comprising HP brand computers, keyboards and monitors that bear the “GS” approval mark, meet the applicable ergonomic requirements. The installation guides included with the products provide configuration information.

Japanese Notice

この装置は、クラスB情報技術装置です。この装置は、家庭環境で使用することを目的としていますが、この装置がラジオやテレビジョン受信機に近接して使用されると、受信障害を引き起こすことがあります。取扱説明書に従って正しい取り扱いをして下さい。

VCCI-B

Korean Notice

B급 기기

(가정용 방송통신기기)

이 기기는 가정용(B급)으로 전자파적합등록을 한 기기로서 주로 가정에서 사용하는 것을 목적으로 하며, 모든 지역에서 사용할 수 있습니다.

Power Cord Set Requirements

The monitor power supply is provided with Automatic Line Switching (ALS). This feature allows the monitor to operate on input voltages between 100–120V or 200–240V.

The power cord set (flexible cord or wall plug) received with the monitor meets the requirements for use in the country where you purchased the equipment.

If you need to obtain a power cord for a different country, you should purchase a power cord that is approved for use in that country.

The power cord must be rated for the product and for the voltage and current marked on the product's electrical ratings label. The voltage and current rating of the cord should be greater than the voltage and current rating marked on the product. In addition, the cross-sectional area of the wire must be a minimum of 0.75 mm² or 18 AWG, and the length of the cord must be between 6 feet (1.8 m) and 12 feet (3.6 m). If you have questions about the type of power cord to use, contact an authorized HP service provider.

A power cord should be routed so that it is not likely to be walked on or pinched by items placed upon it or against it. Particular attention should be paid to the plug, electrical outlet, and the point where the cord exits from the product.

Japanese Power Cord Requirements

For use in Japan, use only the power cord received with this product.

⚠ CAUTION: Do not use the power cord received with this product on any other products.

Product Environmental Notices

ENERGY STAR® Qualification

HP Displays marked with the ENERGY STAR® certification mark meet the requirements of the U.S. Environmental Protection Agency (EPA) ENERGY STAR® program. The EPA ENERGY STAR® certification mark does not imply endorsement by the EPA. As an ENERGY STAR® Partner, Hewlett Packard Company has determined that this product meets the ENERGY STAR® program requirements for display energy efficiency.

The following ENERGY STAR® certification mark appears on all ENERGY STAR® qualified displays:



The ENERGY STAR® program specifications for displays and computers were created by the EPA to promote energy efficiency and reduce air pollution through more energy-efficient equipment in homes, offices, and factories. One way products achieve this goal is by using the Microsoft Windows power management feature to reduce power consumption when the product is not in use.

The power management feature enables the computer to initiate a low-power or “sleep” mode after a period of user inactivity. When used with an external ENERGY STAR® qualified display, this feature also supports similar power management features for the display. To take advantage of these potential energy savings, users should use the default power management settings that are provided with ENERGY STAR qualified computers and displays. The default power management settings on ENERGY STAR® qualified computers are preset to behave in the following ways when the system is operating on AC power:

- Turn off an external display after 15 minutes of user inactivity
- Initiate a low power sleep mode for the computer after 30 minutes of user inactivity

ENERGY STAR® qualified computers exit the low power sleep mode and ENERGY STAR® qualified displays resume operation when the user resumes use of the computer. Examples include the user pressing the power/sleep button, receiving an input signal from an input device, receiving an input signal from a network connection with the Wake On LAN (WOL) feature enabled, etc.

Additional information on the ENERGY STAR® program, its environmental benefits and the potential energy and financial savings of the power management feature can be found on the EPA ENERGY STAR® Power Management Web site at <http://www.energystar.gov/powermanagement>.

Materials Disposal

Some HP LCD monitors contain mercury in the fluorescent lamps that might require special handling at end-of-life.

Disposal of this material can be regulated because of environmental considerations. For disposal or recycling information, contact the local authorities or the Electronic Industries Alliance (EIA) <http://www.eiae.org>.

Disposal of Waste Equipment by Users in Private Household in the European Union



This symbol on the product or on its packaging indicates that this product must not be disposed of with your household waste. Instead, it is your responsibility to dispose of your waste equipment by handing it over to a designated collection point for the recycling or waste electrical and electronic equipment. The separate collection and recycling of your waste equipment at the time of disposal will help to conserve natural resources and ensure that it is recycled in a manner that protects human health and the environment. For more information about where you can drop off your waste equipment for recycling, please contact the local city office, the household waste disposal service or the shop where you purchased the product.

HP Recycling Program

HP encourages customers to recycle used electronic hardware, HP original print cartridges, and rechargeable batteries. For more information about recycling programs, go to <http://www.hp.com/recycle>.

Chemical Substances

HP is committed to providing our customers with information about the chemical substances in our products as needed to comply with legal requirements such as REACH (Regulation EC No 1907/2006 of the European Parliament and Council). A chemical information report for this product can be found at <http://www.hp.com/go/reach>.

Restriction of Hazardous Substances (RoHS)

A Japanese regulatory requirement, defined by specification JIS C 0950, 2005, mandates that manufacturers provide Material Content Declarations for certain categories of electronic products offered for sale after July 1, 2006. To view the JIS C 0950 material declaration for this product, visit <http://www.hp.com/go/jisc0950>.

2008年、日本における製品含有表示方法、JISC0950が公示されました。製造事業者は、2006年7月1日以降に販売される電気・電子機器の特定化学物質の含有につきまして情報提供を義務付けられました。製品の部材表示につきましては、www.hp.com/go/jisc0950を参照してください。

产品中有毒有害物质或元素的名称及含量

根据中国《电子信息产品污染控制管理办法》

LCD 显示器

部件名称	有毒有害物质或元素					
	铅 (Pb)	汞 (Hg)	镉 (Cd)	六价铬 (Cr(VI))	多溴联苯 (PBB)	多溴二苯醚 (PBDE)
液晶显示屏 - CCFL	X	X	○	○	○	○
液晶显示屏 - WLED	X	○	○	○	○	○
机箱 / 其他	X	○	○	○	○	○

○: 表示该有毒或有害物质在该部件所有均质材料中的含量均在 SJ/T11363-2006 标准规定的限量要求以下。

X: 表示该有毒或有害物质至少在该部件的某一均质材料中的含量超出 SJ/T11363-2006 标准规定的限量要求。

表中标有 "X" 的所有部件都符合欧盟 RoHS 法规，即“欧洲议会和欧洲理事会 2003 年 1 月 27 日关于在电子电气设备中限制使用某些有害物质的 2002/95/EC 号指令”。

注：环保使用期限的参考标识取决于产品正常工作的温度和湿度等条件。

Turkey EEE Regulation

In Conformity with the EEE Regulation

EEE Yönetmeliğine Uygundur

D LCD Monitor Quality and Pixel Policy

The TFT monitor uses high-precision technology, manufactured according to HP standards, to guarantee trouble-free performance. Nevertheless, the display may have cosmetic imperfections that appear as small bright or dark spots. This is common to all LCD displays used in products supplied by all vendors and is not specific to the HP LCD. These imperfections are caused by one or more defective pixels or sub-pixels.

- A pixel consists of one red, one green, and one blue sub-pixel.
- A defective whole pixel is always turned on (a bright spot on a dark background), or it is always off (a dark spot on a bright background). The first is the more visible of the two.
- A defective sub-pixel (dot defect) is less visible than a defective whole pixel and is small and only visible on a specific background.

To locate defective pixels, the monitor should be viewed under normal operating conditions, in normal operating mode at a supported resolution and refresh rate, from a distance of approximately 50 cm (20 in).

HP expects that, over time, the industry will continue to improve its ability to produce LCDs with fewer cosmetic imperfections and HP will adjust guidelines as improvements are made.