

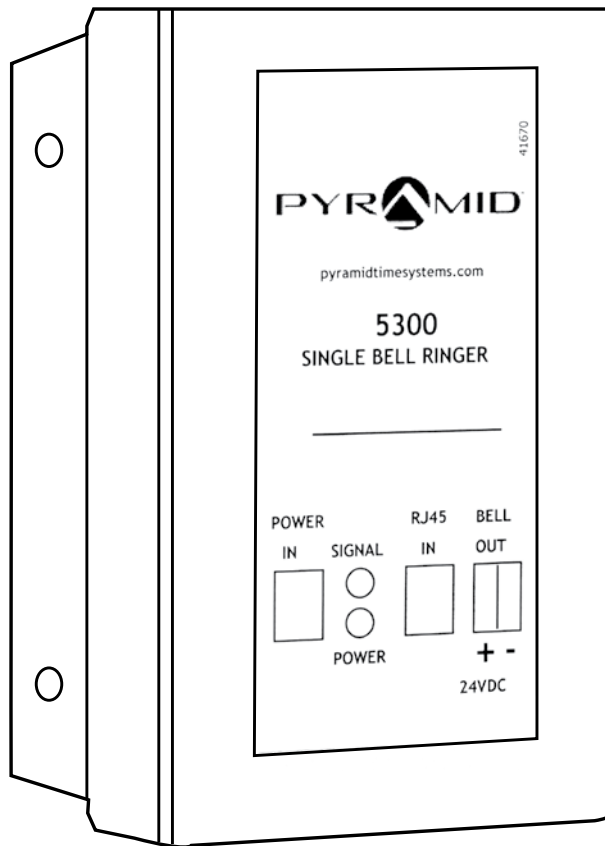

# **TIMETRA<sup>TM</sup>** Sync **5300**

Bell Ringer

## Installation Instructions



# TIMETRAX™ SYNC 5300 BELL RINGER

## Installation Instructions

SIMPLE : SMART®

### OVERVIEW

Thank you for choosing a TimeTrax Sync™ 5300 Bell Ringer. The TimeTrax Sync™ 5300 directs bells and horns (sold separately) to promote accountability, productivity and punctuality with standardized class changes, shift changes, production schedules, arrival time, breaks and departure time. The 5300 handles single zone configuration and provides 24V DC power to bells and horns up to 1amp maximum total load.

TimeTrax Sync™ 5300 interfaces with Pyramid 4000/5000 Series Auto Totaling Time Clocks, TimeTrax™ Elite Series Automated Time Clock Systems or TimeTrax™ RF Wireless Transmitter to receive bell/horn activation signals. Bell and horn schedules may be configured using any compatible Pyramid time clock or transmitter (sold separately). Please see page 10 for a complete list of bells, horns, and compatible signal devices.

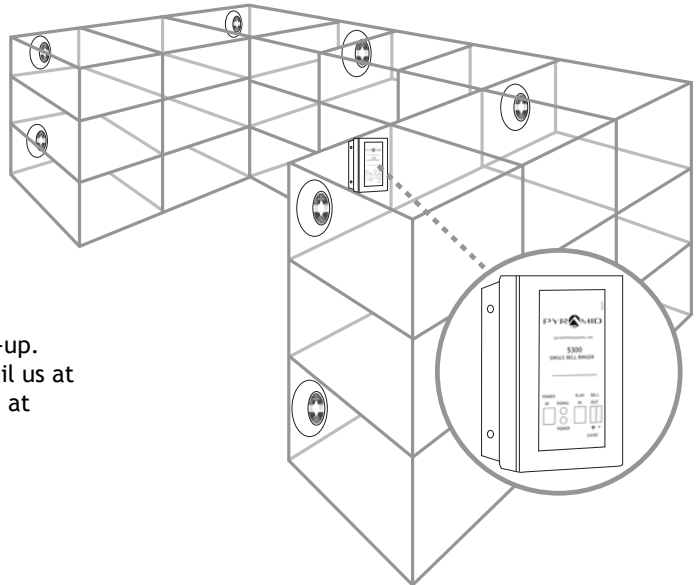
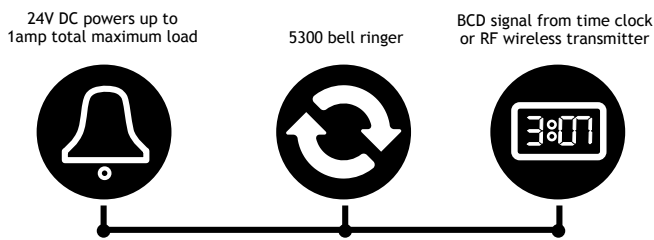

Please read through this User Guide for simple installation and set-up. For more information, please visit [pyramiddtimesystems.com](http://pyramiddtimesystems.com), email us at [customersupport@ptitime.com](mailto:customersupport@ptitime.com) or call our technical support team at 888.479.7264 during regular business hours: 8am-5pm EST, M-F.

### 5300 BELL RINGER : FEATURES

Zone Capacity	Single
5300 Interface	Interfaces with Pyramid Auto Totaling Time Clocks, Elite Time Clock Systems, or TimeTrax Sync™ RF Wireless Transmitters
Bell/Horn Power	24V DC maximum total load
Bell Scheduling	Unlimited
Warranty	1-Year manufacturer's limited warranty

### CONTENTS

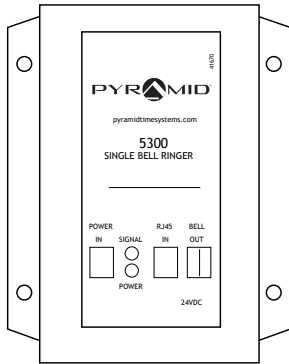

TimeTrax Sync™ 5300  
Bell Ringer



5300  
User Guide

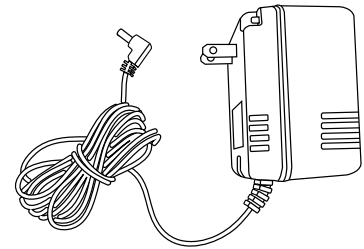

Power Adapter

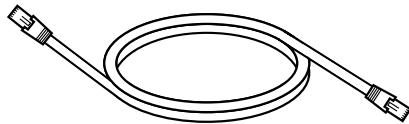

RJ45 Cable

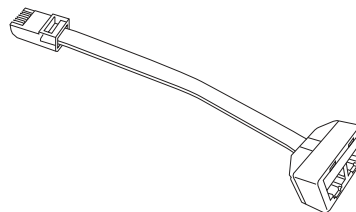

RJ45 Splitter Cable

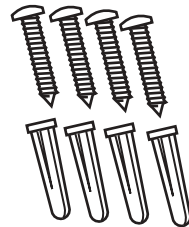

Mounting Screws (4)  
Wall Anchors (4)

### WALL MOUNTING

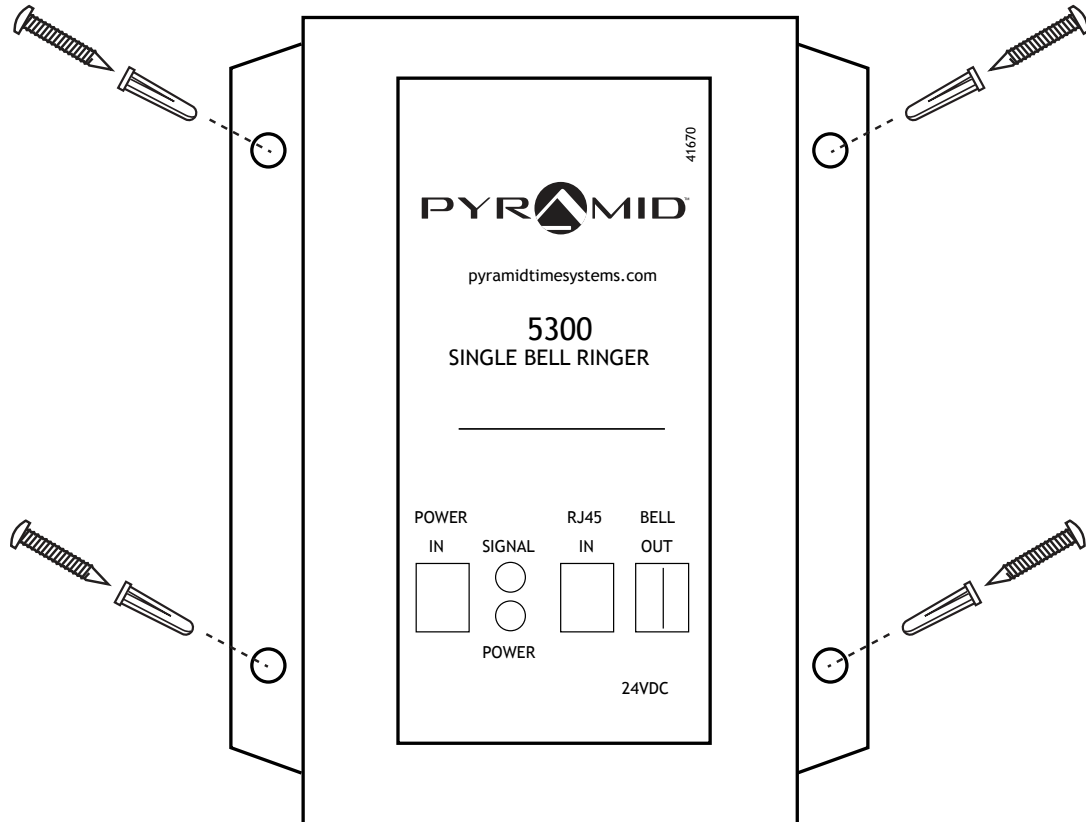

- ① Select a location for mounting. Power outlet should be within 5 feet of mounting location.
- ② Hold the case in desired location and mark holes for drilling. Drill holes for mounting.
- ③ For sheet rock walls, use plastic anchors.

# TIMETRAX™ SYNC 5300 BELL RINGER

## Installation Instructions

SIMPLE : SMART®

### INSTALLATION

- ① The 5300 Bell Ringer requires one of the following Pyramid interface products for operation; 4000, 4000HD, 5000HD, PSDLAUBKK, TTPROXEK, TTELITEEK, 9T1WI, S9DWXSLAUB. Prior to installation, make sure the time is set on the time clock or transmitter from which bell/horn signal will be sent.

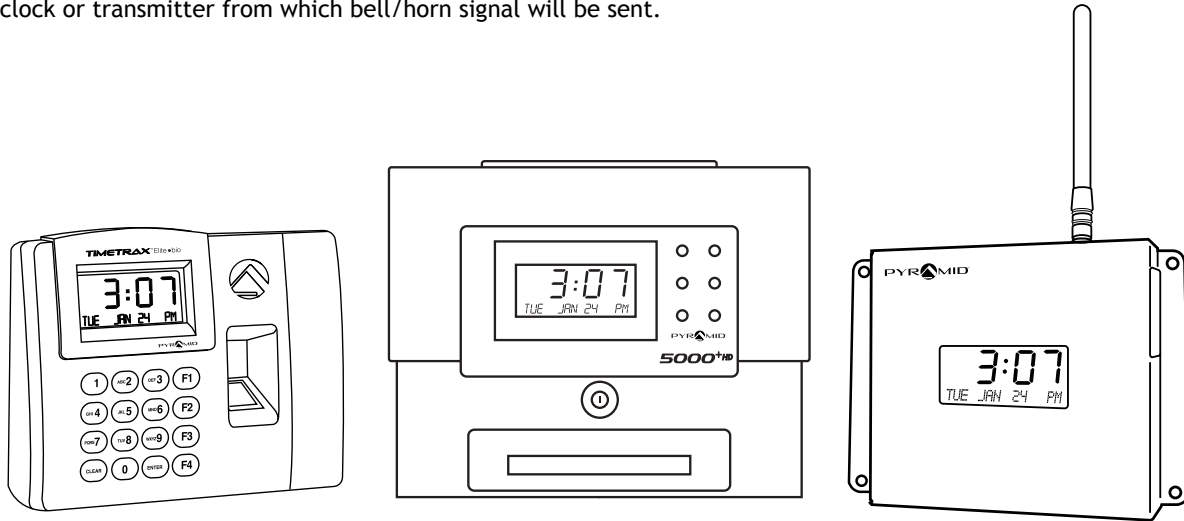

- ② Plug the end of the power supply into the power port located on the far left side of the bottom of the 5300 case.
- ③ Plug power supply into standard electrical wall outlet. The bottom light will turn green upon power connection.

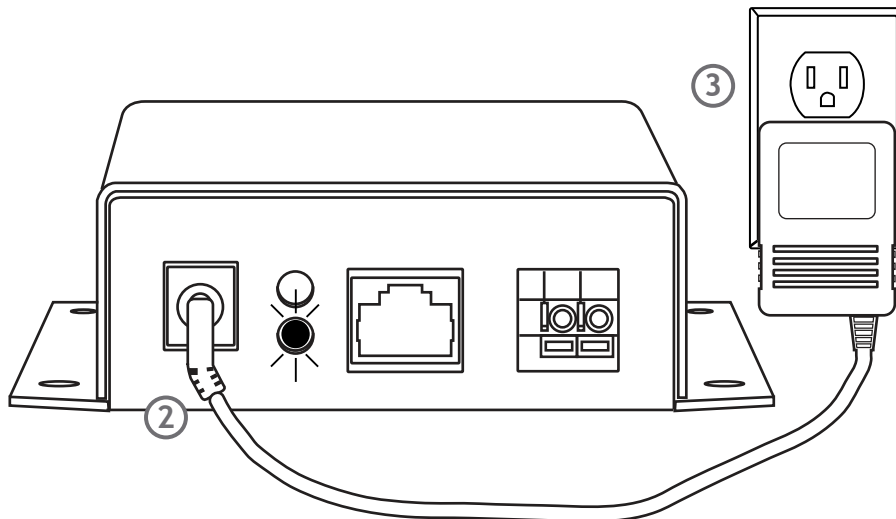

### INSTALLATION (Cont.)

- ④ Insert RJ45 cable into the BCD port located on the bottom of the 5300 case.
- ⑤ Insert other end RJ45 cable into BCD port on the side or back of time clock. The top light will turn green, signaling connection (this can take up to 2 minutes). Continue to step 8 on next page.

**Note:** The time clock must be powered and have the time set. If the time is not set, the indicator light will not turn on.

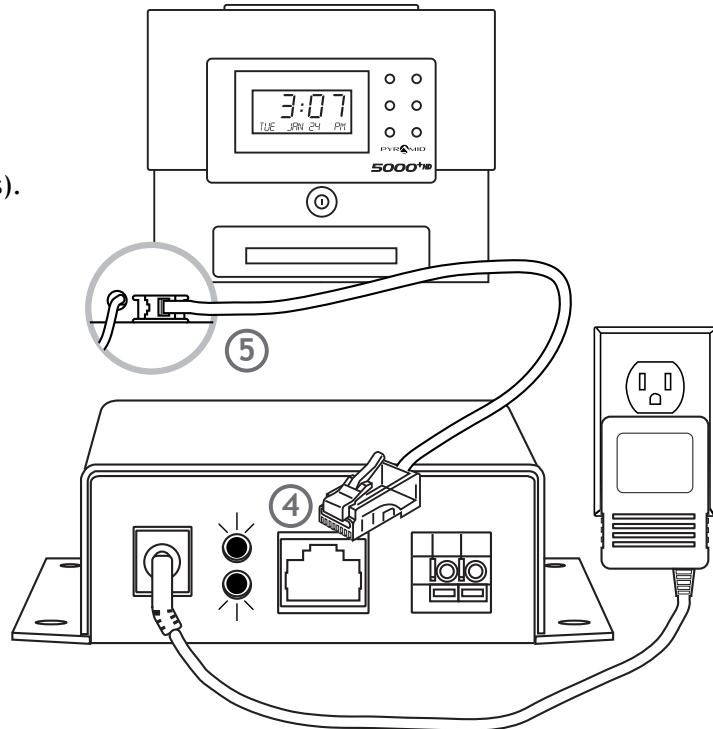

TimeTrax™ Elite Time Clock System

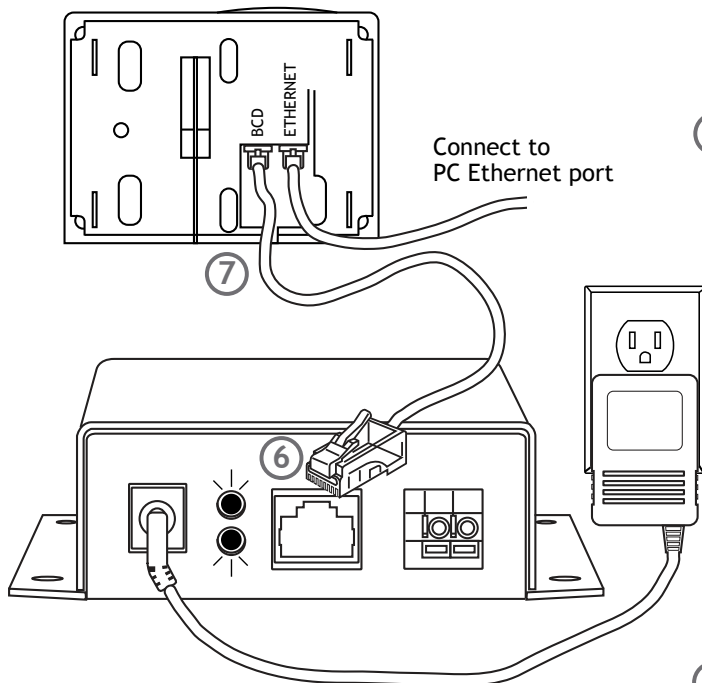

- ⑥ If using 5300 Bell Ringer with a TimeTrax™ Elite Time Clock System or TimeTrax Sync™ RF Wireless Transmitter, insert the end of the RJ45 cable into the BCD port located on the bottom of the 5300 case.

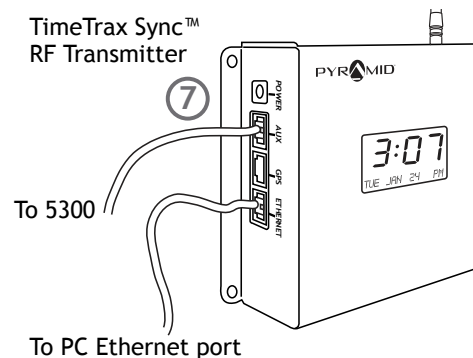

- ⑦ Insert other end RJ45 cable into BCD port on back of TimeTrax™ Elite Time Clock System or AUX port on back or side of TimeTrax Sync™ RF Wireless Transmitter.

### BELL/HORN CONNECTION

- ⑧ Connect 24Volt DC bell or horn to the 5300 bell ringer by pushing the bell wire into the connector located on the far right of the bottom of the 5300. Positive (red) is on the left, and negative (black) is on the right. To remove, gently push the orange clip down to release wires.

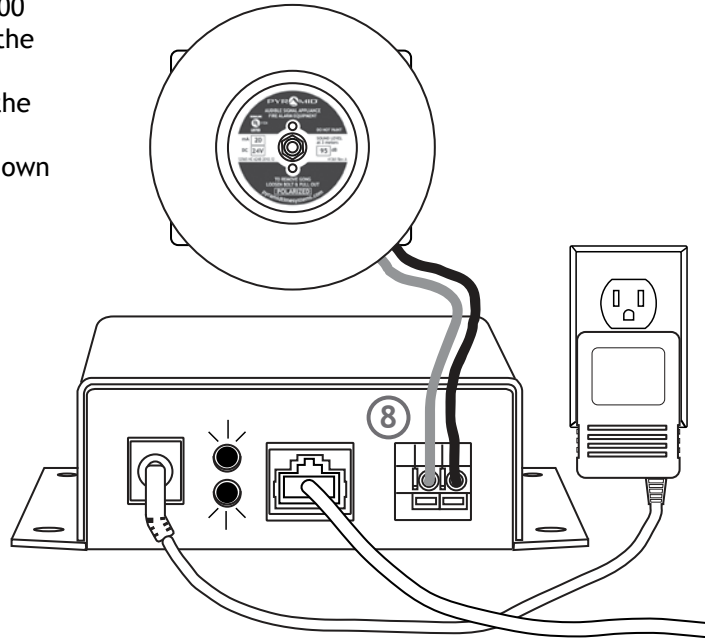

- ⑨ If more than one bell or horn is needed, daisy chain the units in parallel.

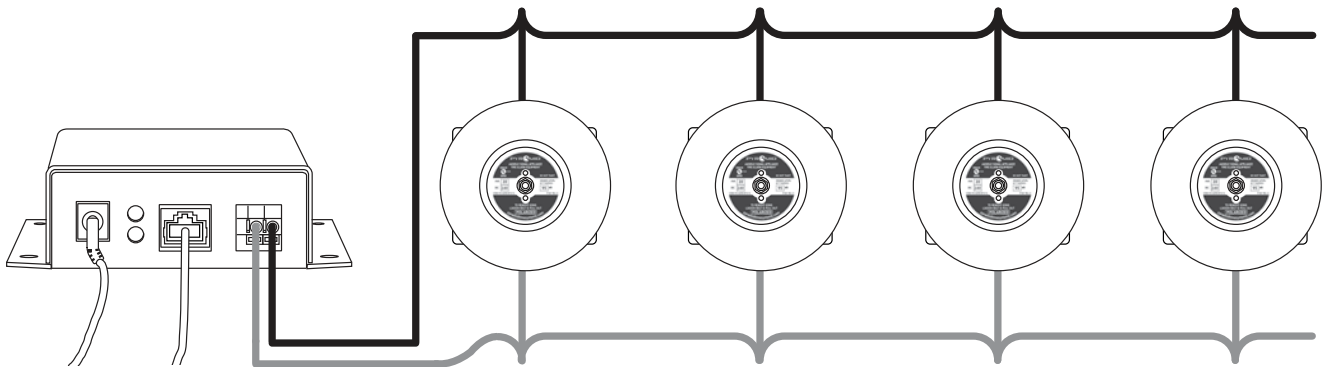

### BELL SCHEDULES

- ⑩ If using a TimeTrax™ Elite Time Clock System or a TimeTrax Sync™ RF Wireless Transmitter to send a signal to the 5300, set up bell schedule according to the time clock or transmitter software instructions. Once the schedule has been saved, be sure to upload the schedule.

#### TIMETRAX™ ELITE TIME CLOCK SYSTEM BELL SCHEDULING

The screenshot shows a software window titled "Add Bell Event". At the top left are "Save & Close" and "Close" buttons. Below them, the "Ring Time" is set to "9:15 AM" and "Ring Duration" is set to "5 (Secs)". Under "Select Days", checkboxes are checked for Monday, Tuesday, Wednesday, Thursday, and Friday. Under "Select Zones", checkboxes are checked for Zone 1 and Zone 4.

#### TIMETRAX SYNC™ RF WIRELESS TRANSMITTER BELL SCHEDULING

The screenshot shows a software window titled "Add Bell Event". At the top left are "Save & Close" and "Close" buttons. Below them, the "Ring Time" is set to "09:15 AM" and "Ring Duration" is set to "5.0 Sec(s)". Under "Select Days", checkboxes are checked for Monday, Tuesday, Wednesday, Thursday, and Friday. Under "Select Zones", checkboxes are checked for Contact Zone 1 and Contact Zone 4.

- ⑪ If using a Pyramid 4000/5000 series auto totaling time clock to send a signal to the 5300, refer to user guide for bell schedule instructions.

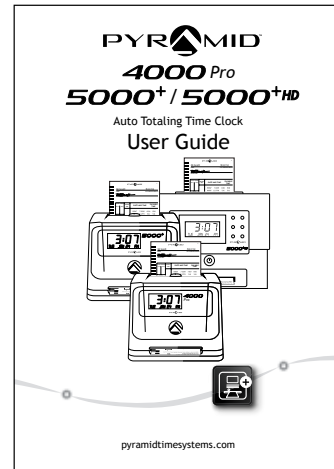



# TIMETRAX™ SYNC 5300 BELL RINGER

## Installation Instructions

SIMPLE : SMART®

### SPECIFICATIONS

SPECIFICATIONS	
Zones	Single
Signal Devices	41361 6" 24V DC bell, 41392 8" 24V DC bell 41362 24V DC horn
Max Load	1 amp
Compatible Signal Devices	4000, 4000HD, 4000Pro, 5000, 5000HD Auto Totaling Time Clocks, PSDLAUBKK, TTPROXEK, TTELITEEK Elite Time Clock Systems, 9T1WI, S9DWXSLAUB RF Wireless Transmitters
Dimensions (WxHxD)	4.25" X 5.25" X 1.25"
Weight	.85lbs
Power	110VAC or 220VAC, 50/60Hz (UL/CUL listed power supply)
Mounting	Wall Mount
Color	Black
Includes	5300 24 Volt Single Zone Bell Ringer, 50' RJ45 Cable, RJ45 Y Splitter, Power Transformer, Mounting Hardware, User Guide
Warranty	1-Year Manufacturer's limited warranty

### ACCESSORIES

PART #	DESCRIPTION
41361	6" 24V DC Bell
41392	8" 24V DC Bell
41362	24V DC Horn
41449	Bell Wire, 100'
41450	Bell Wire, 250'
41270	RJ45 Cable Splitter
41200	Power Adapter 120V
4000Pro	Auto Totaling Time Clock
5000	Auto Totaling Time Clock
5000HD	Auto Totaling Time Clock
PSDLAUBKK	TimeTrax™ Elite Swipe Card Time Clock System
TTPROXEK	TimeTrax™ Elite Proximity Time Clock System
TTELITEEK	TimeTrax™ Elite Biometric Time Clock System
9T1WI	TimeTrax Sync™ RF Wireless Transmitter
S9DWXSLAUB	TimeTrax Sync™ RF Wireless Transmitter
S9DSXOLAUB	Add-on TimeTrax™ RF Wireless Transmitter
42337	Add-on TimeTrax™ RF Wireless Transmitter
5200	13" Analog Clock (5300 can power up to 8 clocks)

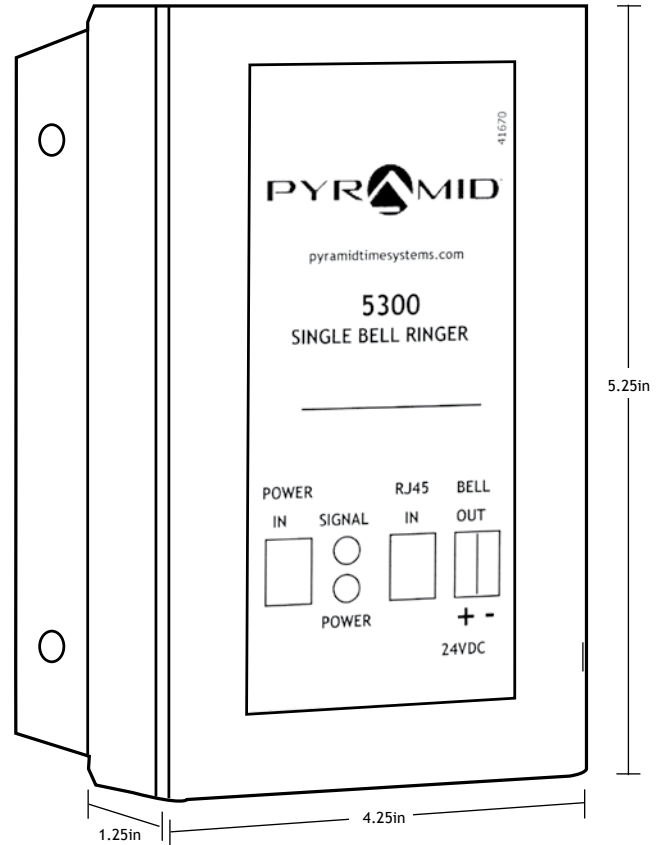

### WARRANTY

#### 1-YEAR LIMITED WARRANTY

Pyramid warrants its Synchronized Clock Systems to the original user against defective material or workmanship for a period of 1 year from date of purchase.

The manufacturer's responsibility under this Warranty is limited to repair or replacement of defective part or parts. Pyramid reserves the right to determine whether parts failed because of defective material, workmanship, or other causes. Failure caused by accident, alteration, misuse or improper packaging of returned unit is not covered by this Warranty. Any repair to equipment other than by Pyramid voids the Warranty. Users in territories other than USA, Canada, South America & Australia should contact the Dealer from whom the unit was purchased. The rights under this Warranty are limited to original user and may not be transferred to subsequent users.

If Customer Support cannot troubleshoot your problem over the phone, we will replace your unit free of charge if it is within warranty period. Please contact Customer Support at **888.479.7264** between the hours of **8am-5pm EST** for details.

### TECHNICAL SUPPORT

Should you need to speak live to one of our representatives, please call toll-free (US/Canada) at **888.479.7264** during regular business hours: **8am-5pm EST, M-F**.

THIS PAGE DOES NOT PRINT

this page not needed

# SIMPLE : SMART<sup>®</sup>

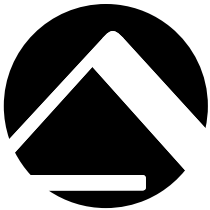

## CONTACT US:

For more information, visit [pyramidtimesystems.com](http://pyramidtimesystems.com) or call our technical support team at **888.479.7264** during regular business hours: **8am-5pm EST, Monday-Friday.**

Copyright © 2017 Pyramid Time Systems, LLC. All rights reserved.