

# RackLink® Owner's Manual

Monitor | Control | Alert | Report | Analyze



# Rack Link™

by Middle Atlantic Products

U.S. Patent No. 8,947,844

The logo for Middle Atlantic Products, featuring a stylized, cursive 'MA' monogram above the company name.

**Middle Atlantic Products**

## TABLE OF CONTENTS

WARNINGS.....	pg 3
REGULATORY INFORMATION.....	pg 4
INTRODUCTION.....	pg 4
SYSTEM REQUIREMENTS.....	pg 5
RS-232 CONNECTION PINOUTS.....	pg 5
DEVICE DISCOVERY INSTALLATION (WINDOWS AND MAC).....	pg 6 - 11
DEVICE CONTROL.....	pg 12
USER INTERFACE OPERATION.....	pg 13 - 30
UPDATING FIRMWARE.....	pg 31 - 32
MOBILE APPLICATION.....	pg 33
IP SETTINGS WITH DIRECT CONNECTION TO A PC.....	pg 34 - 36
TROUBLESHOOTING.....	pg 37
FEATURE SET CALLOUTS (ALL MODELS).....	pg 38 - 51
DIMENSIONS.....	pg 52 - 53
WARRANTY.....	pg 54

## WARNINGS/IMPORTANT SAFETY INFORMATION

READ AND SAVE THESE INSTRUCTIONS! CONSERVER CES INSTRUCTIONS!



### **CAUTION/ATTENTION**

The exclamation point within an equilateral triangle is intended to alert the user to the presence of important operating and maintenance (servicing) instructions in the literature accompanying the appliance.

*Le point d'exclamation dans un triangle équilatéral est destiné à alerter l'utilisateur de la présence d'importantes instructions d'opération et de maintenance (entretien) dans la documentation accompagnant l'appareil.*



### **DANGER HAZARDOUS VOLTAGE/DANGER HAUTE TENSION**

The lightning flash with the arrowhead symbol, within an equilateral triangle is intended to alert the user to the presence of uninsulated dangerous voltage within the product's enclosure that may be of sufficient magnitude to constitute a risk of electric shock to persons.

*L'éclair avec le symbole de flèche dans un triangle équilatéral est destiné à alerter l'utilisateur de la présence d'une tension dangereuse non isolée dans l'enceinte du produit qui peut être d'une ampleur suffisante pour constituer un risque de choc électrique pour les personnes.*



- Contains switched receptacle(s). To reduce risk of shock , disconnect the RackLink™ device from the power source before servicing any connected equipment

- *Contient de(s) receptacle(s) commuté(s). Pour réduire les risques d'électrocution, débranchez l'appareil RackLink™ de la source d'alimentation avant l'entretien de tout équipement connecté*



- Do not overload the wall outlet where this device is being connected. Do not overload this device. Ensure the total load to this device does not exceed that which is listed in the specifications section of this manual

- *Ne surchargez pas le réceptacle de mur ou le circuit qui fournit l'énergie à ce appareil. Ne pas surcharger cette appareil. S'assurer que la charge totale à cet appareil ne dépasse pas celle qui est répertoriée dans la section des spécifications de ce manuel*



- Ensure this device is connected to a properly grounded AC power source. Ensure the device is plugged into a source providing the required 120V. Do not use a plug adapter that defeats the ground pin of the AC plug

- *Assurez-vous cet appareil est connecté à une source d'alimentation C/A avec mise à la terre. Assurez-vous cet appareil est branché sur une source d'alimentation fournissant les nécessaires 120V. Ne pas utiliser un adaptateur qui contrecarre la broche de terre de la prise du cordon d'alimentation*



- There are no user-serviceable components within this device. Removal of the cover from this device may present a shock hazard, and void the warranty

- *Il n'ya pas de composants réparables par l'utilisateur au sein de cet appareil. Retrait de la couverture de cet appareil peut présenter un danger d'électrocution et annuler la garantie*



- To be used indoors in a dry location only

- *Pour être utilisé en intérieur dans un endroit sec seulement*



- Do not operate with a damaged cord or plug

- *Ne pas faire fonctionner avec un cordon ou une prise endommagée*



- Clean only with dry cloth

- *Nettoyer avec un chiffon sec seulement*

## REGULATORY INFO

### **Models: RLNK-MON115-NS, RLNK-MON120-NS, RLNK-SW215-NS, RLNK-SW220-NS**

**NOTE:** This equipment has been tested and found to comply with the limits for a Class A digital device, pursuant to Part 15 of the FCC Rules. Modifications not expressly approved by the manufacturer could void the user's authority to operate the equipment under FCC rules. These limits are designed to provide reasonable protection against harmful interference when the equipment is operated in a commercial environment. This equipment generates, uses, and can radiate radio frequency energy and, if not installed and used in accordance with the instruction manual, may cause harmful interference to radio communications. Operation of this equipment in a residential area is likely to cause harmful interference in which case the user will be required to correct the interference at his own expense.

#### All Other Models:

**NOTE:** This equipment has been tested and found to comply with the limits for a Class B digital device, pursuant to Part 15 of the FCC Rules. These limits are designed to provide reasonable protection against harmful interference in a residential installation. This equipment generates, uses and can radiate radio frequency energy and, if not installed and used in accordance with the instructions, may cause harmful interference to radio communications. However, there is no guarantee that interference will not occur in a particular installation. If this equipment does cause harmful interference to radio or television reception, which can be determined by turning the equipment off and on, the user is encouraged to try to correct the interference by one or more of the following measures:

- Reorient or relocate the receiving antenna.
- Increase the separation between the equipment and the receiver.
- Connect the equipment into an outlet on a circuit different from that to which the receiver is connected.
- Consult the dealer or an experienced radio/TV technician for help.

## INTRODUCTION

### **What Is RackLink?**

RackLink is a suite of AV system monitoring and power management products that allows local and remotely located users to instantly control, view and manage connected systems in real-time via the web, or through any Control System that supports IP or RS-232 communication.

Providing both individual outlet control and dry contact output control plus a suite of power monitoring and alerting capabilities the product suite includes 1RU rackmount products (15A and 20A) and compact 0RU in-line modular products that can be mounted in no-man's land.

### **RackLink Key Features:**

- Remote reboot of connected equipment
- Auto-Ping feature for automatic remote reboot (or e-mail status notification) of equipment
- Integrated sequencing (model specific)
- Emergency power off (model specific)
- Power monitoring and logging
- Temperature monitoring and logging
- Individual outlet control is supported locally and remotely via the web or connected control system
- Multiple dry contact closure outputs can be controlled remotely via the web or connected control system
- Set and be alerted by e-mail to key threshold deviations (e.g. over current/under voltage/over temp)
- Open platform communications protocol provides seamless integration with Crestron, AMX and any IP or RS-232 based control system
- Mobile applications available for iPhone and Android



## SYSTEM REQUIREMENTS

- Windows XP or greater with .Net 4.0 Framework.
- Windows Explorer Version 7 or higher.
- MAC OS X 10.6 or higher.
- DDNS Server Requirements (Optional): If you have an Internet line that has an address that remains the same (static), configure a port on your firewall to allow pass-through traffic to the RackLink device. Please see your router's instructions on opening ports. If you do not have a static IP address, you must first setup a method of the address change such as using a DDNS service. Once completed, follow those same instructions as if you had a static address and open a port on your router to allow traffic to pass-through.

## RS-232 CONNECTION PINOUTS

**NOTE:** The DB9 port on the RackLink module is male. A Female-To-Female null modem cable is required.

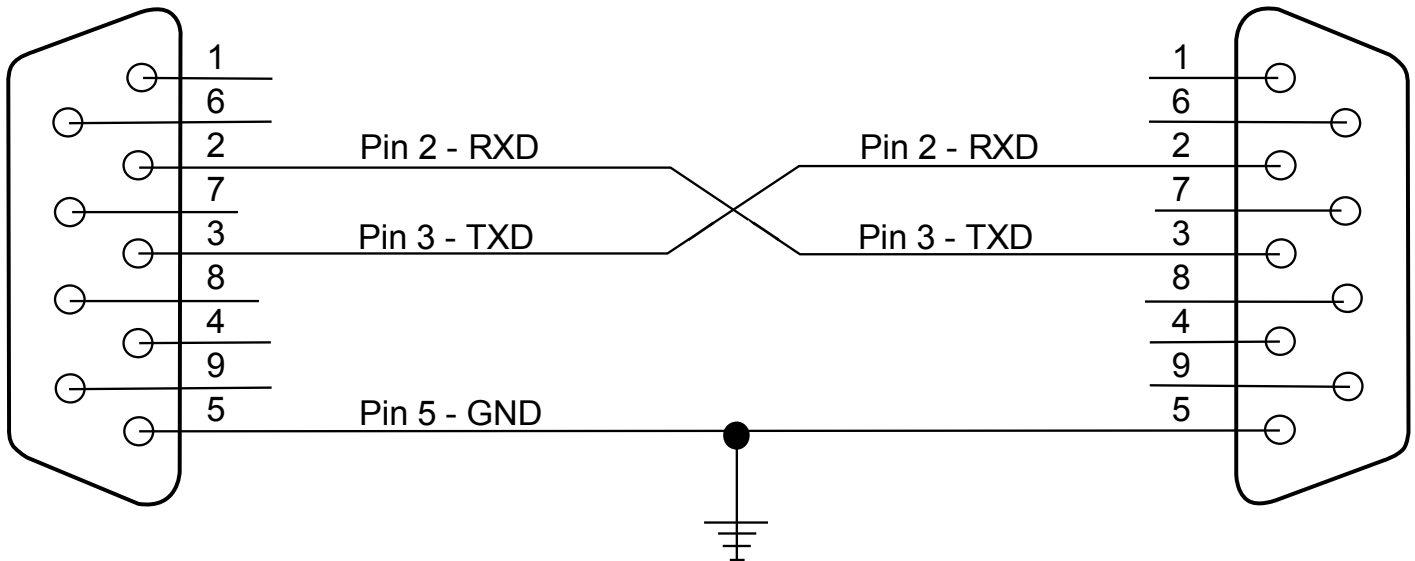

## RackLink® DEVICE DISCOVERY

There are two ways to discover your RackLink device. Using the Device Discovery software, or with the Device Discovery provided with the mobile application.

- **Software Installation:** By default the Device Discovery software will look for a DHCP server. The default IP address for the RackLink device is 192.168.1.200.
- For the mobile application to discover the RackLink device, the device and mobile phone must be on the same network.

**NOTE:** In order for the RackLink Device Discovery software to find your RackLink module. The PC where the software resides must be on the same subnet as the RackLink module. (See I-00472 for setting up RackLink via the RS-232 port). **You may need to disable your Windows firewall if you cannot discover your RackLink device.**

- 1) Run the **setup.exe** file located at <http://www.middleatlantic.com/Racklink/index.htm>. The default installation path is C:\Program Files\Middle AtlanticProducts\RackLink Discovery\.
- 2) This will bring you to the Device Discovery Setup dialog box. Click **Next**.



- 3) If desired, the installation location may be changed here. You can also install RackLink Discovery for everyone, or just the installer of the software. Click **Next**. To check disk space availability, you can click **Disk Cost**.



4) Click **Next** to begin the installation.



5) Click **Close** to exit. The default setting is to launch the RackLink Discovery tool. Uncheck the **Launch RackLink Discovery** checkbox if you do not want to automatically launch the tool.

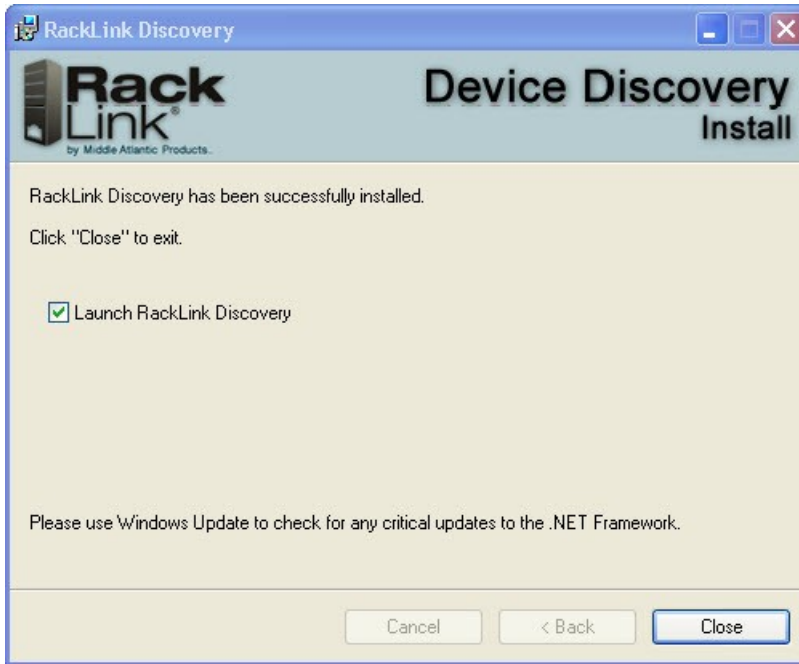

6) The RackLink Discover Tool will automatically discover all RackLink devices on the subnet you are connected to. You can also click **Discover** to search for RackLink devices added after the initial discovery. By default, the RackLink device is set for DHCP. You can identify each device by the MAC address or IP address. **You may need to disable your Windows firewall if you cannot discover your RackLink device.**

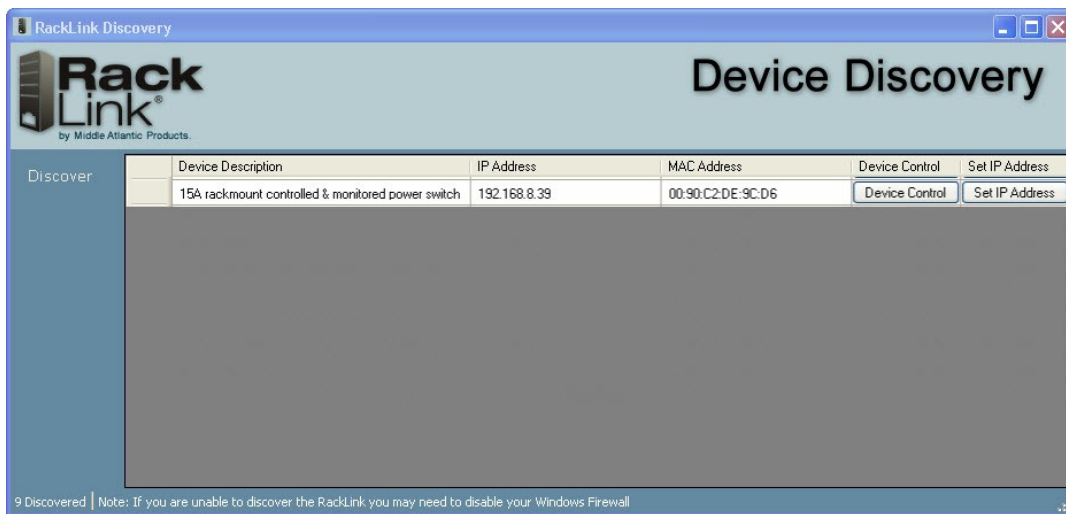

## MAC RackLink® DEVICE DISCOVERY

There are two ways to discover your RackLink device. Using the Device Discovery software, or with the Device Discovery provided with the mobile application.

- **Software Installation:** By default the Device Discovery software will look for a DHCP server. The default IP address for the RackLink device is 192.168.1.200.
- For the mobile application to discover the RackLink device, the device and mobile phone must be on the same network.

**NOTE:** In order for the RackLink Device Discovery software to find your RackLink module. The computer where the software resides must be on the same subnet as the RackLink module. (See I-00472 for setting up RackLink via the RS-232 port). **You may need to disable your firewall if you cannot discover your RackLink device.**

- 1) Run **RackLinkDiscovery.pkg** file at <http://www.middleatlantic.com/Racklink/index.htm>.
- 2) This will bring you to the Install RackLink Discovery dialog box. Click **Continue**.

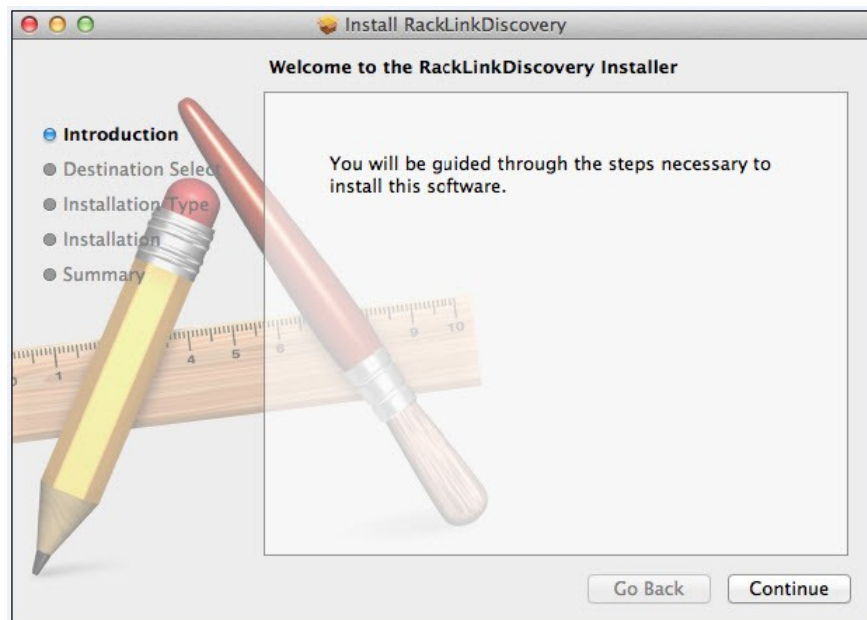

- 3) If desired, the installation destination can be selected here. Click **Continue** to begin the installation process.

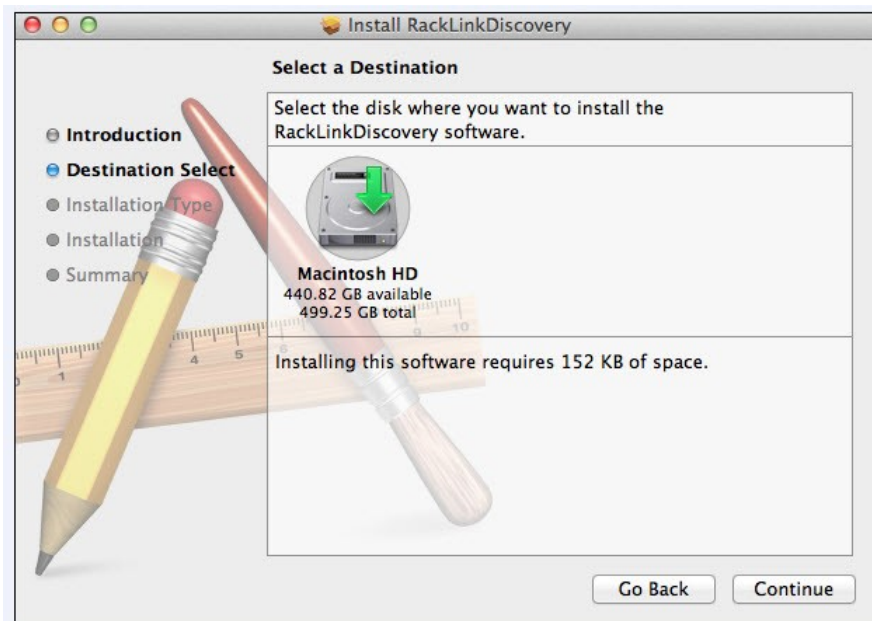

4) Click **Install** to begin the installation. You may change your Destination or the Installation Type/Location.

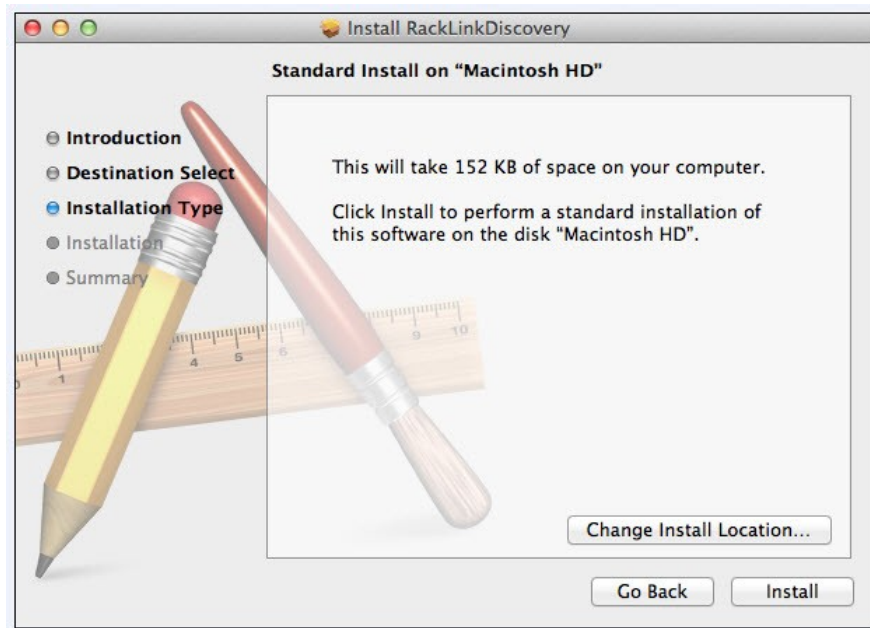

5) Click **Close** to exit after the installation was successful.

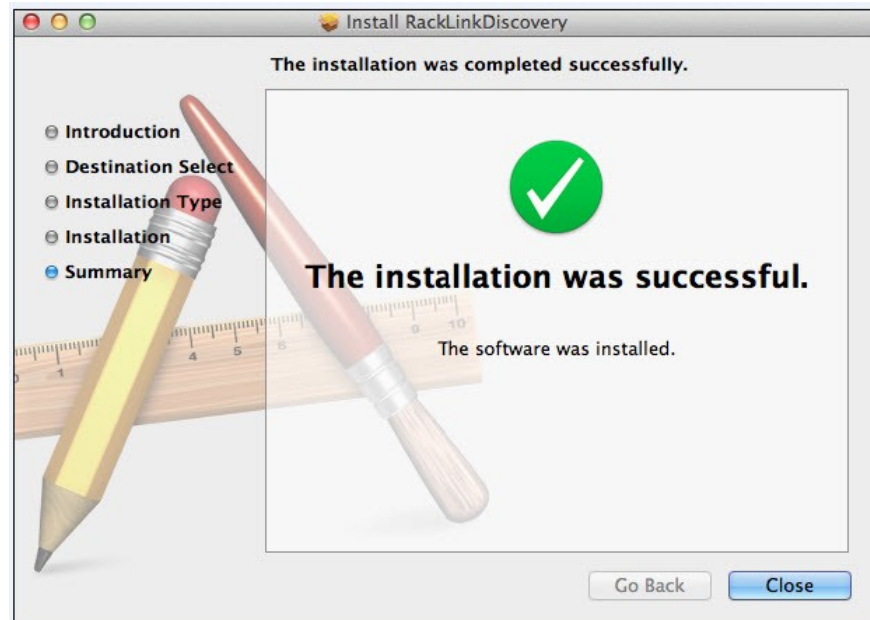

6) Navigate to **Applications** via the **Finder** to launch the RackLink Discovery application.

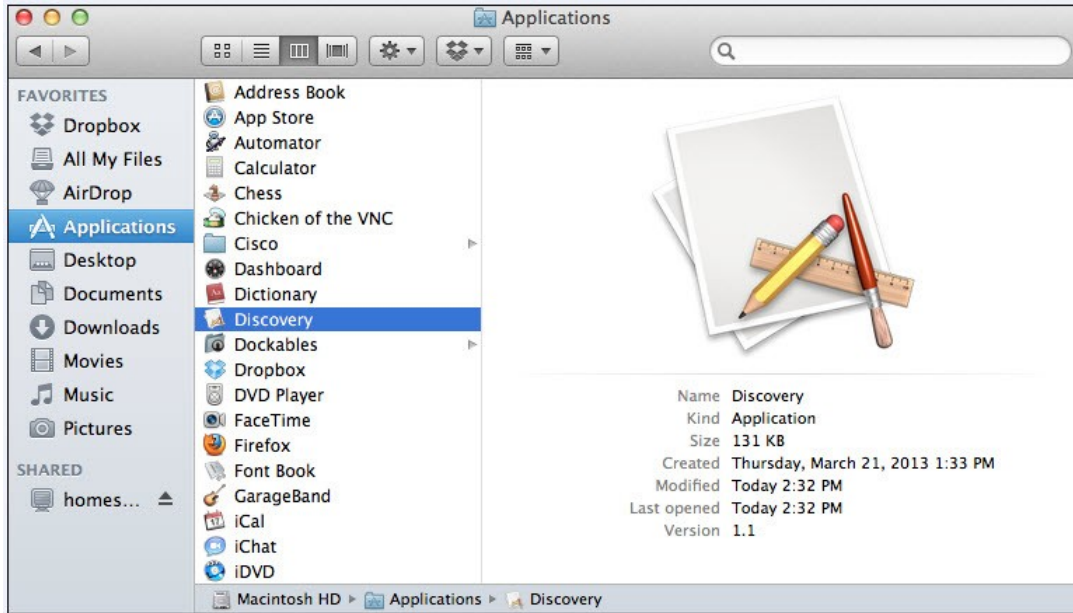

7) The RackLink Device Discover Tool will discover all RackLink devices on the subnet you are connected to. By default, the RackLink device is set for DHCP. You can identify each device by the MAC address or IP address. **You may need to disable your firewall if you cannot discover your RackLink device.**

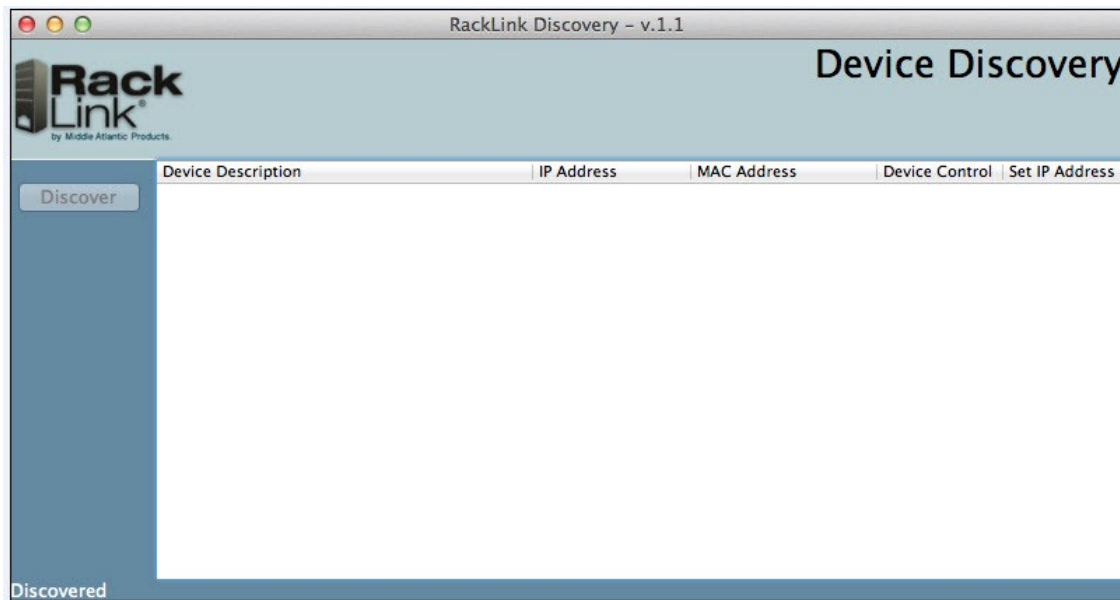



## DEVICE CONTROL

- 1) To access the web-browser based interface of the desired device, click on **Device Control**. You will then be prompted to enter a User name/Password. To login as an administrator, the default login/password is admin/admin. To login as a user, the default login/password is user/user. See page 29 for how to change the passwords.



- 2) You may also change the IP settings by clicking on **Set IP Address** and un-checking **Use DHCP**. You will be prompted to enter your login credentials. You must be logged in as an **admin** to change the IP settings.



- 3) Having successfully authenticated, you can now set the device's IP Address, Subnet Mask, Gateway, and DNS Server. Uncheck the 'DHCP' check box before making changes. After making changes, click **Apply** when completed. These settings are now the static settings for your RackLink device. You can access the web-based interface by typing the IP address in the address bar or by clicking **discover** on the discovery tool.

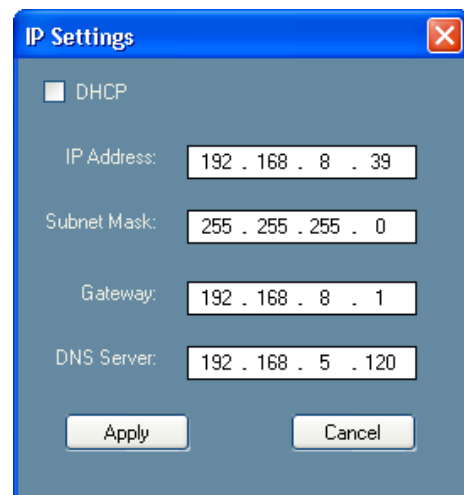
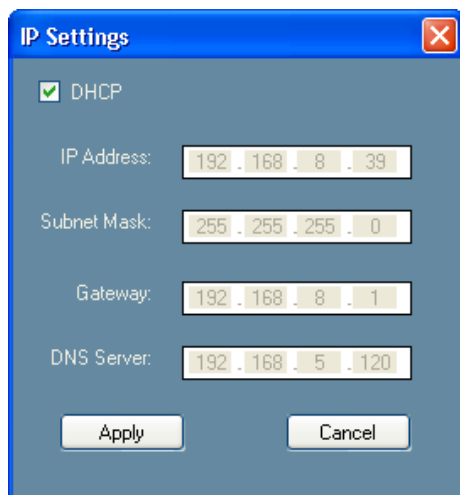

# USER INTERFACE OPERATION - HOME PAGE

**PLEASE NOTE:** The number of outlets and dry contacts are model specific. See **sequencing models** home page.

**RackLink™**  
by Middle Atlantic Products

RLNK-SW715R Model #: RLNK-SW715R

My Device  
Logs  
Setup (Admin Only)  
Close

### Current Readings

Input Voltage (RMS)	Input Voltage (Peak)	Load Current (RMS)	Load Current (Peak)
118 VAC	123 VAC	0.2 A	0.3 A
Watts	Power Factor	Kilo Watt Hours	Thermal Load (BTU)
17 W	0.7	0.4 KWh <a href="#">Reset</a>	60 BTUs
Temperature			
74° F			

### Outlets

Number	Name	Status	Control	Cycle Delay (sec.)
				<input type="text" value="3"/>
1.	<a href="#">OUTLET 1</a>	ON	Not Controllable	Not Controllable
2.	<a href="#">OUTLET 2</a>	ON	Not Controllable	Not Controllable
3.	<a href="#">OUTLET 3</a>	ON	<input type="button" value="ON"/> <input type="button" value="OFF"/>	<input type="button" value="Cycle"/>
4.	<a href="#">OUTLET 4</a>	ON	<input type="button" value="ON"/> <input type="button" value="OFF"/>	<input type="button" value="Cycle"/>
5.	<a href="#">OUTLET 5</a>	ON	<input type="button" value="ON"/> <input type="button" value="OFF"/>	<input type="button" value="Cycle"/>
6.	<a href="#">OUTLET 6</a>	ON	<input type="button" value="ON"/> <input type="button" value="OFF"/>	<input type="button" value="Cycle"/>
7.	<a href="#">OUTLET 7</a>	ON	<input type="button" value="ON"/> <input type="button" value="OFF"/>	<input type="button" value="Cycle"/>

### Dry Contacts

Number	Name	Status	Control	Cycle Delay (sec.)
				<input type="text" value="3"/>
A.	<a href="#">CONTACT 1</a>	OPEN	<input type="button" value="OPEN"/> <input type="button" value="CLOSE"/>	<input type="button" value="Cycle"/>
B.	<a href="#">CONTACT 2</a>	OPEN	<input type="button" value="OPEN"/> <input type="button" value="CLOSE"/>	<input type="button" value="Cycle"/>
C.	<a href="#">CONTACT 3</a>	OPEN	<input type="button" value="OPEN"/> <input type="button" value="CLOSE"/>	<input type="button" value="Cycle"/>
D.	<a href="#">CONTACT 4</a>	OPEN	<input type="button" value="OPEN"/> <input type="button" value="CLOSE"/>	<input type="button" value="Cycle"/>
E.	<a href="#">Surge Status</a>	PROTECTED	Not Controllable	Not Controllable

Processor Firmware - v 0.62 - 06171108

www.MIDDLEATLANTIC.COM

## My Device Functions/Options:

- The top left corner contains the Device Name. This can be set/changed under the **setup>device settings tab**. The default name is the device model. The model number is listed on the right hand side of the screen. This cannot be changed.
- Device image as shown from the back of the unit (RLNK-SW715R shown).

- **Current Readings:**
  - Input Voltage (RMS)
  - Input Voltage (Peak)
  - Load Current (RMS)
  - Load Current (Peak)
  - Watts
  - Power Factor
  - Kilowatt Hours (Can be reset)
  - Thermal Load (BTU)
  - Temperature
- **Outlets:**
  - **Number:** Outlet number from left to right.
  - **Name:** The name can be changed by clicking on the **current name**. Once changed, you can click **save** or **cancel**.
  - **Status:** Tells you if the outlet is on, off, or rebooting.
  - **Control:** For controllable outlets, you can manually turn them on/off. Default status is on.
  - **Cycle:** This will cycle the outlet power one time only when the outlet is on. The cycle delay can be set for **1 - 999 seconds**, 3 seconds is the default. If during the cycled delay period a new command is received for that outlet, it will supersede the cycle command.
- **Dry Contacts:**
  - **Number:** Dry contact number/letter from left to right.
  - **Name:** The name can be changed by clicking on the **current name**. Once changed, you can click **save** or **cancel**.
  - **Status:** Tells you if the dry contact is on, off, or rebooting. If you have a unit with surge protection there will be one dry contact that is for notification if the surge protection is compromised.
  - **Control:** Allows user to open or close dry contacts, default status is closed.
  - **Cycle:** This will cycle the dry contact one time whether the dry contact is open or closed. The cycle delay can be set for **1 - 999 seconds**, 3 seconds is the default. If during the cycled delay period a new command is received for that dry contact, it will supersede the cycle command.
- **Processor Firmware:** This displays the current firmware version with the manufacturing code.

# SEQUENCING MODELS HOME PAGE

## Sequence Functionality

- If outlets are checked in the sequence control section, this will override startup default. Refer to the sequencing section on the 'Device Settings' page, 'Initial Outlet Contact State' section.
- Dry contact 'C' is dedicated sequence status notification (see below).



RLNK-SW815R-SP



Model #: RLNK-SW815R-SP

My Device

Logs

Setup (Admin Only)

Close

### Current Readings

Input Voltage (RMS)	Input Voltage (Peak)	Load Current (RMS)	Load Current (Peak)
120 VAC	120 VAC	0 A	0.1 A
Watts	Power Factor	Kilo Watt Hours	Thermal Load (BTU)
8 W	0.7	0 KWh <a href="#">Reset</a>	28 BTUs
Temperature			
78° F			

### Sequence Control: Rear Outlets

Rear Outlets	Status	Control	Delay (sec.)
<input checked="" type="checkbox"/> 2 <input checked="" type="checkbox"/> 3 <input checked="" type="checkbox"/> 4 <input checked="" type="checkbox"/> 5 <input checked="" type="checkbox"/> 6 <input checked="" type="checkbox"/> 7 <input checked="" type="checkbox"/> 8	Not Sequenced	<input type="button" value="ON"/> <input type="button" value="OFF"/>	<input style="width: 30px;" type="text" value="1"/>

### Manual Control: All Outlets

Number	Name	Status	Control	Cycle Delay (sec.)
				<input style="width: 30px;" type="text" value="3"/>
1.	<a href="#">Add description</a>	ON	<input type="button" value="ON"/> <input type="button" value="OFF"/>	<input type="button" value="Cycle"/>
2.	<a href="#">Add description</a>	ON	<input type="button" value="ON"/> <input type="button" value="OFF"/>	<input type="button" value="Cycle"/>
3.	<a href="#">Add description</a>	ON	<input type="button" value="ON"/> <input type="button" value="OFF"/>	<input type="button" value="Cycle"/>
4.	<a href="#">Add description</a>	ON	<input type="button" value="ON"/> <input type="button" value="OFF"/>	<input type="button" value="Cycle"/>
5.	<a href="#">Add description</a>	ON	<input type="button" value="ON"/> <input type="button" value="OFF"/>	<input type="button" value="Cycle"/>
6.	<a href="#">Add description</a>	ON	<input type="button" value="ON"/> <input type="button" value="OFF"/>	<input type="button" value="Cycle"/>
7.	<a href="#">Add description</a>	ON	<input type="button" value="ON"/> <input type="button" value="OFF"/>	<input type="button" value="Cycle"/>
8.	<a href="#">Add description</a>	ON	<input type="button" value="ON"/> <input type="button" value="OFF"/>	<input type="button" value="Cycle"/>

### Dry Contacts

Number	Name	Status	Control	Cycle Delay (sec.)
				<input style="width: 30px;" type="text" value="3"/>
A.	<a href="#">Add description</a>	OPEN	<input type="button" value="OPEN"/> <input type="button" value="CLOSE"/>	<input type="button" value="Cycle"/>
B.	<a href="#">Add description</a>	OPEN	<input type="button" value="OPEN"/> <input type="button" value="CLOSE"/>	<input type="button" value="Cycle"/>
C.	Sequence Status Notification	CLOSED	Not Controllable	Not Controllable



Processor Firmware - v 2.01 - 03161206

- **Sequence Control: Rear Outlets**

- **Rear Outlets:** Select/deselect the rear outlets to be sequenced. The lower number outlet will be the first to sequence up, the higher numbered outlet will be the first to sequence down.
- **Status:** This field will show the current sequence state. If sequencing is not enabled, the field will read 'Not Sequenced'. If sequencing has not been initiated or any sequenced outlet has changed state, status will read 'Not Sequenced'. Otherwise, you will see one of the following messages.
  - Sequence ON in Progress
  - Sequence ON Complete
  - Sequence OFF in Progress
  - Sequence OFF Complete
- **Control:** User selectable on/off buttons will enable/disable sequencing. The on/off buttons operate so that it is possible to select 'Sequence ON/OFF' multiple times without having to first select 'Sequence OFF/ON'.
- **Delay (in seconds):** This is the delay between outlets sequencing on/off. The set delay is the same for all sequenced outlets. The delay can be set from 0 – 999 seconds.

- **Dry Contacts: Sequence Status Notification**

- **Non-Controllable Dry Contact Switch:** Open by default, closed upon sequence complete. Reopen on sequence off complete.

**NOTE:** If manually controlling a previously sequenced outlet (e.g. turning off an outlet that was sequenced on) will not cause the contact to change state.



# LOGS

**Rack Link**  
by Middle Atlantic Products

My Device  
Logs  
Setup (Admin Only)  
Close

RLNK-SW715R Model #: RLNK-SW715R

**Logs**

Start Date: 9 / 6 / 2011  
Start Time: 3 : 44 PM  
Finish Date: 9 / 7 / 2011  
Finish Time: 3 : 44 PM

Input Voltage (RMS)   
 Load Current (RMS)   
 Watts  
 Power Factor  
 Temperature  
 Thermal Load (BTUs)

Timestamp	Input Voltage (RMS)	Load Current (RMS)	Watts	Power Factor	Temperature	Thermal Load
09/06/2011 15:45:57	121	00.3	0017	0.7	074	0060.7
09/06/2011 15:50:34	121	00.3	0017	0.7	074	0059.6
09/06/2011 15:55:24	121	00.3	0017	0.7	073	0060.7
09/06/2011 16:01:08	121	00.3	0017	0.7	073	0059.6
09/06/2011 16:02:22	120	00.3	0017	0.7	073	0060.7
09/06/2011 16:05:03	120	00.3	0017	0.7	074	0060.7
09/06/2011 16:10:23	120	00.3	0017	0.7	074	0060.7
09/06/2011 16:15:42	120	00.3	0017	0.7	074	0060.7
09/06/2011 16:19:52	120	00.3	0017	0.7	074	0060.7
09/06/2011 16:24:46	120	00.3	0017	0.7	074	0060.7

Processor Firmware - v 0.62 - 06171108

**Logging:** Logs provides you with the ability to view historical data. You can set the start and end date/time manually. The factory default is set to capture 24 hours of data. The log saves up to 2000 entries. The first entry in will be the first entry deleted.

- You can refresh the view by clicking on the **Refresh** button.
- Click **Save As** and the log file can be saved as a **.csv file**.

The following information can be displayed by clicking the check box next to the option.

- Input Voltage (RMS)
- Load Current (RMS)
- Watts
- Power Factor
- Temperature
- Thermal Load (BTUs)

✓ **NOTE:** Reason codes and meanings are not logged on the interface, but are logged in the .csv file.

### Logging Operation:

- If all variables are within the tolerance range, a record will be logged every 5 minutes.
- If a monitored value is out of tolerance range, the following will take place.
  - The record will log immediately upon event occurrence and when the recovery takes place. This will also generate an e-mail alert if the device is setup to perform that function.

## LOGS CONTINUED

- During the out of tolerance period, a log entry will continue to populate every 5 minutes, store an additional record, and issue e-mail alert (if alert is setup) during the following situations.
  - Input voltage changes +/- 2V
  - Load current changes +/- .2A
  - Temperature changes +/- 2°
- When you click on **Save As** and save the log file, you can also view reason codes, and the meanings of the reason code next to the log entry. The following reason codes and meanings are listed below. The reason code is 1<sup>st</sup> and the meaning is 2<sup>nd</sup>.
  - 0 – Normal Event
  - 1 – Over Voltage
  - 2 – Under Voltage
  - 3 – Over Current
  - 4 – Under Current
  - 5 – Over Temperature
  - 6 – Under Temperature
  - 7 – Surge Fault
  - 8 – Auto Ping Fault
  - 9 – RS-232 Ping Fail



# DEVICE SETTINGS

**SEQUENCING MODELS ONLY (SEE NEXT PAGE)**

## General Settings:

- **Device Name:** The name that will be shown in the top left corner on every page.
- **Account Name/Number:** User defined field for reference.
- **Device Description:** This description will be shown in the RackLink Discovery Tool.
- **Initial Outlet/Contact State:** ON/OPEN is the factory default setting for the outlet(s) and dry contact(s). When doing a firmware upgrade the outlet(s)/dry contact(s) state will default to the setting There are three settings:
  - **Remember prior state** - The outlet(s)/dry contact(s) will remain in the prior state.
  - **OFF/OPEN** - The outlet(s) will default to on, the dry contact(s) will default to open.
  - **ON/OPEN** - The outlet(s) will default to on, the dry contact(s) will default to open (default setting).

UPDATE FIRMWARE: Shows the current version of firmware. Click the Upload a new version link to browse and upload the latest version. The current version is available at our website; <http://www2.middleatlantic.com/support/firmware.aspx>

## DEVICE SETTINGS CONTINUED

### Sequencing:

- **Sequence on Power Up:** ENABLED/DISABLED. Default setting is ENABLED.
- **Sequence Input Control Type:**
  - Maintained; Normally Open
  - Maintained; Normally Closed
  - Momentary; Normally Open
  - Momentary; Normally Closed
- **Sequence Notification:**
  - Act as next step (default): Dry Contact C will **'close'** after the highest numbered outlet has been powered on. The dry contact will **'open'** immediately following a **'sequence off'** command.
  - Sequence status complete: Upon completion of **'sequence on'** Dry Contact C will close, when the highest numbered outlet in the sequence profile has powered **'on'** following a change of state in the Dry Contact input, or if executed via the GUI.

### Emergency Power Off: Normally Open/Maintained (cannot be changed)

- **Recovery: Automatic (default)** If Dry Contact input E state is **'closed'** the RackLink unit will respond according to the following.
  - **'Device is in emergency power off condition'** notification removed from **'my device'** tab.
  - Local outlet control is disabled.
  - GUI outlet control disabled.
  - Serial communication outlet and sequencing control disabled.
  - Dry Contact Input D (Sequence ON/OFF) is disabled.
  - Dry Contact Output C (Sequence Status) set to open.
  - Entered Emergency Power Off Condition e-mail is issued (if enabled).
  - All controlled outlets turned **'off'** immediately; and concurrently.
  - Rapid **'sequence off'** initiated. The highest numbered outlet in the sequence profile, through the lowest numbered outlet in the sequence profile.
    - Highest numbered outlet turns off immediately.
    - Minimum delay between each steps.
- **Hard Reset Required:** The device will remain in EPO mode pending a hard reboot.

# TCP/IP SETTINGS

The screenshot shows the 'TCP/IP Settings' page for a Rack Link device (Model #: RLNK-SW715R). The interface includes a left-hand navigation menu with options like 'My Device', 'Device Settings', 'TCP/IP Settings', 'Notification', 'Alert Thresholds', 'Auto Ping Settings', 'Passwords', 'Restore Defaults', and 'Close'. The main content area is divided into two sections: 'TCP/IP Settings' and 'NTP Settings'. In the 'TCP/IP Settings' section, the MAC Address is 00:90:C2:DE:9C:D6, and 'USE DHCP' is checked. The IP Address is 192.168.8.74, Subnet Mask is 255.255.255.0, Gateway is 192.168.8.1, Primary DNS is 192.168.5.120, Secondary DNS (Optional) is 192.168.5.121, and HTTP Port is 80. The 'NTP Settings' section has 'Use NTP' checked, with NTP Server 1 and 2 both set to 0.north-america.pool.ntp.org and 1.north-america.pool.ntp.org respectively. The date is 10/12/11, the time is 07:50 AM, and the time zone is Eastern Standard Time (GMT-5:00). There are 'Apply' and 'Restore Factory Defaults' buttons at the bottom right. The footer shows 'Processor Firmware - v 0.73 - 10051108' and the Rack Link logo with the website URL www.MIDDLEATLANTIC.COM.

## TCP/IP Settings:

- **MAC Address:** Unique MAC Address to your specific unit.
- **USE DHCP:** If checked the device will use a DHCP server to set all IP address settings.
- **IP Address Settings:**
  - Device IP Address
  - Subnet Mask
  - Gateway
  - Primary DNS
  - Secondary DNS (Optional)
  - HTTP Port: 80 (Default) - You cannot choose a port that is already in use. The used ports are 7 (ICMP/Ping), 54632 (Discovery), and 60000 (Control Protocol). If you choose any of these ports the system will not change the port of the HTTP Server.

## TCP/IP SETTINGS CONTINUED

- **NTP Settings:** Network Time Protocol.
  - **Use NTP** – Check this to **enable** the usage of the Network Time Protocol.
  - **NTP Server 1:** Set a NTP server of your choice (Default is 0.north-america.pool.ntp.org).
  - **NTP Server 2:** Set a NTP server of your choice (Default is 1.north-america.pool.ntp.org).
  - **Date/Time:** The date and time when the entry was made.
  - **Time Zone:** Drop down menu for setting to the desired time zone.
  - **Daylight Savings Time:** Check to recognize daylight savings time.
- Click **apply** for the changes to take effect.

# NOTIFICATION

**Rack Link**  
by Middle Atlantic Products.

RLNK-SW815R-SP Model #: RLNK-SW815R-SP

My Device  
Device Settings  
TCP/IP Settings  
Notification  
Alert Thresholds  
Auto Ping Settings  
Passwords  
Restore Defaults  
Close

### Notifications

#### Email Alerts

	No Response	Recovery	Threshold	EPO
Alert Recipient: <input type="text"/>	<input type="checkbox"/>	<input type="checkbox"/>	<input type="checkbox"/>	<input type="checkbox"/>
Alert Recipient: <input type="text"/>	<input type="checkbox"/>	<input type="checkbox"/>	<input type="checkbox"/>	<input type="checkbox"/>
Alert Recipient: <input type="text"/>	<input type="checkbox"/>	<input type="checkbox"/>	<input type="checkbox"/>	<input type="checkbox"/>
Alert Recipient: <input type="text"/>	<input type="checkbox"/>	<input type="checkbox"/>	<input type="checkbox"/>	<input type="checkbox"/>
Alert Recipient: <input type="text"/>	<input type="checkbox"/>	<input type="checkbox"/>	<input type="checkbox"/>	<input type="checkbox"/>

#### Mail Server

Server Name:

Server Port:

User Name:

Password:

Sender's Email Address:

Send Test Email:

Last Test Result:

Processor Firmware - v 2.01 - 03161206

www.MIDDLEATLANTIC.COM

## Email Alerts:

- **Alert Recipients:** (five maximum) for **notification** of an auto ping no response, recovery from a threshold violation, and when a threshold has gone above or below assigned value.
- **No Response:** If checked, sends a notification if an auto ping IP address fails to respond.
- **Recovery:** If checked, sends a notification if a threshold violation has been reached.
- **Threshold:** If checked, sends a notification if a threshold violation has occurred.
- **EPO:** During and 'Emergency Power Off' situation, the 'Alert Recipient' will receive an e-mail notification.

**Mail Server:**

- **Server Name:** The name of the mail server you will be using.
- **Server Port:** Default port is 25.
- **User Name:** Login name for the mail server.
- **Password:** Password for logging into the mail server.
- **Sender's Email Address:** Email address that a notification will come from. Ensure the email is white-listed so that it is not marked as spam and does not reach the intended recipient.
- **Send Test Email:** This option will send one test e-mail to ensure the e-mail alert system is operating properly
- Click **Apply** for the changes to take effect.

**IMPORTANT NOTES ABOUT E-MAIL OPERATION:**

- Make sure the server name is fully qualified.
- Make sure the port is correct.
- Confirm the network does not block outbound traffic on the specified port.
- If the e-mail system requires authentication, populate the username and password text boxes.

# ALERT THRESHOLDS



RLNK-SW415R-SP

Model #: RLNK-SW415R-SP

- My Device
- Device Settings
- TCP/IP Settings
- Notification
- Alert Thresholds**
- Auto Ping Settings
- Passwords
- Restore Defaults
- Close

## Alert Thresholds

### Current Readings

<b>Input Voltage (RMS)</b> 114 VAC	<b>Input Voltage (Peak)</b> 120 VAC	<b>Load Current (RMS)</b> 0 A	<b>Load Current (Peak)</b> 0.1 A
<b>Watts</b> 4 W	<b>Power Factor</b> 0.5	<b>Kilo Watt Hours</b> 0.1 kWh <a href="#">Reset</a>	<b>Thermal Load (BTU)</b> 12 BTUs
<b>Temperature</b> 81° F			

### Input Voltage Alert Threshold

Low Voltage:  (105V - 110V)  
High Voltage:  (123V - 128V)

### Under & Over Voltage Actions

Turn   
Off All  
Outlets

### Load Current Alert Threshold

Max:  (0A - 20A)  
Min:  (0A - 20A)

### Temperature Alert Threshold

Max:   
Min:

### Over Temperature Actions

	Action	Power Cycle Delay Period (1-999 seconds)
Outlet:	<input type="text" value="3 - Add description"/> <input type="text" value="None (default)"/>	<input type="text" value="3"/>
Dry Contact:	<input type="text" value="A - Add description"/> <input type="text" value="None (default)"/>	



Processor Firmware - v 0.07 - 03021206

- **Current Readings:** Shows the current reading that is also shown on the home page.
- **Input Voltage Alert Threshold:** Allows the user to set the high and low voltage alert thresholds.



## ALERT THRESHOLDS CONTINUED

- **Low Voltage:** thresholds can be set from **105V - 110V**.
- **High Voltage:** thresholds can be set from **123V - 128V**.
- **Under/Over Voltage Actions:** If checked, all outlets will be turned off immediately if an under/over voltage condition takes place.
- **Load Current Alert Threshold:** Allows the user to set the max and min current alert thresholds.
  - **Max Current:** thresholds can be set from **0A - 15A** (for 15A models) **0A - 20A** (for 20A models).
  - **Min Current:** thresholds can be set from **0A - 15A** (for 15A models) **0A - 20A** (for 20A models).
- **Temperature Alert Threshold:** This threshold has no upper or lower limits.
- **Over Temperature Actions:** When an over temperature is reached, you can perform the following actions on the controlled outlet(s) and on the dry contact(s). Only one action per outlet or dry contact can be performed at a time.

### OUTLET ACTIONS

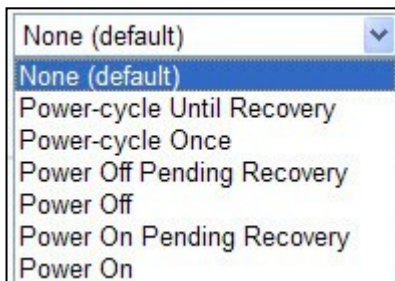

### DRY CONTACT ACTIONS

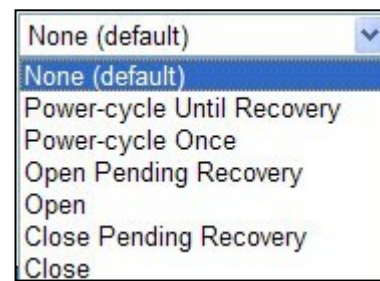

- Click **apply** for the changes to take effect.
  - **Please note the following:** You cannot use the same outlet/dry contact for both Auto Ping and Over Temperature Actions. For example, if you set Outlet 3 to Power Cycle until Recovery for Auto Ping, that outlet will not show up in the dropdown selection for Over Temperature. The opposite is also true. If you set Outlet 3 to be power on for Over Temperature, it will not show up in the dropdown selection for Auto Ping.
  - On the two outlet in-line models (RLNK-SW215-NS and RLNK-SW220-NS), there is only one outlet/dry contact available. You will only be able to set an outlet/contact response for Auto Ping or Over Temperature Actions, but not both.
- **Power Cycle Delay Period:** This can be set for **1 - 999 seconds**. 3 seconds is the factory default
  - When an outlet is cycled until recovery from an Over Temperature Action, the outlet will be on, even if the previous state was off.

# AUTO PING SETTINGS

**Rack Link**  
by Middle Atlantic Products

RLNK-SW815R-SP Model #: RLNK-SW815R-SP

### Auto Ping

**Auto Ping Settings**

Current Status:

Enable Auto Ping:

IP Address To Ping:  .  .  .

Frequency (sec.):  (30-999 seconds)

Failures:  (2-200)

**Action on No Response to Auto Ping**

	Action	Power Cycle Delay Period (1-999 seconds)
Sequence Outlets: <input type="checkbox"/>	Sequence Off	
Outlet: <input type="text" value="3 - Add description"/>	<input type="text" value="None (default)"/>	<input type="text" value="3"/>
Dry Contact: <input type="text" value="1 - Add description"/>	<input type="text" value="None (default)"/>	

Processor Firmware - v 2.01 - 03161206

**NOTE:** If the RackLink device does not have an active connection to a router/gateway, the Auto Ping actions for the outlets and/or dry contacts are disabled. You can however configure the actions if the Ethernet link is inactive.

**Auto Ping Settings:** Configure RackLink device to ping another network device and create actions if the device does not respond.

- **Current Status:** This should read **Communication Established** if the device configured with the auto ping address is communicating. If this reads **Communication Not Established**, the auto ping device is not recognized by the RackLink device.
- **Enable Auto Ping:** Check this box to enable auto ping.
- **IP Address To Ping:** Add the IP address that is to be auto pinged.
- **Frequency (in seconds):** How often, in seconds, your device will initiate an auto ping. This can be set from **30 - 999** seconds (the default is 30 seconds).
- **Retries:** The number of time your device will ping the preset address if no response is received. This can be set from **2 - 200** retries (the default is 3).

**Action on Failure:** When the device being auto pinged does not reply, you can perform the following actions on the controlled outlet(s) and on the dry contact(s). The actions will cease if/when the device being pinged replies.

- **Sequence Outlets:** Default action is to 'Sequence Off'. If check box selected existing 'Outlet' actions are to be disabled. Dry Contact Output actions remain as prior settings. This is a one-time action.

## AUTO PING SETTINGS CONTINUED

### OUTLET ACTIONS

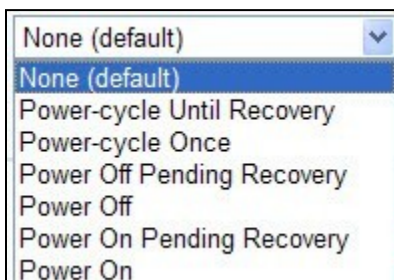

A dropdown menu with a blue header and a white body. The header contains the text "None (default)" and a small downward arrow icon. The body contains a list of seven options: "None (default)", "Power-cycle Until Recovery", "Power-cycle Once", "Power Off Pending Recovery", "Power Off", "Power On Pending Recovery", and "Power On". The "None (default)" option is highlighted with a blue background.

### DRY CONTACT ACTIONS

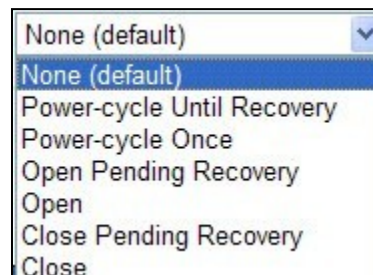

A dropdown menu with a blue header and a white body. The header contains the text "None (default)" and a small downward arrow icon. The body contains a list of seven options: "None (default)", "Power-cycle Until Recovery", "Power-cycle Once", "Open Pending Recovery", "Open", "Close Pending Recovery", and "Close". The "None (default)" option is highlighted with a blue background.

- Click **apply** for the changes to take affect.

**PLEASE NOTE THE FOLLOWING:** You cannot use the same outlet/dry contact for both Auto Ping and Over Temperature Actions. For example, if you set Outlet 3 to Power Cycle until Recovery for Auto Ping, that outlet will not show up in the dropdown selection for Over Temperature. The opposite is also true. If you set Outlet 3 to be power on for Over Temperature, it will not show up in the dropdown selection for Auto Ping.

On the two outlet in-line models (RLNK-SW215-NS and RLNK-SW220-NS), there is only one outlet/dry contact available. You will only be able to set an outlet/contact response for Auto Ping or Over Temperature Action, but not both.

- **Power Cycle Delay Period:** This can be set for **1 - 999** seconds. 3 seconds is the factory default
  - When an outlet is cycled until recovery from an Over Temperature Action, the outlet will be on, even if the previous state was off.

**Passwords:** If logged in as an administrator, you can change the passwords for the administrator and a user. If logged in as a user, you cannot make any changes to the settings. Click **Apply** when the new password is entered.

- **Default login/password:** For a user, it is **user/user**.
- **Default login/password:** For an admin it is **admin/admin**.
  - You can only change *passwords* not the login; the default login remains admin and user. If logged in as a user, you can click on **Setup tab**, and you will be prompted to login as an administrator.
- **RS-232 Control Protocol default login/password:** The default is **user/password**.
- **TCP/IP Control Protocol default login/password:** The default is **user/password**.
  - You can only change the *password* not the login; the default login remains user.

## RESTORE DEFAULTS

The screenshot displays the 'Restore Defaults' page for a Rack Link device. The page is titled 'Restore Factory Defaults' and features a grid of eight settings categories, each with a 'Restore Factory Defaults' button. The categories are: Device Settings, TCP/IP Settings, Notifications, Alert Thresholds, Auto Ping Settings, Passwords, Sequence Settings, and All Settings. A sidebar menu on the left contains the following items: My Device, Device Settings, TCP/IP Settings, Notification, Alert Thresholds, Auto Ping Settings, Passwords, Restore Defaults (highlighted), and Close. The top of the page shows the device model 'RLNK-SW415R-SP' and the processor firmware version 'v 2.01 - 02281206'. The Rack Link logo and 'by Middle Atlantic Products' are visible in the top left corner.

**Restore Defaults:** This allows you to restore the **factory default** settings for the following.

- Device Settings
- TCP/IP Settings
- Notifications
- Alert Thresholds
- Auto Ping Settings
- Passwords
- Sequence Settings (sequencing models only)
- All Settings (defaults all previously listed settings)
  - When you click on any of these options, you will be prompted to click **OK** or **Cancel**.



# UPDATING FIRMWARE

**Rack Link**  
by Middle Atlantic Products.

RLNK-SW415R-SP Model #: RLNK-SW415R-SP

### Update Firmware

**Step 1: Upload Firmware File**

Current Firmware: RLNK-SW820R-SP v0.07

Get the Latest Firmware: [Firmware](#)

Upload New Firmware:

**Step 2: Install Firmware**

Last Firmware Uploaded: RLNK-SW820R-SP v0.07

Processor Firmware - v 0.07 - 03021206

- **Current Firmware:** Shows the current revision loaded into your device.
- **Get The Latest Firmware:** Click on this link to go to the MAP website to obtain the current version on firmware.
- **Upload New Firmware:** Click **browse** to locate the file. Once the file is located, click on **upload**.
  - You will see the following screen while the firmware is updating.

**Rack Link**  
by Middle Atlantic Products.

RLNK-SW715R Model #: RLNK-SW715R

### Update Firmware

**Step 1: Upload Firmware File**

 Updating firmware.

When firmware upload has completed click 'Install' to update your device.  
NOTE THAT THE DEVICE WILL REBOOT AUTOMATICALLY AFTER FIRMWARE UPDATE. IT IS RECOMMENDED THAT CONNECTED DEVICES ARE POWERED DOWN PRIOR TO CLICKING 'INSTALL'

Processor Firmware - v 0.57 - 06171108

## UPDATING FIRMWARE CONTINUED

- Please note that the RackLink device will reboot automatically after the firmware update. It is highly recommended that all connected devices are powered down prior to clicking **Install**.

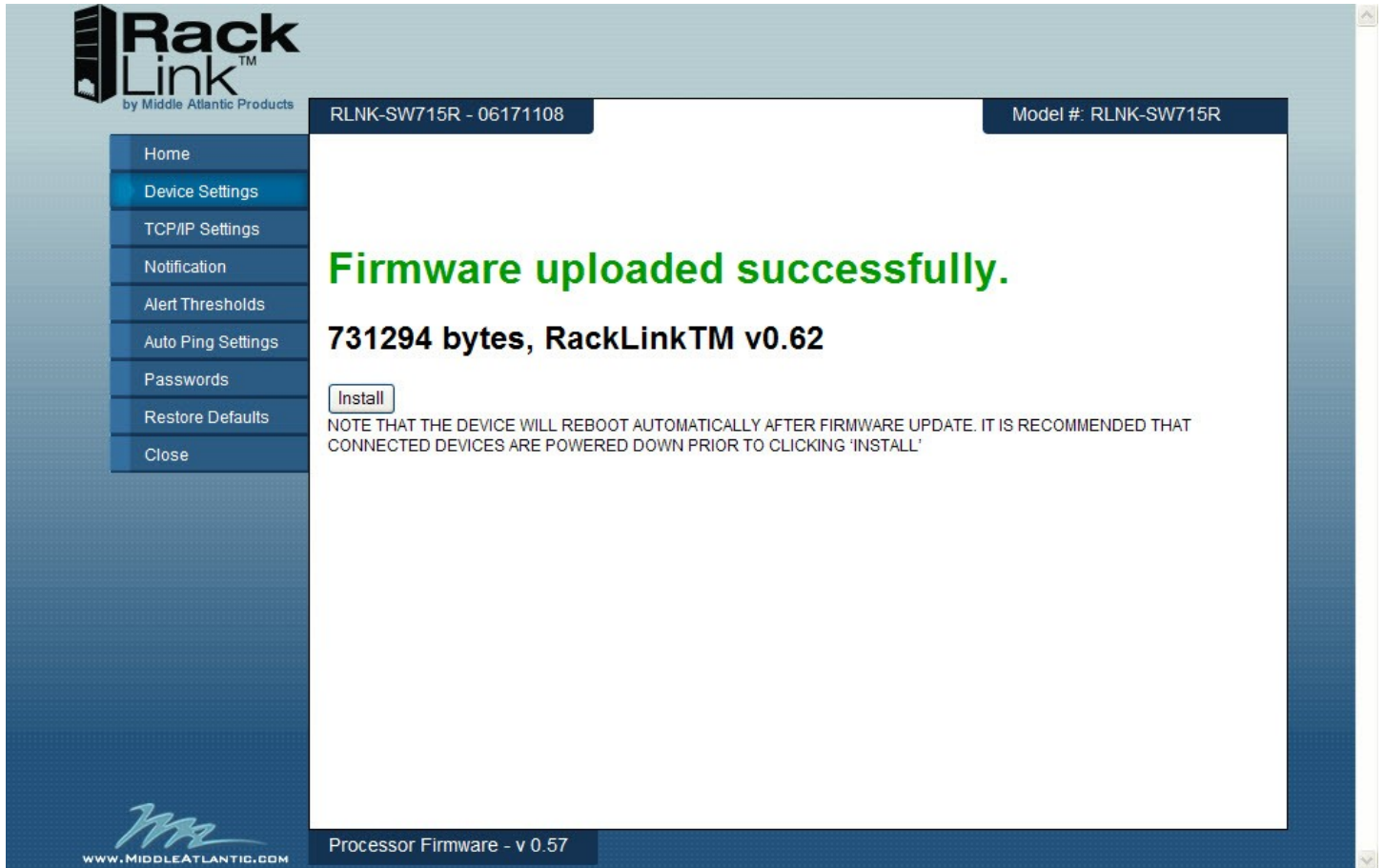

The screenshot shows the RackLink web interface. At the top left is the RackLink logo with the tagline "by Middle Atlantic Products". The top right displays the device ID "RLNK-SW715R - 06171108" and the model number "Model #: RLNK-SW715R". A left-hand navigation menu includes options like Home, Device Settings, TCP/IP Settings, Notification, Alert Thresholds, Auto Ping Settings, Passwords, Restore Defaults, and Close. The main content area features a large green heading: "Firmware uploaded successfully." Below this, it states "731294 bytes, RackLink™ v0.62" and includes an "Install" button. A note below the button reads: "NOTE THAT THE DEVICE WILL REBOOT AUTOMATICALLY AFTER FIRMWARE UPDATE. IT IS RECOMMENDED THAT CONNECTED DEVICES ARE POWERED DOWN PRIOR TO CLICKING 'INSTALL'". At the bottom of the interface, the text "Processor Firmware - v 0.57" is visible, along with the Middle Atlantic logo and website URL "WWW.MIDDLEATLANTIC.COM".

- Once the upload is completed, click **install** to complete the installation.
- You will see the following message until the device has fully completed the installation.

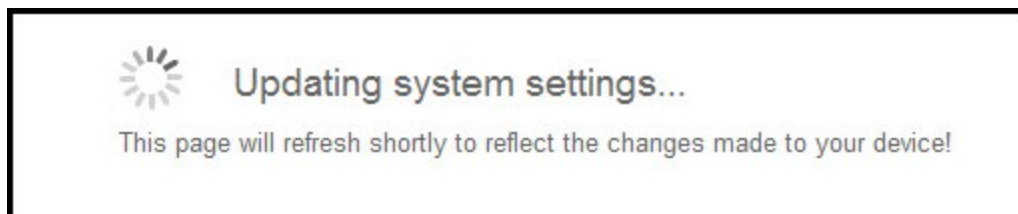

- Once the installation is complete, your device will reboot and you will be redirected to the My Device page.



## MOBILE APPLICATION FUNCTIONALITY

There are two ways to discover your RackLink device. Using the Device Discovery software, or with the Device Discovery provided with the mobile application.

- For the mobile application to discover the RackLink device, the device and mobile phone must be on the same wireless network.
  
- This mobile application will allow the user to view the following current (live) readings:
  - Input Voltage (RMS)
  - Input Voltage (Peak)
  - Load Current (RMS)
  - Load Current (Peak)
  - Watts
  - Power Factor
  - Kilowatt Hours (Can be reset)
  - Thermal Load (BTU)
  - Temperature
  
- You can also control any controllable outlet(s) or dry contact(s) from your smart phone.
- **Please Note:** You cannot perform any setup functions of your RackLink device from the mobile application.
  
- **DDNS Server Requirements (optional):** If you have an Internet line that has an address that remains the same (static), configure a port on your firewall to allow pass-through traffic to the RackLink device. Please see your router's instructions on opening ports. If you do not have a static IP address, you must first setup a method of the address change such as using a DDNS service. Once completed, follow those same instructions as if you had a static address and open a port on your router to allow traffic to pass-through.

## SETTING IP ADDRESS WITH DIRECT CONNECTION TO A PC

This section details how to configure the IP settings of your RackLink device with a direct connection to a PC

The following items are required:

- RackLink Device.
- PC running Windows XP or greater. (Steps show in this section reflect Windows XP, these setup steps are similar on the other operating systems).
- Network Crossover Cable (Cat 5 or better).
- Standard Network Cable (Cat 5 or better).
- Pen and Paper.

### SETTING UP THE PC

- 1) Disconnect the PC from any networks.
- 2) Click the **Start** button in the lower left corner of the screen. Then select **Control Panel**.

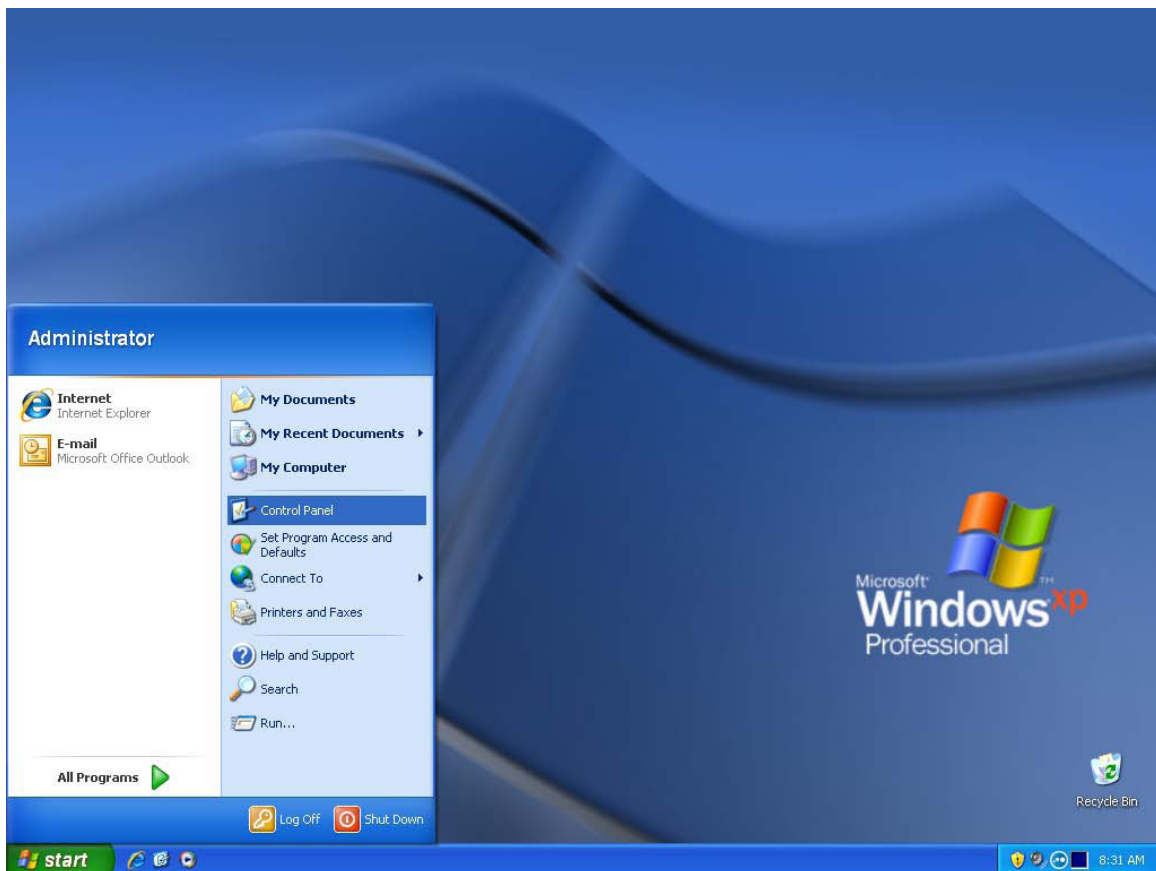

3) Once the Control Panel opens, double click **Network Connections**.

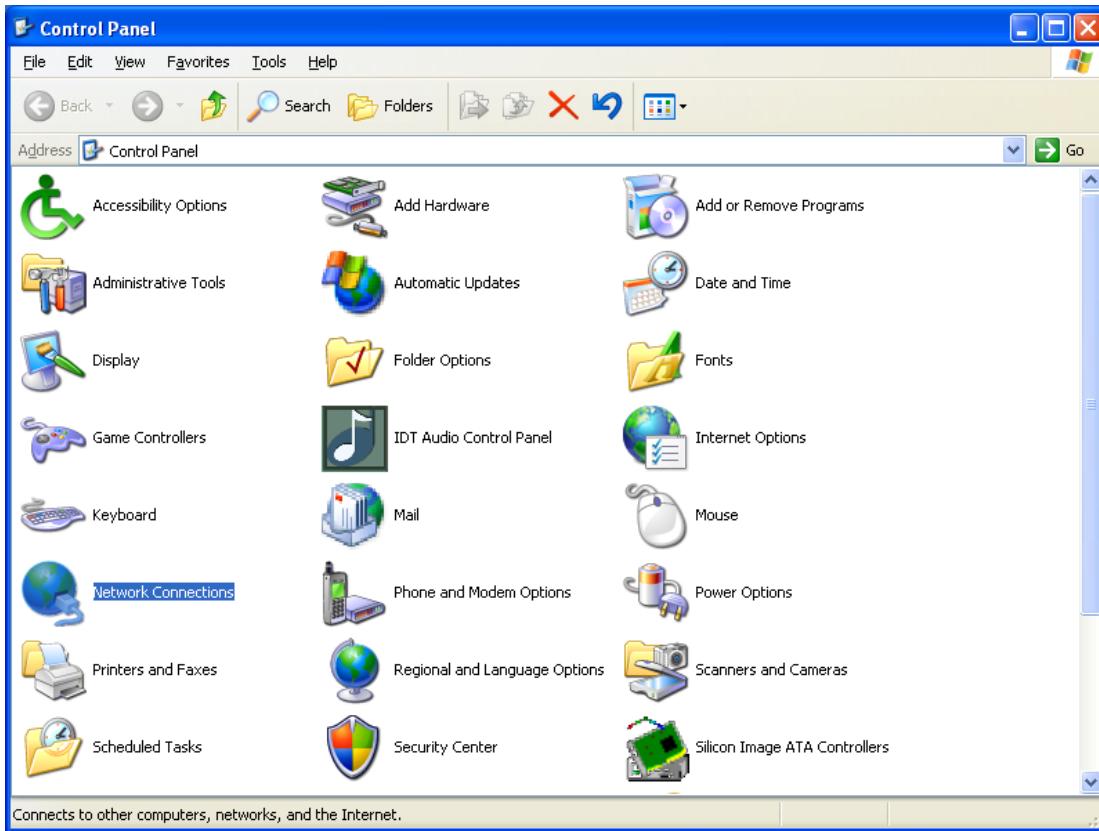

4) In the Network Connections window, locate the computer's **wired network** connection. It should be listed in the **LAN or High-Speed Internet** group and should have a name similar to Local Area Connection. **Right click** on the **connection** and then **left click** on **Properties**.

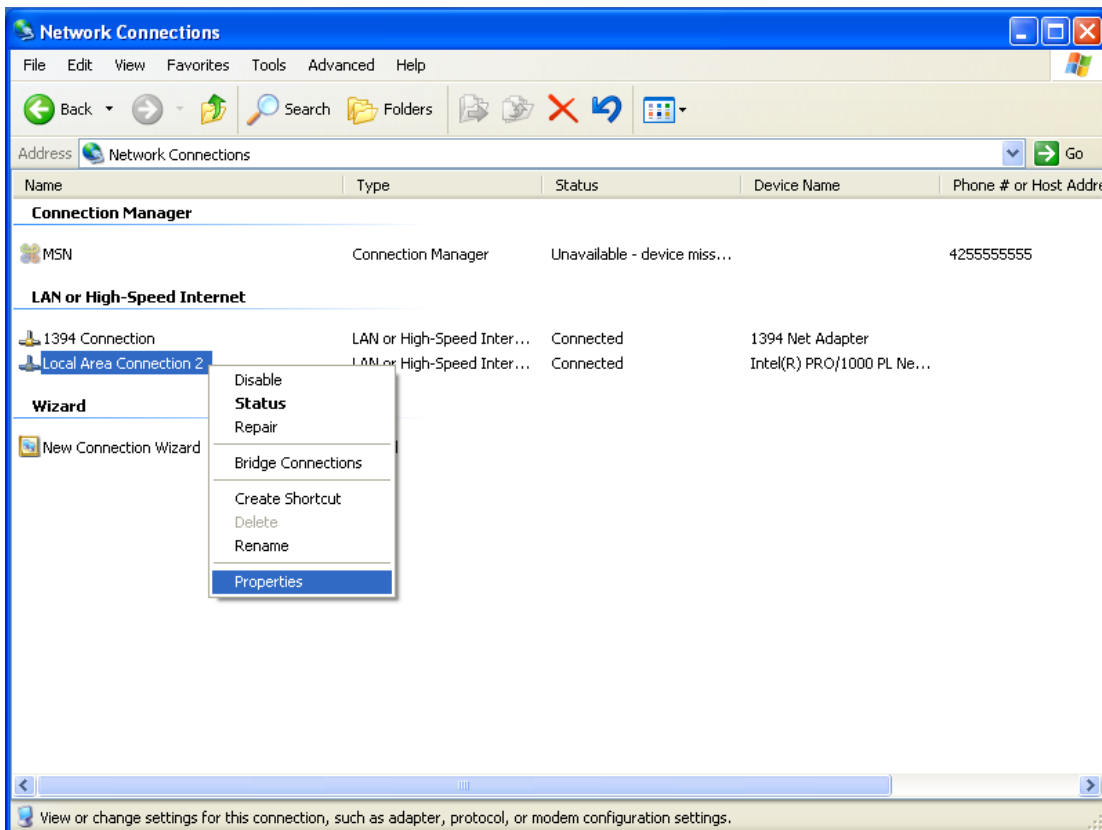

5) In the **Local Area Connection Properties** window, select **Internet Protocol (TCP/IP)** by clicking on it once. Click on the **Properties** button.

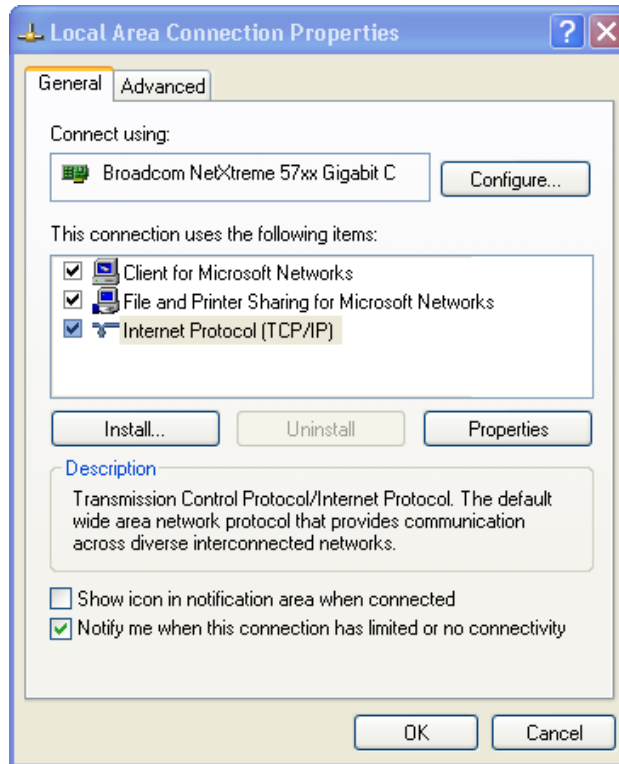

6) The Internet Protocol (TCP/IP) Properties window displays the computer's current settings and allows the settings to be changed. Write down the computer's current settings (these settings will be needed later to restore the computer to its original settings once RackLink has been set up).

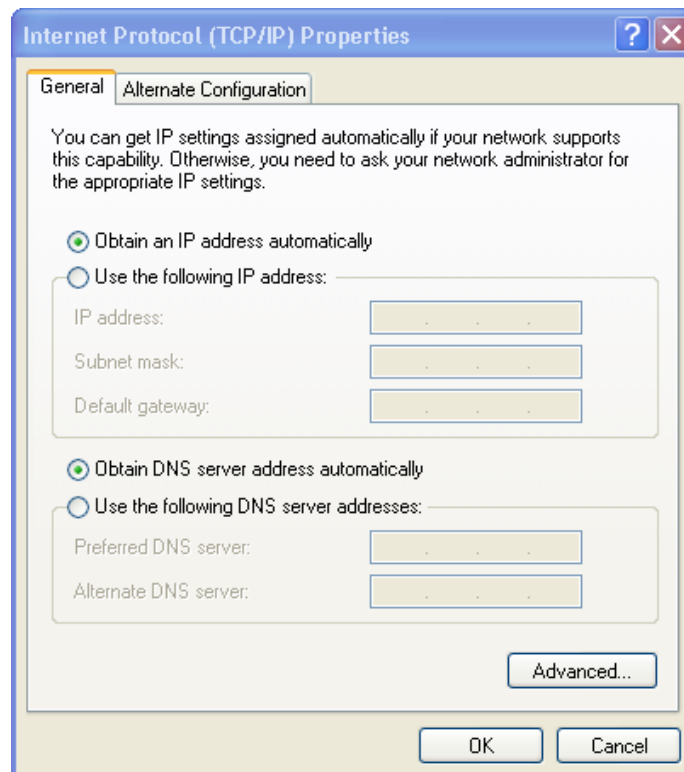

- 7) Select **Use the following IP address** and enter **192.168.1.100** in the **IP address** field. Enter **255.255.255.0** in the **Subnet mask** field. Leave the other fields blank. When the properties window looks like the following image, click **OK**.

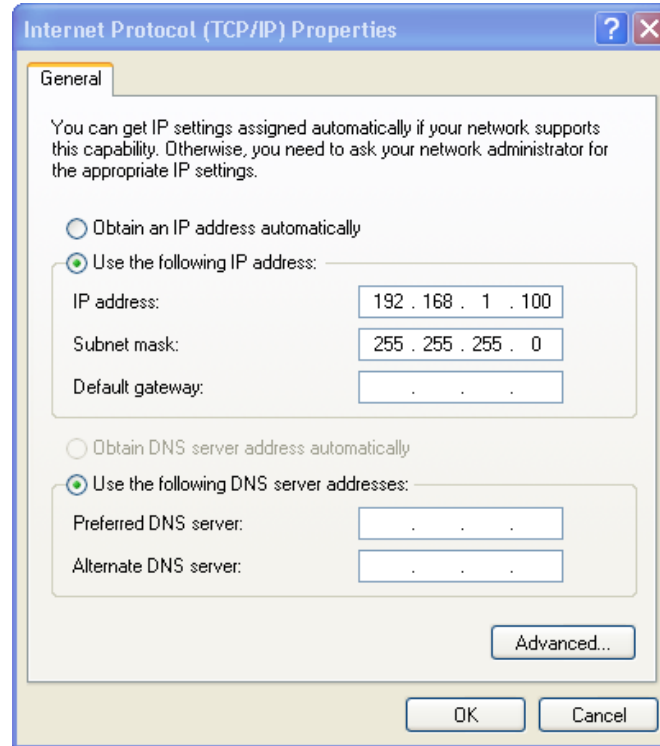

- 8) The PC setup is now complete. The PC may need rebooting for the new settings to take effect.

## **SETTING UP RACKLINK**

- 1) Plug one end of the network crossover cable into the network jack on the rear of the RackLink unit and plug the other end into the PC's network jack.
- 2) Plug in the RackLink unit.
- 3) After a few seconds, the computer and the RackLink unit should establish a network connection. Open a **web browser** (Microsoft Internet Explorer 7 or higher is recommended) and navigate to **http://192.168.1.200**.
- 4) Login to the RackLink interface. The default **login** and **password** are **admin/admin**.
- 5) Navigate to the **Setup** menu and select **TCP/IP Settings**.
- 6) Change the network information to the desired settings and click **Apply**. After the settings have been changed, the RackLink unit will no longer be accessible from the connected PC.
- 7) Disconnect the network crossover cable connecting the RackLink unit and the computer.
- 8) Restore the PC to the original settings and put the RackLink device in its final location.

## TROUBLESHOOTING

Forgotten Password	Press the Restore Defaults button on the device. This will default the login to admin and the password to admin (Please note that pressing this button will also default the device to Use DHCP).
Cannot Access User Interface	Check to see if you can access a general web-page.
	Ensure the green LED on the Ethernet port is on solid and the yellow LED is blinking.
Unit Will Not Operate After Firmware Upgrade	Contact Middle Atlantic Tech Support at 1-800-266-7225.
RackLink Device Not Receiving Power	Check the power cable, confirm the unit's circuit breaker is in the on position.
	Plug another device into the receptacle that the RackLink device is plugged into and see if that unit is receiving power.

## RLNK-SW715R FEATURE SET



- 1) 2-Stage Surge Protection LEDs. Protected when lit.
- 2) Power Switch with Switch Guard.
- 3) System Alarm LED: The LED will illuminate when there is an alarm condition. The following conditions will cause an alarm condition. *Input Voltage Alert Threshold, Load Current Alert Threshold and Temperature Alert Threshold and a No Response to Auto Ping.*

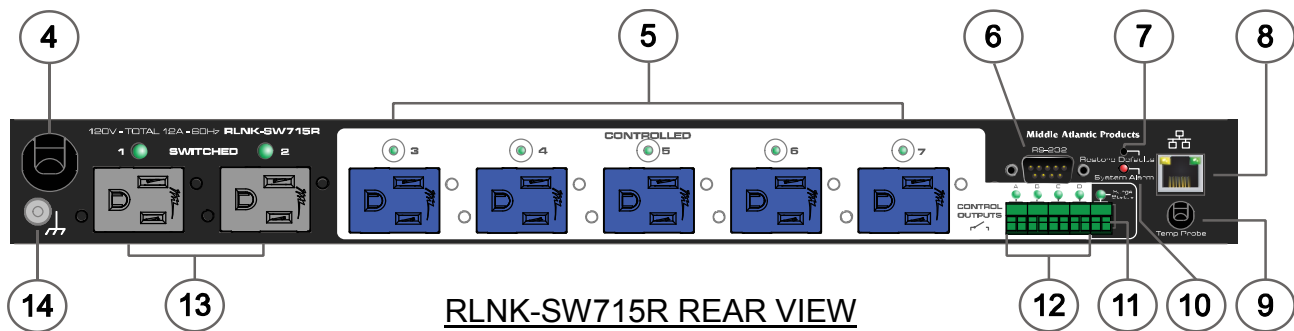

- 4) Mains Power Cord: 120V nominal, 12A (total load, all outlets), 60Hz input.
- 5) Five Controlled Receptacles and Manual Push-Button Switches with Integrated On/Off LED: The LED will illuminate if the receptacle is energized.
- 6) RS-232, DB-9 Male Connector: Requires a female-to-female, null modem cable for communication with a control system.
- 7) Default Restoration Button: Resets to DHCP and to default passwords.
- 8) 10/100 Ethernet Port: Used to connect to a network, requires a Cat-5 or better cable.
- 9) Six Foot Temperature Probe: Mount at the highest available point in the enclosure.
- 10) System Alarm LED: The LED will illuminate when there is an alarm condition. *Input Voltage Alert Threshold, Load Current Alert Threshold and Temperature Alert Threshold and a No Response to Auto Ping.*
- 11) Surge Status Dry Contact Notification: When a surge occurs, the dry-contact will initiate a notification.
- 12) Four Dry Contact Controls: Can be opened or closed via the user interface.
- 13) Switched Receptacles: Controlled only by the main power switch.
- 14) Ground/Bond Stud.



## RLNK-SW715R-NS FEATURE SET



RLNK-SW715R-NS FRONT VIEW

- 1) Power Switch with Switch Guard.
- 2) System Alarm LED: The LED will illuminate when there is an alarm condition. *Input Voltage Alert Threshold, Load Current Alert Threshold and Temperature Alert Threshold and a No Response to Auto Ping.*

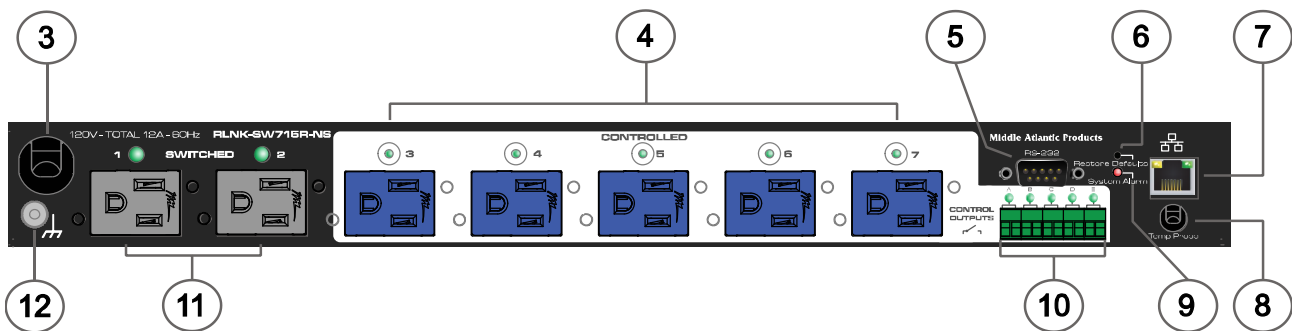

RLNK-SW715R-NS REAR VIEW

- 3) Mains Power Cord: 120V nominal, 12A (total load, all outlets), 60Hz input.
- 4) Five Controlled Receptacles and Manual Push-Button Switches with Integrated On/Off LED: The LED will illuminate if the receptacle is energized.
- 5) RS-232, DB-9 Male Connector: Requires a female-to-female, null modem cable for communication with a control system.
- 6) Default Restoration Button: Resets to DHCP and to default passwords.
- 7) 10/100 Ethernet Port: Used to connect to a network, requires a Cat-5 or better cable.
- 8) Six Foot Temperature Probe: Mount at the highest available point in the enclosure.
- 9) System Alarm LED: The LED will illuminate when there is an alarm condition. *Input Voltage Alert Threshold, Load Current Alert Threshold and Temperature Alert Threshold and a No Response to Auto Ping.*
- 10) Four Dry Contact Controls: Can be opened or closed via the user interface.
- 11) Switched Receptacles: Controlled only by the main power switch.
- 12) Ground/Bond Stud.

## RLNK-SW620R FEATURE SET



- 1) 2-Stage Surge Protection LEDs. Protected when lit.
- 2) Power Switch with Switch Guard.
- 3) System Alarm LED: The LED will illuminate when there is an alarm condition. *Input Voltage Alert Threshold, Load Current Alert Threshold and Temperature Alert Threshold and a No Response to Auto Ping.*

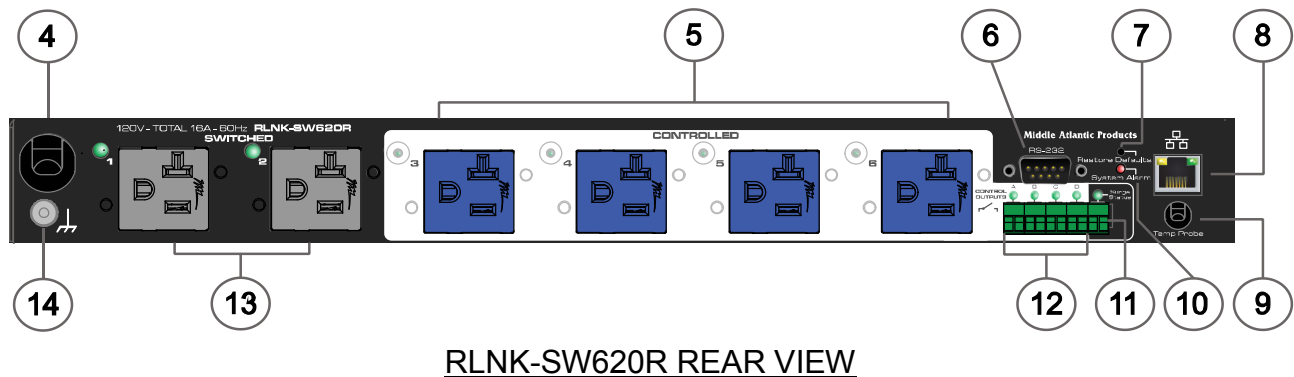

- 4) Mains Power Cord: 120V nominal, 16A (total load, all outlets), 60Hz input.
- 5) Four Controlled Receptacles and Manual Push-Button Switches with Integrated On/Off LED: The LED will illuminate if the receptacle is energized.
- 6) RS-232, DB-9 Male Connector: Requires a female-to-female, null modem cable for communication with a control system.
- 7) Default Restoration Button: Resets to DHCP and to default passwords.
- 8) 10/100 Ethernet Port: Used to connect to a network, requires a Cat-5 cable.
- 10) System Alarm LED: The LED will illuminate when there is an alarm condition. *Input Voltage Alert Threshold, Load Current Alert Threshold and Temperature Alert Threshold and a No Response to Auto Ping.*
- 11) Surge Status Dry Contact Notification: When a surge occurs, the dry-contact will initiate a notification.
- 12) Four Dry Contact Controls: Can be opened or closed via the user interface.
- 13) Switch Receptacles: Controlled only by the main power switch.
- 14) Ground/Bond Stud.

## RLNK-SW620R-NS FEATURE SET



- 1) Power Switch with Switch Guard.
- 2) System Alarm LED: The LED will illuminate when there is an alarm condition. *Input Voltage Alert Threshold, Load Current Alert Threshold and Temperature Alert Threshold and a No Response to Auto Ping.*

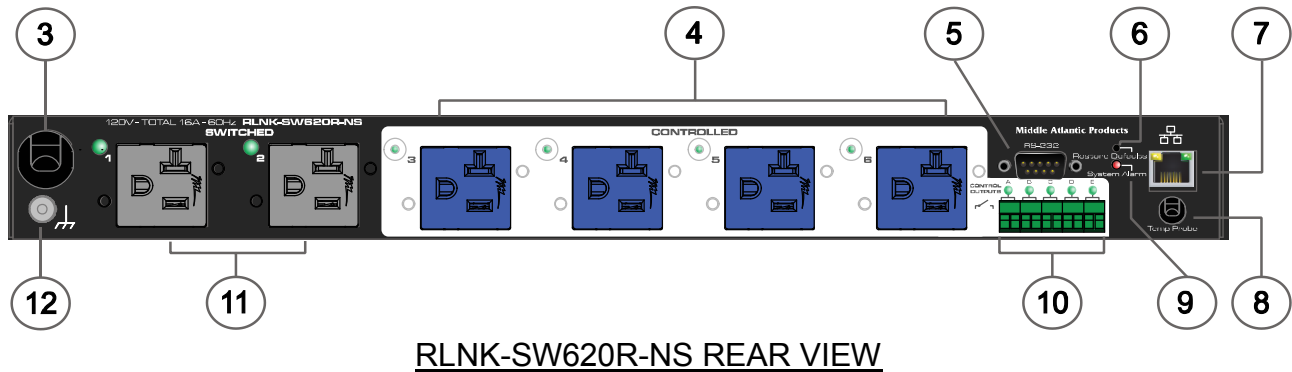

- 3) Mains Power Cord: 120V nominal, 16A (total load, all outlets), 60Hz input.
- 4) Four Controlled Receptacles and Manual On/Off Push-Button Switches with Integrated LED: The LED will illuminate if the receptacle is energized.
- 5) RS-232, DB-9 Male Connector: Requires a female-to-female, null modem cable for communication with a control system.
- 6) Default Restoration Button: Resets to DHCP and to default passwords.
- 7) 10/100 Ethernet Port: Used to connect to a network, requires a Cat-5 cable.
- 8) Six Foot Temperature Probe: Mount at the highest available point in the enclosure.
- 9) System Alarm LED: The LED will illuminate when there is an alarm condition. *Input Voltage Alert Threshold, Load Current Alert Threshold and Temperature Alert Threshold and a No Response to Auto Ping.*
- 10) Four Dry Contact Controls: Can be opened or closed via the user interface.
- 11) Switch Controlled Receptacles: Always on, controlled only by the main power switch.
- 12) Ground/Bond Stud.

## RLNK-SW215-NS FEATURE SET

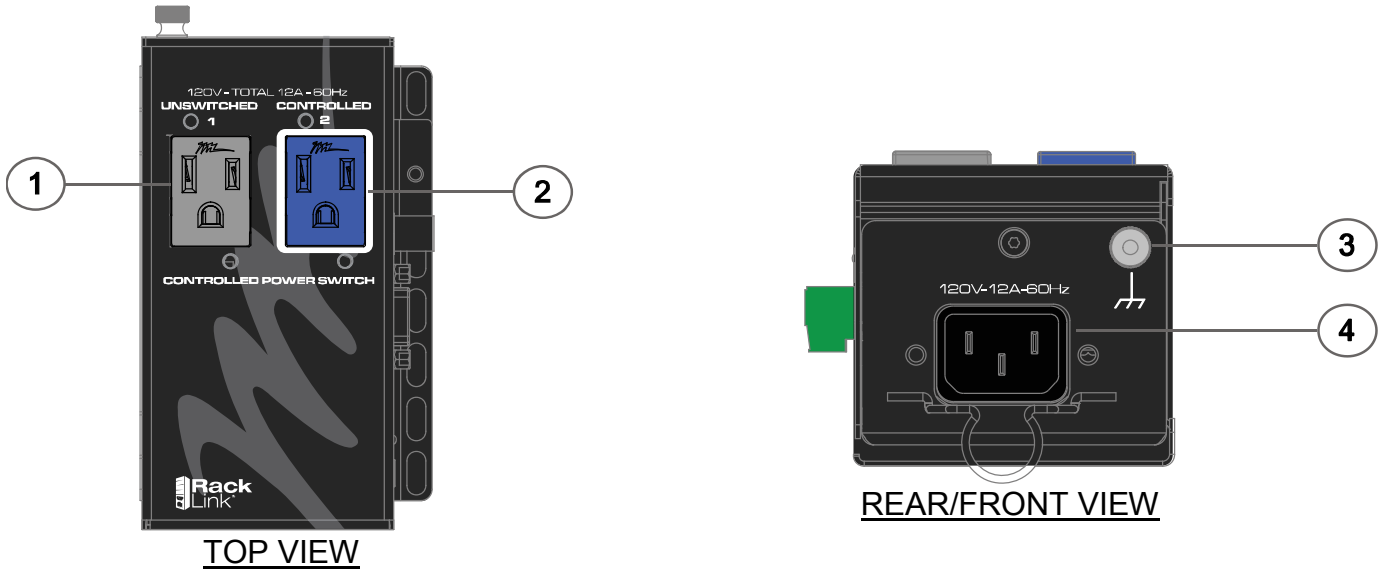

- 1) Unswitched Receptacle: 120V, 60Hz, 12A output (total load, all outlets).
- 2) Controlled Receptacle: 120V, 60Hz, 12A output (total load, all outlets).
- 3) Ground/Bond Stud.
- 4) Mains Power Inlet: 120V, 60Hz, 12A. IEC C13 inlet.

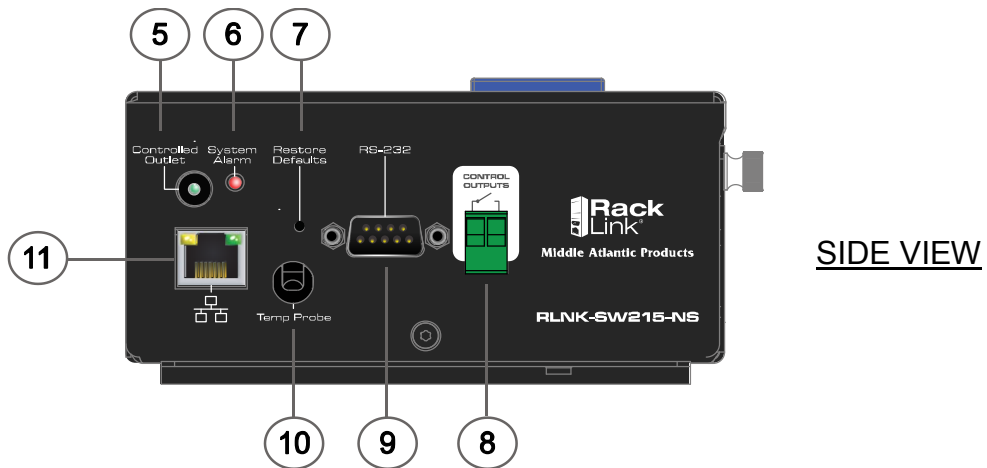

- 5) Controlled Receptacle Manual On/Off Push-Button with Integrated LED: The LED will illuminate if power if the receptacle is energized.
- 6) System Alarm LED: The LED will illuminate when there is an alarm condition. *Input Voltage Alert Threshold, Load Current Alert Threshold and Temperature Alert Threshold and a No Response to Auto Ping.*
- 7) Default Restoration Button: Resets to DHCP and to default passwords.
- 8) Dry Contact Control Output. Can be opened or closed via the user interface.
- 9) RS-232, DB-9 Male Connector: Requires a female-to-female, null modem cable for communication with a control system.
- 10) Six Foot Temperature Probe: Mount at the highest available point in the enclosure.
- 11) 10/100 Ethernet Port: Used to connect to a network, requires a Cat-5 cable.

# RLNK-SW220-NS FEATURE SET

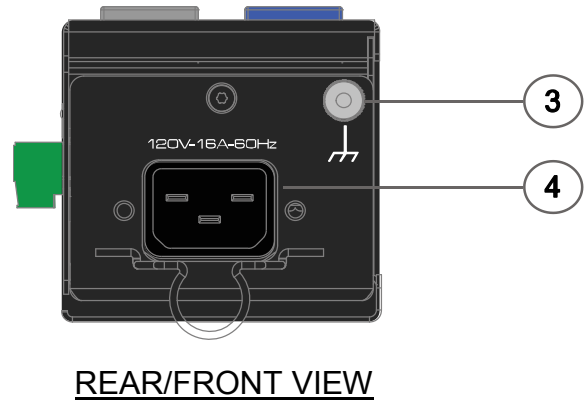
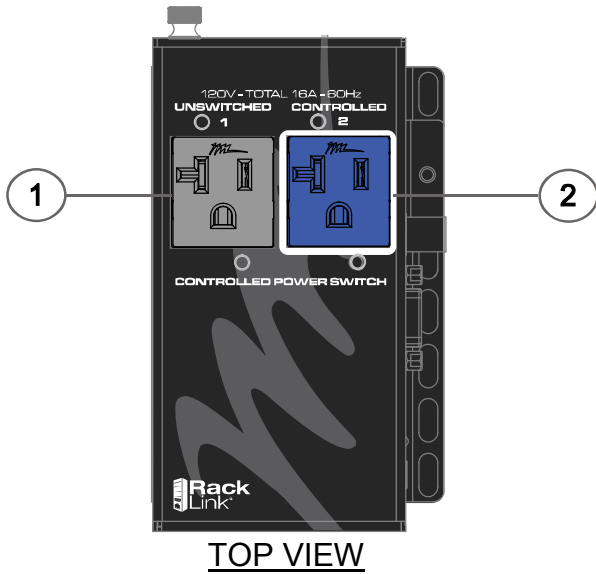

- 1) Unswitched Receptacle: 120V, 60Hz, 16A output (total load, all outlets).
- 2) Controlled Receptacle: 120V, 60Hz, 16A output (total load, all outlets).
- 3) Ground/Bond Stud.
- 4) Mains Power Inlet: 120V, 60Hz, 16A. IEC C13 inlet.

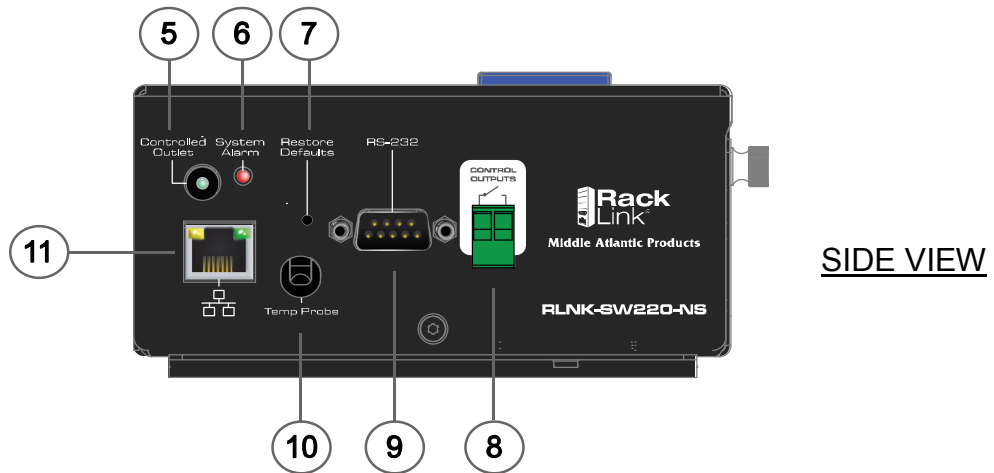

- 5) Controlled Receptacle Manual On/Off Push-Button with Integrated LED: The LED will illuminate if power if the receptacle is energized.
- 6) System Alarm LED: The LED will illuminate when there is an alarm condition. *Input Voltage Alert Threshold, Load Current Alert Threshold and Temperature Alert Threshold and a No Response to Auto Ping.*
- 7) Default Restoration Button: Resets to DHCP and to default passwords.
- 8) Dry Contact Control Output. Can be opened or closed via the user interface.
- 9) RS-232, DB-9 Male Connector: Requires a female-to-female, null modem cable for communication with a control system.
- 10) Six Foot Temperature Probe: Mount at the highest available point in the enclosure.
- 11) 10/100 Ethernet Port: Used to connect to a network, requires a Cat-5 or better cable.

# RLNK-MON115-NS FEATURE SET

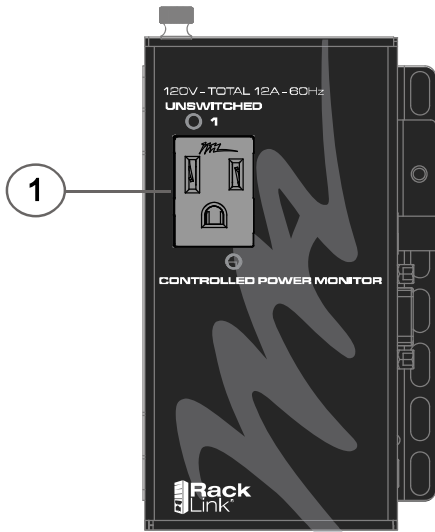

TOP VIEW

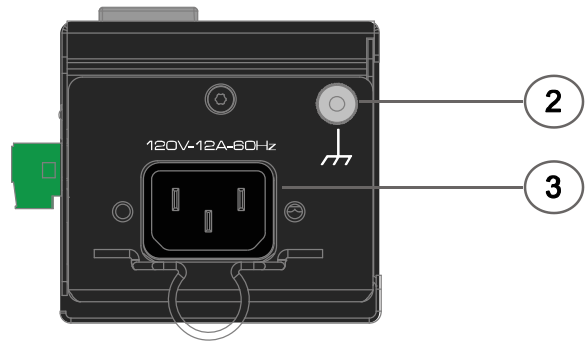

REAR/FRONT VIEW

- 1) Unswitched Receptacle: 120V, 60Hz, 12A.
- 2) Ground/Bond Stud.
- 3) Mains Power Inlet: 120V, 60Hz, 12A. IEC C13 inlet.

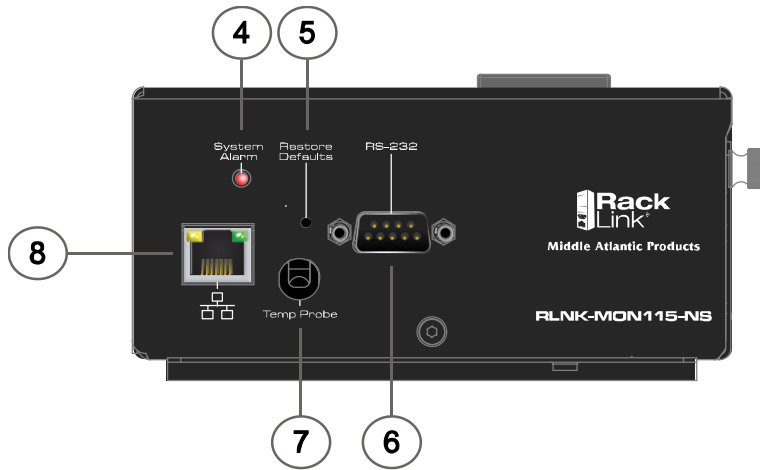

SIDE VIEW

- 4) System Alarm LED: The LED will illuminate when there is an alarm condition. *Input Voltage Alert Threshold, Load Current Alert Threshold and Temperature Alert Threshold and a No Response to Auto Ping.*
- 5) Default Restoration Button: Resets to DHCP and to default passwords.
- 6) RS-232, DB-9 Male Connector: Requires a female-to-female, null modem cable for communication with a control system.
- 7) Six Foot Temperature Probe: Mount at the highest available point in the enclosure.
- 8) 10/100 Ethernet Port: Used to connect to a network, requires a Cat-5 or better cable.

# RLNK-MON120-NS FEATURE SET

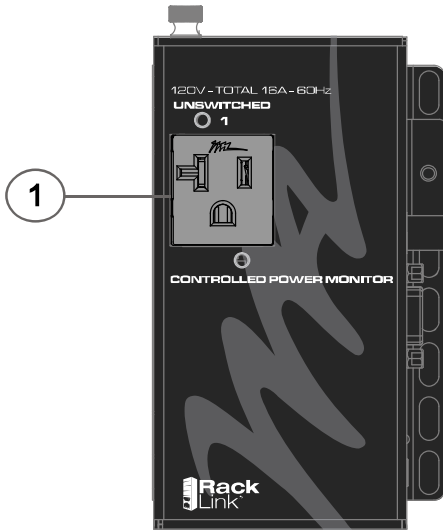

TOP VIEW

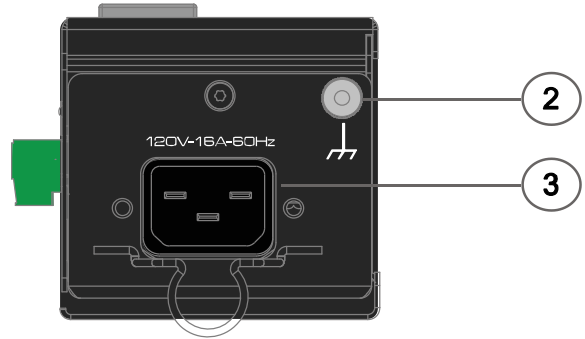

REAR/FRONT VIEW

- 1) Unswitched receptacle: 120V, 60Hz, 16A.
- 2) Ground/Bond stud.
- 3) Mains Power Inlet: 120V, 60Hz, 16A. IEC C13 inlet.

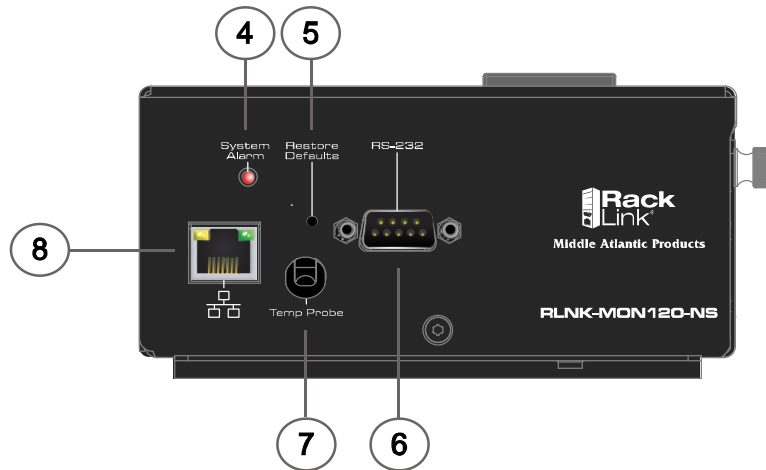

SIDE VIEW

- 4) System Alarm LED: The LED will illuminate when there is an alarm condition. *Input Voltage Alert Threshold, Load Current Alert Threshold and Temperature Alert Threshold and a No Response to Auto Ping.*
- 5) Default Restoration Button: Resets to DHCP and to default passwords.
- 6) RS-232, DB-9 Male Connector: Requires a female-to-female, null modem cable for communication with a control system.
- 7) Six Foot Temperature Probe: Mount at the highest available point in the enclosure.
- 8) 10/100 Ethernet Port: Used to connect to a network, requires a Cat-5 or better cable.



## RLNK-SW815R-SP FEATURE SET

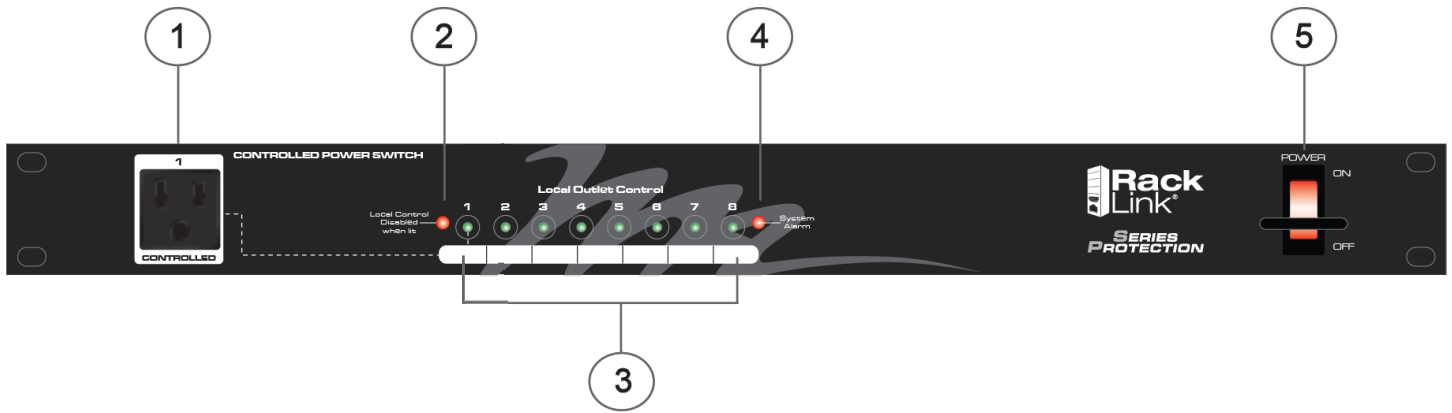

RLNK-SW815R-SP FRONT VIEW

- 1) Controlled Receptacle: Not included in sequence steps.
- 2) Local Control DISABLED When Lit: If local control is selected as disabled in the general settings section of the device settings page, this LED will illuminate.
- 3) Local Control On/Off Push-Button Switch with Integrated LED for Outlets 1 - 8: If local control is enabled, outlets 1 - 8 can be energized/denergized by pressing the button. When the outlet is energized the LED on the button will illuminate.
- 4) System Alarm LED: The LED will illuminate when there is an alarm condition. *Input Voltage Alert Threshold, Load Current Alert Threshold and Temperature Alert Threshold and a No Response to Auto Ping.*
- 5) Power Switch with Switch Guard.
- 6) Ground/Bond Stud.

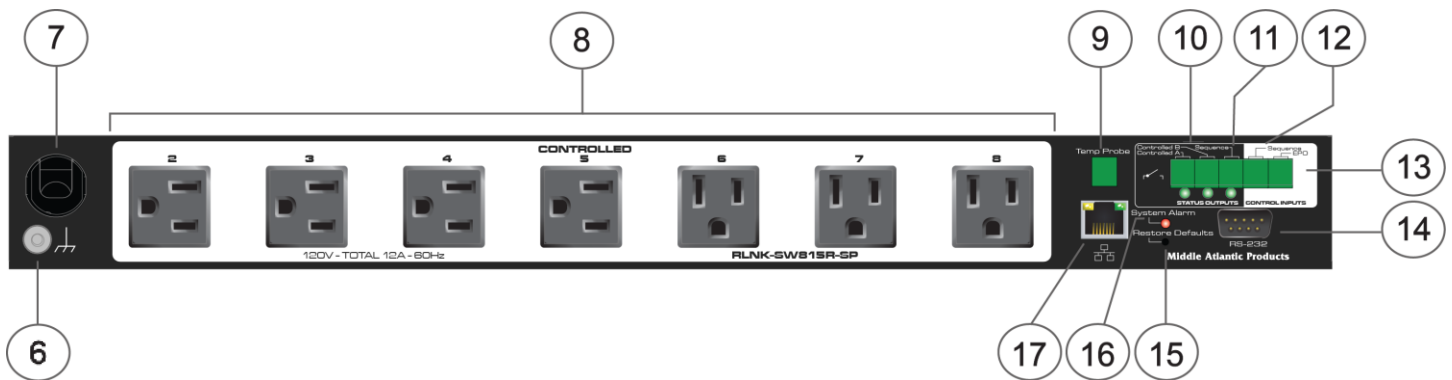

RLNK-SW815R-SP REAR VIEW

- 7) Mains Power Cord: 120V nominal, 12A (total load, all outlets), 60Hz input.
- 8) Controlled Outlets 2 – 8.
- 9) Six Foot Temperature Probe: Mount at the highest available point in the enclosure.

- 10) Two Dry Contact Output Controls (A and B): Can be opened or closed via the user interface. The LED will illuminate if the contact is closed.
- 11) Sequencing Status Output Dry Contact: When a sequence is initiated, this dry contact will close.
- 12) Sequence Dry Contact Control Input: Remote closure will cause the defined sequencing scheme to initiate.
- 13) EPO (Emergency Power Off) Dry Contact Control Input: Remote closure will cause all outlets to turn off at once.
- 14) RS-232, DB-9 Male Connector: Requires a female-to-female, null modem cable for communication with a control system.
- 15) Default Restoration Button: Resets unit to DHCP and to default passwords.
- 16) System Alarm LED: The LED will illuminate when there is an alarm condition. *Input Voltage Alert Threshold, Load Current Alert Threshold and Temperature Alert Threshold and a No Response to Auto Ping.*
- 17) 10/100 Ethernet Port: Used to connect to a network, requires a Cat-5 cable.

## RLNK-SW820R-SP FEATURE SET

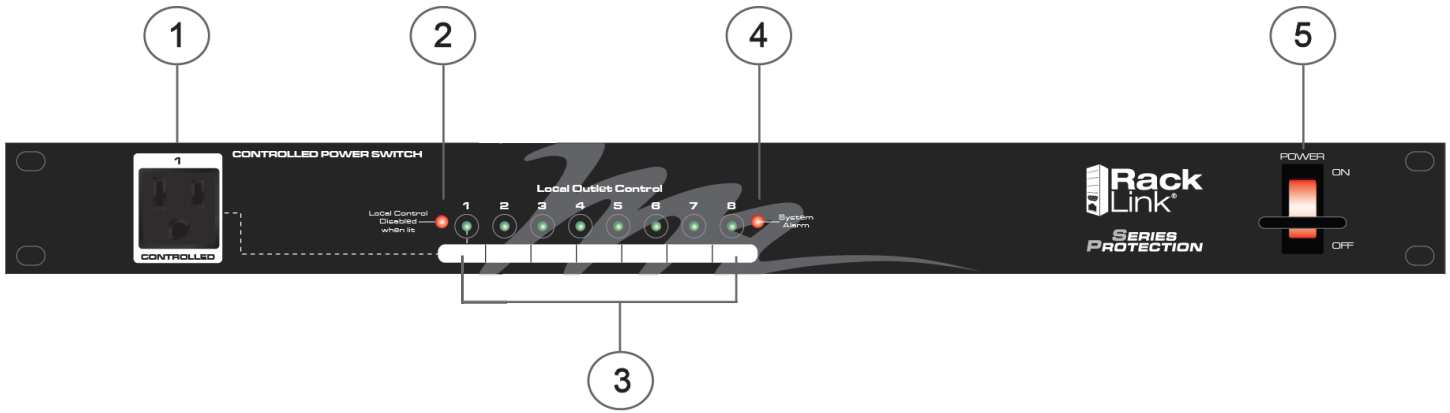

RLNK-SW820R-SP FRONT VIEW

- 1) Controlled Receptacle: Not included in sequence steps.
- 2) Local Control DISABLED When Lit: If local control is selected as disabled in the general settings section of the device settings page, this LED will illuminate.
- 3) Local Control On/Off Push-Button Switch with Integrated LED for Outlets 1 - 8: If local control is enabled, outlets 1 - 8 can be energized/denergized by pressing the button. When the outlet is energized the LED on the button will illuminate.
- 4) System Alarm LED: The LED will illuminate when there is an alarm condition. *Input Voltage Alert Threshold, Load Current Alert Threshold and Temperature Alert Threshold and a No Response to Auto Ping.*
- 5) Power Switch with Switch Guard.
- 6) Ground/Bond Stud.

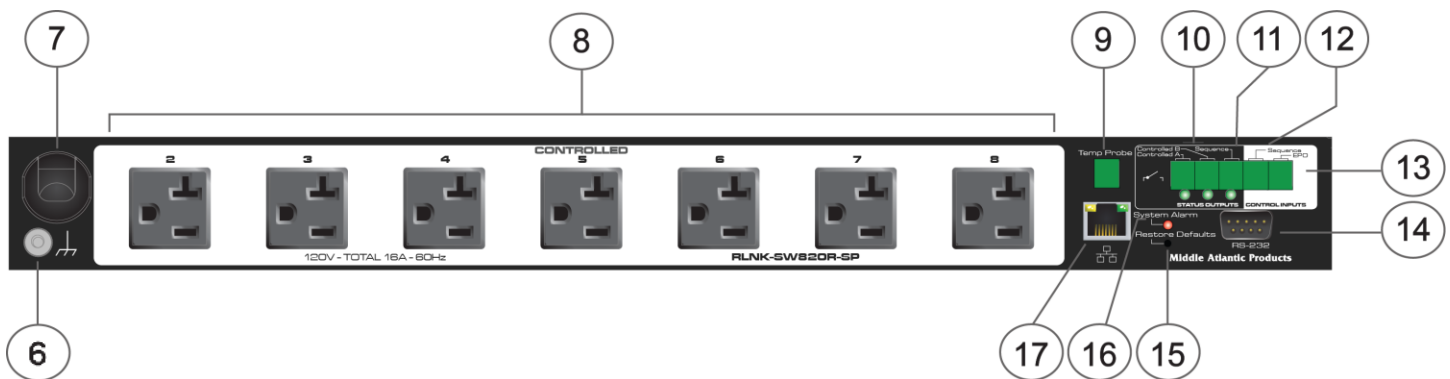

RLNK-SW820R-SP REAR VIEW

- 7) Mains Power Cord: 120V nominal, 16A (total load, all outlets), 60Hz input.
- 8) Controlled Outlets 2 – 8.
- 9) Six Foot Temperature Probe: Mount at the highest available point in the enclosure.

- 10) Two Dry Contact Output Controls (A and B): Can be opened or closed via the user interface. The LED will illuminate if the contact is closed.
- 11) Sequencing Status Output Dry Contact: When a sequence is initiated, this dry contact will close.
- 12) Sequence Dry Contact Control Input: Remote closure will cause the defined sequencing scheme to initiate.
- 13) EPO (Emergency Power Off) Dry Contact Control Input: Remote closure will cause all outlets to turn off at once.
- 14) RS-232, DB-9 Male Connector: Requires a female-to-female, null modem cable for communication with a control system.
- 15) Default Restoration Button: Resets unit to DHCP and to default passwords.
- 16) System Alarm LED: The LED will illuminate when there is an alarm condition. *Input Voltage Alert Threshold, Load Current Alert Threshold and Temperature Alert Threshold and a No Response to Auto Ping.*
- 17) 10/100 Ethernet Port: Used to connect to a network, requires a Cat-5 cable.

## RLNK-SW415R-SP FEATURE SET

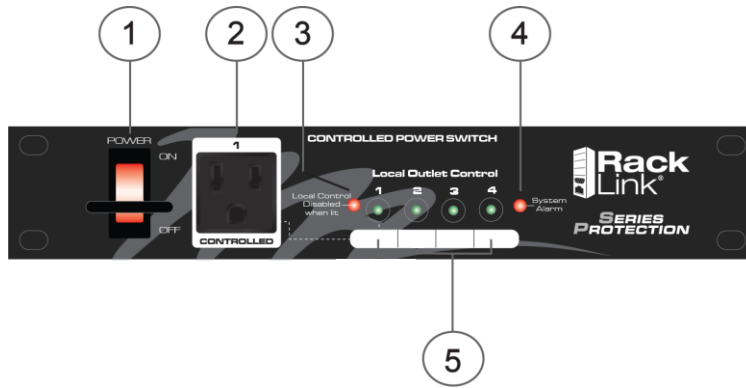

RLNK-SW415R-SP FRONT VIEW

- 1) Power Switch with Switch Guard
- 2) Controlled Receptacle: Not included in sequence step.
- 3) Local Control DISABLED When Lit: If local control is selected as disabled in the general settings section of the device settings page, this LED will illuminate.
- 4) System Alarm LED: The LED will illuminate when there is an alarm condition. *Input Voltage Alert Threshold, Load Current Alert Threshold and Temperature Alert Threshold and a No Response to Auto Ping.*
- 5) Local Control On/Off Push-Button Switch with Integrated LED for Outlets 1 - 4: If local control is enabled, outlets 1 – 4 can be energized/denergized by pressing the button. When the outlet is energized the LED on the button will illuminate.
- 6) Ground/Bond Stud.

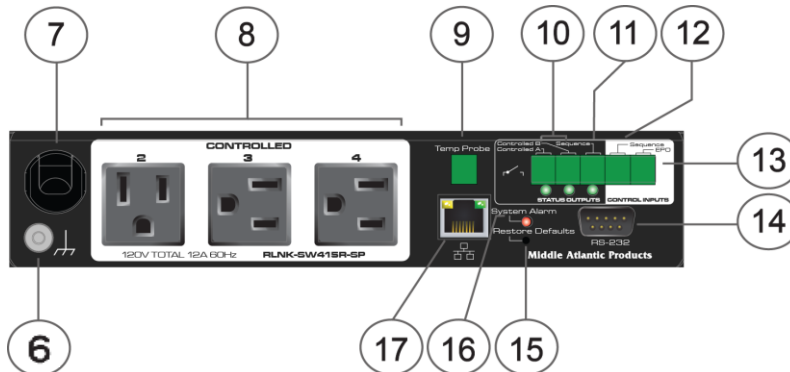

RLNK-SW415R-SP REAR VIEW

- 7) Mains Power Cord: 120V nominal, 12A (total load, all outlets), 60Hz input.
- 8) Controlled Outlets 2 – 4.
- 9) Six Foot Temperature Probe: Mount at the highest available point in the enclosure.

- 10) Two Dry Contact Output Controls (A and B): Can be opened or closed via the user interface. The LED will illuminate if the contact is closed.
- 11) Sequencing Status Output Dry Contact: When a sequence is initiated, this dry contact will close.
- 12) Sequence Dry Contact Control Input: Remote closure will cause the defined sequencing scheme to initiate.
  
- 13) EPO (Emergency Power Off) Dry Contact Control Input: Remote closure will cause all outlets to turn off at once.
- 14) RS-232, DB-9 Male Connector: Requires a female-to-female, null modem cable for communication with a control system.
- 15) Default Restoration Button: Resets unit to DHCP and to default passwords.
- 16) System Alarm LED: The LED will illuminate when there is an alarm condition. *Input Voltage Alert Threshold, Load Current Alert Threshold and Temperature Alert Threshold and a No Response to Auto Ping.*
- 17) 10/100 Ethernet Port: Used to connect to a network, requires a Cat-5 cable.

# DIMENSIONS

## IN-LINE MODELS

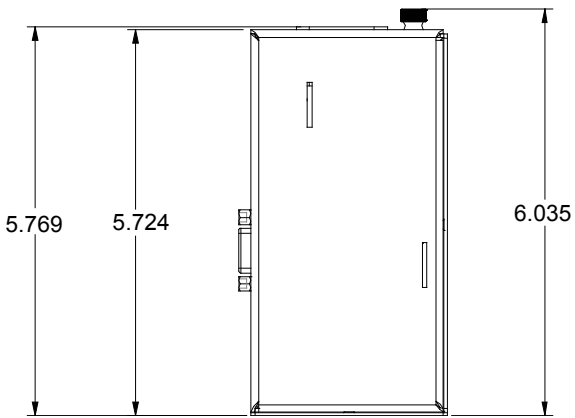

REAR VIEW

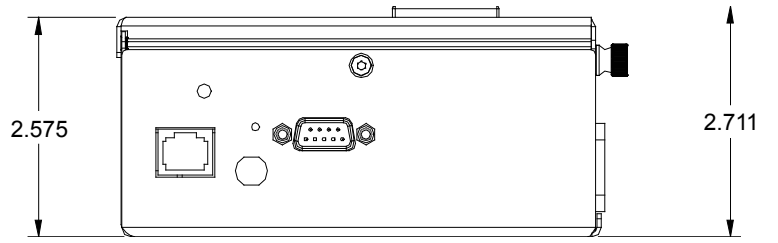

SIDE VIEW

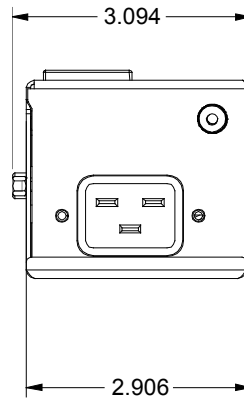

BACK/FRONT VIEW

## RACKMOUNT MODELS

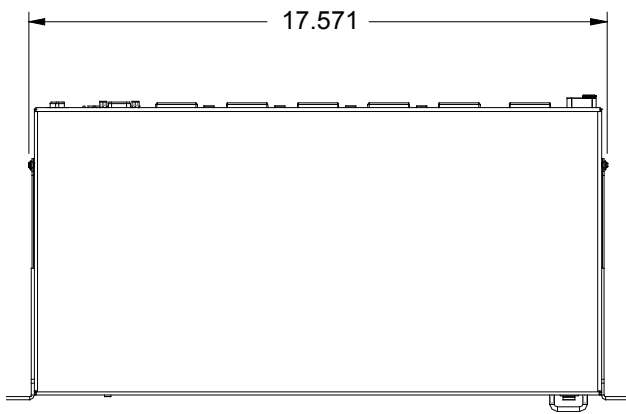

TOP VIEW

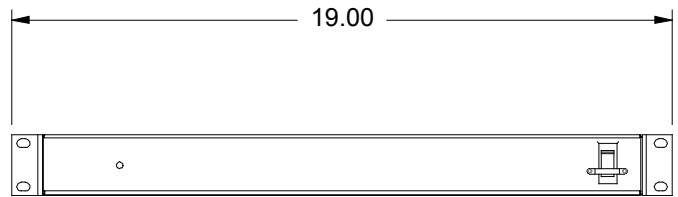

FRONT VIEW

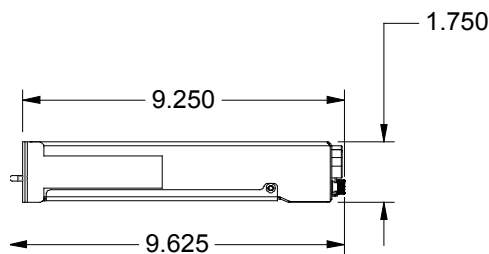

SIDE VIEW



## HALF FRAME MODELS

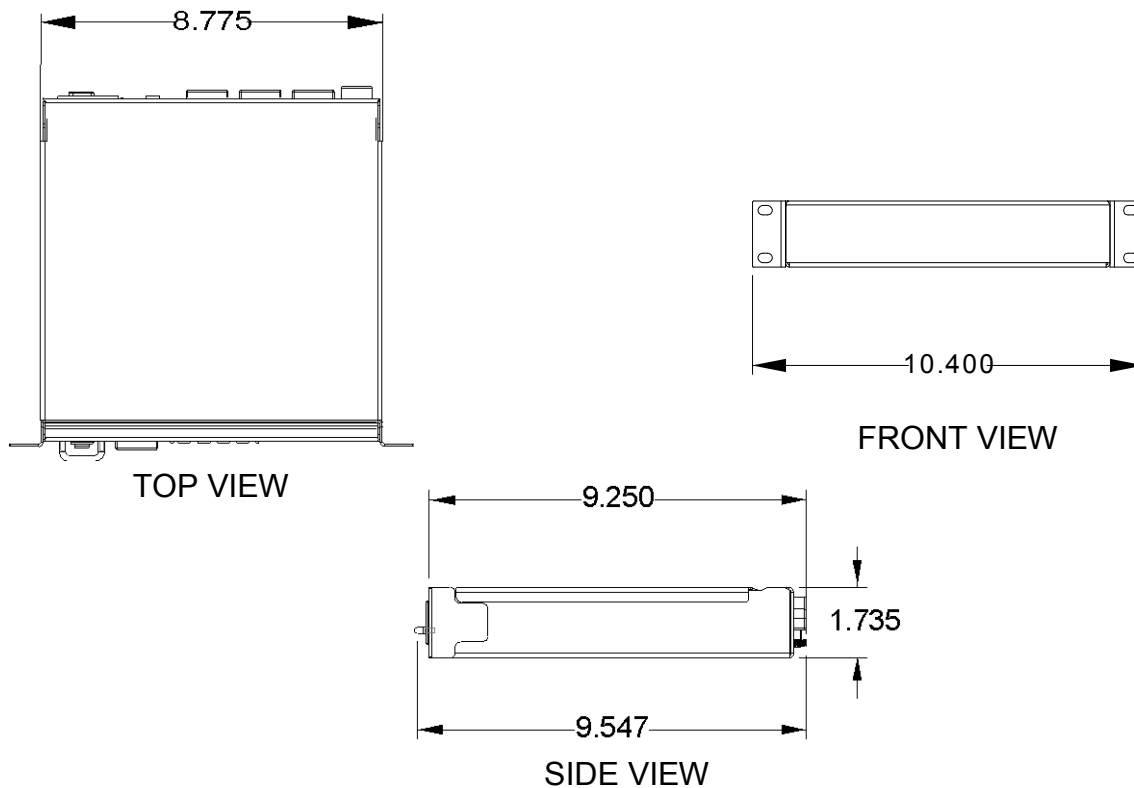

---

### WARRANTY

Middle Atlantic Products, Inc. (the "Company") warrants the RackLink® Device product to be free from defects in material or workmanship under normal use and conditions for a period of (3) three years from date of shipment by the Company.

The Company's entire liability to the purchaser, and the purchaser's (or any other party's) sole and exclusive remedy, under this warranty shall be limited, at the Company's option, to either (a) return of and refund of the price paid for, or (b) repair or replacement at the Company's factory of the products purchased, or any part or parts thereof, which the Company has determined to be defective after inspection thereof at the Company's factory. This warranty does not cover damage due to acts of God, accident, misuse, abuse or negligence by parties other than the Company, or any modification or alteration of the products. In addition, this warranty does not cover damage due to improper handling, assembly, installation or maintenance.

THIS WARRANTY IS IN LIEU OF ALL OTHER WARRANTIES OF ANY KIND, EITHER EXPRESSED OR IMPLIED, INCLUDING, BUT NOT LIMITED TO, IMPLIED WARRANTIES OF MERCHANTABILITY AND FITNESS FOR A PARTICULAR PURPOSE. TO THE MAXIMUM EXTENT PERMITTED BY APPLICABLE LAW, IN NO EVENT SHALL THE COMPANY BE LIABLE FOR ANY SPECIAL, INCIDENTAL, INDIRECT, OR CONSEQUENTIAL DAMAGES WHATSOEVER (INCLUDING, WITHOUT LIMITATION, DAMAGES FOR LOSS OF BUSINESS PROFITS, BUSINESS INTERRUPTION OR ANY OTHER PECUNIARY LOSS) ARISING OUT OF THE USE OF THE PRODUCTS PURCHASED, EVEN IF THE COMPANY HAS BEEN ADVISED OF THE POSSIBILITY OF SUCH DAMAGES. THE COMPANY'S LIABILITY TO THE PURCHASER (OR ANY OTHER PARTY) HEREUNDER, IF ANY, SHALL IN NO EVENT EXCEED THE PURCHASE PRICE OF THE PRODUCTS PAID TO THE COMPANY.

Corporate Headquarters  
Corporate Voice 973-839-1011 - Fax 973-839-1976 / International Voice +1 973-839-8821 - Fax +1 973-839-4982  
middleatlantic.com - info@middleatlantic.com

Middle Atlantic Canada  
Voice 613-836-2501 - Fax 613-836-2690 / middleatlantic.ca - customerservicecanada@middleatlantic.ca