

# INSPIRON™

## SETUP GUIDE



YOURS IS HERE



# INSPIRON™

## SETUP GUIDE

Regulatory model: W01C series

Regulatory type: W01C001; W01C002

# Notes, Cautions, and Warnings

 **NOTE:** A NOTE indicates important information that helps you make better use of your computer.

 **CAUTION:** A CAUTION indicates either potential damage to hardware or loss of data and tells you how to avoid the problem.

 **WARNING:** A WARNING indicates a potential for property damage, personal injury, or death.

If you purchased a Dell™ n Series computer, any references in this document to the Microsoft® Windows® operating systems are not applicable.

---

**Information in this document is subject to change without notice.**

© 2010 Dell Inc. All rights reserved.

Reproduction of these materials in any manner whatsoever without the written permission of Dell Inc. is strictly forbidden.

Trademarks used in this text: *Dell*, the *DELL* logo, *YOURS IS HERE*, *Inspiron*, *Solution Station*, and *DellConnect* are trademarks of Dell Inc.; *Intel* and *Centrino* are registered trademarks and *Core* is a trademark of Intel Corporation in the U.S. and other countries; *AMD*, *AMD Athlon*, and *ATI Mobility Radeon* are either trademarks or registered trademarks of Advanced Micro Devices, Inc.; *Microsoft*, *Windows*, and the *Windows* start button logo are either trademarks or registered trademarks of Microsoft Corporation in the United States and/or other countries; *Blu-ray Disc* is a trademark of the Blu-ray Disc Association; *Bluetooth* is a registered trademark owned by Bluetooth SIG, Inc. and is used by Dell under license.

Other trademarks and trade names may be used in this document to refer to either the entities claiming the marks and names or their products. Dell Inc. disclaims any proprietary interest in trademarks and trade names other than its own.

**July 2010**

**P/N JMV0N**

**Rev. A00**

# Contents

<b>Setting Up Your Inspiron One</b> . . . . .	<b>5</b>	Using the Optical Drive . . . . .	28
Before Setting Up Your Computer . . . . .	5	Back View Features . . . . .	30
Connect the Keyboard and Mouse . . . . .	6	Display Features . . . . .	34
Connect the AC Adapter . . . . .	7	Using the Touch Screen (Optional) . . . . .	36
Connect the Network Cable (Optional) . . . . .	8	Software Features . . . . .	40
Adjust the Computer Stand . . . . .	10	Dell DataSafe Online Backup . . . . .	41
Set Up the TV Tuner (Optional) . . . . .	11	Dell Dock . . . . .	42
Press the Power Button . . . . .	16	<b>Solving Problems</b> . . . . .	<b>43</b>
Set Up the Operating System . . . . .	17	Touch Screen Problems . . . . .	43
Create System Recovery Media (Recommended) . . . . .	18	Beep Codes . . . . .	45
Connect to the Internet (Optional) . . . . .	19	Network Problems . . . . .	46
Set Up Wireless Display (Optional) . . . . .	21	Power Problems . . . . .	47
<b>Using Your Inspiron One</b> . . . . .	<b>24</b>	Memory Problems . . . . .	49
Right View Features . . . . .	24	Lockups and Software Problems . . . . .	49
Left View Features . . . . .	26		

## Contents

<b>Using Support Tools</b> .....	<b>52</b>	Returning Items for Repair Under Warranty or for Credit.....	<b>72</b>
Dell Support Center.....	52	Before You Call.....	73
My Dell Downloads.....	53	Contacting Dell.....	75
System Messages.....	53		
Hardware Troubleshooter.....	55	<b>Finding More Information and Resources</b> .....	<b>76</b>
Dell Diagnostics.....	56		
<b>Restoring Your Operating System</b> .....	<b>60</b>	<b>Specifications</b> .....	<b>78</b>
System Restore.....	61	<b>Appendix</b> .....	<b>84</b>
Dell DataSafe Local Backup.....	62	Macrovision Product Notice.....	84
System Recovery Media.....	65	Information for NOM, or Official Mexican Standard (Only for Mexico).....	85
Dell Factory Image Restore.....	66		
<b>Getting Help</b> .....	<b>68</b>	<b>Index</b> .....	<b>86</b>
Technical Support and Customer Service.....	69		
DellConnect.....	69		
Online Services.....	70		
Automated Order-Status Service.....	71		
Product Information.....	71		

# Setting Up Your Inspiron One

This section provides information about setting up your Dell™ Inspiron One computer.

 **WARNING:** Before you begin any of the procedures in this section, read the safety information that shipped with your computer. For additional safety best practices information, see the Regulatory Compliance Homepage at [www.dell.com/regulatory\\_compliance](http://www.dell.com/regulatory_compliance).

 **NOTE:** Your computer's Service Tag and Express Service Code are located on a label at the back of your computer. Use the Service Tag or Express Service Code to identify your computer when you access the Dell Support website or contact technical support.

## Before Setting Up Your Computer

When positioning your computer, ensure that you allow easy access to a power source, adequate ventilation, and a level surface to place your computer.

Restricting airflow around your computer may cause it to overheat. To prevent overheating ensure that you leave at least 10.2 cm (4 inches) at the back of the computer and a minimum of 5.1 cm (2 inches) on all other sides. You should never place your computer in an enclosed space, such as a cabinet or drawer when it is powered on.

## Connect the Keyboard and Mouse

Connect the USB keyboard and mouse to the USB connectors on the computer.

-  **NOTE:** If you purchased a wireless keyboard and mouse along with your computer, connect the USB receiver to the USB connector. For more information, see the documentation that shipped with the wireless keyboard and mouse.

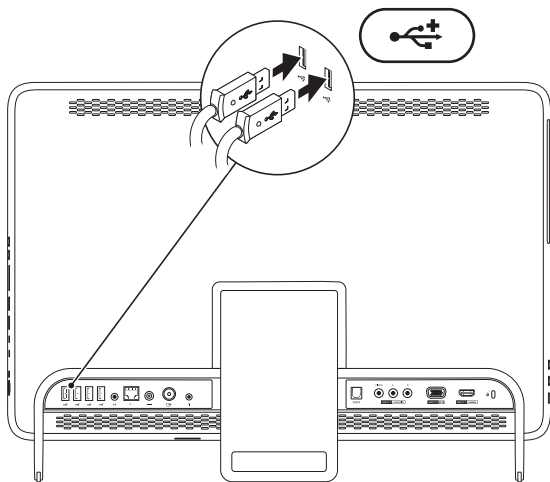



## Connect the AC Adapter

Connect the AC adapter to the computer and then plug it into an electrical outlet or surge protector.

**⚠ WARNING:** The AC adapter works with electrical outlets worldwide. However, power connectors and power strips vary among countries. Using an incompatible cable or improperly connecting the cable to a power strip or electrical outlet may cause fire or permanent damage to your computer.

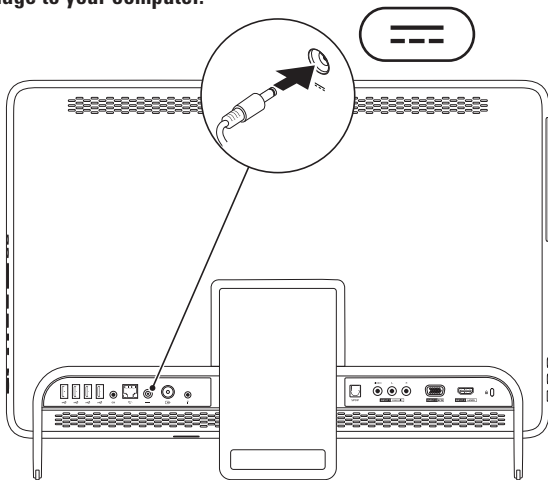

## Connect the Network Cable (Optional)

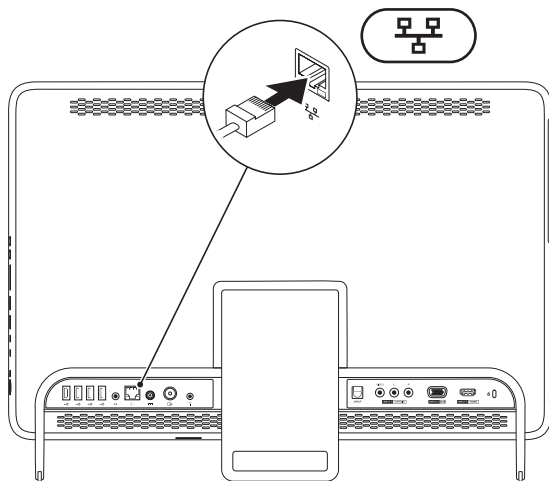

A network connection is not required to complete this computer setup, but if you have an existing network or Internet connection that uses a cable connection (such as a home cable modem or Ethernet jack), you can connect it now.

 **NOTE:** Use only an Ethernet cable (RJ45 connector) to connect to the network connector. Do not plug a telephone cable (RJ11 connector) into the network connector.

To connect your computer to a network or broadband device, connect one end of a network cable to either a network port or a broadband device. Connect the other end of the network cable to the network connector (RJ45 connector) on the back panel of your computer. A click indicates that the network cable has been securely attached.

## Adjust the Computer Stand

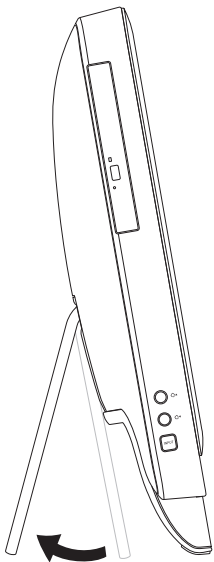

**⚠ WARNING:** Do not use the stand to carry the computer or tilt the computer upside down.

Pull the stand to adjust the display to a comfortable viewing angle. A distinct click is heard when the stand is opened or closed.

## Set Up the TV Tuner (Optional)

You can watch TV on your computer by connecting either a TV/digital antenna cable or a set-top box to your computer.

### Set Up Using a Set-Top Box

1. Peel the protective cover from the IR transmitter and adhere the IR transmitter to the IR sensor on the set-top box.
2. Connect the IR transmitter cable to the IR blaster connector on your computer.

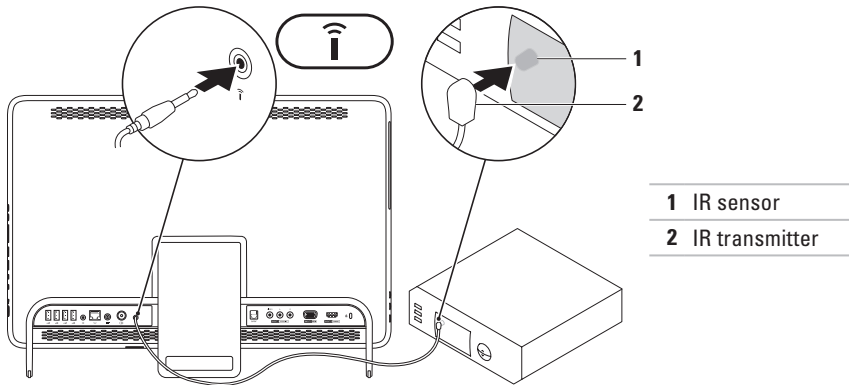

## Setting Up Your Inspiron One

3. Connect the RF cable to the RF-out connector on your set-top box and to the antenna-in connector on your computer.

 **NOTE:** The RF cable does not ship with your computer and must be purchased separately.

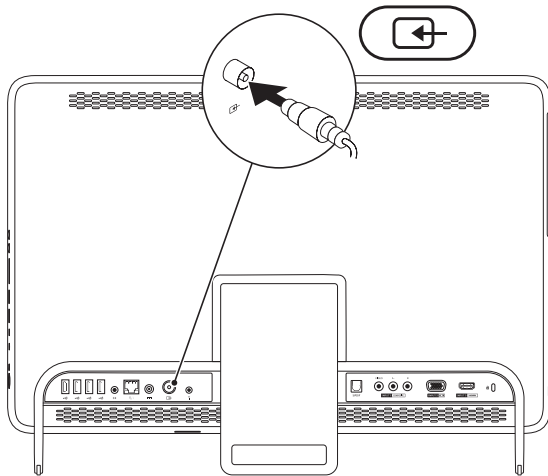

4. Turn on your computer.
5. Click **Start**  → **All Programs** → **Windows Media Center** → **Tasks** → **settings** → **TV**.
6. Follow the instructions on the screen.

## Setting Up Your Inspiron One

### Set Up Using a TV/Digital Antenna Cable

1. If not already inserted, insert the B-CAS card into the B-CAS card slot on your computer (Japan only).

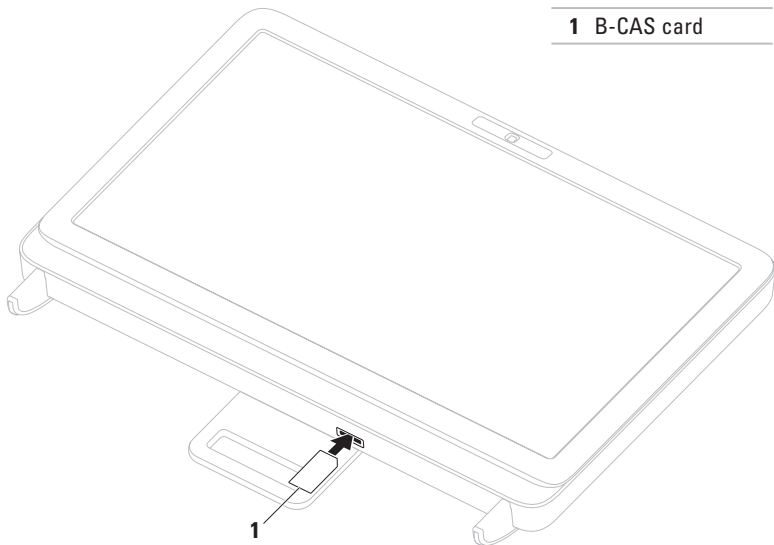



2. Connect the TV/digital antenna cable to the antenna-in connector on your computer.
3. Turn on your computer.
4. Click **Start**  → **All Programs** → **Windows Media Center** → **Tasks** → **settings** → **TV**.
5. Follow the instructions on the screen.

## Press the Power Button

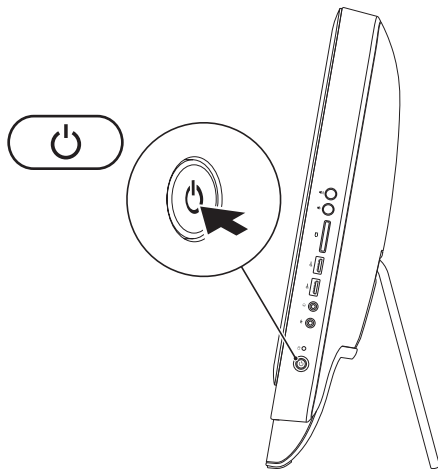



## Set Up the Operating System

Your Dell computer is preconfigured with the operating system you selected at the time of purchase.

### Microsoft Windows

To set up Microsoft® Windows® for the first time, follow the instructions on the screen. These steps are mandatory and may take some time to complete. The Windows setup screens will take you through several procedures including accepting license agreements, setting preferences, and setting up an Internet connection.

 **CAUTION:** Do not interrupt the operating system's setup process. Doing so may render your computer unusable and you will need to reinstall the operating system.

 **NOTE:** For optimal performance of your computer, it is recommended that you download and install the latest BIOS and drivers for your computer available at [support.dell.com](http://support.dell.com).

 **NOTE:** For more information on the operating system and features, go to [support.dell.com/MyNewDell](http://support.dell.com/MyNewDell).

### Ubuntu

To set up Ubuntu for the first time, follow the instructions on the screen. See the Ubuntu documentation for more operating system specific information.

# Create System Recovery Media (Recommended)

 **NOTE:** It is recommended that you create a system recovery media as soon as you set up Microsoft Windows.

The system recovery media can be used to restore your computer to the operating state it was in when you purchased the computer, while preserving data files (without the need of the *Operating System* disc). You can use the system recovery media if changes to the hardware, software, drivers, or other system settings have left the computer in an undesirable operating state.

You will require the following to create the system recovery media:

- Dell DataSafe Local Backup
- USB key with a minimum capacity of 8 GB or DVD-R/DVD+R/Blu-ray Disc™

 **NOTE:** Dell DataSafe Local Backup does not support rewritable discs.

To create a system recovery media:

1. Ensure that the AC adapter is connected (see “Connect the AC Adapter” on page 7).
2. Insert the disc or USB key in the computer.
3. Click **Start**  → **All Programs** → **Dell DataSafe Local Backup**.
4. Click **Create Recovery Media**.
5. Follow the instructions on the screen.

 **NOTE:** For information on restoring your operating system using the system recovery media, see “System Recovery Media” on page 65.

### Connect to the Internet (Optional)

To connect to the Internet, you need an external modem or network connection and an Internet Service Provider (ISP).

If an external USB modem or WLAN adapter is not a part of your original order, you can purchase one at [www.dell.com](http://www.dell.com).

#### Setting Up a Wired Connection

- If you are using a dial-up connection, connect the telephone line to the optional external USB modem and to the telephone wall connector before you set up your Internet connection.
- If you are using a DSL or cable/satellite modem connection, contact your ISP or cellular telephone service for setup instructions.

To complete setting up your wired Internet connection, follow the instructions in “Setting Up Your Internet Connection” on page 21.

### Setting Up a Wireless Connection

 **NOTE:** To set up your wireless router, see the documentation that shipped with your router.

Before you can use your wireless Internet connection, you need to connect to your wireless router.

To setup your connection to a wireless router:

1. Save and close any open files, and exit any open programs.
2. Click **Start**  → **Control Panel**.
3. In the search box, type `network`, and then click **Network and Sharing Center** → **Connect to a network**.
4. Follow the instructions on the screen to complete the setup.

## Setting Up Your Internet Connection

ISPs and ISP offerings vary by country. Contact your ISP for offerings available in your country.

If you cannot connect to the Internet but have successfully connected in the past, the ISP might have a service outage. Contact your ISP to check the service status, or try connecting again later.

Have your ISP information ready. If you do not have an ISP, the **Connect to the Internet** wizard can help you get one.

To set up your Internet connection:

1. Save and close any open files, and exit any open programs.
2. Click **Start**  → **Control Panel**.
3. In the search box, type `network`, and then click **Network and Sharing Center** → **Set up a new connection or network** → **Connect to the Internet**.

The **Connect to the Internet** window appears.

-  **NOTE:** If you do not know which type of connection to select, click **Help me choose** or contact your ISP.
4. Follow the instructions on the screen and use the setup information provided by your ISP to complete the setup.

## Set Up Wireless Display (Optional)

 **NOTE:** Wireless display may not be supported on all computers.

Wireless display can only be set up on computers with:

Processor	Intel® Core™ i3 and above
Video controller	Intel HD Graphics
WLAN card	Intel Centrino® 6200 or Intel Centrino Advanced-N + WiMAX 6250
Operating system	Windows 7 Home Premium, Professional, or Ultimate
Driver	Download and install the latest driver for “Intel Wireless Display Connection Manager” available at <a href="http://support.dell.com">support.dell.com</a> .

To set up wireless display on your computer:

1. Ensure that your computer is turned on.
2. Ensure that wireless is enabled.
3. Connect the wireless display adapter to the TV.

 **NOTE:** The wireless display adapter does not ship with your computer and must be purchased separately.

4. Turn on the TV.
5. Select the appropriate video source for your TV, such as HDMI1, HDMI2, or S-Video.
6. Double-click the Intel® Wireless Display  icon on the desktop.  
The **Intel® Wireless Display** window appears.



7. Select **Scan for available displays**.
8. Select your wireless display adapter from the **Detected wireless displays** list.
9. Enter the security code that appears on your TV.

To enable wireless display:

1. Double-click the Intel® Wireless Display  icon on the desktop.  
The **Intel Wireless Display** window appears.
2. Select **Connect to Existing Adapter**.





 **NOTE:** For more information about wireless display, see the wireless display adapter documentation.

# Using Your Inspiron One

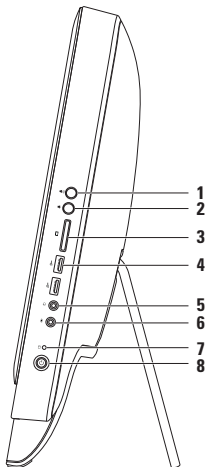
This section provides information about the features available on your Dell™ Inspiron One computer.

## Right View Features



-  **Volume increase button** — Press to increase the volume level.
-  **Volume decrease button** — Press to decrease the volume level.
-  **7-in-1 Media Card Reader** — Provides a fast and convenient way to view and share digital photos, music, videos, and documents stored on memory cards.
-  **USB 2.0 connectors (2)** — Connect to USB devices, such as a mouse, keyboard, printer, external drive, or MP3 player.

- 
- 5  **Audio-out/Headphone connector** — Connects to a pair of headphones.

**NOTE:** To connect to a powered speaker or sound system, use the line-out connector on the back of your computer.

---

- 6  **Audio-in/Microphone connector** — Connects to a microphone or inputs signal for use with audio programs.
- 

- 7  **Hard drive activity light** — Turns on when the computer reads or writes data. A blinking white light indicates hard drive activity.

 **CAUTION: To avoid loss of data, never turn off the computer, move the computer, or adjust the stand while the hard drive activity light is blinking.**

---

- 8  **Power button and light** — Turns the computer on or off when pressed. The light on the button indicates the following power states:

- Solid white — The computer is on.
  - Solid amber — The computer is in sleep/standby mode or there might be an issue with the system board or the power supply. Contact Dell (see “Contacting Dell” on page 75) for assistance.
  - Blinking amber — The computer has detected an error during the Power-on self-test (POST). Contact Dell (see “Contacting Dell” on page 75) for assistance.
  - Off — The computer is in hibernate mode, turned off, or is not receiving power.
-

## Left View Features

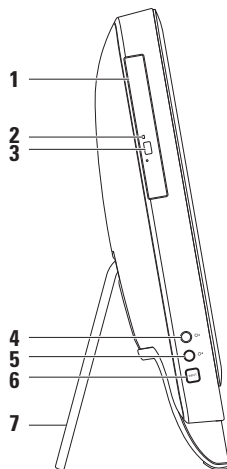

- 
- 1 Optical drive** — Plays or records CDs, DVDs, and Blu-ray Discs (optional). For more information, see “Using the Optical Drive” on page 28.

---

  - 2 Optical drive light** — Blinks when you press the optical drive eject button or when you insert a disc and it is being read.

---

  - 3 Optical drive eject button** — Opens the optical drive tray when pressed.

---

  - 4  Brightness increase button (optional)** — Press to increase the brightness level of the display.

---

  - 5  Brightness decrease button (optional)** — Press to decrease the brightness level of the display.

---

  - 6 Video input source button (optional)** — Press to choose the video source (composite, VGA, or HDMI).

---

  - 7 Computer stand** — Provides stability to the computer and also allows you to adjust the display to a comfortable viewing angle.
-

## Using the Optical Drive

 **CAUTION:** Do not press on the disc tray when you open or close it. Keep the tray closed when you are not using the drive.

 **CAUTION:** Do not move the computer while playing or recording a disc.

This optical drive plays or records CDs, DVDs, and Blu-ray Discs (optional). Ensure that the side with print or writing is facing towards you when placing discs on the optical drive tray.

To place a disc in the optical drive:

1. Press the eject button on the optical drive.
2. Place the disc with the printed side facing towards you in the center of the optical drive tray and snap the disc onto the spindle.
3. Gently push the optical drive tray back into the drive.

---

**1** optical drive tray

---

**2** spindle

---

**3** disc

---

**4** eject button

---

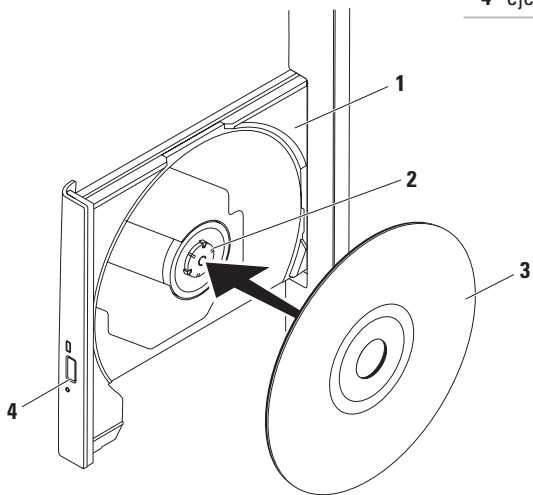

## Back View Features

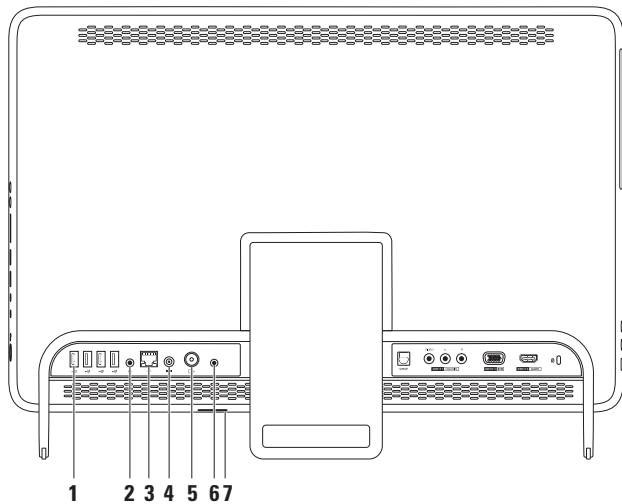



- 
-  **USB 2.0 connectors (4)** — Connect to USB devices, such as a mouse, keyboard, printer, external drive, or MP3 player.

---

  -  **Line-out connector** — Connects to a powered speaker or sound system.

---

  -  **Network connector** — Connects your computer to a network or a broadband device if you are using a wired network. The two lights next to the connector indicate the status and activity for a wired network connection.

---

  -  **AC adapter connector** — Connects to the AC adapter to power the computer.

---

  -  **Antenna-in connector (optional)** — Connects to an external antenna to view programs using the optional TV tuner card.



---

  -  **Infrared (IR) blaster connector (optional)** — Connects to an external IR device such as a set-top box.

---

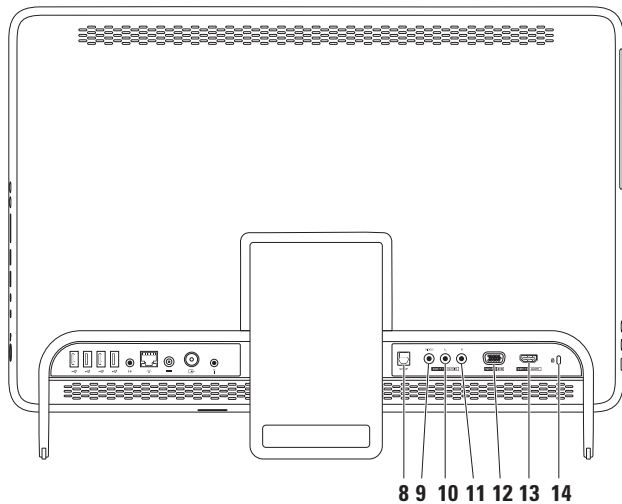
  - B-CAS card slot (optional)** — Allows you to install a B-CAS card required for decoding digital TV signals in Japan. For more information, see “Set Up the TV Tuner (Optional)” on page 11.
-



- 
- 8**  **S/PDIF connector (optional)** — Connects to amplifiers, speakers, or TVs for digital audio output through optical digital cables.
- 
- 9** **Composite video-in connector (optional)** — Connects to the composite video-output connector on your video device such as a DVD player, camcorder, or gaming device.
- 
- 10** **Composite left audio-in connector (optional)** — Connects to the composite left audio-output connector on your video device such as a DVD player, camcorder, or gaming device.
- 
- 11** **Composite right audio-in connector (optional)** — Connects to the composite right audio-output connector on your video device such as a DVD player, camcorder, or gaming device.
- 
- 12**  **VGA-in connector (optional)** — Connects to the VGA-output connector on your computer.
- 
- 13**  **HDMI-in connector (optional)** — Connects to the HDMI-output connector on your video device such as a DVD player, camcorder, or gaming device.
- 
- 14** **Security cable slot** — Attaches a commercially available security cable to the computer.  
**NOTE:** Before you buy a security cable, ensure that it fits into the security cable slot on your computer.
-

## Display Features

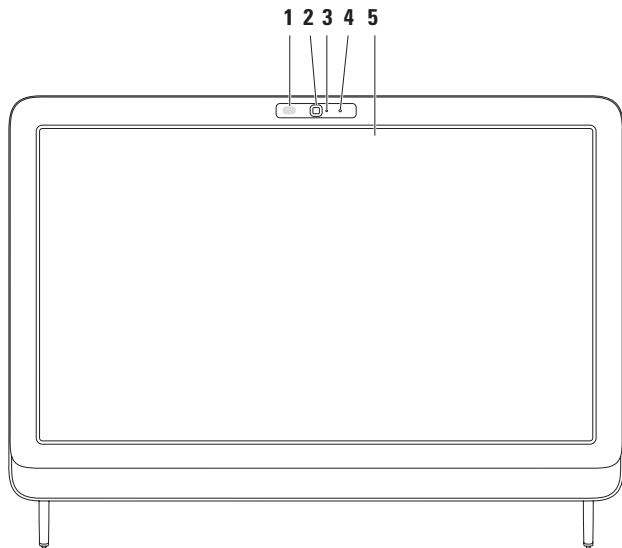

- 
- 1 IR receiver (optional)** — Detects signals from an IR device such as a Dell TV remote control.

---

  - 2 Camera** — Built-in camera for video capture, conferencing, and chat.

---

  - 3 Camera activity indicator** — Indicates if the camera is on or off. A solid white light indicates camera activity.

---

  - 4 Microphone** — Provides quality sound for video chatting and voice recording.

---

  - 5 Display** — Your display can vary based on selections you made when purchasing your computer. The display supports Zoom, Dwell, Flick, Scroll, and Rotate gestures. For more information, see “Touch Screen Gestures (Optional)” on page 37.
-

## Using the Touch Screen (Optional)

The touch screen feature on your Dell Inspiron One converts your computer into an interactive display.

### Dell Stage

The Dell Stage software installed on your computer provides access to your favorite media and multi-touch applications.

To launch Dell Stage, click **Start**  →

**All Programs** → **Dell Stage** → **Dell Stage**.

 **NOTE:** Some of the applications on Dell Stage can also be launched directly through the **All Programs** menu.

You can customize Dell Stage as follows:

- Rearrange an application shortcut — Select and hold the application shortcut until it blinks and then drag the application shortcut to a desired location on Dell Stage.

- Minimize — Drag the Dell Stage window to the bottom of the screen.
- Personalize — Select the settings icon and then choose the desired option.

The following are the applications available on Dell Stage:

 **NOTE:** Some of the applications may not be available based on the selections you made while purchasing your computer.

- MUSIC — Play music or browse through your music files by album, artist, or song title. You can also listen to radio stations from across the globe. The optional Napster application allows you to download songs when connected to the Internet.
- YOUPAINT — Draw and edit pictures.
- GAMES — Play touch-enabled games.
- DOCUMENTS — Provides quick access to the Documents folder on your computer.

- **PHOTO** — View, organize, or edit your pictures. You can create slideshows and collections of your pictures and upload them to **Facebook** or **Flickr** when connected to the Internet.
- **DELL WEB** — Provides a preview of up to four of your favorite web pages. Click or tap the web page preview to open it in the web browser.
- **VIDEO** — View videos. The optional CinemaNow application allows you to purchase and download or rent movies and TV shows when connected to the Internet.
- **SHORTCUTS** — Provides quick access to your frequently-used programs.
- **STICKYNOTES** — Create notes or reminders using the keyboard or touch screen. These notes will appear on the bulletin board the next time you access STICKYNOTES. You can also save notes on your desktop.
- **Web Tile** — Provides a preview of up to four of your favorite web pages. The tile allows you to add, edit, or delete a web page preview. Click or tap the web page preview to open it in the web browser. You can also create multiple Web Tiles through the Apps Gallery.

### Touch Screen Gestures (Optional)

 **NOTE:** Some of the gestures are application-specific and may not work outside the application.

#### Zoom

Allows you to increase or decrease the magnification of the screen content.

**Pinch** — Allows you to zoom-in or zoom-out by moving two fingers apart or bringing them closer together on the screen.



To zoom in:  
Move two fingers apart to enlarge the view of the active window.



To zoom out:  
Move two fingers close together to reduce the view of the active window.

#### Dwell

Allows you to access additional information by simulating a right-click.

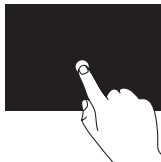

Press and hold a finger on the touch screen, to open context-sensitive menus.

#### Flick

Allows you to flip content forward or backward based on the direction of the flick.

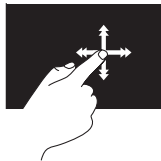

Move a finger quickly in the desired direction to flip through content in the active window like pages in a book. Flick also works vertically when navigating content such as images or songs in a playlist.



## Scroll

Allows you to scroll through content. The scroll features include:

**Pan** — Allows you to move the focus on the selected object when the entire object is not visible.

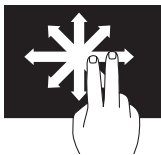

Move two fingers in the desired direction to pan scroll the selected object.

**Scroll Vertical** — Allows you to scroll up or scroll down on the active window.

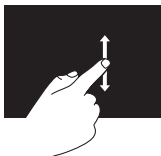

Move a finger up or down to activate vertical scrolling.

**Scroll Horizontal** — Allows you to scroll left or right on the active window.

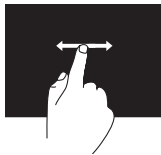

Move a finger to the left or right to activate horizontal scrolling.

## Rotate

Allows you to rotate the active content on the screen.

**Twist** — Allows you to rotate the active content using two fingers.



Keeping a finger or thumb in place, move the other finger in an arced direction right or left. You can also rotate the active content by moving both the fingers in a circular motion.

## Software Features

### FastAccess Facial Recognition

Your computer may have the FastAccess facial recognition feature. This feature helps keep your Dell computer secure by learning the unique appearance of your face and uses this to verify your identity to automatically supply login information when you would normally enter this information yourself (such as for logging on to a Windows account or secure websites).

For more information, click

**Start**  → **All Programs** → **FastAccess**.

### Productivity and Communication

You can use your computer to create presentations, brochures, greeting cards, fliers, and spreadsheets. You can also edit and view digital photographs and images. Check your purchase order for software installed on your computer.

After connecting to the Internet, you can access websites, setup an e-mail account, upload or download files, and so on.

## Entertainment and Multimedia

You can use your computer to watch videos, play games, create your own CDs/DVDs/Blu-ray Discs (optional), listen to music and internet radio stations. Your optical drive may support multiple disc media formats including CDs, DVDs, and Blu-ray Discs (optional).

You can download or copy pictures and video files from portable devices, such as digital cameras and cell phones. Optional software applications enable you to organize and create music and video files that can be recorded to disc, saved on portable products such as MP3 players and handheld entertainment devices, or played and viewed directly on connected TVs, projectors, and home theater equipment.

## Dell DataSafe Online Backup

 **NOTE:** Dell DataSafe Online may not be available in all regions.

 **NOTE:** A broadband connection is recommended for fast upload/download speeds.

Dell DataSafe Online is an automated backup and recovery service that helps protect your data and other important files from catastrophic incidents like theft, fire, or natural disasters. You can access the service on your computer using a password-protected account.

For more information, go to **DellDataSafe.com**.

To schedule backups:

1. Double-click the Dell DataSafe Online icon  in the notification area of your desktop.
2. Follow the instructions on the screen.

# Dell Dock

The Dell Dock is a group of icons that provides easy access to frequently-used applications, files, and folders. You can personalize the Dock by:

- Adding or removing icons
- Changing the color and location of the Dock
- Grouping related icons into categories
- Changing the behavior of the icons



## Add a Category

1. Right-click the Dock, click **Add**→ **Category**. The **Add/Edit Category** window appears.
2. Enter a title for the category in the **Title** field.
3. Select an icon for the category from the **Select an image:** box.
4. Click **Save**.

## Add an Icon

Drag and drop the icon to the Dock or a category.

## Remove a Category or Icon

1. Right-click the category or icon on the Dock and click **Delete shortcut** or **Delete category**.
2. Follow the instructions on the screen.

## Personalize the Dock

1. Right-click the Dock and click **Advanced Setting...**
2. Choose the desired option to personalize the Dock.

# Solving Problems

This section provides troubleshooting information for your computer. If you cannot solve your problem using the following guidelines, see “Using Support Tools” on page 52 or “Contacting Dell” on page 75.

 **WARNING:** Only trained service personnel should remove the computer cover. See the *Service Manual* at [support.dell.com/manuals](http://support.dell.com/manuals) for advanced service instructions.

## Touch Screen Problems

**Some or all multi-touch features are not working —**

- Certain touch and multi-touch features may be disabled. To enable them, double-click the **Flicks** icon in the notification area of your desktop. In the **Pen and Touch** window, select the **Touch** tab and ensure that **Use your finger as an input device** and **Enable multi-touch gestures and inking** options are selected.
- The multi-touch feature may not be supported by the application.
- The touch screen is calibrated at the factory, and does not require re-calibration. If you choose to calibrate the touch screen, see “Touch Screen Calibration” on page 44.

 **NOTE:** Improper calibration may lead to inaccurate touch sensitivity.

## Solving Problems

### If the touch screen starts losing its sensitivity —

- Calibrate the touch screen (see “Touch Screen Calibration” on page 44).
- The touch screen may have foreign particles (such as sticky notes) that are blocking the touch sensors. To remove these particles:
  - a. Turn off the computer.
  - b. Disconnect the power cable from the wall outlet.
  - c. Use a clean, lint-free cloth (can spray water on a cloth if needed, but not on the screen) and wipe the surface and sides of the touch screen to remove any dirt or fingerprints.

## Touch Screen Calibration

 **NOTE:** It is recommended that you calibrate the touch screen if you have touch screen problems or if you change the screen resolution.

To calibrate the touch screen, click

**Start**  → **Control panel** → **Tablet PC Settings** → **Display** → **Calibrate...**

## Beep Codes

Your computer might emit a series of beeps during start-up if there are errors or problems. This series of beeps, called a beep code, identifies a problem. If this occurs, write down the beep code and contact Dell (see “Contacting Dell” on page 75) for assistance.

 **NOTE:** To replace parts, see the *Service Manual* at [support.dell.com/manuals](http://support.dell.com/manuals).

Beep Code	Possible Problem
One	Possible system board failure — BIOS ROM checksum failure
Two	No RAM detected <b>NOTE:</b> If you installed or replaced the memory module, ensure that the memory module is seated properly.
Three	Possible system board failure — Chipset error
Four	RAM read/write failure
Five	Real Time Clock failure
Six	Video card or chip failure
Seven	Processor failure

## Network Problems

### Wireless Connections

**If the wireless network connection is lost** — The wireless router is offline or wireless has been disabled on the computer.

- Check your wireless router to ensure it is powered on and connected to your data source (cable modem or network hub).
- Ensure that wireless is enabled on your computer.
- Re-establish your connection to the wireless router (see “Setting Up a Wireless Connection” on page 20).
- Interference may be blocking or interrupting your wireless connection. Try moving the computer closer to your wireless router.

### Wired Connections

**If the wired network connection is lost** — The network cable is loose or damaged.

- Check the network cable to ensure it is plugged in and not damaged.
- The link integrity light on the integrated network connector lets you verify that your connection is working and provides information on the status:
  - Green — A good connection exists between a 10/100-Mbps network and the computer.
  - Amber — A good connection exists between a 1000-Mbps network and the computer.
  - Off — The computer is not detecting a physical connection to the network.



**NOTE:** The link integrity light on the network connector is only for a wired network connection. The link integrity light does not provide status for wireless connections.



## Power Problems

**If the power light is off** — The computer is either turned off or is not receiving power.

- Press the power button. The computer resumes normal operation if it is off or in hibernate mode.
- Reseat the AC adapter cable into the power connector on the computer and the electrical outlet.
- If the computer is plugged into a power strip, ensure that the power strip is plugged into an electrical outlet and that the power strip is turned on.
- Temporarily bypass power protection devices, power strips, and power extension cables to verify that the computer turns on properly.
- Ensure that the electrical outlet is working by testing it with another device, such as a lamp.

- Check the AC adapter cable connections. If the AC adapter has a light, ensure that the light on the AC adapter is on.
- If the problem persists, contact Dell (see “Contacting Dell” on page 75).

**If the power light is solid white and the computer is not responding** — The display may not be responding.

- Press the power button until the computer turns off and then turn it back on.
- If the problem persists, contact Dell (see “Contacting Dell” on page 75).

## Solving Problems

**If the power light is breathing amber** — The computer is in sleep/standby mode or the display may not be responding.

- Press a key on the keyboard, move the connected mouse, or press the power button to resume normal operation.
- If the display is not responding, press the power button until the computer turns off and then turn it back on.
- If the problem persists, contact Dell (see “Contacting Dell” on page 75).

**If the power light is solid amber** — The computer has detected an error during POST. The light will blink along with the three BIOS beep codes to indicate the error. For assistance, contact Dell (see “Contacting Dell” on page 75).

**If you encounter interference that hinders reception on your computer** — An unwanted signal is creating interference by interrupting or blocking other signals. Some possible causes of interference are:

- Power, keyboard, and mouse extension cables.
- Too many devices connected to a power strip.
- Multiple power strips connected to the same electrical outlet.

## Memory Problems

**If you receive an insufficient memory message** —

- Save and close any open files and exit any open programs you are not using to see if that resolves the problem.
- If the problem persists, contact Dell (see “Contacting Dell” on page 75).

**If you experience other memory problems** —

- Run Dell Diagnostics (see “Dell Diagnostics” on page 56).
- If the problem persists, contact Dell (see “Contacting Dell” on page 75).

## Lockups and Software Problems

**If the computer does not start up** — Ensure that the AC adapter cable is firmly connected to the computer and to the electrical outlet.

**If a program stops responding** —

End the program:

1. Press <Ctrl><Shift><Esc> simultaneously.
2. Click **Applications**.
3. Click the program that is no longer responding.
4. Click **End Task**.

## Solving Problems

**If a program crashes repeatedly** — Check the software documentation. If necessary, uninstall and then reinstall the program.

 **NOTE:** Software usually includes installation instructions in its documentation or on the CD.

**If the computer stops responding or a solid blue screen appears** —

 **CAUTION:** You might lose data if you are unable to perform an operating system shutdown.

If you are unable to get a response by pressing a key on your keyboard or moving your mouse, press the power button for at least 8 to 10 seconds until the computer turns off and then restart your computer.

**If a program is designed for an earlier Microsoft® Windows® operating system** —

Run the Program Compatibility Wizard. The Program Compatibility Wizard configures a program so that it runs in an environment similar to an earlier version of Microsoft Windows operating system.

To run the Program Compatibility Wizard:

1. Click **Start**  → **Control Panel** → **Programs** → **Run programs made for previous versions of Windows**.
2. In the welcome screen, click **Next**.
3. Follow the instructions on the screen.

### If you have other software problems —

- Back up your files immediately.
  - Use a virus-scanning program to check the hard drive or CDs.
  - Save and close any open files or programs and shut down your computer through the **Start**  menu.
  - Check the software documentation or contact the software manufacturer for troubleshooting information:
    - Ensure that the program is compatible with the operating system installed on your computer.
    - Ensure that your computer meets the minimum hardware requirements needed to run the software. See the software documentation for information.
- Ensure that the program is installed and configured properly.
  - Verify that the device drivers do not conflict with the program.
  - If necessary, uninstall and then reinstall the program.
  - Write down any error message that is displayed to help in troubleshooting when contacting Dell.

# Using Support Tools

## Dell Support Center

The **Dell Support Center** helps you find the service, support, and system-specific information you need.

To launch the application, click the  icon in the notification area of your desktop.

The **Dell Support Center** home page displays your computer's model number, service tag, express service code, and service contact information.

The home page also provides links to access:

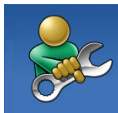

**Self Help** (Troubleshooting, Security, System Performance, Network/Internet, Backup/Recovery, and Windows operating system)



**Alerts** (technical support alerts relevant to your computer)



**Assistance from Dell** (Technical Support with DellConnect™, Customer Service, Training and Tutorials, How-To Help with Solution Station™, and Online Scan with PC CheckUp)



**About Your System** (System Documentation, Warranty Information, System Information, Upgrades, and Accessories)

For more information about **Dell Support Center** and available support tools, go to **DellSupportCenter.com**.

## My Dell Downloads

 **NOTE:** My Dell Downloads may not be available in all regions.

Some of the software pre-installed on your new Dell computer do not include a backup CD or DVD. This software is available on the My Dell Downloads website. From this website you can download available software for reinstallation or create your own backup media.

To register and use My Dell Downloads:

1. Go to **DownloadStore.dell.com/media**.
2. Follow the instructions on the screen to register and download the software.
3. Reinstall the software or create a backup media for future use.

## System Messages

If your computer has an issue or error, it may display a system message that will help you identify the cause and action needed to resolve the issue.

 **NOTE:** If the message you received is not listed in the following examples, see the documentation for either the operating system or the program that was running when the message appeared. Alternatively you could contact Dell (see “Contacting Dell” on page 75) for assistance.

**Alert! Previous attempts at booting this system have failed at checkpoint [nnnn]. For help in resolving this problem, please note this checkpoint and contact Dell Technical Support** — The computer failed to complete the boot routine three consecutive times for the same error. Contact Dell (see “Contacting Dell” on page 75) for assistance.

## Using Support Tools

**CPU fan failure** — CPU fan has failed. Replace the CPU fan (see the *Service Manual* at [support.dell.com/manuals](http://support.dell.com/manuals)).

**System fan failure** — System fan has failed. Contact Dell (see “Contacting Dell” on page 75) for assistance.

**Hard-disk drive failure** — Possible hard-disk drive failure during POST. Contact Dell (see “Contacting Dell” on page 75) for assistance.

**Hard-disk drive read failure** — Possible hard-disk drive failure during HDD boot test. Contact Dell (see “Contacting Dell” on page 75) for assistance.

**Keyboard failure** — Keyboard failure or loose cable. Replace the keyboard.

**No boot device available** — No bootable partition on hard drive, the hard drive cable is loose, or no bootable device exists.

- If the hard drive is your boot device, ensure that the cables are connected and that the drive is installed properly and partitioned as a boot device.
- Enter system setup and ensure that the boot sequence information is correct. See the *Service Manual* at [support.dell.com/manuals](http://support.dell.com/manuals).

**No timer tick interrupt** — A chip on the system board might be malfunctioning or system board failure. Contact Dell (see “Contacting Dell” on page 75) for assistance.



**USB over current error** — Disconnect the USB device. Your USB device needs more power for it to function properly. Use an external power source to connect the USB device, or if your device has two USB cables, connect both of them.

**CAUTION - Hard Drive SELF MONITORING SYSTEM has reported that a parameter has exceeded its normal operating range. Dell recommends that you back up your data regularly. A parameter out of range may or may not indicate a potential hard drive problem** — S.M.A.R.T error, possible hard drive failure. Contact Dell (see “Contacting Dell” on page 75) for assistance.

## Hardware Troubleshooter

If a device is either not detected during the operating system setup or is detected but incorrectly configured, you can use the **Hardware Troubleshooter** to resolve the incompatibility.

To start the Hardware Troubleshooter:

1. Click **Start**  → **Help and Support**.
2. Type `hardware troubleshooter` in the search field and press <Enter> to start the search.
3. In the search results, select the option that best describes the problem and follow the remaining troubleshooting steps.

# Dell Diagnostics

If you experience a problem with your computer, perform the checks in “Lockups and Software Problems” on page 49 and run Dell Diagnostics before you contact Dell for technical assistance. It is recommended that you print these procedures before you begin.

 **NOTE:** Dell Diagnostics works only on Dell computers.

 **NOTE:** The *Drivers and Utilities* disc may not ship with your computer.

See the *Specifications* on page 78 to review your computer’s configuration information, and ensure that the device that you want to test appears in the system setup program and is active.

Start Dell Diagnostics from your hard drive or from the *Drivers and Utilities* disc.

## Starting Dell Diagnostics From Your Hard Drive

Dell Diagnostics is located on a hidden diagnostic utility partition on your hard drive.

 **NOTE:** If your computer cannot display a screen image, contact Dell (see “Contacting Dell” on page 75) for assistance.

1. Ensure that the computer is connected to an electrical outlet that is known to be working properly.
2. Turn on (or restart) your computer.
3. When the DELL™ logo appears, press <F12> immediately. Select **Diagnostics** from the boot menu and press <Enter>. This may invoke the Pre-Boot System Assessment (PSA) on your computer.

 **NOTE:** If you wait too long and the operating system logo appears, continue to wait until you see the Microsoft® Windows® desktop; then, shut down your computer and try again.

 **NOTE:** If you see a message stating that no diagnostic utility partition has been found, run Dell Diagnostics from the *Drivers and Utilities* disc.

*If PSA is invoked:*

- a. The PSA will start running the tests.
- b. If the PSA completes successfully, the following message appears: `"No problems have been found with this system so far. Do you want to run the remaining memory tests? This will take about 30 minutes or more. Do you want to continue? (Recommended) ."`

- c. If you are experiencing memory issues, press <y>, otherwise press <n>. The following message appears: `"Booting Dell Diagnostic Utility Partition. Press any key to continue."`
- d. Press any key to go to the **Choose An Option** window.

*If PSA is not invoked:*



Press any key to start Dell Diagnostics from the diagnostics utility partition on your hard drive and to go to the **Choose An Option** window.

4. Select the test you want to run.
5. If a problem is encountered during a test, a message appears with an error code and a description of the problem. Write down the error code and problem description and contact Dell (see "Contacting Dell" on page 75) for assistance.

## Using Support Tools

-  **NOTE:** The Service Tag for your computer is displayed at the top of each test screen. The Service Tag helps you identify your computer when you contact Dell.
- 6. When the tests are complete, close the test screen to return to the **Choose An Option** window.
- 7. To exit Dell Diagnostics and restart the computer, click **Exit**.

## Starting Dell Diagnostics From the Drivers and Utilities Disc

-  **NOTE:** The *Drivers and Utilities* disc may not ship with your computer.
- 1. Insert the *Drivers and Utilities* disc.
- 2. Shut down and restart the computer. When the DELL™ logo appears, press <F12> immediately.
-  **NOTE:** If you wait too long and the operating system logo appears, continue to wait until you see the Microsoft Windows desktop; then, shut down your computer and try again.
-  **NOTE:** The next steps change the boot sequence for one time only. On the next start-up, the computer boots according to the devices specified in the system setup program.

3. When the boot device list appears, highlight **CD/DVD/CD-RW** and press <Enter>.
  4. Select the **Boot from CD-ROM** option from the menu that appears and press <Enter>.
  5. Type 1 to start the CD menu and press <Enter> to proceed.
  6. Select **Run the 32 Bit Dell Diagnostics** from the numbered list. If multiple versions are listed, select the version appropriate for your computer.
  7. Select the test you want to run.
  8. If a problem is encountered during a test, a message appears with an error code and a description of the problem. Write down the error code and problem description and contact Dell (see “Contacting Dell” on page 75) for assistance.
-  **NOTE:** The Service Tag for your computer is displayed at the top of each test screen. The Service Tag helps you identify your computer when you contact Dell.
9. When the tests are complete, close the test screen to return to the **Choose An Option** window.
  10. To exit the Dell Diagnostics and restart the computer, click **Exit**.
  11. Remove the *Drivers and Utilities* disc.

# Restoring Your Operating System

You can restore the operating system on your computer using any of the following options:

 **CAUTION:** Using Dell Factory Image Restore or the *Operating System* disc to restore your operating system permanently deletes all data files on your computer. If possible, backup your data files before using these options.

Option	Use
System Restore	as the first solution
Dell DataSafe Local Backup	when System Restore does not resolve your problem
System recovery media	when operating system failure prevents the use of System Restore and DataSafe Local Backup when installing the operating system and Dell factory-installed software on a newly installed hard drive
Dell Factory Image Restore	to restore your computer to the operating state it was in when you received your computer
<i>Operating System</i> disc	to reinstall only the operating system on your computer



 **NOTE:** The *Operating System* disc may not ship with your computer.

## System Restore

The Microsoft® Windows® operating systems provide a System Restore option which allows you to return your computer to an earlier operating state (without affecting data files) if changes to the hardware, software, or other system settings have left the computer in an undesirable operating state. Any changes that System Restore makes to your computer are completely reversible.

 **CAUTION: Make regular backups of your data files. System Restore does not monitor your data files or recover them.**

## Starting System Restore

1. Click **Start** .
2. In the search box, type `System Restore` and press <Enter>.  
 **NOTE:** The **User Account Control** window may appear. If you are an administrator on the computer, click **Continue**; otherwise, contact your administrator to continue the desired action.
3. Click **Next** and follow the instructions on the screen.

In the event that System Restore did not resolve the issue, you may undo the last system restore.

### Undoing the Last System Restore

 **NOTE:** Before you undo the last system restore, save and close all open files and exit any open programs. Do not alter, open, or delete any files or programs until the system restoration is complete.

1. Click **Start** .
2. In the search box, type `System Restore` and press <Enter>.
3. Click **Undo my last restoration**, click **Next** and follow the instructions on the screen.

### Dell DataSafe Local Backup

 **CAUTION:** Using Dell DataSafe Local Backup to restore your operating system permanently removes any programs or drivers installed after you received your computer. Create backup media of applications you need to install on your computer before using Dell DataSafe Local Backup. Use Dell DataSafe Local Backup only if System Restore did not resolve your operating system problem.

 **CAUTION:** Although Dell Datasafe Local Backup is designed to preserve the data files on your computer, it is recommended that you backup your data files before using Dell DataSafe Local Backup.

 **NOTE:** Dell DataSafe Local Backup may not be available in all regions.



 **NOTE:** If Dell DataSafe Local Backup is not available on your computer, use Dell Factory Image Restore (see “Dell Factory Image Restore” on page 66) to restore your operating system.

You can use Dell DataSafe Local Backup to restore your hard drive to the operating state it was in when you purchased your computer, while preserving the data files.

Dell DataSafe Local Backup allows you to:

- Backup and restore your computer to an earlier operating state
- Create system recovery media

### Dell DataSafe Local Backup Basic

To restore your operating system and the Dell factory-installed software while preserving the data files:

1. Turn off your computer.
2. Disconnect all the devices (USB drive, printer, and so on) connected to the computer and remove any newly added internal hardware.

 **NOTE:** Do not disconnect the AC adapter.

3. Turn on your computer.
4. When the DELL™ logo appears, press <F8> several times to access the **Advanced Boot Options** window.

 **NOTE:** If you wait too long and the operating system logo appears, continue to wait until you see the Microsoft Windows desktop; then, shut down your computer and try again.

5. Select **Repair Your Computer**.
6. Select **Dell DataSafe Restore and Emergency Backup** from the **System Recovery Options** menu and follow the instructions on the screen.

 **NOTE:** The restoration process may take an hour or more depending on the size of the data to be restored.

 **NOTE:** For more information, see knowledge base article 353560 at [support.dell.com](http://support.dell.com).

## Upgrading to Dell DataSafe Local Backup Professional

 **NOTE:** Dell DataSafe Local Backup Professional may be installed on your computer, if you ordered it at the time of purchase.

Dell DataSafe Local Backup Professional provides additional features that allow you to:

- Backup and restore your computer based on file types
- Backup files to a local storage device
- Schedule automated backups

To upgrade to Dell DataSafe Local Backup Professional:

1. Double-click the Dell DataSafe Local Backup icon  in the notification area of your desktop.
2. Click **UPGRADE NOW!**
3. Follow the instructions on the screen.

## System Recovery Media

 **CAUTION:** Although the system recovery media is designed to preserve the data files on your computer, it is recommended that you backup your data files before using the system recovery media.

You can use the system recovery media, created using Dell DataSafe Local Backup, to return your hard drive to the operating state it was in when you purchased the computer while preserving the data files on your computer.

Use the system recovery media in case of:

- Operating system failure that prevents the use of the recovery options installed on your computer.
- Hard drive failure that prevents data from being recovered.

To restore operating system and Dell factory-installed software using the system recovery media:

1. Insert the system recovery disc or USB key and restart the computer.
2. When the DELL™ logo appears, press <F12> immediately.

 **NOTE:** If you wait too long and the operating system logo appears, continue to wait until you see the Microsoft Windows desktop; then, shut down your computer and try again.

3. Select the appropriate boot device from the list and press <Enter>.
4. Follow the instructions on the screen.

### Dell Factory Image Restore

 **CAUTION:** Using Dell Factory Image Restore to restore your operating system permanently removes any programs or drivers installed after you received your computer. If possible, back up the data before using this option. Use Dell Factory Image Restore only if System Restore did not resolve your operating system problem.

 **NOTE:** Dell Factory Image Restore may not be available in certain countries or on certain computers.

 **NOTE:** If Dell Factory Image Restore is not available on your computer, use Dell DataSafe Local Backup (see “Dell DataSafe Local Backup” on page 62) to restore your operating system.

You can use Dell Factory Image Restore only as the last method to restore your operating system. This option restores your hard drive to the operating state it was in when you purchased the computer. Any programs or files added since you received your computer—including data files—are permanently deleted from the hard drive. Data files include documents, spreadsheets, e-mail messages, digital photos, music files, and so on. If possible, back up all data before using Dell Factory Image Restore.

## Starting Dell Factory Image Restore

1. Turn on the computer.
2. When the DELL™ logo appears, press <F8> several times to access the **Advanced Boot Options** window.  
 **NOTE:** If you wait too long and the operating system logo appears, continue to wait until you see the Microsoft Windows desktop; then, shut down your computer and try again.
3. Select **Repair Your Computer**.  
The **System Recovery Options** window appears.
4. Select a keyboard layout and click **Next**.
5. To access the recovery options, log on as a local user. To access the command prompt, type `administrator` in the **User name** field, then click **OK**.
6. Click **Dell Factory Image Restore**. The **Dell Factory Image Restore** welcome screen appears.

 **NOTE:** Depending upon your configuration, you may need to select **Dell Factory Tools**, then **Dell Factory Image Restore**.

7. Click **Next**.  
The **Confirm Data Deletion** screen appears.  
 **NOTE:** If you do not want to proceed with the Dell Factory Image Restore, click **Cancel**.
8. Select the check box to confirm that you want to continue to reformat the hard drive and restore the system software to the factory condition, then click **Next**.  
The restore process begins and may take five or more minutes to complete. A message appears when the operating system and factory-installed applications have been restored to factory condition.
9. Click **Finish** to restart the computer.

# Getting Help

If you experience a problem with your computer, you can complete the following steps to diagnose and troubleshoot the problem:

1. See “Solving Problems” on page 43 for information and procedures that pertain to the problem your computer is experiencing.
2. See “Dell Diagnostics” on page 56 for procedures on how to run Dell Diagnostics.
3. Fill out the “Diagnostic Checklist” on page 74.
4. Use Dell’s extensive suite of online services available at Dell Support ([support.dell.com](http://support.dell.com)) for help with installation and troubleshooting procedures. See “Online Services” on page 70 for a more extensive list of Dell Support online.
5. If the preceding steps have not resolved the problem, see “Before You Call” on page 73.

 **NOTE:** Call Dell Support from a telephone near or at the computer so that the support staff can assist you with any necessary procedures.

 **NOTE:** Dell’s Express Service Code system may not be available in all countries.

When prompted by Dell’s automated telephone system, enter your Express Service Code to route the call directly to the proper support personnel. If you do not have an Express Service Code, open the **Dell Accessories** folder, double-click the **Express Service Code** icon, and follow the directions.

 **NOTE:** Some of the services are not always available in all locations outside the continental U.S. Call your local Dell representative for information on availability.

## Technical Support and Customer Service

Dell's support service is available to answer your questions about Dell hardware. Our support staff use computer-based diagnostics to provide fast, accurate answers.

To contact Dell's support service, see "Before You Call" on page 73 and then see the contact information for your region or go to **[support.dell.com](http://support.dell.com)**.

## DellConnect

DellConnect™ is a simple online access tool that allows a Dell service and support associate to access your computer through a broadband connection, diagnose your problem, and repair it all under your supervision. For more information, go to **[www.dell.com/DellConnect](http://www.dell.com/DellConnect)**.

### Online Services

You can learn about Dell products and services on the following websites:

- **www.dell.com**
- **www.dell.com/ap** (Asian/Pacific countries only)
- **www.dell.com/jp** (Japan only)
- **www.euro.dell.com** (Europe only)
- **www.dell.com/la** (Latin American and Caribbean countries)
- **www.dell.ca** (Canada only)

You can access Dell Support through the following websites and e-mail addresses:

#### Dell Support Websites

- **support.dell.com**
- **support.jp.dell.com** (Japan only)
- **support.euro.dell.com** (Europe only)
- **supportapj.dell.com** (Asia Pacific only)

#### Dell Support E-mail Addresses

- **mobile\_support@us.dell.com**
- **support@us.dell.com**
- **la-techsupport@dell.com** (Latin America and Caribbean countries only)
- **apsupport@dell.com** (Asian/Pacific countries only)

#### Dell Marketing and Sales E-mail Addresses

- **apmarketing@dell.com** (Asian/Pacific countries only)
- **sales\_canada@dell.com** (Canada only)

#### Anonymous File Transfer Protocol (FTP)

- **ftp.dell.com**  
Log in as user: `anonymous`, and use your e-mail address as your password.



## Automated Order-Status Service

To check on the status of any Dell products that you have ordered, you can go to **support.dell.com**, or you can call the automated order-status service. A recording prompts you for the information needed to locate and report on your order.

If you have a problem with your order, such as missing parts, wrong parts, or incorrect billing, contact Dell for customer assistance. Have your invoice or packing slip handy when you call.

For the telephone number to call for your region, see “Contacting Dell” on page 75.

## Product Information

If you need information about additional products available from Dell, or if you would like to place an order, go to **www.dell.com**. For the telephone number to call for your region or to speak to a sales specialist, see “Contacting Dell” on page 75.

## Returning Items for Repair Under Warranty or for Credit

Prepare all items being returned, whether for repair or credit, as follows:

 **NOTE:** Before you return the product to Dell, ensure that you back up any data on the hard drive and on any other storage device in the product. Remove any and all confidential, proprietary and personal information, as well as removable media, such as CDs/DVDs/Blu-ray Discs and media cards. Dell is not responsible for any of your confidential, proprietary or personal information; lost or corrupted data; or damaged or lost removable media that may be included with your return.

1. Call Dell to obtain a Return Material Authorization Number, and write it clearly and prominently on the outside of the box. For the telephone number to call for your region, see “Contacting Dell” on page 75.

2. Include a copy of the invoice and a letter describing the reason for the return.
3. Include a copy of the Diagnostics Checklist (see “Diagnostic Checklist” on page 74), indicating the tests that you have run and any error messages reported by Dell Diagnostics (see “Dell Diagnostics” on page 56).
4. Include any accessories that belong with the item(s) being returned (AC adapter cable, software, guides, and so on) if the return is for credit.
5. Pack the equipment to be returned in the original (or equivalent) packing materials.

 **NOTE:** You are responsible for paying shipping expenses. You are also responsible for insuring any product returned, and you assume the risk of loss during shipment to Dell. Collect On Delivery (C.O.D.) packages are not accepted.

 **NOTE:** Returns that are missing any of the preceding requirements will be refused at Dell’s receiving dock and returned to you.

## Before You Call

 **NOTE:** Have your Express Service Code ready when you call. The code helps Dell's automated-support telephone system direct your call more efficiently. You may also be asked for your Service Tag (located at the back of your computer).

### Locating Your Service Tag and Express Service Code

The Service Tag and Express Service Code for your computer can be found on a label at the back of your computer.

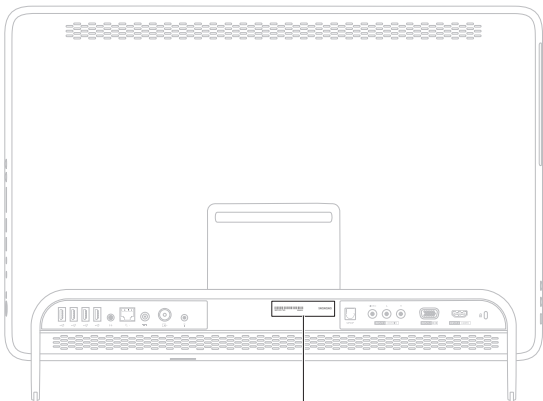

---

**1** Service Tag and  
Express Service Code

---

## Getting Help

Remember to fill out the following Diagnostics Checklist. If possible, turn on your computer before you call Dell for assistance and call from a telephone at or near the computer. You may be asked to type some commands at the keyboard, relay detailed information during operations, or try other troubleshooting steps possible only at the computer itself. Ensure that the computer documentation is available.

### **Diagnostic Checklist**

- Name:
- Date:
- Address:
- Phone number:
- Service Tag (bar code on the back of the computer):
- Express Service Code:
- Return Material Authorization Number (if provided by Dell support technician):
- Operating system and version:
- Devices:
- Expansion cards:
- Are you connected to a network? Yes/No
- Network, version, and network adapter:
- Programs and versions:

See your operating system documentation to determine the contents of the computer's start-up files. If the computer is connected to a printer, print each file. Otherwise, record the contents of each file before calling Dell.

- Error message, beep code, or diagnostic code:
- Description of problem and troubleshooting procedures you performed:

## Contacting Dell

For customers in the United States, call 800-WWW-DELL (800-999-3355).

 **NOTE:** If you do not have an active Internet connection, you can find contact information on your purchase invoice, packing slip, bill, or Dell product catalog.

Dell provides several online and telephone-based support and service options. Availability varies by country and product, and some services may not be available in your area.

To contact Dell for sales, technical support, or customer service issues:

1. Go to **[www.dell.com/ContactDell](http://www.dell.com/ContactDell)**.
2. Select your country or region.
3. Select the appropriate service or support link based on your requirement.
4. Choose the method of contacting Dell that is convenient for you

# Finding More Information and Resources

**If you need to:****See:**

---

reinstall your operating system

“System Recovery Media” on page 65

---

find your system model number

the back of your computer

---

run a diagnostic program for your computer

“Dell Diagnostics” on page 56

---

reinstall system software

“My Dell Downloads” on page 53

---

find more information about the Microsoft Windows operating system and features

**support.dell.com**

---

upgrade your computer with new or additional memory, or a new hard drive

the *Service Manual* at  
**support.dell.com/manuals**

---

reinstall or replace a worn or defective part



**NOTE:** In some countries, opening and replacing parts of your computer may void your warranty. Check your warranty and return policies before working inside your computer.

---

### If you need to:

find safety best practices information for your computer

review Warranty information, Terms and Conditions (U.S. only), Safety instructions, Regulatory information, Ergonomics information, and End User License Agreement

find your Service Tag/Express Service Code — You must use the service tag to identify your computer on **support.dell.com** or to contact technical support

find drivers and downloads; readme files  
access technical support and product help  
check on your order status for new purchases  
find solutions and answers to common questions

locate information for last-minute updates about technical changes to your computer or advanced technical-reference material for technicians or experienced users

### See:



the safety and regulatory documents that shipped with your computer and also see the Regulatory Compliance Homepage at **www.dell.com/regulatory\_compliance**

the back of your computer  
the **Dell Support Center**. To launch the **Dell Support Center**, click the  icon in the notification area of your desktop

**support.dell.com**

# Specifications

This section provides information that you may need when setting up, updating drivers for, and upgrading your computer.

 **NOTE:** Offerings may vary by region. For more information regarding the configuration of your computer, see the **About Your System** section in the Dell Support Center. To launch the Dell Support Center, click the  icon in the notification area of your desktop.

## Computer Model

---

Dell™ Inspiron™ One 2305

Dell Inspiron One 2310

## Processor

---

Inspiron 2305      AMD Athlon™ II X2  
                           AMD Athlon II X3  
                           AMD Athlon II X4

Inspiron 2310      Intel® Core™ i3  
                           Intel Core i5  
                           Intel Core i7

## System Chipset

---

Inspiron 2305      AMD®  
                           M880G + SB820M

Inspiron 2310      Mobile Intel 5 Series  
                           Express Chipset HM57



## Drives

---

Internally accessible	one 3.5-inch SATA hard drive
Externally accessible)	one tray-load SATA DVD+/-RW/Blu-ray Disc™ combo (optional)/Blu-ray Disc rewritable (optional) and 7-in-1 Media Card Reader

## Memory

---

Memory module connectors	two user-accessible connectors
Inspiron 2305	UDIMM
Inspiron 2310	SODIMM
Memory module capacities	1 GB, 2 GB, and 4 GB
Memory type	1333 MHz DDR3 non-ECC memory only

## Memory

---

Minimum memory	2 GB
Maximum memory	4 GB
Possible memory configurations	2 GB, 3 GB, 4 GB, 6 GB, and 8 GB

 **NOTE:** For instructions on upgrading the memory, see the *Service Manual* at [support.dell.com/manuals](http://support.dell.com/manuals).

## Audio

---

Audio controller	Realtek ALC272 High Definition audio
Speakers	2 x 4 watt speakers
Microphone	one digital microphone
Volume controls	software program menus and media controls

## Specifications

### Video

---

#### UMA

##### Inspiron 2305

Video controller	ATI Mobility Radeon™ HD 4270
------------------	---------------------------------

##### Inspiron 2310

Video controller	Intel HD Graphics
------------------	-------------------

#### Discrete

Video controller	ATI Mobility Radeon HD 5470
------------------	--------------------------------

### Internal Connectors

---

MXM3                    one type-A slot

PCIe                    two mini slots

### External Connectors

---

#### Audio:

Side panel            one stereo headphones/  
speakers connector  
and one microphone-in  
connector

Back panel            one line-out connector  
S/PDIF (optional)    one optical output  
connector (7.1 channel)

Network adapter    one RJ45 connector

USB                    two side-panel and  
four back-panel USB  
2.0-compliant  
connectors

VGA-in (optional)    one 15-pin connector

HDMI-in (optional)    one 19-pin connector

Composite  
(optional)            one video-in and two  
audio-in connectors

## External Connectors

---

Antenna-in connector (optional)	one MCX connector
Infrared (IR) blaster connector (optional)	one connector
Media Card Reader	one 7-in-1 slot

## Camera

---

Pixel	2.0 megapixel
Video resolution	640 x 480 at 30 fps (maximum)

## Battery

---

Type	3 V CR-2032 lithium coin-cell
------	-------------------------------

## Media Card Reader

---

Cards supported	Secure Digital (SD) memory card MultiMedia Card (MMC) Memory Stick Memory Stick PRO xD-Picture Card Hi Speed-SD Secure Digital High Capacity (SDHC) card
-----------------	--

## Communications

---

Network adapter	10/100/1000 Ethernet LAN on system board
Wireless	Wi-Fi and Bluetooth® wireless technology

## Specifications

### Display

---

Type	23-inch Full HD WLED
Maximum resolution	1920 x 1080

### AC Adapter

---

 **NOTE:** Use only AC adapters specified for use with your computer. See the safety information that shipped with your computer.

Input voltage	100–240 VAC
Input current	1.5 A/2.3 A/2.5 A
Input frequency	50–60 Hz
Output power	90 W or 130 W
Output current:	
90 W	4.62 A
130 W	6.70 A

### AC Adapter

---

Rated output voltage	19.5 +/- 1 VDC
----------------------	----------------

Temperature range:

Operating	0° to 40°C (32° to 104°F)
Storage	–40° to 70°C (–40° to 158°F)

### Physical

---

Height	420 mm (16.5 inches)
Width	570 mm (22.4 inches)
Depth	90 mm (3.5 inches)

Weight:

Touch screen	configurable to less than 8.95 kg (19.73 lb)
Non-touch screen	configurable to less than 8.15 kg (17.97 lb)

## Computer Environment

---

Temperature range:

Operating      10°C to 35°C  
(50°F to 95°F)

Storage          –40°C to 65°C  
(–40°F to 149°F)

Relative humidity (maximum)      10% to 90%  
(noncondensing)

Maximum shock (for operating — measured with Dell Diagnostics running on the hard drive and a 2-ms half-sine pulse; for non-operating — measured with the hard drive in head-parked position and a 2-ms half-sine pulse):

Operating      40 G for 2 ms with a change in velocity of 20 in/s (51 cm/s)

Non-Operating      40 G for 22 ms with a change in velocity of 240 in/s (609 cm/s)

## Computer Environment

---

Maximum vibration (using a random vibration spectrum that simulates user environment):

Operating      0.26 GRMS

Non-Operating      2.20 GRMS

Altitude (maximum):

Operating      –15.2 to 3048 m  
(–50 to 10,000 ft)

Storage          –15.2 to 10,668 m  
(–50 to 35,000 ft)

Airborne contaminant level      G2 or lower as defined by ISA-S71.04-1985

# Appendix

## Macrovision Product Notice

This product incorporates copyright protection technology that is protected by method claims of certain U.S. patents and other intellectual property rights owned by Macrovision Corporation and other rights owners. Use of this copyright protection technology must be authorized by Macrovision Corporation, and is intended for home and other limited viewing uses only unless otherwise authorized by Macrovision Corporation. Reverse engineering or disassembly is prohibited.

## Information for NOM, or Official Mexican Standard (Only for Mexico)

The following information is provided in the device(s) described in this document in accordance with the requirements of the Official Mexican Standard (NOM):

### Importer:

Dell México S.A. de C.V.

Paseo de la Reforma 2620 - 11°

Col. Lomas Altas

11950 México, D.F.

Regulatory model number	Voltage	Frequency	Electricity consumption	Output voltage	Output intensity
W01C	100–240 VAC	50–60 Hz	1.5 A/2.3A/2.5A	19.5 VDC	4.62/6.70 A

For details, read the safety information that shipped with your computer.

For additional safety best practices information, see the Regulatory Compliance Homepage at [www.dell.com/regulatory\\_compliance](http://www.dell.com/regulatory_compliance).

# Index

## A

airflow, allowing **5**

## C

calling Dell **73**

computer capabilities **40**

computer, setting up **5**

connect(ing)

to the Internet **19**

Contacting Dell online **75**

customer service **69**

## D

DellConnect **69**

Dell Diagnostics **56**

Dell Factory Image Restore **66**

Dell Stage **36**

Dell Support Center **52**

Diagnostic Checklist **74**

drivers and downloads **77**

DVDs, playing and creating **41**

## E

e-mail addresses

for technical support **70**

## F

finding more information **76**

FTP login, anonymous **70**

## G

gestures

touch screen **38**



**H**

hard drive activity light **25**

hardware problems

    diagnosing **55**

Hardware Troubleshooter **55**

help

    getting assistance and support **68**

**I**

Internet connection **19**

ISP

    Internet Service Provider **19**

**M**

Media Card Reader **24**

memory problems

    solving **49**

microphone connector **25**

**N**

network connection

    fixing **46**

**P**

power button and light **25**

power problems, solving **47**

problems, solving **43**

products

    information and purchasing **71**

**R**

resources, finding more **76**

restoring factory image **66**

**S**

setup, before you begin **5**

shipping products

    for return or repair **72**

## Index

- software features **40**
- software problems **49**
- solving problems **43**
- specifications **78**
- support e-mail addresses **70**
- support sites
  - worldwide **70**
- System Messages **53**
- system reinstall options **60**

## T

- TV tuner
  - set up **11**

## V

- ventilation, ensuring **5**

## W

- warranty returns **72**
- Windows
  - Program Compatibility Wizard **50**
  - reinstall **60**
  - setup **17**
- wired network
  - network cable, connecting **8**
- wireless
  - display **21**
- wireless network connection **46**





Printed in the U.S.A.

[www.dell.com](http://www.dell.com) | [support.dell.com](http://support.dell.com)



OJMVONA00