

LIFEBOOK A531
LIFEBOOK AH531



Congratulations, you have decided to buy an innovative Fujitsu product.

The latest information about our products, useful tips, updates etc. is available from our website: ["http://ts.fujitsu.com"](http://ts.fujitsu.com)

For automatic driver updates, go to: ["http://support.ts.fujitsu.com/com/support/index.html"](http://support.ts.fujitsu.com/com/support/index.html)

Should you have any technical questions, please contact:

- our Hotline/Service Desk (see Service Desk list or visit: ["http://ts.fujitsu.com/support/serviceesk.html"](http://ts.fujitsu.com/support/serviceesk.html))
- Your sales partner
- Your sales office

We hope you really enjoy using your new Fujitsu system.

**Copyright**

Fujitsu Technology Solutions 02/2011

Published by

Fujitsu Technology Solutions GmbH
Mies-van-der-Rohe-Straße 8 (Mies-van-der-Rohe Street No. 8)
80807 Munich, Germany

Contact

<http://ts.fujitsu.com/support>

All rights reserved, including intellectual property rights. Subject to technical alterations. Delivery subject to availability. No warranty is offered or liability accepted in regard of the completeness, correctness, or current applicability of any data or illustrations. Brand names may be protected trademarks of the respective manufacturer and/or protected by copyright. Use of these by third parties for their own purposes may constitute an infringement of the holders' rights. Further information can be found at "http://ts.fujitsu.com/terms_of_use.html"

Order No. Fujitsu Technology Solutions GmbH: A26391-K330-Z320-1-7619, edition 1

LIFEBOOK A531

LIFEBOOK AH531

Operating Manual

Innovative technology	7
Ports and controls	9
Important notes	12
First-time setup of your device	16
Working with the notebook	19
Security functions	44
Connecting external devices	48
Removing and installing components during servicing	52
Settings in BIOS Setup Utility	60
Troubleshooting and tips	62
Technical data	70
Manufacturer's notes	72
Index	79

Microsoft, MS, Windows XP and Windows 7 are registered trademarks of the Microsoft Corporation.

Adobe Reader is a trademark of Adobe Systems Incorporated.

MultiMediaCard is a registered trademark of Infineon Technologies AG

Sony and Memory Stick are registered trademarks of Sony Electronics, Inc.

All other trademarks referenced are trademarks or registered trademarks of their respective owners, whose protected rights are acknowledged.

Copyright © Fujitsu Technology Solutions GmbH 2011

All rights reserved, including rights of translation, reproduction by printing, copying or similar methods, in part or in whole.

In the event of violations, perpetrators will be liable to prosecution for damages.

All rights reserved, including rights created by patent grant or registration of a utility model or design.

Subject to availability and technical modifications.

Contents

Innovative technology	7
Further information	7
Notational conventions	8
Ports and controls	9
Important notes	12
Safety notes	12
Additional safety notes for devices with radio components	13
Energy saving	13
Energy saving under Windows	13
Travelling with your notebook	14
Before you travel	14
Notebook: transporting	14
Cleaning the notebook	15
First-time setup of your device	16
Unpacking and checking the device	16
Selecting a location	17
Mains adapter connecting	17
Switching on the device for the first time	18
Working with the notebook	19
Status indicators	19
Switching on the notebook	21
Notebook: switching off	21
Keyboard	22
Virtual numeric keypad	24
Separate numeric keypad (device-dependent)	25
Key combinations	25
Country and keyboard settings	27
Touchpad and touchpad buttons	27
Moving the pointer	27
Selecting an item	28
Executing commands	28
Dragging items	28
Switching the Touchpad on and off	28
LCD screen	29
Webcam	30
Rechargeable battery	30
Charging, caring for and maintaining the battery	31
Removing and installing the battery	31
Optical drive	33
Handling data carriers	33
CD/DVD indicator	34
Inserting or removing a data carrier	34
Manual removal (emergency removal)	35
Using the power-management features	36
Memory cards	37
Supported formats	37
Inserting the memory card	37
Removing the memory card	38

ExpressCards	39
Inserting the card	39
Removing the card	40
Loudspeakers and microphones	40
SIM card (devices with UMTS module)	41
Inserting the SIM card	41
Removing the SIM card	41
Wireless LAN / Bluetooth / UMTS	42
Switching the wireless components on and off	42
Setting up WLAN access	42
Access via UMTS	42
Ethernet and LAN	43
Security functions	44
Use Kensington Lock	44
Configuring password protection in BIOS Setup Utility	45
Protecting BIOS Setup Utility (supervisor and user password)	45
Password protection for booting of the operating system	46
Password protection for the hard disk	47
Connecting external devices	48
Connecting an external monitor	49
HDMI port	49
Connecting USB devices	50
How to remove USB devices correctly	50
Connecting external audio devices	51
Microphone port/Line In	51
Headphone port	51
Removing and installing components during servicing	52
Notes on installing and removing boards and components	52
Preparing to remove components	53
Installing and removing memory expansion	53
Removing the cover	54
Removing memory modules	54
Installing a memory module	55
Securing the cover	55
Removing and installing the hard disk	56
Removing a cover	56
Removing a hard disk	57
Installing a hard disk	58
Attaching the cover	59
Finishing component removal	59
Settings in BIOS Setup Utility	60
Starting the BIOS Setup Utility	60
Operating BIOS Setup Utility	60
Exiting BIOS Setup Utility	61
Exit Saving Changes - save changes and exit BIOS Setup Utility	61
Exit Discarding Changes – Discard changes and exit BIOS Setup Utility	61
Load Setup Defaults – Copy Standard Entries	61
Discard Changes – Discard changes without exiting the BIOS Setup Utility	61
Save Changes - save changes without exiting the BIOS Setup Utility	61
Save Changes and Power Off	61

Troubleshooting and tips	62
Help if problems occur	63
Restoring the hard disk contents under Windows	63
The notebook's date or time is incorrect	64
When certain characters are entered on the keyboard, only numerals are written	64
The notebook's LCD screen remains blank	64
The LCD screen is difficult to read	64
The external monitor remains blank	65
The external monitor is blank or the image is unstable	65
The notebook cannot be started	66
The notebook stops working	66
The printer does not print	67
The radio connection to a network does not work	67
Acoustic warnings	67
Error messages on the screen	68
Technical data	70
LIFEBOOK	70
Rechargeable battery	70
Mains adapter 80 W	70
Power adapter, 65 W	71
Manufacturer's notes	72
Energy Star	72
Disposal and recycling	72
Declarations of Conformity	72
CE marking	73
Regulatory notices	73
Regulatory information for notebooks without radio device	73
DOC (Industry CANADA) notices	75
FCC regulatory information for notebooks with radio device	77
Index	79

Innovative technology

... and ergonomic design make your device a reliable and convenient companion.

The device boots very quickly, is ready for immediate use and offers a particularly long operating time because of its high capacity battery.

With the user-friendly "BIOS Setup Utility" you can control your notebook's hardware and better protect your system against unauthorised access by using the powerful password properties.



Information on the connections and user components of your notebook can be found in ["Ports and controls", Page 9.](#)

Further information









The Windows drivers for your device can be found on our Internet site. The factory installation of your device does not support any other operating system. Fujitsu Technology Solutions accepts no liability whatsoever if any other operating system is used.

Software oriented components of these instructions refer to Microsoft products, if they come within the scope of the delivery.

If you install other software products, pay attention to the operating instructions of the manufacturer.

Notational conventions

	Pay particular attention to text marked with this symbol. Failure to observe these warnings could pose a risk to health, damage the device or lead to loss of data. The warranty will be invalidated if the device becomes defective through failure to observe these warnings.
	Indicates important information for the proper use of the device.
	Indicates an activity that must be performed
	Indicates a result
This font	indicates data entered using the keyboard in a program dialogue or at the command line, e.g. your password (Name123) or a command used to start a program (start.exe)
This font	indicates information that is displayed on the screen by a program, e.g.: Installation is complete.
<i>This font</i>	indicates <ul style="list-style-type: none"> • terms and texts used in a software interface, e.g.: Click on <i>Save</i> • names of programs or files, e.g. <i>Windows</i> or <i>setup.exe</i>.
"This font"	indicates <ul style="list-style-type: none"> • cross-references to another section, e.g. "Safety information" • cross-references to an external source, e.g. a web address: For more information, go to "http://ts.fujitsu.com" • Names of CDs, DVDs and titles or designations for other materials, e.g.: "CD/DVD Drivers & Utilities" or "Safety/Regulations" manual
	indicates a key on the keyboard, e.g: 
This font	indicates terms and texts that are emphasised or highlighted, e.g.: Do not switch off the device

Ports and controls

This chapter presents the individual hardware components of your device. It gives an overview of the indicators and connections of the device. Please familiarise yourself with these components before you start to work with the device.

Front

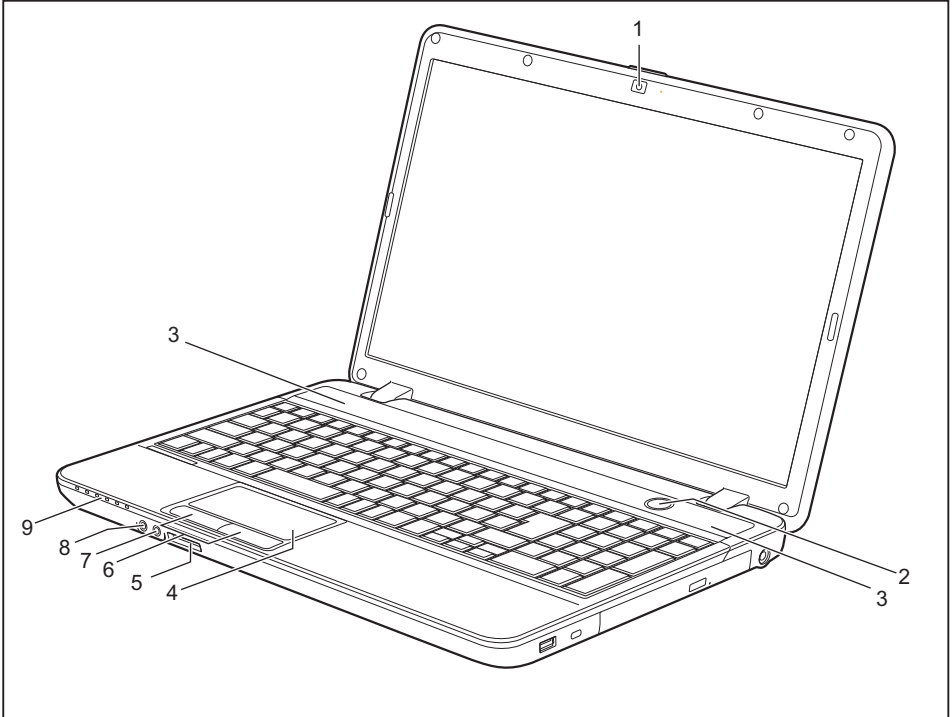

- 1 = WebCam
- 2 = ON/OFF switch
- 3 = Loudspeakers
- 4 = Touchpad
- 5 = Memory card slot

- 6 = Touchpad buttons
- 7 = Microphone jack
- 8 = Headphone port
- 9 = Status indicators

Left panel

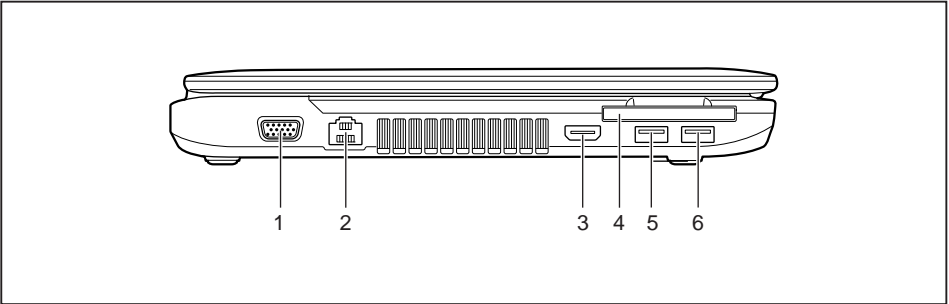

1 = VGA monitor port

2 = LAN port

3 = HDMI port

4 = ExpressCard slot

5 = USB port

6 = USB port with charging function

Right-hand side

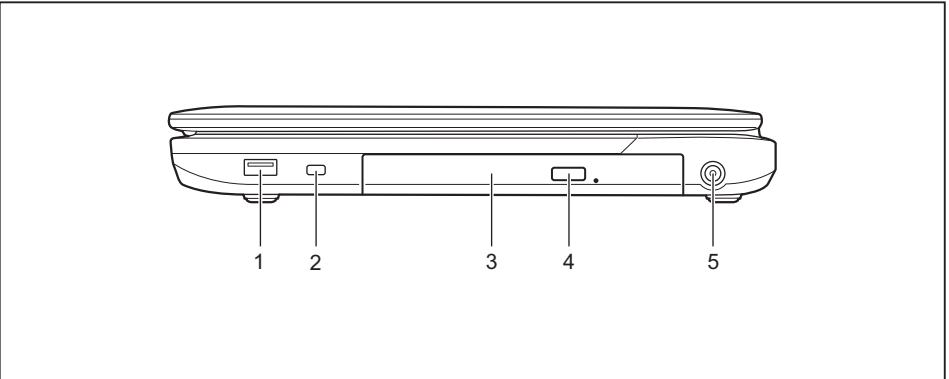

1 = USB port

2 = Kensington Lock

3 = Optical drive

4 = Eject button for optical drive

5 = DC input connector (DC IN)

Underside

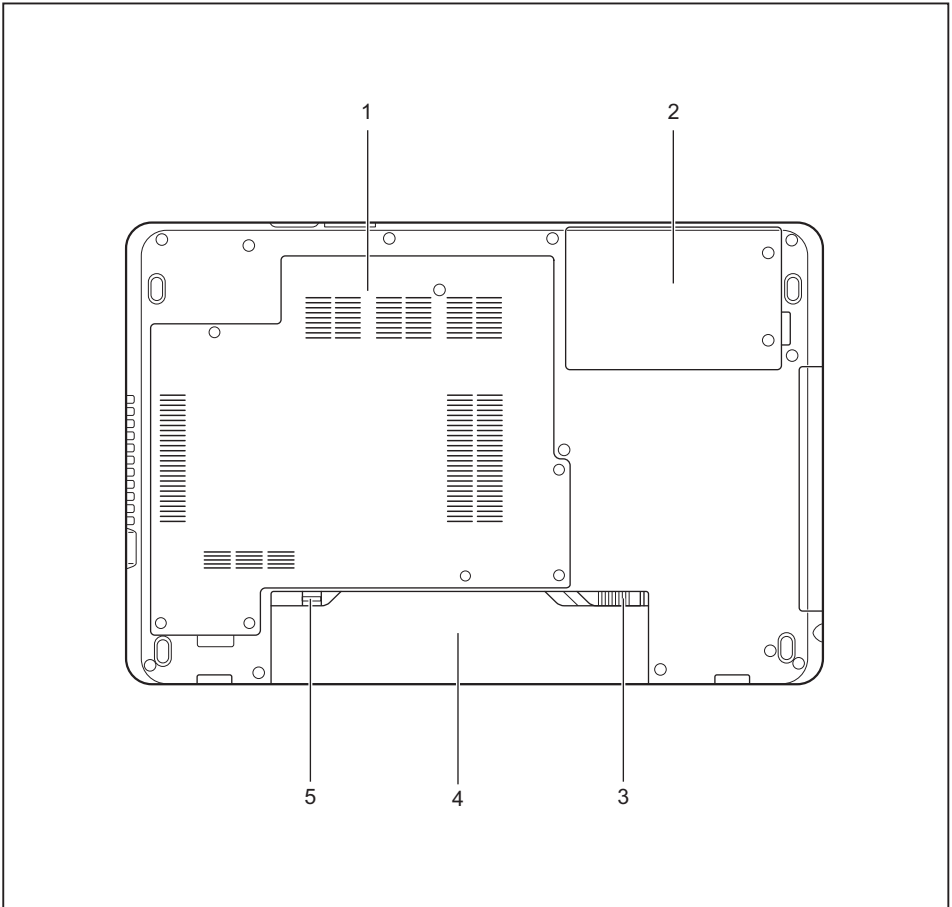

- 1 = Memory service compartment
- 2 = Hard disk service compartment
- 3 = Battery release

- 4 = Battery compartment with SIM card slot under battery (optional)
- 5 = Battery release

Important notes



This chapter contains essential safety information which must be followed when working with your notebook. Other notes also provide useful information which will help you with your notebook.

Safety notes



Please follow the safety notes provided in the "Safety/Regulations" manual as well as the safety notes given below.

Please pay special attention to the sections in the manual marked with the symbol on the left.

When connecting and disconnecting cables, observe the relevant notes in this operating manual.

Read the information on the ambient conditions in the ["Technical data", Page 70](#) and ["First-time setup of your device", Page 16](#) before preparing your notebook for use and switching it on for the first time.

When cleaning the device, please observe the relevant notes in the section ["Cleaning the notebook", Page 15](#).

Pay attention to the additional safety notes for devices with radio components provided in the "Safety/Regulations" manual.

Please refer to the notes in the chapter ["Removing and installing components during servicing", Page 52](#).

This notebook complies with the relevant safety regulations for data processing equipment. If you have questions about using your notebook in a particular area, please contact your sales outlet or our Hotline/Service Desk.

Additional safety notes for devices with radio components

If a radio component (Wireless LAN, Bluetooth, UMTS) is integrated in your notebook, you must be sure to observe the following safety notes when using your notebook:

- Switch off the radio components when you are in an aircraft or driving in a car.
- Switch off the radio components when you are in a hospital, an operating room or near a medical electronics system. The transmitted radio waves can impair the operation of medical devices.
- Switch off the radio components when you let the device get near flammable gases or into hazardous environments (e.g. petrol station, paintshops), as the transmitted radio waves can cause an explosion or a fire.



For information on how to switch radio components on and off, see chapter ["Switching the wireless components on and off", Page 42](#).

Energy saving

Switch the notebook off when it is not in use. Switch off external, connected devices if you are not using them. If you use the energy saving functions, the notebook uses less energy. You will then be able to work for longer before having to recharge the battery.



Energy efficiency is increased and the environmental impact is reduced. You save money while protecting the environment.

Energy saving under Windows

- ▶ Make use of the power management features (see ["Using the power-management features", Page 36](#)).

Travelling with your notebook

Please observe the points listed below when travelling with your notebook.

Before you travel

- ▶ Back up important data stored on your hard disk.
- ▶ Switch off the radio component for data security reasons. With data traffic via a wireless connection, it is also possible for unauthorised third parties to receive data.



Information on activating data encryption is provided in the documentation for your radio component.

- ▶ If you wish to use your notebook during a flight, first check with the flight attendants if it is OK to do so.

When travelling in other countries

- ▶ If you are travelling abroad, check that the mains adapter can be operated with the local mains voltage. If this is not the case, obtain the appropriate mains adapter for your notebook. Do not use any other voltage converter!
- ▶ Check whether the local mains voltage and the power cable are compatible. If this is not the case, buy a power cable that matches the local conditions.
- ▶ Enquire with the corresponding government office of the country you will be travelling in as to whether you may operate the radio component integrated in your notebook there (see also ["CE marking", Page 73](#)).

Notebook: transporting



Protect the notebook from severe shocks and extreme temperatures (e.g. direct sunlight in a car).

- ▶ If your device has an optical drive, remove all data media (e.g. CD, DVD) from the drives.
- ▶ Switch the notebook off.
- ▶ Unplug the mains adapter and all external devices from the power socket.
- ▶ Disconnect the mains adapter cable and the data cables for all external devices.
- ▶ Close the LCD screen.
- ▶ To protect against damaging jolts and bumps, use a notebook carrying case to transport your notebook.

Cleaning the notebook



Do not clean any interior parts yourself; leave this job to a service technician.

Only use cleaning products designed for computers. Normal household cleaners and polishes can damage the markings on the keyboard and the device, the paintwork or the notebook itself.

Ensure that no liquid enters the notebook.

The LCD screen very sensitive to scratches. Only clean the display surface with a very soft, slightly damp cloth.

- ▶ Switch the notebook off.
- ▶ In order to prevent accidentally switching the device on, remove the power cable from the mains adaptor and remove the battery (see ["Removing and installing the battery", Page 31](#)).
- ↳ The surface can be cleaned with a dry cloth. If particularly dirty, use a cloth which has been moistened in mild domestic detergent and then carefully wrung out.
To clean the keyboard and the touchpad, if available, you can use disinfectant wipes.
Ensure that no liquid enters the device.

First-time setup of your device



Please read the chapter ["Important notes", Page 12.](#)

If your device is equipped with a Windows operating system, the necessary hardware drivers and supplied software are already pre-installed.

Before you switch on the device for the first time, connect it to the mains voltage using the mains adapter, see ["Mains adapter connecting", Page 17.](#) The mains adapter must be connected during the entire installation process.

A system test is performed when your device is first switched on. Various messages can appear. The display may remain dark for a short time or may flicker.

Please follow the instructions on the screen.

NEVER switch off your device during the first-time setup process.

On delivery, the battery can be found in the battery compartment or in the accessories kit. The battery must be charged if you want to operate your device using the battery.

When used on the move, the built-in battery provides the device with the necessary power. You can increase the operating time by using the available energy-saving functions.

For instructions on how to connect external devices (e.g. mouse, printer) to your device, please refer to the operating manual for your device.

Unpacking and checking the device



Should you discover any damage that occurred during transportation, notify your local sales outlet immediately!

- ▶ Unpack all the individual parts.
- ▶ Check your device for any visible damage which may have occurred during transportation.



You may need the packaging in the future, if you need to transport your device.

Selecting a location



Select a suitable location for the device before setting it up. Follow the instructions below when doing so:

- Never place the device or the mains adapter on a heat-sensitive surface. The surface could be damaged as a result.
- Never place the device on a soft surface (e.g. carpeting, upholstered furniture, bed). This can block the air vents and cause overheating and damage.
- The underside of the device heats up during normal operation. Prolonged contact with the skin may become unpleasant or even result in burns.
- Place the device on a stable, flat, non-slippery surface. Please note that the rubber feet of the device may mark certain types of delicate surfaces.
- Keep other objects at least 100 mm away from the device and its mains adapter to ensure adequate ventilation.
- Never cover the ventilation slots of the device.
- Do not expose the device to extreme environmental conditions. Protect the device from dust, humidity, and heat.

Mains adapter connecting



Observe the safety notes in the enclosed "Safety/Regulations" manual.

The supplied power cable conforms to the requirements of the country in which you purchased your device. Make sure that the power cable is approved for use in the country in which you intend to use it.

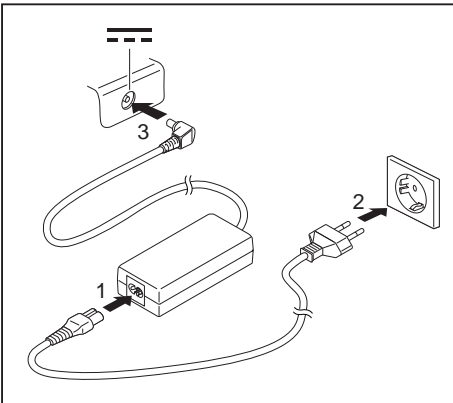

- ▶ Connect the power cable (1) to the mains adapter.
- ▶ Plug the mains cable (2) into a mains outlet.
- ▶ Connect the mains adapter cable (3) to the DC jack (DC IN) of the device.

Switching on the device for the first time



When you switch on the device for the first time, the supplied software is installed and configured. Because this procedure must not be interrupted, you should set aside enough time for it to be fully completed and connect the device to the mains using the mains adapter.

During the installation process, DO NOT restart the device unless you are requested to do so!

To make it easier to use your device for the first time, the operating system is pre-installed on the hard disk.

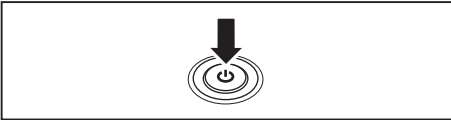

► Switch on your device.

► During installation, follow the instructions on screen.



If a Windows operating system is installed on your device, you will find more information on the system and drivers, help programmes, updates, manuals etc. on the device or on the Internet at ["http://ts.fujitsu.com/support"](http://ts.fujitsu.com/support).

Working with the notebook

This chapter describes the basics for operating your notebook. Please read the chapter entitled ["Connecting external devices", Page 48](#) for instructions on how to connect devices such as a mouse and a printer to the notebook.







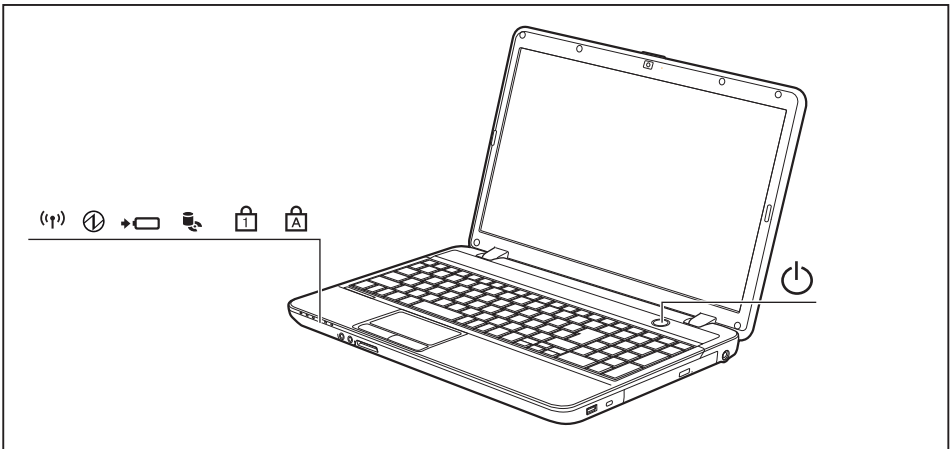

Please refer to the notes in ["Important notes", Page 12](#).

Status indicators

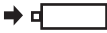
The status indicators provide information about the status of the power supply, the drives and the keyboard functions.



Status indicators	Description
	<p>Wireless components indicator</p> <ul style="list-style-type: none"> • The indicator is lit: The wireless components are switched on. • The indicator is not lit: The wireless components are switched off.
	<p>Power-on indicator/Standby</p> <ul style="list-style-type: none"> • The indicator is lit: The notebook is switched on. • The indicator flashes: The notebook is in standby mode. • The indicator is not lit: The notebook is switched off.
	<p>Battery charging indicator/power connector</p> <p>The state of charge of the battery is shown by the battery indicator.</p> <p>With mains adapter connected:</p> <ul style="list-style-type: none"> • The indicator lights up blue: The battery is fully charged. • The indicator lights up orange: The battery is charging. • Indicator flashes purple: a fault has occurred. The battery cannot be recharged. • The indicator is off: The system is in battery mode and the mains adapter is not connected or the battery is not installed.
	<p>Drive indicator</p> <p>The indicator is lit: One of the drives (e.g. hard disk, CD/DVD) is being accessed.</p>
	<p>Num Lock indicator</p> <p>The indicator is lit: The Num key has been pressed. The virtual numerical keypad is activated. You can output the characters indicated on the upper right of the keys.</p>
	<p>Caps Lock indicator</p> <p>The indicator is lit: The Caps Lock key has been pressed. All the characters you type will appear in upper case. In the case of overlay keys, the character printed on the upper left of the key will appear when that key is pressed.</p>

Switching on the notebook

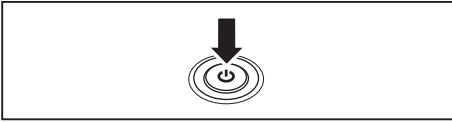

↳ The power-on indicator is lit.

- ▶ Open the LCD screen.
- ▶ Press the ON/OFF switch for about one second to switch the notebook on.

Notebook: switching off



Back up your data and close all applications before you switch off your device. Otherwise data might be lost.

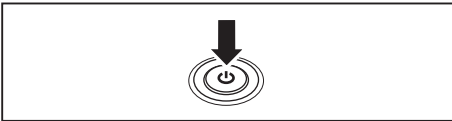

- ▶ Shut down the operating system properly (e. g. from the Windows *Start* menu, by clicking on *Start – Shut Down – OK*).
- ▶ If the notebook is not switched off automatically, press the ON/OFF switch for approx. five seconds.
- ▶ Close the LCD screen.

Keyboard



The keyboard of your notebook is subject to continuous wear through normal use. The key markings are especially prone to wear. The key markings are liable to wear away over the life of the notebook.

The keyboard has been designed to provide all the functions of an enhanced keyboard. Some enhanced keyboard functions are mapped with key combinations.





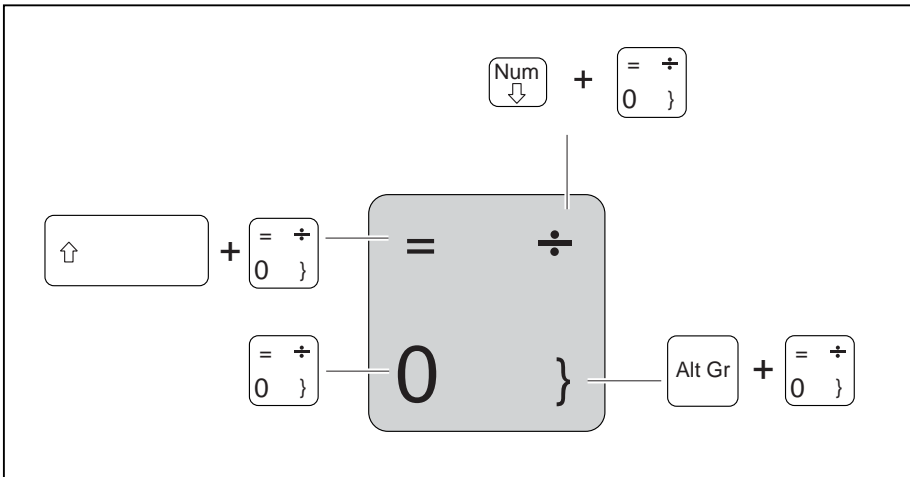

The following description of keys refers to Windows. Additional functions supported by the keys are described in the relevant manuals supplied with your application programs.

The figure below shows how to access the different characters on keys with overlaid functions. The example applies when the Caps Lock key has not been activated.

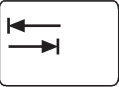

The illustrations shown below may differ from your actual device.

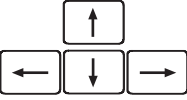

Key	Description
	Backspace key The Backspace key deletes the character to the left of the cursor.
	Tab key The Tab key moves the cursor to the next tab stop.
	Enter key (return) The Enter key terminates a command line. The command you have entered is executed when you press this key.
	Caps Lock key The Caps Lock key activates the Caps Lock mode, and the corresponding icon is displayed in the Windows information area. In Caps Lock mode, all of the characters you type appear in upper case. In the case of overlay keys, the character printed on the upper left of the key will appear when that key is pressed. To cancel the Caps Lock function, simply press the Caps Lock key again.
	Shift key The Shift key causes uppercase characters to appear. In the case of overlay keys, the character printed on the upper left of the key appears when that key is pressed.
	Fn button The [Fn] key enables the special functions indicated on overlay keys (see "Key combinations", Page 25).
	Cursor keys The cursor keys move the cursor in the direction of the arrow, i.e. up, down, left, or right.
	Start key The Start key opens the Windows Start menu.
	Menu key The Menu key invokes the menu for the marked item.

Virtual numeric keypad

To provide the convenience of a numeric keypad, your keyboard is equipped with a virtual numeric keypad. The special keys of the virtual numeric keypad are recognisable by the numbers and symbols printed in the upper right corner of each key. If you have switched on the virtual numeric keypad, you can output the characters shown on the upper right of the keys.



The keyboard layout shown below may differ from your actual device.

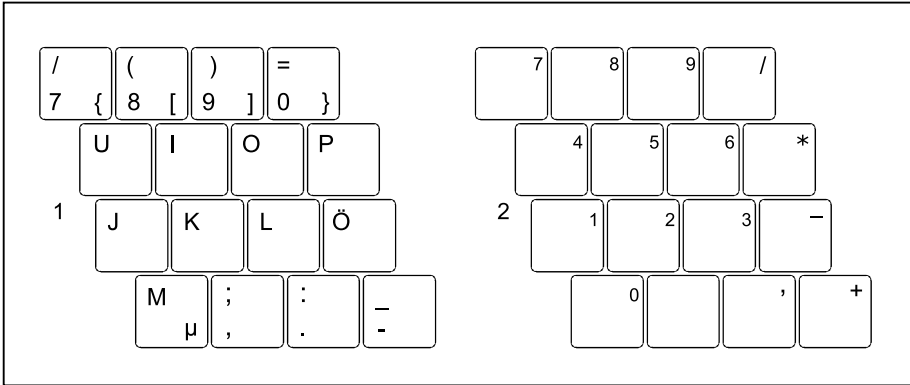

1 = Valid characters when the Num key is not activated

2 = Valid characters when the Num is activated

Further information about the status indicators can be found in chapter ["Status indicators", Page 19](#).

Separate numeric keypad (device-dependent)

The keyboard of your notebook has a separate number block on the far right, depending on the device version.

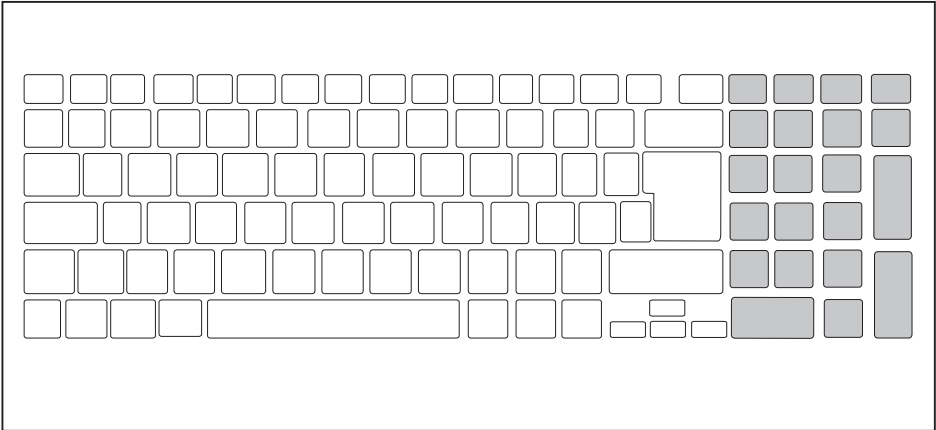







Key combinations



The following description of key combinations applies to Windows operating systems. Some of the following key combinations may not function in other operating systems or with certain device drivers.

Other key combinations are described in the relevant manuals supplied with your application programs.

Key combinations are entered as follows:

- ▶ Press the first key in the combination and keep it pressed.
- ▶ While holding the first key down, press the other key or keys in the combination.

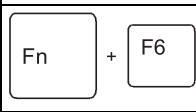
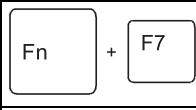
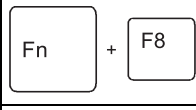
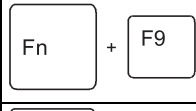
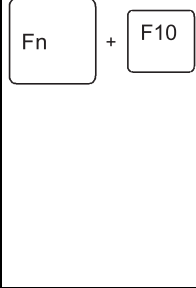
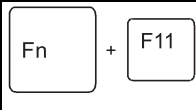
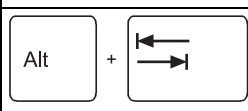
Combination	Description
 + 	Switching the loudspeakers on and off This key combination switches your notebook's loudspeakers off and on.
 + 	Switching the touchpad and touchpad buttons on/off This key combination switches the touchpad and the touchpad buttons on or off.
 + 	Switching the wireless components on / off This key combination switches the wireless components off or on.

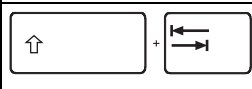
Combination	Description
	<p>Decrease screen brightness This key combination decreases the brightness of the screen.</p>
	<p>Increase screen brightness This key combination increases the brightness of the screen.</p>
	<p>Decrease volume This key combination reduces the volume of the internal loudspeakers.</p>
	<p>Increase volume This key combination increases the volume of the internal loudspeakers.</p>
	<p>Toggle output screen Use this key combination to select which screen(s) is/are used for display if an external monitor is connected.</p> <p>Screen output is possible:</p> <ul style="list-style-type: none"> • only on the notebook's LCD screen • on the LCD screen of the notebook and the external monitor at the same time • only on the external monitor <p>This setting is useful if you would like a high resolution and a high refresh rate on an external monitor.</p>
	<p>Power management functions Use this key combination to activate the power management functions (see chapter "Using the power-management features", Page 36).</p>
	<p>Switch between open applications Use this key combination to switch between several open applications.</p>
	<p>Windows security/Task-Manager This key combination opens the Windows security/Task-Manager window.</p>
	<p>Back tab This key combination moves the cursor back to the previous tab stop.</p>



Key combinations using the Windows keys are detailed in the manual for your operating system.

Country and keyboard settings

If you want to change the country and keyboard settings, proceed as follows:

- ▶ Enter the settings by clicking *Start – (Settings) – Control Panel – Time, Regional and Language Options*.

Touchpad and touchpad buttons



Keep the touchpad clean. Protect it from dirt, liquids and grease.

Do not use the touchpad if your fingers are dirty.

Do not rest heavy objects (e.g. books) on the touchpad or the touchpad buttons.

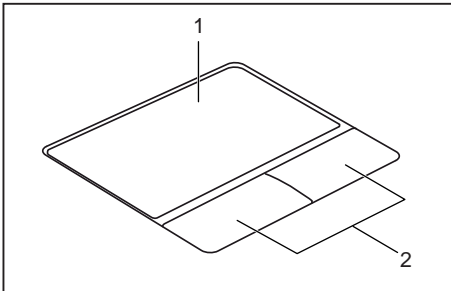

1 = Touchpad

2 = Touchpad buttons

The touchpad enables you to move the mouse pointer on the screen.

The touchpad buttons allow you to select and execute commands. They correspond to the buttons on a conventional mouse.



You can use a key combination to disable the touchpad, to avoid accidentally moving the pointer on the screen (see also ["Key combinations", Page 25](#)).

Moving the pointer

- ▶ Move your finger on the touchpad.
- ↳ The pointer will move.

Selecting an item

- ▶ Move the pointer to the item you wish to select.
- ▶ Tap the touchpad once or press the left button once.
- ↳ The item is selected.

Executing commands

- ▶ Move the pointer to the field you wish to select.
- ▶ Tap the touchpad twice or press the left button twice.
- ↳ The command is executed.

Dragging items

- ▶ Select the desired item.
- ▶ Press and hold the left button and drag the item to the desired position with the finger on the touchpad.
- ↳ The item will be moved.

Switching the Touchpad on and off



You can switch the Touchpad on and off using a key combination, see "[Key combinations](#)", [Page 25](#).

LCD screen

High-quality TFT displays are installed in notebooks from Fujitsu Technology Solutions GmbH. For technical reasons, TFT monitors are manufactured for a specific resolution. An optimal, clear picture can only be ensured with the correct resolution intended for the relevant TFT monitor. A monitor resolution which differs from the specification can result in an unclear picture.

The screen resolution of the LCD monitor of your notebook is optimally set at the factory.

The standard of production techniques today cannot guarantee an absolutely fault-free screen display. A few isolated constant lit or unlit pixels (picture elements) may be present. The maximum permitted number of pixels faults is stipulated in the international standard ISO 9241-3 (Class II).

Example:

A monitor with a resolution of 1280 x 800 has $1280 \times 800 = 1024000$ pixels. Each pixel consists of three subpixels (red, green and blue), so there are almost 3 million subpixels in total. According to ISO 9241-3 (class II), a maximum of 2 light and 2 dark pixels and an additional 5 light or 10 dark subpixels or a corresponding mix may be defective (1 light subpixel counts as 2 dark subpixels).

Pixel	A pixel consists of 3 subpixels, normally red, green and blue. A pixel is the smallest element that can be generated by complete functionality of the display.
Subpixel	A subpixel is a separately addressable internal structure within a pixel that enhances the pixel function.
Cluster	A cluster contains two or more defective pixels or subpixels in a 5 x 5 pixel block.

Background lighting

TFT monitors are operated with background lighting. The luminosity of the background lighting can decrease during the period of use of the notebook. However, you can set the brightness of your monitor individually.

Synchronising the display on the LCD screen and an external monitor

For more information, please refer to the chapter ["Key combinations", Page 25](#) under "Display output, switch between".

Webcam

Depending on the software used, you can use your Webcam to take pictures, record video clips or take part in web chats.

- The picture quality depends on the lighting conditions and the software being used.
- You can only operate the webcam with a particular application (e.g. an Internet telephony program or a video conferencing program which supports a webcam).
- When using the webcam the notebook support must not wobble.
- The webcam automatically adjusts itself to the current light level. For this reason the LCD screen may flicker while the light level is adjusted.



Further information on using the webcam and on the additional settings which are possible for your webcam can be found in the help function of the program which uses the webcam.

If you wish to carry out a function test with your webcam, you can use the corresponding test software available at ["http://ts.fujitsu.com/support/"](http://ts.fujitsu.com/support/).

Rechargeable battery

When not plugged into a mains socket, the notebook runs on its built-in battery. You can increase the life of the battery by caring for the battery properly. The average battery life is around 500 charge/discharge cycles.

You can extend the battery life by taking advantage of the available energy saving functions.

Charging, caring for and maintaining the battery

The notebook battery can only be charged, when the ambient temperature is between 5°C and max. 35°C.

You can charge the battery by connecting the notebook to the mains adapter (see "[Mains adapter connecting](#)", [Page 17](#)).

If the battery is running low you will hear a warning alarm. If you do not connect the mains adapter within five minutes of the warning alarm described above, your notebook will automatically switch off.

monitoring the battery charging level

Windows also has a "Battery status meter" in the taskbar for monitoring the battery capacity. When you place the mouse pointer on the battery symbol, the system displays the battery status.

Battery storage

Keep the battery pack between 0°C and +30°C. The lower the temperature at which the batteries are stored, the lower the rate of self-discharge.



If you will be storing batteries for a longer period (longer than two months), the battery charge level should be approx. 30 %. To prevent exhaustive discharge which would permanently damage the battery, check the level of charge of the battery at regular intervals.

To be able to make use of the optimal charging capacity of the batteries, the battery should be completely discharged and then fully recharged.



If you do not use the batteries for long periods, remove them from the notebook. Never store the batteries in the device.

Removing and installing the battery



Only use rechargeable batteries approved by Fujitsu Technology Solutions for your notebook.

Never use force when fitting or removing a battery.

Make sure that no foreign bodies get into the battery connections.

Never store a battery for longer periods in the discharged state. This can make it impossible to recharge.

Removing the battery

- ▶ Prepare for removal, see chapter ["Preparing to remove components", Page 53](#).

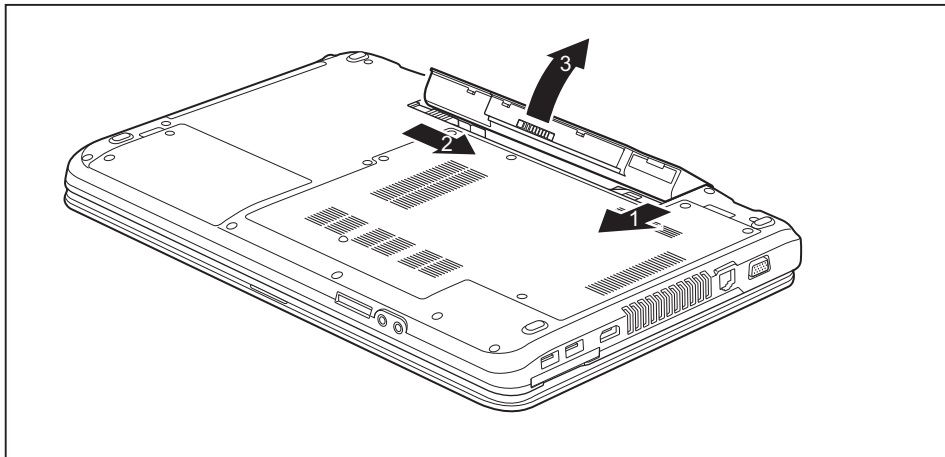

- ▶ Slide the release button in the direction of the arrow (1) and hold it in place.
- ▶ Slide the release button in direction of the arrow (2).
- ▶ Remove the battery from the battery compartment (3).

Inserting battery

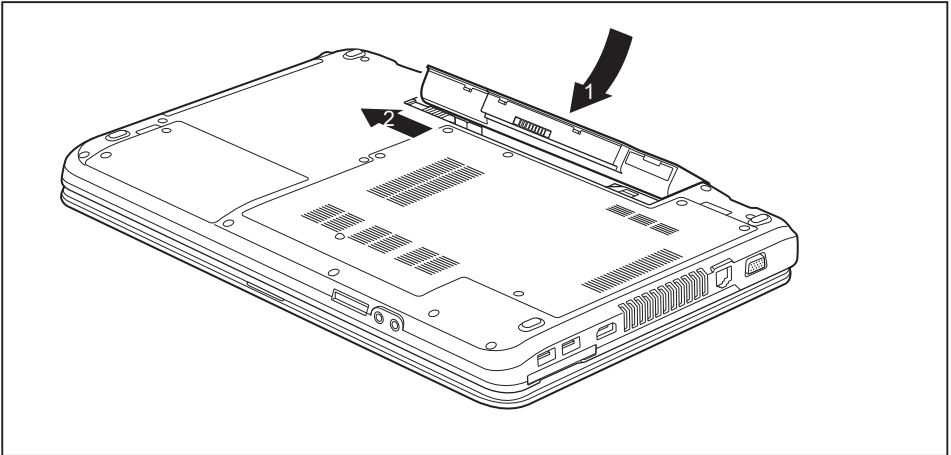

- ▶ Position the battery at the edge.
- ▶ Insert the battery into the battery compartment until it engages positively (1).
- ▶ Slide the release button in the direction of the arrow (2).
- ▶ Complete the removal, see chapter ["Finishing component removal", Page 59](#).

Optical drive



This product contains a light emitting diode, classified in accordance with IEC 8251:1993: LASER CLASS 1, and must therefore not be opened.

Handling data carriers

Observe the following guidelines when handling data carriers:

- Avoid touching the surface of a data carrier. Only handle data carriers by their edges.
- Always store data carriers in their cases. This will protect the data carrier against being covered in dust, scratched or damaged in any other way.
- Protect your data carriers against dust, mechanical vibrations and direct sunlight.
- Avoid storing a data carrier in areas subject to high temperatures or humidity.

You may use both 8-cm and 12-cm data carriers in the optical drive.

When using a data carrier of lesser quality, vibrations and reading errors may occur.

CD/DVD indicator

The CD/DVD indicator flashes when a data carrier is inserted. The indicator goes out when the drive is ready for reading. The indicator lights up when the drive is being accessed. You may only remove the data carrier when the indicator is unlit.



If the CD/DVD indicator does not go out after a data carrier has been inserted, but instead continues to flash, this means that the drive cannot access the data carrier.

Either the data carrier is damaged or dirty or you are using a data carrier that the drive cannot read.

Inserting or removing a data carrier

The notebook must be switched on.

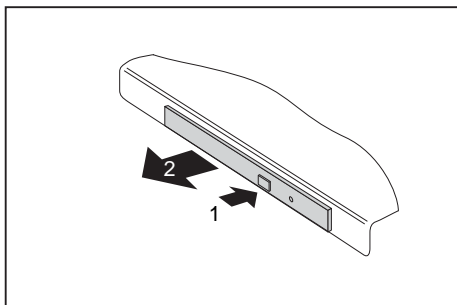

- ▶ Push the insert/eject button (1).
- ↳ The drive tray will open.
- ▶ Gently pull the drive tray (2) completely out.

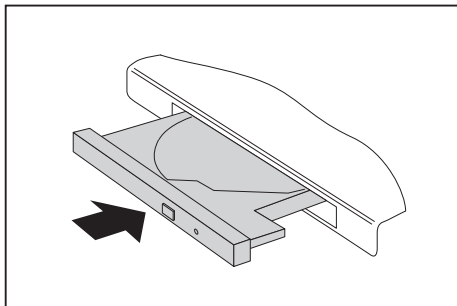

- ▶ Place the data carrier in the drive tray with the printed side facing upwards.

or

- ▶ Remove a data carrier that has been inserted.
- ▶ Push in the drive tray until you feel it lock into place.

Manual removal (emergency removal)

In the event of a power failure or damage to the drive, you can remove the data carrier manually.

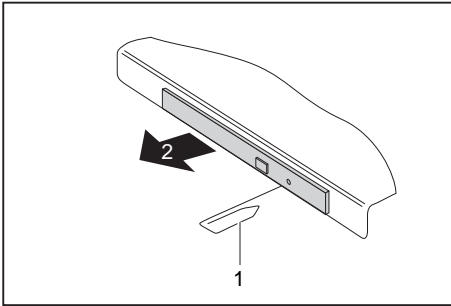

- ▶ Switch your notebook off.
- ▶ Push a pen or a piece of wire (such as a paperclip) firmly into the opening (1).
- ↳ The drive tray is ejected. You can now pull the drive tray (2) out of the drive.

Using the power-management features

The notebook uses less power when the available power-management features are used. You will then be able to work longer when using the battery before having to recharge it.



Power efficiency is increased and environmental pollution reduced. By choosing the best power options, you can make significant savings and at the same time help protect the environment.

When you close the LCD screen, depending on the setting in Windows, the notebook automatically enters a power saving mode.

We recommend the following settings:

Function	On external power	On battery power
Turn off monitor	After 10 minutes	After 5 minutes
Turn off hard disk(s)	After 15 minutes	After 10 minutes
Energy saving (S3)	After 20 minutes	After 15 minutes
Hibernate mode (S4)	After 1 hour	After 30 minutes

- ▶ Select the power management functions in your Control Panel.
- ▶ Select the Screen Saver in your Control Panel.

or

- ▶ Right-click on the desktop. Switch on the screen saver by clicking *Personalization – Change screen saver*.



If you need further information about an option, you can get help with most settings by pressing **F1** to open the Microsoft Help.

When the notebook is in power-saving mode, the following must be remembered:



During power saving mode, open files are held in the main memory or in a swap file on the hard disk.

Never turn off your notebook while it is in a power saving mode. If the built-in battery is nearly empty, close the open files and do not go into power saving mode.

If you do not intend to use your notebook for a long period of time:

- ▶ Exit power saving mode if necessary via the mouse or keyboard or by switching on the notebook.
- ▶ Close all opened programs and completely shut down the notebook.

Memory cards

Your notebook is equipped with an integrated memory card reader.



Observe the manufacturer's instructions when handling the memory cards.

Supported formats

Your notebook supports the following formats:

- SDHC
- SDXC
- Memory Stick / Memory Stick pro (Sony®)

Inserting the memory card

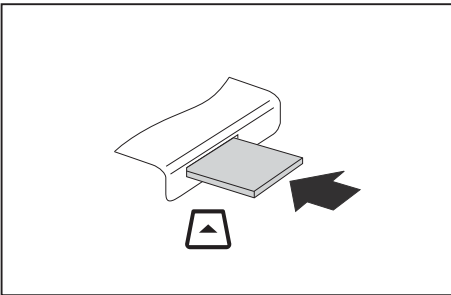

- ▶ Carefully slide the memory card into the slot. The label should be facing upward. Do not apply excessive force, as otherwise the delicate contact surfaces could be damaged.
- ↳ Depending on the particular type used, the memory card may protrude slightly from the slot.

Removing the memory card



In order to protect your data, always follow the correct procedure for removing the card outlined below.

You can stop the memory card via the corresponding icon in the task bar:

- ▶ Left-click on the icon.
- ▶ Select the card you want to stop and remove.
- ▶ Press the Enter key.
- ↳ Wait for the dialogue box which tells you that it is now safe to remove the memory card.
- ▶ Pull the memory card out of the slot.

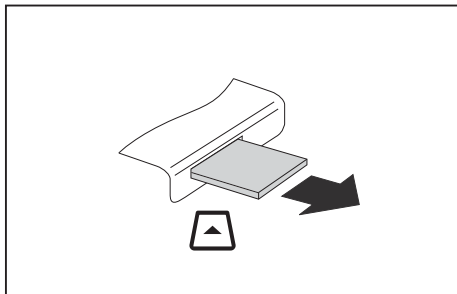

ExpressCards

An ExpressCard slot enables operation of an ExpressCard/34 or ExpressCard/54.



Consult the documentation supplied by the ExpressCard's manufacturer and follow the instructions provided.

Never use force when installing or removing an ExpressCard.

Make sure that no foreign objects enter the ExpressCard slot.

Inserting the card



Keep the placeholder for the slot in a safe place. When you remove the card again, you must reinstall the place holder. This prevents foreign objects from getting into the slot.

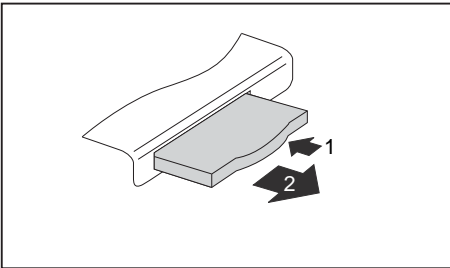

- ▶ Press the edge of the placeholder (1) to make the card placeholder protrude from the notebook's case.
- ▶ Pull the card placeholder out of the slot (2).

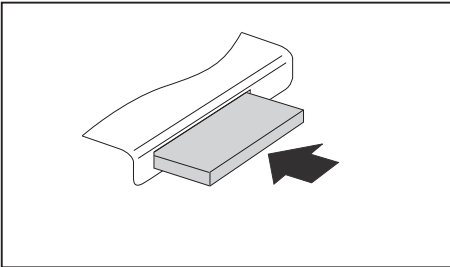

- ▶ Insert the card into the slot guide with the connection contacts first.
- ▶ Gently push the card into the slot until you feel it click into place. Do not use any force. Depending on the particular type used, the card may protrude slightly from the slot.



Please see the documentation relating to the card for driver installation instructions.

Removing the card



Always remove the card according to the rules described below, to ensure that none of your data is lost.

You can stop the ExpressCard using the corresponding symbol in the task bar:

- ▶ Click on the symbol for safe removal of hardware with the left mouse button.
- ▶ Select the ExpressCard you want to stop and remove.
- ▶ Press the Enter key.
- ↳ Wait for the dialogue box which tells you that it is now safe to remove the ExpressCard.

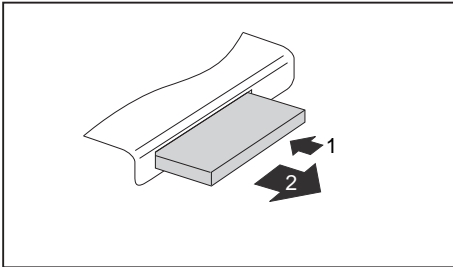

- ▶ Press the edge of the card (1) so that the card protrudes a little from the notebook.
- ▶ Pull the card out of the slot (2).

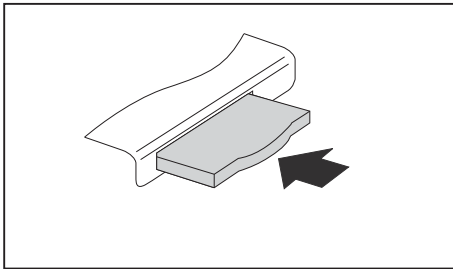

- ▶ Insert the card placeholder into the slot guide.
- ▶ Gently slide the card placeholder into the slot until you feel it click into place.

Loudspeakers and microphones

Information on the exact position of the speakers and microphone can be found in ["Ports and controls", Page 9](#).

Please refer to chapter ["Key combinations", Page 25](#) for information on setting the volume and also enabling/disabling the loudspeakers using key combinations.



If you attach an external microphone, the built-in microphone is disabled.

When you connect headphones or external speakers, the built-in speakers are disabled.

Information on connecting headphones and a microphone can be found in ["Connecting external devices", Page 48](#).

SIM card (devices with UMTS module)

A SIM Card (Subscriber Identity Module) is a chip card which is inserted in a mobile telephone or notebook to enable access to a mobile radio network in conjunction with an installed UMTS module.



Follow the instructions supplied by the provider of the SIM card.

The SIM card slot is located in the battery compartment and can only be accessed when the battery is removed.

Inserting the SIM card

- ▶ Prepare for installation of the SIM card, see chapter ["Preparing to remove components", Page 53.](#)

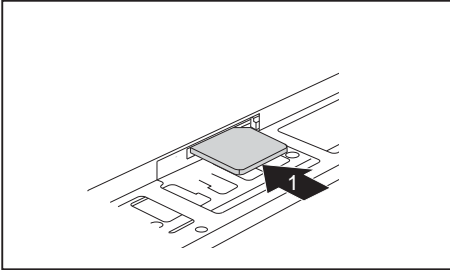

- ▶ Slide the SIM card into the slot (1) until it is felt to engage, as shown in the battery compartment.

- ▶ Complete the installation, see chapter ["Finishing component removal", Page 59.](#)

Removing the SIM card

- ▶ Prepare for removal of the SIM card, see chapter ["Preparing to remove components", Page 53.](#)

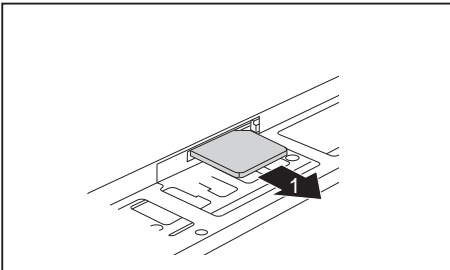

- ▶ Press on the edge of the SIM card so that it jumps up slightly out of the slot.
- ▶ Pull the SIM card out of the slot in the direction of the arrow (1).

- ▶ Complete the removal, see chapter ["Finishing component removal", Page 59.](#)

Wireless LAN / Bluetooth / UMTS



The installation of radio components not approved by Fujitsu Technology Solutions will invalidate the certifications issued for this device.

Switching the wireless components on and off

- ▶ Press the key combination **[Fn] + [F5]** to start the *WirelessSelector*.
- ↳ The wireless component indicator will illuminate when one or more wireless components are switched on.



The Bluetooth and UMTS modules and the wireless LAN transmission unit (antenna) will also be switched off when you switch off the wireless components.

Pay attention to the additional safety notes for devices with wireless components provided in the "Safety" manual.

Details on using a Wireless LAN can be found in the online help system included in the Wireless LAN software.

You can obtain more information on UMTS from your service provider.

Setting up WLAN access

- Requirement: A WLAN must be available and you must have the corresponding access information.



Information on configuring the WLAN access can be found in the documentation for your operating system.

Access via UMTS

If you have ordered an integrated UMTS module with your system, you can enjoy the best reception and maximum energy efficiency, without any disruptive cables or aerials. The optional UMTS module is ready for use immediately.

If you have not ordered a UMTS module, you can purchase the accessories for UMTS reception from specialised dealers or from your Fujitsu Technology Solutions dealer.

You will find information on establishing the connection with the UMTS network in the documentation for the hardware used.

Your device can connect with the Internet via UMTS. To do this, use one of the following types of connection:

- an integrated UMTS module (depending on your model variant)
- a USB dongle (a USB stick with your mobile phone provider's SIM card)
- a UMTS ExpressCard (to be inserted in the ExpressCard slot of your device)
- a mobile end-device (e.g. mobile phone with Bluetooth or cable connection)

Ethernet and LAN

The internal network module of your notebook supports Ethernet LAN. You can use it to establish a connection to a local network (LAN = Local Area Network).

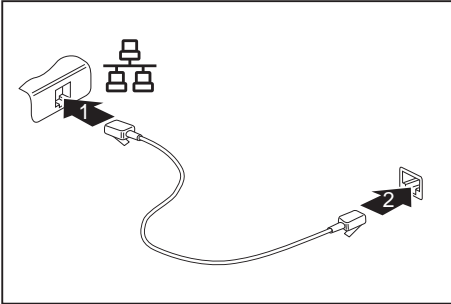

- ▶ Connect the network cable to the LAN port of the notebook (1).
- ▶ Connect the network cable to your network connection (2).

i

Your network administrator can help you to configure and use the LAN connections.

The network cable is not included in the delivery scope. This type of cable can be obtained from a specialist dealer.

Security functions

Your notebook has several security features that you can use to secure your system from unauthorised access.

This chapter explains how to use each function, and what the benefits are.



Please remember that in some cases, for example, forgetting your password, you may be locked out and unable to access your data. Therefore, please note the following information:

- Make regular backups to external data carriers such as external hard drives, CDs, DVDs or Blu-ray Discs.
- Some security functions need you to choose passwords. Make a note of the passwords and keep them in a safe place.

If you forget your passwords you will need to contact the our Service Desk. Deletion or resetting of passwords is not covered by your warranty and a charge will be made for assistance.

Use Kensington Lock

Your device comes with a Kensington Lock device for the Kensington MicroSaver. With the Kensington MicroSaver, a sturdy steel cable, you can help protect your notebook from theft. The Kensington MicroSaver is available as an accessory.

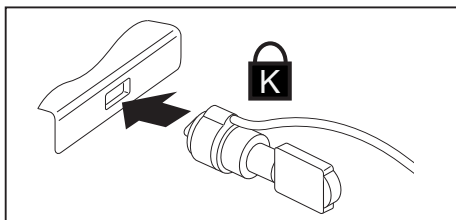

- ▶ Fit the Kensington MicroSaver on the device on your notebook.

Configuring password protection in BIOS Setup Utility



Before using the various options for password protection in the *BIOS Setup utility* to increase data security, please observe the following:

Make a note of the passwords and keep them in a safe place. If you forget your supervisor password you will not be able to access your notebook. Passwords are not covered by your warranty and a charge will be made for assistance.



Your password can be up to eight characters long and contain letters and numbers. No distinction is made between uppercase and lowercase.

Protecting BIOS Setup Utility (supervisor and user password)



If you have opened these operating instructions on the screen, we recommend that you print out the following instructions. Because you cannot call the instructions onto the screen while you are setting up the password.

You prevent unauthorised use of the *BIOS Setup Utility* with both the supervisor and the user password. The supervisor password gives you access to all functions of the *BIOS Setup Utility*, while the user password only provides some of the functions. You can only set a user password if a supervisor password has already been assigned.



Please refer to the ["Settings in BIOS Setup Utility", Page 60](#) section for a description of how to call up and operate the *BIOS Setup Utility*.

Setting supervisor and user password

- ▶ Start the *BIOS Setup Utility* and go to the *Security* menu.
- ▶ Select the *Set Supervisor Password* field and press the Enter key.
- ↳ With *Enter new Password*: you are asked to enter a password.
- ▶ Enter the password and press the Enter key.
- ↳ *Confirm new Password* requires you to confirm the password.
- ▶ Enter the password again and press the Enter key.
- ↳ *Changes have been saved* is a confirmation that the new password has been saved.
- ▶ To set the user password, select *Set User Password* and proceed exactly as when configuring the supervisor password.
- ↳ If you do not want to change any other settings, you can exit *BIOS Setup Utility*.
- ▶ In the *Exit* menu, select the option *Save Changes & Exit*.
- ▶ Select *Yes* and press the Enter key.
- ↳ The notebook will be rebooted and the new password will come into effect. It will now be necessary to first enter your supervisor or user password in order to open the *BIOS Setup Utility*. Please note that the user password only provides access to a few of the BIOS settings.

Changing the supervisor or user password

You can only change the supervisor password when you have logged into the *BIOS Setup Utility* with the supervisor password.

- ▶ Call the *BIOS Setup Utility* and go to the *Security* menu.
- ▶ When changing the password, proceed exactly as for password assignment.

Removing passwords

To remove a password (without setting a new password) perform the following steps:

- ▶ Start the *BIOS Setup Utility* and go to the *Security* menu.
- ▶ Highlight the *Set Supervisor Password* or *Set User Password* field and press the Enter key.
 - ↳ You will be requested to enter the current password by the *Enter Current Password* prompt. You will be requested to enter a new password by the *Enter New Password* prompt.
- ▶ Press the Enter key twice.
- ▶ In the *Exit* menu, select the option *Save Changes & Exit*.
- ▶ Select *Yes* and press the Enter key.
 - ↳ The notebook will now reboot with the password removed. Removing the supervisor password simultaneously deactivates the user password.

Password protection for booting of the operating system



With the supervisor password you have set in the *BIOS Setup Utility* (see section "[Setting supervisor and user password](#)", Page 45), you can also prevent booting of the operating system.

Activating system protection

- ▶ Start the *BIOS Setup Utility* and go to the *Security* menu.
- ▶ Select the *Password on Boot* option and press the Enter key.
- ▶ Select the desired option (*Disabled*, *First Boot* or *Every Boot*) and press the Enter key.
- ▶ Select the *Save Changes & Exit* option under *Exit*.
 - ↳ The notebook will reboot. You will be prompted to enter your password (the supervisor password).

Deactivating system protection

- ▶ Start the *BIOS Setup Utility* and go to the *Security* menu.
- ▶ Select the *Password on Boot* option and press the Enter key.
- ▶ Select the *Disabled* option and press the Enter key.
 - ↳ If you do not want to change any other settings, you can exit *BIOS Setup Utility*.
- ▶ Select the *Save Changes & Exit* option under *Exit*.
 - ↳ The notebook will reboot. The system is no longer password-protected.

Password protection for the hard disk



The hard disk password prevents unauthorised access to the hard disk drives and is checked internally each time the system is booted. The condition for this is that you have assigned at least the supervisor password.

Activating hard disk protection

- ▶ Call up the *BIOS Setup* and select the *Security* menu.
- ↳ If you have not assigned BIOS passwords yet, define the supervisor and the user password now, if desired (see "[Security functions](#)", [Page 44](#)).
- ▶ Mark the *Hard Disk Security* field and press the Enter key.
- ▶ In the *Drive0* area mark the *Set Master Password* field and press the Enter key.
- ↳ *Enter new Password* then appears and you are asked to enter a password.
- ▶ Enter the password and press the Enter key.
- ↳ *Confirm new Password* requires you to confirm the password.
- ▶ Enter the password again and press the Enter key.
- ↳ *Setup Notice: Changes have been saved* is displayed to confirm that the new password has been saved.
- ▶ To assign the password for the second hard disk (*Drive1*), go to the *Drive1* area and select the field *Set Master Password*, then proceed in exactly the same way as for setting up the password for the first hard disk (*Drive0*).
- ↳ The field *Password Entry on Boot* is set to *Enabled* by default. You can exit the *BIOS Setup* once you have finished changing the settings.
- ▶ From the *Exit* menu, choose the option *Exit Saving Changes*.
- ▶ Press the Enter key and select *Yes*.
- ↳ The notebook reboots and your hard disk is now protected with a password. The system will ask you to enter the password when the notebook is restarted again.

Deactivating hard disk protection

To cancel a password without setting a new one, proceed as follows:

- ▶ Call up the *BIOS Setup* and select the *Security* menu.
- ▶ Mark the *Hard Disk Security* field and press the Enter key.
- ▶ In the *Drive0* area mark the *Set Master Password* field and press the Enter key.
- ↳ You will be initially requested to enter the old password by the *Enter current Password* prompt. You will then be requested to enter a new password by the *Enter new Password* prompt.
- ▶ After entering the password, press the Enter key three times.
- ▶ From the *Exit* menu, choose the option *Exit Saving Changes*.
- ▶ Press the Enter key and select *Yes*.
- ↳ The notebook reboots, and password protection for the hard disk is cancelled.
- ▶ To cancel the password for the second hard disk (*Drive1*), go to the *Drive1* area and select the field *Set Master Password*, then proceed in exactly the same way as for cancelling the password for the first hard disk (*Drive0*).

Connecting external devices



Always refer to the safety information provided in "[Important notes](#)", [Page 12](#) before connecting or disconnecting any devices to or from your notebook.

Always read the documentation supplied with the device you wish to connect.

Never connect or disconnect cables during a thunderstorm.

Never pull at a cable when disconnecting it. Always grasp the plug.

Follow the steps below in order, when connecting or disconnecting devices to your notebook:



With some devices such as USB devices, it is not necessary to switch off the notebook and the device before connecting/disconnecting. For more information about whether or not devices need to be switched off, please refer to the documentation supplied with the external device.

Some of the external devices require special drivers (see the operating system and external device documentation).

Connecting devices to the notebook

1. Turn off your notebook and all external devices.
2. Unplug your notebook and all devices from the mains sockets.
3. Connect the cables for your external devices following the instructions.
4. Plug all power cables into the mains sockets.

Disconnecting devices from the notebook

1. Turn off your notebook and all external devices.
2. Unplug your notebook and all devices from the mains sockets.
3. Disconnect the cables for your external devices following the instructions.

Connecting an external monitor

You can connect an external monitor to the analogue VGA monitor connection of the notebook. Screen output is limited to a maximum of two screens at any one time (see ["Key combinations"](#), [Page 25](#), section "Toggle output screen").

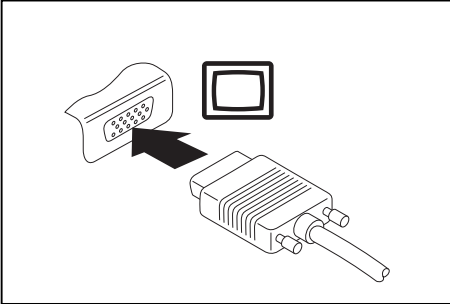

Analogue VGA monitor connection socket

- ▶ Switch off the notebook and the external monitor.
- ▶ Connect the data cable of the external monitor to the monitor port of the notebook.
- ▶ First switch on the external monitor and then the notebook.

i

You can also use a key combination to switch back and forth between the external monitor and the notebook's LCD screen, see chapter ["Key combinations"](#), [Page 25](#).

You can display the same picture on the external monitor and the notebook LCD screen simultaneously.

HDMI port

The HDMI port on your notebook can be used to connect an external amplifier, LCD TV or a plasma TV with an HDMI connection.

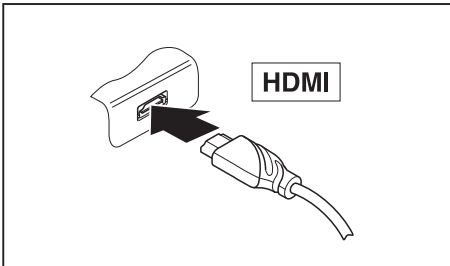

- ▶ Connect the data cable to the external device.
- ▶ Connect the data cable to the HDMI port of the notebook.

Connecting USB devices

On the USB ports, you can connect external devices that also have a USB port (e.g. a DVD drive, a printer, a scanner or a modem).



USB devices are hot-pluggable. This means you can connect and disconnect devices while your operating system is running.

USB 1.x has a maximum data transfer rate of 12 Mbit/s.

USB 2.x has a data transfer rate of up to 480 Mbit/s.

Additional information can be found in the documentation for the USB devices.

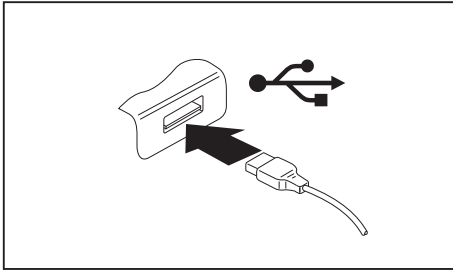

- ▶ Connect the data cable to the external device.
- ▶ Connect the data cable to a USB port of the notebook.



Device drivers

USB devices will be automatically recognised and installed by your operating system.

How to remove USB devices correctly



Always correctly remove the device according to the rules described below, to ensure that none of your data is lost.

- ▶ Left click on the icon to safely remove hardware, located in the taskbar.
- ▶ Select the device which you want to shut down and remove.
- ▶ Press the Enter key.
- ↳ Wait for the dialogue box which tells you that it is now safe to remove the device.

Connecting external audio devices

Microphone port/Line In

The microphone port/Line In allows you to connect an external microphone, a MiniDisc player, MP3 player, CD player or a tape deck to your notebook.

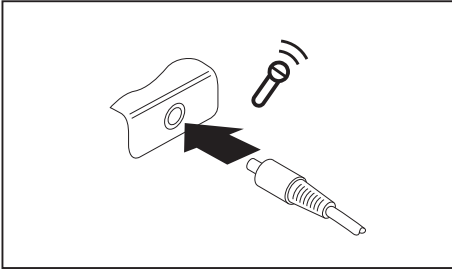

- ▶ Connect the audio cable to the external device.
- ▶ Connect the audio cable to the microphone port/Line In of the notebook.

Headphone port

You can connect headphones or external loudspeakers to your notebook via the headphone port.

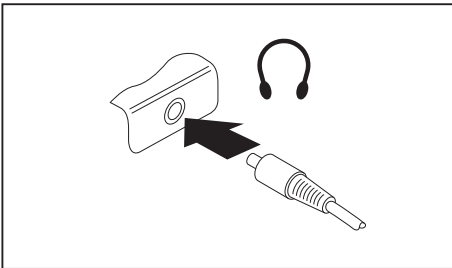

- ▶ Connect the audio cable to the external device.
- ▶ Connect the audio cable to the headphone port of the notebook.
- ↳ The internal loudspeakers are disabled.



If you purchase a cable from a retailer, please note the following information:

The headphone port on your notebook is a "3.5 mm jack socket".

If you want to connect headphones or a speaker you will need a "3.5 mm jack plug".

Removing and installing components during servicing



Only qualified technicians should repair your notebook. Unauthorised opening or incorrect repair may greatly endanger the user (electric shock, fire risk) and will invalidate your warranty.

After consulting the Hotline/Service Desk, you may remove and install the components described in this chapter yourself.



If you remove and install components without consulting the Hotline/Service Desk, then the warranty of your notebook will be voided.

Notes on installing and removing boards and components

- Switch the notebook off and pull the power plug out of the mains socket.
- Always remove the battery.
- Take care when you use the locking mechanisms on the battery and any other component.
- Never use sharp objects such as screwdrivers, scissors or knives as leverage to remove covers.



Boards with electrostatic sensitive devices (ESD) are marked with the label shown.

When handling boards fitted with ESDs, you must always observe the following points:

- You must always discharge static build up (e.g. by touching a grounded object) before working.
- The equipment and tools you use must be free of static charges.
- Remove the power plug from the mains supply before inserting or removing boards containing ESDs.
- Always hold boards with ESDs by their edges.
- Never touch pins or conductors on boards fitted with ESDs.

Preparing to remove components

If you are going to remove or change system components, prepare for the removal as follows:



Please observe the safety information in chapter ["Important notes", Page 12.](#)

Remove the power plug from the mains outlet !

- ▶ Switch the device off.



The device must not be in energy-saving mode !

- ▶ Close the LCD screen.
- ▶ Remove all the cables from the device.
- ▶ Turn the device over and place it on a stable, flat and clean surface. If necessary, lay an anti-slip cloth on this surface to prevent the device from being scratched.
- ▶ Remove the battery (see ["Removing the battery", Page 32.](#))

Installing and removing memory expansion

If you are asked by the Hotline/Service Desk to remove and install the memory expansion yourself, proceed as follows:



Please observe the safety information in chapter ["Important notes", Page 12.](#)

When installing/removing memory modules, the battery must be removed from the notebook and the notebook must not be connected to the power supply, see ["Preparing to remove components", Page 53.](#)

Only use memory expansion modules that have been approved for your notebook (see ["Technical data", Page 70.](#))

Never use force when installing or removing a memory extension.

Make sure that foreign objects do not fall into the memory extension compartment.

You must open the service compartment to remove or install a memory module. On some devices, opening the compartment may expose other components. These components should be removed and replaced only by authorised specialists. Therefore, be sure to observe the following:



Individual components can become very hot during operation. Therefore, we recommend that you wait one hour after switching off the notebook before removing or installing memory modules. Otherwise, there is a risk of suffering burns!

As some components are exposed that are sensitive to static electricity, please take note of chapter ["Notes on installing and removing boards and components", Page 52.](#)

Removing the cover

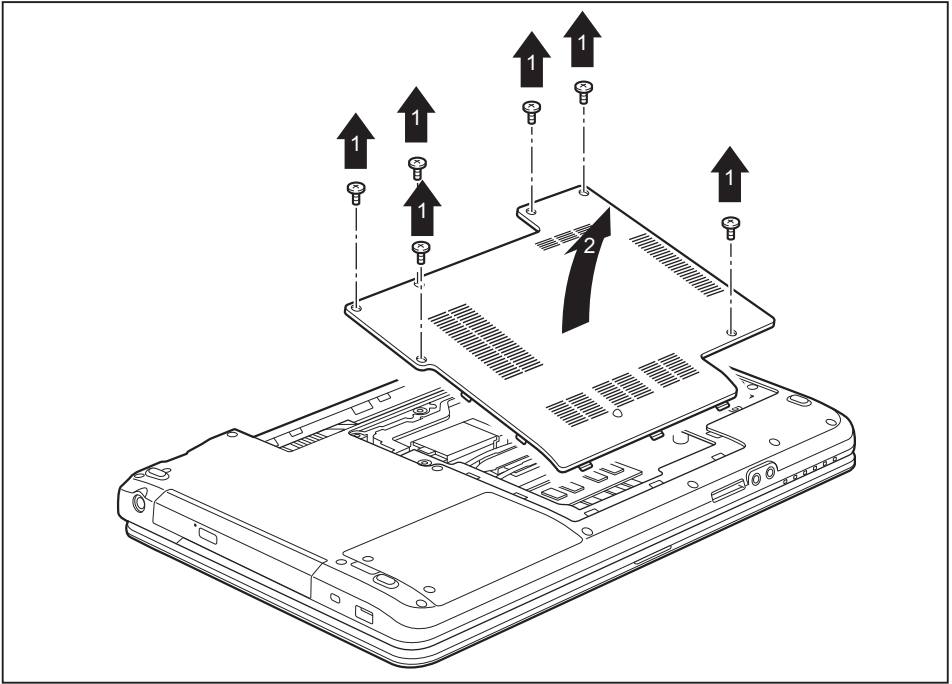

- ▶ Remove the screws (1).
- ▶ Lift the cover off the notebook (2).

Removing memory modules

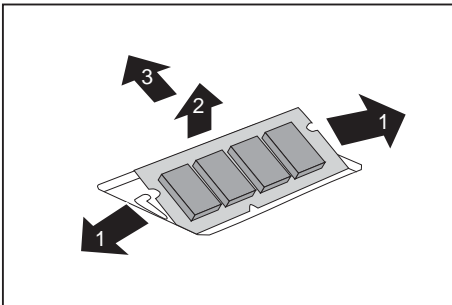

- ▶ Carefully push the two mounting clips outwards (1).
- ↳ The memory module snaps upwards (2).
- ▶ Pull the memory module out of its slot in the direction of the arrow (3).

Installing a memory module

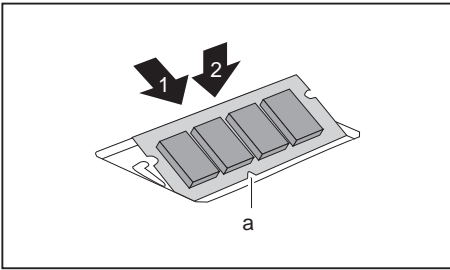

- ▶ Insert the memory module with the contacts and the recess (a) facing the slot (1).
- ▶ Carefully push the memory module downwards until you feel it click into place (2).

Securing the cover

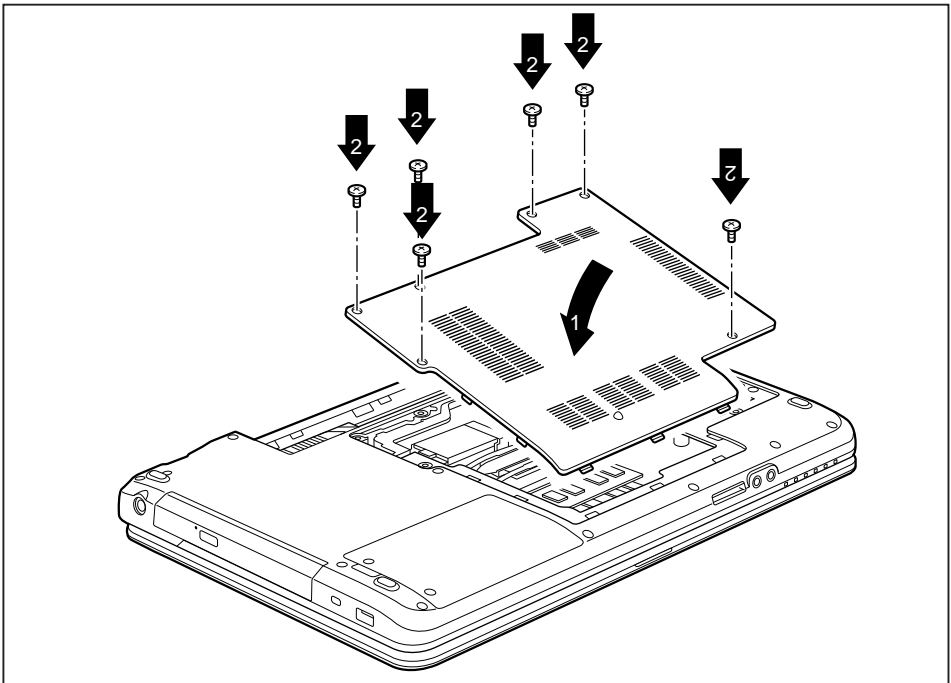

- ▶ Place the cover into its installation position in the direction of the arrow (1).
- ▶ Secure the cover with the screws (2).

Removing and installing the hard disk

Removing a cover

- ▶ Remove the battery (see Chapter ["Removing the battery", Page 32](#)).

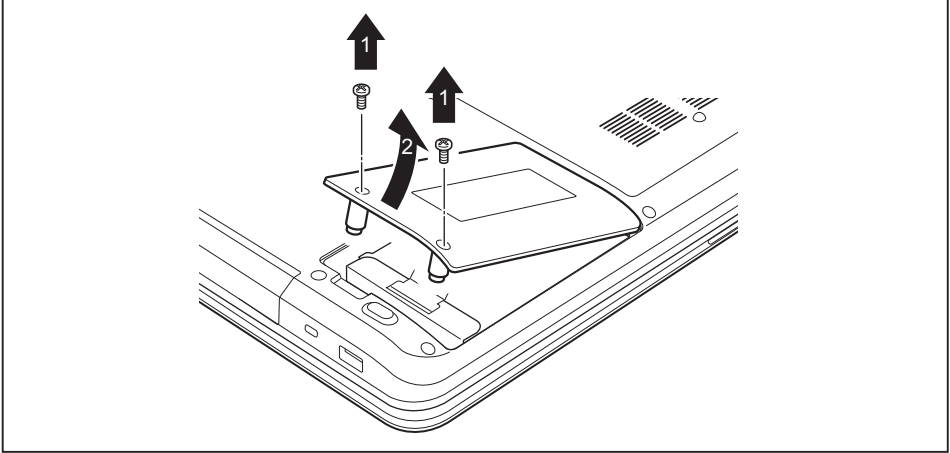

- ▶ Remove the screws (1).



Keep the screws in a safe place. If you are removing more than one component at the same time, store the screws for the individual components separately from each other. If you install the wrong screws, components may be damaged.

- ▶ Lift the cover off the notebook (2).

Removing a hard disk

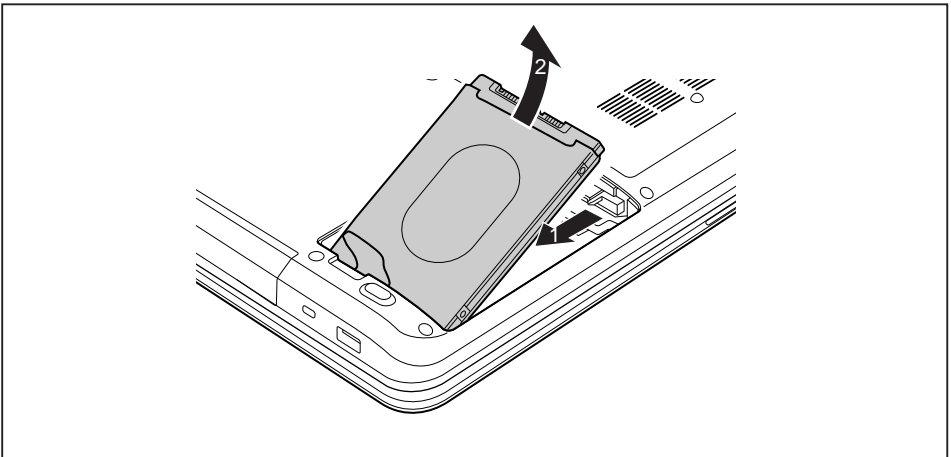

- ▶ Use the pulling aid to pull the hard disk in the direction of the arrow (1) until the contacts disengage.
- ▶ Remove the hard disk from the hard disk compartment (2).

Installing a hard disk



If you are installing more than one component at the same time, keep the screws for the individual components separately from each other and make sure that you use the correct screws. If you install the wrong screws, components may be damaged.

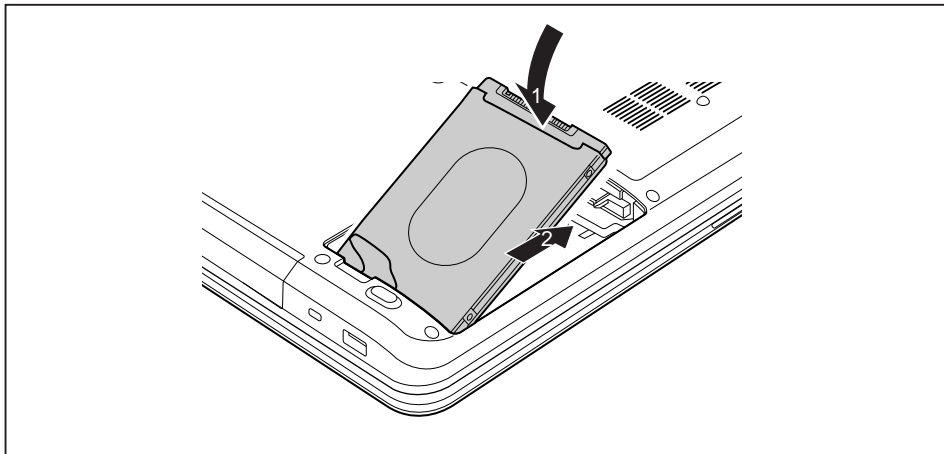

- ▶ Place the hard disk into the hard disk compartment (1).
- ▶ Push the hard disk in the direction of the arrow (2) until the contacts engage.
- ▶ Fasten the screws (3).

Attaching the cover

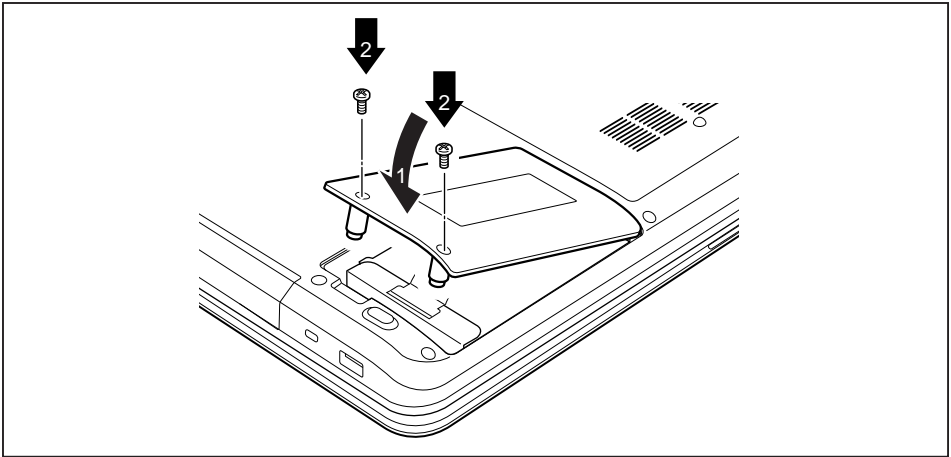

- ▶ Place the cover in the correct mounting position (1).



If you remove more than one component at the same time, keep the screws for the individual components separately from each other and make sure that you use the correct screws. If you install the wrong screws, components may be damaged.

- ▶ Tighten the screws (2).
- ▶ Insert the battery (see Chapter ["Inserting battery", Page 33](#)).

Finishing component removal

After you have removed or changed the system components as you required, please prepare your device for operation again as follows:

- ▶ Install the battery again (see ["Inserting battery", Page 33](#)).
- ▶ Turn the notebook the right way up again and place it on a flat surface.
- ▶ Reconnect the cables that you disconnected before.

Settings in BIOS Setup Utility

The *BIOS Setup Utility* allows you to set the system functions and the hardware configuration for the notebook.

When it is delivered, the notebook is set to factory default settings. You can change these settings in *BIOS Setup Utility*. Any changes you make take effect as soon as you save and exit the *BIOS Setup Utility*.

The *BIOS Setup Utility* program contains the following menus:

<i>About</i>	Displays information relating to the BIOS, processor and notebook
<i>System</i>	Advanced system settings
<i>Advanced</i>	Configuration of various hardware components, such as mouse, keyboard, processor
<i>Security</i>	Password settings and security functions
<i>Boot</i>	Configuration of the start-up sequence
<i>Exit</i>	Exits the <i>BIOS Setup Utility</i>

Starting the BIOS Setup Utility

▶ Reboot the notebook (switch off/on or reboot the operating system).

↳ The following or a similar display appears on the screen at start-up:

<F2> BIOS Setup <F12> Boot Menu

▶ Press the function key **[F2]**.

▶ If a password has been assigned, enter the password and press the Enter key.



If you have forgotten the password, contact your system administrator or contact our customer service centre.

The *BIOS Setup Utility* starts.

Operating BIOS Setup Utility



Press the **[F1]** key to display help on the operation of *BIOS Setup Utility*. The description of the individual settings is shown in the right-hand window of the *BIOS Setup Utility*.

With the **[F9]** key you can load the default settings of the *BIOS Setup Utility*.

▶ Use the cursor keys **[←]** or **[→]** to select the menu you wish to access to make changes.

↳ The menu is displayed on the screen.

▶ Select the option you want to change with the cursor keys **[↑]** or **[↓]**.

▶ Press the Enter key.

▶ Press the **[ESC]** key to exit the selected menu.

▶ For future reference, make a note of the changes you have made (for example, in this manual).

Exiting BIOS Setup Utility

You need to select the desired option in the *Exit* menu and activate it by pressing the Enter key:

Exit Saving Changes - save changes and exit BIOS Setup Utility

- ▶ To save the current menu settings and exit the *BIOS Setup Utility*, select *Exit Saving Changes* and *Yes*.
- ↳ The notebook is rebooted and the new settings come into effect.

Exit Discarding Changes – Discard changes and exit BIOS Setup Utility

- ▶ To discard the changes, select *Exit Discarding Changes* and *Yes*.
- ↳ The settings in place when *BIOS Setup Utility* was called remain effective. *BIOS Setup Utility* is terminated and the notebook is rebooted.

Load Setup Defaults – Copy Standard Entries

- ▶ To copy the standard entries for all menus of the *BIOS Setup Utility*, choose *Load Setup Defaults* and *Yes*.

Discard Changes – Discard changes without exiting the BIOS Setup Utility

- ▶ To discard the changes you have made, select *Discard Changes* and *Yes*.
- ↳ The settings in place when *BIOS Setup Utility* was called remain effective. You can now make additional settings in the *BIOS Setup Utility*.
- ▶ If you want to exit *BIOS Setup Utility* with these settings, select *Exit Saving Changes* and *Yes*.

Save Changes - save changes without exiting the BIOS Setup Utility

- ▶ To save the changes, select *Save Changes* and *Yes*.
- ↳ The changes are saved. You can now make additional settings in the BIOS Setup Utility.
- ▶ If you want to exit BIOS Setup Utility with these settings, choose *Exit Saving Changes* and *Yes*.

Save Changes and Power Off

- ▶ To save the changes and switch off your device, select *Save Changes and Power Off* and *Yes*.
- ↳ The changes are saved. Your device is shut down.

Troubleshooting and tips



Follow the safety notes in the "Safety/Regulations" manual when connecting or disconnecting cables.

If a fault occurs, try to correct it as described. If you fail to correct the problem, proceed as follows:

- ▶ Make a note of the steps and the circumstances that led to the fault. Also make a note of any error messages displayed.
- ▶ Switch the notebook off.
- ▶ Please contact the Hotline/Service Desk.



You can find the telephone numbers in the service desk list. Please have the following information ready when you call:

- The model name and serial number of the notebook. The serial number is located on a sticker on the underside of the notebook.
- Notes of any messages that appear on the screen and information on acoustic signals.
- Any changes you have made to the hardware or software since receiving the notebook.
- Any changes you have made to the *BIOS Setup* settings since receiving the notebook.
- Your system configuration and all peripheral devices connected to your system.
- Your sales contract.



Our notebooks have been designed primarily with mobile applications in mind. This means that considerable effort has been made to optimise components and equipment in terms of weight, space and energy requirements. Depending on the particular configuration you have purchased, it is possible that functionality may be slightly reduced compared to a desktop PC if you are running processor-intensive gaming software, e.g. games with intensive 3D graphics. Updating your hardware with drivers which have not been approved by Fujitsu Technology Solutions may result in performance losses, data losses or malfunction of the equipment. A list of approved drivers and current BIOS versions can be downloaded from: ["http://ts.fujitsu.com/support/downloads.html"](http://ts.fujitsu.com/support/downloads.html)

Help if problems occur

Should you at any time have a problem with your computer that you can't solve yourself, in many cases you can quickly solve it by using the *SystemDiagnostics* program which is pre-installed on your computer.



The *SystemDiagnostics* program is already installed on devices which were delivered with a Windows operating system.

- ▶ To start the *SystemDiagnostics* program, click on *Startsymbol - Program - Fujitsu - SystemDiagnostics*.
- ▶ If a problem is found during a test run, the *SystemDiagnostics* program outputs a code (e.g. DIFS-Code YXXX123456789123).
- ▶ Make a note of the output DIFS code and the identity number of your device. The identity number can be found on the type rating plate on the back of the casing.
- ▶ For further clarification of the problem, contact the Service Desk for your country (see the Service Desk list or visit the Internet at "<http://ts.fujitsu.com/support/serviceDesk.html>"). When you do this, please have ready the identity number and serial number of your system and the DIFS code.

Restoring the hard disk contents under Windows

You can use the "Windows Recovery CD" (optionally available) and the "Drivers & Utilities CD/DVD" to reinstall the operating system.

The instructions are provided on the case of the Recovery CD.



During the reinstall process your personal files and any installed programs will be deleted. We advise you to backup your files to an external hard drive, or CD / DVD disk before you start.

- ▶ Switch the notebook on.
- ↳ The following display briefly appears on the screen during start-up:
`<ESC>Diagnostic screen <F12>Boot Menu <F2>BIOS Setup`
- ▶ When this message appears, press the function key **F12**.
- ▶ Insert the "Windows Recovery CD" into the optical drive.
- ▶ Select *CD-ROM* and press the Enter key.
- ▶ Follow the instructions on the screen.
 After the installation you must install all the drivers again. Some installed hardware components will not be correctly supported until this has been done.
- ▶ Insert the "Drivers & Utilities" CD/DVD into the optical drive. The CD starts automatically.
- ▶ Click on the *Desk Update* button.
- ▶ Select *Automatic driver installation (Express)* and click on *Start installation*.
- ▶ Follow the instructions on the screen.
- ▶ Restart your notebook when the driver installation is completed.

The notebook's date or time is incorrect

Cause	Troubleshooting
Time and date are incorrect.	▶ With the <i>BIOS-Setup-Utility</i> , you can set the date and time in the <i>main</i> menu.
If the time and date are still set incorrectly after switching on the notebook.	▶ Please contact your sales outlet or our Hotline/Service Desk.

When certain characters are entered on the keyboard, only numerals are written

Cause	Troubleshooting
The virtual numeric keypad of your device is activated, see "Virtual numeric keypad", Page 24	▶ Press the [Num] key.

The notebook's LCD screen remains blank

Cause	Troubleshooting
Monitor is switched off.	▶ Press a key or touch the touchpad.
External monitor or television set connected.	▶ Press the key combination to switch the screen output, see "Key combinations", Page 25 .

The LCD screen is difficult to read

Cause	Troubleshooting
Reflected glare	<ul style="list-style-type: none"> ▶ Turn the notebook or alter the tilt of the LCD screen. ▶ Increase the brightness of the screen.

The external monitor remains blank

Cause	Troubleshooting
Monitor is switched off.	▶ Switch the external monitor on.
Power saving has been activated (monitor is blank).	▶ Press any key to continue.
Brightness is set to dark.	▶ Adjust the brightness of the monitor.
Screen output is set to the notebook's LCD screen	▶ Press the key combination to switch the screen output, see " Key combinations ", Page 25 .
The external monitor's power cable or data cable is not connected properly.	<ul style="list-style-type: none"> ▶ Switch off the external monitor and the notebook. ▶ Check whether the power cable is plugged properly into the external monitor and into the power socket. ▶ Check whether the data cable is properly connected to the notebook and the external monitor (if it is plugged in with a connector). ▶ Switch on the external monitor and the notebook.

The external monitor is blank or the image is unstable

Cause	Troubleshooting
The wrong external monitor has been selected or the wrong screen resolution has been set for the application program.	<ul style="list-style-type: none"> ▶ Terminate the application program in Windows by pressing Alt + F4. If the fault persists after closing the program, use the key combination for switching the screen output (see "Key combinations", Page 25) to switch over to the notebook's LCD screen. Change the following setting: <ul style="list-style-type: none"> ▶ Set the screen resolution: Set the screen resolution as described in the documentation for your operating system. ▶ Select monitor: Select monitor 1 or 2 as described in the documentation for your operating system.

The notebook cannot be started

Cause	Troubleshooting
The battery is not installed correctly.	<ul style="list-style-type: none"> ▶ Check whether the battery is installed correctly in its compartment. ▶ Switch the notebook on.
The battery is dead.	<ul style="list-style-type: none"> ▶ Charge the battery. <p>or</p> <ul style="list-style-type: none"> ▶ Insert a charged battery. <p>or</p> <ul style="list-style-type: none"> ▶ Connect the mains adapter to the notebook.
The power adapter is not connected correctly.	<ul style="list-style-type: none"> ▶ Check whether the mains adapter is connected correctly to the notebook. ▶ Switch the notebook on.

The notebook stops working

Cause	Troubleshooting
Notebook is in energy saving mode.	<ul style="list-style-type: none"> ▶ Leave energy saving mode.
An application programme has caused the malfunction.	<ul style="list-style-type: none"> ▶ Close the application program or restart the notebook (by restarting the operating system or switching the device off and back on again).
The battery is dead.	<ul style="list-style-type: none"> ▶ Charge the battery. <p>or</p> <ul style="list-style-type: none"> ▶ Insert a charged battery. <p>or</p> <ul style="list-style-type: none"> ▶ Connect the mains adapter to the notebook.

The printer does not print

Cause	Troubleshooting
The printer is not switched on.	<ul style="list-style-type: none"> ▶ Make sure that the printer is switched on and ready for operation (refer to the documentation supplied with the printer).
The printer is not connected correctly.	<ul style="list-style-type: none"> ▶ Check that the data cable connecting the notebook to the printer is properly connected.
The printer driver is faulty or not correctly installed, or it is the wrong printer driver.	<ul style="list-style-type: none"> ▶ Check that the data cable connecting the notebook to the printer is properly connected. ▶ Check whether the correct printer driver is loaded (refer to the printer documentation).

The radio connection to a network does not work

Cause	Troubleshooting
The wireless component is disabled.	<ul style="list-style-type: none"> ▶ Switch the radio component on (see "Switching the wireless components on and off", Page 42).
The wireless component is enabled. Despite this, the wireless connection to a network does not work.	<ul style="list-style-type: none"> ▶ Check whether the radio connection is switched on via the software. ▶ Further information on using the radio component can be found in the help files.

Acoustic warnings

Cause	Troubleshooting
<p>A beep sounds every few seconds.</p> <p>The battery is almost flat.</p>	<ul style="list-style-type: none"> ▶ Charge the battery.

Error messages on the screen

This section describes the error messages generated by the BIOS Setup. Error messages displayed by the operating system or programmes are described in the relevant documentation.



If the error message appears repeatedly, despite troubleshooting measures, please contact the place of purchase or our customer service centre.

Error message/cause	Resolution
<p><i>CMOS battery bad</i></p> <p>If the error message occurs repeatedly, the buffer battery in the notebook is flat.</p>	<ul style="list-style-type: none"> ▶ Contact your sales outlet or our customer service centre.
<p><i>System CMOS checksum bad - default configuration used</i></p> <p>The system configuration information is incorrect.</p>	<ul style="list-style-type: none"> ▶ Switch the notebook off. ▶ Switch the notebook on. ▶ Press the function key [F2] to access the <i>BIOS Setup</i>. ▶ In the <i>BIOS Setup</i>, select the <i>Exit</i> menu. ▶ Select the entry <i>Load Setup Defaults</i>. ▶ Select <i>OK</i> and press the Enter key.
<p><i>Extended memory failed at offset: xxxx Failing Bits: zzzz zzzz</i></p> <p>When testing the extended memory an error has resulted at the address xxxx.</p>	<ul style="list-style-type: none"> ▶ Check whether the additional memory module has been inserted correctly.
<p><i>Failure Fixed Disk n</i></p> <p>The settings of the hard disk drive are incorrect.</p>	<ul style="list-style-type: none"> ▶ Start the <i>BIOS Setup (Primary Master submenu)</i> and select the correct settings.
<p><i>Keyboard controller error</i></p>	<ul style="list-style-type: none"> ▶ Switch the notebook off with the ON/OFF switch. ▶ Wait 3 - 5 seconds and switch on the notebook again.
<p><i>Keyboard error</i></p>	<p>If you are using an external keyboard:</p> <ul style="list-style-type: none"> ▶ Check the connection and reboot the notebook.
<p><i>nn Stuck key</i></p>	<ul style="list-style-type: none"> ▶ Make sure that no key is pressed.
<p><i>Operating system not found</i></p>	<ul style="list-style-type: none"> ▶ Check in the <i>BIOS Setup</i> whether your hard disk has been set correctly. ▶ Make sure that the operating system is installed on the corresponding drive.
<p><i>Press <F1> to resume, <F2> to SETUP</i></p> <p>This error message appears if an error occurs during the self-test before starting the operating system.</p>	<ul style="list-style-type: none"> ▶ Press the [F1] function key to start the operating system. ▶ Press the function key [F2] to access the <i>BIOS Setup</i>.

Error message/cause	Resolution
<i>Previous boot incomplete - Default configuration used</i> Due to an error during the previous system boot, default values were used for certain settings. Check the settings in the BIOS Setup.	▶ Press the F1 function key when prompted to do so.
<i>Real time clock error</i>	▶ Contact your sales outlet or our customer service centre.
<i>nnmK Shadow RAM failed at offset: xxxx Failing Bits: zzzz</i>	▶ Contact your sales outlet or our customer service centre.
<i>System battery is dead - Replace and run SETUP</i>	▶ Contact your sales outlet or our customer service centre.
<i>System cache error - Cache disabled</i>	▶ Contact your sales outlet or our customer service centre.
<i>System timer error</i>	▶ Contact your sales outlet or our customer service centre.

Technical data

LIFEBOOK

Ambient conditions	
Environment class 3K2	DIN IEC 721
Mechanical class 7M2	DIN IEC 721
Temperature:	
Operation	5 °C ... 35 °C
Transportation	-15 °C ... 60 °C
Dimensions	
Width x depth x height (front/back)	378 mm x 252 mm x 29.2 mm/35.7 mm (excl. rubber feet) or 38.8 mm (incl. rubber feet)
Weight (including 6-cell rechargeable battery)	Approx. 2.5 kg



The data sheet for the device provides further technical data. You will find the data sheet on your device or on the Internet at ["http://ts.fujitsu.com/support"](http://ts.fujitsu.com/support).

Rechargeable battery



You can find information on the batteries used in your device on the Internet at ["http://ts.fujitsu.com/support"](http://ts.fujitsu.com/support).

	6-cell rechargeable battery
Rated voltage	10.8 V
Rated capacity	4400 mAh (48 Wh)

Mains adapter 80 W

Primary

Rated voltage	100 V to 240 V (automatic)
Rated frequency	50 Hz to 60 Hz (automatic)

Secondary

Rated voltage	19 V
Max. rated current	4.22 A

An additional mains adapter or power cable can be ordered at any time.

Power adapter, 65 W

Primary

Rated voltage	100 V to 240 V (automatic)
Rated frequency	50 Hz to 60 Hz (automatic)

Secondary

Rated voltage	20 V
Max. rated current	3.25 A

An additional mains adapter or power cable can be ordered at any time.

Manufacturer's notes

Energy Star



Products which are Energy Star certificated and labelled always meet the full requirements of the standard when shipped. Please note that installation of after-market hardware and software, changes to the BIOS or to the power options may affect power consumption. The properties guaranteed by the Energy Star label can then no longer be guaranteed.



Devices which are certified according to the Energy Star environmental mark help to save money and reduce the emission of greenhouse gases.

Power Management settings on delivery:

- Monitor switched off after < 15 minutes of inactivity
- Automatic activation of energy saving mode (ACPI S3): < 30 minutes of inactivity

Detailed information about the requirements of the "Energy Star" environmental mark and the products which satisfy these requirements can be found on the Internet at ["https://www.energystar.gov/"](https://www.energystar.gov/).

Disposal and recycling

Information about this subject can be found on your notebook or on our Internet pages.

Declarations of Conformity

The "Declarations of Conformity" for the device can be found at our Internet address under: ["http://ts.fujitsu.com/ce"](http://ts.fujitsu.com/ce).

Fujitsu Technology Solutions hereby declares that your device is in compliance with the essential requirements and other relevant provisions of Directive 1999/5/EC.

CE marking



CE marking for devices with radio component

This equipment complies with the requirements of Directive 1999/5/EC of the European Parliament and Commission from 9 March, 1999 governing Radio and Telecommunications Equipment and mutual recognition of conformity.

This equipment can be used in the following countries:

Belgium	Bulgaria	Denmark	Germany
Estonia	Finland	France	Greece
UK	Ireland	Iceland	Italy
Latvia	Liechtenstein	Lithuania	Luxembourg
Malta	The Netherlands	Norway	Austria
Poland	Portugal	Rumania	Sweden
Switzerland	Slovakia	Slovenia	Spain
Czech Republic	Hungary	Cyprus	

Contact the corresponding government office in the respective country for current information on possible operating restrictions. If your country is not included in the list, then please contact the corresponding supervisory authority as to whether the use of this product is permitted in your country.

Regulatory notices



If there is no FCC logo and also no FCC ID on the device then this device is not approved by the Federal Communications Commission (FCC) of the USA. Although it is not explicitly forbidden to travel in the US trading area carrying this device, to avoid trouble at customs clearance, Fujitsu Technology Solutions GmbH recommends not to bring this device into the US trading area.

Regulatory information for notebooks without radio device

NOTICE:

Changes or modifications not expressly approved by Fujitsu Technology Solutions could void this user's authority to operate the equipment.

Notice to Users of Radios and Television

These limits are designed to provide reasonable protection against harmful interference in a residential installation. This equipment generates, uses, and can radiate radio frequency energy and, if not installed and used in accordance with the instructions, may cause harmful interference to radio communications. However, there is no guarantee that interference will not occur in a particular installation. If this equipment does cause harmful interference to radio or television reception, which can be determined by turning the equipment off and on, the user is encouraged to try to correct the interference by one or more of the following measures:

- Reorient or relocate the receiving antenna.
- Increase the separation between the equipment and receiver.

- Connect the equipment into an outlet that is on a different circuit than the receiver.
- Consult the dealer or an experienced radio/TV technician for help.

Notice to Users of the US Telephone Network

Your notebook may be supplied with an internal modem which complies with Part 68 of the FCC rules. On this notebook is a label that contains the FCC Registration Number and the Ringer Equivalence Number (REN) for this equipment among other information. If requested, the user must provide their telephone company with the following information:

1. The telephone number to which the notebook is connected.
2. The Ringer Equivalence Number (REN) for this equipment.
3. The equipment requires a standard modular jack type USOC RJ-11C which is FCC Part 68 compliant.
4. The FCC Registration Number.

This equipment is designed to be connected to the telephone network or premises wiring using a standard modular jack type USOC RJ-11C which is FCC Part 68 compliant and a line cord between the modem and the telephone network with a minimum of 26AWG.

The REN is used to determine the number of devices that you may connect to your telephone line and still have all of those devices ring when your number is called. Too many devices on one line may result in failure to ring in response to an incoming call. In most, but not all, areas the sum of the RENs of all of the devices should not exceed five (5). To be certain of the number of devices you may connect to your line, as determined by the RENs, contact your local telephone company. If this equipment causes harm to the telephone network, your telephone company may discontinue your service temporarily. If possible, they will notify you in advance. If advance notice is not practical they will notify you as soon as possible. You will also be advised of your right to file a complaint with the FCC.

This fax modem also complies with fax branding requirements per FCC Part 68.

Your telephone company will probably ask you to disconnect this equipment from the telephone network until the problem is corrected and you are sure that the equipment is not malfunctioning. This equipment may not be used on coin-operated telephones provided by your telephone company. Connection to party lines is subject to state tariffs. Contact your state's public utility commission, public service commission or corporation commission for more information.

This equipment includes automatic dialing capability. When programming and/or making test calls to emergency numbers:

- Remain on the line and briefly explain to the dispatcher the reason for the call.
- Perform such activities in off-peak hours, such as early morning or late evening.

FCC rules prohibit the use of non-hearing aid compatible telephones in the following locations or applications:

- All public or semi-public coin-operated or credit card telephones.
- Elevators, highways, tunnels (automobile, subway, railroad or pedestrian) where a person with impaired hearing might be isolated in an emergency.
- Places where telephones are specifically installed to alert emergency authorities such as fire, police or medical assistance personnel.
- Hospital rooms, residential health care facilities, convalescent homes and prisons.
- Hotel, motel or apartment lobbies.
- Stores where telephones are used by patrons to order merchandise.

- Public transportation terminals where telephones are used to call taxis or to reserve lodging or rental cars.
- In hotel and motel rooms as at least ten percent of the rooms must contain hearing aid-compatible telephones or jacks for plug-in hearing aid compatible telephones which will be provided to hearing impaired customers on request.

DOC (Industry CANADA) notices

Notice to Users of Radios and Television

This Class B digital apparatus meets all requirements of Canadian Interference-Causing Equipment Regulations.

CET appareil numérique de la class B respecte toutes les exigence du Règlement sur le matériel brouilleur du Canada.

Notice to Users of the Canadian Telephone Network

NOTICE:

This equipment meets the applicable Industry Canada Terminal Equipment Technical Specifications. This is confirmed by the registration number. The abbreviation, IC, before the registration number signifies that registration was performed based on a Declaration of Conformity indicating that Industry Canada technical specifications were met. It does not imply that Industry Canada approved the equipment. Before connecting this equipment to a telephone line the user should ensure that it is permissible to connect this equipment to the local telecommunication facilities. The user should be aware that compliance with the certification standards does not prevent service degradation in some situations.

Repairs to telecommunication equipment should be made by a Canadian authorised maintenance facility. Any repairs or alterations not expressly approved by Fujitsu or any equipment failures may give the telecommunication company cause to request the user to disconnect the equipment from the telephone line.

NOTICE:

The Ringer Equivalence Number (REN) for this terminal equipment is 0.0. The REN assigned to each terminal equipment provides an indication of the maximum number of terminals allowed to be connected to a telephone interface. The termination on an interface may consist of any combination of devices subject only to the requirement that the sum of the Ringer Equivalence Numbers of all the devices does not exceed five.



CAUTION:

For safety, users should ensure that the electrical ground of the power utility, the telephone lines and the metallic water pipes are connected together. Users should NOT attempt to make such connections themselves but should contact the appropriate electric inspection authority or electrician. This may be particularly important in rural areas.

Avis Aux Utilisateurs Du Réseau Téléphonique Canadien

AVIS : Le présent matériel est conforme aux spécifications techniques d'Industrie Canada applicables au matériel terminal. Cette conformité est confirmée par le numéro d'enregistrement. Le sigle IC, placé devant le numéro d'enregistrement, signifie que l'enregistrement s'est effectué conformément à une déclaration de conformité et indique que les spécifications techniques d'Industrie Canada ont été respectées. Il n'implique pas qu'Industrie Canada a approuvé le matériel.

Avant de connecter cet équipement à une ligne téléphonique, l'utilisateur doit vérifier s'il est permis de connecter cet équipement aux installations de télécommunications locales. L'utilisateur est averti que même la conformité aux normes de certification ne peut dans certains cas empêcher la dégradation du service.

Les réparations de l'équipement de télécommunications doivent être effectuées par un service de maintenance agréé au Canada. Toute réparation ou modification, qui n'est pas expressément approuvée par Fujitsu, ou toute défaillance de l'équipement peut entraîner la compagnie de télécommunications à exiger que l'utilisateur déconnecte l'équipement de la ligne téléphonique.

AVIS : L'indice d'équivalence de la sonnerie (IES) du présent matériel est de 0.0. L'IES assigné à chaque dispositif terminal indique le nombre maximal de terminaux qui peuvent être raccordés à une interface téléphonique. La terminaison d'une interface peut consister en une combinaison quelconque de dispositifs, à la seule condition que la somme d'indices d'équivalence de la sonnerie de tous les dispositifs n'excède pas 5.



AVERTISSEMENT:

Pour assurer la sécurité, les utilisateurs doivent vérifier que la prise de terre du service d'électricité, les lignes téléphoniques et les conduites d'eau métalliques sont connectées ensemble. Les utilisateurs NE doivent PAS tenter d'établir ces connexions eux-mêmes, mais doivent contacter les services d'inspection d'installations électriques appropriés ou un électricien. Ceci peut être particulièrement important en régions rurales.

UL Notice

This unit requires an AC adapter to operate. Only use a UL Listed Class 2 adapter. The correct output rating is indicated on the AC adapter label. Refer to the illustration below for the correct AC Adapter output polarity:



CAUTION:

To reduce the risk of fire, use only 26AWG or larger telecommunications line cord.

For Authorized Repair Technicians Only



CAUTION:

For continued protection against risk of fire, replace only with the same type and rating fuse.



WARNING:

Danger of explosion if Lithium (CMOS) battery is incorrectly replaced. Replace only with the same or equivalent type recommended by the manufacturer.

Dispose of used batteries according to the manufacturer's instructions.

FCC regulatory information for notebooks with radio device

Federal Communications Commission statement

This device complies with Part 15 of FCC Rules. Operation is subject to the following two conditions: (1) this device may not cause interference, and

(2) this device must accept any interference, including interference that may cause undesired operation of this device.

FCC Interference Statement

This equipment has been tested and found to comply with the limits for a Class B digital device, pursuant to Part 15 of the FCC Rules. These limits are designed to provide reasonable protection against harmful interference in a residential installation. This equipment generates, uses, and can radiate radio frequency energy. If not installed and used in accordance with the instructions, it may cause harmful interference to radio communications.

However, there is no guarantee that interference will not occur in a particular installation.

If this equipment does cause harmful interference to radio or television reception, which can be determined by turning the equipment off and on, the user is encouraged to try to correct the interference by one or more of the following measures:

1. Reorient or relocate the receiving antenna.
2. Increase the distance between the equipment and the receiver.
3. Connect the equipment to an outlet on a circuit different from the one the receiver is connected to.
4. Consult the dealer or an experienced radio/TV technician for help.

Please note the following regulatory information related to the optional radio device.

FCC Radio Frequency Exposure statement

This radio device has been evaluated under FCC Bulletin OET 65C and found compliant with the requirements as set forth in CFR 47 Sections 2.1091, 2.1093, and 15.247 (b) (4) addressing RF Exposure from radio frequency devices. The radiated output power of this radio device is far below the FCC radio frequency exposure limits. Nevertheless, this device shall be used in such a manner that the potential for human contact during normal operation is minimized. When using this device, a certain separation distance between antenna and nearby persons must be maintained to ensure RF exposure compliance. In order to comply with RF exposure limits established in the ANSI C95.1 standards, the distance between the antennas and the user should not be less than 20 cm (8 inches).

Regulatory Notes and Statements

Radio device, health and authorisation for use

Radio-frequency electromagnetic energy is emitted from the wireless devices. The energy levels of these emissions, however, are far much less than the electromagnetic energy emissions from wireless devices such as mobile phones. Radio devices are safe for use by consumers because they operate within the guidelines found in radio frequency safety standards and recommendations.

The use of the radio devices may be restricted in some situations or environments, such as:

- on board an airplane, or
- in an explosive environment, or
- in situations where the interference risk to other devices or services is perceived or identified as harmful.

In cases in which the policy regarding use of radio devices in specific environments is not clear (e.g., airports, hospitals, chemical/oil/gas industrial plants, private buildings), obtain authorization to use these devices prior to operating the equipment.

Regulatory Information/Disclaimers

Installation and use of this radio device must be in strict accordance with the instructions included in the user documentation provided with the product. Any changes or modifications made to this device that are not expressly approved by the manufacturer may void the user's authority to operate the equipment. The manufacturer is not responsible for any radio or television interference caused by unauthorized modification of this device, or the substitution or attachment of connecting cables and equipment other than those specified by the manufacturer. It is the responsibility of the user to correct any interference caused by such unauthorized modification, substitution or attachment. The manufacturer and its authorized resellers or distributors will assume no liability for any damage or violation of government regulations arising from failure to comply with these guidelines.

Export restrictions

This product or software contains encryption code which may not be exported or transferred from the US or Canada without an approved US Department of Commerce export license. This device complies with Part 15 of FCC Rules, as well as ICES 003 B / NMB 003 B. Operation is subject to the following two conditions:

- (1) this device may not cause harmful interference, and
- (2) this device must accept any interference received, including interference that may cause undesirable operation.

Modifications not expressly authorised by Fujitsu Technology Solutions may invalidate the user's right to operate this equipment.

Index

- A**
- A beep sounds every second 64
 - Acoustic error messages 67
 - Alt+Tab 26
 - Anti-theft protection 44
 - Audio devices, connecting 51
 - Audio ports 51
- B**
- Back tab 26
 - Backspace 23
 - Bass loudspeaker (subwoofer) 40
 - Battery
 - battery life 30
 - caring for and maintaining 31
 - charge level 31, 36
 - charging 31
 - self-discharge 31
 - storage 31
 - Battery indicator 20
 - Battery status indicator
 - see Battery indicator 20
 - Battery status meter 31
 - Battery symbol
 - see Battery indicator 20
 - BIOS Setup Utility
 - calling 60
 - exiting 61
 - operating 60
 - protecting with password 45
 - settings 60
 - Bluetooth
 - Switching the module off 42
 - Switching the module on 42
 - Bluetooth, safety notes 13
 - Board 52
 - Buffer battery, load 64
 - Buttons 22
- C**
- Caps Lock 23
 - indicator 20
 - CD/DVD indicator 34
 - CD/DVD:
 - manual emergency removal 35
 - CE marking 73
 - Charging capacity, battery 31
 - Cleaning 15
 - Components
 - installing / removing 52
 - Configuration, BIOS Setup Utility 60
 - Connecting audio devices 51
 - Connecting headphones 51
 - Crystal View display
 - cleaning 15
 - Ctrl+Alt+Del 26
 - Cursor control keys 23
 - Cursor keys 23
- D**
- Date is incorrect 64
 - Declaration of conformity 72
 - Device
 - setting up 17
 - Devices
 - connecting 48
 - disconnecting 48
 - DOC (INDUSTRY CANADA) NOTICES 75
 - Drive
 - indicator 20
- E**
- Emergency removal of data carrier 35
 - Energy
 - energy saving 13
 - Energy saving 13
 - Energy saving mode
 - leaving 66
 - Enter 23
 - Enter key 23
 - Error message:
 - on the screen 68
 - Error messages on the screen 68
 - Errors
 - Acoustic warnings 67
 - ESD 52
 - Ethernet LAN 43
 - ExpressCard 39
- F**
- Fault
 - correction 62
 - First-time setup 16
 - Fn key 23
 - Fn+F10 26
 - Fn+F3 25
 - Fn+F4 25
 - Fn+F5 25
 - Fn+F6 26

Fn+F7 26
Fn+F8 26
Fn+F9 26

G

Getting started 16

H

Handling
 data carriers 33
Hard disk:
 restoring the contents 63
Hardware configuration 60
HDMI port 49

I

Important notes 12
Incorrect date/time 64
Indicator
 Caps Lock 20
 drive 20
 Num Lock 20
Inserting
 a data carrier 34

K

Kensington MicroSaver 44
Key combinations 25
Keyboard 22
 cleaning 15

L

LCD screen
 cleaning 15
 decrease brightness 26
 difficult to read 64
 notes 29
 reflected glare 64
 remains blank 64
LCD screen is too dark 64
Life, battery 30
Line feed 23
Loudspeakers 40
 switch off 25
 switch on 25

M

Main memory

 see Adding memory 53
Mains adapter
 connecting 17
 setting up 17
Manual removal of data carrier 35
Mechanical backup 44
Memory card
 handling 37
 inserting 37
 removing 38
Memory expansion
 installing 55
 removing 54
Memory module
 important notes 53
 installing 55
 removing 54
Microphone 40
Microphone, connecting 51
Mobile operation 14
Monitor
 connecting 49
 drifting display 65
 remains blank 65
Monitor port
 see VGA connection socket 49

N

Notebook
 before you travel 14
 cannot be started 66
 cleaning 15
 stops working 66
 switching off 21
 transporting 14
 using 19
Notebook, operation 19
Notes 12
 boards 52
 cleaning 15
 disposal / recycling 72
 energy saving 13
 LCD screen 29
 Safety 12
 transport 14
Num Lock
 indicator 20, 24–25
Numeric keypad 22
 see Separate numeric keypad 25
 see Virtual numeric keypad 24

O

- Operating system
 - activating system protection 46
 - cancel system protection 46
 - protecting with password 46
- Operating system, restoring 63
- Optical drive 33

P

- Packaging 16
- Password
 - changing 46
 - entering 45
 - removing 46
- Password protection 45
- Password protection:
 - hard disk 47
- Peripheral devices
 - connecting 48
 - disconnecting 48
- Power
 - power consumption 36
 - power-management features 36
- Power indicator 20
- Preparing for operation 17
- Printer does not print 67

R

- Radio component:
 - safety notes 13
- Rechargeable battery 30
 - see Battery 30
- Regulatory information
 - notebooks with radio device 77
 - Notebooks without radio device 73
- Removing
 - a data carrier 34
- Removing memory
 - see Adding memory 53
- Return 23

S

- Safety notes 12
- Screen
 - no screen display 65
- Screen brightness
 - decrease 26
 - increase 26
- Screen port
 - see VGA connection socket 49
- Security functions 44
- Selecting a location 17

- Self-discharge, battery 31
- Separate numeric keypad 25
- Servicing 52
- Setup
 - see BIOS Setup Utility 60
- Shift 23
- Shift key 23
- Shift+Tab 26
- Slot
 - ExpressCard 39
 - Memory cards 37
- Standby indicator 20
- Start key 23
- Status indicators 19
- Summer time 64
- Supervisor password
 - changing 46
 - entering 45
 - removing 46
- Switching on
 - the notebook 21
- Switching on for the first time 18
- System configuration 60
- System expansion 53
 - see Adding memory 53
- System settings, BIOS Setup Utility 60

T

- Tab key 23
- Technical data 70
 - Mains adapter 70–71
 - notebook 70
- The radio connection to a network does
 - not work 67
- Time not correct 64
- Time, daylight savings 64
- Tips 62
- Toggle output screen 26
- Touchpad 25, 27
 - buttons 27
 - cleaning 15
 - dragging items 28
 - executing commands 28
 - moving the pointer 27
 - selecting an item 28
 - switch off 25
- Touchpad buttons 25
- Transport
 - Transport damage 16
- Transportation 14
- Travel, notebook 14
- Troubleshooting 62

U

- USB ports 50
- User password
 - changing 46
 - entering 45
 - removing 46
- Using a Kensington Lock 44

V

- VGA connection socket 49
- Virtual numeric keypad 24
- Volume
 - decrease 26
 - increase 26

- Volume control 40

W

- Webcam 30
- Wireless components
 - switch off 25
 - switch on 25
- Wireless LAN
 - Switching the module off 42
 - Switching the module on 42
- Wireless LAN:
 - safety notes 13