

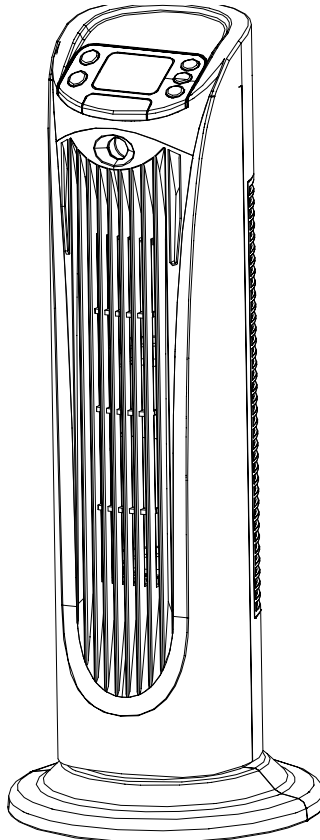

# Ceramic Tower Heater with Motion Sensor & Remote Control

**33554**

**Part# NTS**



## **INSTRUCTION MANUAL**

**Please Read And Save These Instructions**

# IMPORTANT SAFETY INSTRUCTIONS

*Please read these instructions carefully and keep for future reference.*

When using electrical appliances, basic precautions should always be followed to reduce the risk of fire, electric shock, and injury to persons, including the following:

1. This heater is hot when in use. To avoid burns, do not let bare skin touch hot surface. If provided, use handles when moving this heater. Keep combustible materials such as furniture, pillows, bedding, papers, clothes and curtains at least 3 feet (0.9m) from the front of the heater. Also, keep these materials away from the sides and rear of the heater.
2. Extreme caution is necessary when any heater is used by or near children or invalids, and whenever the heater is left operating unattended.
3. Always unplug the heater when not in use.
4. Do not operate the heater if the cord or plug is damaged or if the heater malfunctions, or has been dropped or damaged in any manner. Return heater to an authorized service facility for examination, electrical or mechanical adjustment, and repair.
5. Do not use outdoors.
6. This heater is not intended for use in bathroom, laundry areas and similar moist indoor locations. Never locate heater where it may fall into a bathtub or water container.
7. Do not run cord under carpeting. Do not cover cord with throw rugs, runners or anything similar. Arrange cord away from traffic areas where it will not be tripped over.
8. **CAUTION:** This appliance has a polarized plug (one blade is wider than the other). To reduce the risk of shock, this plug is intended to fit only one way in a polarized outlet. If the plug does not fit fully in the outlet, reverse the plug. If it still does not fit, contact a qualified electrician. **DO NOT** attempt to defeat this safety feature. To do so could result in an electric shock hazard.
9. This heater draws 12.5 amps during operation. To prevent overloading a circuit, do not plug the heater into a circuit that already has other appliances working.
10. **CAUTION:** It is normal for the plug to feel warm to the touch. However, a loose fit between the AC outlet (receptacle) and the plug may cause overheating, and may distort the plug. Contact a qualified electrician to replace loose or worn outlet.
11. To disconnect the heater, first turn controls to the OFF position, then grip the plug and pull it from the wall outlet. Never pull by the cord.
12. Do not insert or allow foreign objects to enter any ventilation or exhaust opening as this may cause an electric shock or fire, or damage the heater.
13. To prevent a possible fire, do not block air intakes or exhaust in any manner. Do not use on soft surface, like a bed, where openings may become blocked.
14. A heater has hot and sparking parts inside. Do not use it in areas where gasoline, paint, or flammable liquids are stored or nearby.

15. Use this heater only as described in this manual. Any other use not recommended by the manufacturer may cause fire, electric shock, or injury to persons.
16. **CAUTION:** Avoid the use of an extension cord because the extension cord may overheat and cause a fire. However, if you have to use an extension cord, it should be a minimum size of No.14 AWG, and rated not less than 1875 watts.
17. The output of this heater may vary and its temperature may become intense enough to burn exposed skin. Use of this heater is not recommended for persons with reduced sensitivity to heat or an inability to react to avoid burns.

**SAVE THESE IMPORTANT INSTRUCTIONS FOR EASY REFERENCE.**

## UNPACKING AND SET-UP ASSEMBLY

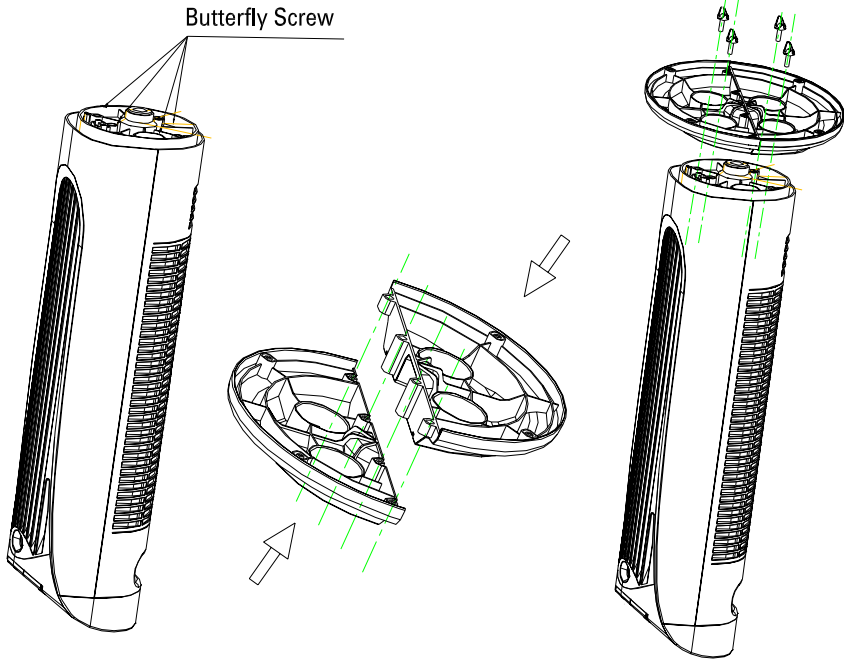

Unpack your heater and remove the two half bases from the package.

1. Make sure the heater is unplugged
2. **TURN THE HEATER UPSIDE DOWN.** Unfasten the four screws.
3. Position the two holes assemblies of the two half bases and fix them as shown.
4. Insert the butterfly screws and screw them tightly.
5. Turn the heater upright.

## ELECTRICAL RATINGS

This product is rated 12.5 amps (1500W) at 120V, 60 Hz.

## FEATURES

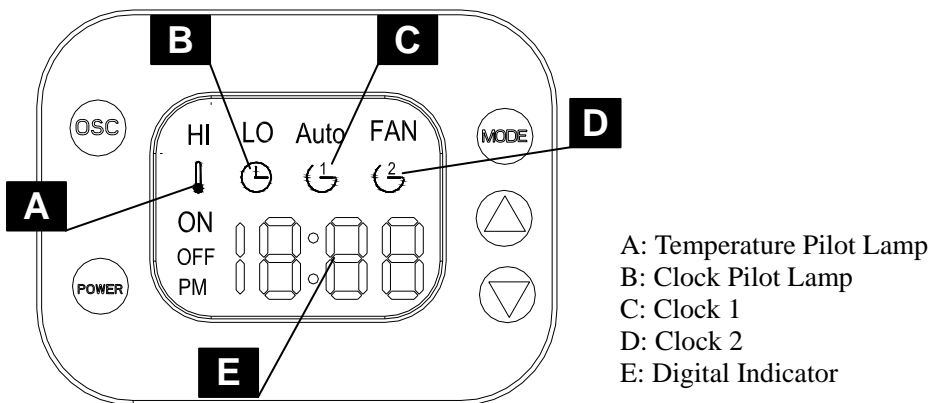

Tip-Over Switch - Shuts heater off automatically if unit tips over, Heater will resume once heater is properly oriented.

## OPERATION

### Turning the Unit On

- Place the heater on a firm level surface free from obstructions, and at least 3 ft. away from any wall and any other objects such as furniture, curtains, plants or combustible material.
- Plug the heater into a grounded 120V outlet. A buzzer will sound. The **thermal pilot lamp** lights up and the “E” Digital Screen indicates room temperature.
- Press the **POWER** button repeatedly to the desired setting. The cycle is as follows:
  - Hi** – Heater operates at a higher wattage.
  - Lo** – Heater operates at a lower wattage.
  - Auto** – Heater will function with the motion sensor, and will automatically stop heating within 10 minutes if there is no motion. When motion is detected, the heater will automatically begin heating again.
  - Fan** – Only the fan will operate, circulating cool air.
- **Note:** The fan speed will remain the same for the **Hi** and **Lo** settings.
- **MODE** Key: It is used to set temperature, clock and timer.

### Turning the Unit Off

- Press the **POWER** button to cycle through the functions until none of them are on (HI, LOW, AUTO, FAN).

**When then unit is turned off the fan will continue to run for 30 seconds to cool down.**

### Setting the Clock

To set or adjust the time while the unit is either **ON** or **OFF**.

- Press the **MODE** until you see the time with  flashing.
- Use the **▲** and **▼** arrows to set the desired hours.
- To change the minutes press **MODE** button and press the **▲** and **▼** arrows to the desired minutes.
- Press **MODE** to finish the setting.

**Note:** A lit Clock shows the current time.

### Setting the Thermostat

In order to set the thermostat the unit has to be on **Hi**, **Lo**, or **Auto**

- While the unit is on, toggle through the **MODE** until you see the temperature with  flashing.
- Use the **▲** and **▼** arrows to adjust to the desired temperature (40F – 95F). Press **MODE** to finalize.

**Note:** To change the temperature to Celsius press the **▲** and **▼** arrow simultaneously while the temperature display is showing.

The thermostat is in effect in modes: **Hi**, **Lo**, and **Auto** and will heat to the desired temperature setting.

A lit Thermometer shows the current temperature.

**Note:** Press both **▲** and **▼** synchronously can shift the temperature "C" and "F".

### Programming the Unit for Automatic Run Time (Setting the Timer)

In order to program the unit, it has to be on **Hi**, **Lo**, **Auto**, or **Fan**

Programming the unit will tell the heater when to turn **On** and **Off** at specific times set on the timer. The heater is able to set up to 2 different time periods.

Setting the Unit to turn on (Program 1)

- While the unit is **On**, press the **MODE** button until you see  and the word **ON** flashing
- Use the **▲** and **▼** arrows to set the hours.
- Press **MODE** button to set the minutes, use the **▲** and **▼** arrows.
- Press **MODE** to finalize.

Setting the Unit to turn off (Program 1)

- After setting the unit to turn on, the  and the word **OFF** will be flashing.
- Use the **▲** and **▼** arrows to set the hours.
- Press **MODE** once more to set the minutes using the **▲** and **▼** arrows.
- Press **MODE** to finish setting Program 1



Setting the Unit to turn on (Program 2)



- While the unit is On, press the **MODE** button until you see  and the word **ON** flashing.
- Use the **▲** and **▼** arrows to set the hours.
- Press **MODE** button to set the minutes, use the **▲** and **▼** arrows.  
Press **MODE** to finalize.

Setting the Unit to turn off (Program 2)

- After setting the unit to turn on,  and the word **OFF** will be flashing.
- Use the **▲** and **▼** arrows to set the hours.
- Press **MODE** once more to set the minutes using the **▲** and **▼** arrows.
- Press **MODE** to finish setting Program 2.

**Note:** Per program, the **On time** & the **Off time** must be set in order for the program to be effective.

A Lit  -  shows that the program has been set.

A Red  -  means that the program is in effect.

To check a program that's been set, repeat the steps above to show the flashing

 -  and it will show you the time that has been programmed.

To cancel a program, cycle through the functions by pressing **POWER** to turn off. Turn on again if needed.

## POWER/MODE Function Map

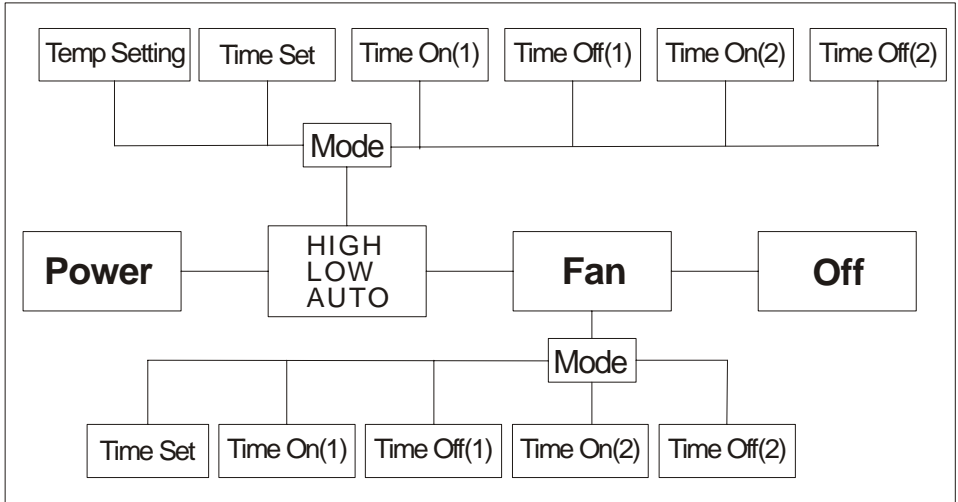

Press the **POWER/MODE** to cycle through the function list accordingly.

### Function Of Oscillation

When the heater is on and under operation, press the **OSC** key to run the oscillating motor.

### **Use Of The Remote Control:**

There are 5 keys on the remote control with the following functions:

1. **ON/OFF**: The on/off key is used to turn the heater **ON** (will turn on at HI) or **OFF**.
2. **POWER**: While the heater is ON, press the **POWER** key to select desired power settings.
3. **OSC**: For use to start oscillating function. Pressing once turns on the function, and pressing once again to disable it. (Note: This function can only be used when the heater is on.)
4. **UP "+"**: For use to adjust the set value of temperature
5. **DOWN "-"**: For use to adjust the set value of temperature, to decrease temperature.



Press the UP or DOWN key once to start the temperature value adjustment. The set temperature light will be flashing. Then, press the UP or DOWN key again to adjust to the desired temperature setting.

## RESET INSTRUCTIONS

- This heater is equipped with an overheating cut-off switch which will shut the unit off if the internal heating components overheat.

**Should the heater shutdown due to overheating, please follow these steps before reusing heater:**

- 1)TURN MODE TO OFF
- 2)UNPLUG UNIT WAIT 10 MINUTES
- 3)PLUG IN AND TURN ON

## ADDITIONAL FEATURES

- Washable Dust Filter
- Convenient Carry Handle

## TROUBLESHOOTING

**If your heater fails to operate, please follow these instructions:**

- Ensure that your circuit breaker or fuse is working properly.
- Be sure the heater is plugged in and that the electrical outlet is working properly.
- Check for any obstruction. If you find any obstruction, turn the heater " **OFF** ". Unplug the heater and wait a few minutes for it to cool down. Carefully remove the obstruction. Plug the heater in and turn it on again by referring to the **OPERATING INSTRUCTIONS**.

## CLEANING AND STORAGE

It is recommended that the heater be cleaned at least one time during the operating season in order to provide the optimum performance. **ALWAYS TURN THE POWER SWITCH OFF AND UNPLUG THE HEATER BEFORE CLEANING.** Be sure to save the box for off-season storage.

- Turn the heater " **OFF** ". Unplug the heater, and wait for it to cool down.
- Use a dry cloth to clean external surfaces only.
- Do not use any cleaning agents or detergents.



- Never immerse the heater in water.
- Pack the heater in the original carton and store it in a cool and dry place.

## **SPECIFICATIONS**

Model No.: 33554 (NTS)

Voltage: 120V, 60Hz

Current: Maximum continuous draw: 12.5 Amps.

Output: 5200 BTUs

Power: LOW = 900 Watts, HIGH = 1500 Watts

Tolerances on all specifications: Not exceeded 105%