

# Installation and Assembly: Metal Stud Wall Plate for FPS-1000 or SP850

**Models: WSP816,  
WSP816-W**

**IMPORTANT!** Read entire instruction sheet before you start installation and assembly.

## Parts List

Description	WSP816		WSP816-W
	Qty.	Part #	Part #
<b>A</b> 16" wall plate	1	024-1047	024-2047
<b>B</b> 1/4-20 x 1/2 phillips head screw	4	510-9108	510-9108
<b>C</b> 1/4" flat washer	10	540-9440	540-9440
<b>D</b> 1/4-20 x 2.5 phillips head screw	6	520-9522	520-9522
<b>E</b> toggler	6	590-1093	590-1093

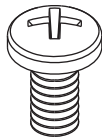
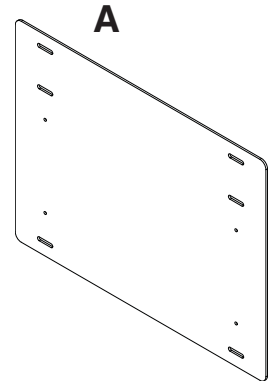

**B**

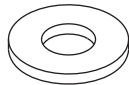

**C**

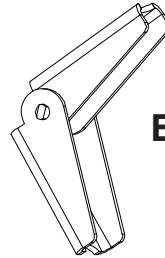

**E**

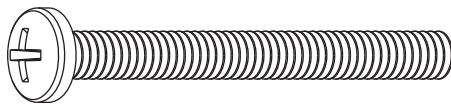

**D**

**Maximum Load Capacity: 150 lb (68 kg)**

- Use a stud finder to locate stud centers. Use wall plate (A) as a template to mark stud centers through slots. Drill 3/4" (19 mm) dia. holes through drywall and studs. Insert togglers (E) as shown below. Six 1/4-20 x 2.5" phillips screws (D) and six washers (C) are provided. Place screws (D) through wall plate (A). Partially fasten the toggler (E) to the back of the screw. Pivot ends of toggler (E) 90°.

## ⚠ WARNING

- Make sure that mounting screws are anchored into the center of the studs. The use of an "edge to edge" stud finder is highly recommended.

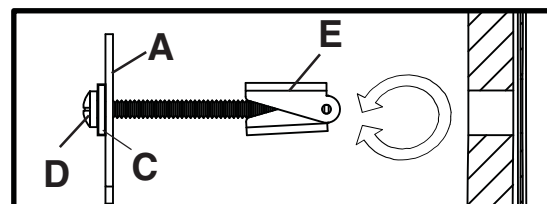
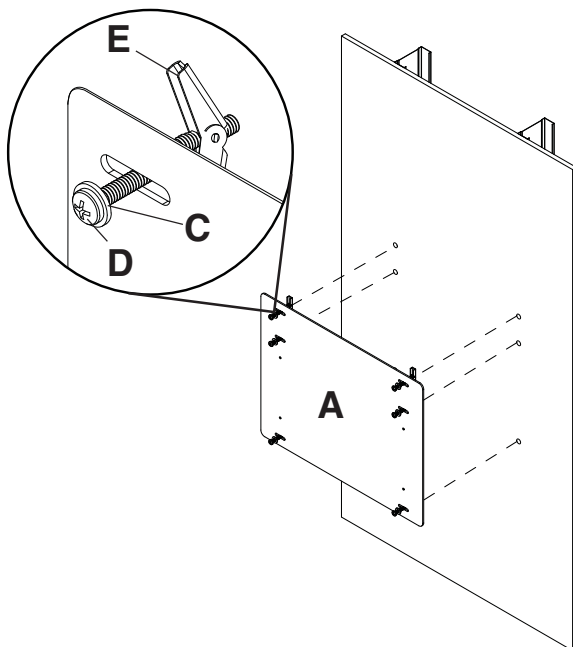

Push toggler (E) through hole.

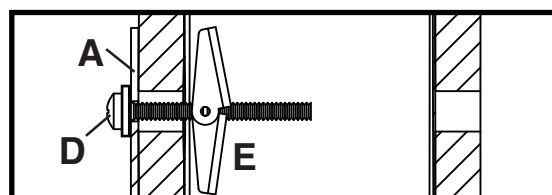
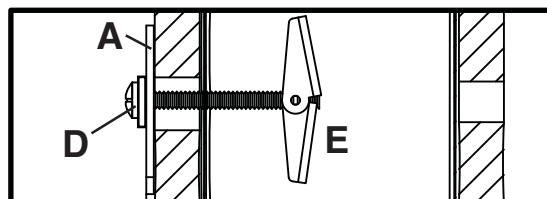

Pull screw (D) back until toggler (E) hits the inside of the metal stud. Fasten all six screws (D) tight, until wall plate (A) is flush with wall.

- 2** Secure FPS-1000, or SP850 to wall plate using four 1/4-20 x 1/2" phillips head screws (**B**) and 1/4" flat washers (**C**).

