

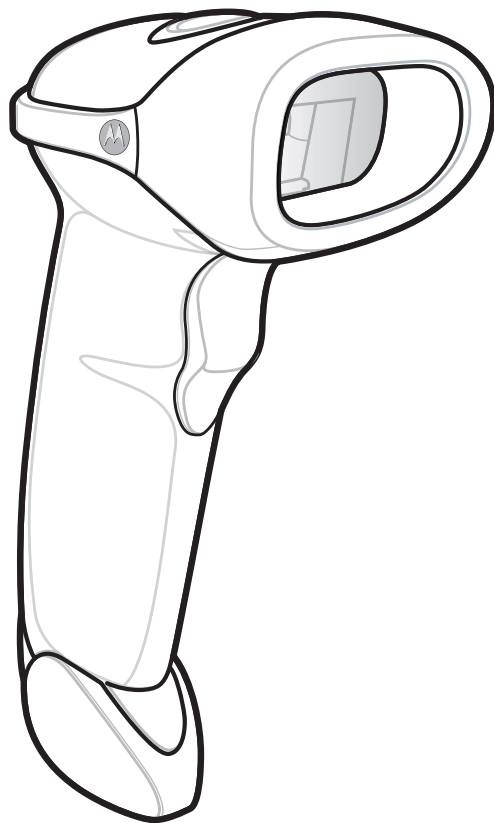

# Symbol LS2208

## Product Reference Guide





**Symbol LS2208**  
**Product Reference Guide**

72E-58808-07

Revision A

August 2010

© 2007-2010 by Motorola, Inc. All rights reserved.

No part of this publication may be reproduced or used in any form, or by any electrical or mechanical means, without permission in writing from Motorola. This includes electronic or mechanical means, such as photocopying, recording, or information storage and retrieval systems. The material in this manual is subject to change without notice.

The software is provided strictly on an “as is” basis. All software, including firmware, furnished to the user is on a licensed basis. Motorola grants to the user a non-transferable and non-exclusive license to use each software or firmware program delivered hereunder (licensed program). Except as noted below, such license may not be assigned, sublicensed, or otherwise transferred by the user without prior written consent of Motorola. No right to copy a licensed program in whole or in part is granted, except as permitted under copyright law. The user shall not modify, merge, or incorporate any form or portion of a licensed program with other program material, create a derivative work from a licensed program, or use a licensed program in a network without written permission from Motorola. The user agrees to maintain Motorola’s copyright notice on the licensed programs delivered hereunder, and to include the same on any authorized copies it makes, in whole or in part. The user agrees not to decompile, disassemble, decode, or reverse engineer any licensed program delivered to the user or any portion thereof.

Motorola reserves the right to make changes to any software or product to improve reliability, function, or design.

Motorola does not assume any product liability arising out of, or in connection with, the application or use of any product, circuit, or application described herein.

No license is granted, either expressly or by implication, estoppel, or otherwise under any Motorola, Inc., intellectual property rights. An implied license only exists for equipment, circuits, and subsystems contained in Motorola products.

MOTOROLA and the Stylized M Logo and Symbol and the Symbol logo are registered in the US Patent & Trademark Office. Bluetooth is a registered trademark of Bluetooth SIG. Microsoft, Windows and ActiveSync are either registered trademarks or trademarks of Microsoft Corporation. All other product or service names are the property of their respective owners.

Motorola, Inc.  
One Motorola Plaza  
Holtsville, New York 11742-1300  
<http://www.motorola.com>

---

## Warranty

For the complete Motorola hardware product warranty statement, go to:  
<http://www.motorola.com/enterprisemobility/warranty>.

## Revision History

Changes to the original manual are listed below:

Change	Date	Description
-01 Rev A	3/2003	Initial release.
-02 Rev A	10/2003	Updated with additional bar codes and various other changes.
-03 Rev A	1/2007	Updated service information, added parameter bar codes for Bookland ISBN, new UPC supplemental decode options, report software version, report MIMIC version, report Synapse cable, COM port, prefix/suffix value.
-04 Rev A	9/2007	Motorola rebranding, changed Set Length(s) for MSI parameter default to 4-55, changed RSS references to GS1 DataBar.
-05 Rev A	10/2007	Added bar codes for "Timeout Between Decodes" to User Preferences.
-06 Rev A	5/2008	Updated service information, removed IBM XT bar code and keyboard from Keyboard Wedge chapter, add French Belgian country codes, added note regarding Code ID and No Read, added Send Pause and Comma bar codes to ADF chapter.
-07 Rev A	7/2010	Corrected the Send Alt @ parameter number and added the Send Alt 2 parameter, updated the default interfaces to Keyboard Wedge and USB, removed patent and regulatory information, updated web addresses, Scan123 <sup>2</sup> chapter and Feedback chapter.



# Table of Contents

Warranty .....	ii
Revision History .....	iii

## About This Guide

Introduction .....	xiii
Chapter Descriptions .....	xiii
Notational Conventions .....	xiv
Related Documents .....	xv
Service Information .....	xv

## Chapter 1: Getting Started

Introduction .....	1-1
Unpacking Your Scanner .....	1-2
Setting Up the Scanner .....	1-3
Installing the Interface Cable .....	1-3
Connecting Power (if required) .....	1-4
Configuring Your Scanner .....	1-4
Connecting a Synapse Cable Interface .....	1-5
Removing the Interface Cable .....	1-5

## Chapter 2: Scanning

Introduction .....	2-1
Beeper Definitions .....	2-2
LED Definitions .....	2-3
Scanning in Hand-Held Mode .....	2-4
Aiming .....	2-5
Decode Zone .....	2-6

Scanning in Hands-Free Mode .....	2-7
Assembling the Stand .....	2-7
Mounting the Stand (optional) .....	2-8
Scanning in Hands-Free Mode .....	2-9
Scanning in the Hands-Free Mode .....	2-9

### Chapter 3: Maintenance and Technical Specifications

Introduction .....	3-1
Maintenance .....	3-1
Troubleshooting .....	3-2
Technical Specifications .....	3-4
Scanner Signal Descriptions .....	3-6

### Chapter 4: User Preferences

Introduction .....	4-1
Scanning Sequence Examples .....	4-1
Errors While Scanning .....	4-2
User Preferences Default Parameters .....	4-2
User Preferences .....	4-3
Set Default Parameter .....	4-3
Beeper Tone .....	4-4
Beeper Volume .....	4-5
Power Mode .....	4-6
Laser On Time .....	4-7
Beep After Good Decode .....	4-8
Timeout Between Decodes .....	4-9

### Chapter 5: Keyboard Wedge Interface

Introduction .....	5-1
Connecting a Keyboard Wedge Interface .....	5-2
Keyboard Wedge Default Parameters .....	5-3
Keyboard Wedge Host Types .....	5-4
Keyboard Wedge Host Types .....	5-4
Keyboard Wedge Country Types (Country Codes) .....	5-5
Ignore Unknown Characters .....	5-7
Keystroke Delay .....	5-8
Intra-Keystroke Delay .....	5-9
Alternate Numeric Keypad Emulation .....	5-9
Caps Lock On .....	5-10
Caps Lock Override .....	5-10
Convert Wedge Data .....	5-11
Function Key Mapping .....	5-12
FN1 Substitution .....	5-13
Send Make and Break .....	5-13
Keyboard Maps .....	5-14
ASCII Character Set .....	5-16



**Chapter 6: RS-232 Interface**

Introduction .....	6-1
Connecting an RS-232 Interface .....	6-2
RS-232 Default Parameters .....	6-3
RS-232 Host Parameters .....	6-4
RS-232 Host Types .....	6-6
Baud Rate .....	6-8
Parity .....	6-10
Stop Bit Select .....	6-12
Data Bits .....	6-12
Check Receive Errors .....	6-13
Hardware Handshaking .....	6-14
Software Handshaking .....	6-16
Host Serial Response Time-out .....	6-18
RTS Line State .....	6-19
Beep on <BEL> .....	6-19
Intercharacter Delay .....	6-20
Nixdorf Beep/LED Options .....	6-21
Ignore Unknown Characters .....	6-21
ASCII Character Set .....	6-22

**Chapter 7: USB Interface**

Introduction .....	7-1
Connecting a USB Interface .....	7-1
USB Default Parameters .....	7-3
USB Host Parameters .....	7-4
USB Device Type .....	7-4
USB Country Keyboard Types (Country Codes) .....	7-6
USB Keystroke Delay .....	7-9
USB CAPS Lock Override .....	7-10
USB Ignore Unknown Characters .....	7-11
Emulate Keypad .....	7-12
USB Keyboard FN 1 Substitution .....	7-12
Function Key Mapping .....	7-13
Simulated Caps Lock .....	7-13
Convert Case .....	7-14
ASCII Character Set .....	7-15

**Chapter 8: IBM 468X/469X Interface**

Introduction .....	8-1
Connecting to an IBM 468X/469X Host .....	8-2
IBM Default Parameters .....	8-3
IBM 468X/469X Host Parameters .....	8-4
Port Address .....	8-4
Convert Unknown to Code 39 .....	8-5

**Chapter 9: Wand Emulation Interface**

Introduction .....	9-1
Connecting Using Wand Emulation .....	9-2
Wand Emulation Default Parameters .....	9-3
Wand Emulation Host Parameters .....	9-4
Wand Emulation Host Types .....	9-4
Leading Margin (Quiet Zone) .....	9-5
Polarity .....	9-6
Ignore Unknown Characters .....	9-6
Convert All Bar Codes to Code 39 .....	9-7
Convert Code 39 to Full ASCII .....	9-7

**Chapter 10: Undecoded Scanner Emulation Interface**

Introduction .....	10-1
Connecting Using Undecoded Scanner Emulation .....	10-2
Undecoded Scanner Emulation Default Parameters .....	10-3
Undecoded Scanner Emulation Host .....	10-4
Undecoded Scanner Emulation Host Parameters .....	10-5
Beep Style .....	10-5
Parameter Pass-Through .....	10-6
Convert Newer Code Types .....	10-7
Module Width .....	10-7
Convert All Bar Codes to Code 39 .....	10-8
Code 39 Full ASCII Conversion .....	10-8
Transmission Timeout .....	10-9
Ignore Unknown Characters .....	10-10
Leading Margin .....	10-11
Check For Decode LED .....	10-12

**Chapter 11: 123Scan2**

Introduction .....	11-1
Communication with 123Scan2 .....	11-1
123Scan2 Requirements .....	11-1

**Chapter 12: Symbolologies**

Introduction .....	12-1
Scanning Sequence Examples .....	12-1
Errors While Scanning .....	12-1
Symbology Default Parameters .....	12-2
UPC/EAN .....	12-5
Enable/Disable UPC-A/UPC-E .....	12-5
Enable/Disable UPC-E1 .....	12-6
Enable/Disable EAN-13/EAN-8 .....	12-7
Enable/Disable Bookland EAN .....	12-8
Decode UPC/EAN/JAN Supplementals .....	12-9
User-Programmable Supplementals .....	12-12
UPC/EAN/JAN Supplemental Redundancy .....	12-12

Transmit UPC-A/UPC-E/UPC-E1 Check Digit .....	12-13
UPC-A Preamble .....	12-14
UPC-E Preamble .....	12-15
UPC-E1 Preamble .....	12-16
Convert UPC-E to UPC-A .....	12-17
Convert UPC-E1 to UPC-A .....	12-18
EAN-8/JAN-8 Extend .....	12-18
Bookland ISBN Format .....	12-19
UPC/EAN Security Level .....	12-20
UCC Coupon Extended Code .....	12-21
Code 128 .....	12-22
Enable/Disable Code 128 .....	12-22
Enable/Disable UCC/EAN-128 .....	12-22
Enable/Disable ISBT 128 .....	12-23
Code 39 .....	12-24
Enable/Disable Code 39 .....	12-24
Enable/Disable Trioptic Code 39 .....	12-24
Convert Code 39 to Code 32 .....	12-25
Code 32 Prefix .....	12-25
Set Lengths for Code 39 .....	12-26
Code 39 Check Digit Verification .....	12-27
Transmit Code 39 Check Digit .....	12-27
Code 39 Full ASCII Conversion .....	12-28
Code 39 Buffering (Scan & Store) .....	12-29
Code 93 .....	12-32
Enable/Disable Code 93 .....	12-32
Set Lengths for Code 93 .....	12-33
Code 11 .....	12-34
Code 11 .....	12-34
Set Lengths for Code 11 .....	12-35
Code 11 Check Digit Verification .....	12-36
Transmit Code 11 Check Digits .....	12-37
Interleaved 2 of 5 (ITF) .....	12-38
Enable/Disable Interleaved 2 of 5 .....	12-38
Set Lengths for Interleaved 2 of 5 .....	12-39
I 2 of 5 Check Digit Verification .....	12-40
Transmit I 2 of 5 Check Digit .....	12-41
Convert I 2 of 5 to EAN-13 .....	12-41
Discrete 2 of 5 (DTF) .....	12-42
Enable/Disable Discrete 2 of 5 .....	12-42
Set Lengths for Discrete 2 of 5 .....	12-43
Chinese 2 of 5 .....	12-44
Enable/Disable Chinese 2 of 5 .....	12-44
Codabar (NW - 7) .....	12-45
Enable/Disable Codabar .....	12-45
Set Lengths for Codabar .....	12-46
CLSI Editing .....	12-47
NOTIS Editing .....	12-47
MSI .....	12-48
Enable/Disable MSI .....	12-48

Set Lengths for MSI .....	12-49
MSI Check Digits .....	12-50
Transmit MSI Check Digit(s) .....	12-50
MSI Check Digit Algorithm .....	12-51
GS1 DataBar (Formerly RSS, Reduced Space Symbology) .....	12-52
GS1 DataBar .....	12-52
Convert GS1 DataBar to UPC/EAN .....	12-53
Redundancy Level .....	12-54
Redundancy Level 1 .....	12-54
Redundancy Level 2 .....	12-54
Redundancy Level 3 .....	12-55
Redundancy Level 4 .....	12-55
Security Level .....	12-56
Security Level 0 .....	12-56
Security Level 1 .....	12-56
Security Level 2 .....	12-56
Security Level 3 .....	12-57
Bi-directional Redundancy .....	12-58
Intercharacter Gap Size .....	12-58
Report Version .....	12-59
Report MIMIC Version .....	12-59
Report Synapse Cable .....	12-59

### Chapter 13: Miscellaneous Scanner Options

Introduction .....	13-1
Scanning Sequence Examples .....	13-2
Errors While Scanning .....	13-2
Miscellaneous Default Parameters .....	13-2
Miscellaneous Scanner Parameters .....	13-3
Transmit Code ID Character .....	13-3
Prefix/Suffix Values .....	13-4
Scan Data Transmission Format .....	13-4
FN1 Substitution Values .....	13-6
Transmit "No Read" Message .....	13-6
Synapse Interface .....	13-7

### Chapter 14: Advanced Data Formatting

Introduction .....	14-1
Rules: Criteria Linked to Actions .....	14-1
Using ADF Bar Codes .....	14-2
ADF Bar Code Menu Example .....	14-2
Rule 1: The Code 128 Scanning Rule .....	14-3
Rule 2: The UPC Scanning Rule .....	14-3
Alternate Rule Sets .....	14-3
Rules Hierarchy (in Bar Codes) .....	14-4
Default Rules .....	14-5
Special Commands .....	14-6
Pause Duration .....	14-6

Begin New Rule .....	14-6
Save Rule .....	14-6
Erase .....	14-7
Quit Entering Rules .....	14-7
Disable Rule Set .....	14-8
Criteria .....	14-9
Code Types .....	14-9
Code Lengths .....	14-12
Message Containing A Specific Data String .....	14-17
Actions .....	14-20
Send Data .....	14-20
Setup Field(s) .....	14-23
Modify Data .....	14-28
Pad Data with Spaces .....	14-29
Pad Data with Zeros .....	14-33
Beeps .....	14-37
Send Keystroke (Control Characters and Keyboard Characters) .....	14-38
Send Right Control Key .....	14-66
Send Graphic User Interface (GUI) Characters .....	14-67
Turn On/Off Rule Sets .....	14-72
Alphanumeric Keyboard .....	14-73

## Appendix A: Standard Default Parameters

## Appendix B: Programming Reference

Symbol Code Identifiers .....	B-1
AIM Code Identifiers .....	B-2

## Appendix C: Sample Bar Codes

Code 39 .....	C-1
UPC/EAN .....	C-1
UPC-A, 100 % .....	C-1
EAN-13, 100 % .....	C-2
Code 128 .....	C-2
Interleaved 2 of 5 .....	C-2
GS1 DataBar-14 .....	C-2

## Appendix D: Numeric Bar Codes

Numeric Bar Codes .....	D-1
0, 1, 2 .....	D-1
3, 4, 5, 6 .....	D-2
7, 8, 9 .....	D-3
Cancel .....	D-3

**Glossary**

**Index**

**Tell Us What You Think...**

# About This Guide

---

## Introduction

The *Symbol LS2208 Product Reference Guide* provides general instructions for setting up, operating, maintaining and troubleshooting the Symbol LS2208.

---

## Chapter Descriptions

Topics covered in this guide are as follows:

- [Chapter 1, Getting Started](#) provides a product overview and unpacking instructions.
- [Chapter 2, Scanning](#) describes parts of the scanner, beeper and LED definitions, and how to use the scanner in hand-held and hands-free modes.
- [Chapter 3, Maintenance and Technical Specifications](#) provides information on how to care for the scanner, troubleshooting, and technical specifications.
- [Chapter 4, User Preferences](#) provides programming bar codes for selecting user preference features for the scanner.
- [Chapter 5, Keyboard Wedge Interface](#) provides information for setting up the scanner for Keyboard Wedge operation.
- [Chapter 6, RS-232 Interface](#) provides information for setting up the scanner for RS-232 operation.
- [Chapter 7, USB Interface](#) provides information for setting up the scanner for USB operation.
- [Chapter 8, IBM 468X/469X Interface](#) provides information for setting up the scanner with IBM 468X/469X POS systems.
- [Chapter 9, Wand Emulation Interface](#) provides information for setting up the scanner for Wand emulation operation.
- [Chapter 10, Undecoded Scanner Emulation Interface](#) provides information for setting up the scanner for Undecoded Scanner emulation operation.
- [Chapter 11, 123Scan2](#) (PC based scanner configuration tool) provides the bar code to scan to communicate with the 123Scan<sup>2</sup> program.

- [Chapter 12, Symbologies](#) describes all symbology features and provides programming bar codes for selecting these features for the scanner.
- [Chapter 13, Miscellaneous Scanner Options](#) includes features frequently used to customize how data transmits to the host device.
- [Chapter 14, Advanced Data Formatting \(ADF\)](#) describes how to customize scanned data before transmitting to the host.
- [Appendix A, Standard Default Parameters](#) provides a table of all host devices and miscellaneous scanner defaults.
- [Appendix B, Programming Reference](#) provides a table of AIM code identifiers, ASCII character conversions, and keyboard maps.
- [Appendix C, Sample Bar Codes](#) includes sample bar codes of various code types.
- [Appendix D, Numeric Bar Codes](#) includes the numeric bar codes to scan for parameters requiring specific numeric values.

---

## Notational Conventions

The following conventions are used in this document:

- *Italics* are used to highlight chapters and sections in this and related documents
- **Bold** text is used to highlight parameter and bar code names
- Bullets (•) indicate:
  - Action items
  - Lists of alternatives
  - Lists of required steps that are not necessarily sequential
- Sequential lists (e.g., those that describe step-by-step procedures) appear as numbered lists.
- Throughout the programming bar code menus, asterisks (\*) are used to denote default parameter settings.

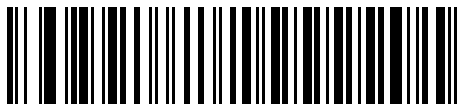

\* Indicates Default — **\*Baud Rate 9600** — Feature/Option



**NOTE** This symbol indicates something of special interest or importance to the reader. Failure to read the note will not result in physical harm to the reader, equipment or data.



**CAUTION** This symbol indicates that if this information is ignored, the possibility of data or material damage may occur.



**WARNING!** This symbol indicates that if this information is ignored the possibility that serious personal injury may occur.



---

## Related Documents

The *Symbol LS2208 Series Quick Reference Guide*, p/n 72-58807-xx, provides general information to help you get started with the scanner. It includes basic set-up and operation instructions.

For the latest version of this guide and all guides, go to: <http://www.motorola.com/enterprisemobility/manuals>.

---

## Service Information

If you have a problem with your equipment, contact Motorola Enterprise Mobility Support for your region. Contact information is available at: <http://www.motorola.com/enterprisemobility/support>.

When contacting Enterprise Mobility Support, please have the following information available:

- Serial number of the unit
- Model number or product name
- Software type and version number.

Motorola responds to calls by E-mail, telephone or fax within the time limits set forth in support agreements.

If your problem cannot be solved by Motorola Enterprise Mobility Support, you may need to return your equipment for servicing and will be given specific directions. Motorola is not responsible for any damages incurred during shipment if the approved shipping container is not used. Shipping the units improperly can possibly void the warranty.

If you purchased your Enterprise Mobility business product from a Motorola business partner, contact that business partner for support.



# Chapter 1 Getting Started

---

## Introduction

The Symbol LS2208 scanner combines excellent scanning performance and advanced ergonomics to provide the best value in a lightweight laser scanner. Whether used as a hand-held scanner or in hands-free mode in a stand, the scanner ensures comfort and ease of use for extended periods of time.

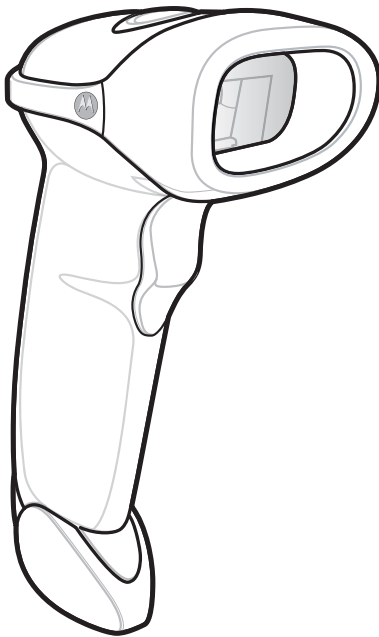

**Figure 1-1** *Symbol LS2208 Scanner*

The Symbol LS2208 scanner supports the following interfaces:

- Standard RS-232 connection to a host. Scan bar code menus to set up proper communication of the scanner with the host.
- Keyboard Wedge connection to a host. The host interprets scanned data as keystrokes.
- International Keyboards supported: North America, German, French, French International, Spanish, Italian, Swedish, British, Japanese, and Portuguese-Brazilian.
- Wand Emulation connection to a host. The scanner connects to a portable data terminal, a controller, or host which collects the data as wand data and decodes it.
- Undecoded Emulation connection to a host. The scanner connects to a portable data terminal, and a controller which collects the data and interprets it for the host.
- Connection to IBM 468X/469X hosts. Scan bar code menus to set up proper communication of the scanner with the IBM terminal.
- USB connection to a host. The scanner autodetects a USB host and defaults to the HID keyboard interface type. Scan programming bar codes to select other USB interface types.
- International Keyboards supported (for Windows™ environment): North America, German, French, French International, Spanish, Italian, Swedish, British, Portuguese-Brazilian, and Japanese.
- Synapse capability. Enables connection to a wide variety of host systems using a Synapse and Synapse adapter cable. The scanner autodetects Synapse.
- Configuration via 123Scan<sup>2</sup>.

---

## Unpacking Your Scanner

Remove the scanner from its packing and inspect it for damage. If the scanner was damaged in transit, contact Motorola Enterprise Mobility Support. See [page xv](#) for contact information. **KEEP THE PACKING.** It is the approved shipping container and should be used if you ever need to return your equipment for servicing.

---

## Setting Up the Scanner

### Installing the Interface Cable

1. Plug the interface cable modular connector into the cable interface port on the bottom of the scanner handle. (See [Figure 1-2](#).)
2. Gently tug the cable to ensure the connector is properly secured.
3. Connect the other end of the interface cable to the host (see the specific host chapter for information on host connections).

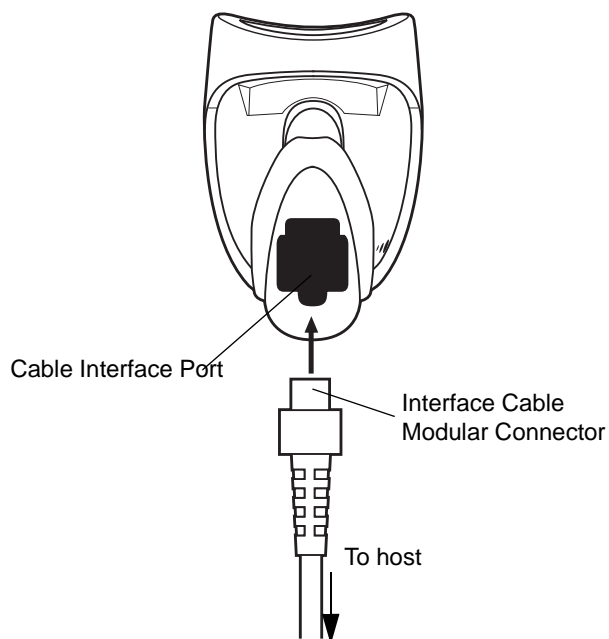

**Figure 1-2** *Installing the Cable*



**NOTE** Different hosts require different cables. The connectors illustrated in each host chapter are examples only. Your connectors may be different than those illustrated, but the steps to connect the scanner are the same.

## Connecting Power (if required)

If the host does not provide power to the scanner, use an external power connection to the scanner:

1. Connect the interface cable to the bottom of the scanner, as described in *Installing the Interface Cable on page 1-3*.
2. Connect the other end of the interface cable to the host (refer to the host manual to locate the correct port).
3. Plug the power supply into the power jack on the interface cable. Plug the other end of the power supply into an AC outlet.

## Configuring Your Scanner

To configure the scanner, use the bar codes included in this manual, or the 123Scan<sup>2</sup> configuration program.

See [Chapter 4, User Preferences](#) for information about programming the scanner using bar code menus. See [Chapter 11, 123Scan<sup>2</sup>](#) to configure the scanner using this configuration program. 123Scan<sup>2</sup> includes a help file.

The scanner supports RS-232, IBM 468X/469X, Keyboard Wedge, Wand Emulation, Undecoded Scanner Emulation, USB, and Synapse to interface to a host system. Each host specific chapter describes how to set up each of these connections.

## Connecting a Synapse Cable Interface

✓ **NOTE** See the *Synapse Interface Guide* provided with the Synapse cable for detailed setup instructions.

Symbol's Synapse Smart Cables enable interfacing to a variety of hosts. The appropriate Synapse cable has the built-in intelligence to detect the host to which it is connected.

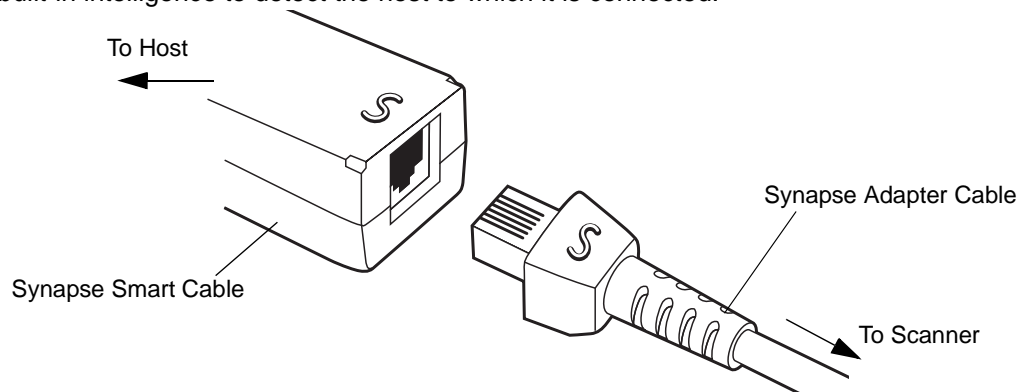

**Figure 1-3** Synapse Cable Connection

1. Plug the Synapse adapter cable (p/n 25-32463-xx) into the bottom of the scanner, as described in [Installing the Interface Cable on page 1-3](#).
2. Align the 'S' on the Synapse adapter cable with the 'S' on the Synapse Smart Cable and plug the cable in.
3. Connect the other end of the Synapse Smart Cable to the host.

## Removing the Interface Cable

To remove the interface cable:

1. Unplug the installed cable's modular connector by depressing the connector clip with the tip of a screwdriver.
2. Carefully slide out the cable.
3. Follow the steps for [Installing the Interface Cable on page 1-3](#) to connect a new cable.





# Chapter 2 Scanning

---

## Introduction

This chapter includes the techniques involved in scanning bar codes, beeper and LED definitions, and general instructions and tips about scanning.



**Figure 2-1** *Scanner Parts*

## Beeper Definitions

The scanner communicates by emitting different beeper sequences and patterns. [Table 2-1](#) defines beep sequences that occur during both normal scanning and while programming the scanner.

**Table 2-1** Standard Beeper Definitions

Beeper Sequence	Indication
<b>Standard Use</b>	
Low/medium/high beep	Power up.
Short high beep	A bar code symbol was decoded (if decode beeper is enabled).
4 long low beeps	A transmission error was detected in a scanned symbol. The data is ignored. This occurs if a unit is not properly configured. Check option setting.
5 low beeps	Conversion or format error.
Lo/hi/lo beep	ADF transmit error.
Hi/hi/hi/lo beep	RS-232 receive error.
<b>Parameter Menu Scanning</b>	
Short high beep	Correct entry scanned or correct menu sequence performed.
Lo/hi beep	Input error, incorrect bar code or "Cancel" scanned, wrong entry, incorrect bar code programming sequence; remain in program mode.
Hi/lo beep	Keyboard parameter selected. Enter value using bar code keypad.
Hi/lo/hi/lo beep	Successful program exit with change in the parameter setting.
Low/hi/low/hi beep	Out of host parameter storage space. Scan <i>Set Default Parameter</i> on page 4-3.
<b>Code 39 Buffering</b>	
Hi/lo beep	New Code 39 data was entered into the buffer.
3 Beeps - long high beep	Code 39 buffer is full.
Lo/hi/lo beep	The Code 39 buffer was erased or there was an attempt to clear or transmit an empty buffer.
Lo/hi beep	A successful transmission of buffered data.

**Table 2-1** Standard Beeper Definitions (Continued)

Beeper Sequence	Indication
<b>Host Specific</b>	
<b>USB only</b>	
4 short high beeps	Scanner has not completed initialization. Wait several seconds and scan again.
Scanner gives a power-up beep after scanning a USB Device Type.	Communication with the bus must be established before the scanner can operate at the highest power level.
This power-up beep occurs more than once.	The USB bus may put the scanner in a state where power to the scanner is cycled on and off more than once. This is normal and usually happens when the PC cold boots.
<b>RS-232 only</b>	
1 short high beep	A <BEL> character is received and Beep on <BEL> is enabled.

## LED Definitions

In addition to beeper sequences, the scanner communicates using a two-color LED display. [Table 2-2](#) defines LED colors that display during scanning.

**Table 2-2** Standard LED Definitions

LED	Indication
Off	No power is applied to the scanner, or the scanner is on and ready to scan.
Green	A bar code was successfully decoded.
Red	A data transmission error or scanner malfunction occurred.

## Scanning in Hand-Held Mode

Install and program the scanner. See each host chapter and [Chapter 4, User Preferences](#), [Chapter 12, Symbologies](#), [Chapter 13, Miscellaneous Scanner Options](#), and [Chapter 14, Advanced Data Formatting](#) for programming instructions. For assistance, contact your local supplier or Motorola Enterprise Mobility Support.

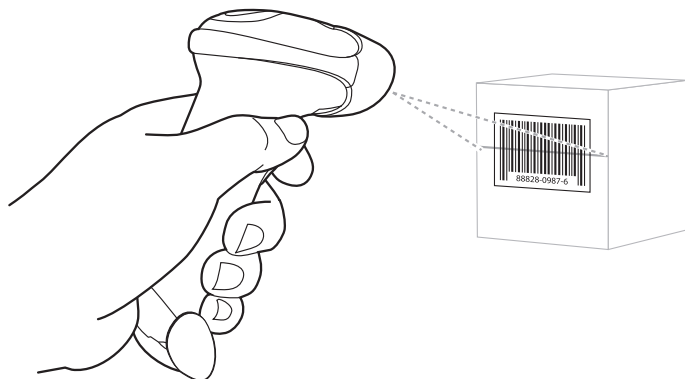

**Figure 2-2** Scanning in Hand-Held Mode

1. Ensure all connections are secure. See the host chapter for your host.
2. Aim the scanner at the bar code. Press the trigger.
3. Ensure the scan line crosses every bar and space of the symbol.

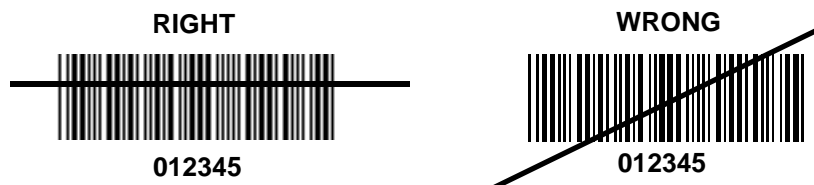

4. Upon successful decode, the scanner beeps and the LED turns green. For more information on beeper and LED definitions, see [Table 2-1](#) and [Table 2-2](#).

---

## Aiming

Do not hold the scanner directly over the bar code. Laser light reflecting *directly* back into the scanner from the bar code is known as specular reflection. This specular reflection can make decoding difficult.

You can tilt the scanner up to 55° forward or back and achieve a successful decode ([Figure 2-3](#)). Simple practice quickly shows what tolerances to work within.

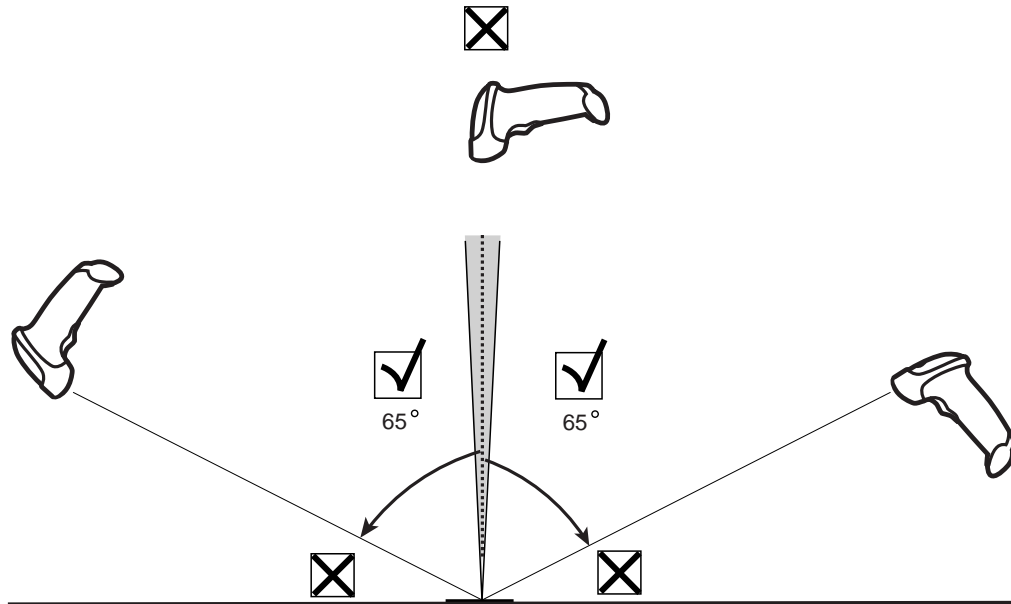

**Figure 2-3** Maximum Tilt Angles and Dead Zone

## Decode Zone

Note: Typical performance at 73° F (23° C) on high quality symbols in normal room light.

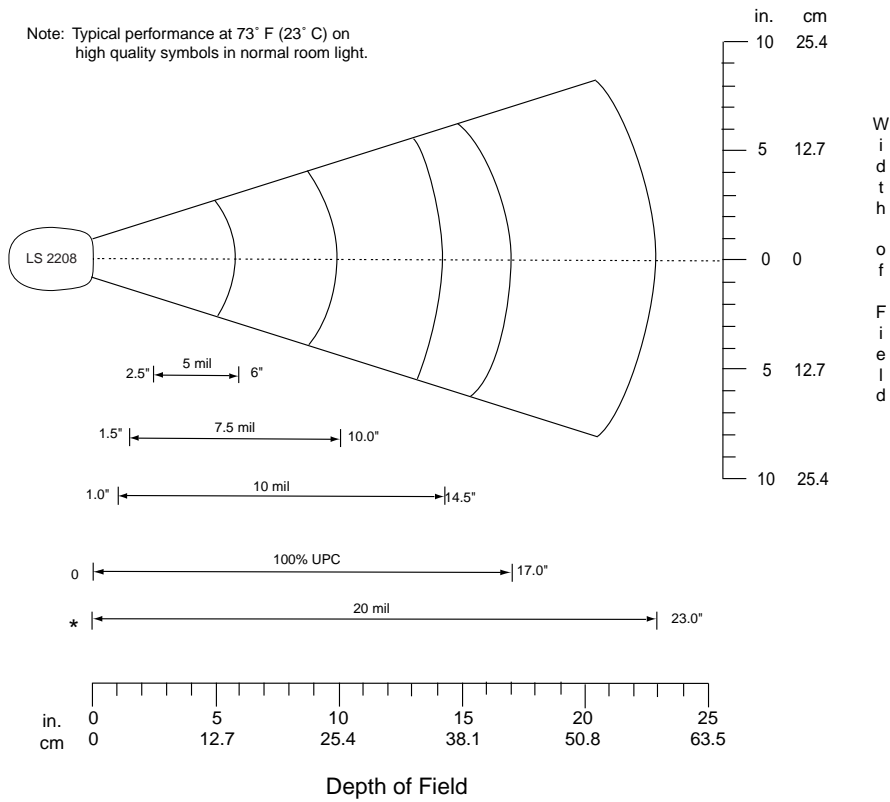

\*Minimum distance determined by symbol length and scan angle

Figure 2-4 Symbol LS2208 Decode Zone

## Scanning in Hands-Free Mode

The Symbol LS2208 Intellistand adds greater flexibility to scanning operation. See [Assembling the Stand](#), [Mounting the Stand \(optional\)](#), and [Scanning in the Hands-Free Mode](#) for more information about hands-free scanning.

### Assembling the Stand

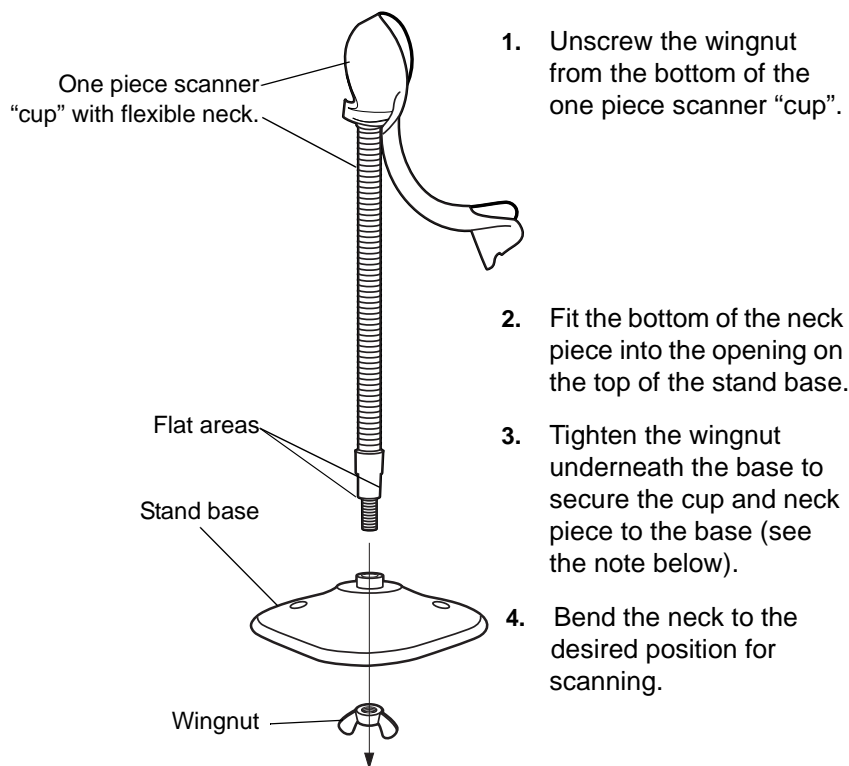

**Figure 2-5** *Assembling the Stand*



**NOTE** Before tightening the wingnut under the base, ensure that the flat areas on the flexible neck fit securely in the grooves in the base.

## Mounting the Stand (optional)

You can attach the base of the scanner's stand to a flat surface using two screws or double-sided tape (not provided).

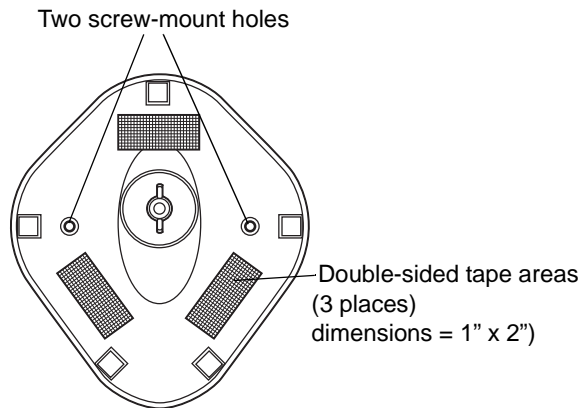

**Figure 2-6** *Mounting the Stand*

### Screw Mount

1. Position the assembled base on a flat surface.
2. Screw one #10 wood screw into each screw-mount hole until the base of the stand is secure (see [Figure 2-6](#)).

### Tape Mount

1. Peel the paper liner off one side of each piece of tape and place the sticky surface over each of the three rectangular tape holders.
2. Peel the paper liner off the exposed sides of each piece of tape and press the stand on a flat surface until it is secure (see [Figure 2-6](#)).



---

## Scanning in Hands-Free Mode

The optional Intellistand adds greater flexibility to scanning operation.

### Scanning in the Hands-Free Mode

When the scanner is seated in the stand's "cup", the scanner's built-in sensor places the scanner in hands-free mode. When you remove the scanner from the stand it operates in its normal hand-held mode.

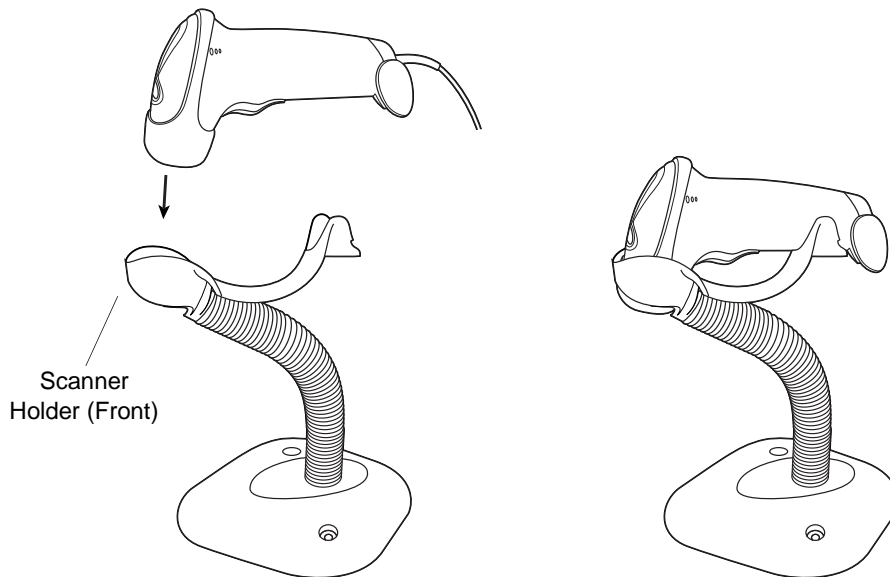

**Figure 2-7** *Inserting and Using the Scanner in the Stand*

Intellistand operation:

1. Ensure all cable connections are secure.
2. Insert the scanner in the optional Intellistand by placing the front of the scanner into the stand's "cup" (see [Figure 2-7](#)).
3. To scan a bar code, present the bar code and ensure the scan line crosses every bar and space of the symbol.
4. Upon successful decode, the scanner beeps and the LED turns green.



# Chapter 3 Maintenance and Technical Specifications

---

## Introduction

This chapter includes suggested scanner maintenance, troubleshooting, technical specifications, and signal descriptions (pinouts).

---

## Maintenance

Cleaning the exit window is the only maintenance required. A dirty window can affect scanning accuracy.

- Do not allow any abrasive material to touch the window
- Remove any dirt particles with a damp cloth
- Wipe the window using a tissue moistened with ammonia/water
- Do not spray water or other cleaning liquids directly into the window.

## Troubleshooting

**Table 3-1** *Troubleshooting*

Problem	Possible Causes	Possible Solutions
Nothing happens when you follow the operating instructions, or the scanner displays erratic behavior (laser does not come on, scanner emits frequent beeps).	No power to the scanner.	Check the system power. Ensure the power supply is connected if your configuration requires a power supply.
	Interface/power cables are loose.	Check for loose cable connections.
Laser comes on, but symbol does not decode.	Scanner is not programmed for the correct bar code type.	Be sure the scanner is programmed to read the type of bar code you are scanning.
	Bar code symbol is unreadable.	Check the symbol to make sure it is not defaced. Try scanning test symbols of the same bar code type.
	Distance between scanner and bar code is incorrect.	Move the scanner closer to or further from the bar code.
Symbol is decoded, but not transmitted to the host.	Scanner is not programmed for the correct host type.	Scan the appropriate host type bar code.

**Table 3-1** *Troubleshooting (continued)*

Problem	Possible Causes	Possible Solutions
Scanned data is incorrectly displayed on the host.	Scanner is not programmed to work with the host. Check scanner host type parameters or editing options.	<p>Be sure proper host is selected. (See the host chapter for your scanner.)</p> <p>For RS-232, ensure the scanner's communication parameters match the host's settings.</p> <p>For a USB HID keyboard or a keyboard wedge configuration, ensure the system is programmed for the correct keyboard type and language, and the CAPS LOCK key is in the correct state.</p> <p>Be sure editing options (e.g., ADF, UPC-E to UPC-A Conversion) are properly programmed.</p>



**NOTE** If after performing these checks the symbol still does not scan, contact your distributor or Motorola Enterprise Mobility Support. See [page xv](#) for contact information.

## Technical Specifications

**Table 3-2** *Technical Specifications*

Item	Description
Power Requirements	Use only a Symbol-approved power supply (p/n 50-14000-253R, 50-14000-256R, 50-14000-257R, 50-14000-258R or 50-14000-259R) output rated 5 VDVC and minimum 650mA. The power supply is certified to EN60950 with SELV outputs. Use of alternative power supply will invalidate any approval given to this device and may be dangerous.
Stand-By Current	500mA (max)
Power Source	Depending on host: <ul style="list-style-type: none"> <li>• Host powered</li> <li>• External power supply</li> <li>• Battery box: Converts a 9 Volt battery to a 5 Volt battery</li> </ul>
Decode Capability	Decoded: UPC/EAN, UPC/EAN with supplementals, UCC/EAN, JAN 8 & 13, 128, Code 39, Code 39 Full ASCII, Code 39 Trioptic, Codabar (NW7), Interleaved 2 of 5, Discrete 2 of 5, Code 128, Code 93, MSI, Code 11, UCC/EAN, GS1 DataBar, Code 32, Coupon Code, Bookland EAN, IATA.
Beeper Operation	User-selectable: Enable, Disable
Beeper Volume	User-selectable: three levels
Beeper Tone	User-selectable: three tones
Scan Repetition Rate	100 ± 5 scans/second
Yaw Tolerance	± 10° from nominal
Pitch Tolerance	± 65° from nominal
Roll Tolerance	± 60° from nominal
Print Contrast Minimum	25% minimum reflectance differential, measured at 650 nm.
Ambient Light Immunity Indoor: Outdoor:	450 Ft Candles (4,842 Lux) (indoor) 10,000 Ft Candles (107,600 Lux) (outdoor)
Durability	5 ft (1.5 m) drops to concrete
Operating Temperature	32° to 120° F (0° to 50° C)
Storage Temperature	-40° to 140° F (-40° to 60° C)
Humidity	5% to 95% (non-condensing)
Weight (without cable)	5.15 oz. (146 g)

**Table 3-2** *Technical Specifications (continued)*

Item	Description
Dimensions: Height Width Depth	6.0 in. (15.2 cm) 2.5in. (6.3 cm) 3.34 in. (8.4 cm)
Laser	650nm laser diode
ESD	15 kV area discharge 8 kV contact discharge
Minimum Element Width	5 mil (0.127 mm)
Interfaces Supported	Decoded: RS-232, Keyboard Wedge, Wand Emulation, Undecoded Scanner Emulation, IBM 468X/469X, USB, Synapse

## Scanner Signal Descriptions

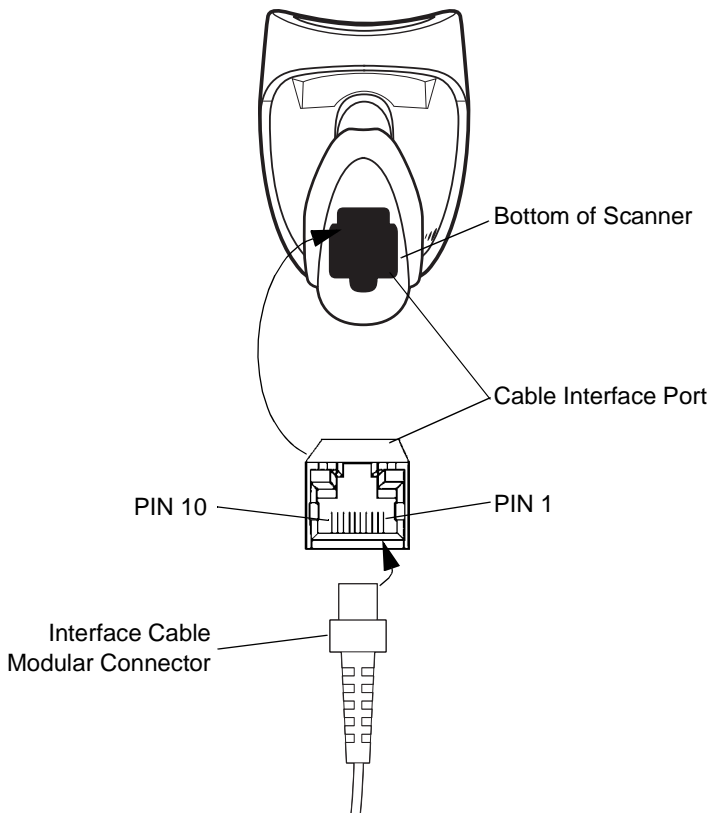

**Figure 3-1** Scanner Cable Pinouts







# Chapter 4 User Preferences

---

## Introduction

You can program the Symbol LS2208 scanner to perform various functions, or activate different features. This chapter describes each user preference feature and provides programming bar codes for selecting these features for the Symbol LS2208 scanner.

The Symbol LS2208 ships with the settings shown in the *User Preferences Default Table on page 4-2* (also see [Appendix A, Standard Default Parameters](#) for all host device and miscellaneous scanner defaults). If the default values suit requirements, programming is not necessary.

Set feature values by scanning single bar codes or short bar code sequences. The settings are stored in non-volatile memory and are preserved even when the scanner is powered down.

If you are not using a Keyboard Wedge or USB cable you must select a host type (see each host chapter for specific host information). After the power-up beeps sound, select a host type. You only need to do this once, upon the first power-up when connecting to a new host.

To return all features to their default values, scan [Set All Defaults on page 4-3](#). Throughout the programming bar code menus, asterisks (\*) indicate default values.

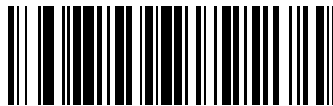

\* Indicates Default    / \*High Frequency    \ Feature/Option

---

## Scanning Sequence Examples

In most cases, scanning one bar code sets the parameter value. For example, to set the beeper tone to high, scan the High Frequency (beeper tone) bar code under *Beeper Tone on page 4-4*. The scanner issues a fast warble beep and the LED turns green, signifying a successful parameter entry.

Other parameters, such as specifying Serial Response Time-Out or setting Data Transmission Formats, require scanning several bar codes. See *Laser On Time on page 4-7* and *Scan Data Transmission Format on page 13-4* for descriptions of this procedure.

## Errors While Scanning

Unless otherwise specified, to correct an error during a scanning sequence, just re-scan the correct parameter.

## User Preferences Default Parameters

*Table 4-1* lists the defaults for user preferences parameters. To change any option, scan the appropriate bar code(s) provided in the User Preferences section beginning on [page 4-3](#).

✓ **NOTE** See [Appendix A, Standard Default Parameters](#) for all user preferences, hosts, symbologies, and miscellaneous default parameters.

**Table 4-1** *User Preferences Default Table*

Parameter	Default	Page Number
<b>User Preferences</b>		
Set Default Parameter	All Defaults	<a href="#">4-3</a>
Beeper Tone	Medium	<a href="#">4-4</a>
Beeper Volume	High	<a href="#">4-5</a>
Power Mode	Continuous On	<a href="#">4-6</a>
Laser On Time	3.0 Sec	<a href="#">4-7</a>
Beep After Good Decode	Enable	<a href="#">4-8</a>
Timeout Between Decodes		
Time-out Between Same Symbol	0.6 sec	<a href="#">4-9</a>
Time-out Between Different Symbols	0.2 sec	<a href="#">4-9</a>

---

## User Preferences

### Set Default Parameter

Scanning this bar code returns all parameters to the default values listed in [Table A-1 on page A-1](#).

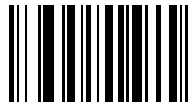

**Set All Defaults**

## Beeper Tone

To select a decode beep frequency (tone), scan the **Low Frequency**, **Medium Frequency**, or **High Frequency** bar code.



**Low Frequency**

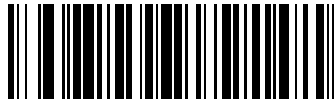

**\*Medium Frequency  
(Optimum Settings)**



**High Frequency**

## Beeper Volume

To select a beeper volume, scan the **Low Volume**, **Medium Volume**, or **High Volume** bar code.



**Low Volume**



**Medium Volume**



**\*High Volume**

---

## Power Mode

This parameter determines whether or not power remains on after a decode attempt. When in reduced power mode, the scanner enters into a low power consumption mode to preserve battery life after each decode attempt. When in continuous power mode, power remains on after each decode attempt.



**\*Continuous On**



**Reduced Power Mode**



## Laser On Time

This parameter sets the maximum time that decode processing continues during a scan attempt. It is programmable in 0.1 second increments from 0.5 to 9.9 seconds. The default Laser On Time is 3.0 seconds.

To set a Laser On Time, scan the bar code below. Next, scan two numeric bar codes beginning on [page D-1](#) in [Appendix D, Numeric Bar Codes](#) that correspond to the desired on time. Include a leading zero for single digit numbers. For example, to set an On Time of 0.5 seconds, scan the bar code below, then scan the “0” and “5” bar codes. To correct an error or change a selection, scan **Cancel** on [page D-3](#).



Laser On Time

## Beep After Good Decode

Scan a bar code below to select whether or not the scanner beeps after a good decode. If you select **Do Not Beep After Good Decode**, the beeper still operates during parameter menu scanning and indicates error conditions.

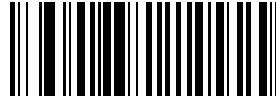

**\*Beep After Good Decode  
(Enable)**

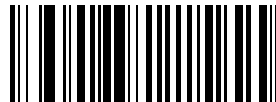

**Do Not Beep After Good Decode  
(Disable)**

---

## Timeout Between Decodes

### Timeout Between Decodes, Same Symbol

This parameter sets the minimum time between decodes of the same symbol. It is programmable in 0.1-second increments from 0.0 to 9.9 seconds. Setting this above 0.4 seconds is recommended. The default for this parameter is 0.6 seconds.

Scan the bar code below to select a new timeout. Next, scan two numeric bar codes beginning in *Numeric Bar Codes on page D-1* that correspond to the desired timeout. Include a leading zero for single digit numbers. For example, to set a timeout of 0.5 seconds, scan the bar code below, then scan the “0” and “5” bar codes. If an error occurs, or to change the selection, scan **Cancel** on page [D-3](#).

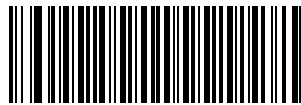

**Timeout Between Same Symbol**

### Timeout Between Decodes, Different Symbol

This parameter sets the minimum time between decodes of different symbols. It is programmable in 0.1-second increments from 0.0 to 9.9 seconds. The default for this parameter is 0.2 seconds.

Scan the bar code below to select a new timeout. Next, scan two numeric bar codes beginning in *Numeric Bar Codes on page D-1* that correspond to the desired timeout. Include a leading zero for single digit numbers. For example, to set a timeout of 0.5 seconds, scan the bar code below, then scan the “0” and “5” bar codes. If an error occurs, or to change the selection, scan **Cancel** on page [D-3](#).



**Timeout Between Different Symbol**



# Chapter 5 Keyboard Wedge Interface

---

## Introduction

This chapter covers Keyboard Wedge interface information for setting up the scanner. Use this interface type to attach the scanner between the keyboard and host computer. The scanner translates the bar code data into keystrokes. The host computer accepts the keystrokes as if they originate from the keyboard.

This mode of operation allows adding bar code reading functionality to a system designed for manual keyboard input. In this mode the keyboard keystrokes are simply passed through.

Throughout the programming bar code menus, asterisks (\*) indicate default values.



\* Indicates Default — \***North American** — Feature/Option

## Connecting a Keyboard Wedge Interface

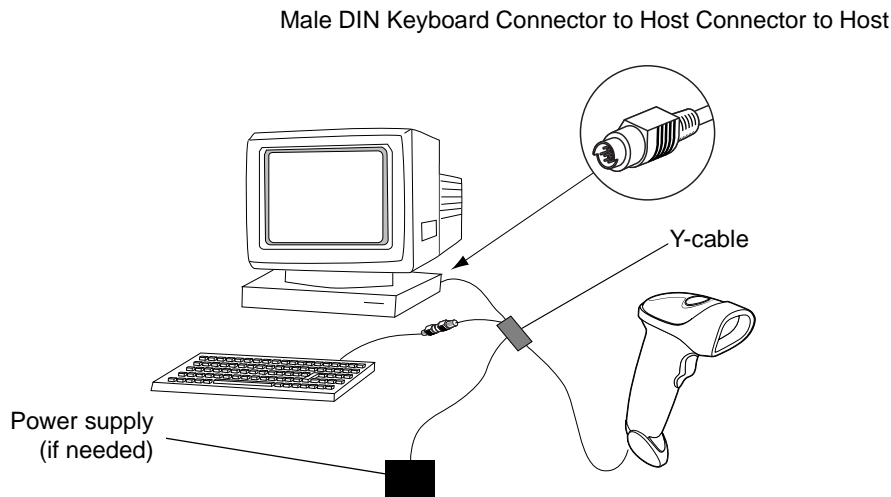

**Figure 5-1** Keyboard Wedge Connection with Y-cable

To connect the Keyboard Wedge Y-cable:

1. Switch off the host and unplug the keyboard connector.
2. Attach the modular connector of the Y-cable to the cable interface port on the scanner. (See [Installing the Interface Cable on page 1-3.](#))
3. Connect the round male DIN host connector of the Y-cable to the keyboard port on the host device.
4. Connect the round female DIN keyboard connector of the Y-cable to the keyboard.
5. If needed, attach the optional power supply to the connector in the middle of the Y-cable.
6. Ensure that all connections are secure.
7. Switch on the host system.
8. Scan the appropriate bar codes in this chapter to configure the scanner.

## Keyboard Wedge Default Parameters

[Table 5-1](#) lists the defaults for Keyboard Wedge host parameters. To change any option, scan the appropriate bar code(s) provided in the Keyboard Wedge Host Parameters section beginning on [page 5-4](#).

✓ **NOTE** See [Appendix A, Standard Default Parameters](#) for all user preferences, hosts, symbologies, and miscellaneous default parameters.

**Table 5-1** Keyboard Wedge Host Default Table

Parameter	Default	Page Number
<b>Keyboard Wedge Host Parameters</b>		
Keyboard Wedge Host Type	IBM PC/AT& IBM PC Compatibles <sup>1</sup>	<a href="#">5-4</a>
Country Types (Country Codes)	North American	<a href="#">5-5</a>
Ignore Unknown Characters	Transmit	<a href="#">5-7</a>
Keystroke Delay	No Delay	<a href="#">5-8</a>
Intra-Keystroke Delay	Disable	<a href="#">5-9</a>
Alternate Numeric Keypad Emulation	Disable	<a href="#">5-9</a>
Caps Lock On	Disable	<a href="#">5-10</a>
Caps Lock Override	Disable	<a href="#">5-10</a>
Convert Wedge Data	No Convert	<a href="#">5-11</a>
Function Key Mapping	Disable	<a href="#">5-12</a>
FN1 Substitution	Disable	<a href="#">5-13</a>
Send and Make Break	Send	<a href="#">5-13</a>

<sup>1</sup>User selection is required to configure this interface and this is the most common selection.

---

## Keyboard Wedge Host Types

### Keyboard Wedge Host Types

Select the keyboard wedge host by scanning one of the bar codes below.



IBM PC/AT & IBM PC Compatibles<sup>1</sup>



IBM PS/2 (Model 30)



IBM AT NOTEBOOK



NCR 7052



**NOTE** User selection is required to configure this interface and this is the most common selection.



## Keyboard Wedge Country Types (Country Codes)

Scan the bar code corresponding to the keyboard type. If your particular keyboard type is not listed, see *Alternate Numeric Keypad Emulation* on page 5-9.



**\*North American**

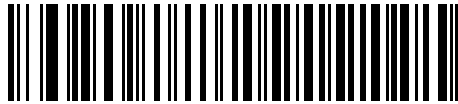

**German Windows**



**French Windows**

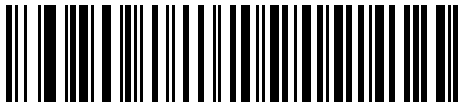

**French Canadian Windows 95/98**

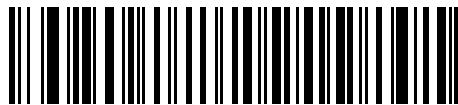

**French Canadian Windows XP/2000**



**French Belgian Windows**

### Keyboard Wedge Country Types (Country Codes) (continued)



**Spanish Windows**



**Italian Windows**

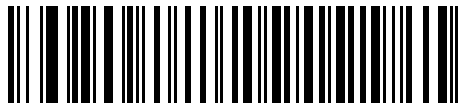

**Swedish Windows**



**UK English Windows**



**Japanese Windows**



**Portuguese-Brazilian Windows**

## Ignore Unknown Characters

Unknown characters are characters the host does not recognize. Select **Send Bar Codes With Unknown Characters** to send all bar code data except for unknown characters. The scanner sounds no error beeps.

Select **Do Not Send Bar Codes With Unknown Characters** to send bar code data up to the first unknown character. The scanner sounds an error beep.



**\*Send Bar Codes with Unknown Characters  
(Transmit)**

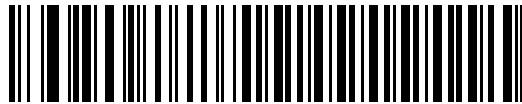

**Do Not Send Bar Codes with Unknown Characters**

## Keystroke Delay

This is the delay in milliseconds between emulated keystrokes. Scan a bar code below to increase the delay when hosts require a slower transmission of data.



**\*No Delay**

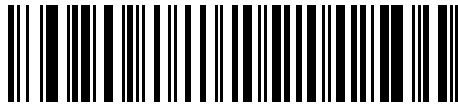

**Medium Delay (20 msec)**

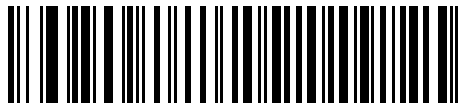

**Long Delay (40 msec)**

## Intra-Keystroke Delay

Enable this to insert an additional delay between each emulated key depression and release. This sets the Keystroke Delay parameter to a minimum of 5 msec as well.

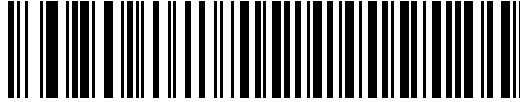

**Enable**

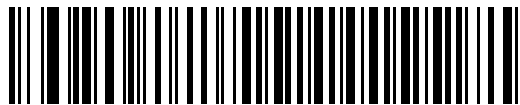

**\*Disable**

## Alternate Numeric Keypad Emulation

This allows emulation of most other country keyboard types not listed in *Keyboard Wedge Country Types (Country Codes)* on page 5-5 in a Microsoft operating system environment.

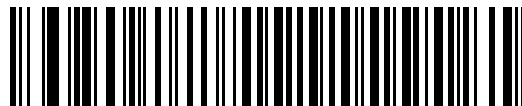

**Enable Alternate Numeric Keypad**



**\*Disable Alternate Numeric Keypad**

## Caps Lock On

When enabled, the scanner emulates keystrokes as if the Caps Lock key is always pressed.

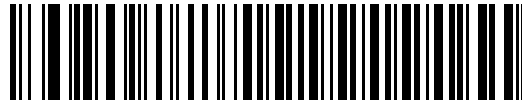

Enable Caps Lock On



\*Disable Caps Lock On

## Caps Lock Override

When enabled, on AT or AT Notebook hosts, the keyboard ignores the state of the Caps Lock key. Therefore, an 'A' in the bar code transmits as an 'A' regardless of the state of the keyboard's Caps Lock key.

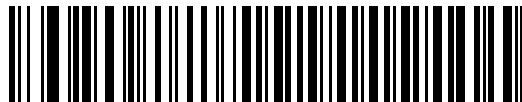

Enable Caps Lock Override

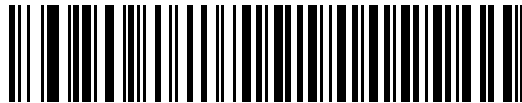

\*Disable Caps Lock Override



**NOTE** If both Caps Lock On and Caps Lock Override are enabled, Caps Lock Override takes precedence.

## Convert Wedge Data

Enable this to convert all bar code data to the selected case.



**Convert to Upper Case**

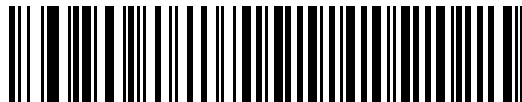

**Convert to Lower Case**



**\*No Convert**

## Function Key Mapping

ASCII values under 32 are normally sent as control key sequences (see [Table 5-2 on page 5-16](#)). Enable this to send the keys in bold in place of the standard key mapping. Table entries that do not have a bold entry remain the same whether or not you enabled this parameter.

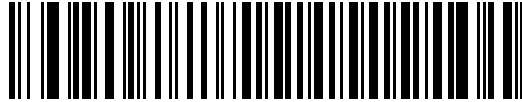

**Enable**

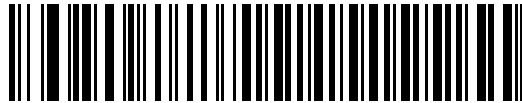

**\*Disable**



## FN1 Substitution

Enable this to allow replacing any FN1 characters in an EAN128 bar code with a user-selected keystroke (see *FN1 Substitution Values on page 13-6*).

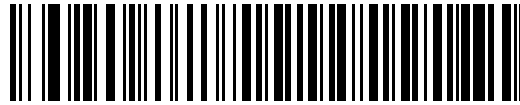

Enable



\*Disable

## Send Make and Break

When enabled, the scan codes for releasing a key are not sent.



\*Send Make and Break Scan Codes

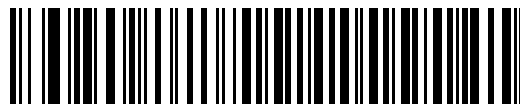

Send Make Scan Code Only

## Keyboard Maps

Use the following keyboard maps for reference for prefix/suffix keystroke parameters. To program the prefix/suffix values, see the bar codes on [page 13-4](#).

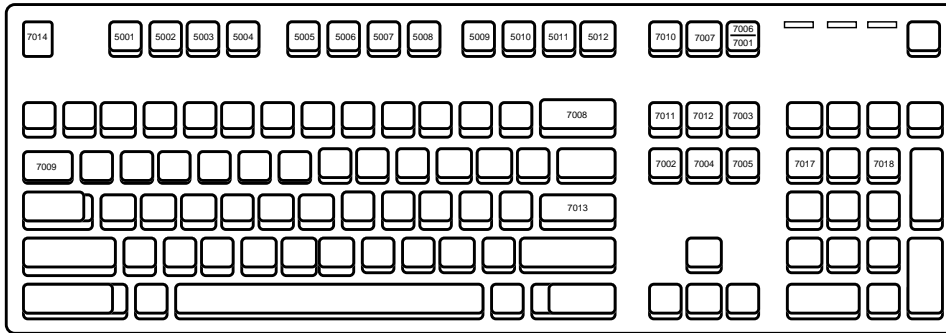

Figure 5-2 IBM PS2 Type Keyboard

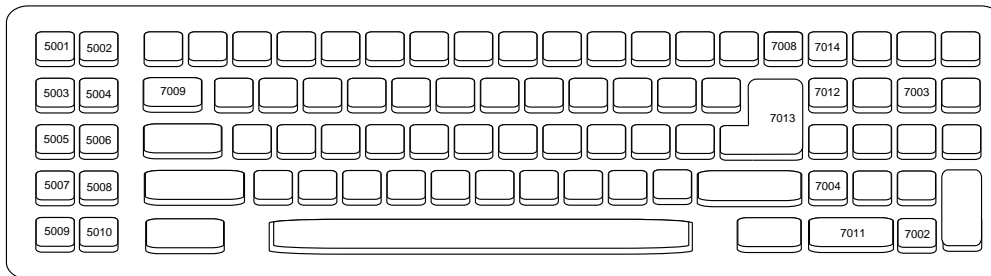

Figure 5-3 IBM PC/AT

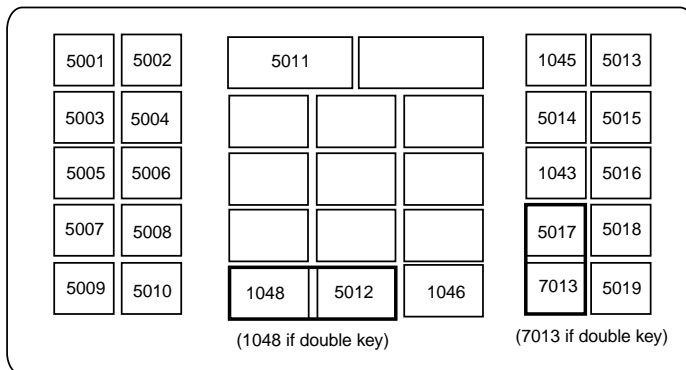
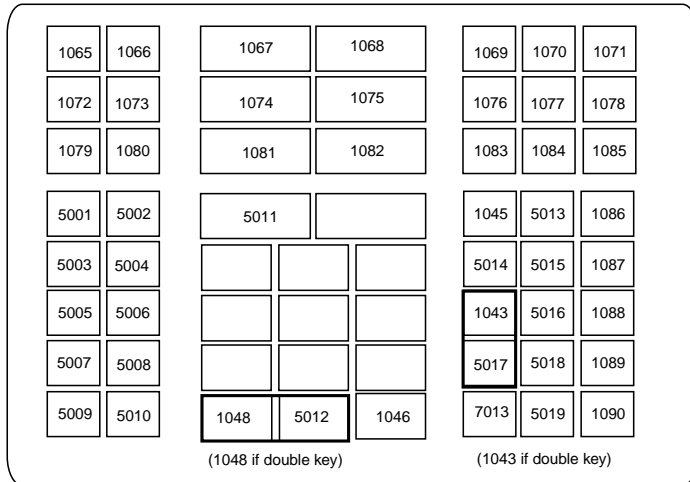

Figure 5-4 NCR 7052 32-KEY

### Keyboard Maps (continued)



**Figure 5-5** NCR 7052 58-KEY

## ASCII Character Set

- ✓ **NOTE** Code 39 Full ASCII interprets the bar code special character (\$ + % /) preceding a Code 39 character and assigns an ASCII character value to the pair. For example, when if you enable Code 39 Full ASCII and scan a **+B**, it is interpreted as **b**, **%J** as **?**, and **%V** as **@**. Scanning **ABC%I** outputs the keystroke equivalent of **ABC >**.

**Table 5-2** Keyboard Wedge ASCII Character Set

ASCII Value	Full ASCII Code 39 Encode Char.	Keystroke
1001	\$A	CTRL A
1002	\$B	CTRL B
1003	\$C	CTRL C
1004	\$D	CTRL D
1005	\$E	CTRL E
1006	\$F	CTRL F
1007	\$G	CTRL G
1008	\$H	CTRL H/ <b>BACKSPACE</b> <sup>1</sup>
1009	\$I	CTRL I/ <b>HORIZONTAL TAB</b> <sup>1</sup>
1010	\$J	CTRL J
1011	\$K	CTRL K
1012	\$L	CTRL L
1013	\$M	CTRL M/ <b>ENTER</b> <sup>1</sup>
1014	\$N	CTRL N
1015	\$O	CTRL O
1016	\$P	CTRL P
1017	\$Q	CTRL Q
1018	\$R	CTRL R
1019	\$S	CTRL S
1020	\$T	CTRL T
1021	\$U	CTRL U

**The keystroke in bold transmits only if you enabled *Function Key Mapping* on page 5-12. Otherwise, the unbolded keystroke transmits.**

**Table 5-2** Keyboard Wedge ASCII Character Set (continued)

ASCII Value	Full ASCII Code 39 Encode Char.	Keystroke
1022	\$V	CTRL V
1023	\$W	CTRL W
1024	\$X	CTRL X
1025	\$Y	CTRL Y
1026	\$Z	CTRL Z
1027	%A	CTRL [ /ESC <sup>1</sup>
1028	%B	CTRL \
1029	%C	CTRL ]
1030	%D	CTRL 6
1031	%E	CTRL -
1032	Space	Space
1033	/A	!
1034	/B	“
1035	/C	#
1036	/D	\$
1037	/E	%
1038	/F	&
1039	/G	‘
1040	/H	(
1041	/I	)
1042	/J	*
1043	/K	+
1044	/L	,
1045	-	-
1046	.	.
1047	/O	/
1048	0	0

**The keystroke in bold transmits only if you enabled *Function Key Mapping* on page 5-12. Otherwise, the unbolded keystroke transmits.**

**Table 5-2** Keyboard Wedge ASCII Character Set (continued)

ASCII Value	Full ASCII Code 39 Encode Char.	Keystroke
1049	1	1
1050	2	2
1051	3	3
1052	4	4
1053	5	5
1054	6	6
1055	7	7
1056	8	8
1057	9	9
1058	/Z	:
1059	%F	;
1060	%G	<
1061	%H	=
1062	%I	>
1063	%J	?
1064	%V	@
1065	A	A
1066	B	B
1067	C	C
1068	D	D
1069	E	E
1070	F	F
1071	G	G
1072	H	H
1073	I	I
1074	J	J
1075	K	K

**The keystroke in bold transmits only if you enabled *Function Key Mapping* on page 5-12. Otherwise, the unbolded keystroke transmits.**

**Table 5-2** Keyboard Wedge ASCII Character Set (continued)

ASCII Value	Full ASCII Code 39 Encode Char.	Keystroke
1076	L	L
1077	M	M
1078	N	N
1079	O	O
1080	P	P
1081	Q	Q
1082	R	R
1083	S	S
1084	T	T
1085	U	U
1086	V	V
1087	W	W
1088	X	X
1089	Y	Y
1090	Z	Z
1091	%K	[
1092	%L	\
1093	%M	]
1094	%N	^
1095	%O	_
1096	%W	'
1097	+A	<b>a</b>
1098	+B	<b>b</b>
1099	+C	<b>c</b>
1100	+D	<b>d</b>
1101	+E	<b>e</b>
1102	+F	<b>f</b>

**The keystroke in bold transmits only if you enabled *Function Key Mapping* on page 5-12. Otherwise, the unbolded keystroke transmits.**

**Table 5-2** Keyboard Wedge ASCII Character Set (continued)

ASCII Value	Full ASCII Code 39 Encode Char.	Keystroke
1103	+G	g
1104	+H	h
1105	+I	i
1106	+J	j
1107	+K	k
1108	+L	l
1109	+M	m
1110	+N	n
1111	+O	o
1112	+P	p
1113	+Q	q
1114	+R	r
1115	+S	s
1116	+T	t
1117	+U	u
1118	+V	v
1119	+W	w
1120	+X	x
1121	+Y	y
1122	+Z	z
1123	%P	{
1124	%Q	
1125	%R	}
1126	%S	~

The keystroke in bold transmits only if you enabled *Function Key Mapping* on page 5-12. Otherwise, the unbolded keystroke transmits.



**Table 5-3** *Keyboard Wedge ALT Keys*

<b>ALT Keys</b>	<b>Keystroke</b>
2065	ALT A
2066	ALT B
2067	ALT C
2068	ALT D
2069	ALT E
2070	ALT F
2071	ALT G
2072	ALT H
2073	ALT I
2074	ALT J
2075	ALT K
2076	ALT L
2077	ALT M
2078	ALT N
2079	ALT O
2080	ALT P
2081	ALT Q
2082	ALT R
2083	ALT S
2084	ALT T
2085	ALT U
2086	ALT V
2087	ALT W
2088	ALT X
2089	ALT Y
2090	ALT Z

**Table 5-4** *Keyboard Wedge GUI Keys*

<b>GUI Keys</b>	<b>Keystroke</b>
3000	Right Control Key
3048	GUI 0
3049	GUI 1
3050	GUI 2
3051	GUI 3
3052	GUI 4
3053	GUI 5
3054	GUI 6
3055	GUI 7
3056	GUI 8
3057	GUI 9
3065	GUI A
3066	GUI B
3067	GUI C
3068	GUI D
3069	GUI E
3070	GUI F
3071	GUI G
3072	GUI H
3073	GUI I
3074	GUI J
3075	GUI K
3076	GUI L
3077	GUI M
3078	GUI N
3079	GUI O
3080	GUI P
3081	GUI Q

**Table 5-4** Keyboard Wedge GUI Keys (continued)

GUI Keys	Keystroke
3082	GUI R
3083	GUI S
3084	GUI T
3085	GUI U
3086	GUI V
3087	GUI W
3088	GUI X
3089	GUI Y
3090	GUI Z

**Table 5-5** Keyboard Wedge F Keys

F Keys	Keystroke
5001	F1
5002	F2
5003	F3
5004	F4
5005	F5
5006	F6
5007	F7
5008	F8
5009	F9
5010	F10
5011	F11
5012	F12
5013	F13
5014	F14
5015	F15
5016	F16
5017	F17

**Table 5-5** Keyboard Wedge F Keys (continued)

F Keys	Keystroke
5018	F18
5019	F19
5020	F20
5021	F21
5022	F22
5023	F23
5024	F24

**Table 5-6** Keyboard Wedge Numeric Keypad

Numeric Keypad	Keystroke
6042	*
6043	+
6044	undefined
6045	-
6046	.
6047	/
6048	0
6049	1
6050	2
6051	3
6052	4
6053	5
6054	6
6055	7
6056	8
6057	9
6058	Enter
6059	Num Lock

**Table 5-7** *Keyboard Wedge Extended Keypad*

<b>Extended Keypad</b>	<b>Keystroke</b>
7001	Break
7002	Delete
7003	Pg Up
7004	End
7005	Pg Dn
7006	Pause
7007	Scroll Lock
7008	Backspace
7009	Tab
7010	Print Screen
7011	Insert
7012	Home
7013	Enter
7014	Escape
7015	Up Arrow
7016	Dn Arrow
7017	Left Arrow
7018	Right Arrow



# Chapter 6 RS-232 Interface

---

## Introduction

This chapter includes RS-232 host information for setting up the scanner. Use the RS-232 interface to attach the scanner to point-of-sale devices, host computers, or other devices with an available RS-232 port (e.g., com port).

If your particular host is not listed in [Table 6-2](#), set the communication parameters to match the host device. Refer to the documentation for the host device.

- ✓ **NOTE** This scanner uses TTL RS-232 signal levels, which interface with most system architectures. For system architectures requiring RS-232C signal levels, Motorola offers different cables providing TTL to RS-232C conversion. Contact Motorola Enterprise Mobility Support for more information.

Throughout the programming bar code menus, asterisks (\*) indicate default values.



\* Indicates Default    \*Baud Rate 9600    Feature/Option

## Connecting an RS-232 Interface

The scanner connects directly to the host computer.

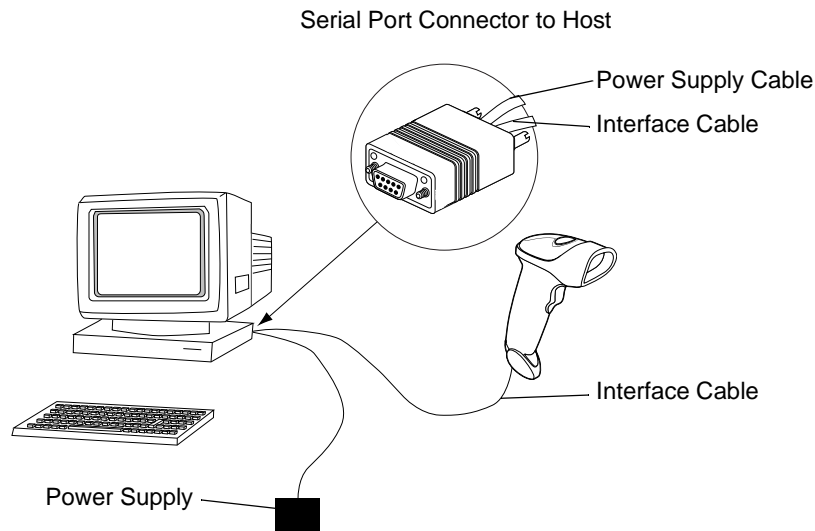

**Figure 6-1** RS-232 Direct Connection

1. Connect the RS-232 interface cable to the bottom of the scanner, as described in [Installing the Interface Cable on page 1-3](#).
2. Connect the other end of the interface cable to the serial port on the host.
3. Connect the power supply.
4. Scan appropriate bar codes in this chapter to match host settings.



## RS-232 Default Parameters

[Table 6-1](#) lists the defaults for RS-232 host parameters. To change any option, scan the appropriate bar code(s) provided in the Parameter Descriptions section beginning on [page 6-4](#).

✓ **NOTE** See [Appendix A, Standard Default Parameters](#) for all user preferences, hosts, symbologies, and miscellaneous default parameters.

**Table 6-1** RS-232 Host Default Table

Parameter	Default	Page Number
<b>RS-232 Host Parameters</b>		
RS-232 Host Types	Standard <sup>1</sup>	<a href="#">6-6</a>
Baud Rate	9600	<a href="#">6-8</a>
Parity Type	None	<a href="#">6-10</a>
Stop Bit Select	1 Stop Bit	<a href="#">6-12</a>
Data Bits	8-Bit	<a href="#">6-12</a>
Check Receive Errors	Enable	<a href="#">6-13</a>
Hardware Handshaking	None	<a href="#">6-14</a>
Software Handshaking	None	<a href="#">6-16</a>
Host Serial Response Time-out	2 Sec	<a href="#">6-18</a>
RTS Line State	Low RTS	<a href="#">6-19</a>
Beep on <BEL>	Disable	<a href="#">6-19</a>
Intercharacter Delay	0 msec	<a href="#">6-20</a>
Nixdorf Beep/LED Options	Normal Operation	<a href="#">6-21</a>
Ignore Unknown Characters	Send Bar Code	<a href="#">6-21</a>

<sup>1</sup>User selection is required to configure this interface and this is the most common selection.

## RS-232 Host Parameters

The RS-232 hosts listed in [Table 6-2](#) use their own parameter default settings. Selecting the ICL, Fujitsu, Wincor-Nixdorf Mode A, Wincor-Nixdorf Mode B, Olivetti, Omron, or terminal sets the defaults listed.

**Table 6-2** Terminal Specific RS-232

Parameter	Standard (Default)	ICL	Fujitsu	Wincor-Nixdorf Mode A	Wincor-Nixdorf Mode B/OPOS	Olivetti	Omron
Transmit Code ID	No	Yes	Yes	Yes	Yes	Yes	Yes
Data Transmission Format	Data as is	Data/Suffix	Data/Suffix	Data/Suffix	Data/Suffix	Prefix/Data/Suffix	Data/Suffix
Suffix	CR/LF (7013)	CR (1013)	CR (1013)	CR (1013)	CR (1013)	ETX (1002)	CR (1013)
Baud Rate	9600	9600	9600	9600	9600	9600	9600
Parity	None	Even	None	Odd	Odd	Even	None
Hardware Handshaking	None	RTS/CTS Option 3	None	RTS/CTS Option 3	RTS/CTS Option 3	None	None
Software Handshaking	None	None	None	None	None	Ack/Nak	None
Serial Response Time-out	2 Sec.	9.9 Sec.	2 Sec.	9.9 Sec.	9.9 Sec.	9.9 Sec.	9.9 Sec.
Stop Bit Select	One	One	One	One	One	One	One
ASCII Format	8-Bit	8-Bit	8-Bit	8-Bit	8-Bit	7-Bit	8-Bit
Beep On <BEL>	Disable	Disable	Disable	Disable	Disable	Disable	Disable
RTS Line State	Low	High	Low	Low	Low = No data to send	Low	High
Prefix	None	None	None	None	None	STX (1003)	None

**\*In the Nixdorf Mode B, if CTS is low, scanning is disabled. When CTS is high, scanning is enabled.**  
**\*\*If you scan Nixdorf Mode B without connecting the scanner to the proper host, it may appear unable to scan. If this occurs, scan a different RS-232 host type within 5 seconds of cycling power to the scanner.**



## RS-232 Host Types

To select an RS-232 host interface, scan one of the following bar codes.

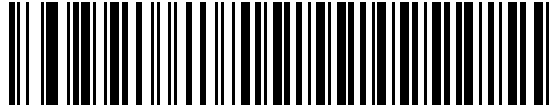

**Standard RS-232<sup>1</sup>**



**ICL RS-232**

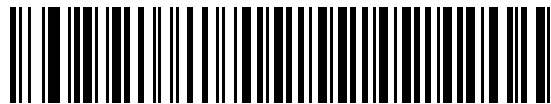

**Wincor-Nixdorf RS-232 Mode A**



**Wincor-Nixdorf RS-232 Mode B**

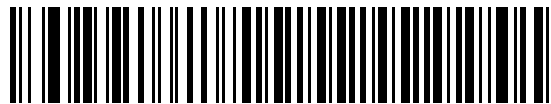

**Olivetti ORS4500**

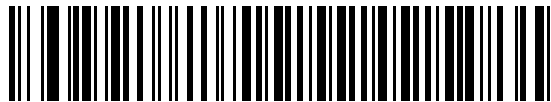
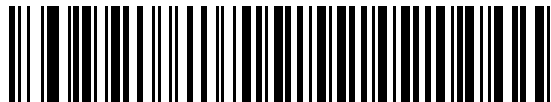
**RS-232 Host Types (continued)****Omron****OPOS/JPOS****Fujitsu RS-232**

✓ **NOTE** <sup>1</sup>User selection is required to configure this interface and this is the most common selection.

## Baud Rate

Baud rate is the number of bits of data transmitted per second. Set the scanner's baud rate to match the host's baud rate setting, or data may not reach the host device or may reach it in distorted form.



**Baud Rate 600**



**Baud Rate 1200**

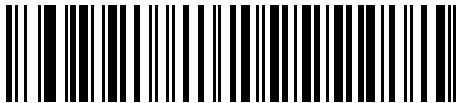

**Baud Rate 2400**

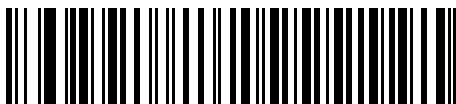

**Baud Rate 4800**

**Baud Rate (continued)**

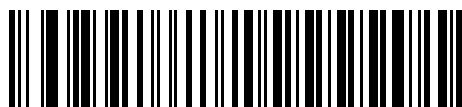

**\*Baud Rate 9600**

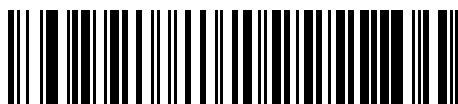

**Baud Rate 19,200**



**Baud Rate 38,400**

## Parity

A parity check bit is the most significant bit of each ASCII coded character. Select the parity type according to host device requirements.

Select **Odd** parity to set the parity bit value to 0 or 1, based on data, to ensure that the coded character contains an odd number of 1 bits.

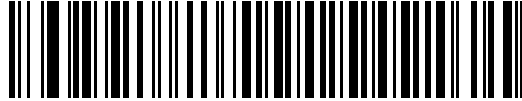

Odd

Select **Even** parity to set the parity bit value to 0 or 1, based on data, to ensure that the coded character contains an even number of 1 bits.



Even

Select **Mark** parity and the parity bit is always 1.

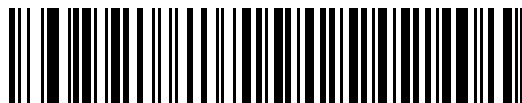

Mark



**Parity (continued)**

Select **Space** parity and the parity bit is always 0.



**Space**

Select **None** when no parity bit is required.



**\*None**

## Stop Bit Select

The stop bit(s) at the end of each transmitted character marks the end of transmission of one character and prepares the receiving device for the next character in the serial data stream. Select the number of stop bits (one or two) depending on the number the receiving terminal/host is programmed to accommodate.



**\*1 Stop Bit**



**2 Stop Bits**

## Data Bits

This parameter allows the scanner to interface with devices requiring a 7-bit or 8-bit ASCII protocol.



**7-Bit**



**\*8-Bit**

## Check Receive Errors

Select whether or not to check the parity, framing, and overrun of received characters. The parity value of received characters is verified against the parity parameter selected above.



**\*Check For Received Errors**

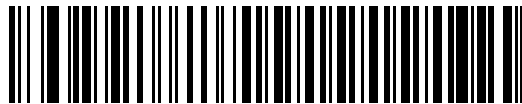

**Do Not Check For Received Errors**

## Hardware Handshaking

The data interface consists of an RS-232 port designed to operate either with or without the hardware handshaking lines, *Request to Send (RTS)*, and *Clear to Send (CTS)*.

Disable Standard RTS/CTS handshaking to transmit scan data as it becomes available. Select Standard RTS/CTS handshaking to transmit scan data according to the following sequence:

- The scanner reads the CTS line for activity. If CTS is asserted, the scanner waits up to Host Serial Response Time-out for the host to negate the CTS line. If, after the Host Serial Response Time-out (default), the CTS line is still asserted, the scanner sounds a transmit error, and discards any scanned data.
- When the CTS line is negated, the scanner asserts the RTS line and waits up to Host Serial Response Time-out for the host to assert CTS. When the host asserts CTS, the scanner transmits data. If, after the Host Serial Response Time-out (default), the CTS line is not asserted, the scanner sounds a transmit error, and discards the data.
- When data transmission completes, the scanner negates RTS 10 msec after sending the last character.
- The host should respond by negating CTS. The scanner checks for a negated CTS upon the next data transmission.

During data transmission, the CTS line should be asserted. If CTS is deasserted for more than 50 ms between characters, the transmission aborts, and the scanner sounds a transmission error and discards the data.

If this communications sequence fails, the scanner issues an error indication and discards the data. You must rescan the data.

If hardware handshaking and software handshaking are both enabled, hardware handshaking takes precedence.



**NOTE** The DTR signal is jumpered to the active state.

### None

Scan the bar code below to disable hardware handshaking.

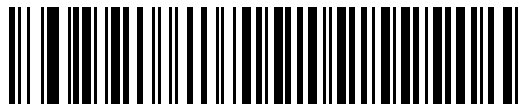

**\*None**

### Standard RTS/CTS

Scan the bar code below to select Standard RTS/CTS hardware handshaking.



**Standard RTS/CTS**

### RTS/CTS Option 1

If you select RTS/CTS Option 1, the scanner asserts RTS before transmitting and ignores the state of CTS. The scanner de-asserts RTS when the transmission completes.

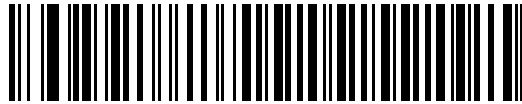

RTS/CTS Option 1

### RTS/CTS Option 2

If you select Option 2, RTS is always high or low (user-programmed logic level). However, the scanner waits for CTS to be asserted before transmitting data. If CTS is not asserted within Host Serial Response Time-out (default), the scanner issues an error indication and discards the data.

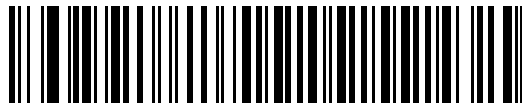

RTS/CTS Option 2

### RTS/CTS Option 3

If you select Option 3, the scanner asserts RTS prior to any data transmission, regardless of the state of CTS. The scanner waits up to Host Serial Response Time-out (default) for CTS to be asserted. If CTS is not asserted during this time, the scanner issues an error indication and discards the data. The scanner de-asserts RTS when transmission is complete.



RTS/CTS Option 3

## Software Handshaking

This parameter offers control of the data transmission process in addition to, or instead of, the control that hardware handshaking offers. There are five options.

If software handshaking and hardware handshaking are both enabled, hardware handshaking takes precedence.

### None

Select this option to transmit data immediately. No response is expected from host.

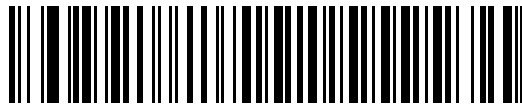

\*None

### ACK/NAK

If you select this option, after transmitting data, the scanner expects either an ACK or NAK response from the host. When a NAK is received, the scanner transmits the same data again and waits for either an ACK or NAK. After three unsuccessful attempts to send data after receiving NAKs, the scanner issues an error indication and discards the data.

The scanner waits up to the programmable Host Serial Response Time-out to receive an ACK or NAK. If the scanner does not get a response in this time, it issues an error indication and discards the data. There are no retries when a time-out occurs.

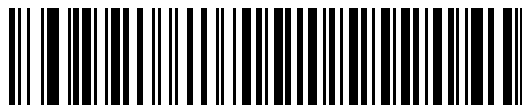

ACK/NAK

### ENQ

If you select this option, the scanner waits for an ENQ character from the host before transmitting data. If the scanner does not receive an ENQ within the Host Serial Response Time-out, it issues an error indication and discards the data. The host must transmit an ENQ character at least every Host Serial Response Time-out to prevent transmission errors.

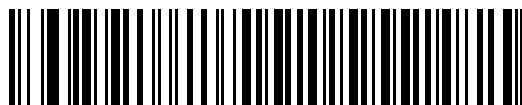

ENQ

### **ACK/NAK with ENQ**

This combines the two previous options. For re-transmissions of data due to a NAK from the host, an additional ENQ is not required.



**ACK/NAK with ENQ**

### **XON/XOFF**

An XOFF character turns the scanner transmission off until the scanner receives an XON character. There are two situations for XON/XOFF:

- The scanner receives an XOFF before it has data to send. When the scanner has data to send, it waits up to Host Serial Response Time-out for an XON character before transmission. If it does not receive an XON within this time, it issues an error indication and discards the data.
- The scanner receives an XOFF during a transmission. Data transmission then stops after sending the current byte. When the scanner receives an XON character, it sends the rest of the data message. The scanner waits up to 30 seconds for the XON.

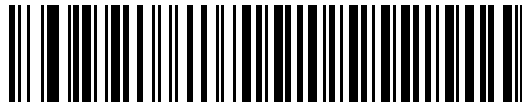

**XON/XOFF**

## Host Serial Response Time-out

This parameter specifies how long the scanner waits for an ACK, NAK, or CTS before determining that a transmission error occurred. This only applies when in one of the ACK/NAK software handshaking modes, or in RTS/CTS hardware handshaking mode.



**\*Minimum: 2 Sec**



**Low: 2.5 Sec**



**Medium: 5 Sec**



**High: 7.5 Sec**



**Maximum: 9.9 Sec**



## RTS Line State

This parameter sets the idle state of the Serial Host RTS line. Scan a bar code below to select **Low RTS** or **High RTS** line state.



**\*Host: Low RTS**

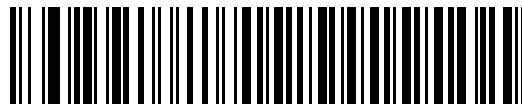

**Host: High RTS**

## Beep on <BEL>

If you enable this parameter, the scanner issues a beep when it detects a <BEL> character on the RS-232 serial line. <BEL> gains a user's attention to an illegal entry or other important event.

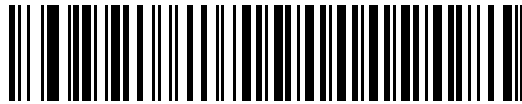

**Beep On <BEL> Character  
(Enable)**



**\*Do Not Beep On <BEL> Character  
(Disable)**

## Intercharacter Delay

This parameter specifies the intercharacter delay inserted between character transmissions.



**\*Minimum: 0 msec**



**Low: 25 msec**

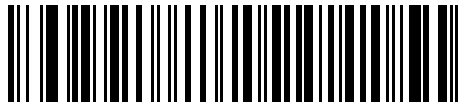

**Medium: 50 msec**

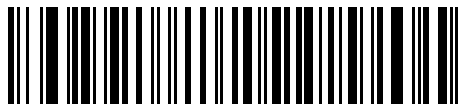

**High: 75 msec**

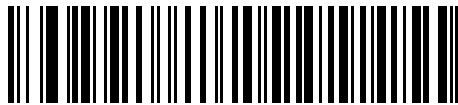

**Maximum: 99 msec**

## Nixdorf Beep/LED Options

When Nixdorf Mode B is selected, this indicates when the scanner beeps and turns on its LED after a decode.

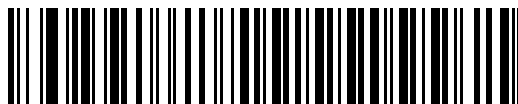

**\*Normal Operation**  
(Beep/LED immediately after decode)

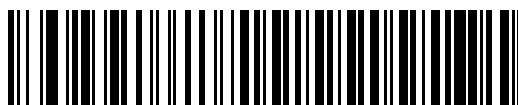

**Beep/LED After Transmission**

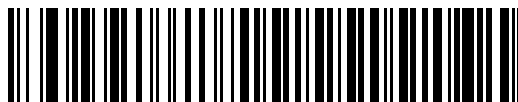

**Beep/LED After CTS Pulse**

## Ignore Unknown Characters

Unknown characters are characters the host does not recognize. Select **Send Bar Codes with Unknown Characters** to send all bar code data except for unknown characters. The scanner sounds no error beeps.

Select **Do Not Send Bar Codes With Unknown Characters** to send bar code data up to the first unknown character. The scanner sounds an error beep.

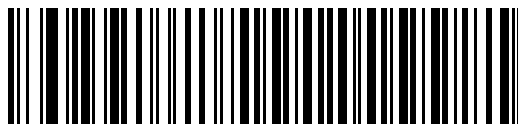

**\*Send Bar Code**  
(with unknown characters)



**Do Not Send Bar Codes**  
(with unknown characters)

## ASCII Character Set

You can assign the values in [Table 6-4](#) as prefixes or suffixes for ASCII character data transmission.

**Table 6-4** Prefix/Suffix Values

Prefix/Suffix Value	Full ASCII Code 39 Encode Character	ASCII Character
1000	%U	NUL
1001	\$A	SOH
1002	\$B	STX
1003	\$C	ETX
1004	\$D	EOT
1005	\$E	ENQ
1006	\$F	ACK
1007	\$G	BELL
1008	\$H	BCKSPC
1009	\$I	HORIZ TAB
1010	\$J	LF/NW LN
1011	\$K	VT
1012	\$L	FF
1013	\$M	CR/ENTER
1014	\$N	SO
1015	\$O	SI
1016	\$P	DLE
1017	\$Q	DC1/XON
1018	\$R	DC2
1019	\$S	DC3/XOFF
1020	\$T	DC4
1021	\$U	NAK
1022	\$V	SYN
1023	\$W	ETB
1024	\$X	CAN
1025	\$Y	EM
1026	\$Z	SUB

**Table 6-4** *Prefix/Suffix Values (continued)*

Prefix/Suffix Value	Full ASCII Code 39 Encode Character	ASCII Character
1027	%A	ESC
1028	%B	FS
1029	%C	GS
1030	%D	RS
1031	%E	US
1032	Space	Space
1033	/A	!
1034	/B	"
1035	/C	#
1036	/D	\$
1037	/E	%
1038	/F	&
1039	/G	'
1040	/H	(
1041	/I	)
1042	/J	*
1043	/K	+
1044	/L	,
1045	-	-
1046	.	.
1047	/O	/
1048	0	0
1049	1	1
1050	2	2
1051	3	3
1052	4	4
1053	5	5
1054	6	6
1057	7	7
1056	8	8

**Table 6-4** Prefix/Suffix Values (continued)

Prefix/Suffix Value	Full ASCII Code 39 Encode Character	ASCII Character
1057	9	9
1058	/Z	:
1059	%F	;
1060	%G	<
1061	%H	=
1062	%I	>
1063	%J	?
1064	%V	@
1065	A	A
1066	B	B
1067	C	C
1068	D	D
1069	E	E
1070	F	F
1071	G	G
1072	H	H
1073	I	I
1074	J	J
1075	K	K
1076	L	L
1077	M	M
1078	N	N
1079	O	O
1080	P	P
1081	Q	Q
1082	R	R
1083	S	S
1084	T	T
1085	U	U
1086	V	V

**Table 6-4** *Prefix/Suffix Values (continued)*

Prefix/Suffix Value	Full ASCII Code 39 Encode Character	ASCII Character
1087	W	W
1088	X	X
1089	Y	Y
1090	Z	Z
1091	%K	[
1092	%L	\
1093	%M	]
1094	%N	^
1095	%O	_
1096	%W	`
1097	+A	a
1098	+B	b
1099	+C	c
1100	+D	d
1101	+E	e
1102	+F	f
1103	+G	g
1104	+H	h
1105	+I	i
1106	+J	j
1107	+K	k
1108	+L	l
1109	+M	m
1110	+N	n
1111	+O	o
1112	+P	p
1113	+Q	q
1114	+R	r
1115	+S	s
1116	+T	t

**Table 6-4** *Prefix/Suffix Values (continued)*

Prefix/Suffix Value	Full ASCII Code 39 Encode Character	ASCII Character
1117	+U	u
1118	+V	v
1119	+W	w
1120	+X	x
1121	+Y	y
1122	+Z	z
1123	%P	{
1124	%Q	
1125	%R	}
1126	%S	~
1127		Undefined
7013		ENTER



# Chapter 7 USB Interface

---

## Introduction

This chapter includes information on how to connect and set up the scanner with a USB host. The scanner connects directly to a USB host, or a powered USB hub, which powers it. No additional power supply is required.

Throughout the programming bar code menus, asterisks (\*) indicate default values.



\* Indicates Default — **\*North American Standard USB Keyboard** — Feature/Option

---

## Connecting a USB Interface

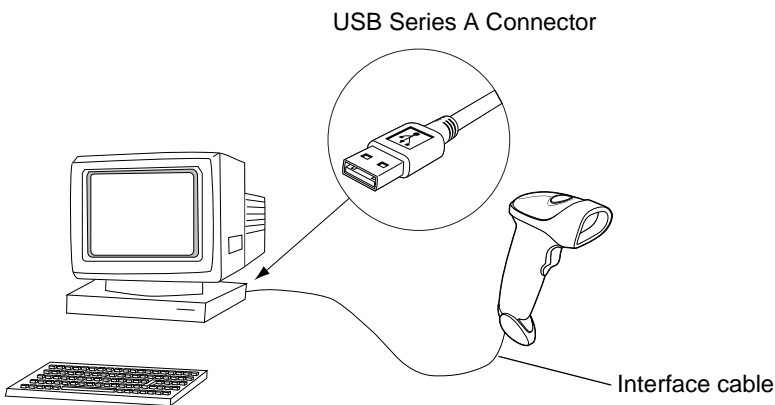

**Figure 7-1** *USB Connection*

The scanner connects with USB capable hosts including:

- Desktop PCs and Notebooks
- Apple™ iMac, G4, iBooks (North America only)
- IBM SurePOS terminals
- Sun, IBM, and other network computers that support more than one keyboard.

The following operating systems support the scanner through USB:

- Windows 98, 2000, ME, XP
- MacOS 8.5 and above
- IBM 4690 OS.

The scanner also interfaces with other USB hosts which support USB Human Interface Devices (HID).

To set up the scanner:

1. Connect the USB interface cable to the bottom of the scanner, as described in [Installing the Interface Cable on page 1-3](#).
2. Plug the series A connector in the USB host or hub, or plug the Plus Power connector in an available port of the IBM SurePOS terminal.
3. Select the USB device type. See *USB Device Type on page 7-4*.
4. On first installation when using Windows, the software prompts you to select or install the **Human Interface Device** driver. To install this driver, provided by Windows, click **Next** through all the choices and click **Finished** on the last choice. The scanner powers up during this installation.
5. If you are not using a North American keyboard, scan the appropriate country bar code under *USB Country Keyboard Types (Country Codes) on page 7-6*.

If you have any problems, see *Troubleshooting on page 3-2*.

## USB Default Parameters

*Table 7-1* lists the defaults for USB host parameters. To change any option, scan the appropriate bar code(s) in the Parameter Descriptions section beginning on *page 7-4*.

✓ **NOTE** See [Appendix A, Standard Default Parameters](#) for all user preferences, hosts, symbologies, and miscellaneous default parameters.

**Table 7-1** *USB Host Default Table*

Parameter	Default	Page Number
<b>USB Host Parameters</b>		
USB Device Type	HID Keyboard Emulation	<a href="#">7-4</a>
USB Country Keyboard Types (Country Codes)	North American	<a href="#">7-6</a>
USB Keystroke Delay	No Delay	<a href="#">7-9</a>
USB CAPS Lock Override	Disable	<a href="#">7-10</a>
USB Ignore Unknown Characters	Enable	<a href="#">7-11</a>
Emulate Keypad	Disable	<a href="#">7-12</a>
USB FN1 Substitution	Disable	<a href="#">7-12</a>
Function Key Mapping	Disable	<a href="#">7-13</a>
Simulated Caps Lock	Disable	<a href="#">7-13</a>
Convert Case	None	<a href="#">7-14</a>

---

## USB Host Parameters

### USB Device Type

Select the USB device type.

- **HID Keyboard Emulation** (default) - This allows the scanner to emulate a USB keyboard. Upon a successful decode, bar code data transmits to the console as if the data was typed on a keyboard. Most USB drivers support **HID Keyboard Emulation** so it requires no special drivers.
- **IBM Table Top USB** - Use this device type with table top scanners connecting to a cash register with IBM OEM specification compliant drivers (supplied by the cash register vendor). IBM Table Top USB requires drivers supplied by the Point-of-Service (POS) device vendor. Check with the POS vendor to verify these drivers.
- **IBM Hand-Held USB** - Use this device type with hand-held scanners connecting to a cash register with IBM OEM specification compliant drivers (supplied by the cash register vendor). IBM Hand-Held USB requires drivers supplied by the Point-of-Service (POS) device vendor. Check with the POS vendor to verify these drivers.



**NOTE** When connecting two scanners to a host, IBM does not permit the selection of two of the same device types. If you require two connections, select IBM Table Top USB for one scanner and IBM Hand-Held USB for the second scanner.

- **USB OPOS Hand-Held** - Use this device type with Motorola's OPOS/JPOS compliant drivers, available from Support Central at <http://motorola.com/enterprisemobility/support>. Motorola only supports one OPOS connection per host.
- **Simple COM Port Emulation** - This device type requires a driver download from Support Central at <http://motorola.com/enterprisemobility/support>. Connecting the scanner to the host automatically selects the next available comm port, emulating a one-way RS-232 connection. This does not support handshaking and does not require a baud setting.

## USB Device Type (continued)

- ✓ **NOTE** When changing USB Device Types, the scanner automatically restarts and issues the standard startup beep sequences.



**\*HID Keyboard Emulation**

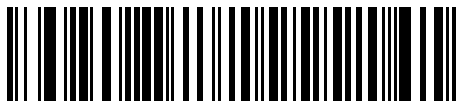

**IBM Table Top USB**



**IBM Hand-Held USB**



**USB OPOS Hand-Held**



**Simple COM Port Emulation**

## USB Country Keyboard Types (Country Codes)

Scan the bar code corresponding to the keyboard type. This setting applies only to the USB HID Keyboard Emulation device.



**NOTE** When changing Country Selection, the scanner automatically restarts and issues the standard startup beep sequences.



\*North American Standard USB Keyboard



German Windows



French Windows

## USB Country Keyboard Types (continued)



**French Canadian Windows 95/98**



**French Canadian Windows 2000/XP**



**French Belgian Windows**



**Spanish Windows**



**Italian Windows**

## USB Country Keyboard Types (continued)



Swedish Windows



UK English Windows

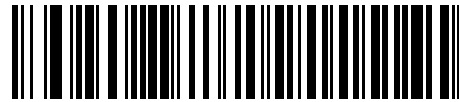

Japanese Windows (ASCII)



Portuguese-Brazilian Windows



## USB Keystroke Delay

This parameter sets the delay, in milliseconds, between emulated keystrokes. Scan a bar code below to increase the delay when hosts require slower data transmission.

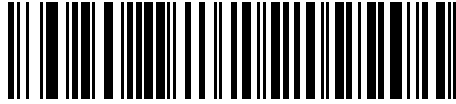

**\*No Delay**

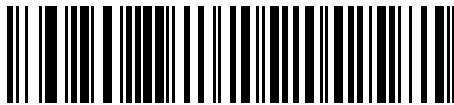

**Medium Delay (20 msec)**



**Long Delay (40 msec)**

## USB CAPS Lock Override

This option applies only to the HID Keyboard Emulation device. Enable this to preserve the case of the data regardless of the state of the Caps Lock key. This setting is always enabled for the “Japanese, Windows (ASCII)” keyboard type and can not be disabled.

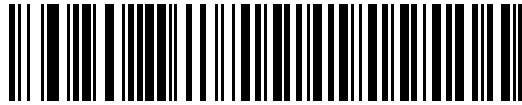

**Override Caps Lock Key  
(Enable)**



**\*Do Not Override Caps Lock Key  
(Disable)**

## USB Ignore Unknown Characters

This option applies only to the HID Keyboard Emulation device and IBM device. Unknown characters are characters the host does not recognize. Select **Send Bar Codes With Unknown Characters** to send all bar code data except for unknown characters. The scanner sounds no error beeps.

Select **Do Not Send Bar Codes With Unknown Characters** to prevent sending bar codes containing at least one unknown character to the host. The scanner sounds an error beep.

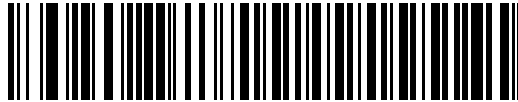

**\*Send Bar Codes with Unknown Characters  
(Transmit)**

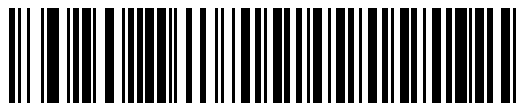

**Do Not Send Bar Codes with Unknown Characters  
(Disable)**

## Emulate Keypad

Enable this to send all characters as ASCII sequences over the numeric keypad. For example, ASCII A transmits as “ALT make” 0 6 5 “ALT Break”.



**\*Disable Keypad Emulation**

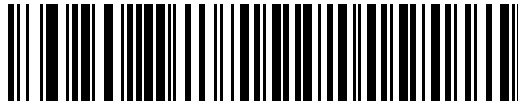

**Enable Keypad Emulation**

## USB Keyboard FN 1 Substitution

This option applies only to the USB HID Keyboard Emulation device. When enabled, this allows replacing any FN 1 characters in an EAN 128 bar code with a Key Category and value chosen by the user (see FN 1 Substitution Values on [page 13-6](#) to set the Key Category and Key Value).



**Enable**

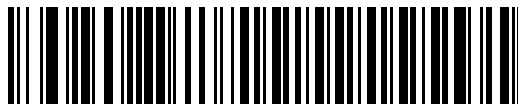

**\*Disable**

## Function Key Mapping

ASCII values under 32 typically transmit as control-key sequences (see [Table 7-2 on page 7-15](#)). Enable this parameter to send the keys in bold in place of the standard key mapping. Table entries that do not have a bold entry remain the same whether or not you enable this parameter.

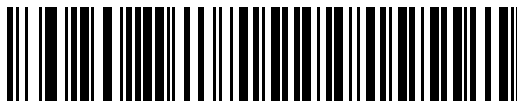

**\*Disable Function Key Mapping**

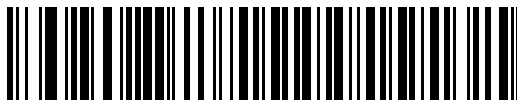

**Enable Function Key Mapping**

## Simulated Caps Lock

Enable this to invert the upper and lower case characters on the scanned bar code as if the Caps Lock state is enabled on the keyboard. This inversion occurs regardless of the keyboard's Caps Lock state.

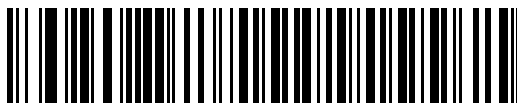

**\*Disable Simulated Caps Lock**

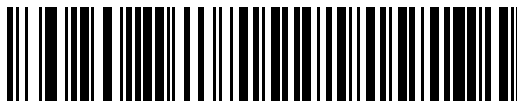

**Enable Simulated Caps Lock**

## Convert Case

Enable this to convert all bar code data to the selected case.

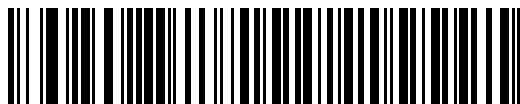

**\*No Case Conversion**

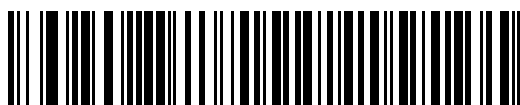

**Convert All to Upper Case**

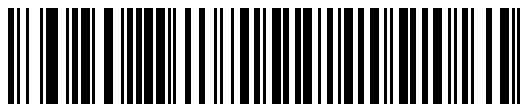

**Convert All to Lower Case**

## ASCII Character Set

**Table 7-2** USB ASCII Character Set

Prefix/ Suffix Value	Full ASCII Code 39 Encode Char.	Keystroke
1000	%U	CTRL 2
1001	\$A	CTRL A
1002	\$B	CTRL B
1003	\$C	CTRL C
1004	\$D	CTRL D
1005	\$E	CTRL E
1006	\$F	CTRL F
1007	\$G	CTRL G
1008	\$H	CTRL H/ <b>BACKSPACE</b> <sup>1</sup>
1009	\$I	CTRL I/ <b>HORIZONTAL TAB</b> <sup>1</sup>
1010	\$J	CTRL J
1011	\$K	CTRL K
1012	\$L	CTRL L
1013	\$M	CTRL M/ <b>ENTER</b> <sup>1</sup>
1014	\$N	CTRL N
1015	\$O	CTRL O
1016	\$P	CTRL P
1017	\$Q	CTRL Q
1018	\$R	CTRL R
1019	\$S	CTRL S
1020	\$T	CTRL T
1021	\$U	CTRL U
1022	\$V	CTRL V
1023	\$W	CTRL W

The keystroke in bold transmits only if you enabled *Function Key Mapping* on page 7-13. Otherwise, the unbolded keystroke transmits.

**Table 7-2** USB ASCII Character Set (continued)

Prefix/ Suffix Value	Full ASCII Code 39 Encode Char.	Keystroke
1024	\$X	CTRL X
1025	\$Y	CTRL Y
1026	\$Z	CTRL Z
1027	%A	CTRL [/ <b>ESC</b> <sup>1</sup>
1028	%B	CTRL \
1029	%C	CTRL ]
1030	%D	CTRL 6
1031	%E	CTRL -
1032	Space	Space
1033	/A	!
1034	/B	"
1035	/C	#
1036	/D	\$
1037	/E	%
1038	/F	&
1039	/G	'
1040	/H	(
1041	/I	)
1042	/J	*
1043	/K	+
1044	/L	,
1045	-	-
1046	.	.
1047	/O	/
1048	0	0
1049	1	1
1050	2	2

**The keystroke in bold transmits only if you enabled *Function Key Mapping* on page 7-13. Otherwise, the unbolded keystroke transmits.**



**Table 7-2** USB ASCII Character Set (continued)

Prefix/ Suffix Value	Full ASCII Code 39 Encode Char.	Keystroke
1051	3	3
1052	4	4
1053	5	5
1054	6	6
1055	7	7
1056	8	8
1057	9	9
1058	/Z	:
1059	%F	;
1060	%G	<
1061	%H	=
1062	%I	>
1063	%J	?
1064	%V	@
1065	A	A
1066	B	B
1067	C	C
1068	D	D
1069	E	E
1070	F	F
1071	G	G
1072	H	H
1073	I	I
1074	J	J
1075	K	K
1076	L	L
1077	M	M

**The keystroke in bold transmits only if you enabled *Function Key Mapping* on page 7-13. Otherwise, the unbolded keystroke transmits.**

**Table 7-2** USB ASCII Character Set (continued)

Prefix/ Suffix Value	Full ASCII Code 39 Encode Char.	Keystroke
1078	N	N
1079	O	O
1080	P	P
1081	Q	Q
1082	R	R
1083	S	S
1084	T	T
1085	U	U
1086	V	V
1087	W	W
1088	X	X
1089	Y	Y
1090	Z	Z
1091	%K	[
1092	%L	\
1093	%M	]
1094	%N	^
1095	%O	_
1096	%W	`
1097	+A	<b>a</b>
1098	+B	<b>b</b>
1099	+C	<b>c</b>
1100	+D	<b>d</b>
1101	+E	<b>e</b>
1102	+F	<b>f</b>
1103	+G	<b>g</b>
1104	+H	<b>h</b>

**The keystroke in bold transmits only if you enabled *Function Key Mapping* on page 7-13. Otherwise, the unbolded keystroke transmits.**

**Table 7-2** USB ASCII Character Set (continued)

Prefix/ Suffix Value	Full ASCII Code 39 Encode Char.	Keystroke
1105	+I	i
1106	+J	j
1107	+K	k
1108	+L	l
1109	+M	m
1110	+N	n
1111	+O	o
1112	+P	p
1113	+Q	q
1114	+R	r
1115	+S	s
1116	+T	t
1117	+U	u
1118	+V	v
1119	+W	w
1120	+X	x
1121	+Y	y
1122	+Z	z
1123	%P	{
1124	%Q	
1125	%R	}
1126	%S	~

**The keystroke in bold transmits only if you enabled *Function Key Mapping* on page 7-13. Otherwise, the unbolded keystroke transmits.**

**Table 7-3** *USB ALT Keys*

<b>ALT Keys</b>	<b>Keystroke</b>
2064	ALT 2
2065	ALT A
2066	ALT B
2067	ALT C
2068	ALT D
2069	ALT E
2070	ALT F
2071	ALT G
2072	ALT H
2073	ALT I
2074	ALT J
2075	ALT K
2076	ALT L
2077	ALT M
2078	ALT N
2079	ALT O
2080	ALT P
2081	ALT Q
2082	ALT R
2083	ALT S
2084	ALT T
2085	ALT U
2086	ALT V
2087	ALT W
2088	ALT X
2089	ALT Y
2090	ALT Z

**Table 7-4** *USB GUI Shift Keys*

GUI Shift Keys	Keystroke
3000	Right Control Key
3048	GUI 0
3049	GUI 1
3050	GUI 2
3051	GUI 3
3052	GUI 4
3053	GUI 5
3054	GUI 6
3055	GUI 7
3056	GUI 8
3057	GUI 9
3065	GUI A
3066	GUI B
3067	GUI C
3068	GUI D
3069	GUI E
3070	GUI F
3071	GUI G
3072	GUI H
3073	GUI I
3074	GUI J
3075	GUI K
3076	GUI L
3077	GUI M
3078	GUI N
3079	GUI O

The Apple™ iMac keyboard has an apple key on either side of the space bar. Windows-based systems have a GUI key to the left of the left ALT key, and to the right of the right ALT key.

**Table 7-4** USB GUI Shift Keys (continued)

GUI Shift Keys	Keystroke
3080	GUI P
3081	GUI Q
3082	GUI R
3083	GUI S
3084	GUI T
3085	GUI U
3086	GUI V
3087	GUI W
3088	GUI X
3089	GUI Y
3090	GUI Z

The Apple™ iMac keyboard has an apple key on either side of the space bar. Windows-based systems have a GUI key to the left of the left ALT key, and to the right of the right ALT key.

**Table 7-5** *USB F Keys*

<b>F Keys</b>	<b>Keystroke</b>
5001	F1
5002	F2
5003	F3
5004	F4
5005	F5
5006	F6
5007	F7
5008	F8
5009	F9
5010	F10
5011	F11
5012	F 12
5013	F 13
5014	F 14
5015	F 15
5016	F16
5017	F 17
5018	F 18
5019	F 19
5020	F 20
5021	F 21
5022	F 22
5023	F 23
5024	F 24

**Table 7-6** *USB Keypad Keys*

Keypad Keys	Keystroke
6042	*
6043	+
6044	undefined
6045	-
6046	.
6047	/
6048	0
6049	1
6050	2
6051	3
6052	4
6053	5
6054	6
6055	7
6056	8
6057	9
6058	Enter
6059	Num Lock



**Table 7-7** *USB Extended Keypad*

<b>Extended Keypad</b>	<b>Keystroke</b>
7001	Break
7002	Delete
7003	PgUp
7004	End
7005	Pg Dn
7006	Pause
7007	Scroll Lock
7008	Backspace
7009	Tab
7010	Print Screen
7011	Insert
7012	Home
7013	Enter
7014	Escape
7015	Up Arrow
7016	Down Arrow
7017	Left Arrow
7018	Right Arrow



# Chapter 8 IBM 468X/469X Interface

---

## Introduction

This chapter includes IBM 468X/469X host information for setting up the scanner.

Throughout the programming bar code menus, asterisks (\*) indicate default values.



\* Indicates Default — **\*Disable Convert to Code 39** — Feature/Option

## Connecting to an IBM 468X/469X Host

The scanner connects directly to the host interface.

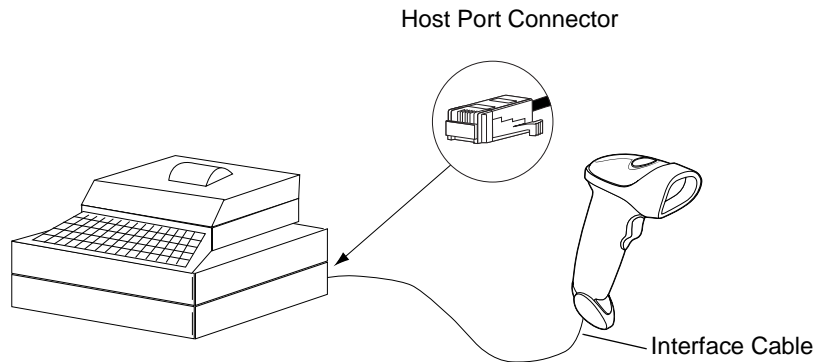

**Figure 8-1** IBM Direct Connection

1. Connect the interface cable to the bottom of the scanner, as described in [Installing the Interface Cable on page 1-3](#).
2. Connect the other end of the interface cable to the appropriate port on the host (typically, Port 9).
3. Scan the appropriate bar codes in this chapter to configure the scanner.

✓ **NOTE** The only required configuration is the port number. The IBM system typically controls most other scanner parameters.

## IBM Default Parameters

*Table 8-1* lists the defaults for IBM host parameters. To change any option, scan the appropriate bar code(s) in the Parameter Descriptions section beginning on [page 8-4](#).

✓ **NOTE** See [Appendix A, Standard Default Parameters](#) for all user preferences, hosts, symbologies, and miscellaneous default parameters.

**Table 8-1** *IBM Host Default Table*

Parameter	Default	Page Number
<b>IBM 468X/469X Host Parameters</b>		
Port Address	None Selected	<a href="#">8-4</a>
Convert Unknown to Code 39	Disable	<a href="#">8-5</a>

---

## IBM 468X/469X Host Parameters

### Port Address

This parameter sets the IBM 468X/469X port used.

✓ **NOTE** Scanning one of these bar codes enables the RS-485 interface on the scanner.

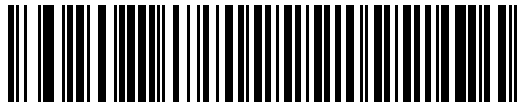

\* None Selected

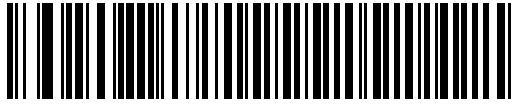

Hand-held Scanner Emulation (Port 9B)<sup>1</sup>



Non-IBM Scanner Emulation (Port 5B)

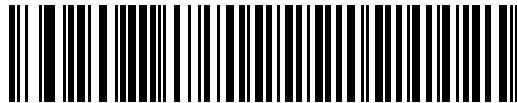
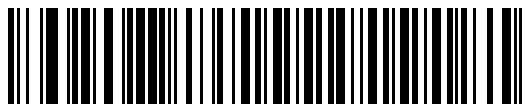

Table Top Scanner Emulation (Port 17)

✓ **NOTE** <sup>1</sup>User selection is required to configure this interface and this is the most common selection.

## Convert Unknown to Code 39

Scan a bar code below to enable or disable the conversion of unknown bar code type data to Code 39.



**Enable Convert Unknown to Code 39**

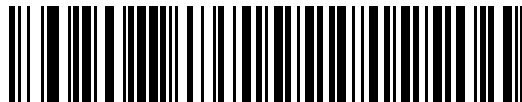

**\*Disable Convert Unknown to Code 39**





# Chapter 9 Wand Emulation Interface

---

## Introduction

This chapter includes Wand Emulation host information for setting up the scanner. Use this mode when you need Wand Emulation communication. The scanner connects either to an external wand decoder or to a decoder integrated in a portable terminal or Point-of-Sale (POS) terminal.

In this mode the scanner emulates the signal of a digital wand to make it "readable" by a wand decoder.

Throughout the programming bar code menus, asterisks (\*) indicate default values.



\* Indicates Default

**\*Transmit Unknown Characters**

Feature/Option

---

## Connecting Using Wand Emulation

To perform Wand Emulation, connect the scanner to a portable data terminal, or a controller which collects the wand data and interprets it for the host.

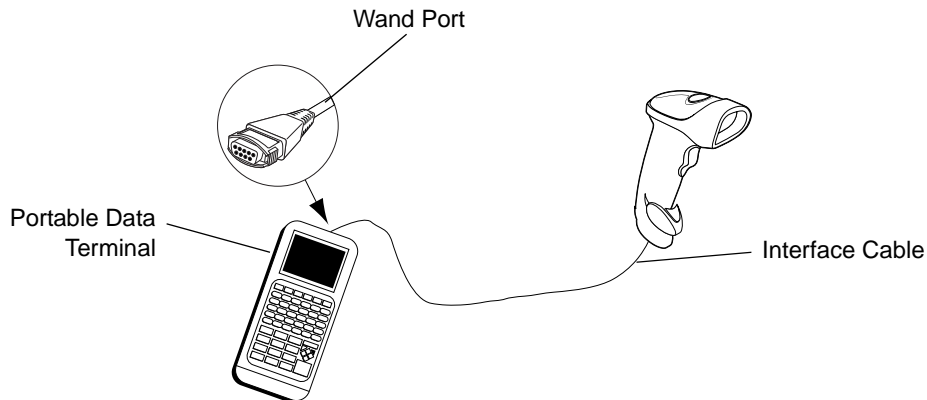

**Figure 9-1** Wand Emulation Connection

1. Connect the Wand Emulation interface cable to the bottom of the scanner, as described in [Installing the Interface Cable on page 1-3](#).
2. Connect the other end of the interface cable to the Wand port on the portable data terminal or controller.
3. Scan the appropriate bar codes in this chapter to configure the scanner.

## Wand Emulation Default Parameters

Table 9-1 lists the defaults for Wand Emulation host types. To change any option, scan the appropriate bar code(s) provided in the Wand Emulation Host Parameters section beginning on page 9-4.

✓ **NOTE** See Appendix A, Standard Default Parameters for all user preferences, hosts, symbologies, and miscellaneous default parameters.

**Table 9-1** Wand Emulation Default Table

Parameter	Default	Page Number
<b>Wand Emulation Host Parameters</b>		
Wand Emulation Host Types	Symbol OmniLink Interface Controller <sup>1</sup>	9-4
Leading Margin	80 msec	9-5
Polarity	Bar High/Margin Low	9-6
Ignore Unknown Characters	Ignore	9-6
Convert All Bar Codes to Code 39	Disable	9-7
Convert Code 39 to Full ASCII	Disable	9-7

**<sup>1</sup>User selection is required to configure this interface and this is the most common selection.**

---

## Wand Emulation Host Parameters

### Wand Emulation Host Types

Select the wand emulation host by scanning one of the bar codes below.



**Symbol OmniLink Interface Controller<sup>1</sup>**

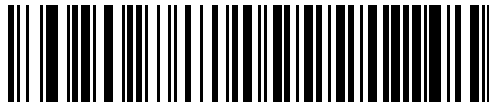

**Symbol PDT Terminal (MSI)**

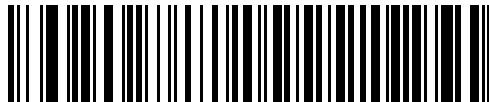

**Symbol PTC Terminal (Telxon)**



**NOTE** <sup>1</sup>User selection is required to configure this interface and this is the most common selection.

### Leading Margin (Quiet Zone)

Scan a bar code below to select a leading margin duration. A leading margin is the time that precedes the first bar of the scan, (in milliseconds). The minimum allowed value is 80 msec and the maximum is 250 msec. This parameter is used to accommodate older wand decoders which cannot handle short leading margins.

✓ **NOTE** 250 msec is the maximum value that this parameter can attain, however, 200 msec is sufficient.

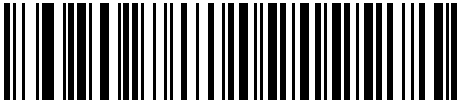

\*80 msec

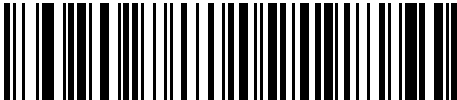

140 msec

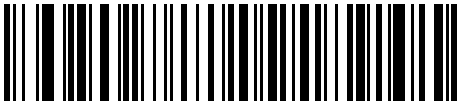

200 msec

## Polarity

Polarity determines how the scanner's wand emulation interface creates the Digitized Barcode Pattern (DBP). DBP is a digital signal that represents the scanned bar code. Different decoders, to which this device can connect, are expecting the DBP in a certain format. The DBP either has the "high" represent bars and the "low" represent spaces (margins), or the "high" represent spaces (margins) and the "low" represent bars.

Scan the appropriate bar code below to select the polarity the decoder requires.

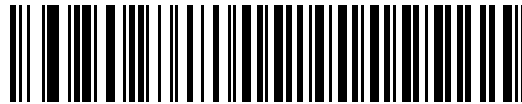

**\*Bar High/Margin Low**

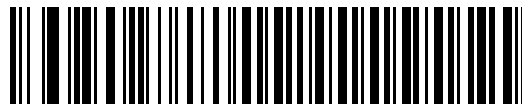

**Bar Low/Margin High**

## Ignore Unknown Characters

Unknown characters are characters the host does not recognize. Select **Send Bar Codes With Unknown Characters** to send all bar code data except for unknown characters. The scanner sounds no error beeps.

Select **Do Not Send Bar Codes With Unknown Characters** to prevent sending bar codes containing at least one unknown character to the host. The scanner sounds an error beep.



**\*Send Bar Codes With Unknown Characters  
(Transmit)**



**Do Not Send Bar Codes With Unknown Characters  
(Do Not Transmit)**

## Convert All Bar Codes to Code 39

By default, the Wand Emulation interface sends data to the attached host in the same symbology that was decoded. This can present a problem for customers with older systems that do not recognize some newer symbologies (for example, GS1 DataBar).

Enable this parameter to ignore the decoded symbology, and output the data as Code 39. Lowercase characters in the original data stream transmit as uppercase. This also allows ADF formatting.

Enable **Ignore Unknown Characters** to replace any characters that do not have a corresponding character in the Code 39 symbology with a space.

If you disable **Ignore Unknown Characters**, when the scanner encounters characters that do not have a corresponding character, it emits an error beep and discards the data.

- ✓ **NOTE** ADF Note: By default, the Wand Emulation interface does not allow ADF rules to process scanned data. Enabling this parameter allows ADF rules to process scanned data. See [Chapter 14, Advanced Data Formatting](#).



Enable Convert to Code 39 for Wand Host

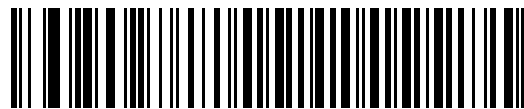

\*Disable Convert to Code 39 for Wand Host

## Convert Code 39 to Full ASCII

By default, a space replaces any characters that do not have a corresponding character in the Code 39 symbology set. Enable this parameter to encode the data sent to the Wand interface in Code 39 Full ASCII. In order to do this, the host must be able to interpret Code 39 Full ASCII data.

This setting applies only if you enabled **Convert to Code 39**.

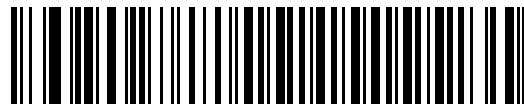

\*Disable Code 39 Full ASCII Conversion

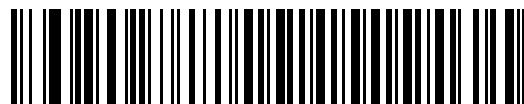

Enable Code 39 Full ASCII Conversion





# Chapter 10 Undecoded Scanner Emulation Interface

---

## Introduction

This chapter includes undecoded scanner emulation host information for setting up the scanner. Use this mode when you require undecoded scanner emulation communication. With this host, the scanner connects either to an external decoder or to a decoder integrated in a portable terminal or Point-of-Sale (POS) terminal.

Throughout the programming bar code menus, asterisks (\*) indicate default values.



\* Indicates Default — **\*Parameter Process and Pass-Through** — Feature/Option

## Connecting Using Undecoded Scanner Emulation

To perform undecoded scanner emulation, connect the scanner to a portable data terminal, or a controller which collects the data and interprets it for the host.

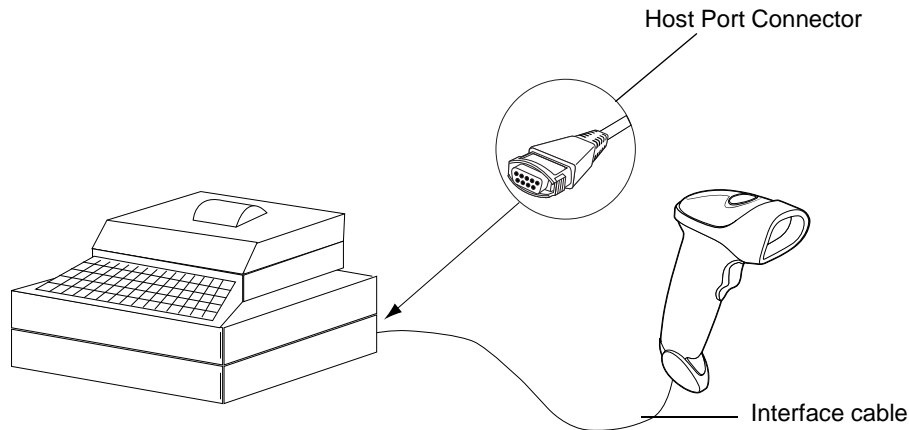

**Figure 10-1** *Undecoded Scanner Emulation Connection*

1. Connect the undecoded interface cable to the bottom of the scanner, as described in [Installing the Interface Cable on page 1-3](#).
2. Connect the other end of the interface cable to the scanner port on the portable data terminal or controller.
3. Scan the appropriate bar codes in this chapter to configure the scanner.



**CAUTION** Connect the scanner to 5 volt decoders only. Connecting the scanner to a 12 volt decoder invalidates the warranty.

## Undecoded Scanner Emulation Default Parameters

*Table 10-1* lists the defaults for the undecoded scanner emulation host. To change an option, scan the appropriate bar code(s) in the Undecoded Scanner Host Parameters section beginning on *page 10-5*.

✓ **NOTE** See *Appendix A, Standard Default Parameters* for all user preferences, hosts, symbologies, and miscellaneous default parameters.

**Table 10-1** *Undecoded Scanner Emulation Default Table*

Parameter	Default	Page Number
Beep Style	Beep on Successful Transmit	<a href="#">10-5</a>
Parameter Pass-Through	Parameter Process and Pass Through	<a href="#">10-6</a>
Convert Newer Code Types	Convert Newer Code Types	<a href="#">10-7</a>
Module Width	20 $\mu$ s	<a href="#">10-7</a>
Convert All Bar Codes to Code 39	Do Not Convert to Bar Codes to Code 39	<a href="#">10-8</a>
Code 39 Full ASCII Conversion	Disable	<a href="#">10-8</a>
Transmission Timeout	3 seconds	<a href="#">10-9</a>
Ignore Unknown Characters	Ignore Unknown Characters	<a href="#">10-10</a>
Leading Margin	2 ms	<a href="#">10-11</a>
Check for Decode LED	Check for Decode LED	<a href="#">10-12</a>

**<sup>1</sup>User selection is required to configure this interface and this is the most common selection.**

---

## Undecoded Scanner Emulation Host

Scan the bar code below to enable the undecoded scanner emulation host.



**Undecoded Scanner Emulation Host**

---

## Undecoded Scanner Emulation Host Parameters

### Beep Style

The undecoded scanner emulation host supports three different beep styles.

The default is to beep when the attached decoder issues the decode signal to the scanner. This way, the scanner and the attached decoder beep at the same time.

The second option is to beep on the scanner's decode. This results in a double beep sequence from most decoders, since the scanner beeps, and the decoder beeps (at a different frequency) when it successfully decodes the output.

The third option is to not beep at all since the attached decoder issues the decode beep.

In all cases, if an error occurs, the scanner issues error beeps.



**\*Beep On Successful Transmit**



**Beep At Decode Time**



**Do Not Beep**

## Parameter Pass-Through

The undecoded scanner emulation host can process parameter bar code messages and send them to the attached decoder. In this way, customers using Motorola compliant decoders can control the behavior of the entire system by scanning the necessary parameters only once.



**NOTE** To enable D 2 of 5, for example, simply scan the **D 2 of 5 Enable** parameter bar code on the scanner. The scanner and the attached decoder both process the parameter.



**\*Parameter Process and Pass-Through**



**Parameter Process Only**

## Convert Newer Code Types

The Symbol LS2208 supports a variety of code types that are typically not decodable by attached decoder systems. To allow compatibility in these environments, the scanner converts these code types to more common symbologies, as per the following chart. Symbologies not listed on this chart transmit normally.

Scan this code type:	Transmitted as:
Code 11	Code 39
Chinese 2 of 5	Code 39
GS1 DataBar (14, Limited, and Expanded)	Code 128
Coupon Code	Code 128

If you disable this parameter, when decoding these code types the scanner issues Convert Error beeps and transmits no data.



**\*Convert Newer Code Types**



**Reject Newer Code Types**

## Module Width

The standard module width is 20  $\mu$ s.

For extremely slow decoder system, use this parameter to extend this module width to 50  $\mu$ s.



**\*20  $\mu$ s Module Width**



**50  $\mu$ s Module Width**

## Convert All Bar Codes to Code 39

Scan the appropriate bar code below to enable or disable converting all bar code data to Code 39.



**\*Do Not Convert Bar Codes To Code 39**



**Convert All To Code 39**

## Code 39 Full ASCII Conversion

By default, a space replaces any characters that do not have a corresponding character in the Code 39 symbology set. Enable this parameter to encode the data sent to the undecoded scanner emulation host in Code 39 Full ASCII. In order to do this, the host must be able to interpret Code 39 Full ASCII data.

This setting applies only if you enabled **Convert to Code 39**.



**\*Disable Convert Code 39 To Full ASCII**



**Enable Convert Code 39 To Full ASCII**



## Transmission Timeout

The undecoded scanner emulation host transmits bar code data to the attached decoder and waits for the attached decoder to assert the Decode signal, indicating successful transmission. If, after a specified amount of time, the Decode signal is not asserted (indicating the attached decoder did not receive the bar code data), the scanner issues Transmit Error beeps.

Scan the appropriate bar code below to select the desired transmission timeout.



**\*3 Second Transmission Timeout**



**4 Second Transmission Timeout**



**5 Second Transmission Timeout**



**10 Second Transmission Timeout**



**30 Second Transmission Timeout**

## Ignore Unknown Characters

Unknown characters are characters the decoder does not recognize. Select **Ignore Unknown Characters** to send all bar code data except for unknown characters. The scanner sounds no error beeps.

Select **Convert Error on Unknown Characters** to prevent sending bar codes containing at least one unknown character to the decoder. The scanner sounds a Convert Error beep.



**\*Ignore Unknown Characters**



**Convert Error On Unknown Characters**

## Leading Margin

Scan a bar code below to select a leading margin duration.



**1 ms Leading Margin**



**\*2 ms Leading Margin**



**3 ms Leading Margin**



**5 ms Leading Margin**



**10 ms Leading Margin**

## Check For Decode LED

The attached decoder normally asserts the Decode line to signal to the undecoded scanner emulation host that it successfully decoded the transmitted bar code. Some decoders, however, do not assert the Decode signal to tell the scanner that a decode occurred. In this case, the scanner emits Transmit Error beeps to indicate that the bar code was not successfully transmitted. Scan the **Ignore Decode LED** bar code below to disable the Transmit Error beeps.



**\*Check For Decode LED**



**Ignore Decode LED**

# Chapter 11 123Scan<sup>2</sup>

---

## Introduction

123Scan<sup>2</sup> is an easy-to-use, PC-based software tool that enables rapid and easy customized setup of Symbol scanners by Motorola.

123Scan<sup>2</sup> uses a wizard tool to guide users through a streamlined set up process. Settings are saved in a configuration file that can be distributed via e-mail, electronically downloaded via a USB cable, or used to generate a sheet of scannable programming bar codes.

Additionally 123Scan<sup>2</sup> can upgrade scanner firmware, check online to enable support for newly released products, generate a collection of multi-setting bar codes if the number of settings is very large, stage large number of scanners simultaneously, generate reports with asset tracking information and create custom products.

---

## Communication with 123Scan<sup>2</sup>

To communicate with the 123Scan<sup>2</sup> program which runs on a host computer running a Windows XP SP2 or Windows Vista operating system, use a USB cable to connect the scanner cradle to the host computer (see *Connecting a USB Interface on page 7-1*).

---

## 123Scan<sup>2</sup> Requirements

- Host computer with Windows XP SP2 or Windows Vista
- Scanner
- Cradle
- USB cable.

For more information on 123Scan<sup>2</sup>, go to:

<http://www.motorola.com/123Scan2>

To download 123Scan<sup>2</sup> software and access the Help file integrated in the utility, go to:

<http://support.symbol.com/support/product/123Scan2.html>

---





# Chapter 12 Symbologies

---

## Introduction

This chapter describes all symbology features and provides programming bar codes for selecting these features for the Symbol LS2208 scanner. Before programming, follow the instructions in [Chapter 1, Getting Started](#).

The scanner ships with the settings in the *Symbology Default Table on page 12-2* (also see [Appendix A, Standard Default Parameters](#) for all host device and miscellaneous scanner defaults). If the default values suit requirements, programming is not necessary. To set feature values, scan single bar codes or short bar code sequences.

To return all features to default values, scan [Set All Defaults on page 4-3](#).

If you are not using a Synapse or USB cable, you must select a host type. See each host chapter for specific host information.

---

## Scanning Sequence Examples

In most cases, scan one bar code to set a specific parameter value. For example, to transmit bar code data without the UPC-A check digit, scan the **Do Not Transmit UPC-A Check Digit** bar code under *Transmit UPC-A/UPC-E/UPC-E1 Check Digit on page 12-13*. The scanner issues a fast warble beep and the LED turns green, signifying a successful parameter entry.

Other parameters, such as **Set Length(s) for D 2 of 5** require scanning several bar codes in sequence. See the individual parameter, such as **Set Length(s) for D 2 of 5**, for this procedure.

---

## Errors While Scanning

Unless otherwise specified, to correct an error during a scanning sequence, just re-scan the correct parameter.

## Symbology Default Parameters

[Table 12-1](#) lists the defaults for all symbologies parameters. To change any option, scan the appropriate bar code(s) provided in the Symbologies Parameters section beginning on [page 12-5](#).

✓ **NOTE** See [Appendix A, Standard Default Parameters](#) for all user preferences, hosts, symbologies, and miscellaneous default parameters.

**Table 12-1** Symbology Default Table

Parameter	Default	Page Number
<b>UPC/EAN</b>		
UPC-A	Enable	<a href="#">12-5</a>
UPC-E	Enable	<a href="#">12-5</a>
UPC-E1	Disable	<a href="#">12-6</a>
EAN-8/JAN 8	Enable	<a href="#">12-18</a>
EAN-13/JAN 13	Enable	<a href="#">12-7</a>
Bookland EAN	Disable	<a href="#">12-8</a>
Decode UPC/EAN/JAN Supplementals (2 and 5 digits)	Ignore	<a href="#">12-9</a>
User-Programmable Supplementals Supplemental 1: Supplemental 2:		<a href="#">12-12</a>
UPC/EAN/JAN Supplemental Redundancy	7	<a href="#">12-12</a>
Transmit UPC-A Check Digit	Enable	<a href="#">12-13</a>
Transmit UPC-E Check Digit	Enable	<a href="#">12-13</a>
Transmit UPC-E1 Check Digit	Enable	<a href="#">12-13</a>
UPC-A Preamble	System Character	<a href="#">12-14</a>
UPC-E Preamble	System Character	<a href="#">12-15</a>
UPC-E1 Preamble	System Character	<a href="#">12-16</a>
Convert UPC-E to A	Disable	<a href="#">12-17</a>
Convert UPC-E1 to A	Disable	<a href="#">12-18</a>
EAN-8/JAN-8 Extend	Disable	<a href="#">12-18</a>
Bookland ISBN Format	ISBN-10	<a href="#">12-19</a>
UPC/EAN Security Levels	0	<a href="#">12-20</a>
UCC Coupon Extended Code	Disable	<a href="#">12-21</a>

**Table 12-1** Symbology Default Table (continued)

Parameter	Default	Page Number
<b>Code 128</b>		
Code 128	Enable	<a href="#">12-22</a>
UCC/EAN-128	Enable	<a href="#">12-22</a>
ISBT 128	Enable	<a href="#">12-23</a>
<b>Code 39</b>		
Code 39	Enable	<a href="#">12-24</a>
Trioptic Code 39	Disable	<a href="#">12-24</a>
Convert Code 39 to Code 32 (Italian Pharmacy Code)	Disable	<a href="#">12-25</a>
Code 32 Prefix	Disable	<a href="#">12-25</a>
Set Length(s) for Code 39	2 to 55	<a href="#">12-26</a>
Code 39 Check Digit Verification	Disable	<a href="#">12-27</a>
Transmit Code 39 Check Digit	Disable	<a href="#">12-27</a>
Code 39 Full ASCII Conversion	Disable	<a href="#">12-28</a>
Buffer Code 39	Disable	<a href="#">12-29</a>
<b>Code 93</b>		
Code 93	Disable	<a href="#">12-32</a>
Set Length(s) for Code 93	4 to 55	<a href="#">12-33</a>
<b>Code 11</b>		
Code 11	Disable	<a href="#">12-34</a>
Set Lengths for Code 11	4 to 55	<a href="#">12-35</a>
Code 11 Check Digit Verification	Disable	<a href="#">12-36</a>
Transmit Code 11 Check Digit(s)	Disable	<a href="#">12-37</a>
<b>Interleaved 2 of 5 (ITF)</b>		
Interleaved 2 of 5 (ITF)	Enable	<a href="#">12-38</a>
Set Lengths for I 2 of 5	14	<a href="#">12-39</a>
I 2 of 5 Check Digit Verification	Disable	<a href="#">12-40</a>
Transmit I 2 of 5 Check Digit	Disable	<a href="#">12-41</a>
Convert I 2 of 5 to EAN 13	Disable	<a href="#">12-41</a>

**Table 12-1** Symbology Default Table (continued)

Parameter	Default	Page Number
<b>Discrete 2 of 5 (DTF)</b>		
Discrete 2 of 5	Disable	<a href="#">12-42</a>
Set Length(s) for D 2 of 5	12	<a href="#">12-43</a>
<b>Chinese 2 of 5</b>		
Enable/Disable Chinese 2 of 5	Disable	<a href="#">12-44</a>
<b>Codabar (NW - 7)</b>		
Codabar	Disable	<a href="#">12-45</a>
Set Lengths for Codabar	5 to 55	<a href="#">12-46</a>
CLSI Editing	Disable	<a href="#">12-47</a>
NOTIS Editing	Disable	<a href="#">12-47</a>
<b>MSI</b>		
MSI	Disable	<a href="#">12-48</a>
Set Length(s) for MSI	4 to 55	<a href="#">12-49</a>
MSI Check Digits	One	<a href="#">12-50</a>
Transmit MSI Check Digit	Disable	<a href="#">12-50</a>
MSI Check Digit Algorithm	Mod 10/Mod 10	<a href="#">12-51</a>
<b>GS1 DataBar (Formerly RSS, Reduced Space Symbology)</b>		
GS1 DataBar-14	Disable	<a href="#">12-52</a>
GS1 DataBar Limited	Disable	<a href="#">12-52</a>
GS1 DataBar Expanded	Disable	<a href="#">12-53</a>
Convert GS1 DataBar to UPC/EAN	Disable	<a href="#">12-53</a>
<b>Symbology - Specific Security Levels</b>		
Redundancy Level	1	<a href="#">12-54</a>
Security Level	0	<a href="#">12-56</a>
Bi-directional Redundancy	Disable	<a href="#">12-58</a>
Intercharacter Gap Size	Normal	<a href="#">12-58</a>
Report Version		<a href="#">12-59</a>
Report MIMIC Version		<a href="#">12-59</a>
Report Synapse Cable		<a href="#">12-59</a>

---

## UPC/EAN

### Enable/Disable UPC-A/UPC-E

To enable or disable UPC-A or UPC-E, scan the appropriate bar code below.

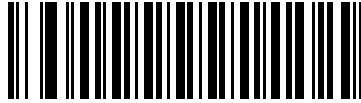

**\*Enable UPC-A**



**Disable UPC-A**

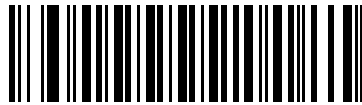

**\*Enable UPC-E**



**Disable UPC-E**

## Enable/Disable UPC-E1

UPC-E1 is disabled by default.

To enable or disable UPC-E1, scan the appropriate bar code below.

✓ **NOTE** UPC-E1 is not a UCC (Uniform Code Council) approved symbology.



**Enable UPC-E1**



**\*Disable UPC-E1**

## Enable/Disable EAN-13/EAN-8

To enable or disable EAN-13 or EAN-8, scan the appropriate bar code below.



**\*Enable EAN-13**

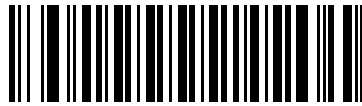

**Disable EAN-13**

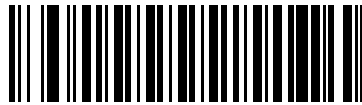

**\*Enable EAN-8**



**Disable EAN-8**

## Enable/Disable Bookland EAN

To enable or disable Bookland EAN, scan the appropriate bar code below.



**Enable Bookland EAN**



**\*Disable Bookland EAN**



**NOTE** If you enable Bookland EAN, select a *Bookland ISBN Format* on page 12-19. Also select either Decode UPC/EAN Supplementals, Autodiscriminate UPC/EAN Supplementals, or Enable 978/979 Supplemental Mode in *Decode UPC/EAN/JAN Supplementals* on page 12-9.



## Decode UPC/EAN/JAN Supplementals

Supplementals are additionally appended characters (2 or 5) according to specific code format conventions (e.g., UPC A+2, UPC E+2, EAN 8+2). The following options are available:

- If you select **Ignore UPC/EAN Supplementals**, and the scanner is presented with a UPC/EAN plus supplemental symbol, the scanner decodes UPC/EAN and ignores the supplemental characters.
- If you select **Decode UPC/EAN with Supplementals**, the scanner only decodes UPC/EAN symbols with supplemental characters, and ignores symbols without supplementals.
- If you select **Autodiscriminate UPC/EAN Supplementals**, the scanner decodes UPC/EAN symbols with supplemental characters immediately. If the symbol does not have a supplemental, the scanner must decode the bar code the number of times set via [UPC/EAN/JAN Supplemental Redundancy on page 12-12](#) before transmitting its data to confirm that there is no supplemental.
- If you select one of the following **Supplemental Mode** options, the scanner immediately transmits EAN-13 bar codes starting with that prefix that have supplemental characters. If the symbol does not have a supplemental, the scanner must decode the bar code the number of times set via [UPC/EAN/JAN Supplemental Redundancy on page 12-12](#) before transmitting its data to confirm that there is no supplemental. The scanner transmits UPC/EAN bar codes that do not have that prefix immediately.
  - **Enable 378/379 Supplemental Mode**
  - **Enable 978/979 Supplemental Mode**

✓ **NOTE** If you select 978/979 Supplemental Mode and are scanning Bookland EAN bar codes, see [Enable/Disable Bookland EAN on page 12-8](#) to enable Bookland EAN, and select a format using [Bookland ISBN Format on page 12-19](#).

- **Enable 977 Supplemental Mode**
- **Enable 414/419/434/439 Supplemental Mode**
- **Enable 491 Supplemental Mode**
- **Enable Smart Supplemental Mode** - applies to EAN-13 bar codes starting with any prefix listed previously.
- **Supplemental User-Programmable Type 1** - applies to EAN-13 bar codes starting with a 3-digit user-defined prefix. Set this 3-digit prefix using [User-Programmable Supplementals on page 12-12](#).
- **Supplemental User-Programmable Type 1 and 2** - applies to EAN-13 bar codes starting with either of two 3-digit user-defined prefixes. Set the 3-digit prefixes using [User-Programmable Supplementals on page 12-12](#).
- **Smart Supplemental Plus User-Programmable 1** - applies to EAN-13 bar codes starting with any prefix listed previously or the user-defined prefix set using [User-Programmable Supplementals on page 12-12](#).
- **Smart Supplemental Plus User-Programmable 1 and 2** - applies to EAN-13 bar codes starting with any prefix listed previously or one of the two user-defined prefixes set using [User-Programmable Supplementals on page 12-12](#).

✓ **NOTE** To minimize the risk of invalid data transmission, select either to decode or ignore supplemental characters.

## Decode UPC/EAN/JAN Supplementals (continued)



**\*Ignore UPC/EAN/JAN With Supplementals**



**Decode UPC/EAN/JAN Only With Supplementals**



**Autodiscriminate UPC/EAN/JAN Supplementals**



**Enable 378/379 Supplemental Mode**



**Enable 978/979 Supplemental Mode**



**Enable 977 Supplemental Mode**



**Enable 414/419/434/439 Supplemental Mode**

### Decode UPC/EAN/JAN Supplementals (continued)



**Enable 491 Supplemental Mode**



**Enable Smart Supplemental Mode**



**Supplemental User-Programmable Type 1**



**Supplemental User-Programmable Type 1 and 2**



**Smart Supplemental Plus User-Programmable 1**



**Smart Supplemental Plus User-Programmable 1 and 2**

## User-Programmable Supplementals

If you selected a Supplemental User-Programmable option from *Decode UPC/EAN/JAN Supplementals on page 12-9*, select **User-Programmable Supplemental 1** to set the 3-digit prefix. Then select the 3 digits using the numeric bar codes beginning on [page D-1](#). Select **User-Programmable Supplemental 2** to set a second 3-digit prefix. Then select the 3 digits using the numeric bar codes beginning on [page D-1](#).



Supplemental User-Programmable 1



Supplemental User-Programmable 2

## UPC/EAN/JAN Supplemental Redundancy

If you selected **Autodiscriminate UPC/EAN/JAN Supplementals** or one of the supplemental modes, this option adjusts the number of times to decode a symbol without supplementals before transmission. The range is from two to thirty times. Five or above is recommended when decoding a mix of UPC/EAN symbols with and without supplementals. The default is 7.

Scan the bar code below to set a decode redundancy value. Next, scan two numeric bar codes beginning on [page D-1](#) in [Appendix D, Numeric Bar Codes](#). Include a leading zero for single digit numbers. To correct an error or change a selection, scan **Cancel** on [page D-3](#).

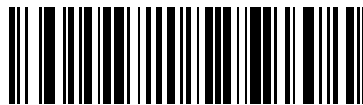

UPC/EAN/JAN Supplemental Redundancy

## Transmit UPC-A/UPC-E/UPC-E1 Check Digit

The check digit is the last character of the symbol used to verify the integrity of the data. Scan the appropriate bar code below to transmit the bar code data with or without the UPC-A, UPC-E or UPC-E1 check digit. It is always verified to guarantee the integrity of the data.

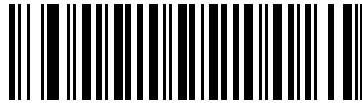

**\*Transmit UPC-A Check Digit**

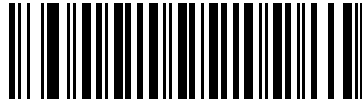

**Do Not Transmit UPC-A Check Digit**

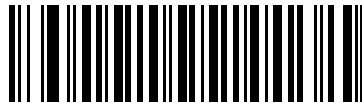

**\*Transmit UPC-E Check Digit**



**Do Not Transmit UPC-E Check Digit**



**\*Transmit UPC-E1 Check Digit**



**Do Not Transmit UPC-E1 Check Digit**

## UPC-A Preamble

Preamble characters are part of the UPC symbol consisting of Country Code and System Character. There are three options for transmitting UPC-A preamble to the host device: transmit System Character only, transmit System Character and Country Code ("0" for USA), and transmit no preamble. Select the appropriate option to match the host system.

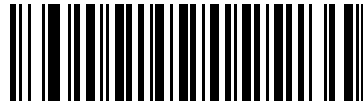

**No Preamble**  
(<DATA>)

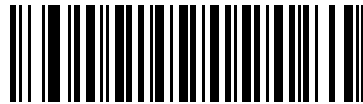

**\*System Character**  
(<SYSTEM CHARACTER> <DATA>)

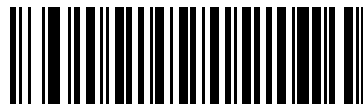

**System Character & Country Code**  
(< COUNTRY CODE> <SYSTEM CHARACTER> <DATA>)

## UPC-E Preamble

Preamble characters are part of the UPC symbol consisting of Country Code and System Character. There are three options for transmitting UPC-E preamble to the host device: transmit System Character only, transmit System Character and Country Code ("0" for USA), and transmit no preamble. Select the appropriate option to match the host system.

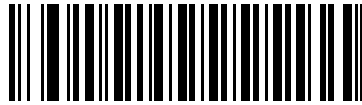

**No Preamble**  
(<DATA>)

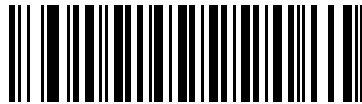

**\*System Character**  
(<SYSTEM CHARACTER> <DATA>)

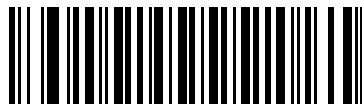

**System Character & Country Code**  
(< COUNTRY CODE> <SYSTEM CHARACTER> <DATA>)

## UPC-E1 Preamble

Preamble characters are part of the UPC symbol consisting of Country Code and System Character. There are three options for transmitting UPC-E1 preamble to the host device: transmit System Character only, transmit System Character and Country Code ("0" for USA), and transmit no preamble. Select the appropriate option to match the host system.



**No Preamble**  
(<DATA>)

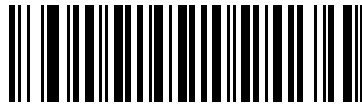

**\*System Character**  
(<SYSTEM CHARACTER> <DATA>)

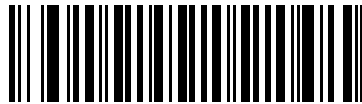

**System Character & Country Code**  
(< COUNTRY CODE> <SYSTEM CHARACTER> <DATA>)



## Convert UPC-E to UPC-A

Enable this to convert UPC-E (zero suppressed) decoded data to UPC-A format before transmission. After conversion, the data follows UPC-A format and is affected by UPC-A programming selections (e.g., Preamble, Check Digit).

Disable this to transmit UPC-E decoded data as UPC-E data, without conversion.

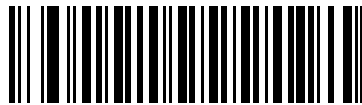

**Convert UPC-E to UPC-A  
(Enable)**

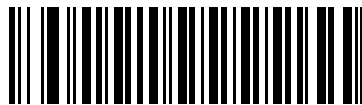

**\*Do Not Convert UPC-E to UPC-A  
(Disable)**

## Convert UPC-E1 to UPC-A

Enable this to convert UPC-E1 decoded data to UPC-A format before transmission. After conversion, the data follows UPC-A format and is affected by UPC-A programming selections (e.g., Preamble, Check Digit).

Disable this to transmit UPC-E1 decoded data as UPC-E1 data, without conversion.

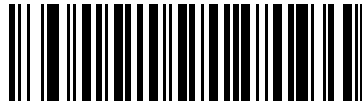

**Convert UPC-E1 to UPC-A  
(Enable)**

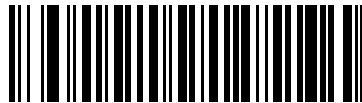

**\*Do Not Convert UPC-E1 to UPC-A  
(Disable)**

## EAN-8/JAN-8 Extend

Enable this to add five leading zeros to decoded EAN-8 symbols to make them compatible in format to EAN-13 symbols.

Disable this to transmit EAN-8 symbols as is.



**Enable EAN/JAN Zero Extend**



**\*Disable EAN/JAN Zero Extend**

## Bookland ISBN Format

If you enabled Bookland EAN using *Enable/Disable Bookland EAN on page 12-8*, select one of the following formats for Bookland data:

- **Bookland ISBN-10** - The scanner reports Bookland data starting with 978 in traditional 10-digit format with the special Bookland check digit for backward-compatibility. Data starting with 979 is not considered Bookland in this mode.
- **Bookland ISBN-13** - The scanner reports Bookland data (starting with either 978 or 979) as EAN-13 in 13-digit format to meet the 2007 ISBN-13 protocol.



**\*Bookland ISBN-10**



**Bookland ISBN-13**



**NOTE** For Bookland EAN to function properly, first enable Bookland EAN using *Enable/Disable Bookland EAN on page 12-8*, then select either Decode UPC/EAN Supplementals, Autodiscriminate UPC/EAN Supplementals, or Enable 978/979 Supplemental Mode in *Decode UPC/EAN/JAN Supplementals on page 12-9*.

## UPC/EAN Security Level

The scanner offers four levels of decode security for UPC/EAN bar codes. Select higher levels of security for decreasing levels of bar code quality. There is an inverse relationship between security and scanner decode speed, so be sure to choose only that level of security necessary for any given application.

### UPC/EAN Security Level 0

This is the default setting which allows the scanner to operate fastest, while providing sufficient security in decoding “in-spec” UPC/EAN bar codes.



**\*UPC/EAN Security Level 0**

### UPC/EAN Security Level 1

As bar code quality levels diminish, certain characters become prone to misdecodes before others (i.e., 1, 2, 7, 8). If you are experiencing misdecodes of poorly printed bar codes, and the misdecodes are limited to these characters, select this security level.



**UPC/EAN Security Level 1**

### UPC/EAN Security Level 2

If you are experiencing misdecodes of poorly printed bar codes, and the misdecodes are not limited to characters 1, 2, 7, and 8, select this security level.



**UPC/EAN Security Level 2**

### UPC/EAN Security Level 3

If you have tried Security Level 2, and still experience misdecodes, select this security level. Be advised, selecting this option is an extreme measure against misdecoding severely out of spec bar codes. Selecting this level of security can significantly impair the scanner’s decoding ability. If this level of security is necessary, try to improve the quality of your bar codes.



**UPC/EAN Security Level 3**

## UCC Coupon Extended Code

Enable this to decode UPC-A bar codes starting with digit '5', EAN-13 bar codes starting with digit '99', and UPCA/EAN-128 Coupon Codes. You must enable UPC-A, EAN-13, and EAN-128 to scan all types of Coupon Codes.



**Enable UCC Coupon Extended Code**

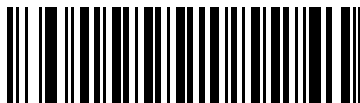

**\*Disable UCC Coupon Extended Code**



**NOTE** The Decode UPC/EAN Supplemental Redundancy parameter controls autodiscrimination of the EAN128 (right half) of a coupon code.

---

## Code 128

### Enable/Disable Code 128

To enable or disable Code 128, scan the appropriate bar code below.

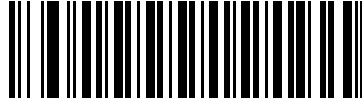

**\*Enable Code 128**

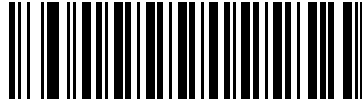

**Disable Code 128**

### Enable/Disable UCC/EAN-128

To enable or disable UCC/EAN-128, scan the appropriate bar code below.



**\*Enable UCC/EAN-128**



**Disable UCC/EAN-128**

## Enable/Disable ISBT 128

To enable or disable ISBT 128, scan the appropriate bar code below.



**\*Enable ISBT 128**

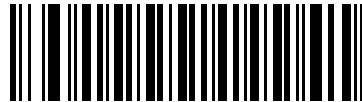

**Disable ISBT 128**

---

## Code 39

### Enable/Disable Code 39

To enable or disable Code 39, scan the appropriate bar code below.

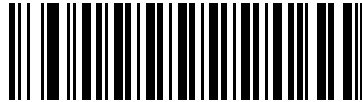

**\*Enable Code 39**

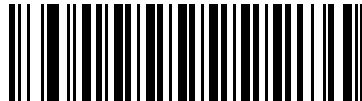

**Disable Code 39**

### Enable/Disable Trioptic Code 39

Trioptic Code 39 is a variant of Code 39 used in the marking of computer tape cartridges. Trioptic Code 39 symbols always contain six characters. To enable or disable Trioptic Code 39, scan the appropriate bar code below.



**Enable Trioptic Code 39**



**\*Disable Trioptic Code 39**



**NOTE** Trioptic Code 39 and Code 39 Full ASCII cannot be enabled simultaneously.



## Convert Code 39 to Code 32

Code 32 is a variant of Code 39 used by the Italian pharmaceutical industry. Scan the appropriate bar code below to enable or disable converting Code 39 to Code 32.

✓ **NOTE** Enable Code 39 in order for this parameter to function.

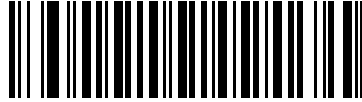

**Enable Convert Code 39 to Code 32**

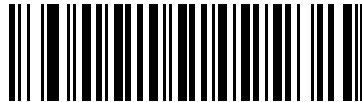

**\*Disable Convert Code 39 to Code 32**

## Code 32 Prefix

Scan the appropriate bar code below to enable or disable adding the prefix character "A" to all Code 32 bar codes.

✓ **NOTE** Convert Code 39 to Code 32 must be enabled for this parameter to function.



**Enable Code 32 Prefix**



**\*Disable Code 32 Prefix**

## Set Lengths for Code 39

The length of a code refers to the number of characters (i.e., human readable characters), including check digit(s) the code contains. Set lengths for Code 39 for any length, one or two discrete lengths, or lengths within a specific range. If you enabled Code 39 Full ASCII, the preferred options are **Length Within a Range** or **Any Length**.

✓ **NOTE** When setting lengths for different bar code types, include a leading zero when scanning single digit numbers.

**One Discrete Length** - Select this option to decode only Code 39 symbols containing a selected length. Select the length using the numeric bar codes in [Appendix D, Numeric Bar Codes](#). For example, to decode only Code 39 symbols with 14 characters, scan **Code 39 - One Discrete Length**, then scan 1 followed by 4. To correct an error or change a selection, scan **Cancel** on [page D-3](#).



**Code 39 - One Discrete Length**

**Two Discrete Lengths** - Select this option to decode only Code 39 symbols containing either of two selected lengths. Select the lengths using the numeric bar codes in [Appendix D, Numeric Bar Codes](#). For example, to decode only those Code 39 symbols containing either 2 or 14 characters, select **Code 39 - Two Discrete Lengths**, then scan 0, 2, 1, and then 4. To correct an error or change a selection, scan **Cancel** on [page D-3](#).

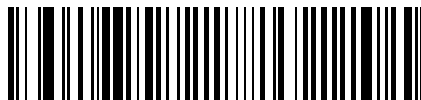

**Code 39 - Two Discrete Lengths**

**Length Within Range** - Select this option to decode a Code 39 symbol within a specific length range. Select the lengths using the numeric bar codes in [Appendix D, Numeric Bar Codes](#). For example, to decode Code 39 symbols containing between 4 and 12 characters, first scan **Code 39 - Length Within Range**. Then scan 0, 4, 1, and 2 (include a leading zero for single digit numbers). To correct an error or change a selection, scan **Cancel** on [page D-3](#).



**Code 39 - Length Within Range**

**Any Length** - Scan this option to decode Code 39 symbols containing any number of characters within the scanner capability.



**Code 39 - Any Length**

## Code 39 Check Digit Verification

Enable this feature to check the integrity of all Code 39 symbols to verify that the data complies with specified check digit algorithm. If you enable this feature, only Code 39 symbols which include a modulo 43 check digit are decoded. Only enable this if your Code 39 symbols contain a Modulo 43 check digit.

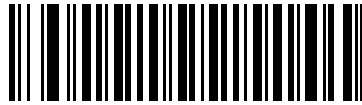

**Enable Code 39 Check Digit**

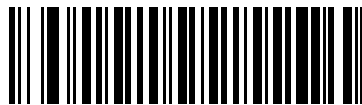

**\*Disable Code 39 Check Digit**

## Transmit Code 39 Check Digit

Scan a bar code below to transmit Code 39 data with or without the check digit.

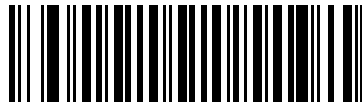

**Transmit Code 39 Check Digit  
(Enable)**

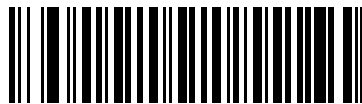

**\*Do Not Transmit Code 39 Check Digit  
(Disable)**



**NOTE** You must enable Code 39 Check Digit Verification for this parameter to function.

## Code 39 Full ASCII Conversion

Code 39 Full ASCII is a variant of Code 39 which pairs characters to encode the full ASCII character set. To enable or disable Code 39 Full ASCII, scan the appropriate bar code below.

See [Table 5-2](#) and for the mapping of Code 39 characters to ASCII values.



**Enable Code 39 Full ASCII**

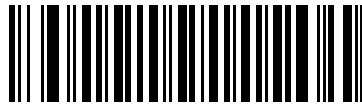

**\*Disable Code 39 Full ASCII**



**NOTE** You cannot enable Trioptic Code 39 and Code 39 Full ASCII simultaneously.

Code 39 Full ASCII to Full ASCII Correlation is host-dependent; see the ASCII Character Set Table for the appropriate interface. See [page 5-3](#) for the Wedge Host conversion table, [page 7-3](#) for the USB Host conversion table, and [page 6-3](#) for the RS-232 Host conversion table.

## Code 39 Buffering (Scan & Store)

This feature allows the scanner to accumulate data from multiple Code 39 symbols.

Select the Scan and Store option (Buffer Code 39) to temporarily buffer all Code 39 symbols with a leading space as a first character for later transmission. The leading space is not buffered.

Decoding a valid Code 39 symbol with no leading space transmits in sequence all buffered data in a first-in first-out format, plus the “triggering” symbol. See the following pages for details.

Select **Do Not Buffer Code 39** to transmit all decoded Code 39 symbols immediately without storing them in the buffer.

This feature affects Code 39 only. If you select **Buffer Code 39**, Motorola recommends configuring the scanner to decode Code 39 symbology only.



**Buffer Code 39  
(Enable)**



**\*Do Not Buffer Code 39  
(Disable)**

While there is data in the transmission buffer, you cannot select **Do Not Buffer Code 39**. The buffer holds 200 bytes of information.

To disable Code 39 buffering when there is data in the transmission buffer, first force the buffer transmission (see [Transmit Buffer on page 12-30](#)) or clear the buffer.

### Buffer Data

To buffer data, Code 39 buffering must be enabled and a Code 39 symbol must be read with a space immediately following the start pattern.

- Unless the data overflows the transmission buffer, the scanner issues a low/high beep to indicate successful decode and buffering. (For overflow conditions, see [Overfilling Transmission Buffer](#).)
- The scanner adds the decoded data excluding the leading space to the transmission buffer.
- No transmission occurs.

### Clear Transmission Buffer

To clear the transmission buffer, scan the **Clear Buffer** bar code below, which contains only a start character, a dash (minus), and a stop character.

- The scanner issues a short high/low/high beep.
- The scanner erases the transmission buffer.
- No transmission occurs.



**Clear Buffer**



**NOTE** The Clear Buffer contains only the dash (minus) character. In order to scan this command, set Code 39 length to include length 1.

### Transmit Buffer

There are two methods to transmit the Code 39 buffer.

1. Scan the **Transmit Buffer** bar code below, which contains only a start character, a plus (+), and a stop character.
  - The scanner transmits and clears the buffer.
  - The scanner issues a low/high beep.



**Transmit Buffer**

2. Scan a Code 39 bar code with a leading character other than a space.
  - The scanner appends new decode data to buffered data.
  - The scanner transmits and clears the buffer.
  - The scanner signals that the buffer transmitted with a low/high beep.
  - Scanner transmits and clears the buffer.



**NOTE** The Transmit Buffer contains only a plus (+) character. In order to scan this command, set Code 39 length to include length 1.

### **Overfilling Transmission Buffer**

The Code 39 buffer holds 200 characters. If the symbol just read results in an overflow of the transmission buffer:

- The scanner indicates that the symbol was rejected by issuing three long, high beeps.
- No transmission occurs. The data in the buffer is not affected.

### **Attempt to Transmit an Empty Buffer**

If the symbol just read was the **Transmit Buffer** symbol and the Code 39 buffer is empty:

- A short low/high/low beep signals that the buffer is empty.
- No transmission occurs.
- The buffer remains empty.

---

## Code 93

### Enable/Disable Code 93

To enable or disable Code 93, scan the appropriate bar code below.

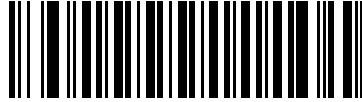

**Enable Code 93**

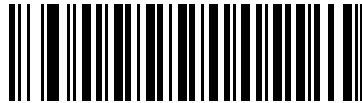

**\*Disable Code 93**



## Set Lengths for Code 93

The length of a code refers to the number of characters (i.e., human readable characters), including check digit(s) the code contains. Set lengths for Code 93 for any length, one or two discrete lengths, or lengths within a specific range.

**One Discrete Length** - Select this option to decode only Code 93 symbols containing a selected length. Select the length using the numeric bar codes in [Appendix D, Numeric Bar Codes](#). For example, to decode only Code 93 symbols with 14 characters, scan **Code 93 - One Discrete Length**, then scan **1** followed by **4**. To correct an error or change the selection, scan **Cancel** on [page D-3](#).



**Code 93 - One Discrete Length**

**Two Discrete Lengths** - Select this option to decode only Code 93 symbols containing either of two selected lengths. Select the lengths using the numeric bar codes in [Appendix D, Numeric Bar Codes](#). For example, to decode only those Code 93 symbols containing either 2 or 14 characters, select **Code 93 - Two Discrete Lengths**, then scan **0, 2, 1**, and then **4**. To correct an error or change the selection, scan **Cancel** on [page D-3](#).



**Code 93 - Two Discrete Lengths**

**Length Within Range** - Select this option to decode a Code 93 symbol within a specific length range. Select the length range using the numeric bar codes in [Appendix D, Numeric Bar Codes](#). For example, to decode Code 93 symbols containing between 4 and 12 characters, first scan **Code 93 - Length Within Range**. Then scan **0, 4, 1**, and **2** (include a leading zero for single digit numbers). To correct an error or change the selection, scan **Cancel** on [page D-3](#).



**Code 93 - Length Within Range**

**Any Length** - Scan this option to decode Code 93 symbols containing any number of characters within the scanner's capability.



**Code 93 - Any Length**

---

## Code 11

### Code 11

To enable or disable Code 11, scan the appropriate bar code below.

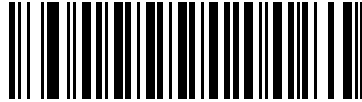

**Enable Code 11**

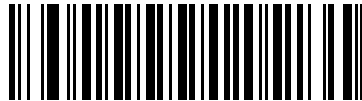

**\*Disable Code 11**

## Set Lengths for Code 11

The length of a code refers to the number of characters (i.e., human readable characters), including check digit(s) the code contains. Set lengths for Code 11 for any length, one or two discrete lengths, or lengths within a specific range.

**One Discrete Length** - Select this option to decode only Code 11 symbols containing a selected length. Select the length using the numeric bar codes in [Appendix D, Numeric Bar Codes](#). For example, to decode only Code 11 symbols with 14 characters, scan **Code 11 - One Discrete Length**, then scan **1** followed by **4**. To correct an error or change a selection, scan **Cancel** on [page D-3](#).

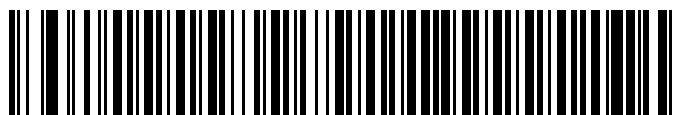

**Code 11 - One Discrete Length**

**Two Discrete Lengths** - Select this option to decode only Code 11 symbols containing either of two selected lengths. Select the lengths using the numeric bar codes in [Appendix D, Numeric Bar Codes](#). For example, to decode only those Code 11 symbols containing either 2 or 14 characters, select **Code 11 - Two Discrete Lengths**, then scan **0, 2, 1**, and then **4**. To correct an error or change a selection, scan **Cancel** on [page D-3](#).

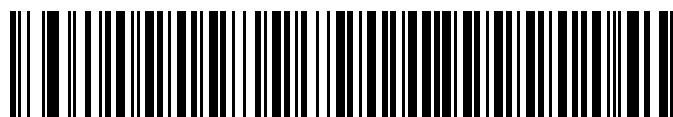

**Code 11 - Two Discrete Lengths**

**Length Within Range** - Select this option to decode a Code 11 symbol within a specific length range. Select the length range using the numeric bar codes in [Appendix D, Numeric Bar Codes](#). For example, to decode Code 11 symbols containing between 4 and 12 characters, first scan **Code 11 - Length Within Range**. Then scan **0, 4, 1**, and **2** (include a leading zero for single digit numbers). To correct an error or change a selection, scan **Cancel** on [page D-3](#).



**Code 11 - Length Within Range**

**Any Length** - Scan this option to decode Code 11 symbols containing any number of characters within the scanner's capability.



**Code 11 - Any Length**

## Code 11 Check Digit Verification

Enable this feature to check the integrity of all Code 11 symbols to verify that the data complies with the specified check digit algorithm. This selects the check digit mechanism for the decoded Code 11 bar code. The options are to check for one check digit, check for two check digits, or disable the feature.

To enable this feature, scan the bar code below corresponding to the number of check digits encoded in your Code 11 symbols.



**\*Disable**



**One Check Digit**



**Two Check Digits**

## Transmit Code 11 Check Digits

This feature selects whether or not to transmit the Code 11 check digit(s).

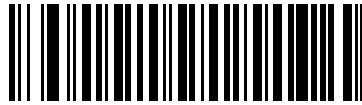

**Transmit Code 11 Check Digit(s)  
(Enable)**

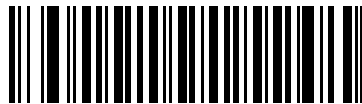

**\*Do Not Transmit Code 11 Check Digit(s)  
(Disable)**



**NOTE** You must enable Code 11 Check Digit Verification for this parameter to function.

---

## Interleaved 2 of 5 (ITF)

### Enable/Disable Interleaved 2 of 5

To enable or disable Interleaved 2 of 5, scan the appropriate bar code below, and select an Interleaved 2 of 5 length from the following pages.

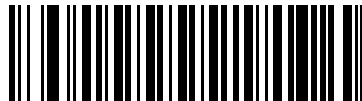

**\*Enable Interleaved 2 of 5**

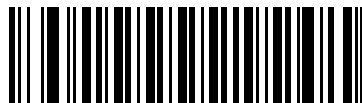

**Disable Interleaved 2 of 5**

## Set Lengths for Interleaved 2 of 5

The length of a code refers to the number of characters (i.e., human readable characters), including check digit(s) the code contains. Set lengths for I 2 of 5 for any length, one or two discrete lengths, or lengths within a specific range.

**One Discrete Length** - Select this option to decode only I 2 of 5 symbols containing a selected length. Select the length using the numeric bar codes in [Appendix D, Numeric Bar Codes](#). For example, to decode only I 2 of 5 symbols with 14 characters, scan **I 2 of 5 - One Discrete Length**, then scan **1** followed by **4**. To correct an error or change a selection, scan **Cancel** on [page D-3](#).

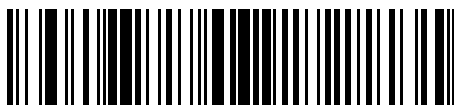

**I 2 of 5 - One Discrete Length**

**Two Discrete Lengths** - Select this option to decode only I 2 of 5 symbols containing either of two selected lengths. Select the lengths using the numeric bar codes in [Appendix D, Numeric Bar Codes](#). For example, to decode only those I 2 of 5 symbols containing either 2 or 14 characters, select **I 2 of 5 - Two Discrete Lengths**, then scan **0, 2, 1**, and then **4**. To correct an error or change a selection, scan **Cancel** on [page D-3](#).

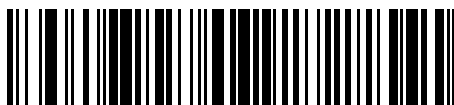

**I 2 of 5 - Two Discrete Lengths**

**Length Within Range** - Select this option to decode an I 2 of 5 symbol within a specific length range. Select the length range using the numeric bar codes in [Appendix D, Numeric Bar Codes](#). For example, to decode I 2 of 5 symbols containing between 4 and 12 characters, first scan **I 2 of 5 - Length Within Range**. Then scan **0, 4, 1**, and **2** (single digit numbers must always be preceded by a leading zero). To correct an error or change a selection, scan **Cancel** on [page D-3](#).

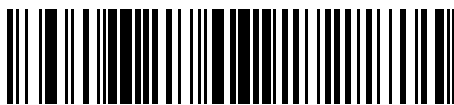

**I 2 of 5 - Length Within Range**

**Any Length** - Scan this option to decode I 2 of 5 symbols containing any number of characters within the scanner's capability.

- ✓ **NOTE** Due to the construction of the I 2 of 5 symbology, it is possible for a scan line covering only a portion of the code to transmit as a complete scan, yielding less data than is encoded in the bar code. To prevent this, Motorola recommends selecting specific lengths (I 2 of 5 - One Discrete Length, Two Discrete Lengths) for I 2 of 5 applications.



**I 2 of 5 - Any Length**

## I 2 of 5 Check Digit Verification

Enable this feature to check the integrity of all I 2 of 5 symbols to verify the data complies with either the specified Uniform Symbology Specification (USS), or the Optical Product Code Council (OPCC) check digit algorithm.



**\*Disable**



**USS Check Digit**



**OPCC Check Digit**



## Transmit I 2 of 5 Check Digit

Scan the appropriate bar code below to transmit I 2 of 5 data with or without the check digit.



**Transmit I 2 of 5 Check Digit  
(Enable)**



**\*Do Not Transmit I 2 of 5 Check Digit  
(Disable)**

## Convert I 2 of 5 to EAN-13

This parameter converts a 14 character I 2 of 5 code into EAN-13, and transmits to the host as EAN-13. To accomplish this, the I 2 of 5 code must be enabled, and the code must have a leading zero and a valid EAN-13 check digit.

Scan the **Convert I 2 of 5 to EAN-13 (Enable)** bar code to enable this function.



**Convert I 2 of 5 to EAN-13  
(Enable)**



**\*Do Not Convert I 2 of 5 to EAN-13  
(Disable)**

---

## Discrete 2 of 5 (DTF)

### Enable/Disable Discrete 2 of 5

To enable or disable Discrete 2 of 5, scan the appropriate bar code below.

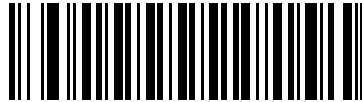

Enable Discrete 2 of 5

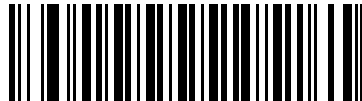

\*Disable Discrete 2 of 5

## Set Lengths for Discrete 2 of 5

The length of a code refers to the number of characters (i.e., human readable characters), including check digit(s) the code contains. Set lengths for D 2 of 5 for any length, one or two discrete lengths, or lengths within a specific range.

**One Discrete Length** - Select this option to decode only D 2 of 5 symbols containing a selected length. Select the length using the numeric bar codes in [Appendix D, Numeric Bar Codes](#). For example, to decode only D 2 of 5 symbols with 14 characters, scan **D 2 of 5 - One Discrete Length**, then scan **1** followed by **4**. To correct an error or change a selection, scan **Cancel** on [page D-3](#).



**D 2 of 5 - One Discrete Length**

**Two Discrete Lengths** - Select this option to decode only D 2 of 5 symbols containing either of two selected lengths. Select the lengths using the numeric bar codes in [Appendix D, Numeric Bar Codes](#). For example, to decode only those D 2 of 5 symbols containing either 2 or 14 characters, select **D 2 of 5 - Two Discrete Lengths**, then scan **0, 2, 1**, and then **4**. To correct an error or change a selection, scan **Cancel** on [page D-3](#).



**D 2 of 5 - Two Discrete Lengths**

**Length Within Range** - Select this option to decode a D 2 of 5 symbol within a specific length range. Select the length range using the numeric bar codes in [Appendix D, Numeric Bar Codes](#). For example, to decode D 2 of 5 symbols containing between 4 and 12 characters, first scan **D 2 of 5 - Length Within Range**. Then scan **0, 4, 1**, and **2** (single digit numbers must always be preceded by a leading zero). To correct an error or change a selection, scan **Cancel** on [page D-3](#).



**D 2 of 5 - Length Within Range**

**Any Length** - Scan this option to decode D 2 of 5 symbols containing any number of characters within the scanner's capability.



**NOTE** Due to the construction of the D 2 of 5 symbology, it is possible for a scan line covering only a portion of the code to transmit as a complete scan, yielding less data than is encoded in the bar code. To prevent this, Motorola recommends selecting specific lengths (D 2 of 5 - One Discrete Length, Two Discrete Lengths) for D 2 of 5 applications.



**D 2 of 5 - Any Length**

---

## Chinese 2 of 5

### Enable/Disable Chinese 2 of 5

To enable or disable Chinese 2 of 5, scan the appropriate bar code below.



**Enable Chinese 2 of 5**



**\*Disable Chinese 2 of 5**

---

## Codabar (NW - 7)

### Enable/Disable Codabar

To enable or disable Codabar, scan the appropriate bar code below.

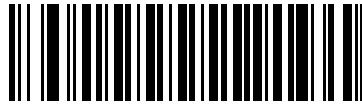

**Enable Codabar**

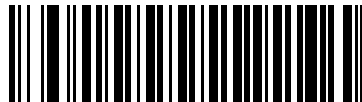

**\*Disable Codabar**

## Set Lengths for Codabar

The length of a code refers to the number of characters (i.e., human readable characters), including check digit(s) the code contains. Set lengths for Codabar for any length, one or two discrete lengths, or lengths within a specific range.

**One Discrete Length** - Select this option to decode only Codabar symbols containing a selected length. Select the length from the numeric bar codes in [Appendix D, Numeric Bar Codes](#). For example, to decode only Codabar symbols with 14 characters, scan **Codabar - One Discrete Length**, then scan 1 followed by 4. To correct an error or change a selection, scan **Cancel** on [page D-3](#).



**Codabar - One Discrete Length**

**Two Discrete Lengths** - Select this option to decode only Codabar symbols containing either of two selected lengths. Select the lengths from the numeric bar codes in [Appendix D, Numeric Bar Codes](#). For example, to decode only those Codabar symbols containing either 2 or 14 characters, select **Codabar - Two Discrete Lengths**, then scan 0, 2, 1, and then 4. To correct an error or change a selection, scan **Cancel** on [page D-3](#).



**Codabar - Two Discrete Lengths**

**Length Within Range** - Select this option to decode a Codabar symbol with a specific length range. Select the length range from the numeric bar codes in [Appendix D, Numeric Bar Codes](#). For example, to decode Codabar symbols containing between 4 and 12 characters, first scan **Codabar - Length Within Range**. Then scan 0, 4, 1, and 2 (include a leading zero for single digit numbers). To correct an error or change a selection, scan **Cancel** on [page D-3](#).



**Codabar - Length Within Range**

**Any Length** - Scan this option to decode Codabar symbols containing any number of characters within the scanner's capability.



**Codabar - Any Length**

## CLSI Editing

Enable this to strip the start and stop characters and insert a space after the first, fifth, and tenth characters of a 14-character Codabar symbol. Use this feature if your host system requires this data format.



**NOTE** Symbol length does not include start and stop characters.

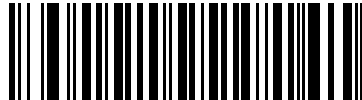

Enable CLSI Editing



\*Disable CLSI Editing

## NOTIS Editing

Enable this to strips the start and stop characters from a decoded Codabar symbol. Use this feature if your host system requires this data format.



Enable NOTIS Editing



\*Disable NOTIS Editing

---

## MSI

### Enable/Disable MSI

To enable or disable MSI, scan the appropriate bar code below.

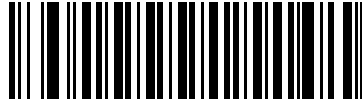

**Enable MSI**

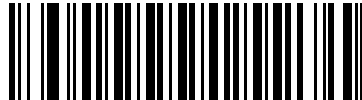

**\*Disable MSI**



## Set Lengths for MSI

The length of a code refers to the number of characters (i.e., human readable characters), including check digit(s) the code contains. Set lengths for MSI for any length, one or two discrete lengths, or lengths within a specific range.

**One Discrete Length** - Select this option to decode only MSI symbols containing a selected length. Select the length using the numeric bar codes in [Appendix D, Numeric Bar Codes](#). For example, to decode only MSI symbols with 14 characters, scan **MSI - One Discrete Length**, then scan **1** followed by **4**. To correct an error or change a selection, scan **Cancel** on [page D-3](#).



**MSI - One Discrete Length**

**Two Discrete Lengths** - Select this option to decode only MSI symbols containing either of two selected lengths. Select the lengths using the numeric bar codes in [Appendix D, Numeric Bar Codes](#). For example, to decode only those MSI symbols containing either 2 or 14 characters, select **MSI - Two Discrete Lengths**, then scan **0, 2, 1**, and then **4**. To correct an error or change a selection, scan **Cancel** on [page D-3](#).



**MSI - Two Discrete Lengths**

**Length Within Range** - Select this option to decode an MSI symbol with a specific length range. Select the length range using the numeric bar codes in [Appendix D, Numeric Bar Codes](#). For example, to decode MSI symbols containing between 4 and 12 characters, first scan **MSI - Length Within Range**. Then scan **0, 4, 1**, and **2** (single digit numbers must always be preceded by a leading zero). To correct an error or change a selection, scan **Cancel** on [page D-3](#).



**MSI - Length Within Range**

**Any Length** - Scan this option to decode MSI symbols containing any number of characters within the scanner's capability.



**NOTE** Due to the construction of the MSI symbology, it is possible for a scan line covering only a portion of the code to transmit as a complete scan, yielding less data than is encoded in the bar code. To prevent this, Motorola recommends selecting specific lengths (MSI - One Discrete Length, Two Discrete Lengths) for MSI applications.



**MSI - Any Length**

## MSI Check Digits

With MSI symbols, one check digit is mandatory and always verified by the reader. The second check digit is optional. If your MSI codes include two check digits, scan the **Two MSI Check Digits** bar code to enable verification of the second check digit.

See [MSI Check Digit Algorithm on page 12-51](#) to select second digit algorithms.

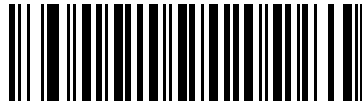

**\*One MSI Check Digit**

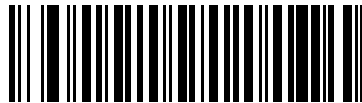

**Two MSI Check Digits**

## Transmit MSI Check Digit(s)

Scan a bar code below to transmit MSI data with or without the check digit.

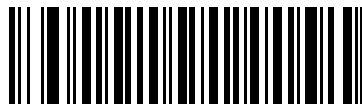

**Transmit MSI Check Digit(s)  
(Enable)**

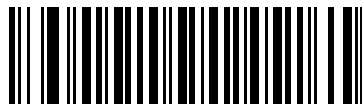

**\*Do Not Transmit MSI Check Digit(s)  
(Disable)**

## MSI Check Digit Algorithm

There are two algorithms for verifying the second MSI check digit. Select the bar code corresponding to the algorithm used to encode your check digit.



**MOD 10/MOD 11**

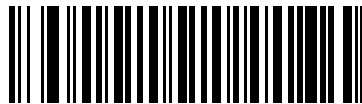

**\*MOD 10/MOD 10**

---

## GS1 DataBar (Formerly RSS, Reduced Space Symbology)

### GS1 DataBar

The variants of GS1 DataBar are DataBar-14, DataBar Expanded, and DataBar Limited. The limited and expanded versions have stacked variants. Scan the appropriate bar codes to enable or disable each variant of GS1 DataBar.



**Enable GS1 DataBar-14**

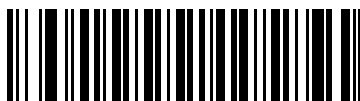

**\*Disable GS1 DataBar-14**



**Enable GS1 DataBar Limited**

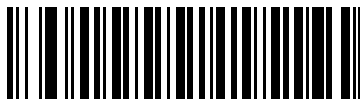

**\*Disable GS1 DataBar Limited**

## GS1 DataBar (continued)

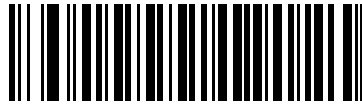

**Enable GS1 DataBar Expanded**



**\*Disable GS1 DataBar Expanded**

## Convert GS1 DataBar to UPC/EAN

This parameter only applies to GS1 DataBar-14 and GS1 DataBar Limited symbols not decoded as part of a Composite symbol. Enable this conversion to strip the leading '010' from GS1 DataBar-14 and GS1 DataBar Limited symbols encoding a single zero as the first digit, and report the bar code as EAN-13.

Enabling this strips the leading '0100' from bar codes beginning with two or more zeros but not six zeros, and reports the bar code as UPC-A. The UPC-A Preamble parameter to transmit the system character and country code applies to converted bar codes. Note that you cannot strip the system character or the check digit.

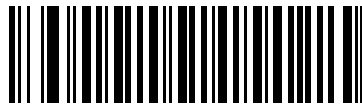

**Enable**

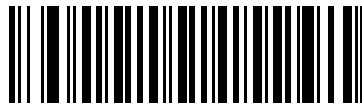

**\*Disable**

## Redundancy Level

The Symbol LS2208 offers four levels of decode redundancy. Select higher redundancy levels for decreasing levels of bar code quality. As redundancy levels increase, the scanner's aggressiveness decreases.

Select the redundancy level appropriate for the bar code quality.

### Redundancy Level 1

The following code types must be successfully read twice before being decoded:

Code Type	Code Length
Codabar	8 characters or less
MSI	4 characters or less
D 2 of 5	8 characters or less
I 2 of 5	8 characters or less

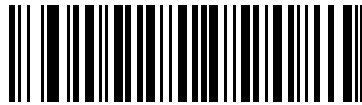

\*Redundancy Level 1

### Redundancy Level 2

The following code types must be successfully read twice before being decoded:

Code Type	Code Length
All	All

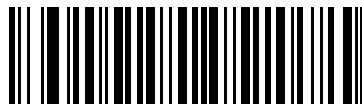

Redundancy Level 2

### Redundancy Level 3

Code types other than the following must be successfully read twice before being decoded. The following codes must be read three times:

Code Type	Code Length
MSI Plessey	4 characters or less
D 2 of 5	8 characters or less
I 2 of 5	8 characters or less
Codabar	8 characters or less



Redundancy Level 3

### Redundancy Level 4

The following code types must be successfully read three times before being decoded:

Code Type	Code Length
All	All



Redundancy Level 4

---

## Security Level

The Symbol LS2208 offers four levels of decode security for delta bar codes. These include the Code 128 family, UPC/EAN, and Code 93. Select higher security levels for decreasing levels of bar code quality. There is an inverse relationship between security and scanner aggressiveness, so be sure to choose only that level of security necessary for your application.

### Security Level 0

This is the default setting which allows the scanner to operate in its most aggressive state, while providing sufficient security in decoding most “in-spec” bar codes.

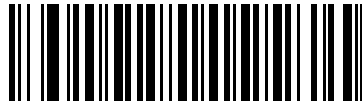

**\*Security Level 0**

### Security Level 1

Select this option if misdecodes occur. This security level eliminates most misdecodes.

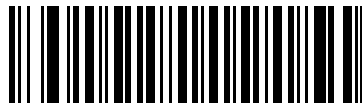

**Security Level 1**

### Security Level 2

Select this option if Security level 1 fails to eliminate misdecodes.



**Security Level 2**



### Security Level 3

If you selected Security Level 2 and misdecodes still occur, select this security level. Be advised, selecting this option is an extreme measure against mis-decoding severely out of spec bar codes. Selecting this level of security significantly impairs the scanner's decoding ability. If you need this level of security, try to improve the quality of the bar codes.

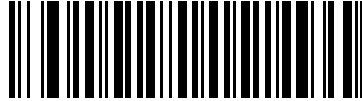

**Security Level 3**

## Bi-directional Redundancy

Enable Bi-directional Redundancy for added security to linear code type security levels. When enabled, a bar code must be successfully scanned in both directions (forward and reverse) before reporting a good decode.



**Enable Bi-directional Redundancy**

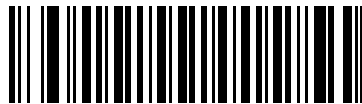

**\*Disable Bi-directional Redundancy**

## Intercharacter Gap Size

The Code 39 and Codabar symbologies have an intercharacter gap that is typically quite small. Due to various bar code printing technologies, this gap can grow larger than the maximum size allowed, preventing decode. If this occurs, select **Large Intercharacter Gaps** to tolerate these out-of-specification bar codes.



**\*Normal Intercharacter Gaps**



**Large Intercharacter Gaps**

---

## Report Version

Scan the bar code below to report the software revision installed in the scanner's primary microprocessor.



**Report Software Version**

---

## Report MIMIC Version

Scan the bar code below to report the MIMIC software revision installed in the scanner's secondary microprocessor. Symbol scanners that do not use MIMIC architecture report nothing.



**Report MIMIC Software Version**

---

## Report Synapse Cable

Scan the bar code below to report the software revision of the attached Synapse cable. If the scanner does not detect an attached Synapse cable, it reports *Synapse not attached*.



**Report Synapse Cable**



# Chapter 13 Miscellaneous Scanner Options

---

## Introduction

This chapter includes features frequently used to customize how data transmits to the host. In addition to these bar codes for data formatting, see each host chapter for the appropriate host connections and features for the scanner. Also see [Chapter 12, Symbologies](#) and [Chapter 14, Advanced Data Formatting](#) for customizing data for transmission to the host device.

Before programming, follow the instructions in [Chapter 1, Getting Started](#).

The scanner ships with the settings in the *Miscellaneous Scanner Options Default Table on page 13-2* (also see [Appendix A, Standard Default Parameters](#) for all host and miscellaneous scanner defaults). If the default values suit requirements, programming is not necessary. Set feature values by scanning single bar codes or short bar code sequences.

---

## Scanning Sequence Examples

In most cases you need only scan one bar code to set a specific parameter value.

Parameters, such as **Prefix Value**, require scanning several bar codes in sequence. See each individual parameter for descriptions of this procedure.

---

## Errors While Scanning

Unless otherwise specified, to correct an error during a scanning sequence, just re-scan the correct parameter.

---

## Miscellaneous Default Parameters

[Table 13-1](#) lists the defaults for miscellaneous scanner options parameters. To change an option, scan the appropriate bar code(s) in the Miscellaneous Scanner Parameters section beginning on [page 13-3](#).

✓ **NOTE** See [Appendix A, Standard Default Parameters](#) for all user preferences, hosts, symbologies, and miscellaneous default parameters.

**Table 13-1** *Miscellaneous Scanner Options Default Table*

Parameter	Default	Page Number
Transmit Code ID Character	None	<a href="#">13-3</a>
Prefix Value	7013 <CR><LF>	<a href="#">13-4</a>
Suffix Value	7013 <CR><LF>	<a href="#">13-4</a>
Scan Data Transmission Format	Data as is	<a href="#">13-4</a>
FN1 Substitution Values	Set	<a href="#">13-6</a>
Transmit "No Read" Message	Disable	<a href="#">13-6</a>
Synapse Interface	Standard	<a href="#">13-7</a>

---

## Miscellaneous Scanner Parameters

### Transmit Code ID Character

A Code ID character identifies the code type of a scanned bar code. This is useful when the scanner is decoding more than one code type. In addition to any single character prefix already selected, the Code ID character is inserted between the prefix and the decoded symbol.

Select no Code ID character, a Symbol Code ID character, or an AIM Code ID character. For Code ID Characters, see *Symbol Code Identifiers on page B-1* and *AIM Code Identifiers on page B-2*.

- ✓ **NOTE** If you enable Symbol Code ID Character or AIM Code ID Character, and enable *Transmit "No Read" Message on page 13-6*, the scanner appends the code ID for Code 39 to the NR message.

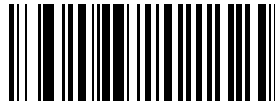

Symbol Code ID Character

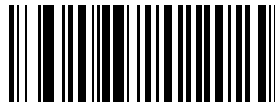

AIM Code ID Character

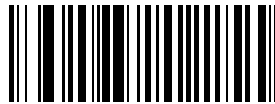

\*None

## Prefix/Suffix Values

You can append a prefix and/or suffix to scan data for use in data editing.

To set a value for a prefix or suffix:

1. Change the scan data format by scanning the appropriate *Scan Data Transmission Format on page 13-4*.
2. Scan the appropriate prefix/suffix bar code below.
3. Scan a four-digit number (i.e., four bar codes from [Appendix D, Numeric Bar Codes](#)) that corresponds to that value.
4. To correct an error or change a selection, scan *Cancel on page D-3*.

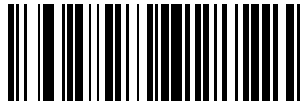

Scan Prefix

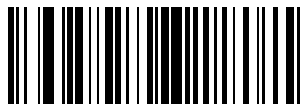

Scan Suffix

## Scan Data Transmission Format

To change the scan data format, scan **Scan Options** and one of the following four bar codes corresponding to the desired format:

- **Data As Is**
- **<DATA> <SUFFIX>**
- **<PREFIX> <DATA>**
- **<PREFIX> <DATA> <SUFFIX>**.

Scan **Enter** on [page 13-5](#) to complete the change. To set values for the prefix and/or suffix, see *Prefix/Suffix Values on page 13-4*. Scan **Data Format Cancel** on [page 13-5](#) to cancel the change.

If you require a carriage return/enter after each scanned bar code, scan the following bar codes in order:

1. **Scan Options**
2. **<DATA> <SUFFIX>**
3. **Enter** (on [page 13-5](#)).



Scan Options



### Scan Data Transmission Format (continued)

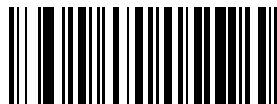

\*Data As Is

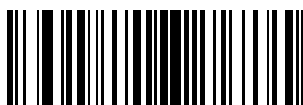

<DATA> <SUFFIX>



<PREFIX> <DATA>



<PREFIX> <DATA> <SUFFIX>



Enter



Data Format Cancel

## FN1 Substitution Values

The Wedge and USB HID Keyboard hosts support a FN1 Substitution feature. When enabled any FN1 character (0x1b) in an EAN128 bar code is substituted with a value. This value defaults to 7013 (Enter Key).

1. To select a FN1 Substitution Value, scan the bar code below.



**Set FN1 Substitution Value**

2. Locate the keystroke desired for FN1 Substitution in the ASCII Character Set table for the current host interface. Enter the 4-digit ASCII Value by scanning each digit in the [Appendix D, Numeric Bar Codes](#).
3. To correct an error or change the selection, scan CANCEL.

To enable FN1 Substitution for Wedge, scan the **Enable Keyboard Wedge** FN1 Substitution bar code on [page 5-13](#).

To enable FN1 Substitution for USB HID Keyboard, scan the **Enable USB Keyboard** FN1 Substitution bar code on [page 7-12](#).

## Transmit “No Read” Message

Scan a bar code below to select whether or not a No Read message transmits. Enable this to transmit the characters NR when a bar code is not decoded. Disable this to transmit nothing if a symbol does not decode.



**NOTE** If you enable **Transmit No Read**, and also enable Symbol Code ID Character or AIM Code ID Character for *Transmit Code ID Character* on [page 13-3](#), the scanner appends the code ID for Code 39 to the NR message.



**Enable No Read**



**\*Disable No Read**

## Synapse Interface

The auto-detection of a Synapse cable varies in duration depending on the type of Synapse connection. If a scanner is connected to another scanner using a Synapse cable, use the Auxiliary Synapse Port connection. In all other cases, when using the cable, Motorola recommends the default setting.

To disconnect and reconnect the scanner from a Synapse cable that is connected to a live host via a Synapse, use the Plug and Play setting. Do not change this setting from the default if an on-board wedge host is enabled.

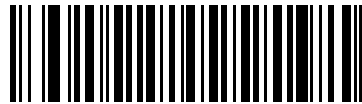

**\*Standard Synapse Connection**



**Auxiliary Synapse Port Connection**



**“Plug and Play” Synapse Connection**



# Chapter 14 Advanced Data Formatting

---

## Introduction

Advanced Data Formatting (ADF) is a means of customizing data before transmission to the host device. Scan data can be edited to suit your particular requirements.

Implement ADF by scanning a related series of bar codes, which begin on [page 14-6](#), or by installing the 123Scan<sup>2</sup> utility (see [Chapter 11, 123Scan2](#)) which allows programming the scanner with ADF rules.

✓ **NOTE** If using the Wand interface with the scanner, you can not use ADF rules to format data unless you enable *Convert All Bar Codes to Code 39* on page 9-7.

---

## Rules: Criteria Linked to Actions

ADF uses **rules** customize data. These rules perform detailed actions when the data meets certain criteria. One rule may consist of single or multiple criteria applied to single or multiple actions.

For instance, a data formatting rule could be:

**Criteria:**        *When scan data is Code 39, length 12, and data at the start position is the string "129",*

**Actions:**        *pad all sends with zeros to length 8,  
send all data up to X,  
send a space.*

Scanning a Code 39 bar code of 1299X1559828 transmits the following: 00001299<space>. If you scan a Code 39 bar code of 1299X15598, this rule is ignored because the bar code doesn't meet the length criteria.

The rule specifies the editing conditions and requirements before data transmission occurs.

---

## Using ADF Bar Codes

When programming a rule, make sure the rule is logically correct. Plan ahead before you start scanning.

To program each data formatting rule:

- **Start the Rule.** Scan [Begin New Rule on page 14-6](#).
- **Specify Criteria.** Scan the bar codes for all pertinent criteria. Criteria can include code type (e.g., Code 128), code length, or data that contains a specific character string (e.g., the digits “129”). See [Criteria on page 14-9](#).
- **Specify Actions.** Scan all actions related to, or affecting, these criteria. The actions of a rule specify how to format the data for transmission. See [Actions on page 14-20](#).
- **Save the Rule.** Scan the [Save Rule on page 14-6](#). This places the rule in the top position in the rule buffer.
- Use the following special-purpose bar codes to correct errors that occur during this process: **Erase Criteria and Start Again, Erase Actions and Start Again, Erase Previously Saved Rule**, etc.

Use the Erase bar codes on [page 14-7](#) to erase criteria, actions, and entire rules.

[Beeper Definitions on page 2-2](#) help guide you through the programming steps.

---

## ADF Bar Code Menu Example

This section provides an example of how to enter and use ADF rules for scan data.

An auto parts distribution center wants to encode manufacturer ID, part number, and destination code into their own Code 128 bar codes. The distribution center also has products that carry UPC bar codes, placed there by the manufacturer. The Code 128 bar codes have the following format:

MMMMMPPPPDD

Where:           M = Manufacturer ID  
                     P = Part Number  
                     D = Destination Code

The distribution center uses a PC with dedicated control characters for manufacturer ID <CTRL M>, part number <CTRL P>, and destination code <CTRL D>. At this center the UPC data is treated as manufacturer ID code.

The following rules must be entered:

When scanning data of code type Code 128, send the next 5 characters, send the manufacturer ID key <CTRL M>, send the next 5 characters, send the part number key <CTRL P>, send the next 2 characters, send the destination code key <CTRL D>.

When scanning data of code type UPC/EAN, send all data, send the manufacturer ID key <CTRL M>.

To enter these rules, see the following steps:

## Rule 1: The Code 128 Scanning Rule

Step	Bar Code	On Page	Beep Indication
1	Begin New Rule	<a href="#">14-6</a>	High High
2	Code 128	<a href="#">14-9</a>	High High
3	Send next 5 characters	<a href="#">14-20</a>	High High
4	Send <CTRL M>	<a href="#">14-39</a>	High High
5	Send next 5 characters	<a href="#">14-20</a>	High High
6	Send <CTRL P>	<a href="#">14-40</a>	High High
7	Send next 2 characters	<a href="#">14-20</a>	High High
8	Send <CTRL D>	<a href="#">14-38</a>	High High
9	Save Rule	<a href="#">14-6</a>	High Low High Low

## Rule 2: The UPC Scanning Rule

Step	Bar Code	On Page	Beep Indication
1	Begin New Rule	<a href="#">14-6</a>	High High
2	UPC/EAN	<a href="#">14-10</a>	High High
3	Send all remaining data	<a href="#">14-20</a>	High High
4	Send <CTRL M>	<a href="#">14-39</a>	High High
5	Save Rule	<a href="#">14-6</a>	High Low High Low

If you made any mistakes while entering this rule, scan [Quit Entering Rules on page 14-7](#). If you already saved the rule, scan [Erase Previously Saved Rule on page 14-7](#).

## Alternate Rule Sets

You can group ADF rules into one of four alternate sets which you can turn on and off when needed. This is useful to format the same message in different ways. For example, a Code 128 bar code contains the following information:

Class (2 digits), Stock Number (8) digits, Price (5 digits)

This bar code might look like this:

245671243701500

where:

Class = 24

Stock Number = 56712437

Price = 01500

Ordinarily you would send this data as follows:

24 (class key)

56712437 (stock key)

01500 (enter key)

But, when there is a sale, you may want to send only the following:

24 (class key)

56712437 (stock key)

and the cashier keys the price manually.

To implement this, first enter an ADF rule that applies to the normal situation, such as:

When scanning a bar code of length 15, send the next 2 characters, send the class key, send the next 8 characters, send the stock key, send the data that remains, send the Enter key.

The “sale” rule may look like:

When scanning a bar code of length 15, send the next 2 characters, send the class key, send the next 8 characters, send the stock key.

To switch between the two sets of rules, program a “switching rule” to specify the type of bar code to scan to switch between the rule sets. For example, in the case of the “sale” rule above, the rule programmer wants the cashier to scan the bar code “M” before a sale. To do this, enter the following rule:

When scanning a bar code of length 1 that begins with “M”, select rule set number 1.

Program another rule to switch back:

When scanning a bar code of length 1 that begins with “N”, turn off rule set number 1.

Or include the switching back to normal rules in the “sale” rule:

When scanning a bar code of length 15, send the next 2 characters, send the class key, send the next 8 characters, send the stock key, turn off rule set 1.

It is recommended that you scan [Disable All Rule Sets on page 14-8](#) after programming a rule belonging to an alternate rule set.

In addition to enabling and disabling rule sets within the rules, enable or disable them by scanning the appropriate bar codes [page 14-8](#).

## Rules Hierarchy (in Bar Codes)

The order of programming individual rules is important. Program the most general rule first.

All programmed rules are stored in a buffer. As they are programmed, they are stored at the top of a rules list. If you create three rules, the list is configured as follows:

Third Rule

Second Rule

First Rule

When scanning data, the rules list is checked from top to bottom to determine if the criteria matches (and therefore, if the actions occur). Input is modified into the data format specified by the first matching set of criteria it finds. Be sure to program the most general rule first.

For example, if the THIRD rule states:

When scanning a bar code of any length, send all data, then send the ENTER key.



And the SECOND rule states:

When scanning a Code 128 bar code of length 12, send the first four characters, then send the ENTER key, then send all remaining data.

If you scan a Code 128 bar code of length 12, the THIRD rule would apply, and the SECOND rule would appear to not function.

Note that using the standard data editing functions also creates ADF rules. Scan options are entered as ADF rules, and the hierarchy mentioned above also applies to them. For the Symbol LS2208, this applies to prefix/suffix programming in the parameter *Scan Data Transmission Format*.

These rules reside in the same “rule list” as ADF rules, so the order of their creation is also important.

## Default Rules

Every unit has a default rule to send all scan data. Units with custom software may have one or more default rules burned in. The rules hierarchy checks user programmable rules first, then the default rules. To disable default rules enter the following general rule in the user programmable buffer:

When receiving scan data, send all data.

Since this rule always applies, ADF will never use the default rules.

---

## Special Commands

### Pause Duration

This parameter along with the Send Pause parameter on [page 14-24](#) inserts a pause in the data transmission. To set the pause scan a two-digit number (i.e., two bar codes), to represent a 0.1 second interval. For example, scan bar codes **0** and **1** from [Appendix D, Numeric Bar Codes](#) to insert a 0.1 second pause; scan **0** and **5** for a 0.5 second delay. To correct an error or to change a selection, scan **Numeric Cancel** on [page D-3](#).



Pause Duration

### Begin New Rule

Scan this bar code to start entering a new rule.



Begin New Rule

### Save Rule

Scan this bar code to save the rule you entered.



Save Rule

## Erase

Use these bar codes to erase criteria, actions, or rules.



**Erase Criteria  
And Start Again**



**Erase Actions  
And Start Again**



**Erase Previously  
Saved Rule**



**Erase All Rules**

## Quit Entering Rules

Scan this bar code to quit entering rules.



**Quit Entering  
Rules**

## Disable Rule Set

Use these bar codes to disable rule sets.



**Disable Rule Set 1**



**Disable Rule Set 2**



**Disable Rule Set 3**



**Disable Rule Set 4**



**Disable All Rule Sets**

---

## Criteria

### Code Types

Select all code types to be affected by the rule. Scan all selected codes in succession, before selecting other criteria. *To select all code types, don't select any code types.*



**Code 39**



**Codabar**



**GS1 DataBar-14**



**GS1 DataBar Limited**



**GS1 DataBar Expanded**



**Code 128**

Scan the bar codes for all code types desired before selecting other criteria.



**D 2 OF 5**



**IATA 2 OF 5**



**I 2 OF 5**



**Code 93**



**UPC-A**



**UPC-E**



**EAN-8**



**EAN-13**

**Code Types (continued)**



**MSI**



**UCC/EAN 128**



**UPC-E1**



**Bookland EAN**



**Trioptic Code 39**



**Chinese 2 of 5**



**Coupon Code**

## Code Lengths

Scan these bar codes to define the number of characters the selected code types must contain. Select one length per rule only. *Don't select any code length to select code types of any length.*



**1 Character**



**2 Characters**



**3 Characters**



**4 Characters**



**5 Characters**



**6 Characters**



### Code Lengths (continued)



7 Characters



8 Characters



9 Characters



10 Characters



11 Characters



12 Characters

**Code Lengths (continued)**



**13 Characters**



**14 Characters**



**15 Characters**



**16 Characters**



**17 Characters**



**18 Characters**

### Code Lengths (continued)



19 Characters



20 Characters



21 Characters



22 Characters



23 Characters



24 Characters

### Code Lengths (continued)



25 Characters



26 Characters



27 Characters



28 Characters



29 Characters



30 Characters

## Message Containing A Specific Data String

Use this feature to select whether the formatting affects data that begins with a specific character or data string, or contains a specific character or data string.

There are 4 features:

- Specific String at Start
- Specific String, Any Location
- Any Message OK
- Rule Belongs to Set

### Specific String at Start

1. Scan the following bar code.
2. Scan the bar codes representing the desired character or characters (up to a total of 8) using the *Alphanumeric Keyboard on page 14-73*
3. Scan [End Of Message on page 14-79](#).



Specific String At Start

### Specific String, Any Location

1. Scan the following bar code.
2. Enter a location by scanning a two-digit number representing the **position** (use a leading "zero" if necessary) using the *Numeric Keypad on page 14-18*.
3. Scan the bar codes representing the desired character or characters (up to a total of 8) using the *Alphanumeric Keyboard on page 14-73*.
4. Scan [End Of Message on page 14-79](#).



Specific String Any Location

### Any Message OK

Do not scan any bar code to format all selected code types, regardless of information contained.

### Numeric Keypad

Do not confuse bar codes on this page with those on the alphanumeric keyboard.



0



1



2



3



4



5



6



7



8



9



Cancel

**Rule Belongs To Set**

Select the set to which a rule belongs. There are four possible rule sets. See *Alternate Rule Sets* on page 14-3 for more information.

**Rule Belongs To Set 1****Rule Belongs To Set 2****Rule Belongs To Set 3****Rule Belongs To Set 4**

---

## Actions

Select how to format the data for transmission.

### Send Data

Send all data that follows, send all data up to a specific character selected from the *Alphanumeric Keyboard on page 14-73*, or send the next *X* characters. Note that only bar codes for **Send Next 1 to 20** appear here, and can be scanned multiple times to send values greater than 20. For instance, to send the next 28 characters, scan **Send Next 20 Characters**, then **Send Next 8 Characters**.

Use these bar codes to send data.



**Send Data Up To  
Character**



**Send All Data That  
Remains**



**Send Next Character**



**Send Next  
2 Characters**



**Send Next  
3 Characters**



**Send Next  
4 Characters**



**Send Next  
5 Characters**



**Send Next  
6 Characters**



**Send Next  
7 Characters**



---

## Send Data (continued)



**Send Next  
8 Characters**



**Send Next  
9 Characters**



**Send Next  
10 Characters**



**Send Next  
11 Characters**



**Send Next  
12 Characters**



**Send Next  
13 Characters**



**Send Next  
14 Characters**



**Send Next  
15 Characters**



**Send Next  
16 Characters**



**Send Next  
17 Characters**

---

## Send Data (continued)



**Send Next  
18 Characters**



**Send Next  
19 Characters**



**Send Next  
20 Characters**

## Setup Field(s)

**Table 14-1** *Setup Field(s) Definitions*

Parameter	Description	Page
<b>Move Cursor</b>		
Move Cursor To a Character	Scan <i>Move Cursor To Character</i> , then any printable ASCII character from the <i>Alphanumeric Keyboard</i> . This moves the cursor to the position after the matching character. If the character is not there, the rule fails and ADF tries the next rule.	14-24
Move Cursor to Start of Data	Scan this bar code to move cursor to the beginning of the data.	14-24
Move Cursor Past a Character	This action moves the cursor past all sequential occurrences of a selected character. For example, if the selected character is 'A', then the cursor moves past 'A', 'AA', 'AAA', etc. Scan <i>Move Cursor Past Character</i> , then select a character from the <i>Alphanumeric Keyboard</i> . If the character is not there, the cursor does not move (i.e., has no effect).	14-24
Skip Ahead "N" Characters	Scan one of these bar codes to select the number of positions ahead to move the cursor.	14-25
Skip Back "N" Characters	Scan one of these bar codes to select the number of positions back to move the cursor.	14-26
Send Preset Value	Send Values 1 through 6 by scanning the appropriate bar code. Set these values using the prefix/suffix values in <i>Table 6-4 on page 6-22</i> . Value 1 = Scan Suffix Value 2 = Scan Prefix Values 3-6 are not applicable	14-27

### Move Cursor

Scan a bar code below to move the cursor in relation to a specified character. Then enter a character by scanning a bar code from the [Alphanumeric Keyboard on page 14-73](#).

✓ **NOTE** If there is no match when the rule is interpreted and the rule fails, the next rule is checked.



**Move Cursor To  
Character**



**Move Cursor To Start**



**Move Cursor Past  
Character**

### Send Pause

Scan the bar code below to insert a pause in the transmission of data. The Pause Duration parameter controls the length of this pause.



**Send Pause**

## Skip Ahead

Use the following bar codes to skip ahead characters.



**Skip Ahead  
1 Character**



**Skip Ahead  
2 Characters**



**Skip Ahead  
3 Characters**



**Skip Ahead  
4 Characters**



**Skip Ahead  
5 Characters**



**Skip Ahead  
6 Characters**



**Skip Ahead  
7 Characters**



**Skip Ahead  
8 Characters**



**Skip Ahead  
9 Characters**



**Skip Ahead  
10 Characters**

## Skip Back

Use the following bar codes to skip back characters.



**Skip Back  
1 Character**



**Skip Back  
2 Characters**



**Skip Back  
3 Characters**



**Skip Back  
4 Characters**



**Skip Back  
5 Characters**



**Skip Back  
6 Characters**



**Skip Back  
7 Characters**



**Skip Back  
8 Characters**



**Skip Back  
9 Characters**



**Skip Back  
10 Characters**

### Send Preset Value

Use these bar codes to send preset values. Set these values using the prefix/suffix values in [Table 6-4 on page 6-22](#).



**Send Value 1**



**Send Value 2**



**Send Value 3**



**Send Value 4**



**Send Value 5**



**Send Value 6**

## Modify Data

Modify data as described below. The following actions work for all send commands that follow it within a rule. Programming *pad zeros to length 6, send next 3 characters, stop padding, send next 5 characters*, adds three zeros to the first send, and does not pad the next send. These options do not apply to the **Send Keystroke** or **Send Preset Value** options.

### Remove All Spaces

To remove all spaces in the send commands that follow, scan this bar code.

### Crunch All Spaces

To leave one space between words, scan this bar code. This also removes all leading and trailing spaces.

### Stop Space Removal

Scan this bar code to disable space removal.

### Remove Leading Zeros

Scan this bar code to remove all leading zeros.

### Stop Zero Removal

Scan this bar code to disable the removal of zeros.

Use the bar codes below to modify data.



**Remove All Spaces**



**Crunch All Spaces**



**Stop Space Removal**



**Remove Leading  
Zeros**



**Stop Zero Removal**



## Pad Data with Spaces

To pad data to the left, scan the bar code containing the desired number of spaces. Send commands activate this parameter.



**Pad Spaces To  
Length 1**



**Pad Spaces To  
Length 2**



**Pad Spaces To  
Length 3**



**Pad Spaces To  
Length 4**



**Pad Spaces To  
Length 5**



**Pad Spaces To  
Length 6**



**Pad Spaces To  
Length 7**



**Pad Spaces To  
Length 8**

**Pad Data with Spaces (continued)**



**Pad Spaces To  
Length 9**



**Pad Spaces To  
Length 10**



**Pad Spaces To  
Length 11**



**Pad Spaces To  
Length 12**



**Pad Spaces To  
Length 13**



**Pad Spaces To  
Length 14**



**Pad Spaces To  
Length 15**



**Pad Spaces To  
Length 16**

### Pad Data with Spaces (continued)



Pad Spaces To  
Length 17



Pad Spaces To  
Length 18



Pad Spaces To  
Length 19



Pad Spaces To  
Length 20



Pad Spaces To  
Length 21



Pad Spaces To  
Length 22



Pad Spaces To  
Length 23



Pad Spaces To  
Length 24

**Pad Data with Spaces (continued)**



**Pad Spaces To  
Length 25**



**Pad Spaces To  
Length 26**



**Pad Spaces To  
Length 27**



**Pad Spaces To  
Length 28**



**Pad Spaces To  
Length 29**



**Pad Spaces To  
Length 30**



**Stop Pad Spaces**

## Pad Data with Zeros

To pad data to the left, scan the bar code containing the desired number of zeros. This parameter is activated by Send commands.



**Pad Zeros To  
Length 1**



**Pad Zeros To  
Length 2**



**Pad Zeros To  
Length 3**



**Pad Zeros To  
Length 4**



**Pad Zeros To  
Length 5**



**Pad Zeros To  
Length 6**



**Pad Zeros To  
Length 7**



**Pad Zeros To  
Length 8**

**Pad Data with Zeros (continued)**



**Pad Zeros To  
Length 9**



**Pad Zeros To  
Length 10**



**Pad Zeros To  
Length 11**



**Pad Zeros To  
Length 12**



**Pad Zeros To  
Length 13**



**Pad Zeros To  
Length 14**



**Pad Zeros To  
Length 15**



**Pad Zeros To  
Length 16**

### Pad Data with Zeros (continued)



Pad Zeros To  
Length 17



Pad Zeros To  
Length 18



Pad Zeros To  
Length 19



Pad Zeros To  
Length 20



Pad Zeros To  
Length 21



Pad Zeros To  
Length 22



Pad Zeros To  
Length 23



Pad Zeros To  
Length 24

### Pad Data with Zeros (continued)



Pad Zeros To  
Length 25



Pad Zeros To  
Length 26



Pad Zeros To  
Length 27



Pad Zeros To  
Length 28



Pad Zeros To  
Length 29



Pad Zeros To  
Length 30



Stop Pad Zeros



## Beeps

Select a beep sequence for each ADF rule.



**Beep Once**



**Beep Twice**



**Beep Three Times**

## Send Keystroke (Control Characters and Keyboard Characters)

### Control Characters

Scan the "Send \_\_\_" bar code for the keystroke to send.



Send Control 2



Send Control A



Send Control B



Send Control C



Send Control D



Send Control E



Send Control F



Send Control G

**Control Characters (continued)**



**Send Control H**



**Send Control I**



**Send Control J**



**Send Control K**



**Send Control L**



**Send Control M**



**Send Control N**



**Send Control O**

**Control Characters (continued)**



**Send Control P**



**Send Control Q**



**Send Control R**



**Send Control S**



**Send Control T**



**Send Control U**



**Send Control V**



**Send Control W**

**Control Characters (continued)**



**Send Control X**



**Send Control Y**



**Send Control Z**



**Send Control [**



**Send Control \**



**Send Control ]**



**Send Control 6**



**Send Control -**

### Keyboard Characters

Scan the "Send \_\_\_" bar code for the keyboard characters to send.



**Send Space**



**Send !**



**Send "**



**Send #**



**Send \$**



**Send %**



**Send &**



**Send '**

**Keyboard Characters (continued)**



**Send (**



**Send )**



**Send \***



**Send +**



**Send ,**



**Send -**



**Send .**



**Send /**

**Keyboard Characters (continued)**



**Send 0**



**Send 1**



**Send 2**



**Send 3**



**Send 4**



**Send 5**



**Send 6**



**Send 7**



**Keyboard Characters (continued)**



**Send 8**



**Send 9**



**Send :**



**Send ;**



**Send <**



**Send =**



**Send >**



**Send ?**

**Keyboard Characters (continued)**



**Send @**



**Send A**



**Send B**



**Send C**



**Send D**



**Send E**



**Send F**



**Send G**

**Keyboard Characters (continued)**



**Send H**



**Send I**



**Send J**



**Send K**



**Send L**



**Send M**



**Send N**



**Send O**

**Keyboard Characters (continued)**



**Send P**



**Send Q**



**Send R**



**Send S**



**Send T**



**Send U**



**Send V**



**Send W**

**Keyboard Characters (continued)**



**Send X**



**Send Y**



**Send Z**



**Send [**



**Send \**



**Send ]**



**Send ^**



**Send \_**

**Keyboard Characters (continued)**



**Send `**



**Send a**



**Send b**



**Send c**



**Send d**



**Send e**



**Send f**



**Send g**

**Keyboard Characters (continued)**



**Send h**



**Send i**



**Send j**



**Send k**



**Send l**



**Send m**



**Send n**



**Send o**

**Keyboard Characters (continued)**



**Send p**



**Send q**



**Send r**



**Send s**



**Send t**



**Send u**



**Send v**



**Send w**



**Keyboard Characters (continued)**



**Send x**



**Send y**



**Send z**



**Send {**



**Send |**



**Send }**



**Send ~**

### Send ALT Characters



Send Alt @



Send Alt 2



Send Alt A



Send Alt B



Send Alt C



Send Alt D



Send Alt E



Send Alt F



Send Alt G



Send Alt H

**Send ALT Characters (continued)**



**Send Alt I**



**Send Alt J**



**Send Alt K**



**Send Alt L**



**Send Alt M**



**Send Alt N**



**Send Alt O**

**Send ALT Characters (continued)**



**Send Alt P**



**Send Alt Q**



**Send Alt R**



**Send Alt S**



**Send Alt T**



**Send Alt U**



**Send Alt V**



**Send Alt W**

**Send ALT Characters (continued)**



**Send Alt X**



**Send Alt Y**



**Send Alt Z**



**Send Alt [**



**Send Alt \**

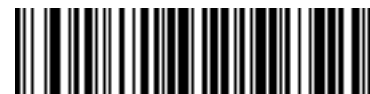

**Send Alt ]**

## Send Keypad Characters



Send Keypad \*



Send Keypad +



Send Keypad -



Send Keypad .



Send Keypad /



Send Keypad 0



Send Keypad 1



Send Keypad 2



Send Keypad 3



Send Keypad 4

**Send Keypad Characters (continued)**



**Send Keypad 5**



**Send Keypad 6**



**Send Keypad 7**



**Send Keypad 8**



**Send Keypad 9**



**Send Keypad Enter**



**Send Keypad Numlock**

**NUM LOCK**

**Send Keypad Characters (continued)**



**Send Break Key**



**Send Delete Key**



**Send Page Up Key**



**Send End Key**



**Send Page Down Key**



**Send Pause Key**



**Send Scroll Lock Key**



**Send Backspace Key**



**Send Tab Key**



**Send Print Screen Key**



**Send Keypad Characters (continued)**



**Send Insert Key**



**Send Home Key**



**Send Enter Key**



**Send Escape Key**



**Send Up Arrow Key**



**Send Down Arrow Key**



**Send Left Arrow Key**



**Send Right Arrow Key**

### Send Function Key



Send F1 Key



Send F2 Key



Send F3 Key



Send F4 Key



Send F5 Key



Send F6 Key



Send F7 Key



Send F8 Key



Send F9 Key



Send F10 Key

**Send Function Key (continued)**



**Send F11 Key**



**Send F12 Key**



**Send F13 Key**



**Send F14 Key**



**Send F15 Key**



**Send F16 Key**



**Send F17 Key**



**Send F18 Key**



**Send F19 Key**



**Send F20 Key**



**Send F21 Key**



**Send F22 Key**



**Send F23 Key**



**Send F24 Key**

**Send Function Key (continued)**



**Send PF1 Key**



**Send PF2 Key**



**Send PF3 Key**



**Send PF4 Key**



**Send PF5 Key**



**Send PF6 Key**



**Send PF7 Key**



**Send PF8 Key**



**Send PF9 Key**



**Send PF10 Key**

**Send Function Key (continued)**



**Send PF11 Key**



**Send PF12 Key**



**Send PF13 Key**



**Send PF14 Key**



**Send PF15 Key**



**Send PF16 Key**



**Send PF17 Key**



**Send PF18 Key**



**Send PF19 Key**



**Send PF20 Key**

### Send Function Key (continued)



Send PF21 Key



Send PF22 Key



Send PF23 Key



Send PF24 Key



Send PF25 Key



Send PF26 Key



Send PF27 Key



Send PF28 Key



Send PF29 Key



Send PF30 Key

### Send Right Control Key

The “Send Right Control Key” action will send a tap (press and release) of the Right Control Key.

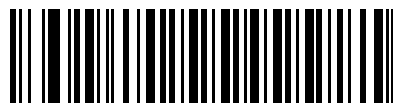

Send Right Control Key

## Send Graphic User Interface (GUI) Characters

The **Send Graphic User Interface Character** actions taps the specified key while holding the System Dependent Graphic User Interface (GUI) Key. The definition of the Graphic User Interface key depends on the attached system:

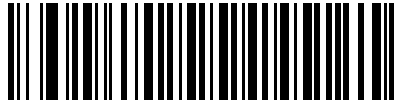

Send GUI 0

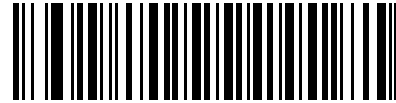

Send GUI 1



Send GUI 2



Send GUI 3



Send GUI 4

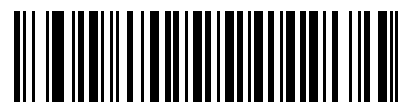

Send GUI 5



Send GUI 6



Send GUI 7

### Send Graphic User Interface (GUI) Characters (continued)



Send GUI 8

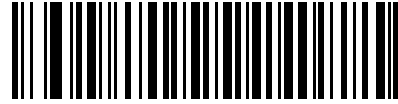

Send GUI 9

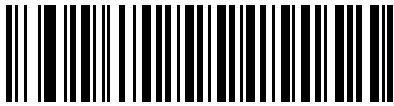

Send GUI A

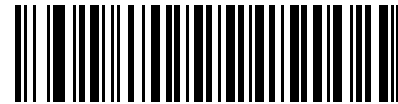

Send GUI B

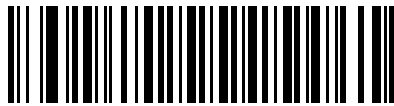

Send GUI C

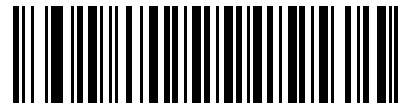

Send GUI D

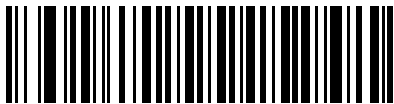

Send GUI E

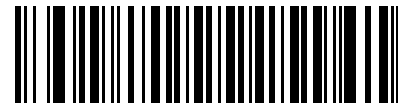

Send GUI F



### Send Graphic User Interface (GUI) Characters (continued)



Send GUI G

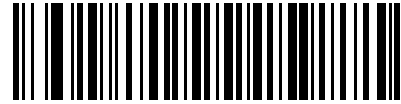

Send GUI H

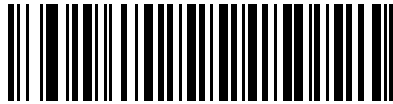

Send GUI I

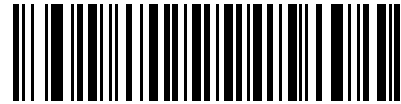

Send GUI J

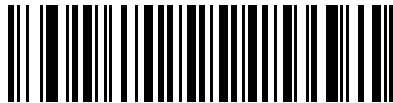

Send GUI K

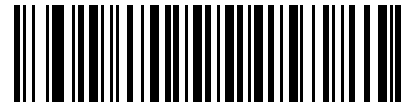

Send GUI L



Send GUI M

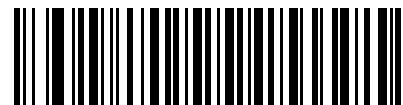

Send GUI N

### Send Graphic User Interface (GUI) Characters (continued)



Send GUI O

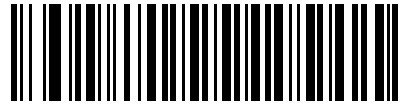

Send GUI P

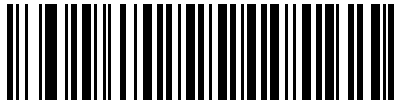

Send GUI Q

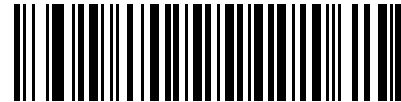

Send GUI R

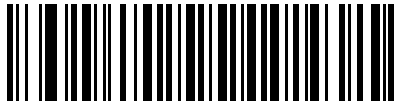

Send GUI S

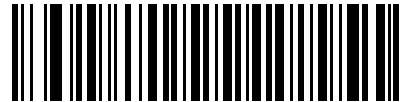

Send GUI T



Send GUI U

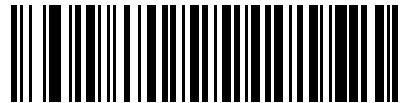

Send GUI V

### Send Graphic User Interface (GUI) Characters (continued)



Send GUI W

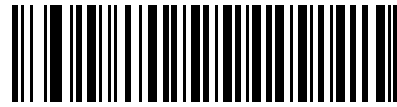

Send GUI X



Send GUI Y

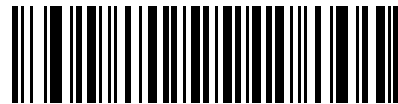

Send GUI Z

## Turn On/Off Rule Sets

Use these bar codes to turn rule sets on and off.



**Turn On Rule Set 1**



**Turn On Rule Set 2**



**Turn On Rule Set 3**



**Turn On Rule Set 4**



**Turn Off Rule Set 1**



**Turn Off Rule Set 2**



**Turn Off Rule Set 3**

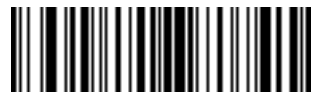

**Turn Off Rule Set 4**

---

## Alphanumeric Keyboard



Space



#



\$



%



\*



+



-  
(Dash)



.



/



!



,

---

## Alphanumeric Keyboard (continued)



“



&



’



(



)



:



;



<



=



>

---

## Alphanumeric Keyboard (continued)



?



@



[



\



]



^



            
(Underscore)



,

---

## Alphanumeric Keyboard (continued)

Do not confuse bar codes on this page with those on the numeric keypad.



0



1



2



3



4



5



6



7



8



9



---

## Alphanumeric Keyboard (continued)



A



B



C



D



E



F



G



H



I



J

---

## Alphanumeric Keyboard (continued)



K



L



M



N



O



P



Q



R



S



T

---

## Alphanumeric Keyboard (continued)



U



V



W



X



Y



Z



Cancel



End Of Message

---

## Alphanumeric Keyboard (continued)



a



b



c



d



e



f



g



h



i



j

---

## Alphanumeric Keyboard (continued)



k



l



m



n



o



p



q



r



s



t

---

## Alphanumeric Keyboard (continued)



u



v



w



x



y



z



{



|



}



~

# Appendix A Standard Default Parameters

**Table A-1** Standard Default Parameters Table

Parameter	Default	Page Number
<b>User Preferences</b>		
Set Default Parameter	All Defaults	4-3
Beeper Tone	Medium	4-4
Beeper Volume	High	4-5
Power Mode	Continuous On	4-6
Laser On Time	3.0 Sec	4-7
Beep After Good Decode	Enable	4-8
Timeout Between Decodes		
Time-out Between Same Symbol	0.6 sec	4-9
Time-out Between Different Symbols	0.2 sec	4-9
<b>Keyboard Wedge Host Parameters</b>		
Keyboard Wedge Host Type	IBM PC/AT& IBM PC Compatibles <sup>1</sup>	5-4
Country Types (Country Codes)	North American	5-5
Ignore Unknown Characters	Transmit	5-7
Keystroke Delay	No Delay	5-8
Intra-Keystroke Delay	Disable	5-9
Alternate Numeric Keypad Emulation	Disable	5-9
Caps Lock On	Disable	5-10

<sup>1</sup>User selection is required to configure this interface and this is the most common selection.

**Table A-1** Standard Default Parameters Table (Continued)

Parameter	Default	Page Number
Caps Lock Override	Disable	5-10
Convert Wedge Data	No Convert	5-11
Function Key Mapping	Disable	5-12
FN1 Substitution	Disable	5-13
Send and Make Break	Send	5-13
<b>RS-232 Host Parameters</b>		
RS-232 Host Types	Standard <sup>1</sup>	6-6
Baud Rate	9600	6-8
Parity Type	None	6-10
Stop Bit Select	1 Stop Bit	6-12
Data Bits	8-Bit	6-12
Check Receive Errors	Enable	6-13
Hardware Handshaking	None	6-14
Software Handshaking	None	6-16
Host Serial Response Time-out	2 Sec	6-18
RTS Line State	Low RTS	6-19
Beep on <BEL>	Disable	6-19
Intercharacter Delay	0 msec	6-20
Nixdorf Beep/LED Options	Normal Operation	6-21
Ignore Unknown Characters	Send Bar Code	6-21
<b>USB Host Parameters</b>		
USB Device Type	HID Keyboard Emulation	7-4
USB Country Keyboard Types (Country Codes)	North American	7-6
USB Keystroke Delay	No Delay	7-9
USB CAPS Lock Override	Disable	7-10
USB Ignore Unknown Characters	Enable	7-11
Emulate Keypad	Disable	7-12
USB Keyboard FN1 Substitution	Disable	7-12

<sup>1</sup>User selection is required to configure this interface and this is the most common selection.



**Table A-1** Standard Default Parameters Table (Continued)

Parameter	Default	Page Number
Function Key Mapping	Disable	7-13
Simulated Caps Lock	Disable	7-13
Convert Case	No Case Conversion	7-14
<b>IBM 468X/469X Host Parameters</b>		
Port Address	None Selected	8-4
Convert Unknown to Code 39	Disable	8-5
<b>Wand Emulation Host Parameters</b>		
Wand Emulation Host Types	Symbol OmniLink Interface Controller <sup>1</sup>	9-4
Leading Margin	80 msec	9-5
Polarity	Bar High/Margin Low	9-6
Ignore Unknown Characters	Ignore	9-6
Convert All Bar Codes to Code 39	Disable	9-7
Convert Code 39 to Full ASCII	Disable	9-7
<b>Undecoded Scanner Emulation</b>		
Beep Style	Beep on Successful Transmit	10-5
Parameter Pass-Through	Parameter Process and Pass Through	10-6
Convert Newer Code Types	Convert Newer Code Types	10-7
Module Width	20 $\mu$ s	10-7
Convert All Bar Codes to Code 39	Do Not Convert to Code 39	10-8
Code 39 Full ASCII Conversion	Disable	10-8
Transmission Timeout	3 seconds	10-9
Ignore Unknown Characters	Ignore Unknown Characters	10-10
Leading Margin	2 ms	10-11
Check for Decode LED	Check for Decode LED	10-12
<b>123Scan2 Configuration Tool</b>		
123Scan <sup>2</sup> Configuration	None <sup>1</sup>	11-1

<sup>1</sup>User selection is required to configure this interface and this is the most common selection.

**Table A-1** Standard Default Parameters Table (Continued)

Parameter	Default	Page Number
<b>UPC/EAN</b>		
UPC-A	Enable	12-5
UPC-E	Enable	12-5
UPC-E1	Disable	12-6
EAN-8/JAN 8	Enable	12-7
EAN-13/JAN 13	Enable	12-7
Bookland EAN	Disable	12-8
Decode UPC/EAN/JAN Supplementals (2 and 5 digits)	Ignore	12-9
User-Programmable Supplementals Supplemental 1: Supplemental 2:		12-12
UPC/EAN/JAN Supplemental Redundancy	7	12-12
Transmit UPC-A Check Digit	Enable	12-13
Transmit UPC-E Check Digit	Enable	12-13
Transmit UPC-E1 Check Digit	Enable	12-13
UPC-A Preamble	System Character	12-14
UPC-E Preamble	System Character	12-15
UPC-E1 Preamble	System Character	12-16
Convert UPC-E to A	Disable	12-17
Convert UPC-E1 to A	Disable	12-18
EAN-8/JAN-8 Extend	Disable	12-18
Bookland ISBN Format	ISBN-10	12-19
UPC/EAN Security Levels	0	12-20
UCC Coupon Extended Code	Disable	12-21
<b>Code 128</b>		
Code 128	Enable	12-22
UCC/EAN-128	Enable	12-22
ISBT 128	Enable	12-23

<sup>1</sup>User selection is required to configure this interface and this is the most common selection.

**Table A-1** Standard Default Parameters Table (Continued)

Parameter	Default	Page Number
<b>Code 39</b>		
Code 39	Enable	12-24
Trioptic Code 39	Disable	12-24
Convert Code 39 to Code 32 (Italian Pharmacy Code)	Disable	12-25
Code 32 Prefix	Disable	12-25
Set Length(s) for Code 39	2 to 55	12-26
Code 39 Check Digit Verification	Disable	12-27
Transmit Code 39 Check Digit	Disable	12-27
Code 39 Full ASCII Conversion	Disable	12-28
Buffer Code 39	Disable	12-29
<b>Code 93</b>		
Code 93	Disable	12-32
Set Length(s) for Code 93	4 to 55	12-26
<b>Code 11</b>		
Code 11	Disable	12-34
Set Lengths for Code 11	4 to 55	12-35
Code 11 Check Digit Verification	Disable	12-36
Transmit Code 11 Check Digit(s)	Disable	12-37
<b>Interleaved 2 of 5 (ITF)</b>		
Interleaved 2 of 5 (ITF)	Enable	12-38
Set Lengths for I 2 of 5	14	12-39
I 2 of 5 Check Digit Verification	Disable	12-40
Transmit I 2 of 5 Check Digit	Disable	12-41
Convert I 2 of 5 to EAN 13	Disable	12-41
<b>Discrete 2 of 5 (DTF)</b>		
Discrete 2 of 5	Disable	12-42
Set Length(s) for D 2 of 5	12	12-43

<sup>1</sup>User selection is required to configure this interface and this is the most common selection.

**Table A-1** Standard Default Parameters Table (Continued)

Parameter	Default	Page Number
<b>Chinese 2 of 5</b>		
Enable/Disable Chinese 2 of 5	Disable	12-44
<b>Codabar (NW - 7)</b>		
Codabar	Disable	12-45
Set Lengths for Codabar	5 to 55	12-46
CLSI Editing	Disable	12-47
NOTIS Editing	Disable	12-47
<b>MSI</b>		
MSI	Disable	12-48
Set Length(s) for MSI	4 to 55	12-49
MSI Check Digits	One	12-50
Transmit MSI Check Digit	Disable	12-50
MSI Check Digit Algorithm	Mod 10/Mod 10	12-51
<b>GS1 DataBar (formerly RSS, Reduced Space Symbology)</b>		
GS1 DataBar-14	Disable	12-52
GS1 DataBar Limited	Disable	12-52
GS1 DataBar Expanded	Disable	12-53
Convert GS1 DataBar to UPC/EAN	Disable	12-53
<b>Symbology - Specific Security Levels</b>		
Redundancy Level	1	12-54
Security Level	0	12-56
Bi-directional Redundancy	Disable	12-58
Intercharacter Gap Size	Normal	12-58
Report Version		12-59
Report MIMIC Version		12-59
Report Synapse Cable		12-59

<sup>1</sup>User selection is required to configure this interface and this is the most common selection.

**Table A-1** Standard Default Parameters Table (Continued)

Parameter	Default	Page Number
<b>Miscellaneous Scanner Options</b>		
Transmit Code ID Character	None	13-3
Prefix Value	7013 <CR><LF>	13-4
Suffix Value	7013 <CR><LF>	13-4
Scan Data Transmission Format	Data as is	13-4
FN1 Substitution Values	Set	13-6
Transmit "No Read" Message	Disable	13-6
Synapse Interface	Standard	13-7

**<sup>1</sup>User selection is required to configure this interface and this is the most common selection.**



# Appendix B Programming Reference

## Symbol Code Identifiers

**Table B-1** *Symbol Code Characters*

Code Character	Code Type
A	UPC-A, UPC-E, UPC-E1, EAN-8, EAN-13
B	Code 39, Code 32
C	Codabar
D	Code 128
E	Code 93
F	Interleaved 2 of 5
G	Discrete 2 of 5, or Discrete 2 of 5 IATA
H	Code 11
J	MSI
K	UCC/EAN-128
L	Bookland EAN
M	Trioptic Code 39
N	Coupon Code
R	GS1 DataBar
T	UCC Composite, TLC 39

## AIM Code Identifiers

Each AIM Code Identifier contains the three-character string **Jcm** where:

- J = Flag Character (ASCII 93)
- c = Code Character (see [Table B-2](#))
- m = Modifier Character (see [Table B-3](#))

**Table B-2** *Aim Code Characters*

Code Character	Code Type
A	Code 39, Code 39 Full ASCII, Code 32
C	Code 128, Coupon (Code 128 portion)
E	UPC/EAN, Coupon (UPC portion)
e	GS1 DataBar
F	Codabar
G	Code 93
H	Code 11
I	Interleaved 2 of 5
M	MSI
S	D2 of 5, IATA 2 of 5
X	Bookland EAN, Code 39 Trioptic



The modifier character is the sum of the applicable option values based on [Table B-3](#).

**Table B-3** *Modifier Characters*

Code Type	Option Value	Option
Code 39	0	No check character or Full ASCII processing.
	1	Reader has checked one check character.
	3	Reader has checked and stripped check character.
	4	Reader has performed Full ASCII character conversion.
	5	Reader has performed Full ASCII character conversion and checked one check character.
	7	Reader has performed Full ASCII character conversion and checked and stripped check character.
		Example: A Full ASCII bar code with check character W, <b>A+I+MI+DW</b> , is transmitted as <b>J<math>\overline{A7}</math>AIMID</b> where $7 = (3+4)$ .
Trioptic Code 39	0	No option specified at this time. Always transmit 0.
	Example: A Trioptic bar code 412356 is transmitted as <b>J<math>\overline{X0}</math>412356</b>	
Code 128	0	Standard data packet, no Function code 1 in first symbol position.
	1	Function code 1 in first symbol character position.
	2	Function code 1 in second symbol character position.
		Example: A Code (EAN) 128 bar code with Function 1 character <sup>FNC1</sup> in the first position, AIMID is transmitted as <b>J<math>\overline{C1}</math>AIMID</b>
I 2 of 5	0	No check digit processing.
	1	Reader has validated check digit.
	3	Reader has validated and stripped check digit.
		Example: An I 2 of 5 bar code without check digit, 4123, is transmitted as <b>J<math>\overline{I0}</math>4123</b>
Codabar	0	No check digit processing.
	1	Reader has checked check digit.
	3	Reader has stripped check digit before transmission.
		Example: A Codabar bar code without check digit, 4123, is transmitted as <b>J<math>\overline{F0}</math>4123</b>
Code 93	0	No options specified at this time. Always transmit 0.
	Example: A Code 93 bar code 012345678905 is transmitted as <b>J<math>\overline{G00}</math>12345678905</b>	

**Table B-3** *Modifier Characters (Continued)*

Code Type	Option Value	Option
MSI	0	Check digits are sent.
	1	No check digit is sent.
	Example: An MSI bar code 4123, with a single check digit checked, is transmitted as <b>JM14123</b>	
D 2 of 5	0	No options specified at this time. Always transmit 0.
	Example: A D 2 of 5 bar code 4123, is transmitted as <b>JS04123</b>	
UPC/EAN	0	Standard packet in full EAN country code format, which is 13 digits for UPC-A and UPC-E (not including supplemental data).
	1	Two-digit supplement data only.
	2	Five-digit supplement data only.
	4	EAN-8 data packet.
	Example: A UPC-A bar code 012345678905 is transmitted as <b>JE00012345678905</b>	
Bookland EAN	0	No options specified at this time. Always transmit 0.
	Example: A Bookland EAN bar code 123456789X is transmitted as <b>JX0123456789X</b>	
Code 11	0	Single check digit
	1	Two check digits
	3	Check characters validated but not transmitted.
GS1 DataBar Family		No option specified at this time. Always transmit 0. GS1 DataBar-14 and GS1 DataBar Limited transmit with an Application Identifier "01". Note: In UCC/EAN-128 emulation mode, GS1 DataBar is transmitted using Code 128 rules (i.e., ]C1).
	Example: A GS1 DataBar-14 bar code 100123456788902 is transmitted as <b>Je001100123456788902</b> .	

# Appendix C Sample Bar Codes

---

## Code 39



---

## UPC/EAN

### UPC-A, 100 %

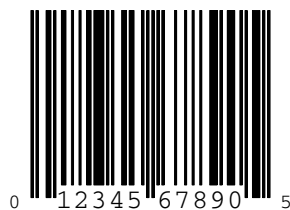

### EAN-13, 100 %



---

### Code 128



---

### Interleaved 2 of 5



---

### GS1 DataBar-14



**NOTE** You must enable GS1 DataBar-14 to read the bar code below (see *Enable GS1 DataBar-14 on page 12-52*).



# Appendix D Numeric Bar Codes

---

## Numeric Bar Codes

### 0, 1, 2

For parameters requiring specific numeric values, scan the appropriately numbered bar code(s).

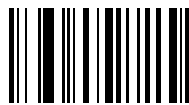

0



1

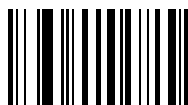

2

**3, 4, 5, 6**



3



4



5



6

**7, 8, 9**

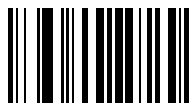

**7**



**8**



**9**

---

**Cancel**

To correct an error or change a selection, scan the bar code below.



**Cancel**





# Glossary

---

## A

**Aperture.** The opening in an optical system defined by a lens or baffle that establishes the field of view.

**ASCII.** American Standard Code for Information Interchange. A 7 bit-plus-parity code representing 128 letters, numerals, punctuation marks and control characters. It is a standard data transmission code in the U.S.

**Autodiscrimination.** The ability of an interface controller to determine the code type of a scanned bar code. After this determination is made, the information content is decoded.

---

## B

**Bar.** The dark element in a printed bar code symbol.

**Bar Code.** A pattern of variable-width bars and spaces which represents numeric or alphanumeric data in machine-readable form. The general format of a bar code symbol consists of a leading margin, start character, data or message character, check character (if any), stop character, and trailing margin. Within this framework, each recognizable symbology uses its own unique format. See **Symbology**.

**Bar Code Density.** The number of characters represented per unit of measurement (e.g., characters per inch).

**Bar Height.** The dimension of a bar measured perpendicular to the bar width.

**Bar Width.** Thickness of a bar measured from the edge closest to the symbol start character to the trailing edge of the same bar.

**Bit.** Binary digit. One bit is the basic unit of binary information. Generally, eight consecutive bits compose one byte of data. The pattern of 0 and 1 values within the byte determines its meaning.

**Bits per Second (bps).** Bits transmitted or received.

**Bluetooth.** A technology that provides a way to connect and exchange information between devices such as scanners, mobile phones, laptops, PCs, and printers over a secure, globally unlicensed short-range radio frequency.

**Boot or Boot-up.** The process a computer goes through when it starts. During boot-up, the computer can run self-diagnostic tests and configure hardware and software.

**bps.** See **Bits Per Second**.

**Byte.** On an addressable boundary, eight adjacent binary digits (0 and 1) combined in a pattern to represent a specific character or numeric value. Bits are numbered from the right, 0 through 7, with bit 0 the low-order bit. One byte in memory is used to store one ASCII character.

---

## C

**CDRH.** Center for Devices and Radiological Health. A federal agency responsible for regulating laser product safety. This agency specifies various laser operation classes based on power output during operation.

**CDRH Class 1.** This is the lowest power CDRH laser classification. This class is considered intrinsically safe, even if all laser output were directed into the eye's pupil. There are no special operating procedures for this class.

**CDRH Class 2.** No additional software mechanisms are needed to conform to this limit. Laser operation in this class poses no danger for unintentional direct human exposure.

**Character.** A pattern of bars and spaces which either directly represents data or indicates a control function, such as a number, letter, punctuation mark, or communications control contained in a message.

**Character Set.** Those characters available for encoding in a particular bar code symbology.

**Check Digit.** A digit used to verify a correct symbol decode. The scanner inserts the decoded data into an arithmetic formula and checks that the resulting number matches the encoded check digit. Check digits are required for UPC but are optional for other symbologies. Using check digits decreases the chance of substitution errors when a symbol is decoded.

**Codabar.** A discrete self-checking code with a character set consisting of digits 0 to 9 and six additional characters: ( - \$ : / , +).

**Code 128.** A high density symbology which allows the controller to encode all 128 ASCII characters without adding extra symbol elements.

**Code 3 of 9 (Code 39).** A versatile and widely used alphanumeric bar code symbology with a set of 43 character types, including all uppercase letters, numerals from 0 to 9 and 7 special characters ( - . / + % \$ and space). The code name is derived from the fact that 3 of 9 elements representing a character are wide, while the remaining 6 are narrow.

**Code 93.** An industrial symbology compatible with Code 39 but offering a full character ASCII set and a higher coding density than Code 39.

**Code Length.** Number of data characters in a bar code between the start and stop characters, not including those characters.

**Cold Boot.** A cold boot restarts a computer and closes all running programs.

**COM Port.** Communication port; ports are identified by number, e.g., COM1, COM2.

**Continuous Code.** A bar code or symbol in which all spaces within the symbol are parts of characters. There are no intercharacter gaps in a continuous code. The absence of gaps allows for greater information density.

**Cradle.** A cradle is used for charging the terminal battery and for communicating with a host computer, and provides a storage place for the terminal when not in use.

---

## D

**Dead Zone.** An area within a scanner's field of view, in which specular reflection may prevent a successful decode.

**Decode.** To recognize a bar code symbology (e.g., UPC/EAN) and then analyze the content of the specific bar code scanned.

**Decode Algorithm.** A decoding scheme that converts pulse widths into data representation of the letters or numbers encoded within a bar code symbol.

**Decryption.** Decryption is the decoding and unscrambling of received encrypted data. Also see, **Encryption** and **Key**.

**Depth of Field.** The range between minimum and maximum distances at which a scanner can read a symbol with a certain minimum element width.

**Discrete Code.** A bar code or symbol in which the spaces between characters (intercharacter gaps) are not part of the code.

**Discrete 2 of 5.** A binary bar code symbology representing each character by a group of five bars, two of which are wide. The location of wide bars in the group determines which character is encoded; spaces are insignificant. Only numeric characters (0 to 9) and START/STOP characters may be encoded.

---

## E

**EAN.** European Article Number. This European/International version of the UPC provides its own coding format and symbology standards. Element dimensions are specified metrically. EAN is used primarily in retail.

**Element.** Generic term for a bar or space.

**Encoded Area.** Total linear dimension occupied by all characters of a code pattern, including start/stop characters and data.

**ENQ (RS-232).** ENQ software handshaking is also supported for the data sent to the host.

**ESD.** Electro-Static Discharge

---

## H

**HID.** Human Interface Device. A Bluetooth host type.

**Host Computer.** A computer that serves other terminals in a network, providing such services as computation, database access, supervisory programs and network control.

**Hz.** Hertz; A unit of frequency equal to one cycle per second.

---

## I

**IEC.** International Electrotechnical Commission. This international agency regulates laser safety by specifying various laser operation classes based on power output during operation.

**IEC (825) Class 1.** This is the lowest power IEC laser classification. Conformity is ensured through a software restriction of 120 seconds of laser operation within any 1000 second window and an automatic laser shutdown if the scanner's oscillating mirror fails.

**Intercharacter Gap.** The space between two adjacent bar code characters in a discrete code.

**Interleaved 2 of 5.** A binary bar code symbology representing character pairs in groups of five bars and five interleaved spaces. Interleaving provides for greater information density. The location of wide elements (bar/spaces) within each group determines which characters are encoded. This continuous code type uses no intercharacter spaces. Only numeric (0 to 9) and START/STOP characters may be encoded.

**Interleaved Bar Code.** A bar code in which characters are paired together, using bars to represent the first character and the intervening spaces to represent the second.

**Input/Output Ports.** I/O ports are primarily dedicated to passing information into or out of the terminal's memory. Series 9000 mobile computers include Serial and USB ports.

**I/O Ports.** interface The connection between two devices, defined by common physical characteristics, signal characteristics, and signal meanings. Types of interfaces include RS-232 and PCMCIA.

---

## K

**Key.** A key is the specific code used by the algorithm to encrypt or decrypt the data. Also see, **Encryption** and **Decrypting**.

---

## L

**LASER.** Light Amplification by Stimulated Emission of Radiation. The laser is an intense light source. Light from a laser is all the same frequency, unlike the output of an incandescent bulb. Laser light is typically coherent and has a high energy density.

**Laser Diode.** A gallium-arsenide semiconductor type of laser connected to a power source to generate a laser beam. This laser type is a compact source of coherent light.

**Laser Scanner.** A type of bar code reader that uses a beam of laser light.

**LED Indicator.** A semiconductor diode (LED - Light Emitting Diode) used as an indicator, often in digital displays. The semiconductor uses applied voltage to produce light of a certain frequency determined by the semiconductor's particular chemical composition.

**Light Emitting Diode.** See **LED**.

---

## M

**MIL.** 1 mil = 1 thousandth of an inch.

**MIN.** Mobile Identification Number. The unique account number associated with a cellular device. It is broadcast by the cellular device when accessing the cellular system.

**Misread (Misdecode).** A condition which occurs when the data output of a reader or interface controller does not agree with the data encoded within a bar code symbol.

**MRD.** Minimum reflective difference. A measurement of print contrast.

---

## N

**Nominal.** The exact (or ideal) intended value for a specified parameter. Tolerances are specified as positive and negative deviations from this value.

**Nominal Size.** Standard size for a bar code symbol. Most UPC/EAN codes are used over a range of magnifications (e.g., from 0.80 to 2.00 of nominal).

---

## O

**ODI.** See **Open Data-Link Interface**.

**Open Data-Link Interface (ODI).** Novell's driver specification for an interface between network hardware and higher-level protocols. It supports multiple protocols on a single NIC (Network Interface Controller). It is capable of understanding and translating any network information or request sent by any other ODI-compatible protocol into something a NetWare client can understand and process.

**Open System Authentication.** Open System authentication is a null authentication algorithm.

---

## P

**PAN .** Personal area network. Using Bluetooth wireless technology, PANs enable devices to communicate wirelessly. Generally, a wireless PAN consists of a dynamic group of less than 255 devices that communicate within about a 33-foot range. Only devices within this limited area typically participate in the network.

**Parameter.** A variable that can have different values assigned to it.

**Percent Decode.** The average probability that a single scan of a bar code would result in a successful decode. In a well-designed bar code scanning system, that probability should approach near 100%.

**Print Contrast Signal (PCS).** Measurement of the contrast (brightness difference) between the bars and spaces of a symbol. A minimum PCS value is needed for a bar code symbol to be scannable.  $PCS = (RL - RD) / RL$ , where RL is the reflectance factor of the background and RD the reflectance factor of the dark bars.

**Programming Mode.** The state in which a scanner is configured for parameter values. See **Scanning Mode**.

---

## Q

**Quiet Zone.** A clear space, containing no dark marks, which precedes the start character of a bar code symbol and follows the stop character.

**QWERTY.** A standard keyboard commonly used on North American and some European PC keyboards. "QWERTY" refers to the arrangement of keys on the left side of the third row of keys.

---

## R

**Reflectance.** Amount of light returned from an illuminated surface.

**Resolution.** The narrowest element dimension which is distinguished by a particular reading device or printed with a particular device or method.

**RF.** Radio Frequency.

**RS-232.** An Electronic Industries Association (EIA) standard that defines the connector, connector pins, and signals used to transfer data serially from one device to another.

---

## S

**Scan Area.** Area intended to contain a symbol.

**Scanner.** An electronic device used to scan bar code symbols and produce a digitized pattern that corresponds to the bars and spaces of the symbol. Its three main components are: 1) Light source (laser or photoelectric cell) - illuminates a bar code;; 2) Photodetector - registers the difference in reflected light (more light reflected from spaces); 3) Signal conditioning circuit - transforms optical detector output into a digitized bar pattern.

**Scanning Mode.** The scanner is energized, programmed and ready to read a bar code.

**Scanning Sequence.** A method of programming or configuring parameters for a bar code reading system by scanning bar code menus.

**Self-Checking Code.** A symbology that uses a checking algorithm to detect encoding errors within the characters of a bar code symbol.

**Space.** The lighter element of a bar code formed by the background between bars.

**Specular Reflection.** The mirror-like direct reflection of light from a surface, which can cause difficulty decoding a bar code.

**SPP.** Serial Port Profile.

**Start/Stop Character.** A pattern of bars and spaces that provides the scanner with start and stop reading instructions and scanning direction. The start and stop characters are normally to the left and right margins of a horizontal code.

**Substrate.** A foundation material on which a substance or image is placed.

**Symbol.** A scannable unit that encodes data within the conventions of a certain symbology, usually including start/stop characters, quiet zones, data characters and check characters.

**Symbol Aspect Ratio.** The ratio of symbol height to symbol width.

**Symbol Height.** The distance between the outside edges of the quiet zones of the first row and the last row.

**Symbol Length.** Length of symbol measured from the beginning of the quiet zone (margin) adjacent to the start character to the end of the quiet zone (margin) adjacent to a stop character.

**Symbology.** The structural rules and conventions for representing data within a particular bar code type (e.g. UPC/EAN, Code 39, PDF417, etc.).

---

## T

**Tolerance.** Allowable deviation from the nominal bar or space width.

---

## U

**UPC.** Universal Product Code. A relatively complex numeric symbology. Each character consists of two bars and two spaces, each of which is any of four widths. The standard symbology for retail food packages in the United States.

---

## V

**Visible Laser Diode (VLD).** A solid state device which produces visible laser light.





# Index

## Numerics

123Scan2 ..... 11-1

## A

actions ..... 14-2  
ADF ..... 14-1  
    actions ..... 14-1, 14-20  
        move cursor ..... 14-24  
        send data ..... 14-20  
        setup fields ..... 14-23  
alphanumeric keyboard ..... 14-73  
alternate rule sets ..... 14-3  
bar code menu example ..... 14-2  
beep ..... 14-37  
code lengths ..... 14-12  
code types ..... 14-9  
criteria ..... 14-1, 14-9  
default rules ..... 14-5  
move cursor past a character ..... 14-23  
move cursor to a character ..... 14-23  
move cursor to start of data ..... 14-23  
numeric keypad ..... 14-18  
pad spaces ..... 14-29  
pad zeros ..... 14-33  
rules ..... 14-1  
rules hierarchy ..... 14-4  
send alt characters ..... 14-54  
send control characters ..... 14-38  
send function key ..... 14-62  
send keyboard characters ..... 14-42  
send keypad characters ..... 14-58  
send preset value ..... 14-23  
send value ..... 14-27  
skip ahead "n" characters ..... 14-23  
skip ahead characters ..... 14-25

skip back "n" characters ..... 14-23  
skip back characters ..... 14-26  
space removal ..... 14-28  
special commands ..... 14-6  
specific data string ..... 14-17  
specific string  
    any location ..... 14-17  
    any message ok ..... 14-17  
    at start ..... 14-17  
    rule belongs to set ..... 14-19  
turn off rule sets ..... 14-72  
zero removal ..... 14-28  
advanced data formatting ..... 14-1  
actions ..... 14-1, 14-20  
alphanumeric keyboard ..... 14-73  
alternate rule sets ..... 14-3  
bar code menu example ..... 14-2  
beep ..... 14-37  
code lengths ..... 14-12  
code types ..... 14-9  
criteria ..... 14-1, 14-9  
default rules ..... 14-5  
numeric keypad ..... 14-18  
pad spaces ..... 14-29  
pad zeros ..... 14-33  
rules ..... 14-1  
rules hierarchy ..... 14-4  
send alt characters ..... 14-54  
send control characters ..... 14-38  
send function key ..... 14-62  
send keyboard characters ..... 14-42  
send keypad characters ..... 14-58  
send preset value ..... 14-27  
setup fields ..... 14-23  
skip ahead characters ..... 14-25  
skip back characters ..... 14-26  
space removal ..... 14-28

special commands ..... 14-6  
 specific data string ..... 14-17  
 turn off rule sets ..... 14-72  
 zero removal ..... 14-28  
 aiming ..... 2-5  
 ASCII values ..... 5-16, 6-22, 7-15  
 assembling the stand ..... 2-7

**B**

bar codes

beep after good decode ..... 4-8  
 beeper tone ..... 4-4  
 beeper volume ..... 4-5  
 code 39  
     transmit buffer ..... 12-30  
 data options ..... 13-3  
     pause duration ..... 14-6  
     prefix/suffix values ..... 13-4  
     transmit code ID character ..... 13-3

IBM 468X/469X

convert unknown to code 39 ..... 8-5  
 default parameters ..... 8-3  
 port address ..... 8-4

interleaved 2 of 5

convert to EAN-13 ..... 12-41  
 lengths ..... 12-39

keyboard wedge

alternate numeric keypad emulation ..... 5-9  
 caps lock on ..... 5-10  
 caps lock override ..... 5-10  
 country keyboard types  
     (country codes) ..... 5-5, 5-6  
 default table ..... 5-3  
 host types ..... 5-4  
 ignore unknown characters ..... 5-7  
 intra-keystroke delay ..... 5-9  
 keystroke delay ..... 5-8

laser on time

..... 4-7

miscellaneous

scan data options ..... 13-4  
 transmit no read msg ..... 13-6

numeric bar codes

..... D-3

RS-232

baud rate ..... 6-8  
 beep on bel ..... 6-19  
 check receive errors ..... 6-13  
 data bits ..... 6-12  
 default table ..... 6-3  
 hardware handshaking ..... 6-14  
 host serial response time-out ..... 6-18  
 host types ..... 6-6, 6-7  
 intercharacter delay ..... 6-20  
 parity ..... 6-10

RTS line state ..... 6-19  
 software handshaking ..... 6-16  
 stop bit select ..... 6-19  
 set defaults ..... 4-3  
 symbologies  
     bi-directional redundancy ..... 12-58  
     bookland EAN ..... 12-8  
     bookland ISBN ..... 12-19  
     buffering ..... 12-29  
     codabar ..... 12-45  
     codabar CLSI editing ..... 12-47  
     codabar lengths ..... 12-46  
     codabar NOTIS editing ..... 12-47  
     code 11 ..... 12-34  
     code 11 lengths ..... 12-35  
     code 128 ..... 12-22  
     code 39 ..... 12-24  
     code 39 check digit verification ..... 12-27  
     code 39 full ASCII ..... 12-28  
     code 39 lengths ..... 12-26  
     code 39 transmit check digit ..... 12-27  
     code 93 ..... 12-32  
     code 93 lengths ..... 12-33  
     convert UPC-E to UPC-A ..... 12-17  
     convert UPC-E1 to UPC-A ..... 12-18  
     default table ..... 12-2  
     discrete 2 of 5 ..... 12-42  
     discrete 2 of 5 lengths ..... 12-43  
     EAN zero extend ..... 12-18  
     EAN-13/EAN-8 ..... 12-7  
     I 2 of 5 check digit verification ..... 12-40  
     I 2 of 5 convert to EAN-13 ..... 12-41  
     I 2 of 5 transmit check digit ..... 12-41  
     intercharacter gap size ..... 12-58  
     ISBT 128 ..... 12-23  
     MSI ..... 12-48  
     MSI check digit algorithm ..... 12-51  
     MSI check digits ..... 12-50  
     MSI lengths ..... 12-49  
     MSI transmit check digit ..... 12-50  
     redundancy level ..... 12-54  
     report MIMIC version ..... 12-59  
     report synapse cable ..... 12-59  
     report version ..... 12-59  
     security level ..... 12-56  
     supplementals ..... 12-9  
     UCC coupon extended code ..... 12-21  
     UCC/EAN-128 ..... 12-22  
     UPC-A preamble ..... 12-14  
     UPC-A/E/E1 check digit ..... 12-13  
     UPC-A/UPC-E ..... 12-5  
     UPC-E preamble ..... 12-15  
     UPC-E1 ..... 12-6  
 timeout between decodes ..... 4-9

- UPC/EAN
    - coupon code . . . . . 12-21
    - security level . . . . . 12-20
    - supp redundancy . . . . . 12-12
  - UPC/EAN/JAN
    - supplemental redundancy . . . . . 12-12
  - USB
    - caps lock override . . . . . 7-10
    - country keyboard types . . . . . 7-6
    - default table . . . . . 7-3
    - device type . . . . . 7-4, 7-5
    - keystroke delay . . . . . 7-9
    - unknown characters . . . . . 7-11
  - wand emulation
    - code 39 full ASCII . . . . . 9-7
    - convert all bar codes to code 39 . . . . . 9-7
    - default table . . . . . 9-3, 10-3
    - host types . . . . . 9-4
    - leading margin (quiet zone) . . . . . 9-5
    - polarity . . . . . 9-6
    - unknown characters . . . . . 9-6
  - bullets . . . . . xiv
- C**
- cables
    - installing . . . . . 1-3
    - interface . . . . . 1-4
    - removing cables . . . . . 1-5
  - character set . . . . . 5-16, 6-22, 7-15
  - codabar bar codes
    - CLSI editing . . . . . 12-47
    - codabar . . . . . 12-45
    - lengths . . . . . 12-46
    - NOTIS editing . . . . . 12-47
  - code 11 bar codes
    - code 11 . . . . . 12-34
    - lengths . . . . . 12-35
  - code 128 bar codes
    - code 128 . . . . . 12-22
    - ISBT 128 . . . . . 12-23
    - UCC/EAN-128 . . . . . 12-22
  - code 39 bar codes
    - buffering . . . . . 12-29
    - check digit verification . . . . . 12-27
    - code 39 . . . . . 12-24
    - full ASCII . . . . . 12-28
    - lengths . . . . . 12-26
    - transmit check digit . . . . . 12-27
  - code 93 bar codes
    - code 93 . . . . . 12-32
    - lengths . . . . . 12-33
  - code identifiers
    - AIM code IDs . . . . . B-2
    - Symbol code IDs . . . . . B-1
  - connecting power . . . . . 1-4
  - conventions
    - notational . . . . . xiv
- D**
- decode zone . . . . . 2-6
  - default parameters . . . . . 4-2
    - IBM 468X/469X . . . . . 8-3
    - keyboard wedge . . . . . 5-3
    - miscellaneous scanner options . . . . . 13-2
    - RS-232 . . . . . 6-3
    - standard default table . . . . . A-1
    - symbolgies . . . . . 12-2
    - USB . . . . . 7-3
    - user preferences . . . . . 4-2
    - wand emulation . . . . . 9-3, 10-3
  - discrete 2 of 5 bar codes
    - discrete 2 of 5 . . . . . 12-42
    - lengths . . . . . 12-43
- G**
- GS1 databar
    - convert GS1 databar to UPC/EAN . . . . . 12-53
    - GS1 databar expanded . . . . . 12-53
    - GS1 databar limited . . . . . 12-52
    - GS1 databar-14 . . . . . 12-52
- H**
- host types
    - IBM . . . . . 8-4
    - keyboard wedge . . . . . 5-4
    - RS-232 . . . . . 6-6, 6-7
    - USB . . . . . 7-4
    - wand emulation . . . . . 9-4
- I**
- IBM 468X/469X connection . . . . . 8-2
  - IBM 468X/469X default parameters . . . . . 8-3
  - IBM 468X/469X parameters . . . . . 8-4
  - information, service . . . . . xv
  - interleaved 2 of 5 bar codes
    - check digit verification . . . . . 12-40
    - convert to EAN-13 . . . . . 12-41
    - transmit check digit . . . . . 12-41

## K

keyboard wedge connection	5-2
keyboard wedge default parameters	5-3
keyboard wedge parameters	5-4

## M

maintenance	3-1
miscellaneous scanner parameters	13-2
mounting the stand	2-8
MSI bar codes	
check digit algorithm	12-51
check digits	12-50
lengths	12-49
MSI	12-48
transmit check digit	12-50

## N

notational conventions	.xiv
------------------------	------

## P

parameters	
IBM 468X/469X	8-4
keyboard wedge	5-4
RS-232	6-4
USB	7-4
wand emulation	9-4
parts	2-1
pinouts	
scanner signal descriptions	3-6
power supply	
connecting	1-4

## Q

quiet zone (leading margin)	9-5
-----------------------------	-----

## R

RS-232 connection	6-2
RS-232 default parameters	6-3
RS-232 parameters	6-4, 6-6, 6-7

## S

scanner defaults	4-2
scanner parts	2-1
scanning	
aiming	2-5
errors	4-2, 12-1, 13-2
hand-held	2-4

hands-free	2-7, 2-9
sequence example	4-1, 12-1, 13-2
security level bar codes	
bi-directional redundancy	12-58
redundancy level	12-54
security level	12-56
service information	xv
setup	
connecting a USB interface	7-1
connecting an RS-232 interface	6-2
connecting interface cable	1-4
connecting keyboard wedge interface	5-2
connecting power	1-4
connecting power supply	1-4
connecting to an IBM 468X/469X host	8-2
connecting using wand emulation	9-2, 10-2
installing the cable	1-3
unpacking	1-2
signal descriptions	3-6
specifications	3-4
stand	
assembling	2-7
mounting	2-8
standard defaults	4-2, A-1
symbology default parameters	12-2

## T

technical specifications	3-4
--------------------------	-----

## U

unpacking	1-2
UPC/EAN bar codes	
bookland EAN	12-8
bookland ISBN	12-19
check digit	12-13
convert UPC-E to UPC-A	12-17
convert UPC-E1 to UPC-A	12-18
EAN zero extend	12-18
EAN-13/EAN-8	12-7
UCC coupon extended code	12-21
UPC-A preamble	12-14
UPC-A/UPC-E	12-5
UPC-E preamble	12-15
UPC-E1	12-6
UPC/EAN/JAN bar codes	
supplementals	12-9
USB connection	7-1
USB default parameters	7-3
USB parameters	7-4
user preferences parameters	4-2

**W**

- wand emulation connection . . . . .9-2, 10-2
- wand emulation default parameters . . . . .9-3, 10-3
- wand emulation parameters . . . . . 9-4

# Tell Us What You Think...

We'd like to know what you think about this Manual. Please take a moment to fill out this questionnaire and fax this form to: (631) 627-7184, or mail to:

Motorola, Inc.  
One Motorola Plaza M/S B-10  
Holtsville, NY 11742-1300  
Attention: Technical Publications Manager  
Advanced Data Capture Division



important If you need product support, please call the appropriate customer support number for your area. Unfortunately, we cannot provide customer support at the fax number above.

Manual Title: \_\_\_\_\_  
(please include revision level)

How familiar were you with this product before using this manual?

Very familiar     Slightly familiar     Not at all familiar

Did this manual meet your needs? If not, please explain.

---

---

---

---

What topics need to be added to the index, if applicable?

---

---

---

---

What topics do you feel need to be better discussed? Please be specific.

---

---

---

---

What can we do to further improve our manuals?

---

---

---

---

Thank you for your input—We value your comments.









**MOTOROLA**

Motorola, Inc.  
One Motorola Plaza  
Holtsville, New York 11742, USA  
1-800-927-9626  
<http://www.motorola.com>

MOTOROLA and the Stylized M Logo and Symbol and the Symbol logo are registered in the U.S. Patent and Trademark Office.  
All other product or service names are the property of their respective owners.

© Motorola, Inc. 2010



72E-58808-07 Revision A - July 2010