

Overview

Premium Sounding Compact Ceiling Speakers at a Non-Premium Price.

VC series ceiling speakers for commercial installations deliver excellent sound quality at a price point traditionally reserved for economy speakers. A total of six models, three with back cans and three without, feature elegant low-profile designs that can be install easily even in limited ceiling or wall spaces. Large mounting clamps with non-slip treads ensure secure mounting.



Features

- Engineered for optimum BGM and voice reproduction
- No back can low-profile design allows installation in limited ceiling spaces
- Direct support for low-impedance or high-impedance connections
- 16 Ω in low-impedance is advantageous when connecting multiple speakers in low impedance system
- Double-threaded speaker clamp screws for speedy tightening
- Paintable grilles with magnetic catches
- Black and white versions available
- 2.8 kg (6.2 lbs), $\text{\O}325$ mm x D131 mm ($\text{\O}12\text{-}3/4$ " x D5-1/8")
- Single unit package

Specifications

General Specifications

System Type		2way Coaxial type (without backcan)
Components	LF	8" Cone
	HF	1" Soft dome
Frequency Range (-10 dB)		52 Hz - 20 kHz *1
Coverage Angle (Horizontal x Vertical)		110°conical *1
Nominal Impedance		16 Ω
Transformer Taps	70V	12 W, 6 W, 3 W, 1.5 W
	100V	12 W, 6 W, 3 W
Power Rating	NOISE	25 W
	PGM	50 W
	MAX	100 W
Sensitivity (1 W, 1 m)		91 dB SPL *1
Maximum SPL (Calculated, 1 m)		111 dB SPL *2
Connectors		1 x Push terminal (WAGO 294 /2 pin)
Material, Finish, Color		VC8NB: Black (approx. Munsell N3)
		VC8NW: White (approx. Munsell N9.3)
Dimensions (W x H x D)		Ø325 mm x D131 mm (Ø12-3/4" x D5-1/8")
Net Weight		2.8 kg (6.2 lbs)
Cutout Size		Ø285 mm (Ø11-1/4")
Required Ceiling Board Thickness		2 mm - 37 mm
Packaging		Single
Certificate		CE, RoHS

*1 Half space (2π)

*2 Calculated based on power rating and sensitivity

Accessories

Included Accessories	C-Ring, Tile Rails x 2, Grille, Safety wire, Cutout template
----------------------	--

Dimensions

Unit: mm

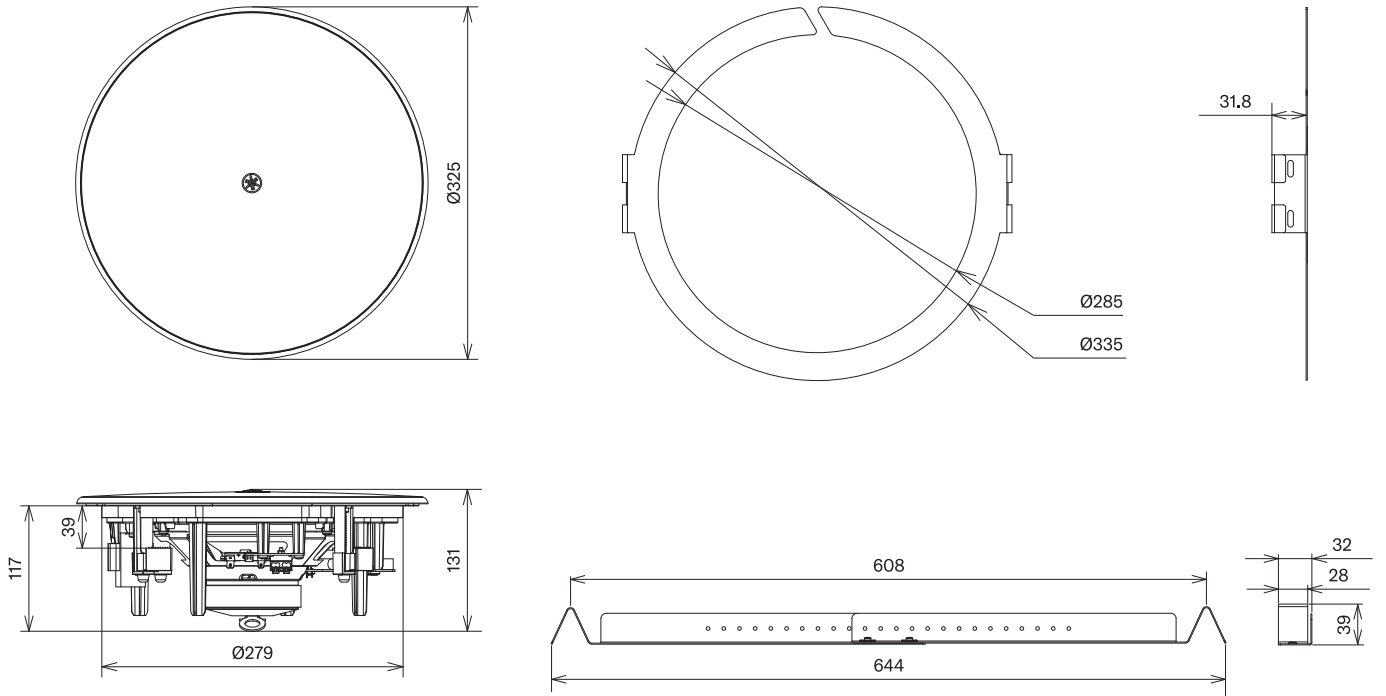

Architectural and Engineering Specifications

The Yamaha VC8NB (black) and VC8NW (white) shall be low-profile flush-mount ceiling speakers designed for commercial installations. The VC8NB and VC8NW shall have an 8" cone low frequency driver and 1" soft dome high frequency driver.

The VC8NB and VC8NW shall meet the following performance criteria: Sensitivity shall be 91 dB SPL at 1 watt/1 meter, maximum SPL shall be 111 dB at 1 meter, frequency response shall be 52 Hz to 20 kHz at 10 dB below rated sensitivity, and nominal coverage angle shall be 110° conical. Maximum power ratings shall be 25 watts noise, 50 watts program, and 100 watts peak. A tap selector shall be provided to allow operation at 16 ohms in low-impedance systems, or 70V/100V line voltage in distributed systems. 3, 6, and 12 watt power taps shall be provided for 100 volt distributed lines. 1.5, 3, 6, and 12 watt power taps shall be provided for 70 volt distributed lines. Overload protection shall be provided by full-range power limiting. Push terminals shall be provided for input connection.

The VC8NB and VC8NW shall have a powder-coated punched metal grille and ABS trim ring. These models shall not have back cans, but shall be provided with a dust-proof bag made of artificial fiber to protect the back of the speaker. The VC8NB grille and trim ring shall be black, and the VC8NW grille and trim ring shall be white. The VC8NB and VC8NW shall be supplied with a safety wire, cutout template, owner's manual, and a reinforcing bracket kit including tile rails, a C-ring, and screws. The required ceiling cutout size shall be 285 (ø) mm. Speaker dimensions including grille shall be 325 (ø) x 131 (D) mm. Weight shall be 2.8 kg.

Sensitivity

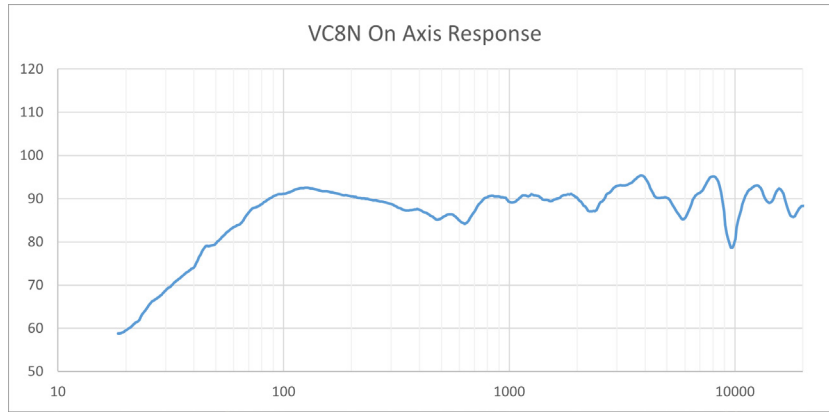

Beam Width

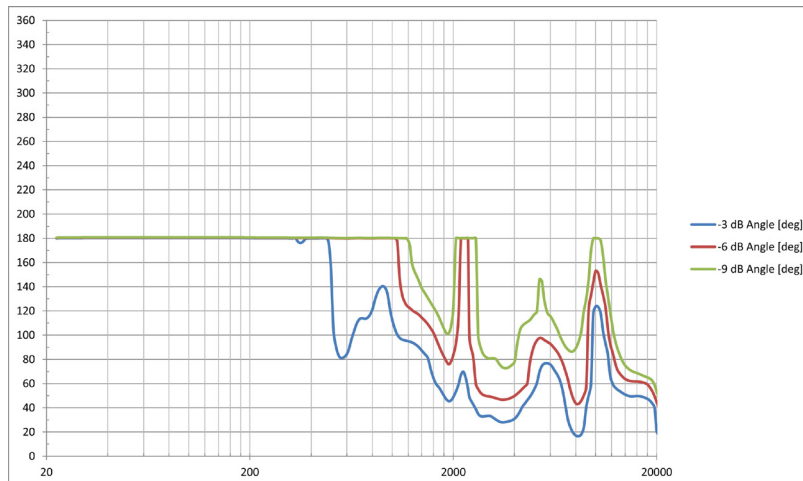

Directivity Index

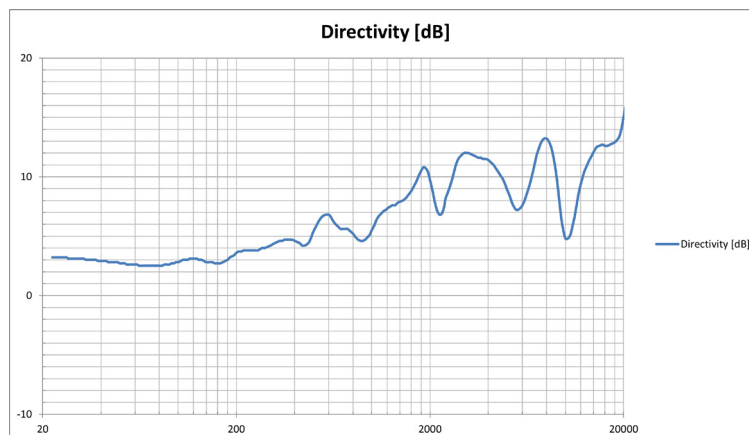

Polar Plots

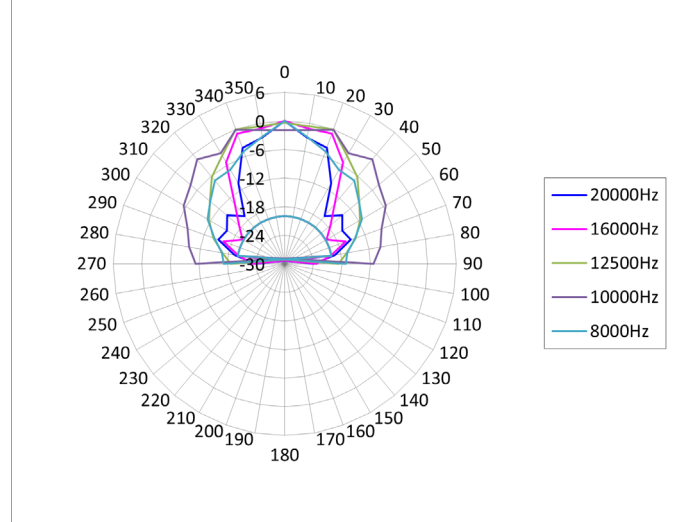
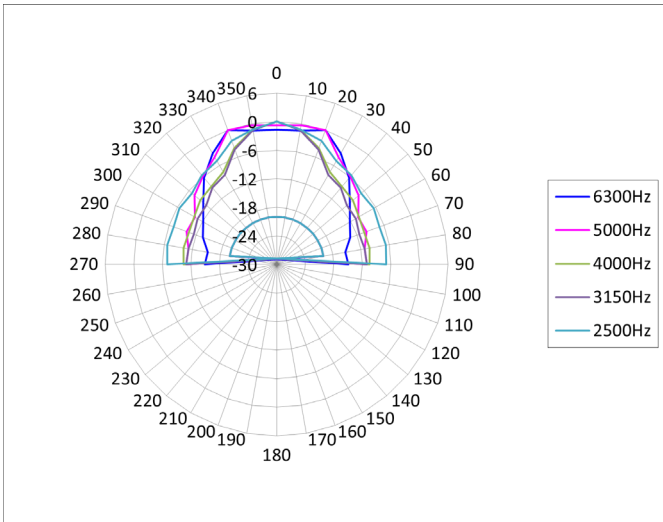
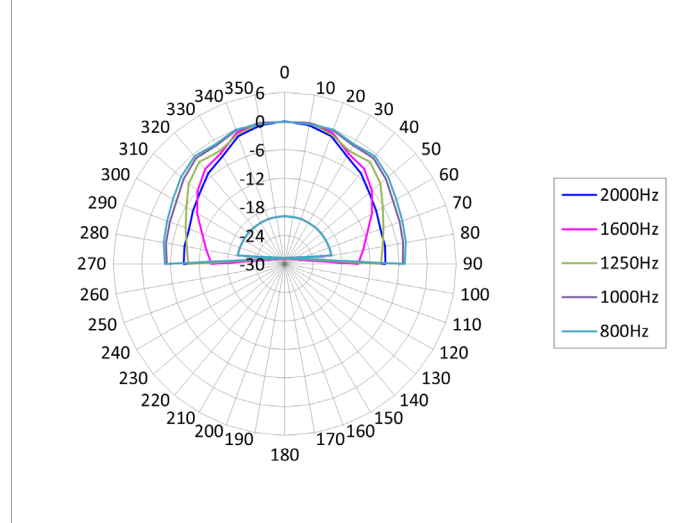
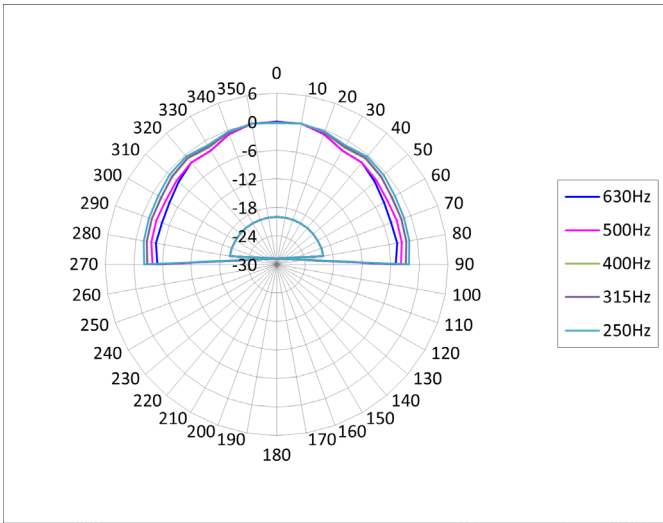

*All information subject to change without notice.

*All trademarks and registered trademarks are property of their respective owners.

Created in May, 2022