

# MAGELLAN™ 3410VSi

## PRODUCT REFERENCE GUIDE



Omni-Directional Imaging Scanner

 **DATALOGIC**

**Datalogic S.r.l.**

Via S. Vitalino, 13  
40012 Calderara di Reno — Italy  
Tel. +39 051 3147011  
Fax +39 051 3147205

**© 2021-2022 Datalogic S.p.A. and /or its affiliates**

All rights reserved. Without limiting the rights under copyright, no part of this documentation may be reproduced, stored in or introduced into a retrieval system, or transmitted in any form or by any means, or for any purpose, without the express written permission of Datalogic S.p.A. and/or its affiliates.

Owners of Datalogic products are hereby granted a non-exclusive, revocable license to reproduce and transmit this documentation for the purchaser's own internal business purposes. Purchaser shall not remove or alter any proprietary notices, including copyright notices, contained in this documentation and shall ensure that all notices appear on any reproductions of the documentation.

Electronic versions of this document may be downloaded from the Datalogic website ([www.datalogic.com](http://www.datalogic.com)). If you visit our website and would like to make comments or suggestions about this or other Datalogic publications, please let us know via the "Contact" page.

**Disclaimer**

Datalogic has taken reasonable measures to provide information in this manual that is complete and accurate, however, Datalogic shall not be liable for technical or editorial errors or omissions contained herein, nor for incidental or consequential damages resulting from the use of this material. Datalogic reserves the right to change any specification at any time without prior notice.

**Trademarks**

Datalogic and the Datalogic logo are registered trademarks of Datalogic S.p.A. in many countries, including the U.S.A. and the E.U.

Magellan is a trademark of Datalogic S.p.A. or of Datalogic and/or its affiliates, registered in many countries, including the U.S. and the E.U.

**Patents**

See [www.patents.datalogic.com](http://www.patents.datalogic.com) for patent list.

**The content of this manual refers to software version DR9401453.**

# TABLE OF CONTENTS

---

<b>CHAPTER 1. GETTING STARTED.....</b>	<b>1</b>
<b>About This Manual .....</b>	<b>1</b>
Manual Conventions .....	1
<b>SCANNER FEATURES .....</b>	<b>2</b>
<b>Connecting the Scanner .....</b>	<b>3</b>
<b>Mount Installation .....</b>	<b>6</b>
Wall Mount .....	6
Countertop Mount .....	7
Adjustable Riser .....	7
<b>CHAPTER 2. PROGRAMMING .....</b>	<b>8</b>
<b>About Programming your Scanner .....</b>	<b>8</b>
Programming with Barcodes .....	9
Getting Started .....	10
Programming Mode .....	10
Programming Session .....	11
If You Make a Mistake... .....	12
Return to Factory Settings .....	12
Datalogic Scanalyzer .....	13
Using a Bar Code Mask .....	13
Going Green .....	13
<b>Bar Code Mask .....</b>	<b>14</b>
<b>GENERAL SCANNER FEATURES.....</b>	<b>15</b>
SCANNING FEATURES .....	16
1D Double Read Timeout .....	16
2D Double Read Timeout .....	17
Double Read Table Size .....	18
DIGITAL WATERMARK (DIGIMARC®) FEATURES .....	19
Digital Watermark (Digimarc) Enable .....	19
Digital Watermark (Digimarc) Double Read Timeout .....	20
Digital Watermark (Digimarc) Data Format .....	21
Sleep Mode Timer .....	22
1D Inverse Read Control .....	23
2D Inverse Read Control .....	24
LED AND BEEPER INDICATORS .....	25
Power On Alert .....	25
Reading Illumination Duration .....	26
Illumination During Disable Mode .....	27
Object Sense Control .....	28
External Read Indicator (ERI) .....	29
ERI Timeout .....	29
Good Read LED Idle State .....	30
Scanner Control Button Options .....	31
Good Read Beep Control .....	32
Good Read Beep Frequency .....	33
Good Read Beep Length .....	34
Good Read Beep Volume .....	35

Good Read When to Indicate .....	36
Illumination Blank on Beep .....	37
Host Download to Handheld .....	38
Handheld Host Download Timeout .....	38
<b>IMAGING FEATURES .....</b>	<b>39</b>
IMAGING FEATURES .....	40
Image Capture to the Host by Host Command .....	40
Image Capture to the Host by Camera Button .....	41
Camera Button Mode .....	41
Image Destination .....	42
Picture Retrieval Timeout .....	43
Image Capture Delay .....	45
Image Format .....	46
Image Size .....	47
Image Brightness .....	48
Image Contrast .....	50
Image Compression .....	52
Region of Interest (ROI) .....	53
CELL PHONE SETTINGS .....	55
Cell Phone Mode .....	55
Cell Mode Percent .....	56
<b>INTERFACE RELATED FEATURES .....</b>	<b>57</b>
INTERFACE SELECTION .....	58
<b>Interface Type .....</b>	<b>58</b>
RS-232 Interface Selection .....	58
USB Interface Selection .....	59
Keyboard Interface Selection .....	59
INTERFACE FEATURES .....	60
Maximum Host-Transmitted Message Length .....	60
Ignore Host Commands .....	61
RS-232 INTERFACE FEATURES .....	62
RS-232 Baud Rate .....	62
RS-232 Number of Data Bits .....	63
RS-232 Number of Stop Bits .....	63
RS-232 Parity .....	64
RS-232 Hardware Control .....	65
RS-232 Intercharacter Delay .....	66
RS-232 Software Flow Control .....	67
RS-232 Beep on ASCII BEL .....	67
Beep on Not on File .....	68
RS-232 ACK NAK Features .....	69
ACK NAK Enable .....	69
RS-232 ACK Character .....	70
RS-232 NAK Character .....	71
RS-232 Retry on ACK NAK Timeout .....	71
RS-232 ACK NAK Timeout Value .....	72
RS-232 ACK NAK Retry Count .....	73
RS-232 ACK NAK Error Handling .....	74
RS-232 Indicate Transmission Failure .....	75
USB-COM INTERFACE FEATURES .....	76
USB-COM Interface Setup .....	76
USB Power Compliance .....	76
USB-OEM INTERFACE FEATURES .....	77
USB OEM Scanner Device Type .....	77
USB OEM Additional Interface Options .....	78
USB KEYBOARD FEATURES .....	79
Keyboard Layout .....	79
USB Keyboard Country Mode .....	79
USB Keyboard Caps Lock State .....	82
USB Keyboard Send Control Characters .....	83
Quiet Interval .....	84

USB Keyboard Intercharacter Delay .....	85
USB Keyboard Additional Interface Options .....	85
<b>DATA EDITING .....</b>	<b>86</b>
<b>Data Editing Overview .....</b>	<b>87</b>
Please Keep In Mind... .....	87
GLOBAL PREFIX/SUFFIX .....	88
Global Prefix .....	88
Global Suffix .....	89
AIM ID .....	90
LABEL ID .....	91
Label ID Control .....	91
Setting Label ID .....	92
1D Symbologies .....	92
2D Symbologies .....	97
Global Mid-Label ID .....	99
CASE CONVERSION .....	100
CHARACTER CONVERSION .....	101
<b>1D SYMBOLOGY PROGRAMMING .....</b>	<b>102</b>
1D Symbologies .....	102
COUPON CONTROL .....	103
Coupon Control Enable .....	103
Coupon Label Priority Timer .....	105
UPC-A .....	106
UPC-A Enable .....	106
UPC-A Number System Character Transmission .....	107
UPC-A Check Character Transmission .....	108
UPC-A Minimum Read .....	109
Expand UPC-A to EAN-13 .....	110
UPC-E .....	111
UPC-E Enable .....	111
UPC-E Number System Character Transmission .....	112
UPC-E Check Character Transmission .....	113
Expand UPC-E to UPC-A .....	114
Expand UPC-E to EAN-13 .....	114
UPC-E Minimum Read .....	115
EAN-13 .....	116
EAN-13 Enable .....	116
EAN-13 First Character Transmission .....	117
EAN-13 Check Character Transmission .....	118
EAN-13 ISBN Conversion Enable .....	119
EAN-13 Minimum Read .....	120
EAN-8 .....	121
EAN-8 Enable .....	121
EAN-8 Check Character Transmission .....	122
Expand EAN-8 to EAN-13 .....	123
EAN-8 Minimum Read .....	124
EAN-8 Guard Insertion .....	125
EAN-8 Guard Substitution .....	126
EAN-8/Jan-8 Both Guards Substitution .....	127
EAN-8 Stitch Exact Label Halves .....	128
EAN-8 Stitch Unlike Label Halves .....	129
EAN-8 Minimum Segment Length .....	130
EAN-8 Decoding Levels .....	132
OTHER UPC/EAN OPTIONS .....	133
In-Store Printed Label Minimum Read .....	133
UPC/EAN Guard Insertion .....	134
UPC/EAN Stitch Exact Label Halves .....	135
UPC/EAN Stitch Unlike Label Halves .....	136
UPC/EAN Minimum Segment Length .....	137
Price Weight Check .....	139
Enable EAN Two Label .....	140

EAN Two Label Minimum Read .....	141
EAN Two Label Combined Transmission .....	142
Add-ons .....	143
P2 Add-on Minimum Read .....	144
P5 Add-on Minimum Read .....	146
UPC/EAN Composites .....	149
GTIN .....	150
GTIN Enable .....	150
GS1 DATABAR .....	151
DATABAR OMNIDIRECTIONAL .....	151
DataBar Omnidirectional Enable .....	151
DataBar Omnidirectional/EAN-128 Emulation .....	152
DataBar Omnidirectional 2D Component Enable .....	153
DataBar Omnidirectional Minimum Read .....	154
DataBar Omnidirectional Double Read Timeout .....	155
DATABAR LIMITED .....	156
DataBar Limited Enable .....	156
DataBar Limited Minimum Read .....	157
DataBar Limited 2D Component Enable .....	158
DataBar Limited EAN128 Emulation Enable .....	159
DATABAR EXPANDED .....	160
DataBar Expanded Enable .....	160
DataBar Expanded EAN-128 Emulation .....	161
DataBar Expanded 2D Component Enable .....	162
DataBar Expanded Minimum Read .....	163
DataBar Expanded Length Control .....	164
DataBar Expanded Length 1 .....	165
DataBar Expanded Length 2 .....	166
DataBar Expanded Reverse Retry .....	167
Code 39 .....	168
Code 39 Enable .....	168
Code 39 Start Stop Character Transmission .....	169
Code 39 Check Character Calculation .....	170
Code 39 Check Character Transmission .....	171
Code 39 Full ASCII .....	172
Code 39 Minimum Read .....	173
Code 39 Length Control .....	174
Code 39 Length 1 .....	175
Code 39 Length 2 .....	176
Code 39 Stitching .....	177
Code 39 Require Margins .....	178
Code 32 Italian Pharmacode .....	179
Code 32 Italian Pharmacode Enable .....	179
Code 32 Start Stop Character Transmission .....	180
Code 32 Check Character Transmission .....	181
Code 128 .....	182
Code 128 Enable .....	182
Code 128 Transmit Function Characters .....	183
Expand Code128 to Code 39 .....	184
Code 128 Minimum Read .....	185
Code 128 Length Control .....	186
Code 128 Length 1 .....	187
Code 128 Length 2 .....	188
Code 128 Stitching .....	189
EAN-128 .....	190
EAN-128 Enable .....	190
Interleaved 2 of 5 (I 2 OF 5) .....	191
Interleaved 2 of 5 (I 2 OF 5) Enable .....	191
I 2 of 5 Check Character Calculation .....	192
I 2 of 5 Check Character Transmission .....	193
I 2 of 5 Minimum Read .....	194

I 2 of 5 Length Control .....	195
I 2 of 5 Length 1 .....	196
I 2 of 5 Length 2 .....	197
Codabar .....	198
Codabar Enable .....	198
Codabar Start Stop Character Transmission .....	199
Codabar Start Stop Character Set .....	200
Codabar Start Stop Character Match .....	201
Codabar Check Character Calculation .....	202
Codabar Check Character Transmission .....	203
Codabar Minimum Read .....	204
Codabar Length Control .....	205
Codabar Length 1 .....	206
Codabar Length 2 .....	207
Codabar Require Margins .....	208
Code 93 .....	209
Code 93 Enable .....	209
Code 93 Minimum Read .....	210
Code 93 Length Control .....	211
Code 93 Length 1 .....	212
Code 93 Length 2 .....	213
MSI .....	214
MSI Enable .....	214
MSI Check Character Calculation .....	215
MSI Number of Check Characters .....	216
MSI Check Character Transmission .....	217
MSI Minimum Read .....	218
MSI Length Control .....	219
MSI Length 1 .....	220
MSI Length 2 .....	221
Standard 2 of 5 .....	222
Standard 2 of 5 Enable .....	222
Standard 2 of 5 Check Character Calculation .....	223
Standard 2 of 5 Check Character Transmission .....	224
Standard 2 of 5 Minimum Read .....	225
Standard 2 of 5 Length Control .....	226
Standard 2 of 5 Length 1 .....	227
Standard 2 of 5 Length 2 .....	228
<b>2D SYMBOLOGIES / BAR CODES.....</b>	<b>229</b>
2D CODES .....	229
DATA MATRIX .....	230
Data Matrix Enable .....	230
Data Matrix Length Control .....	231
Configuring Variable Length Decoding: .....	231
Data Matrix Length 1, Length 2 Programming Instructions .....	232
GS1 Datamatrix Enable .....	233
PDF 417 .....	234
PDF 417 Enable .....	234
PDF 417 Length Control .....	235
PDF 417 Length 1, Length 2 Programming Instructions .....	236
PDF 417 Read Option .....	237
MICRO PDF 417 .....	238
Micro PDF 417 Enable .....	238
Micro PDF 417 Length Control .....	239
Micro PDF 417 Length 1, Length 2 Programming Instructions .....	240
Micro PDF 417 128 Emulation .....	241
QR CODE .....	242
QR Code Enable .....	242
QR Code Length Control .....	243
QR Code Length 1, Length 2 Programming Instructions .....	244
QR Code URL Link Enable .....	245

GS1 QR Code Enable .....	246
MICRO QR CODE .....	247
Micro QR Code Enable .....	247
Micro QR Code Length Control .....	248
Micro QR Code Length 1, Length 2 Programming Instructions .....	249
AZTEC CODE .....	250
Aztec Enable .....	250
Aztec Length Control .....	251
Aztec Length 1, Length 2 Programming Instructions .....	252
HAN XIN CODE .....	253
Han Xin Enable .....	253
DOTCODE .....	254
Dotcode Enable .....	254
<b>CHAPTER 3. REFERENCES .....</b>	<b>255</b>
<b>Global Prefix/Suffix .....</b>	<b>256</b>
<b>Label ID .....</b>	<b>257</b>
<b>Length Control .....</b>	<b>258</b>
Configuring Variable Length Decoding: .....	258
Length 1, Length 2 Programming Instructions .....	258
<b>APPENDIX A. PRODUCT SPECIFICATIONS .....</b>	<b>259</b>
<b>Technical Specifications .....</b>	<b>260</b>
Decoding Capability .....	260
Electrical Specifications .....	260
Environmental .....	260
Interfaces .....	260
Optional Features .....	261
<b>Physical Characteristics .....</b>	<b>261</b>
Scanner Dimensions .....	261
<b>Reading Performance .....</b>	<b>262</b>
Reading Ranges .....	262
<b>Safety &amp; Regulatory .....</b>	<b>262</b>
<b>Utilities .....</b>	<b>263</b>
<b>Warranty .....</b>	<b>263</b>
<b>LED and Beeper Indicators .....</b>	<b>263</b>
<b>Error Codes .....</b>	<b>264</b>
<b>APPENDIX B. CABLE PINOUTS .....</b>	<b>265</b>
<b>Standard Cable Pinouts (Primary Interface Cables) .....</b>	<b>265</b>
<b>APPENDIX C. ALPHA-NUMERIC KEYPAD .....</b>	<b>266</b>
<b>APPENDIX D. FACTORY DEFAULT SETTINGS .....</b>	<b>268</b>
Factory Default Settings .....	268
<b>APPENDIX E. KEYBOARD FUNCTION KEY MAPPINGS .....</b>	<b>277</b>
USB Function Key Usage Map .....	277
<b>APPENDIX F. HOST COMMANDS .....</b>	<b>284</b>
<b>Accepting RS-232 AND USB COM Commands .....</b>	<b>284</b>
<b>APPENDIX G. SAMPLE SYMBOLS .....</b>	<b>285</b>
<b>1D Symbol Samples .....</b>	<b>285</b>
<b>2D Sample Symbols .....</b>	<b>287</b>
<b>Composite Sample Symbols .....</b>	<b>288</b>
<b>APPENDIX H. MICROSD CARD .....</b>	<b>289</b>
<b>microSDHC Compatibility .....</b>	<b>290</b>
microSD Card Insertion .....	290



microSD Card Removal .....	290
<b>Autorun File Processing .....</b>	<b>291</b>
<b>microSD Function Summary .....</b>	<b>291</b>
<b>microSD Function Details .....</b>	<b>292</b>
From Scanner to microSD Card .....	292
Capture and save an image to a microSD card by button press .....	292
Export a Configuration file from the Scanner to the microSD card .....	292
From microSD Card to Scanner .....	292
Application code load to scanner .....	292
Configuration load to scanner .....	293

## **APPENDIX I. HANDHELD DATA FORMAT REQUIREMENTS ..... 294**

<b>Handheld Data Format Requirements General .....</b>	<b>294</b>
Datalogic Handheld Data Format Requirements .....	294
GS1 DataBar Omnidirectional .....	294
GS1 DataBar Expanded .....	295
UPC-A .....	295
UPC-A with 2-Digit Supplemental .....	295
UPC-A with 5-Digit Supplemental .....	295
UPC-E .....	295
UPC-E with 2-Digit Supplemental .....	295
UPC-E with 5-Digit Supplemental .....	295
EAN-8 .....	295
EAN-8 with 2-Digit Supplemental .....	295
EAN-8 with 5-Digit Supplemental .....	296
EAN-13 .....	296
EAN-13 with 2-Digit Supplemental .....	296
EAN-13 with 5-Digit Supplemental .....	296
Code 39 .....	296
Code 39-Pharmacode .....	296
I 2 of 5 .....	296
Codabar .....	297
Code 128 .....	297
MSI .....	297
Code 93 .....	297
PDF417 .....	297
AIM Formats .....	298
UPC-A .....	298
UPC-E .....	298
EAN-13 .....	298
EAN-8 .....	298
2-Digit Supplemental .....	298
5-Digit Supplemental .....	298
Bookland .....	299
Code 39 .....	299
Codabar .....	299
MSI .....	299
Code 93 .....	299
RSS-14 .....	300
RSS Expanded .....	300
I 2 of 5 .....	300
Code 128 / EAN128 .....	300
PDF417 .....	300
"Unknown" AIM ID (an AIM ID which is not specified above) .....	300

## **APPENDIX J. ASCII CHART ..... 301**

---

# NOTES

# CHAPTER 1

## GETTING STARTED

---

### ABOUT THIS MANUAL

This manual provides advanced user information, including connection, programming, product and cable specifications, and other useful references. For additional information, such as installation, maintenance, troubleshooting and warranty information, see the Quick Reference Guide (QRG). Copies of other publications for this product can be downloaded free of charge from the website listed on the back cover of this manual.

On leaving the factory, units are programmed for the most common terminal and communications settings. If you need to change these settings, custom programming can be accomplished by scanning the bar codes in this guide. The most common default settings for features/options are indicated by a green arrow.

### Manual Conventions

The symbols listed below are used in this manual to notify the reader of key issues or procedures that must be observed when using the scanner:



**NOTES** contain information necessary for properly diagnosing, repairing and operating the scanner.



The **CAUTION** symbol advises you of actions that could damage equipment or property.

# SCANNER FEATURES

The Magellan™ 3410VSi On-Counter Vertical Presentation Scanner is designed for small counter retail checkout environments where there is a relatively high number of transactions with a fairly small number of items per transaction. The scanner has a reduced footprint, allowing more room for item merchandising of high margin impulse items clustered around the POS (Point of Sale).

Figure 1. Scanner Features - Front View

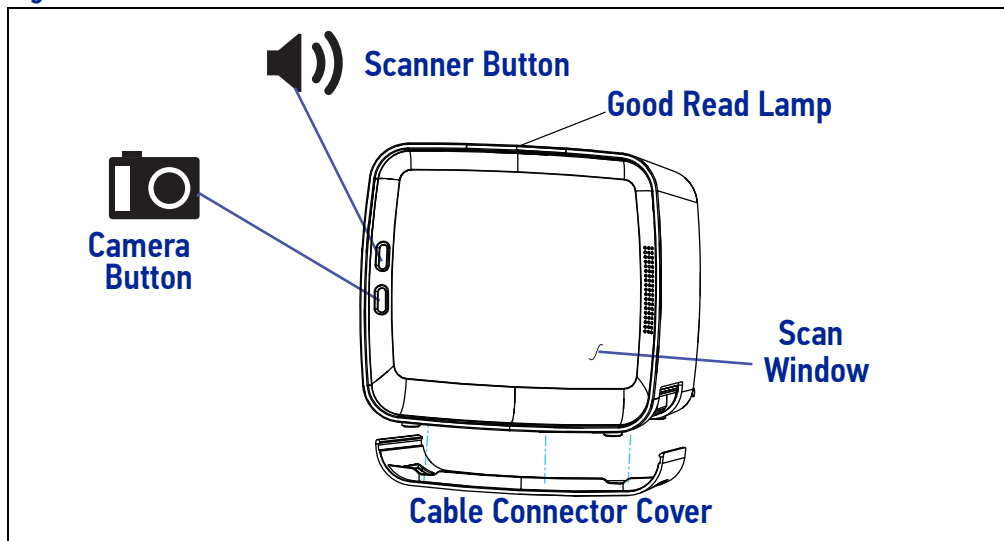

Figure 2. Scanner Features - Back View

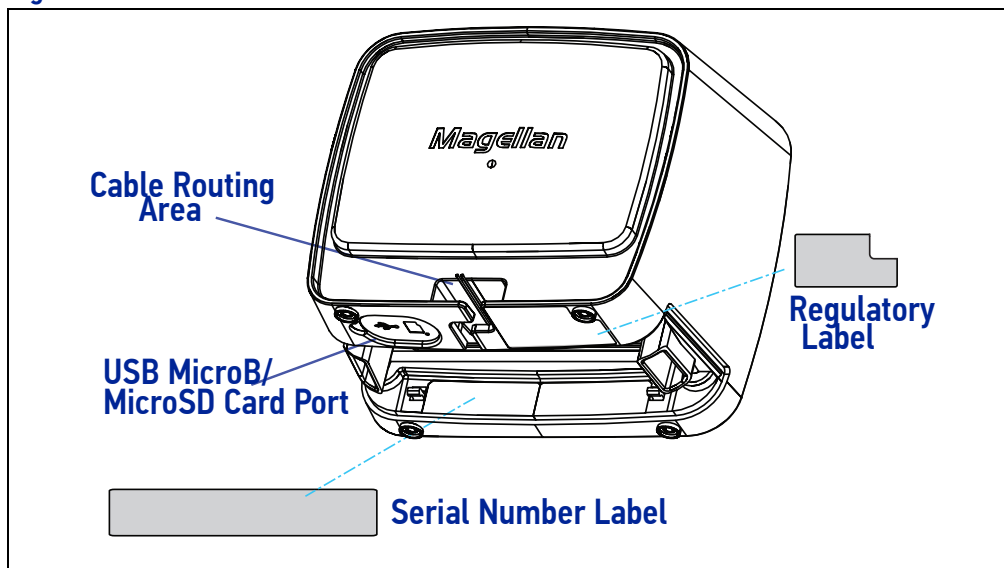
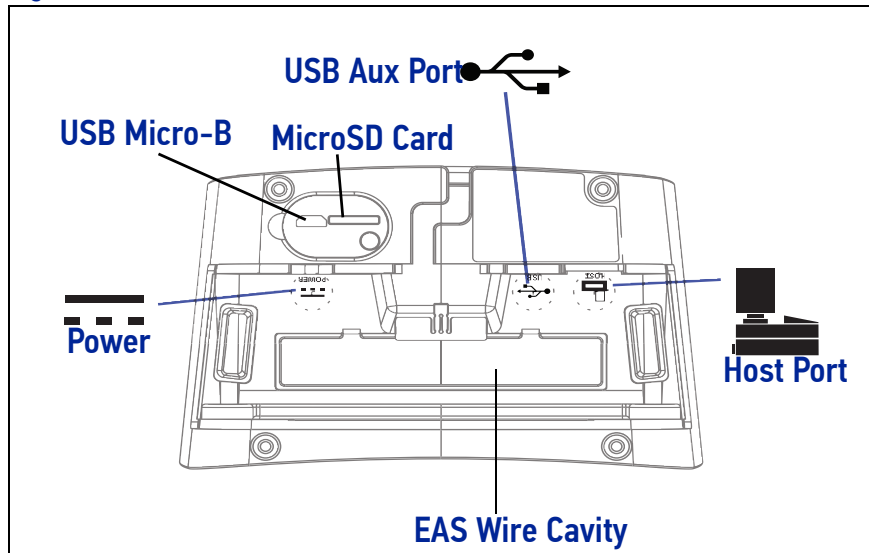

Figure 3. Scanner Features - Bottom View



## CONNECTING THE SCANNER

The scanner kit you ordered to match your interface should provide a compatible cable for your installation. Alternatively, it may be possible to connect using a cable from a previously existing installation. Check with your technical support representative about compatibility before connecting. For Powering Off Terminal (POT), please reference [Electrical Specifications](#) on page A-260 of Appendix A to ensure your Host Terminal's power supply is compatible, or contact Datalogic Technical Support.

The USB AUX PORT will only be supported by using a 12V power supply or using a USB + POWER 12V port. If the scanner is powered only by the standard USB cable as shown in Figure 6, an auxiliary scanner will not be supported.

Use the appropriate instructions below when you're ready to connect the scanner to the terminal, PC or other host device. Upon completing the connection, proceed to the [Interface Related Features](#) section of this manual and scan the bar code to select the correct interface type.

**RS-232 Serial Connection :** Turn off power to the terminal/PC and connect the scanner to the terminal/PC serial port via the RS-232 cable as shown in the following figures. If the terminal will not support POT (Power Off the Terminal) to supply scanner power, use the approved power supply (AC Adapter).

Figure 4. USB + Power Cable Power Off the Terminal

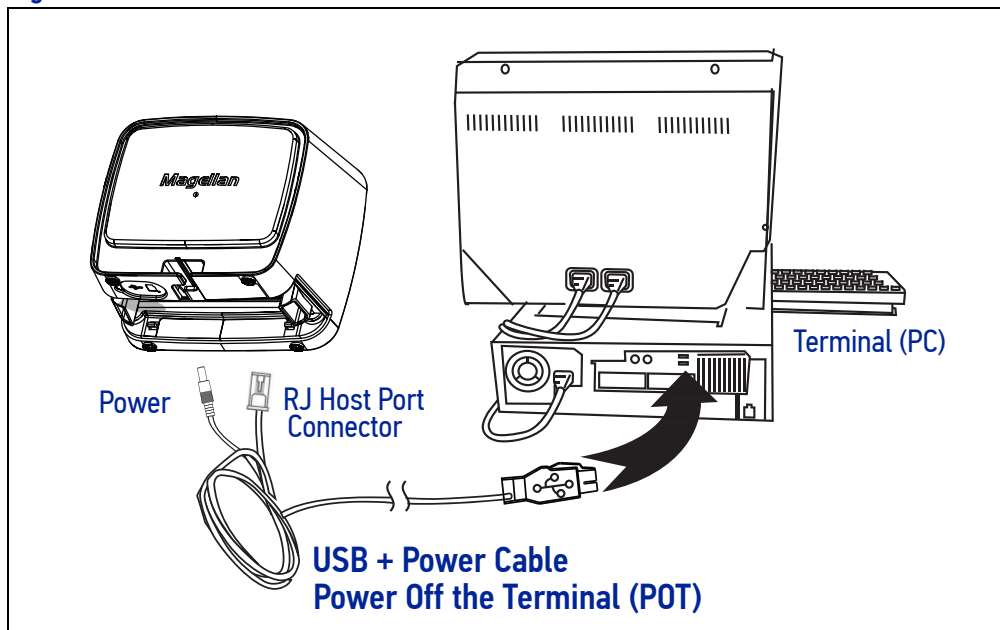
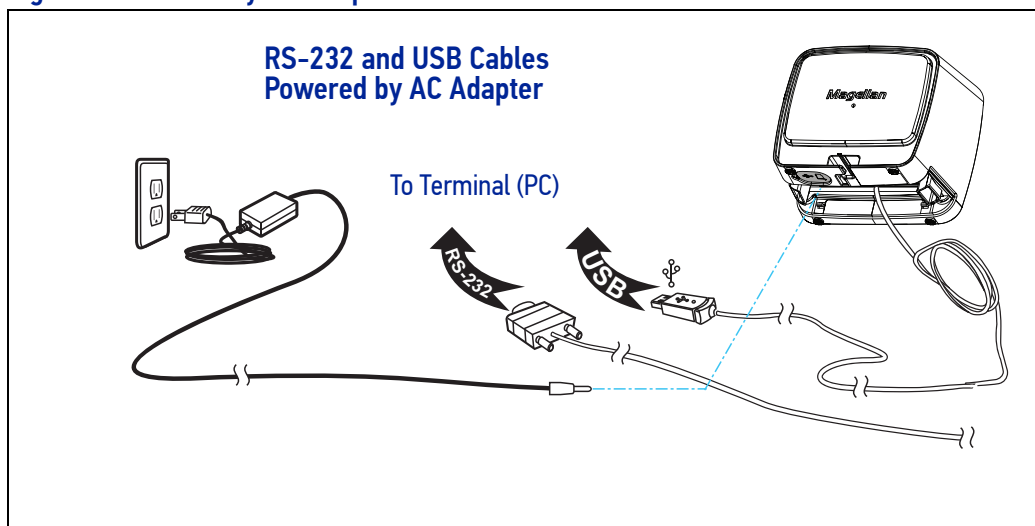

Figure 5. Powered by AC Adapter



**USB Connection :** Connect the scanner to a USB port on the terminal/PC using the correct USB cable for the interface type you ordered. Reference the figures on this and the previous page.

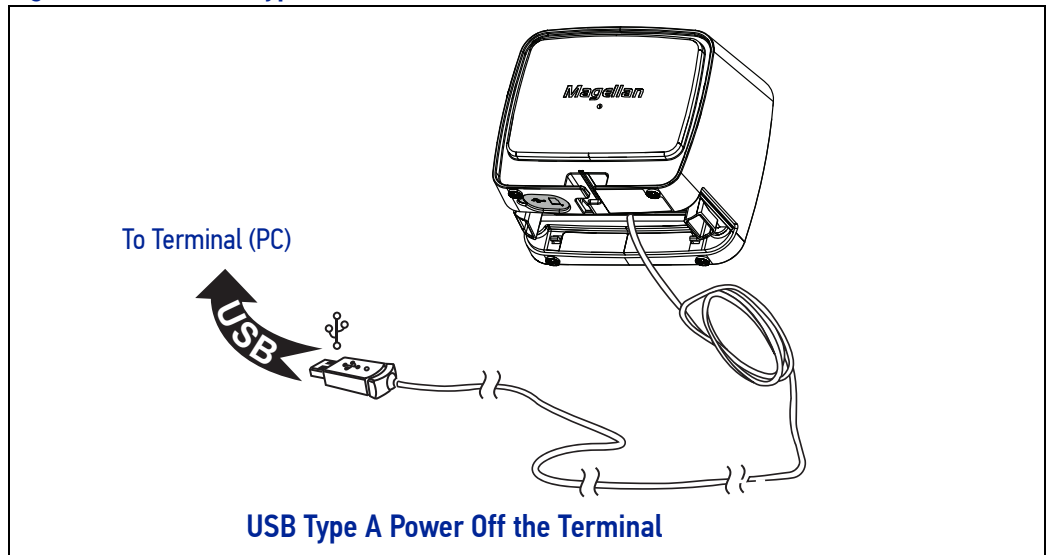

**NOTE: USB installations may require a power connection via an approved A/C Adapter as shown. For example, this would be the case if the scanner is connected along with a number of other devices to a non-powered USB hub.**

**Figure 6. USB Cable Type A Power Off the Terminal**

**NOTE:** This cable (or similar) will not support a USB peripheral. The system must be powered by 12V in order for a peripheral to be attached to the AUX USB PORT.

## MOUNT INSTALLATION

Options for mounting the scanner to a wall or countertop include an L-Bracket or an adjustable riser. Figure 7 shows the scanner being seated in an L-Bracket.

**Figure 7. L-Bracket Mount**

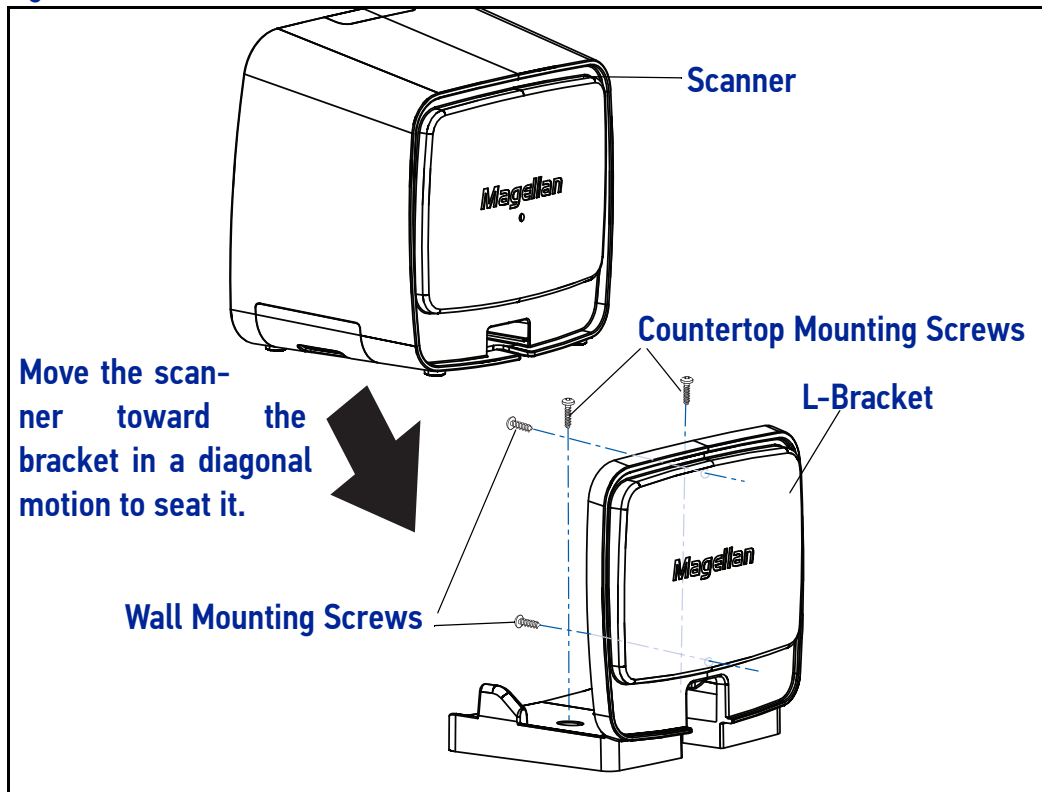

## Wall Mount

When using the L-Bracket for wall mount installation, pre-drill the center of the two wall mount bosses (shown in Figure 8) using a 4.5mm or 11/64" drill.

Attach the L-Bracket to the wall over the two drilled holes shown in Figure 8 using two pan head M4 or #8 screws (8.2mm or 5/16" maximum head diameter) with threads that suit the mounting surface of the wall.



**CAUTION: Do not remove the plastic ribs around the mounting holes and do not overtighten the mounting screws as this may damage the wall mount.**

**Figure 8. Wall Mount Drill Location**

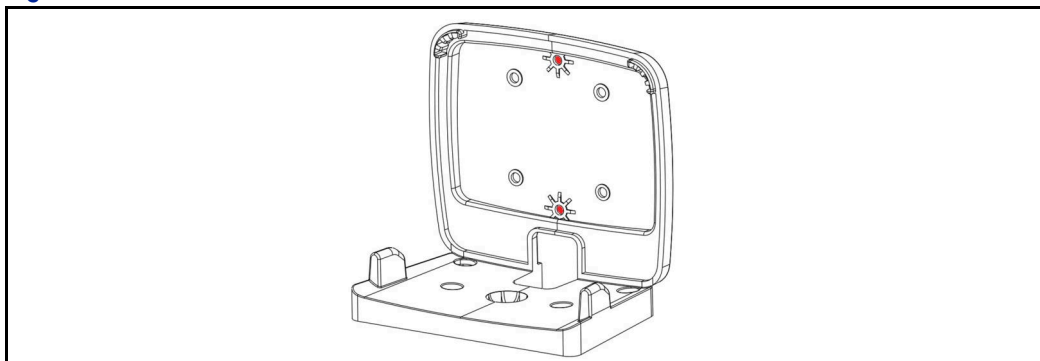



## Countertop Mount

If using the L-Bracket alone for countertop installation, secure the bracket in place using two screws through the bottom face of the bracket (see Figure 7). It is recommended to use two pan head (8.2mm or 5/16" maximum head diameter) #8 screw with a thread profile that suits the mounting surface material in the countertop.



**CAUTION: Do not use a countersink type of screw head. Damage will occur from use of a countersunk screw head in the plastic screw bosses**

## Adjustable Riser

The Adjustable Riser may be attached as shown.

**Figure 9. Using the Adjustable Riser**

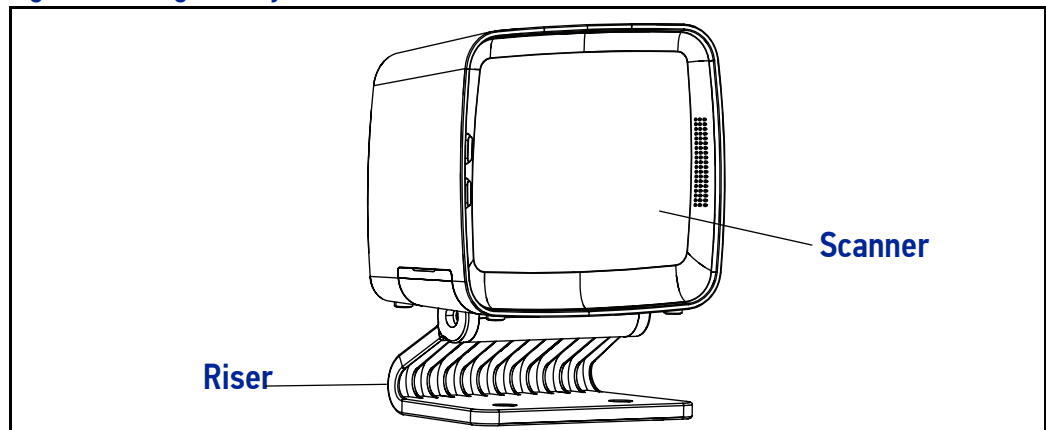

# CHAPTER 2

## PROGRAMMING

---

### ABOUT PROGRAMMING YOUR SCANNER

This PRG lists the master defaults for the Magellan 3410VSi. These master defaults can be modified depending on the configuration file loaded into the scanner at the time of manufacture. This allows the user to customize and adapt the scanner performance for their changing needs. Specific configuration settings are also optimized for the active host interface. Datalogic Technical Support can assist with creating custom configurations.

The scanner is typically factory-configured with a set of default features standard to the interface type you ordered. The scanner's programmable feature settings can be modified to accommodate your system's unique requirements.

If you need to change these settings, custom programming can be accomplished using one of the following methods:

**Programming Barcodes:** The programming bar code labels contained in this manual will allow you to customize and configure features and settings for your scanner. Go to "Programming with Barcodes" on page 9 to get started.

**Datalogic Scanalyzer Configuration Utility:** An additional programming option is to use Datalogic's Scanalyzer software configuration utility, available for free download from the Datalogic website. See "Datalogic Scanalyzer" on page 13 for more information.



**NOTE:** When you program the scanner using either of the methods listed above, the scanner will store the changes until reprogrammed or returned to factory defaults.

## Programming with Barcodes

If you have little or no prior experience with programming using barcode labels, you should review the next few pages of this section to familiarize yourself with the basics of scanner programming before performing any changes to your configuration.

Most scanner programming falls within general categories:

**General Scanner Features:** features common to all interface types. Examples include beeper adjustments such as volume and length, read verification settings, etc.

**Imaging Features:** settings specific to Imaging

**Interface Related Features:** mandatory settings necessary to allow communication. Examples of these settings are: RS-232 baud rate and parity.



**NOTE: Ensure that your planned modifications are compatible with the current interface.**

**Data Editing:** Additional information sent to the host computer along with the barcode data. This combination of barcode data and supplementary user-defined data is called a “message string.” The features in this chapter can be used to build specific user-defined data into a message string.

**Symbology Programming:** Gives the scanner the capability to autodiscriminate as few as one and as many as all available symbologies. For optimal scanner performance enable only those symbologies required. Additionally the scanner may be programmed with the standard options available for the various symbologies, such as check digit, minimum label length, fixed and variable length bar codes, etc.

The barcode programming section lists the factory default settings for each of the menu commands for the standard RS-232 interface, indicated by green shading. Exceptions to default settings for the other interfaces can be found in [Appendix D](#).

If you experience difficulties, have questions or require additional information, contact your local distributor, or call your dealer or sales representative.

## Getting Started

After scanning the interface barcode from the Interface Features section, you can select other options and customize your scanner through use of the instructions and programming barcodes available in that section and also the Data Editing and Symbologies chapters of this manual.



**NOTE: When you program the scanner using any of the methods above, the scanner will store the changes until reprogrammed or returned to factory defaults.**

## Programming Mode

Scan the Enter/Exit Programming Mode barcode found at the top of applicable pages) once to enter Programming Mode. After the scanner is in Programming Mode, you can scan a number of parameter settings before scanning the Enter/Exit Programming Mode barcode a second time, which will then accept your changes, exit Programming Mode, reset the scanner and return it to normal operation.



**NOTE: While in Programming Mode, your scanner will read the 2D programming bar codes in this manual regardless of whether 2D reading capability has been enabled as an option.**

The scanner will exit Programming Mode under any of the following conditions:

- the programming sequence has been completed or the Enter/Exit Programming Mode bar code is scanned.
- five minutes have passed without scanning activity. Any data programmed during the current session will be ignored, and the scanner will reset and revert to its condition previous to initiating the exited session.
- power is disconnected. Disconnecting power during Programming Mode, before scanning the Enter/Exit Programming Mode bar code, will cause all new settings to be ignored<sup>1</sup>. On powerup, the scanner will return to previous settings.

While in Programming Mode, the scanner only recognizes the special programming bar codes contained in this programming guide. See [Appendix A](#) for information about scanner indications while in the Programming Mode.

Some programming barcode labels, like the label on [page 12](#), require only the scan of that single label to enact the change. Most of the programming labels in this manual, however, require the scanner to be placed in Programming Mode prior to scanning them.

---

1. Exception: If an interface bar code had been read while in Programming Mode, the scanner will operate on the default settings for the new interface.

## Programming Session

A typical programming session is conducted as follows:

1. Scan the **Enter/Exit Programming Mode** bar code to place the scanner in Programming Mode. Depending upon its current programming, the scanner may emit a beep or beeps, indicating it has read the bar code and the green LED will flash on and off slowly while the scanner remains in Programming Mode. Normal scanning functions are disabled.
2. Scan the programming bar code(s) to make the desired changes. The beeper will sound as programming barcode labels are scanned, indicating progress during scanner configuration. The beep may vary depending upon the feature being configured.



**NOTE: Not all features are available for all interfaces and the scanner will sound an error tone when scanning programming bar codes for features invalid to the current interface. Only features supported by the currently active interface will be implemented.**



**NOTE: If a bar code is scanned that changes the scanner's interface, all previous configuration items scanned in the programming session are lost.**

Additionally, when programming a feature requiring you to scan single digits to set a multi-digit number, such as Minimum Label Length, do not scan bar code (or any item tag/item value bar code) before completing all input. To do so will result in an error tone and cause the scanner to exit Programming Mode. Under these circumstances, the current feature you were trying to set is not applied, but any previous bar codes scanned during the session will still take effect.



**NOTE: It is recommended that programming sessions be limited to one feature at a time. Should you make a mistake in the programming sequence, it can be difficult to discover where an error has been made if several features are programmed at once. Additionally, it can be confusing to determine which features may or may not have been successfully set following such a session.**

3. Scan the **Enter/Exit Programming Mode** bar code to save any new settings and exit Programming Mode. The scanner will sound a beep and reset upon exiting Programming Mode, and the green LED will return to its usual state (on steady or off).
4. Maintain a good record of all changes made to ensure that you know if the original factory settings have been changed.

## If You Make a Mistake...

If, during a programming session, you find that you are unsure of the scanner's settings or wish to reset the scanner's configuration, use the Return to Factory Settings label below to return the scanner's configuration to the factory settings. Scanning this label will also reset any changes made during previous programming sessions.

### Return to Factory Settings

Scan the bar code below to return the scanner to the default settings configured at the factory for the currently active interface. This bar code is typically used to return the scanner to a "known" operating state when the present programming status is not known, faulty, or suspect.



**CAUTION: Use this bar code with caution, since it will reset ALL features that may have been programmed since the scanner's installation.**



**NOTE: DO NOT scan the Enter/Exit Programming Mode bar code before and after scanning this bar code.**



Standard Product Default Settings

## Datalogic Scanalyzer

The Datalogic website offers free download of the Datalogic Scanalyzer Configuration and Maintenance Tool. This program may be used instead of or in addition to the programming labels in this manual.

The Datalogic Scanalyzer Configuration and Maintenance Tool ('Scanalyzer tool') is a Microsoft Windows®-based utility for current Datalogic Fixed Retail Products. The Scanalyzer tool has the ability to manage your Datalogic Fixed Retail Scanner, offering the following capabilities:

- Create and print your own programming barcode labels for scanning.
- Create, save, modify, upload, and download configuration files.
- Examine scanner configuration and compare to other files or default values.
- Read and modify individual configuration items on the scanner via a command interface.
- Read and save scanner information such as firmware version, model number and interface.
- Update scanner firmware.
- Read, save and send scanner event logs and statistics.

It is recommended that you have some familiarity with the product as well as a fundamental knowledge of the various operating modes prior to making any changes.

## Using a Bar Code Mask

The programming bar codes in this manual have been placed as multiples per page. In order to present them only one at a time to the scanner, a bar code mask is provided on the opposite side of this page.

## Going Green

Thank you for using the bar code mask on the opposite side of this page. This manual has been formatted to minimize the quantity of pages needed to provide all of the programming bar codes available for this product.



# BAR CODE MASK

Cut a hole in this page and remove it from the manual as indicated to create a sleeve through which bar codes (starting in the following section) can be individually viewed and scanned, if needed. It is important that only one bar code at a time be presented to the scanner.

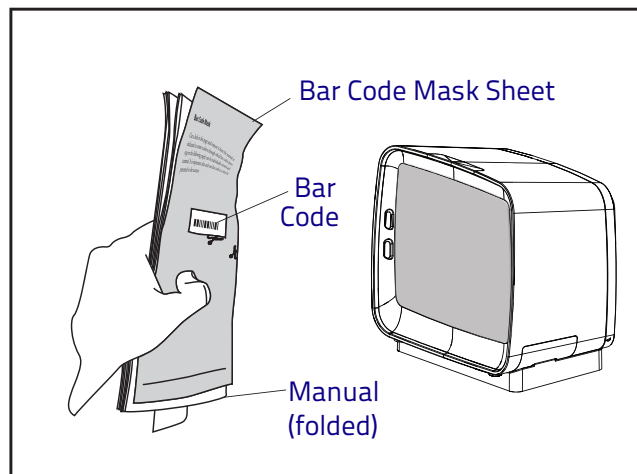
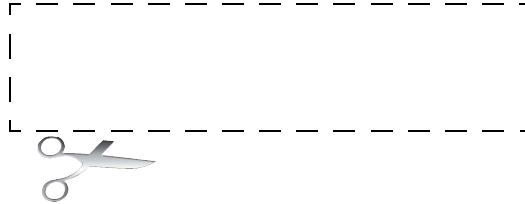



# CONFIGURATION | GENERAL SCANNER FEATURES

## SECTION CONTENTS

### SCANNING FEATURES starting on page 16

- |  |   |
|--|---|
| <ul style="list-style-type: none"> <li>•1D Double Read Timeout on page 16</li> <li>•2D Double Read Timeout</li> <li>•Double Read Table Size</li> <li>•Digital Watermark (Digimarc®) Features               <ul style="list-style-type: none"> <li>- Digital Watermark (Digimarc) Enable</li> <li>- Digital Watermark (Digimarc) Double Read Timeout</li> <li>- Digital Watermark (Digimarc) Data Format</li> </ul> </li> </ul> | <ul style="list-style-type: none"> <li>•Sleep Mode Timer</li> <li>•1D Inverse Read Control</li> <li>•2D Inverse Read Control</li> </ul> |
|--|---|

### LED AND BEEPER INDICATORS starting on page 25

- |   |  |
|---|--|
| <ul style="list-style-type: none"> <li>•Power On Alert</li> <li>•Reading Illumination Duration</li> <li>•Illumination During Disable Mode</li> <li>•Object Sense Control</li> <li>•External Read Indicator (ERI)</li> <li>•ERI Timeout</li> <li>•Good Read LED Idle State</li> <li>•Scanner Control Button Options</li> </ul> | <ul style="list-style-type: none"> <li>•Good Read Beep Control</li> <li>•Good Read Beep Frequency</li> <li>•Good Read Beep Length</li> <li>•Good Read Beep Volume</li> <li>•Good Read When to Indicate</li> <li>•Illumination Blank on Beep</li> </ul> |
|---|--|

### HOST DOWNLOAD TO HANDHELD starting on page 38

- Handheld Host Download Timeout



## SCANNING FEATURES

### 1D Double Read Timeout

The 1D Double Read Timeout feature specifies the minimum allowable time which must pass before reading the same 1D label again (e.g. two identical items in succession).

To set the Double Read Timeout:

1. Scan the Enter/Exit Programming Mode bar code.
2. Scan your selection from the bar codes below. You'll need to cover any unused bar codes on this and the facing page to ensure that the scanner reads only the bar code you intend to scan.
3. Complete the programming sequence by scanning the Enter/Exit Programming Mode bar code.



**NOTE: If the incidence of multiple reads is not acceptable, increase the Double Read Timeout setting to a higher value.**



1D Double Read Timeout = 300ms



★ 1D Double Read Timeout = 400ms



1D Double Read Timeout = 600ms



1D Double Read Timeout = 800ms

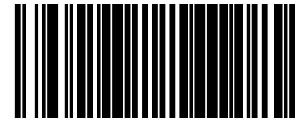

## 2D Double Read Timeout

The 2D Double Read Timeout feature specifies the minimum allowable time which must pass before reading the same 2D label again (e.g. two identical items in succession).

To set this feature:

1. Scan the Enter/Exit Programming Mode bar code.
2. Scan your selection from the bar codes below. You'll need to cover any unused bar codes on this and the facing page to ensure that the scanner reads only the bar code you intend to scan.
3. Complete the programming sequence by scanning the Enter/Exit Programming Mode bar code.



**NOTE: If the incidence of multiple reads is not acceptable, increase the Timeout setting to a higher value.**



2D Double Read Timeout = 300ms



2D Double Read Timeout = 400ms



2D Double Read Timeout = 600ms



★ 2D Double Read Timeout = 700ms



2D Double Read Timeout = 800ms



## Double Read Table Size

Specifies the number of labels to be tracked if double read protection is needed. Contact Technical Support for more information.

To set this feature:

1. Scan the Enter/Exit Programming Mode barcode at the top of the page.
2. Scan the barcode below. You'll need to cover any unused barcodes on this and the facing page to ensure that the scanner reads only the barcode you intend to scan.
3. Scan the appropriate digits from the [Alpha-Numeric Keypad in Appendix C](#) that represent the desired number of entries, using hex values. The selectable range is 01-25. Pad all numbers with leading zeros to yield a two-digit entry.
4. Scan the Enter/Exit Programming Mode barcode at the top of the page to exit Programming Mode.

★ Default setting for this feature is: 7 Entries

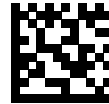

Set Double Read Table Size

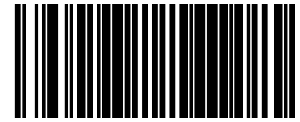

## DIGITAL WATERMARK (DIGIMARC®) FEATURES

### Digital Watermark (Digimarc) Enable

Enables/Disables the ability of the scanner to decode Digimarc® Digital Watermarks.

To set this feature:

1. Scan the Enter/Exit Programming Mode bar code.
2. Scan your selection from the bar codes below. You'll need to cover any unused bar codes on this and the facing page to ensure that the scanner reads only the bar code you intend to scan.
3. Complete the programming sequence by scanning the Enter/Exit Programming Mode bar code.



★ Digital Watermark (Digimarc) = Disable



Digital Watermark (Digimarc) = Enable



## Digital Watermark (Digimarc) Double Read Timeout

Specifies the minimum allowable time which must pass before reading the same Digital Watermark (Digimarc) label again (e.g. two identical items in succession).

To set this feature:

1. Scan the Enter/Exit Programming Mode bar code.
2. Scan your selection from the bar codes below. You'll need to cover any unused bar codes on this and the facing page to ensure that the scanner reads only the bar code you intend to scan.

Complete the programming sequence by scanning the Enter/Exit Programming Mode bar code.



**NOTE: If the incidence of multiple reads is not acceptable, increase the Double Read Timeout setting to a higher value.**



Digimarc Double Read Timeout = 0.3 Seconds



Digimarc Double Read Timeout = 0.4 Seconds



★ Digimarc Double Read Timeout = 0.5 Seconds



Digimarc Double Read Timeout = 0.7 Seconds



Digimarc Double Read Timeout = 1 Second

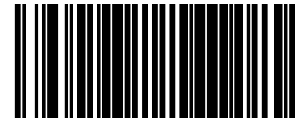

## Digital Watermark (Digimarc) Data Format

Selects the format for the watermark data. Choices are:

- Compatibility mode
- Databar-14
- Native

1. Scan the Enter/Exit Programming Mode bar code.
2. Scan your selection from the bar codes below. You'll need to cover any unused bar codes on this and the facing page to ensure that the scanner reads only the bar code you intend to scan.
3. Complete the programming sequence by scanning the Enter/Exit Programming Mode bar code.



**NOTE: The Digital Watermark feature must be enabled for decode functionality.**



★ Digital Watermark (Digimarc) Data Format =  
Compatibility mode



Digital Watermark (Digimarc) Data Format = Databar-  
14 mode



Digital Watermark (Digimarc) Data Format = Native  
mode



## Sleep Mode Timer

This feature specifies the amount of time of inactivity (with no label reads) before the scanner enters sleep mode.

To set this feature:

1. Scan the Enter/Exit Programming Mode bar code.
2. Scan the bar code, [Set Sleep Mode Timer](#) below. You'll need to cover any unused bar codes on this and the facing page to ensure that the scanner reads only the bar code you intend to scan.
3. Scan the appropriate digits from the [Alpha-Numeric Keypad in Appendix C](#) that represent the desired time interval. The selectable range is 000-255 in 15 second increments. Pad all numbers with leading zeros to yield a three-digit entry (000-255).
4. Scan the Enter/Exit Programming Mode bar code to exit Programming Mode.

★ Default setting for this feature is: 5 minutes



Set Sleep Mode Timer



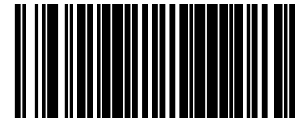

## 1D Inverse Read Control

This configuration item is used to toggle inverted label reading for 1D bar codes, for example, a label printed as white on black as opposed to black on white.

1. Scan the Enter/Exit Programming Mode bar code.
2. Scan your selection from the bar codes below. You'll need to cover any unused bar codes on this and the facing page to ensure that the scanner reads only the bar code you intend to scan.
3. Finish by scanning the Enter/Exit Programming Mode bar code.



★ 1D Inverse Read Control = Normal  
(black bar color / white space color)



1D Inverse Read Control = Inverse  
(white bar color / black space color)



1D Inverse Read Control = Normal + Inverse  
(auto detect bar / space colors)

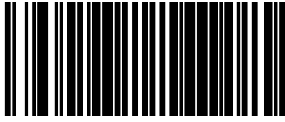

## 2D Inverse Read Control

This configuration item is used to toggle inverted label reading for 2D bar codes, for example, a label printed as white on black as opposed to black on white. Use the instructions for 1D Inverse Read Control above.



★ 2D Inverse Read Control = Normal  
(black bar color / white space color)



2D Inverse Read Control = Inverse  
(white bar color / black space color)



2D Inverse Read Control = Normal + Inverse  
(auto detect bar / space colors)

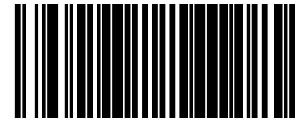

## LED AND BEEPER INDICATORS

### Power On Alert

Disables or enables the indication that the scanner has finished all its power up tests and is now ready for operation (usually a single beep).



Power-up Tone Control = No Tone



★ Power-up Tone Control = Play Tone



## Reading Illumination Duration

This feature specifies how long the illumination stays on after a label or label segment is read.

To set this feature:

1. Scan the Enter/Exit Programming Mode bar code.
2. Scan your selection from the bar codes below. You'll need to cover any unused bar codes on this and the facing page to ensure that the scanner reads only the bar code you intend to scan.
3. Complete the programming sequence by scanning the Enter/Exit Programming Mode bar code.



Reading Illumination Duration = 1 Seconds



Reading Illumination Duration = 3 Seconds



★ Reading Illumination Duration = 5 Seconds

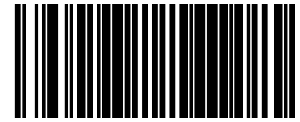

## Illumination During Disable Mode

This feature allows illumination to be turned off when the scanner is in “disable” mode. It determines if the imager illumination is controlled by host interface enable/disable commands.

**Disable** = Illumination is not controlled by host enable/disable commands, illumination stays on when disabled.

**Enable** = Illumination is controlled by host enable/disable commands, illumination is on when enabled and off when disabled.

To set this feature:

1. Scan the Enter/Exit Programming Mode bar code.
2. Scan your selection from the bar codes below.
3. Complete the programming sequence by scanning the Enter/Exit Programming Mode bar code.



Illumination During Disable Mode = Disable



★ Illumination During Disable Mode = Enable



## Object Sense Control

This feature determines whether the main illumination is controlled by the Object Sensing system, or alternatively, stays continuously on.

**Enable** = Illumination is controlled by using Object Sense

**Disable** = Normal illumination is used but it goes off during sleep mode / disable mode

To set this feature:

1. Scan the Enter/Exit Programming Mode bar code.
2. Scan your selection from the bar codes below. You'll need to cover any unused bar codes on this and the facing page to ensure that the scanner reads only the bar code you intend to scan.
3. Complete the programming sequence by scanning the Enter/Exit Programming Mode bar code.



★ Object Sense Control = Enable



Object Sense Control =Disable

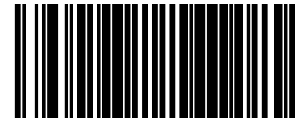

## External Read Indicator (ERI)



**NOTE: This feature is available only through use of a special cable.**



★ ERI Active State = Active Low



ERI Active State = Active High

## ERI Timeout

Specifies the amount of time the External Read Indicator (ERI) signal is held active for a good read. Sets the ERI timeout duration using hex values from 000 to 255 in increments of ten milliseconds (10ms or 0.01 seconds).

To configure this feature:

1. Scan the “Enter/Exit Programming Mode” bar code above to place the unit in Programming Mode.
2. Scan “Set ERI Timeout,” followed by the two digits (zero padded) from the [Alpha-Numeric Keypad in Appendix C](#) representing the desired time value.
3. Exit programming mode by scanning the “Enter/Exit Programming Mode” bar code again.

Default setting for this feature is:

★ 002 -20ms



Set ERI Timeout



## Good Read LED Idle State

This feature specifies the state of the green scanner LEDs when the scanner is idle and ready to read a label. Options are:

- Off
- On dim

To set the Scanner LEDs Idle State:

1. Scan the Enter/Exit Programming Mode bar code.
2. Scan your selection from the bar codes below. You'll need to cover any unused bar codes on this and the facing page to ensure that the scanner reads only the bar code you intend to scan.
3. Complete the programming sequence by scanning the Enter/Exit Programming Mode bar code.



Scanner LED Idle State = Off

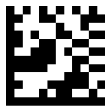

★ Scanner LED Idle State = On Dim



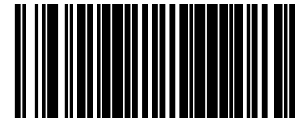

## Scanner Control Button Options

Configure the Scanner Control Button to one of the following modes of operation:

- Enable all functions: Volume, tone, diagnostics and reset.
- Enable only volume, tone and reset.
- Enable reset only.
- Disable all button functions

To set the desired Scanner Control Button Option:

1. Scan the Enter/Exit Programming Mode bar code.
2. Scan your selection from the bar codes below. You'll need to cover any unused bar codes on this and the facing page to ensure that the scanner reads only the bar code you intend to scan.
3. Complete the programming sequence by scanning the Enter/Exit Programming Mode bar code.



Scanner Control Button = Enable All Functions



★ Scanner Control Button = Enable Only Volume Tone and Reset



Scanner Control Button = Enable Reset Only



Scanner Control Button = Disable All Functions



## Good Read Beep Control

This feature enables/disables scanner beep upon successfully decoding of a label.

To set this feature:

1. Scan the Enter/Exit Programming Mode bar code.
2. Scan your selection from the bar codes below. You'll need to cover any unused bar codes on this and the facing page to ensure that the scanner reads only the bar code you intend to scan.
3. Complete the programming sequence by scanning the Enter/Exit Programming Mode bar code.



Good Read Beep Control = Disable



★ Good Read Beep Control = Enable

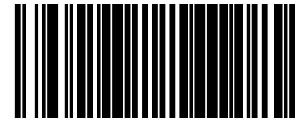

## Good Read Beep Frequency

Adjusts the scanner's good read beep to sound at low, medium, or high frequency (controls the beeper's pitch/tone).

- Low
- Medium
- High

To set this feature:

1. Scan the Enter/Exit Programming Mode bar code.
2. Scan your selection from the bar codes below. You'll need to cover any unused bar codes on this and the facing page to ensure that the scanner reads only the bar code you intend to scan.
3. Complete the programming sequence by scanning the Enter/Exit Programming Mode bar code.



Good Read Beep Frequency = Low



★ Good Read Beep Frequency = Medium



Good Read Beep Frequency = High



## Good Read Beep Length

Specifies the duration of a good read beep.

To set this feature:

1. Scan the Enter/Exit Programming Mode bar code.
2. Scan the bar code, [Set Good Read Beep Length](#). You'll need to cover any unused bar codes on this and the facing page to ensure that the scanner reads only the bar code you intend to scan.
3. Scan the appropriate digits from the [Alpha-Numeric Keypad in Appendix C](#) that represent the desired good read beep length setting. The selectable range is 1-255, which is the timeout in 10-millisecond increments. Times have a tolerance of +/- 25%. Pad all single and double digit numbers with leading zeroes to yield a three-digit entry (001-255).

Examples:

001 = 10ms

005 = 50ms

040 = 400ms

4. The scanner will automatically exit Programming Mode when the appropriate amount of digits have been scanned.

Default setting for this feature is:

★008 - 80ms



Set Good Read Beep Length

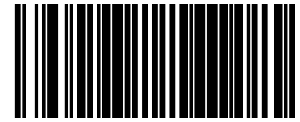

## Good Read Beep Volume

Selects the beeper volume upon a good read beep. There are five selectable volumes, with each volume increment adding approximately five decibels to the previous level:

- Low
- Medium Low
- Medium
- Medium High
- High

1. Scan the Enter/Exit Programming Mode bar code.
2. Scan your selection from the bar codes below. You'll need to cover any unused bar codes on this and the facing page to ensure that the scanner reads only the bar code you intend to scan.
3. Complete the programming sequence by scanning the Enter/Exit Programming Mode bar code.



Good Read Beep Volume = Low



Good Read Beep Volume = Medium Low



★ Good Read Beep Volume = Medium



Good Read Beep Volume = Medium High



Good Read Beep Volume = High



## Good Read When to Indicate

This feature specifies when the scanner will provide indication (beep and/or flash its green LEDs) upon successfully reading a bar code.

- Good Read = Indicate after decode.
- Good Read = Indicate after transmit.
- Good Read = Indicate after CTS goes inactive, then active.  
This mode applies to RS-232 STD and RS-232 WN interfaces only. If set in other interfaces, “Indicate after decode” mode will be implemented.
- Good Read = Indicate after each output structure proofed.  
When beeping after each output structure decoded, if there are multiple output structures, there is a delay after the beep has finished. This delay is equal to the [Good Read Beep Length](#).

To set the Good Read When to Indicate feature:

1. Scan the Enter/Exit Programming Mode bar code.
2. Scan the desired mode bar code from those provided below You’ll need to cover any unused bar codes on facing pages to ensure that the scanner reads only the bar code you intend to scan.
3. Scan the Enter/Exit Programming Mode bar code to complete.



★ Good Read When to Indicate = After Decode



Good Read When to Indicate = After Transmit



Good Read When to Indicate = After CTS goes Inactive,  
Then Active



Good Read When to Indicate = After Each Output  
Structure Proofed

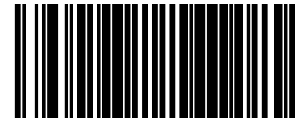

ENTER/EXIT PROGRAMMING MODE

## Illumination Blank on Beep

Enable this feature to turn off illumination while sound is playing.

To set this feature:

1. Scan the Enter/Exit Programming Mode barcode at the top of the page.
2. Scan your selection from the barcodes below.
3. Complete the programming sequence by scanning the Enter/Exit Programming Mode barcode.



★ Illumination Blank on Beep = Disable



Illumination Blank on Beep = Enable

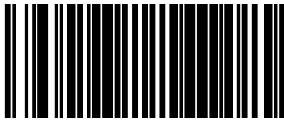

## Host Download to Handheld

Attached Datalogic handheld scanners can be updated via the host port. Contact Technical Support for details.

## Handheld Host Download Timeout

This feature sets the timeout (in seconds) to wait for a response from the handheld when performing a host download to the handheld.

To set this feature:

1. Scan the Enter/Exit Programming Mode bar code.
2. Scan the bar code below, Set Handheld HDL Timeout. You'll need to cover any unused bar codes on this and the facing page to ensure that the scanner reads only the bar code you intend to scan.
3. Scan the appropriate digits from the [Alpha-Numeric Keypad in Appendix C](#) that represent the desired delay. The selectable range is 001-255, which is the delay in 1-second increments. Pad all single and double digit numbers with leading zeroes to yield a three-digit entry (001-255).
4. Complete the programming sequence by scanning the Enter/Exit Programming Mode bar code.

Examples:

002 = 2 seconds

005 = 5 seconds

015 = 15 seconds

★ Default setting for this feature is: 15 seconds



Set Handheld HDL Timeout



# CONFIGURATION | IMAGING FEATURES

SECTION CONTENTS	
<b>IMAGING FEATURES</b>	starting on page 40
<ul style="list-style-type: none"><li>•Image Capture to the Host by Host Command</li><li>•Image Capture to the Host by Camera Button<ul style="list-style-type: none"><li>- Camera Button Mode</li><li>- Image Destination</li></ul></li><li>•Picture Retrieval Timeout</li><li>•Image Capture Delay</li><li>•Image Format</li><li>•Image Size</li><li>•Image Brightness</li><li>•Image Contrast</li><li>•Image Compression</li><li>•Region of Interest (ROI)</li></ul>	
<b>CELL PHONE SETTINGS</b>	starting on page 55
<ul style="list-style-type: none"><li>•Cell Phone Mode</li><li>•Cell Mode Percent</li></ul>	

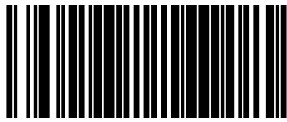

## IMAGING FEATURES

### Image Capture to the Host by Host Command

This feature is only available for RS-232 and USB COM interfaces.



**NOTE: If the USB COM interface has been selected, follow the instructions in USB-COM Interface Setup.**

The host command format is as follows:

P<cnt>pSBC

where:

**P** - ASCII 'P' used as preamble of pass-through commands

**<cnt>** - binary value of 4 indicating 4 bytes to follow

**p** - ASCII lowercase 'p'; command to take a picture

**S** - size value of image as ASCII character

'S' == uses scanner's configuration value

'0'-VGA, (640X480)

'1'-WVGA, (752X480)

'2'-SXGA, (1280x800)

'3'-CIF (320x240)

**B** - brightness value in ASCII

'B' == uses scanner's configuration value CI\_IMAGE\_BRIGHTNESS

else '0' thru'9' specifies brightness

**C** - contrast value in ASCII

'C' == uses scanner configuration value CI\_IMAGE\_CONTRAST

else '0' thru'9' specifies contrast

IF the image is of a type the scanner supports, capture and transmission occurs, and the command is of proper format

THEN

The scanner will transmit an ACK (0x06) to the Host in response to this command.

The image data transmission starts with a 4 byte binary field representing (Big Endian) number of bytes to follow.

If the "number of bytes to follow" value is zero, there was a problem with generating the image and the request should be retried.

ELSE

The scanner will transmit a BEL (0x07) to the Host in response to this command.

ENDIF

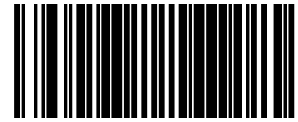

## Image Capture to the Host by Camera Button

Perform the following steps to set up the Camera Button.

1. Set the Camera Button Mode to enabled.
2. Set the Image Capture destination to host port.
3. Press the camera button.

Scanner will beep for a few seconds, then take picture and send the Image Retrieval Event label to the POS to indicate image is ready. The data content of the event label is:

**A856102000239**

The POS sends the picture retrieval command to initiate picture download from the scanner. Format of the command is:

**P\x02pG**

The scanner sends the picture to the POS with the transmission format described in the previous section, "Image Capture By Host Command".

### Camera Button Mode

This feature enables or disables the camera button.



★ Camera Button Mode = Disabled



Camera Button Mode = Enable

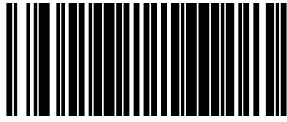

## Image Destination

Specifies the destination for pictures/images taken with a camera button press.



★ Image Destination = Disable

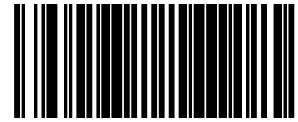

Image Destination = SD card<sup>a</sup>



Image Destination = Host port

- a. Contact Customer Service for more information on using this feature.



## Picture Retrieval Timeout

This feature sets the amount of time after the picture retrieval label is sent to the POS that the scanner will allow subsequent picture taking requests via button press.



**NOTE: If set to 0, the picture retrieval timeout will not be used and a picture will remain accessible until another is taken or the scanner is reset.**



Picture Retrieval Timeout = 0



Picture Retrieval Timeout = 1 second



Picture Retrieval Timeout = 2 seconds



Picture Retrieval Timeout = 3 seconds



Picture Retrieval Timeout = 4 seconds



★ Picture Retrieval Timeout = 5 seconds



Picture Retrieval Timeout = 6 seconds

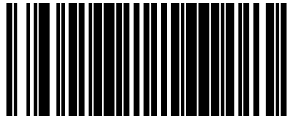

## Picture Retrieval Timeout (continued)



Picture Retrieval Timeout = 7 seconds



Picture Retrieval Timeout = 8 seconds



Picture Retrieval Timeout = 9 seconds



Picture Retrieval Timeout = 10 seconds

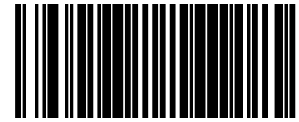

## Image Capture Delay

This feature specifies the amount of time after the image capture is initiated by a button press until the picture is taken.

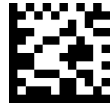

Image Capture Delay = 0 seconds



Image Capture Delay = 1 second



Image Capture Delay = 2 seconds



★ Image Capture Delay = 5 seconds



Image Capture Delay = 10 seconds

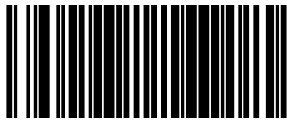

## Image Format

This feature specifies the output format for images taken using the camera function of the scanner.

Choices are:

- JPG
- BMP



★ Image Format = JPG



Image Format = BMP



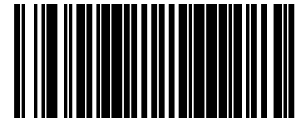

## Image Size

This feature specifies the size of the captured image. Choices are:

**VGA :** Video Graphics Array, 640 x 480 pixels, cropped.

**WVGA:** Wide Video Graphics Array, 752 x 480 pixels, cropped.

**Full Size:** 1280 x 800 pixels, full image.

**QVGA:** 320 x 240 pixels, cropped.

**Scaled VGA:** Video Graphics Array, 640 x 480 pixels, scaled.

**ROI:** The size of an ROI image is determined by the value of the ROI setting. See "[Region of Interest \(ROI\)](#)" on page 53.



★ Image Size = VGA



Image Size = WVGA



Image Size = Full Size



Image Size = QVGA



Image Size = Scaled VGA



Image Size = ROI

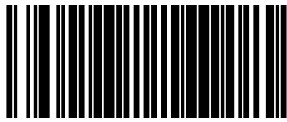

## Image Brightness

Specifies the image brightness value. The selectable range is from 0 to 10, with 10 being the brightest.



★ Image Brightness = 0



Image Brightness = 1



Image Brightness = 2



Image Brightness = 3



Image Brightness = 4



Image Brightness = 5



Image Brightness = 6



Image Brightness = 7

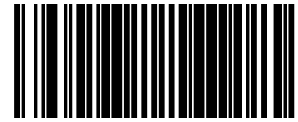

## Image Brightness — continued



Image Brightness = 8



Image Brightness = 9



Image Brightness = 10

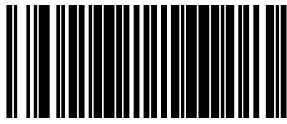

## Image Contrast

This feature sets the contrast level for a captured image. The selectable range is from 0 to 10, with 0 being the lowest and 10 being the highest contrast.



★ Image Contrast = 0



Image Contrast = 1



Image Contrast = 2



Image Contrast = 3



Image Contrast = 4



Image Contrast = 5



Image Contrast = 6



Image Contrast = 7

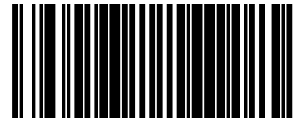

## Image Contrast — continued



Image Contrast = 8



Image Contrast = 9



Image Contrast = 10

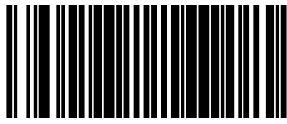

## Image Compression

Specifies the starting image compression factor.



Image Compression = 5



Image Compression = 10



Image Compression = 25



Image Compression = 50



Image Compression = 70



Image Compression = 80



Image Compression = 90



★ Image Compression = 100

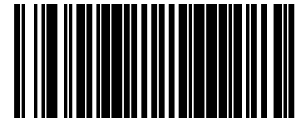

## Region of Interest (ROI)

This feature specifies the X-Y coordinates for the Region of Interest (ROI). The region of interest coordinates are defined as follows:

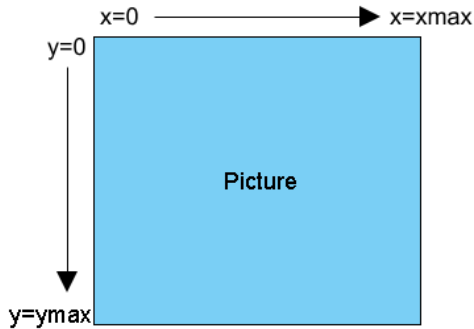

Where **xmax** is the x-size of a full size image (1279 pixels), and **ymin** is the y-size of a full size image (799 pixels).

For example, a coordinate set of 0, 639, 400, 799 will produce the bottom left section of a full size image.



**NOTE: Picture coordinates are NOT defined on a Cartesian coordinate plane.**

- Byte [0]-[1]: 16 bit hex value xmin
- Byte [2]-[3]: 16 bit hex value xmax
- Byte [4]-[5]: 16 bit hex value ymin
- Byte [6]-[7]: 16 bit hex value ymax



**NOTE: If the xmax/ymax values are configured larger than the maximum values above, they will default to 1 less than their respective maximum values.**

**If the xmin/ymin values are configured larger than xmax/ymax, they will default to 0.**

**Images extracted with ROI must be in JPG format.**

## Region of Interest (continued)



★ Region of Interest = default



Region of Interest = upper left quadrant

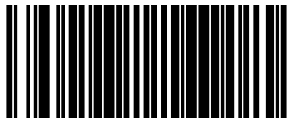

### Region of Interest (continued)



Region of Interest = upper right quadrant



Region of Interest = lower left quadrant



Region of Interest = lower right quadrant



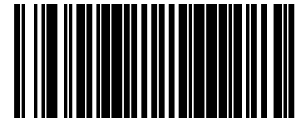

## CELL PHONE SETTINGS

### Cell Phone Mode

Enables/disables the operating mode for mobile phone read.

- In Toggle mode each host command toggles the mode.
- In Timer Expiration mode, a single host command enters Cell Phone mode but it is exited at timer expiration. The timer is not restarted on a label read.
- In Always On mode, the scanner stays on regardless of host command or button push. It will not enter sleep mode.



Cell Phone Mode = Toggle

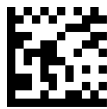

Cell Phone Mode = Timer Expiration



★ Cell Phone Mode = Always On

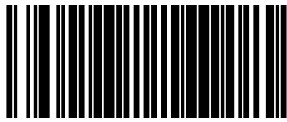

## Cell Mode Percent

Specifies the rate of frames dedicated to reading cell phones. Cell reading feature must be enabled for this to be active. The setting reflects a variable setting (or percentage) of frames dedicated to cell reading.



**NOTE: As the percentage is increased, object sense (if enabled) will become less responsive. Anything above 10% will have a negative impact on scanning performance.**



Cell Mode Percent = 5% (Very Low)



★ Cell Mode Percent = 10% (Low)



Cell Mode Percent = 20% (Medium)



Cell Mode Percent = 30% (Medium High)



Cell Mode Percent = 50% (High)

# CONFIGURATION | INTERFACE RELATED FEATURES

SECTION CONTENTS	
<b>INTERFACE SELECTION</b> starting on page 58	
<ul style="list-style-type: none"> <li>•USB-COM Interface Setup</li> <li>•RS-232 Interface Selection</li> </ul>	<ul style="list-style-type: none"> <li>•USB Interface Selection</li> <li>•Keyboard Interface Selection</li> </ul>
<b>INTERFACE FEATURES</b> starting on page 60	
<ul style="list-style-type: none"> <li>•Maximum Host-Transmitted Message Length</li> </ul>	<ul style="list-style-type: none"> <li>•Ignore Host Commands</li> </ul>
<b>RS-232 INTERFACE FEATURES</b> starting on page 62	
<ul style="list-style-type: none"> <li>•RS-232 Baud Rate</li> <li>•RS-232 Number of Data Bits</li> <li>•RS-232 Number of Stop Bits</li> <li>•RS-232 Parity</li> <li>•RS-232 Hardware Control</li> <li>•RS-232 Intercharacter Delay</li> <li>•RS-232 Software Flow Control</li> <li>•RS-232 Beep on ASCII BEL</li> </ul>	<ul style="list-style-type: none"> <li>•Beep on Not on File</li> <li>•RS-232 ACK NAK Features                             <ul style="list-style-type: none"> <li>- ACK NAK Enable</li> <li>- RS-232 ACK Character</li> <li>- RS-232 NAK Character</li> <li>- RS-232 Retry on ACK NAK Timeout</li> <li>- RS-232 ACK NAK Timeout Value</li> <li>- RS-232 ACK NAK Retry Count</li> <li>- RS-232 ACK NAK Error Handling</li> </ul> </li> <li>•RS-232 Indicate Transmission Failure</li> </ul>
<b>USB-COM INTERFACE FEATURES</b> starting on page 76	
<ul style="list-style-type: none"> <li>•USB-COM Interface Setup</li> </ul>	<ul style="list-style-type: none"> <li>•USB Power Compliance</li> </ul>
<b>USB-OEM INTERFACE FEATURES</b> starting on page 77	
<ul style="list-style-type: none"> <li>•USB OEM Scanner Device Type</li> </ul>	
<b>USB KEYBOARD FEATURES</b> starting on page 79	
<ul style="list-style-type: none"> <li>•Keyboard Layout</li> <li>•USB Keyboard Country Mode</li> <li>•USB Keyboard Caps Lock State</li> <li>•USB Keyboard Send Control Characters</li> </ul>	<ul style="list-style-type: none"> <li>•Quiet Interval</li> <li>•USB Keyboard Intercharacter Delay</li> <li>•USB Keyboard Additional Interface Options</li> </ul>

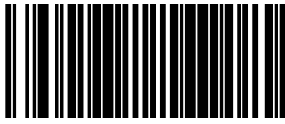

## INTERFACE SELECTION

### INTERFACE TYPE

Specifies the current scanner interface.



**NOTE:** The correct interface cable is generally included for the reader interface type you ordered.



**NOTE:** If the scanner's interface type must be changed, always be sure that interface configuration is the **FIRST** item scanned during a programming session. (Selecting an interface type resets **ALL** other configuration items to the factory default for that interface type.)



**CAUTION:** Great care should be taken to select the correct interface type, since you can cause damage to the scanner and/or POS terminal by attempting to change to an incompatible interface. **ALWAYS** make interface selections with the host cable **DISCONNECTED**.



**NOTE:** When an interface is selected, the scanner loads the configuration for that interface as the selection is made. Any custom configurations done in the previous interface will not be carried over to the configuration for the new interface.

### RS-232 Interface Selection

Remember to cover any unused bar codes on this and the facing page to ensure that the scanner reads only the bar code you intend to scan.



**CAUTION:** Great care should be taken to select the correct interface type, since you can cause damage to the scanner and/or POS terminal by attempting to change to an incompatible interface. **ALWAYS** make interface selections with the host cable **DISCONNECTED**.



Interface Type = RS-232 Standard



Interface Type = RS-232 Wincor-Nixdorf

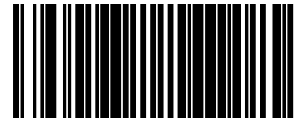

## USB Interface Selection

Remember to cover any unused bar codes on this and the facing page to ensure that the scanner reads only the bar code you intend to scan.



**CAUTION: Great care should be taken to select the correct interface type, since you can cause damage to the scanner and/or POS terminal by attempting to change to an incompatible interface. ALWAYS make interface selections with the host cable DISCONNECTED.**



Interface Type = USB OEM



Interface Type = USB TEC



Interface Type = USB COM

## Keyboard Interface Selection

Remember to cover any unused bar codes on this and the facing page to ensure that the scanner reads only the bar code you intend to scan.



**CAUTION: Great care should be taken to select the correct interface type, since you can cause damage to the scanner and/or POS terminal by attempting to change to an incompatible interface. ALWAYS make interface selections with the host cable DISCONNECTED.**



Interface Type = USB Keyboard

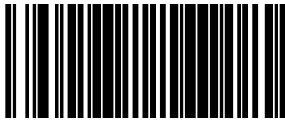

## INTERFACE FEATURES

### Maximum Host-Transmitted Message Length

Specifies the maximum number of data characters allowed in messages transmitted to the host.

To set the Maximum Host-Transmitted Message Length:

1. Scan the Enter/Exit Programming Mode bar code.
2. Scan the bar code, [Set Maximum Host-Transmitted Message Length](#) below. You'll need to cover any unused bar codes on this and the facing page to ensure that the scanner reads only the bar code you intend to scan.
3. Scan the appropriate digits from [Appendix C, Alpha-Numeric Keypad](#) that represent the desired maximum host-transmitted message length. The selectable range is 0-249 data characters. (Labels that are longer than this length are not read.) Pad all single and double digit numbers with leading zeroes to yield a three-digit entry (000-249).



**NOTE: If this configuration item is set to 0 (000), there is no general length limit imposed on data being transmitted to the host.**

4. The scanner will automatically exit Programming Mode when the appropriate amount of digits have been scanned.

Default setting for this feature is:

★ 000 - No general limit imposed

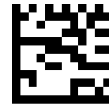

Set Maximum Host-Transmitted Message Length

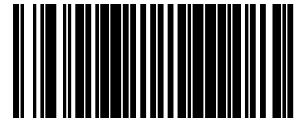

## Ignore Host Commands

When set to ignore host commands, the scanner will ignore all host commands except the minimum set necessary to keep the interface active and transmit labels. For normal operation of the interface, select Obey Host Commands.



★ Ignore Host Commands = Don't Ignore



Ignore Host Commands = Ignore

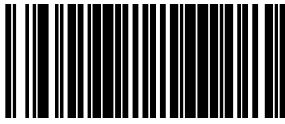

## RS-232 INTERFACE FEATURES



**NOTE: A setting of no parity with 7 data bits is invalid and will default to 8 data bits and no parity.**

### RS-232 Baud Rate



RS-232 Baud Rate = 1200



RS-232 Baud Rate = 2400



RS-232 Baud Rate = 4800



★ RS-232 Baud Rate = 9600



RS-232 Baud Rate = 19200



RS-232 Baud Rate = 38400



RS-232 Baud Rate = 57600



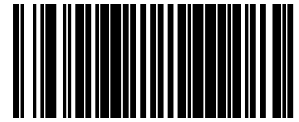

## RS-232 Baud Rate (continued)



RS-232 Baud Rate = 115200



RS-232 Baud Rate = 230400

## RS-232 Number of Data Bits

Specifies number of data bits required for sending and receiving data..



**NOTE: A setting of 7 data bits with no parity will default to 8 data bits and no parity.**



RS-232 Number of Data Bits = 7



★RS-232 Number of Data Bits = 8

## RS-232 Number of Stop Bits

Specifies number of stop bits required for sending and receiving data



★RS-232 Number of Stop Bits = 1



RS-232 Number of Stop Bits = 2

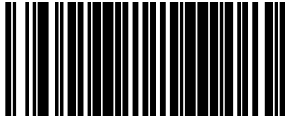

## RS-232 Parity

Specifies parity required for sending and receiving data.

Options for this setting are:

- RS-232 PARITY = NONE
- RS-232 PARITY = EVEN
- RS-232 PARITY = ODD.



**NOTE: A setting of no parity with 7 data bits will default to 8 data bits and no parity.**



★ RS-232 Parity = None



RS-232 Parity = Even



RS-232 Parity = Odd

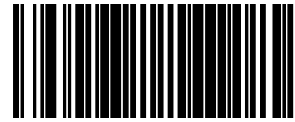

## RS-232 Hardware Control

Enables/disables use of the RS-232 CTS signal for flow control and/or scan control.

Options are:

- Disable — The scanner transmits to the host regardless of any activity on the CTS line.
- Enable CTS Flow Control — The CTS signal controls transmission of data to the host.
- Enable CTS Scan Control — The CTS line must be active for scanner to read and transmit data. While the CTS line is inactive, scanner remains in a host- disabled state; following a successful label transmission, the CTS signal must transition to inactive and then to active to enable scanning for the next label.
- Enable Magellan SL CTS Scan Control — Follows the same hardware protocol as older Magellan SL scanners.



★ RS-232 Hardware Control = Disable



RS-232 Hardware Control = Enable CTS Flow Control



RS-232 Parity = Enable CTS Scan Control



RS-232 Hardware Control = Enable MGL SL CTS Scan Control

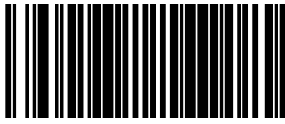

## RS-232 Intercharacter Delay

Specifies delay between the end of one character and the beginning of the next in 10-millisecond increments. This delay is inserted after each data character transmitted. If the transmission speed is too high, the system may not be able to receive all characters. You may need to adjust the delay to make the system work properly.

To set the RS-232 Intercharacter Delay:

1. Scan the Enter/Exit Programming Mode bar code.
2. Scan the bar code below, [Set RS-232 Intercharacter Delay](#).
3. Scan the appropriate digits from the [Alpha-Numeric Keypad in Appendix C](#) that represent the desired delay. The selectable range is 0-100, which is the delay in 10-millisecond increments. Pad all single and double digit numbers with leading zeroes to yield a three-digit entry (000-100).

Examples:

001 = 10ms

005 = 50ms

040 = 400ms

100 = 1,000ms (1 second)

4. The scanner will automatically exit Programming Mode when the appropriate amount of digits have been scanned.

Default setting for this feature is:

★ 00 - No Intercharacter Delay



Set RS-232 Intercharacter Delay

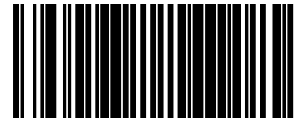

## RS-232 Software Flow Control

Enables/disables RS-232 Flow Control using XON/ XOFF characters.



**NOTE: This item will be ignored when the feature, RS-232 NAK Character, is enabled**

To set this feature:

1. Scan the Enter/Exit Programming Mode bar code.
2. Scan either the enable or disable bar code below. You'll need to cover any unused bar codes on this and the facing page to ensure that the scanner reads only the bar code you intend to scan.
3. Complete the programming sequence by scanning the Enter/Exit Programming Mode bar code.



★RS-232 Software Flow Control= Disable



RS-232 Software Flow Control= Enable

## RS-232 Beep on ASCII BEL

Enables/disables ability of scanner to beep (sound a good read tone) on receiving an ASCII BEL (07 hex).



★RS-232 Beep on ASCII BEL = Disable



RS-232 Beep on ASCII BEL = Enable

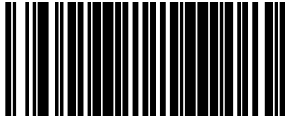

## Beep on Not on File

Select for the host to beep (or not) when a not-on-file condition is detected by the host.



RS-232 Beep on Not on File = Muted



★ RS-232 Beep on Not on File = Low Volume



RS-232 Beep on Not on File = Medium Volume



RS-232 Beep on Not on File = High Volume

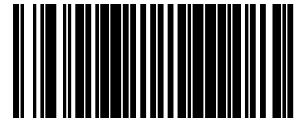

## RS-232 ACK NAK Features

### ACK NAK Enable

Enables/disables the ability of the scanner to support the RS-232 ACK/NAK protocol. When configured, the scanner and/or host sends an “ACK” when it receives data properly, and sends “NAK” when the data is in error. Selections are:

- Disable ACK NAK
- Enable for Label Transmission — the scanner expects an ACK/NAK response from the host when a label is sent)
- Enable for Host Acknowledgment — Enabled for Host Commands (the scanner will respond with ACK/NAK when the host sends a command)
- Enable for Label & Host — Enabled for both Label Transmission & Host Command acknowledgment.

To select the option for RS-232 ACK NAK Enable:

1. Scan the Enter/Exit Programming Mode bar code.
2. Scan the desired option from bar codes below and on the following page. You’ll need to cover any unused bar codes on this and the facing page to ensure that the scanner reads only the bar code you intend to scan.
3. Complete by scanning the Enter/Exit Programming Mode bar code.



★ RS-232 ACK NAK = Disable



RS-232 ACK NAK = Enable for Label Transmission



RS-232 ACK NAK = Enable for Host Acknowledgment



RS-232 ACK NAK = Enable for Label & Host

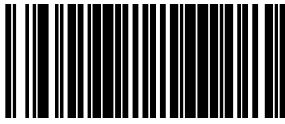

## RS-232 ACK Character

This feature specifies which ASCII character will be used as an ACK character.



**NOTE: DO NOT set this feature to use previously defined characters such as XON, XOFF or host commands as this will conflict with normal operation of these characters. 8-bit data is not recognized when the feature, RS-232 Number of Data Bits, is set to 7 data bits.**

To specify the RS-232 ACK Character:

1. Scan the Enter/Exit Programming Mode bar code.
2. Scan the bar code, SET RS-232 ACK Character below. You'll need to cover any unused bar codes on this and the facing page to ensure the scanner reads only the bar code you intend to scan.
3. Scan the appropriate digits from the [Alpha-Numeric Keypad in Appendix C](#) that represent the hex designation for the desired character. A table containing the ASCII Character Set and their corresponding Hex Values is available in the inside back cover of this manual. ASCII parameters must be input by scanning a pair of hexadecimal digits for the desired character. For example, if ASCII "A" were the desired ACK character, you would scan the digits "4", then "1" (the ASCII corresponding hex value).
4. The scanner will automatically exit Programming Mode when the appropriate amount of digits/characters have been scanned.

Default setting for this feature is:

★06



Set RS-232 ACK Character



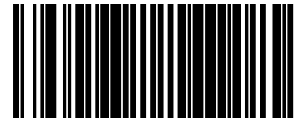

## RS-232 NAK Character

This feature specifies which ASCII character will be used as a NAK character.



**NOTE: DO NOT set this feature to use previously defined characters such as XON, XOFF or host commands as this will conflict with normal operation of these characters. 8-bit data is not recognized when the feature, RS-232 Number of Data Bits, is set to 7 data bits.**

To specify the RS-232 NAK Character:

1. Scan the Enter/Exit Programming Mode bar code.
2. Scan the bar code, SET RS-232 NAK Character below. You'll need to cover any unused bar codes on this and the facing page to ensure the scanner reads only the bar code you intend to scan.
3. Scan the appropriate digits from the [Alpha-Numeric Keypad in Appendix C](#) that represent the hex designation for the desired character. A table containing the ASCII Character Set and their corresponding Hex Values is available in the inside back cover of this manual. ASCII parameters must be input by scanning a pair of hexadecimal digits for the desired character. For example, if ASCII "A" were the desired NAK character, you would scan the digits "4", then "1" (the ASCII corresponding hex value).
4. The scanner will automatically exit Programming Mode when the appropriate amount of digits/characters have been scanned.

Default setting for this feature is:

★15



Set RS-232 NAK Character

## RS-232 Retry on ACK NAK Timeout

This option specifies the action scanner performs on expiration of the RS-232 ACK NAK Timeout Value.



RS-232 Retry on ACK NAK Timeout = Disable



★RS-232 Retry on ACK NAK Timeout = Enable

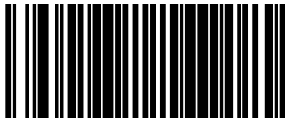

## RS-232 ACK NAK Timeout Value

This item specifies the time the scanner will wait for an ACK character from the host following a label transmission.

- 0 = Infinite timeout
- 1 - 75 = Timeout in 200-millisecond increments

To set the ACK NAK Timeout Value:

1. Scan the Enter/Exit Programming Mode bar code.
2. Scan the bar code below, [Set RS-232 ACK NAK Timeout Value](#). You'll need to cover any unused bar codes on this and the facing page to ensure that the scanner reads only the bar code you intend to scan.
3. Scan the appropriate digits from the [Alpha-Numeric Keypad in Appendix C](#) that represent the desired timeout. A setting of 0 specifies an infinite timeout. The remaining selectable range is 1-75, which is the timeout in 200-millisecond increments. Pad all single digit numbers with a leading zero to yield a two-digit entry (00-75).

Examples:

00 = Infinite timeout

01 = 200ms

05 = 1,000ms (1 second)

40 = 8,000ms (8 seconds)

75 = 15,000ms (15 seconds)

The scanner will automatically exit Programming Mode when the appropriate amount of digits have been scanned.

Default setting for this feature is:

★ 01 - 200ms



Set RS-232 ACK NAK Timeout Value

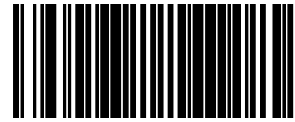

## RS-232 ACK NAK Retry Count

This feature sets the number of times for the scanner to retry a label transmission under a retry condition.

To set the RS-232 ACK NAK Retry Count:

1. Scan the Enter/Exit Programming Mode bar code.
2. Scan the bar code, [Set RS-232 ACK NAK Retry Count](#) below. You'll need to cover any unused bar codes on this and the facing page to ensure that the scanner reads only the bar code you intend to scan.
3. Scan the appropriate digits from the [Alpha-Numeric Keypad in Appendix C](#) that represent the desired number. The selectable range is 000-255 resets. Pad all single and double digit numbers with leading zeroes to yield a three-digit entry (000-255).



**NOTE: A setting of 255 specifies "retry forever."**

4. The scanner will automatically exit Programming Mode when the appropriate amount of digits have been scanned.

Default setting for this feature is:

★003 - Three retrys



Set RS-232 ACK NAK Retry Count

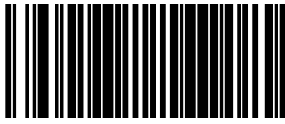

## RS-232 ACK NAK Error Handling

This item specifies the method the scanner will use to handle errors detected while waiting to receive the ACK character from the host. Errors include unrecognized host commands and communication errors such as parity or framing errors.

- Ignore Errors (recommended setting)
- Assume ACK (risk of lost label data)
- Assume NAK (risk of duplicate label)



★ RS-232 ACK NAK Error Handling = Ignore Errors



RS-232 ACK NAK Error Handling = Assume ACK

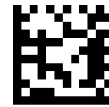

RS-232 ACK NAK Error Handling = Assume NAK

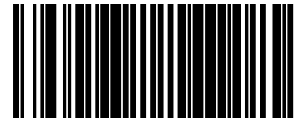

## RS-232 Indicate Transmission Failure

This feature enables / disables the ability of the scanner to sound a bad label beep indication when a transmission failure occurs.

To set this feature:

1. Scan the Enter/Exit Programming Mode bar code.
2. Scan the desired option from the bar codes below. You'll need to cover any unused bar codes on this and the facing page to ensure that the scanner reads only the bar code you intend to scan.
3. Complete the programming sequence by scanning the Enter/Exit Programming Mode bar code.



RS-232 Indicate Transmission Failure = Disable



★ RS-232 Indicate Transmission Failure = Enable

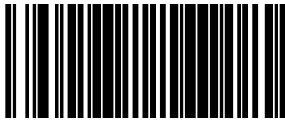

## USB-COM INTERFACE FEATURES

### USB-COM Interface Setup

Before plugging your scanner into the Host PC, please ensure you have already copied the executable DLS USB-COM driver file to your PC and that the scanner's interface is set to USB COM. The DLS USB-COM driver (for Windows operating systems) is provided by Datalogic or downloaded from the Datalogic website.

1. Execute the DLS USB-COM driver file.
2. When the scanner is first plugged into the PC, Windows will bring up the "Found New Hardware" message.
3. The installation is complete.



**NOTE: Contact your Datalogic Representative for information about USB-COM operation with other major PC operating systems.**

### USB Power Compliance

This feature enables / disables the ability of the Universal Interface to hold off system controller power until after USB POS Host enumeration.

To set this feature:

1. Scan the Enter/Exit Programming Mode barcode at the top of the page.
2. Scan the desired option from the barcodes below. Cover unused barcodes on this and the facing page to ensure that the scanner reads only the barcode you intend to scan.
3. Complete by scanning the Enter/Exit Programming Mode barcode.



USB Power Compliance = Disable



★ USB Power Compliance = Enable

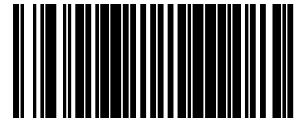

## USB-OEM INTERFACE FEATURES

### USB OEM Scanner Device Type

The OEM-USB protocol allows for the scanner to be identified as one of two different types of bar code scanners. Depending on what other scanners you may already have connected to a USB POS, you may need to change this setting to enable all scanners to communicate. Options are:

- Table Top Scanner
- Handheld Scanner

To set this feature:

1. Scan the Enter/Exit Programming Mode bar code.
2. Scan your selection from the bar codes below. You'll need to cover any unused bar codes on this and the facing page to ensure that the scanner reads only the bar code you intend to scan.
3. Complete the programming sequence by scanning the Enter/Exit Programming Mode bar code.



★ USB OEM Scanner Device Type = Table Top Scanner



USB OEM Scanner Device Type = Handheld Scanner

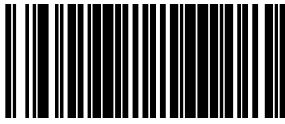

## USB OEM Additional Interface Options

To set this feature:

1. Scan the Enter/Exit Programming Mode bar code.
2. Scan your selection from the bar codes below. You'll need to cover any unused bar codes on this and the facing page to ensure that the scanner reads only the bar code you intend to scan.

Complete the programming sequence by scanning the Enter/Exit Programming Mode bar code



USB OEM Interfaces Option2 =  
Enable scanner at first enumeration after BusReset



★ USB OEM Interfaces Option2 =  
Disable scanner at first enumeration after BusReset



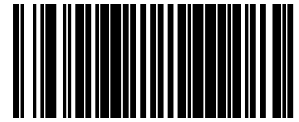

## USB KEYBOARD FEATURES

As a keyboard interface, the scanner supports most popular PC terminals.

### Keyboard Layout

The Keyboard Layout option supports many countries. For details about Keyboard Layout, please refer to your operating system manual.

### USB Keyboard Country Mode

This feature specifies the country/language that will be supported by the keyboard.



★ USB Keyboard Country Mode = USA



USB Keyboard Country Mode = Belgium



USB Keyboard Country Mode = Britain



USB Keyboard Country Mode = Denmark



USB Keyboard Country Mode = France



USB Keyboard Country Mode = Germany



USB Keyboard Country Mode = Italy

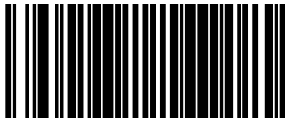

### USB Keyboard Country Mode (continued)



USB Keyboard Country Mode =  
Norway



USB Keyboard Country Mode =  
Portugal

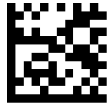

USB Keyboard Country Mode = Spain



USB Keyboard Country Mode =  
Sweden



USB Keyboard Country Mode =  
Switzerland



USB Keyboard Country Mode =  
Japanese 106-key



USB Keyboard Country Mode = Hungary



USB Keyboard Country Mode =  
Czech Republic



USB Keyboard Country Mode = Slovakia

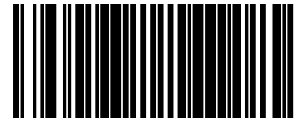

## USB Keyboard Country Mode (continued)



USB Keyboard Country Mode =  
Romania

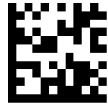

USB Keyboard Country Mode =  
Croatia



USB Keyboard Country Mode = Poland



USB Keyboard Country Mode =  
French Canadian



USB Keyboard Country Mode = Turkish

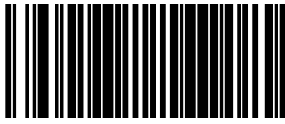

## USB Keyboard Caps Lock State

This feature specifies the format in which the scanner sends character data. Selections are:

**Caps Lock OFF:** Send character data in normal format

**Caps Lock ON:** Send character data in reverse case

**Shift Lock Mode:** This setting results in a Caps Lock OFF functionality.

**Caps Lock Compensation Mode:** This only applies to USB Keyboard. For other interfaces, this setting results in a Caps Lock OFF functionality.

1. Scan the Enter/Exit Programming Mode bar code.
2. Scan the desired selection from the bar codes below. You'll need to cover any unused bar codes on this and the facing page to ensure that the scanner reads only the bar code you intend to scan.
3. Complete by scanning the Enter/Exit Programming Mode bar code.

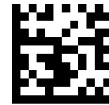

★ USB Keyboard Caps Lock State =  
Caps Lock OFF



USB Keyboard Caps Lock State =  
Caps Lock ON



USB Keyboard Caps Lock State =  
Shift Lock Mode



USB Keyboard Caps Lock State =  
Caps Lock Compensation

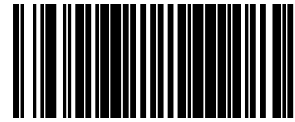

## USB Keyboard Send Control Characters

This feature specifies how the scanner transmits ASCII control characters to the host.



**NOTE: Affects suffix and prefix characters. When disabled, only ASCII characters between 20H and 127H inclusive (space... delete) plus special characters 0DH (carriage return), 08H (backspace), 27H (ESC), 09H (right tab) and 0BH (left tab) are transmitted.**

Choices are:

**Disable:** No control characters are sent to the host.

**Enable transmission of control characters to host:** Control characters are sent to the host.

**Send characters between 00H and 1FH:** Send characters between 00H and 1FH according to special function-key mapping table (This is used to send keys that are not in normal ASCII set; a unique set is provided for each available scancode set).

1. Scan the Enter/Exit Programming Mode bar code.
2. Scan the bar code for the desired setting below. You'll need to cover any unused bar codes on this and the facing page to ensure that the scanner reads only the bar code you intend to scan.
3. Complete by scanning the Enter/Exit Programming Mode bar code.



★ Keyboard Send Control Characters = Disable



Keyboard Send Control Characters =  
Enable transmission of control characters to host



USB Keyboard No Keyboard Support =  
Send characters between 00H and 1FH

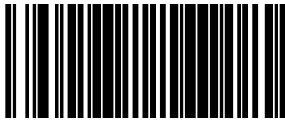

## Quiet Interval

This setting specifies the amount of time to monitor for keyboard activity before breaking the keyboard connection.

To set this feature:

1. Scan the Enter/Exit Programming Mode bar code.
2. Scan the bar code below, [Set Quiet Interval](#). You'll need to cover any unused bar codes on this and the facing page to ensure that the scanner reads only the bar code you intend to scan.
3. Scan the appropriate digits from the [Alpha-Numeric Keypad in Appendix C](#) that represent the desired time interval. The selectable range is 001-100, which is the interval in 10-millisecond increments. Pad all single and double digit numbers with leading zeroes to yield a three-digit entry (001-100).

Examples:

001 = 10ms

005 = 50ms

040 = 400ms

100 = 1,000ms (1 second)

4. The scanner will automatically exit Programming Mode when the appropriate amount of digits have been scanned.

Default setting for this feature is:

★00A - 100ms



Set Quiet Interval

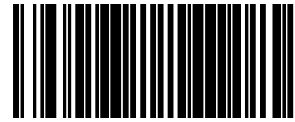

## USB Keyboard Intercharacter Delay

Specifies a time delay between characters.

To set this feature:

1. Scan the Set USB Keyboard Intercharacter Delay bar code below.
2. Scan the appropriate characters/digits from the [Alpha-Numeric Keypad in Appendix C](#) that represent the desired delay. The selectable range for this option is any decimal value from 00 (no delay) to 99 in 10 ms increments. A table containing the ASCII Character Set and their corresponding decimal values is available in the inside back cover of this manual. ASCII parameters must be input by scanning decimal digits for each character. Pad all single digit numbers with leading zero to yield a two-digit entry (00-99). Thus, to set an intercharacter delay of 70ms, bar codes containing the digits '0' and '7' must be scanned.
3. Complete the programming sequence by scanning the Enter/Exit Programming Mode bar code.

★ Default setting for this feature is: 01 (10ms)



Set USB Keyboard Intercharacter Delay

## USB Keyboard Additional Interface Options

See "[Keyboard Function Key Mappings](#)" on page 277 for more information.

To set this feature:

1. Scan the Enter/Exit Programming Mode bar code.
2. Scan your selection from the bar codes below. You'll need to cover any unused bar codes on this and the facing page to ensure that the scanner reads only the bar code you intend to scan.
3. Complete the programming sequence by scanning the Enter/Exit Programming Mode bar code.



USB Keyboard Interface Option 1 =  
Use Rev C function table



★ USB Keyboard Interfaces Option 2 =  
Use Rev D function table

# CONFIGURATION | DATA EDITING

SECTION CONTENTS
<b>DATA EDITING OVERVIEW</b> starting on page 87
<b>GLOBAL PREFIX/SUFFIX</b> starting on page 88 <ul style="list-style-type: none"><li>• Global Prefix</li><li>• Global Suffix</li></ul>
<b>AIM ID</b> starting on page 90
<b>LABEL ID</b> starting on page 91 <ul style="list-style-type: none"><li>• Label ID Control</li><li>• Setting Label ID</li><li>• 1D Symbologies</li><li>• 2D Symbologies</li></ul>
<b>CASE CONVERSION</b> starting on page 100
<b>CHARACTER CONVERSION</b> starting on page 101



## DATA EDITING OVERVIEW

When a bar code is scanned, additional information can be sent to the host computer along with the bar code data. This combination of bar code data and supplementary user-defined data is called a “message string.” The features in this chapter can be used to build specific user-defined data into a message string.

There are several types of selectable data characters that can be sent before and after scanned data. You can specify if they should be sent with all symbologies, or only with specific symbologies. The figure below shows the available elements you can add to a message string:

### Breakdown of a Message String

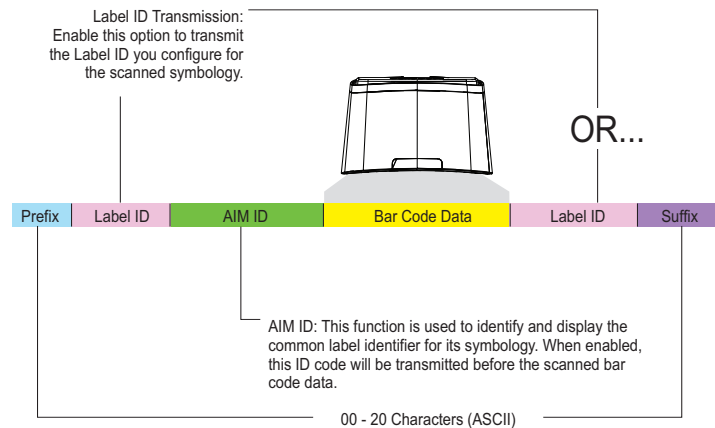

### Please Keep In Mind...

- Modifying a message string is not a mandatory requirement. Data editing is a sophisticated feature allowing highly customizable output for advanced users. Factory default settings for data editing is typically set to NONE.
- A prefix or suffix may be applied (reference the [1D Symbology Programming](#) chapter for these settings) or across all symbologies (set via the Global features in this chapter).
- You can add any character from the [ASCII Character Set](#) (from 00-FF) on the inside back cover of this manual as a prefix, suffix or Label ID.
- Enter prefixes and suffixes in the order in which you want them to appear on the output.

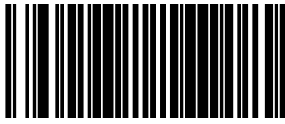

## GLOBAL PREFIX/SUFFIX

### Global Prefix

This feature applies to RS-232 (Standard or Wincor-Nixdorf), USB-COM, USB-TEC, and USB Keyboard interfaces. It specifies the prefix that is added to the beginning of label transmission.

1. Scan the Enter/Exit Programming Mode bar code.
2. Scan the bar code Set Global Prefix below. Cover any unused bar codes to ensure the scanner reads only the bar code you intend to scan.
3. Scan the appropriate characters/digits from the [Alpha-Numeric Keypad](#) that represent the hex designation for the desired character(s). The ASCII Character Set and their corresponding Hex Values are shown on the inside back cover of this manual. ASCII parameters must be input by scanning a pair of hexadecimal digits for each character. Thus, to set a two-character value of AB, bar codes containing the digits 4 1 4 2 must be scanned. The selectable range for this option is any hex value from 00 to FF. Up to 20 hex pairs can be designated.



**NOTE: To specify “No Global Prefix,” scan 00.**

4. If designating the full 20 hex pairs, the scanner will exit Programming Mode when the appropriate amount of digits have been scanned. If designating less than 20 hex pairs, you can end the programming sequence early by scanning the Terminate Sequence bar code.
5. Complete by scanning the Enter/Exit Programming Mode bar code.



Set Global Prefix



Terminate Sequence

Default setting for this feature is:

★00 - No Global Prefix

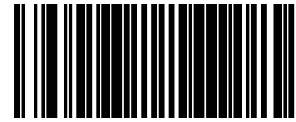

## Global Suffix

This feature applies to RS-232 (Standard or Wincor-Nixdorf), USB-COM, USB-TEC, and USB Keyboard interfaces. It specifies the suffix that is added to end of a label transmission. Three standard options are available below. Contact your dealer for other alternate settings for this feature.

- No Global Suffix
- CR — Carriage Return
- CR LF — Carriage Return, Line Feed

To set the Global Suffix:

1. Scan the Enter/Exit Programming Mode bar code.
2. Scan your selection from the bar codes below.
3. Complete the programming sequence by scanning the Enter/Exit Programming Mode bar code.



Global Suffix = No Global Suffix



★ Global Suffix = CR



Global Suffix = CR LF

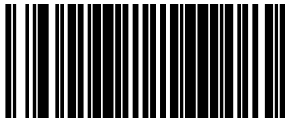

## AIM ID

AIM (Automatic Identification Manufacturers) label identifiers are assigned from a globally standardized list — as opposed to custom label ID characters you select yourself — and can be included with scanned bar code data. AIM label identifiers consist of three characters as follows:

- A close brace character (ASCII '['), followed by...
- A code character (see the table below), followed by...
- A modifier character (the modifier character is symbol dependent)

SYMBOLGY	CHAR	SYMBOLGY	CHAR	SYMBOLGY	CHAR
UPC/EAN	E	GS1 Omnidirectional, GS1 Expanded	e	QR Code and Micro QR	Q
Code 39	A	Standard 2 of 5	S	Aztec	z
Codabar	F	ISBN	X <sup>a</sup>	DotCode	J
Interleaved 2 of 5	I	Datamatrix	d	OCR and MICR	o
Code 93	G	PDF417 and MicroPDF	L	Digimarc	+
Code 128/EAN 128	C	MSI Plessey	M	Han Xin (China Sensible) Code	X <sup>a</sup>

a. ISBN (X with a 0 modifier character). X is used for all unknown label types.

### AIM ID

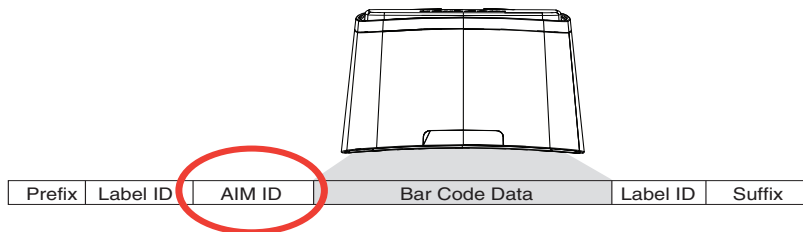

★ Global AIM ID = Disable



Global AIM ID = Enable

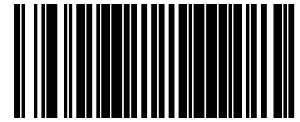

## LABEL ID

### Label ID Control

This feature specifies whether Label IDs are transmitted to the host and whether to attach them as a prefix or suffix. See "Label ID" on page 257 for more information.

Choices are:

- Disable
- Enable as a Prefix
- Enable as a Suffix

### Label ID Position Options

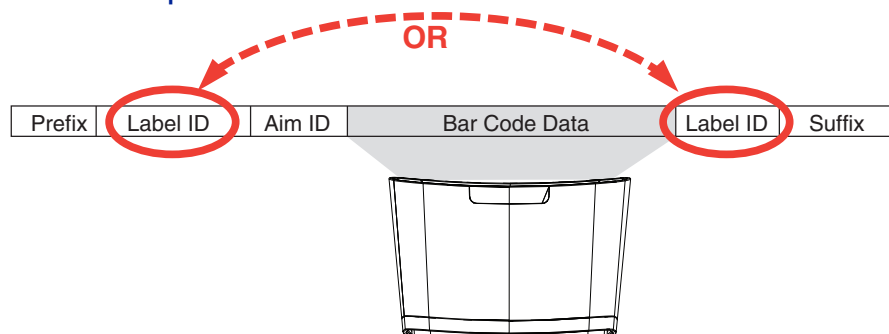

1. Scan the Enter/Exit Programming Mode bar code.
2. Scan the desired option from the bar codes below. You'll need to cover any unused bar codes on this and the facing page to ensure that the scanner reads only the bar code you intend to scan.
3. Complete by scanning the Enter/Exit Programming Mode bar code again.



Label ID Control = Disable



Label ID Control = Enable as a Prefix



Label ID Control = Enable as a Suffix

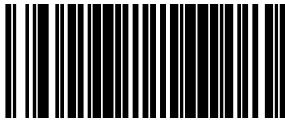

## Setting Label ID





This feature allows the setting of custom Label ID character(s) for each available symbology type if other than the default Label ID is desired.

To set this feature:

1. Scan the Enter/Exit Programming Mode bar code.
2. Scan the bar code for the desired symbology below. You'll need to cover any unused bar codes on this and the facing page to ensure the scanner reads only the bar code you intend to scan.
3. Scan the appropriate digits from the [Alpha-Numeric Keypad](#) that represent the desired Label ID characters; entered as two hex pairs. A table containing the ASCII Character Set and their corresponding Hex Values is available in the inside back cover of this manual. ASCII parameters must be input by scanning a pair of hexadecimal digits for each character. Thus, to set a two-character value of AB, bar codes containing the digits '4', '1', '4', and '2' must be scanned. The selectable range for this option is any hex value from 00 to FF.

Complete the programming sequence by scanning the Enter/Exit Programming Mode bar code.

### 1D Symbologies

LABEL ID — 1D SYMBOLOGIES	
Default Label ID for this symbology is: 41 = A	 Set UPC-A Label ID
 UPCA Composite Label ID	Default Label ID for this symbology is: 41 = A
Default Label ID for this symbology is: 41 = A	 Set UPC-A 2-Digit Supplemental Label ID
 Set UPC-A 5-Digit Supplemental Label ID	Default Label ID for this symbology is: 41 = A
Default Label ID for this symbology is: 45 = E	 Set UPC-E Label ID

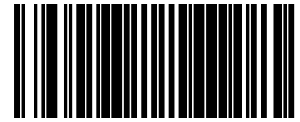
**LABEL ID — 1D SYMBOLOGIES (CONTINUED)**

UPC-E Composite Label ID

Default Label ID for this symbology is:

45 = E

Default Label ID for this symbology is:

45 = E



Set UPC-E 2-Digit Supplemental Label ID



Set UPC-E 5-Digit Supplemental Label ID

Default Label ID for this symbology is:

45 = E

Default Label ID for this symbology is:

46 = F



Set EAN-13 Label ID

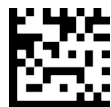

EAN-13 Composite Label ID

Default Label ID for this symbology is:

46 = F

Default Label ID for this symbology is:

46 = F



Set EAN-13 2-Digit Supplemental Label ID



Set EAN-13 5-Digit Supplemental Label ID

Default Label ID for this symbology is:

46 = F

Default Label ID for this symbology is:

4646 = FF



Set EAN-8 Label ID



EAN-8 Composite Label ID

Default Label ID for this symbology is:

4646 = FF

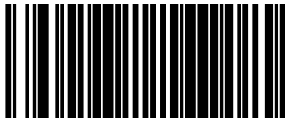

### LABEL ID — 1D SYMBOLOGIES (CONTINUED)

Default Label ID for this symbology is:  
4646 = FF



Set EAN-8 2-Digit Supplemental Label ID

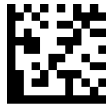

Set EAN-8 5-Digit Supplemental Label ID

Default Label ID for this symbology is:  
4646 = FF

Default Label ID for this symbology is:  
47 = G



Set GTIN Label ID



Set GTIN 2-Digit Supplemental Label ID

Default Label ID for this symbology is:  
4732 = G2

Default Label ID for this symbology is:  
4735 = G5



Set GTIN 5-Digit Supplemental Label ID



Set DataBar Omnidirectional Label ID

Default Label ID for this symbology is:  
5234 = R4

Default Label ID for this symbology is:  
5234 = R4



Set DataBar Omnidirectional Composite Label ID



Set DataBar Limited Label ID

Default Label ID for this symbology is:  
5258 = RX

Default Label ID for this symbology is:  
5258 = RX



DataBar Expanded Label ID

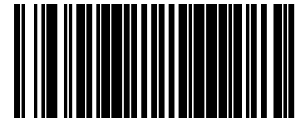

**LABEL ID — 1D SYMBOLOGIES (CONTINUED)**

DataBar Expanded Composite Label ID

Default Label ID for this symbology is:

5258 = RX

Default Label ID for this symbology is:

5258 = RX



Set DataBar Limited Composite Label ID



Code 39 Label ID

Default Label ID for this symbology is:

2A = \*

Default Label ID for this symbology is:

41 = A



Code 32 Label ID



Code 128 Label ID

Default Label ID for this symbology is:

23 = #

Default Label ID for this symbology is:

66 = f



Code 128 ISBT Label ID



EAN 128 Label ID

Default Label ID for this symbology is:

50 = P

Default Label ID for this symbology is:

69 = i



I 2 of 5 Label ID



Codabar Label ID

Default Label ID for this symbology is:

25 = %

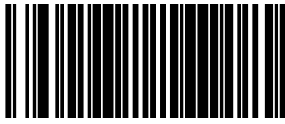

## LABEL ID — 1D SYMBOLOGIES (CONTINUED)

Default Label ID for this symbology is:  
26 = &



Code 93 Label ID

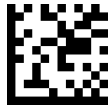

MSI Label ID

Default Label ID for this symbology is:  
40 = @

Default Label ID for this symbology is:  
73 = s



Standard 2 of 5 Label ID



ISBN Label ID

Default Label ID for this symbology is:  
49 = I

Default Label ID for this symbology is:  
57 = W



Industrial 2 of 5 Label ID

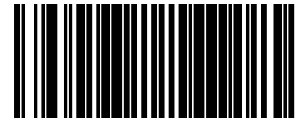

## 2D Symbolologies

LABEL ID — 2D SYMBOLOGIES	
<p>Default Label ID for this symbology is: 446D = Dm</p>	 Data Matrix Label ID
 PDF 417 Label ID	<p>Default Label ID for this symbology is: 50 = P</p>
<p>Default Label ID for this symbology is: 6D50 = mP</p>	 Micro PDF 417 Label ID
 QR Code Label ID	<p>Default Label ID for this symbology is: 5152 = QR</p>
<p>Default Label ID for this symbology is: 2451 = \$Q</p>	 Micro QR Code Label ID
 Aztec Label ID	<p>Default Label ID for this symbology is: 417A = Az</p>
<p>Default Label ID for this symbology is: 4467 = Dg</p>	 GS1 Datamatrix label ID
 GS1 QR Code label ID	<p>Default Label ID for this symbology is: 5147 = QG</p>
<p>Default Label ID for this symbology is: 2453 = \$S</p>	 Han Xin Label ID

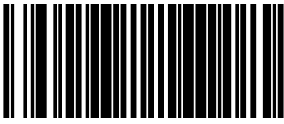

## LABEL ID — 2D SYMBOLOGIES (CONTINUED)



Dotcode Label ID

Default Label ID for this symbology is:  
2464 = \$d

## LABEL ID — OTHER

Default Label ID for this symbology is:  
246F = \$o



OCR A Label ID



OCR B Label ID

Default Label ID for this symbology is:  
2470 = \$p

Default Label ID for this symbology is:  
246D = \$m



MICR Label ID



Digimarc Label ID

Default Label ID for this symbology is:  
2B = +

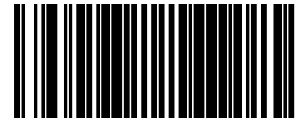

## Global Mid-Label ID

This feature specifies a global mid-label ID that is added between two bar codes for transmission.

To set this feature:

1. Scan the Enter/Exit Programming Mode bar code.
2. Scan the [Set Global Mid-Label ID](#) bar code below. You'll need to cover any unused bar codes on this and the facing page to ensure the scanner reads only the bar code you intend to scan.
3. Scan the appropriate digits from the [Appendix C, Alpha-Numeric Keypad](#) that represent the desired mid-label ID characters; entered as two hex pairs. A table containing the ASCII Character Set and their corresponding Hex Values is available in the inside back cover of this manual. ASCII parameters must be input by scanning a pair of hexadecimal digits for each character. Thus, to set a two-character value of AB, bar codes containing the digits '4', '1', '4', and '2' must be scanned. The selectable range for this option is any hex value from 00 to FF.

Complete the programming sequence by scanning the Enter/Exit Programming Mode bar code.

Default Label ID for this symbology is:

★ 00 = No Global Mid-label ID



Set Global Mid-Label ID

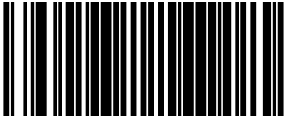

## CASE CONVERSION

This option can change the case of all alphabetic characters in scanned bar code data to upper or lower case.



**NOTE: Case conversion affects ONLY scanned bar code data, and does not affect Label ID, Prefix, Suffix, or other appended data.**

To set this feature:

1. Scan the Enter/Exit Programming Mode bar code.
2. Scan bar code for the desired option below. You'll need to cover any unused bar codes on this and the facing page to ensure that the scanner reads only the bar code you intend to scan.
3. Complete the programming sequence by scanning the Enter/Exit Programming Mode bar code.



★ Case Conversion = No Case Conversion



Case Conversion = Upper Case



Case Conversion = Lower Case

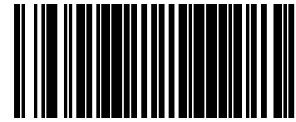

## CHARACTER CONVERSION

Character conversion is an eight byte configuration item. The eight bytes are 4 character pairs represented in hexadecimal ASCII values. The first character in the pair is the character that will be converted. The second character in the pair is the character to convert to. If the character to convert in a pair is FF, then no conversion is done.

For example, if you have the character conversion configuration item set to the following:

41423132FFFFFFFF

The first pair is 4142 or AB (41 hex is an ASCII capital A, 42 hex is an ASCII capital B) and the second pair is 3132 or 12 (31 hex is an ASCII 1, 32 is an ASCII 2). The other two pairs are FFFF and FFFF.

With the label, AG15TA81, it would look as follows after the character conversion: BG25TB82.

The A characters were converted to the B character and the 1 characters were converted to the numeral 2 character. Nothing is done with the last two character pairs, since they are all FF.

To set Character Conversion:

1. Scan the Enter/Exit Programming Mode bar code.
2. Scan the Character Conversion bar code.
3. Determine the desired string. Up to sixteen positions can be determined as in the above example. Next, turn to the ASCII Chart on the inside back cover of this manual and find the equivalent hex digits needed to fulfill the string.



**NOTE: The positions not used must be filled with the character 'F'.**

4. Turn to the [Alpha-Numeric Keypad](#) and scan the bar codes representing the hex characters determined in the previous step. When the last character is scanned, the scanner will sound a triple beep.
5. Complete the programming sequence by scanning the Enter/Exit Programming Mode bar code.

Default setting for this feature is:

★ FFFFFFFFFFFFFFFF (No Character Conversion)



Set Character Conversion

# CONFIGURATION | 1D SYMBOLOGY PROGRAMMING

## 1D Symbologies



**NOTE:** If the scanner's interface type must be changed, always be sure that interface configuration is the **FIRST** item scanned during a programming session. (Selecting an interface type resets **ALL** other configuration items — including symbology programming — to factory default for that interface type.)

The following pages contain configuration information concerning the various bar code types (symbologies) the scanner supports.

SECTION CONTENTS	
<b>COUPON CONTROL</b> starting on page 103	<b>DATABAR EXPANDED</b> starting on page 160
<b>UPC-A</b> starting on page 106	<b>CODE 39</b> starting on page 168
<b>UPC-E</b> starting on page 111	<b>CODE 32 ITALIAN PHARMACODE</b> starting on page 179
<b>EAN-13</b> starting on page 116	<b>CODE 128</b> starting on page 182
<b>EAN-8</b> starting on page 121	<b>EAN-128</b> starting on page 190
<b>OTHER UPC/EAN OPTIONS</b> starting on page 133	<b>INTERLEAVED 2 OF 5 (I 2 OF 5)</b> starting on page 191
<b>GTIN</b> starting on page 150	<b>CODABAR</b> starting on page 198
<b>GS1 DATABAR</b> starting on page 151	<b>CODE 93</b> starting on page 209
<b>DATABAR OMNIDIRECTIONAL</b> starting on page 151	<b>MSI</b> starting on page 214
<b>DATABAR LIMITED</b> starting on page 156	<b>STANDARD 2 OF 5</b> starting on page 222



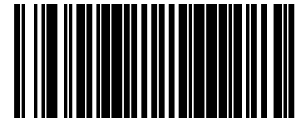

## COUPON CONTROL

### Coupon Control Enable

This feature is used to control the method of processing coupon labels. For the purposes of this feature, coupon labels are defined as (1) UPC-A labels that start with a '5'; or (2) GS1 DataBar Expanded labels that start with '8110'

**Enable UPC-A Coupons :** UPCA coupon labels will decode but RSS/Databar Expanded coupon labels will not. RSS/Databar Expanded labels that are not coupon labels will decode and all UPCA labels will decode.

**Enable GS1 DataBar Expanded Coupons :** RSS/Databar Expanded coupon labels will decode but UPCA coupon labels will not. UPCA labels that are not coupon labels and all RSS/Databar Expanded labels will decode.

**Priority to UPC-A Coupons:** UPCA coupon labels will be given priority.

**Priority to GS1 DataBar Expanded Coupons :** DataBar coupon labels will be given priority.

1. Scan the Enter/Exit Programming Mode bar code.
2. Scan your choice from the Coupon Control selections below. You'll need to cover any unused bar codes on this and the facing page to ensure that the scanner reads only the bar code you intend to scan.
3. Complete by scanning the Enter/Exit Programming Mode bar code.



Coupon Control = Disable



Coupon Control = Enable UPC-A Coupons



Coupon Control = Enable GS1 DataBar Expanded Coupons

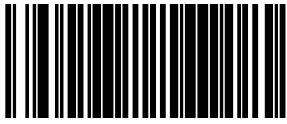

## Coupon Control Enable — continued



Coupon Control = Priority to UPC-A Coupons



★ Coupon Control = Priority to GS1 DataBar Expanded  
Coupons

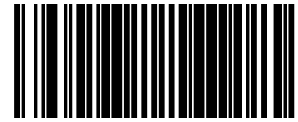

## Coupon Label Priority Timer

This feature sets the duration of the UPCA / DataBar coupon label priority timer.

To set this feature:

1. Scan the Enter/Exit Programming Mode bar code.
2. Scan your selection from the bar codes below. You'll need to cover any unused bar codes on this and the facing page to ensure that the scanner reads only the bar code you intend to scan.
3. Complete the programming sequence by scanning the Enter/Exit Programming Mode bar code.



Coupon Label Priority Timer = 0.1 Seconds



★ Coupon Label Priority Timer = 0.2 Seconds



Coupon Label Priority Timer = 0.3 Seconds



Coupon Label Priority Timer = 0.4 Seconds



Coupon Label Priority Timer = 0.5 Second



Coupon Label Priority Timer = 1 Second

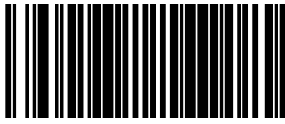

## UPC-A

### UPC-A Enable

Enables/disables the ability of the scanner to decode UPC-A labels.

To set this feature:

1. Scan the Enter/Exit Programming Mode bar code.
2. Scan either the enable or disable bar code below. You'll need to cover any unused bar codes on this and the facing page to ensure that the scanner reads only the bar code you intend to scan.
3. Complete the programming sequence by scanning the Enter/Exit Programming Mode bar code.



UPC-A = Disable



★ UPC-A = Enable

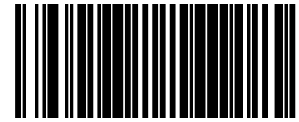

## UPC-A Number System Character Transmission

Enables/disables transmission of a UPC-A number system character.



**NOTE: This item is ignored when the advanced feature, Full Label Edit, is enabled.**

To set this feature:

1. Scan the Enter/Exit Programming Mode bar code.
2. Scan either the enable or disable bar code below. You'll need to cover any unused bar codes on this and the facing page to ensure that the scanner reads only the bar code you intend to scan.
3. Complete the programming sequence by scanning the Enter/Exit Programming Mode bar code.



UPC-A Number System Character Transmission =  
Disable



★ UPC-A Number System Character Transmission =  
Enable

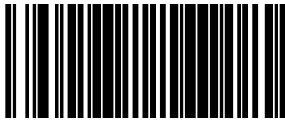

## UPC-A Check Character Transmission

Enables/disables transmission of a UPC-A check character.



**NOTE: This item is ignored when the advanced feature, Full Label Edit, is enabled.**

To set this feature:

1. Scan the Enter/Exit Programming Mode bar code.
2. Scan either the enable or disable bar code below. You'll need to cover any unused bar codes on this and the facing page to ensure that the scanner reads only the bar code you intend to scan.
3. Complete the programming sequence by scanning the Enter/Exit Programming Mode bar code.



UPC-A Check Character Transmission = Disable



★UPC-A Check Character Transmission = Enable

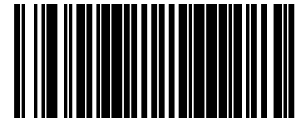

## UPC-A Minimum Read

This feature specifies the minimum number of consecutive UPC-A decodes before is accepted as good read.

To set this feature:

1. Scan the ENTER/EXIT Programming Mode bar code.
2. Scan your selection from the bar codes below. You'll need to cover any unused bar codes on this and the facing page to ensure that the scanner reads only the bar code you intend to scan.
3. Complete the programming sequence by scanning the ENTER/EXIT Programming Mode bar code.



★ UPC-A Minimum Read = 1



UPC-A Minimum Read = 2



UPC-A Minimum Read = 3



UPC-A Minimum Read = 4

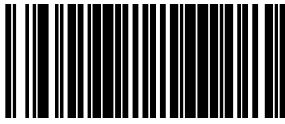

## Expand UPC-A to EAN-13

Enables/disables expansion of UPC-A labels to EAN/JAN-13.

To set this feature:

1. Scan the Enter/Exit Programming Mode bar code.
2. Scan either the enable or disable bar code below. You'll need to cover any unused bar codes on this and the facing page to ensure that the scanner reads only the bar code you intend to scan.
3. Complete the programming sequence by scanning the Enter/Exit Programming Mode bar code.



★ Expand UPC-A to EAN-13 = Disable



Expand UPC-A to EAN-13 = Enable



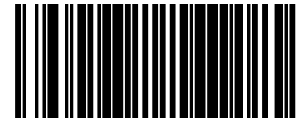

## UPC-E

### UPC-E Enable

Enables/disables the ability of the scanner to decode UPC-E labels.

To set this feature:

1. Scan the Enter/Exit Programming Mode bar code.
2. Scan either the enable or disable bar code below. You'll need to cover any unused bar codes on this and the facing page to ensure that the scanner reads only the bar code you intend to scan.
3. Complete the programming sequence by scanning the Enter/Exit Programming Mode bar code.



UPC-E = Disable



★UPC-E = Enable

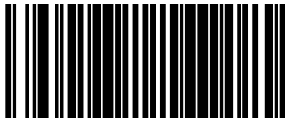

## UPC-E Number System Character Transmission

Enables/disables transmission of a UPC-E number system character.



**NOTE: This item is ignored when the advanced feature, Full Label Edit, is enabled.**

To set this feature:

1. Scan the Enter/Exit Programming Mode bar code.
2. Scan either the enable or disable bar code below. You'll need to cover any unused bar codes on this and the facing page to ensure that the scanner reads only the bar code you intend to scan.
3. Complete the programming sequence by scanning the Enter/Exit Programming Mode bar code.



UPC-E Number System Character Transmission =  
Disable



★ UPC-E Number System Character Transmission =  
Enable

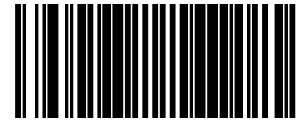

## UPC-E Check Character Transmission

Enables/disables transmission of a UPC-E check character.



**NOTE: This item is ignored when the advanced feature, Full Label Edit, is enabled.**

To set this feature:

1. Scan the Enter/Exit Programming Mode bar code.
2. Scan either the enable or disable bar code below. You'll need to cover any unused bar codes on this and the facing page to ensure that the scanner reads only the bar code you intend to scan.
3. Complete the programming sequence by scanning the Enter/Exit Programming Mode bar code.



UPC-E Check Character Transmission = Disable



★ UPC-E Check Character Transmission = Enable

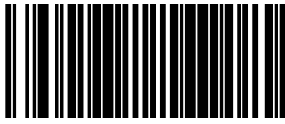

## Expand UPC-E to UPC-A

Enables/disables expansion of UPC-E labels to UPC-A.

To set this feature:

1. Scan the Enter/Exit Programming Mode bar code.
2. Scan either the enable or disable bar code below. You'll need to cover any unused bar codes on this and the facing page to ensure that the scanner reads only the bar code you intend to scan.
3. Complete the programming sequence by scanning the Enter/Exit Programming Mode bar code.



★ Expand UPC-E to UPC-A = Disable



Expand UPC-E to UPC-A = Enable

## Expand UPC-E to EAN-13

Enables/disables expansion of UPC-E labels to EAN/JAN-13.

To set this feature:

1. Scan the Enter/Exit Programming Mode bar code.
2. Scan either the enable or disable bar code below. You'll need to cover any unused bar codes on this and the facing page to ensure that the scanner reads only the bar code you intend to scan.
3. Complete the programming sequence by scanning the Enter/Exit Programming Mode bar code.



★ Expand UPC-E to EAN-13 = Disable



Expand UPC-E to EAN-13 = Enable

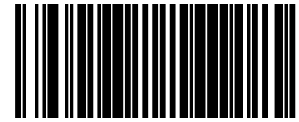

## UPC-E Minimum Read

This feature specifies the minimum number of consecutive UPC-E decodes before is accepted as good read.

To set this feature:

1. Scan the ENTER/EXIT Programming Mode bar code.
2. Scan your selection from the bar codes below. You'll need to cover any unused bar codes on this and the facing page to ensure that the scanner reads only the bar code you intend to scan.
3. Complete the programming sequence by scanning the ENTER/EXIT Programming Mode bar code.



★ UPC-E Minimum Read = 1



UPC-E Minimum Read = 2



UPC-E Minimum Read = 3



UPC-E Minimum Read = 4

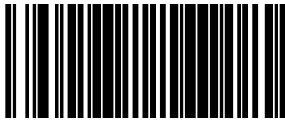

## EAN-13

### EAN-13 Enable

Enables/disables the ability of the scanner to decode EAN/JAN-13 labels.

To set this feature:

1. Scan the Enter/Exit Programming Mode bar code.
2. Scan either the enable or disable bar code below. You'll need to cover any unused bar codes on this and the facing page to ensure that the scanner reads only the bar code you intend to scan.
3. Complete the programming sequence by scanning the Enter/Exit Programming Mode bar code.



EAN-13 = Disable



★ EAN-13 = Enable

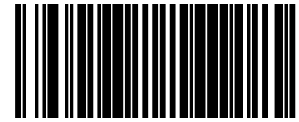

## EAN-13 First Character Transmission

Enables/disables transmission of EAN/JAN-13 first character.



**NOTE: This item is ignored when the advanced feature, Full Label Edit, is enabled.**

To set this feature:

1. Scan the Enter/Exit Programming Mode bar code.
2. Scan either the enable or disable bar code below. You'll need to cover any unused bar codes on this and the facing page to ensure that the scanner reads only the bar code you intend to scan.
3. Complete the programming sequence by scanning the Enter/Exit Programming Mode bar code.



EAN-13 First Character Transmission = Disable



★ EAN-13 First Character Transmission = Enable

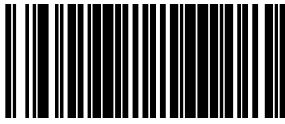

## EAN-13 Check Character Transmission

Enables/disables transmission of an EAN/JAN-13 check character.



**NOTE: This item is ignored when the advanced feature, Full Label Edit, is enabled.**

To set this feature:

1. Scan the Enter/Exit Programming Mode bar code.
2. Scan either the enable or disable bar code below. You'll need to cover any unused bar codes on this and the facing page to ensure that the scanner reads only the bar code you intend to scan.
3. Complete the programming sequence by scanning the Enter/Exit Programming Mode bar code.



EAN-13 Check Character Transmission = Disable



★ EAN-13 Check Character Transmission = Enable



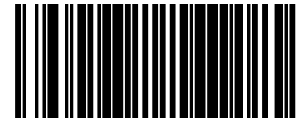

## EAN-13 ISBN Conversion Enable

Enables/disables conversion of EAN/JAN-13 labels starting with 978 to Bookland ISBN labels.

To set this feature:

1. Scan the Enter/Exit Programming Mode bar code.
2. Scan either the enable or disable bar code below. You'll need to cover any unused bar codes on this and the facing page to ensure that the scanner reads only the bar code you intend to scan.
3. Complete the programming sequence by scanning the Enter/Exit Programming Mode bar code.



★ EAN-13 ISBN Conversion = Disable



EAN-13 ISBN Conversion = Enable

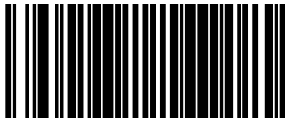

## EAN-13 Minimum Read

This feature specifies the minimum number of consecutive EAN-13 decodes before is accepted as good read.

To set this feature:

1. Scan the ENTER/EXIT Programming Mode bar code.
2. Scan your selection from the bar codes below. You'll need to cover any unused bar codes on this and the facing page to ensure that the scanner reads only the bar code you intend to scan.
3. Complete the programming sequence by scanning the ENTER/EXIT Programming Mode bar code.



★ EAN-13 Minimum Read = 1



EAN-13 Minimum Read = 2



EAN-13 Minimum Read = 3



EAN-13 Minimum Read = 4

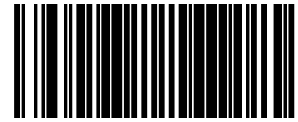

## EAN-8

### EAN-8 Enable

Enables/disables the ability of the scanner to decode EAN/JAN-8 labels.

To set this feature:

1. Scan the Enter/Exit Programming Mode bar code.
2. Scan either the enable or disable bar code below. You'll need to cover any unused bar codes on this and the facing page to ensure that the scanner reads only the bar code you intend to scan.
3. Complete the programming sequence by scanning the Enter/Exit Programming Mode bar code.



EAN-8 = Disable



★ EAN-8 = Enable

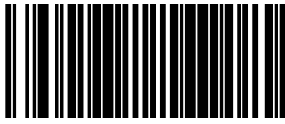

## EAN-8 Check Character Transmission

Enables/disables transmission of an EAN/JAN-8 check character.



**NOTE: This item is ignored when the advanced feature, Full Label Edit, is enabled.**

To set this feature:

1. Scan the Enter/Exit Programming Mode bar code.
2. Scan either the enable or disable bar code below. You'll need to cover any unused bar codes on this and the facing page to ensure that the scanner reads only the bar code you intend to scan.
3. Complete the programming sequence by scanning the Enter/Exit Programming Mode bar code.



EAN-8 Check Character Transmission = Disable



★ EAN-8 Check Character Transmission = Enable

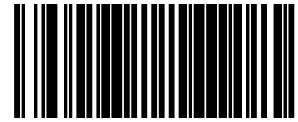

## Expand EAN-8 to EAN-13

Enables/disables expansion of EAN/JAN-8 labels to EAN/JAN-13.

To set this feature:

1. Scan the Enter/Exit Programming Mode bar code.
2. Scan either the enable or disable bar code below. You'll need to cover any unused bar codes on this and the facing page to ensure that the scanner reads only the bar code you intend to scan.
3. Complete the programming sequence by scanning the Enter/Exit Programming Mode bar code.



★ Expand EAN-8 to EAN-13 = Disable



Expand EAN-8 to EAN-13 = Enable

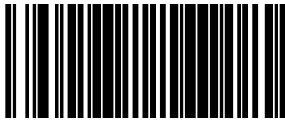

## EAN-8 Minimum Read

This feature specifies the minimum number of consecutive EAN-8 decodes before is accepted as good read.

To set this feature:

1. Scan the ENTER/EXIT Programming Mode bar code.
2. Scan your selection from the bar codes below. You'll need to cover any unused bar codes on this and the facing page to ensure that the scanner reads only the bar code you intend to scan.
3. Complete the programming sequence by scanning the ENTER/EXIT Programming Mode bar code.



★ EAN-8 Minimum Read = 1



EAN-8 Minimum Read = 2



EAN-8 Minimum Read = 3



EAN-8 Minimum Read = 4

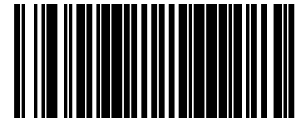

## EAN-8 Guard Insertion

This setting enables the insertion of either a missing leading or trailing guard to a scanned bar code.

To set this feature:

1. Scan the Enter/Exit Programming Mode bar code.
2. Scan either the enable or disable bar code below. You'll need to cover any unused bar codes on this and the facing page to ensure that the scanner reads only the bar code you intend to scan.
3. Complete the programming sequence by scanning the Enter/Exit Programming Mode bar code.



★ EAN-8 Guard Insertion = Disable



EAN-8 Guard Insertion = Enable

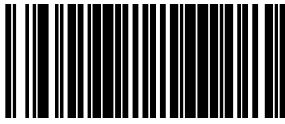

## EAN-8 Guard Substitution

This setting enables the scanner to substitute a guard pattern for even-parity 6 for EAN8/JAN8 labels.

To set this feature:

1. Scan the Enter/Exit Programming Mode bar code.
2. Scan either the enable or disable bar code below. You'll need to cover any unused bar codes on this and the facing page to ensure that the scanner reads only the bar code you intend to scan.
3. Complete the programming sequence by scanning the Enter/Exit Programming Mode bar code.



★ EAN-8 Guard Insertion = Disable



EAN-8 Guard Insertion = Enable



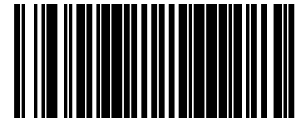

## EAN-8/Jan-8 Both Guards Substitution

Enables/disables the ability of the scanner to find an EAN/JAN8 guard pattern in cases where the EAN/JAN8 margin makes the guard look like a character.

To set this feature:

1. Scan the Enter/Exit Programming Mode bar code.
2. Scan either the enable or disable bar code below. You'll need to cover any unused bar codes on this and the facing page to ensure that the scanner reads only the bar code you intend to scan.
3. Complete the programming sequence by scanning the Enter/Exit Programming Mode bar code.



★ EAN-8/JAN-8 Both Guards Substitution = Disable



EAN-8/JAN-8 Both Guards Substitution = Enable

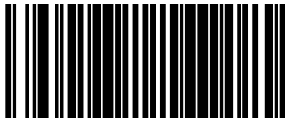

## EAN-8 Stitch Exact Label Halves

This setting enables the stitching of exact EAN-8 label halves with no overlapping characters.

To set this feature:

1. Scan the Enter/Exit Programming Mode bar code.
2. Scan either the enable or disable bar code below. You'll need to cover any unused bar codes on this and the facing page to ensure that the scanner reads only the bar code you intend to scan.
3. Complete the programming sequence by scanning the Enter/Exit Programming Mode bar code.



★ EAN-8 Stitch Exact Label Halves = Disable



EAN-8 Stitch Exact Label Halves = Enable

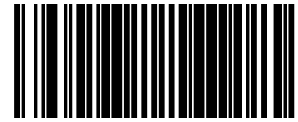

## EAN-8 Stitch Unlike Label Halves

This setting enables the stitching of two EAN-8 label halves together that may have different characters.

To set this feature:

1. Scan the Enter/Exit Programming Mode bar code.
2. Scan either the enable or disable bar code below. You'll need to cover any unused bar codes on this and the facing page to ensure that the scanner reads only the bar code you intend to scan.
3. Complete the programming sequence by scanning the Enter/Exit Programming Mode bar code.



★ EAN-8 Stitch Unlike Label Halves = Disable



EAN-8 Stitch Unlike Label Halves = Enable

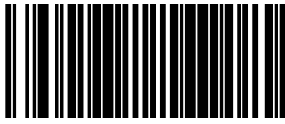

## EAN-8 Minimum Segment Length

Specifies the minimum number of characters necessary in an EAN-8/JAN-8 label segment in order for the scanner to accept a label for decoding. Selectable from 5 to 15 characters. Default setting for this feature is: 08 (8 characters).



EAN-8 Minimum Segment Length = 5 characters



EAN-8 Minimum Segment Length = 6 characters



EAN-8 Minimum Segment Length = 7 characters



★ EAN-8 Minimum Segment Length = 8 characters



EAN-8 Minimum Segment Length = 9 characters



EAN-8 Minimum Segment Length = 10 characters



EAN-8 Minimum Segment Length = 11 characters

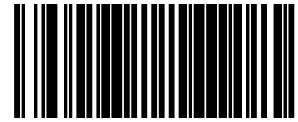

### EAN-8 Minimum Segment Length (continued)



EAN-8 Minimum Segment Length = 12 characters



EAN-8 Minimum Segment Length = 13 characters



EAN-8 Minimum Segment Length = 14 characters



EAN-8 Minimum Segment Length = 15 characters

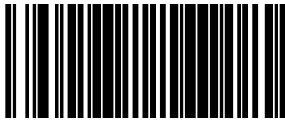

## EAN-8 Decoding Levels

Decoding levels allow the decoder to be set to perform at one of four selectable levels:

- Very Conservative — Slower scan time, virtually eliminates misreads. The most secure setting.
- Slightly More Aggressive — Faster scanning, more aggressive, yet minimizes misreads.
- Moderately Aggressive — Even faster scanning, even more aggressive.
- Very Aggressive — Fastest scan speed, most aggressive.



**CAUTION: Use caution when setting this feature, as more aggressive settings for this feature allow a higher potential for misreads.**



★ EAN-8 Decoding Level = Very Conservative



EAN-8 Decoding Level = Slightly More Aggressive



EAN-8 Decoding Level = Moderately Aggressive



EAN-8 Decoding Level = Very Aggressive

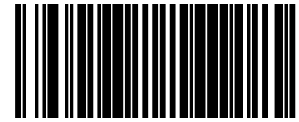

## OTHER UPC/EAN OPTIONS

The following pages contain other selectable features for UPC/EAN symbologies:

In-Store Printed Label Minimum Read	Price Weight Check
UPC/EAN Guard Insertion	Enable EAN Two Label
UPC/EAN Stitch Exact Label Halves	Add-ons
UPC/EAN Stitch Unlike Label Halves	UPC/EAN Composites
UPC/EAN Minimum Segment Length	

### In-Store Printed Label Minimum Read

This feature specifies the minimum number of consecutive In-Store Printed Label decodes before is accepted as good read.

To set this feature:

1. Scan the ENTER/EXIT Programming Mode bar code.
2. Scan your selection from the bar codes below. You'll need to cover any unused bar codes on this and the facing page to ensure that the scanner reads only the bar code you intend to scan.
3. Complete the programming sequence by scanning the ENTER/EXIT Programming Mode bar code.



★ In-Store Printed Label Minimum Read = 1



In-Store Printed Label Minimum Read = 2



In-Store Printed Label Minimum Read = 3



In-Store Printed Label Minimum Read = 4

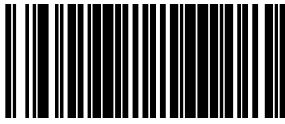

## UPC/EAN Guard Insertion

This setting enables the insertion of either a missing leading or trailing guard to a scanned bar code.

To set this feature:

1. Scan the Enter/Exit Programming Mode bar code.
2. Scan either the enable or disable bar code below. You'll need to cover any unused bar codes on this and the facing page to ensure that the scanner reads only the bar code you intend to scan.
3. Complete the programming sequence by scanning the Enter/Exit Programming Mode bar code.



★ UPC/EAN Guard Insertion = Disable



UPC/EAN Guard Insertion = Enable



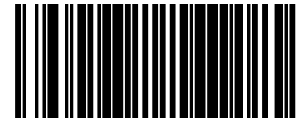

## UPC/EAN Stitch Exact Label Halves

This setting enables the stitching of exact UPC-A/EAN-13 label halves with no overlapping characters.

To set this feature:

1. Scan the Enter/Exit Programming Mode bar code.
2. Scan either the enable or disable bar code below. You'll need to cover any unused bar codes on this and the facing page to ensure that the scanner reads only the bar code you intend to scan.
3. Complete the programming sequence by scanning the Enter/Exit Programming Mode bar code.



★UPC/EAN Stitch Exact Label Halves = Disable



UPC/EAN Stitch Exact Label Halves = Enable

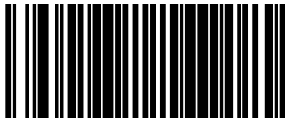

## UPC/EAN Stitch Unlike Label Halves

This setting enables the stitching of two UPC-A/EAN-13 label halves together that may have different characters.

To set this feature:

1. Scan the Enter/Exit Programming Mode bar code.
2. Scan either the enable or disable bar code below. You'll need to cover any unused bar codes on this and the facing page to ensure that the scanner reads only the bar code you intend to scan.
3. Complete the programming sequence by scanning the Enter/Exit Programming Mode bar code.



★UPC/EAN Stitch Unlike Label Halves = Disable



UPC/EAN Stitch Unlike Label Halves = Enable

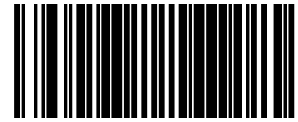

## UPC/EAN Minimum Segment Length

This feature specifies the minimum number of characters needed in a UPC/EAN segment in order to be accepted for decoding.

To set this feature:

1. Scan the Enter/Exit Programming Mode bar code.
2. Scan the bar code for the desired setting below. You'll need to cover any unused bar codes on this and the facing page to ensure that the scanner reads only the bar code you intend to scan.
3. Complete the programming sequence by scanning the Enter/Exit Programming Mode bar code.



★UPC/EAN Minimum Segment Length = 5 Characters



UPC/EAN Minimum Segment Length = 6 Characters



UPC/EAN Minimum Segment Length = 7 Characters



UPC/EAN Minimum Segment Length = 8 Characters



UPC/EAN Minimum Segment Length = 9 Characters

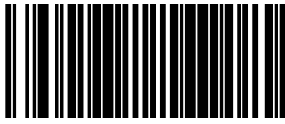

## UPC/EAN Minimum Segment Length — continued



UPC/EAN Minimum Segment Length = 10 Characters



UPC/EAN Minimum Segment Length = 11 Characters



UPC/EAN Minimum Segment Length = 12 Characters



UPC/EAN Minimum Segment Length = 13 Characters



UPC/EAN Minimum Segment Length = 14 Characters



UPC/EAN Minimum Segment Length = 15 Characters

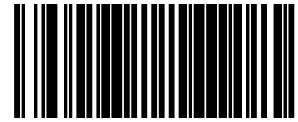

## Price Weight Check

Enables/disables calculation and verification of price/weight check digits. Applies to all UPC-A and EAN/JAN-13 labels with eligible<sup>1</sup> Number System/First Character digits.

Options are:

- Disable
- 4-digit price/weight
- 5-digit price/weight
- 4-digit European price/weight
- 5-digit European price/weight

To set this feature:

1. Scan the Enter/Exit Programming Mode bar code.
2. Scan the bar code representing the desired option below or on the following pages. You'll need to cover any unused bar codes on facing pages to ensure that the scanner reads only the bar code you intend to scan.
3. Complete the programming sequence by scanning the Enter/Exit Programming Mode bar code.



★ Price Weight Check = Disable



Price Weight Check = 4-digit price/weight



Price Weight Check = 5-digit price/weight

1. Price Weight Check generally applies to UPC-A labels with a Number System Digit of 2 and EAN/JAN-13 labels with a First Character of 2. There are a total of six flag digits corresponding to the six types. Checking applies depending upon which type is enabled.

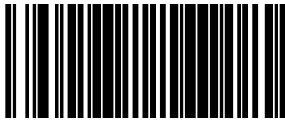

ENTER/EXIT PROGRAMMING MODE

---

## Price Weight Check (continued)



Price Weight Check = 4-digit European price/weight



Price Weight Check = 5-digit European price/weight

## Enable EAN Two Label

Enables/disables the ability of the scanner to decode EAN two-label pairs.

To set this feature:

1. Scan the Enter/Exit Programming Mode bar code.
2. Scan either the enable or disable bar code below. You'll need to cover any unused bar codes on this and the facing page to ensure that the scanner reads only the bar code you intend to scan.
3. Complete the programming sequence by scanning the Enter/Exit Programming Mode bar code.



**NOTE: Contact Customer Support for details about advanced programming for this feature.**



★ EAN Two Label = Disable



EAN Two Label = Enable

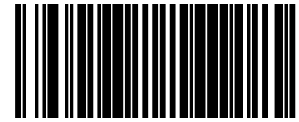

## EAN Two Label Minimum Read

This feature specifies the minimum number of consecutive EAN Two Label decodes before is accepted as good read.

To set this feature:

1. Scan the ENTER/EXIT Programming Mode bar code.
2. Scan your selection from the bar codes below. You'll need to cover any unused bar codes on this and the facing page to ensure that the scanner reads only the bar code you intend to scan.
3. Complete the programming sequence by scanning the ENTER/EXIT Programming Mode bar code.



★ EAN Two Label Minimum Read = 1



EAN Two Label Minimum Read = 2



EAN Two Label Minimum Read = 3



EAN Two Label Minimum Read = 4

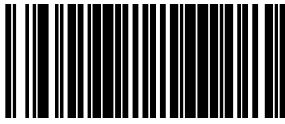

## EAN Two Label Combined Transmission

Enables/disables the transmitting of an EAN two label pair as one label.

To set this feature:

1. Scan the Enter/Exit Programming Mode bar code.
2. Scan either the enable or disable bar code below. You'll need to cover any unused bar codes on this and the facing page to ensure that the scanner reads only the bar code you intend to scan.
3. Complete the programming sequence by scanning the Enter/Exit Programming Mode bar code.



★ EAN Two Label Combined Transmission = Disable



EAN Two Label Combined Transmission = Enable



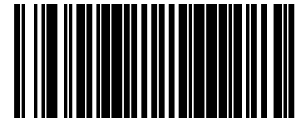

## Add-ons

The scanner is capable of processing different types of add-on codes, including:

- 2-Digit Supplemental
- 5-Digit Supplemental

Options are provided on the following pages for your convenience:

- Disable all add-ons — The scanner will not look for or read add-ons.
- Optional 2-Digit and 5-Digit Supplemental — Bar Codes can be read which include 2-Digit or 5-Digit Supplementals, however, it is not required that add-ons be included in bar codes.



**NOTE: Contact customer support for advanced programming of optional and conditional add-ons.**

To set this feature:

1. Scan the Enter/Exit Programming Mode bar code.
2. Scan the bar code representing the desired option on this and the following page. You'll need to cover any unused bar codes on facing pages to ensure that the scanner reads only the bar code you intend to scan.
3. Complete the programming sequence by scanning the Enter/Exit Programming Mode bar code.



★ Add-ons = Disable All Add-ons



Add-ons = Optional 2-Digit and 5-Digit Supplemental

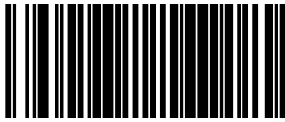

## P2 Add-on Minimum Read

This feature specifies the minimum number of times a P2 add-on must decode before it is marked valid.

To set this feature:

1. Scan the Enter/Exit Programming Mode bar code.
2. Scan the bar code representing the desired option on this and the following page. You'll need to cover any unused bar codes on facing pages to ensure that the scanner reads only the bar code you intend to scan.
3. Complete by scanning the Enter/Exit Programming Mode bar code.



★ P2 Add-on Minimum Read = 2



P2 Add-on Minimum Read = 3

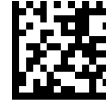

P2 Add-on Minimum Read = 4



P2 Add-on Minimum Read = 5



P2 Add-on Minimum Read = 6



P2 Add-on Minimum Read = 7

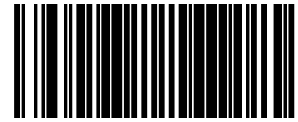

## P2 Add-on Minimum Read — continued



P2 Add-on Minimum Read = 8



P2 Add-on Minimum Read = 9



P2 Add-on Minimum Read = 10



P2 Add-on Minimum Read = 11



P2 Add-on Minimum Read = 12



P2 Add-on Minimum Read = 13



P2 Add-on Minimum Read = 14



P2 Add-on Minimum Read = 15

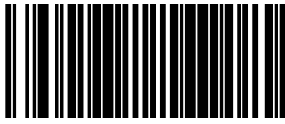

## P5 Add-on Minimum Read

This feature specifies the minimum number of times a P5 add-on must decode before it is marked valid.

To set this feature:

1. Scan the Enter/Exit Programming Mode bar code.
2. Scan the bar code representing the desired option on this and the following page. You'll need to cover any unused bar codes on facing pages to ensure that the scanner reads only the bar code you intend to scan.
3. Complete the programming sequence by scanning the Enter/Exit Programming Mode bar code.



★ P5 Add-on Minimum Read = 1



P5 Add-on Minimum Read = 2



P5 Add-on Minimum Read = 3



P5 Add-on Minimum Read = 4



P5 Add-on Minimum Read = 5



P5 Add-on Minimum Read = 6

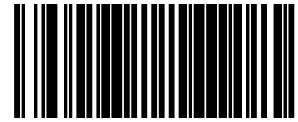

## P5 Add-on Minimum Read — continued



P5 Add-on Minimum Read = 7



P5 Add-on Minimum Read = 8



P5 Add-on Minimum Read = 9



P5 Add-on Minimum Read = 10



P5 Add-on Minimum Read = 11



P5 Add-on Minimum Read = 12



P5 Add-on Minimum Read = 13

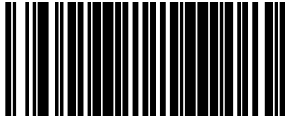

ENTER/EXIT PROGRAMMING MODE

---

## P5 Add-on Minimum Read — continued



P5 Add-on Minimum Read = 14



P5 Add-on Minimum Read = 15

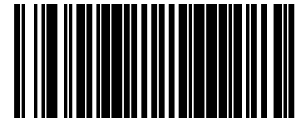

## UPC/EAN Composites

Enables/Disables Composites for the UPC/EAN families of labels.

The value is a bit field where the bits mean the following:

- A setting of 0 (zero) disables this feature.
- Bit0 - if set enabled Composites for UPCE, if clear disables Composites for UPCE
- Bit1 - if set enabled Composites for UPCA, if clear disables Composites for UPCA
- Bit2 - if set enabled Composites for EAN8, if clear disables Composites for EAN8
- Bit3 - if set enabled Composites for EAN13, if clear disables Composites for EAN13

To set this feature:

1. Scan the Enter/Exit Programming Mode bar code.
2. Scan the bar code below. You'll need to cover any unused bar codes on this and the facing page to ensure that the scanner reads only the bar code you intend to scan.
3. Scan the appropriate digits from the [Alpha-Numeric Keypad](#) that represent the desired number. The selectable range is 0-15 resets. Pad all single and double digit numbers with leading zeroes to yield a two-digit entry (00-15).
4. Complete the programming sequence by scanning the Enter/Exit Programming Mode bar code.

Default setting for this feature is:

★00 - Disabled

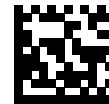

SetUPC/EAN Composites

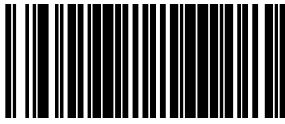

## GTIN

### GTIN Enable

Enables/Disables the ability to convert UPCE, UPCA, EAN8, and EAN13 labels into the GTIN 14-character format.



**NOTE: If add-on information is present on the base label prior to the conversion taking place, the add-on information will be appended to the converted GTIN bar code.**

To set this feature:

1. Scan the Enter/Exit Programming Mode bar code.
2. Scan either the enable or disable bar code below. You'll need to cover any unused bar codes on this and the facing page to ensure that the scanner reads only the bar code you intend to scan.
3. Complete the programming sequence by scanning the Enter/Exit Programming Mode bar code.



★GTIN = Disable



GTIN = Enable



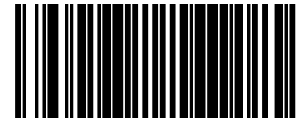

## GS1 DATABAR

The symbology family GS1 DataBar™ was formerly known as Reduced Space Symbology (RSS). For the purpose of simplicity, GS1 DataBar variants are listed in this manual as “DataBar.”

## DATABAR OMNIDIRECTIONAL

### DataBar Omnidirectional Enable

Enables/disables the ability of the scanner to decode DataBar Omnidirectional labels.

To set this feature:

1. Scan the ENTER/EXIT Programming Mode bar code.
2. Scan either the enable or disable bar code below. You’ll need to cover any unused bar codes on this and the facing page to ensure that the scanner reads only the bar code you intend to scan.
3. Complete the programming sequence by scanning the ENTER/EXIT Programming Mode bar code.



★ DataBar Omnidirectional = Disable



DataBar Omnidirectional = Enable

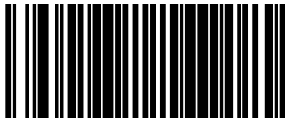

## DataBar Omnidirectional/EAN-128 Emulation

Enables/disables the ability of DataBar Omnidirectional to be transmitted as EAN-128.

1. To set this feature:
2. Scan the ENTER/EXIT Programming Mode bar code.
3. Scan either the enable or disable bar code below. You'll need to cover any unused bar codes on this and the facing page to ensure that the scanner reads only the bar code you intend to scan.
4. Complete the programming sequence by scanning the ENTER/EXIT Programming Mode bar code.



★ DataBar Omnidirectional/EAN-128 Emulation =  
Disable



DataBar Omnidirectional/EAN-128 Emulation = Enable

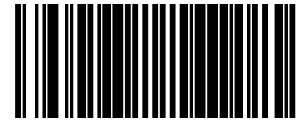

## DataBar Omnidirectional 2D Component Enable

When this feature is enabled, the software will not decode an DataBar Omnidirectional bar code with a 2D component associated with it, and the 2D component will be discarded.

To set this feature:

1. Scan the ENTER/EXIT Programming Mode bar code.
2. Scan your selection from the bar codes below. You'll need to cover any unused bar codes on this and the facing page to ensure that the scanner reads only the bar code you intend to scan.
3. Complete the programming sequence by scanning the ENTER/EXIT Programming Mode bar code.



★ DataBar Omnidirectional 2D Component = Disable



DataBar Omnidirectional 2D Component = Enable

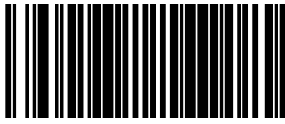

## DataBar Omnidirectional Minimum Read

This feature specifies the minimum number of consecutive DataBar Omnidirectional decodes before is accepted as good read.

To set this feature:

1. Scan the ENTER/EXIT Programming Mode bar code.
2. Scan your selection from the bar codes below. You'll need to cover any unused bar codes on this and the facing page to ensure that the scanner reads only the bar code you intend to scan.
3. Complete the programming sequence by scanning the ENTER/EXIT Programming Mode bar code.



★ DataBar Omnidirectional Minimum Read = 1



DataBar Omnidirectional Minimum Read = 2



DataBar Omnidirectional Minimum Read = 3



DataBar Omnidirectional Minimum Read = 4

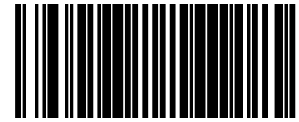

## DataBar Omnidirectional Double Read Timeout

Specifies the minimum allowable time which must pass before reading the same DataBar Omnidirectional label again (e.g. two identical items in succession).

To set this feature:

1. Scan the Enter/Exit Programming Mode bar code.
2. Scan your selection from the bar codes below. You'll need to cover any unused bar codes on this and the facing page to ensure that the scanner reads only the bar code you intend to scan.
3. Complete the programming sequence by scanning the Enter/Exit Programming Mode bar code.



DataBar Omnidirectional Double Read  
Timeout = 0.5 Seconds



DataBar Omnidirectional Double Read  
Timeout = 1 Second



DataBar Omnidirectional Double Read  
★ Timeout = 2.5 Seconds



DataBar Omnidirectional Double Read  
Timeout = 3 Seconds



DataBar Omnidirectional Double Read  
Timeout = 3.5 Seconds

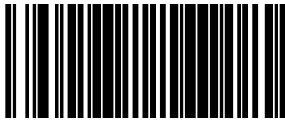

## DATABAR LIMITED

### DataBar Limited Enable

Enables/disables the ability of the scanner to decode DataBar Limited labels.

To set this feature:

1. Scan the ENTER/EXIT Programming Mode bar code.
2. Scan either the enable or disable bar code below. You'll need to cover any unused bar codes on this and the facing page to ensure that the scanner reads only the bar code you intend to scan.
3. Complete the programming sequence by scanning the ENTER/EXIT Programming Mode bar code.



★ Databar Limited = Disable



Databar Limited = Enable

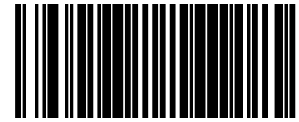

## DataBar Limited Minimum Read

This feature specifies the minimum number of consecutive Databar Limited decodes before is accepted as good read.

To set this feature:

1. Scan the ENTER/EXIT Programming Mode bar code.
2. Scan either the enable or disable bar code below. You'll need to cover any unused bar codes on this and the facing page to ensure that the scanner reads only the bar code you intend to scan.
3. Complete the programming sequence by scanning the ENTER/EXIT Programming Mode bar code.



★ Databar Limited Minimum Read = 1



Databar Limited Minimum Read = 2



Databar Limited Minimum Read = 3



Databar Limited Minimum Read = 4

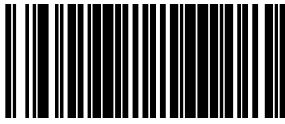

ENTER/EXIT PROGRAMMING MODE

---

## DataBar Limited 2D Component Enable

This feature controls if a 2D label component be decoded when a Databar Limited base label is decoded.

To set this feature:

1. Scan the ENTER/EXIT Programming Mode bar code.
2. Scan either the enable or disable bar code below. You'll need to cover any unused bar codes on this and the facing page to ensure that the scanner reads only the bar code you intend to scan.
3. Complete the programming sequence by scanning the ENTER/EXIT Programming Mode bar code.



★ Databar Limited 2D Component = Disable



Databar Limited 2D Component = Enable



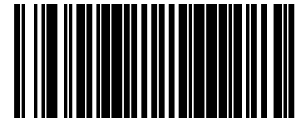

## DataBar Limited EAN128 Emulation Enable

Enables/disables GS1-EAN128 emulation for GS1 Databar Limited.

To set this feature:

1. Scan the ENTER/EXIT Programming Mode bar code.
2. Scan either the enable or disable bar code below. You'll need to cover any unused bar codes on this and the facing page to ensure that the scanner reads only the bar code you intend to scan.
3. Complete the programming sequence by scanning the ENTER/EXIT Programming Mode bar code.



★ Databar Limited EAN128 Emulation = disable



Databar Limited EAN128 Emulation = enable

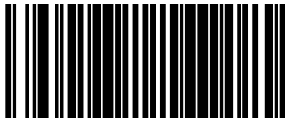

## DATABAR EXPANDED

### DataBar Expanded Enable

Enables/disables the ability of the scanner to decode DataBar Expanded labels.

To set this feature:

1. Scan the ENTER/EXIT Programming Mode bar code.
2. Scan either the enable or disable bar code below. You'll need to cover any unused bar codes on this and the facing page to ensure that the scanner reads only the bar code you intend to scan.
3. Complete the programming sequence by scanning the ENTER/EXIT Programming Mode bar code.



★ DataBar Expanded = Disable



DataBar Expanded = Enable

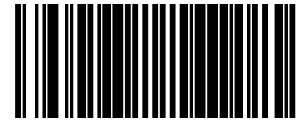

## DataBar Expanded EAN-128 Emulation

Enables/disables EAN 128 emulation for DataBar Expanded.

To set this feature:

1. Scan the ENTER/EXIT Programming Mode bar code.
2. Scan either the enable or disable bar code below. You'll need to cover any unused bar codes on this and the facing page to ensure that the scanner reads only the bar code you intend to scan.
3. Complete the programming sequence by scanning the ENTER/EXIT Programming Mode bar code.



★ DataBar Expanded EAN-128 Emulation = Disable



DataBar Expanded EAN-128 Emulation = Enable

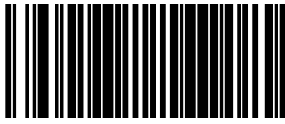

## DataBar Expanded 2D Component Enable

When this feature is enabled, the software will not decode an DataBar Expanded bar code with a 2D component associated with it, and the 2D component will be discarded.

To set this feature:

1. Scan the ENTER/EXIT Programming Mode bar code.
2. Scan your selection from the bar codes below. You'll need to cover any unused bar codes on this and the facing page to ensure that the scanner reads only the bar code you intend to scan.
3. Complete the programming sequence by scanning the ENTER/EXIT Programming Mode bar code.



★ DataBar Expanded 2D Component = Disable



DataBar Expanded 2D Component = Enable

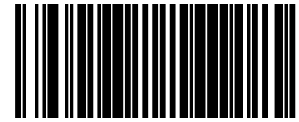

## DataBar Expanded Minimum Read

This feature specifies the minimum number of consecutive DataBar Expanded decodes before is accepted as good read.

To set this feature:

1. Scan the ENTER/EXIT Programming Mode bar code.
2. Scan your selection from the bar codes below. You'll need to cover any unused bar codes on this and the facing page to ensure that the scanner reads only the bar code you intend to scan.
3. Complete the programming sequence by scanning the ENTER/EXIT Programming Mode bar code.



★ DataBar Expanded Minimum Read = 1



DataBar Expanded Minimum Read = 2



DataBar Expanded Minimum Read = 3



DataBar Expanded Minimum Read = 4

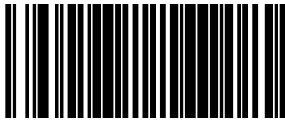

## DataBar Expanded Length Control

This feature specifies either variable-length or fixed-length decoding for DataBar Expanded.

To set this feature:

1. Scan the ENTER/EXIT Programming Mode bar code.
2. Scan your selection from the bar codes below. You'll need to cover any unused bar codes on this and the facing page to ensure that the scanner reads only the bar code you intend to scan.
3. Complete the programming sequence by scanning the ENTER/EXIT Programming Mode bar code.



★ DataBar Expanded Length Control = Variable Length



DataBar Expanded Length Control = Fixed Length

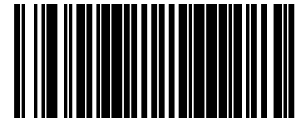

## DataBar Expanded Length 1

Length 1 is the minimum label length if in variable length mode, or the first fixed length if in fixed length mode. Length includes the bar code's data characters only.

To set this feature:

1. Scan the ENTER/EXIT Programming Mode bar code.
2. Scan the bar code, [Set DataBar Expanded Length 1](#) below. You'll need to cover any unused bar codes on this and the facing page to ensure that the scanner reads only the bar code you intend to scan.
3. Scan the appropriate digits from the [Alpha-Numeric Keypad in Appendix C](#) that represent the desired label length. The selectable range for this option is 00 to 74. Pad all single digit numbers with a leading zero to yield a two-digit entry (00-74).
4. Complete the programming sequence by scanning the ENTER/EXIT Programming Mode bar code.

★ Default setting for this feature = 01



Set DataBar Expanded Length 1

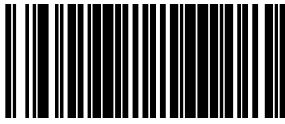

## DataBar Expanded Length 2

Length 2 is the maximum label length if in variable length mode, or the second fixed length if in fixed length mode. Length includes the bar code's data characters only.



**NOTE: When in Fixed Length mode, if Length 2 is set to the value of 00 (zero), then only Length 1 will apply.**

To set this feature:

1. Scan the ENTER/EXIT Programming Mode bar code.
2. Scan the bar code, [Set DataBar Expanded Length 2](#) below. You'll need to cover any unused bar codes on this and the facing page to ensure that the scanner reads only the bar code you intend to scan.
3. Scan the appropriate digits from the [Alpha-Numeric Keypad in Appendix C](#) that represent the desired label length. The selectable range for this option is 00 to 74. Pad all single digit numbers with a leading zero to yield a two-digit entry (00-74).
4. Complete the programming sequence by scanning the ENTER/EXIT Programming Mode bar code.

★ Default setting for this feature = 4A (length = 74)



Set DataBar Expanded Length 2



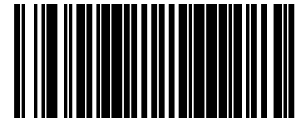

## DataBar Expanded Reverse Retry

Enables/disables the reading of out of specification labels where the last row has been printed in reverse.

- When enabled, DataBar Expanded Stacked labels that have the last row incorrectly printed in reverse will be re-decoded.
- When disabled, DataBar Expanded Stacked labels that have the last row incorrectly printed in reverse will not be read.

To set this feature:

1. Scan the ENTER/EXIT Programming Mode bar code.
2. Scan your selection from the bar codes below. You'll need to cover any unused bar codes on this and the facing page to ensure that the scanner reads only the bar code you intend to scan.
3. Complete the programming sequence by scanning the ENTER/EXIT Programming Mode bar code.



★ DataBar Expanded Reverse Retry = Disable



DataBar Expanded Reverse Retry = Enable

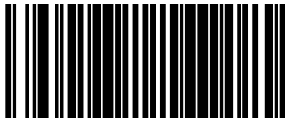

## Code 39

### Code 39 Enable

Enables/disables the ability of the scanner to decode Code 39 labels.

To set this feature:

1. Scan the ENTER/EXIT Programming Mode bar code.
2. Scan either the enable or disable bar code below. You'll need to cover any unused bar codes on this and the facing page to ensure that the scanner reads only the bar code you intend to scan.
3. Complete the programming sequence by scanning the ENTER/EXIT Programming Mode bar code.



Code 39 = Disable



★ Code 39 = Enable

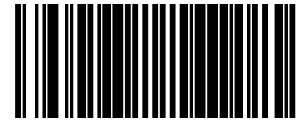

## Code 39 Start Stop Character Transmission

Enables/disables transmission of Code 39 start and stop characters.



**NOTE: This item is ignored when the advanced feature, Full Label Edit, is enabled**

To set this feature:

1. Scan the ENTER/EXIT Programming Mode bar code.
2. Scan either the enable or disable bar code below. You'll need to cover any unused bar codes on this and the facing page to ensure that the scanner reads only the bar code you intend to scan.
3. Complete the programming sequence by scanning the ENTER/EXIT Programming Mode bar code.



★ Code 39 Start Stop Character Transmission = Disable



Code 39 Start Stop Character Transmission = Enable

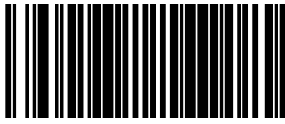

## Code 39 Check Character Calculation

Enables/disables calculation and verification of an optional Code 39 check character. When disabled, any check character in label is treated as a data character.



**NOTE: If check calculation is disabled, the risk is increased that a misread can occur.**

To set this feature:

1. Scan the ENTER/EXIT Programming Mode bar code.
2. Scan either the enable or disable bar code below. You'll need to cover any unused bar codes on this and the facing page to ensure that the scanner reads only the bar code you intend to scan.
3. Complete the programming sequence by scanning the ENTER/EXIT Programming Mode bar code.



★ Code 39 Check Character Calculation = Disable



Code 39 Check Character Calculation = Enable

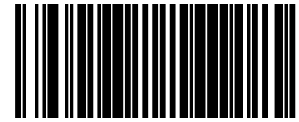

## Code 39 Check Character Transmission

Enables/disables transmission of optional Code 39 check character.



**NOTE: This item is ignored when the advanced feature, Full Label Edit, is enabled.**

To set this feature:

1. Scan the ENTER/EXIT Programming Mode bar code.
2. Scan either the enable or disable bar code below. You'll need to cover any unused bar codes on this and the facing page to ensure that the scanner reads only the bar code you intend to scan.
3. Complete the programming sequence by scanning the ENTER/EXIT Programming Mode bar code.



Code 39 Check Character Transmission = Disable



★ Code 39 Check Character Transmission = Enable

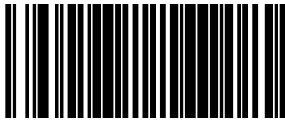

## Code 39 Full ASCII

Enables/disables the ability of the scanner to translate to Code 39 full ASCII labels.

To set this feature:

1. Scan the ENTER/EXIT Programming Mode bar code.
2. Scan either the enable or disable bar code below. You'll need to cover any unused bar codes on this and the facing page to ensure that the scanner reads only the bar code you intend to scan.
3. Complete the programming sequence by scanning the ENTER/EXIT Programming Mode bar code.



★ Code 39 Full ASCII = Disable



Code 39 Full ASCII = Enable

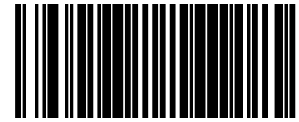

## Code 39 Minimum Read

This feature specifies the minimum number of consecutive Code 39 decodes before is accepted as good read.

To set this feature:

1. Scan the ENTER/EXIT Programming Mode bar code.
2. Scan your selection from the bar codes below. You'll need to cover any unused bar codes on this and the facing page to ensure that the scanner reads only the bar code you intend to scan.
3. Complete the programming sequence by scanning the ENTER/EXIT Programming Mode bar code.



★ Code 39 Minimum Read = 1



Code 39 Minimum Read = 2



Code 39 Minimum Read = 3



Code 39 Minimum Read = 4

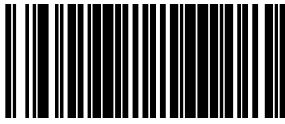

## Code 39 Length Control

This feature specifies whether variable-length or fixed-length decoding will be set for Code 39.

To set this feature:

1. Scan the ENTER/EXIT Programming Mode bar code.
2. Scan your selection from the bar codes below. You'll need to cover any unused bar codes on this and the facing page to ensure that the scanner reads only the bar code you intend to scan.
3. Complete the programming sequence by scanning the ENTER/EXIT Programming Mode bar code.



★ Code 39 Length Control = Variable Length



Code 39 Length Control = Fixed Length



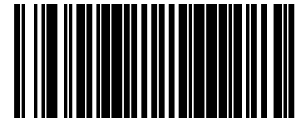

## Code 39 Length 1

If Code 39 Length Control is set to Fixed-Length decoding, this feature specifies Code 39 first fixed length. If Code 39 Length Control is set to Variable-Length decoding, this feature specifies the minimum label length.

To set this feature:

1. Scan the ENTER/EXIT Programming Mode bar code.
2. Scan the bar code, [Set Code 39 Length 1](#) below. You'll need to cover any unused bar codes on this and the facing page to ensure that the scanner reads only the bar code you intend to scan.
3. Scan the appropriate digits from the [Alpha-Numeric Keypad in Appendix C](#) that represent the desired label length. The selectable range for this option is 00 to 50. Pad all single digit numbers with a leading zero to yield a two-digit entry (00-50).
4. Complete the programming sequence by scanning the ENTER/EXIT Programming Mode bar code.

★ Default setting for this feature = 02



Set Code 39 Length 1

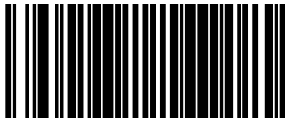

## Code 39 Length 2

If Code 39 Length Control is set to Fixed-Length decoding, this feature specifies Code 39 second fixed length. If Code 39 Length Control is set to Variable-Length decoding, this feature specifies the maximum label length.



**NOTE: When in Fixed Length mode, if Length 2 is set to the value of 00, then only Length 1 will apply**

To set this feature:

1. Scan the ENTER/EXIT Programming Mode bar code.
2. Scan the bar code, [Set Code 39 Length 2](#) below. You'll need to cover any unused bar codes on this and the facing page to ensure that the scanner reads only the bar code you intend to scan.
3. Scan the appropriate digits from the [Alpha-Numeric Keypad in Appendix C](#) that represent the desired label length. The selectable range for this option is 00, no second fixed length, or 01 to 50. Pad all single digit numbers with a leading zero to yield a two-digit entry (00-50).
4. Complete the programming sequence by scanning the ENTER/EXIT Programming Mode bar code.

★ Default setting for this feature = 32 (length = 50)



Set Code 39 Length 2

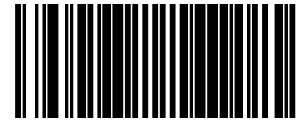

## Code 39 Stitching

Enables/disables stitching for Code 39 labels. When parts of a Code 39 bar code are presented to the scanner with this feature enabled, the bar code parts will be assembled by the scanner's software, and the data will be decoded if all bar code proofing requirements are met.

To set this feature:

1. Scan the ENTER/EXIT Programming Mode bar code.
2. Scan your selection from the bar codes below. You'll need to cover any unused bar codes on this and the facing page to ensure that the scanner reads only the bar code you intend to scan.
3. Complete the programming sequence by scanning the ENTER/EXIT Programming Mode bar code.



Code 39 Stitching = Disable



★ Code 39 Stitching = Enable

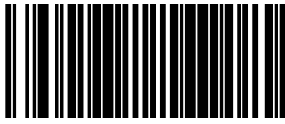

## Code 39 Require Margins

Enables/disables the requirement that quiet zones be present in a Code 39 bar code.

To set this feature:

1. Scan the ENTER/EXIT Programming Mode bar code.
2. Scan either the enable or disable bar code below. You'll need to cover any unused bar codes on this and the facing page to ensure that the scanner reads only the bar code you intend to scan.
3. Complete the programming sequence by scanning the ENTER/EXIT Programming Mode bar code.



★ Code 39 Require Margins = Quiet Zones Not Required



Code 39 Require Margins = Quiet Zones Required

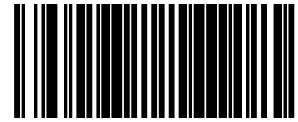

## Code 32 Italian Pharmacode

### Code 32 Italian Pharmacode Enable

Enables/disables the ability of the scanner to decode Italian Pharmaceutical Code 39 labels.

To set this feature:

1. Scan the ENTER/EXIT Programming Mode bar code.
2. Scan either the enable or disable bar code below. You'll need to cover any unused bar codes on this and the facing page to ensure that the scanner reads only the bar code you intend to scan.
3. Complete the programming sequence by scanning the ENTER/EXIT Programming Mode bar code.



★ Code 32 Italian Pharmacode Enable = Disable



Code 32 Italian Pharmacode Enable = Enable

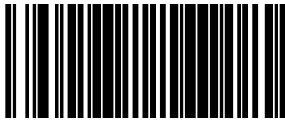

## Code 32 Start Stop Character Transmission

Enables/ disables transmission of start and stop characters for Code 32.



**NOTE: This item is ignored when the advanced feature, Full Label Edit, is enabled.**

To set this feature:

1. Scan the ENTER/EXIT Programming Mode bar code.
2. Scan either the enable or disable bar code below. You'll need to cover any unused bar codes on this and the facing page to ensure that the scanner reads only the bar code you intend to scan.
3. Complete the programming sequence by scanning the ENTER/EXIT Programming Mode bar code.



★ Code 32 Start Stop Character Transmission = Disable



Code 32 Start Stop Character Transmission = Enable

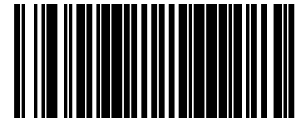

## Code 32 Check Character Transmission

Enables/disables transmission of Code 32 check character.



**NOTE: This item is ignored when the advanced feature, Full Label Edit, is enabled.**

To set this feature:

1. Scan the ENTER/EXIT Programming Mode bar code.
2. Scan either the enable or disable bar code below. You'll need to cover any unused bar codes on this and the facing page to ensure that the scanner reads only the bar code you intend to scan.
3. Complete the programming sequence by scanning the ENTER/EXIT Programming Mode bar code.



★ Code 32 Check Character Transmission = Disable



Code 32 Check Character Transmission = Enable

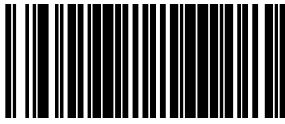

ENTER/EXIT PROGRAMMING MODE

---

## Code 128

### Code 128 Enable

Enables/disables the ability of the scanner to decode Code 128 labels.

To set this feature:

1. Scan the ENTER/EXIT Programming Mode bar code.
2. Scan either the enable or disable bar code below. You'll need to cover any unused bar codes on this and the facing page to ensure that the scanner reads only the bar code you intend to scan.
3. Complete the programming sequence by scanning the ENTER/EXIT Programming Mode bar code.



Code 128 = Disable



★ Code 128 = Enable



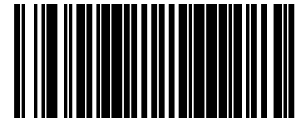

## Code 128 Transmit Function Characters

Enables/disables transmission of Code 128 function characters 1, 2, 3, and 4.



**NOTE: Disabled is the recommended setting for all interfaces.**

To set this feature:

1. Scan the ENTER/EXIT Programming Mode bar code.
2. Scan either the enable or disable bar code below. You'll need to cover any unused bar codes on this and the facing page to ensure that the scanner reads only the bar code you intend to scan.
3. Complete the programming sequence by scanning the ENTER/EXIT Programming Mode bar code.



★ Code 128 Transmit Function Characters = Disable



Code 128 Transmit Function Characters = Enable

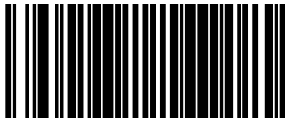

## Expand Code128 to Code 39

Enables/disables expansion of Code 128 labels to Code 39.

To set this feature:

1. Scan the ENTER/EXIT Programming Mode bar code.
2. Scan either the enable or disable bar code below. You'll need to cover any unused bar codes on this and the facing page to ensure that the scanner reads only the bar code you intend to scan.
3. Complete the programming sequence by scanning the ENTER/EXIT Programming Mode bar code.

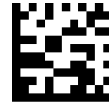

★ Expand Code128 to Code 39 = Disable



Expand Code128 to Code 39 = Enable

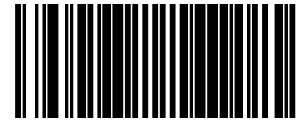

## Code 128 Minimum Read

This feature specifies the minimum number of consecutive Code 128 decodes before is accepted as good read.

To set this feature:

1. Scan the ENTER/EXIT Programming Mode bar code.
2. Scan your selection from the bar codes below. You'll need to cover any unused bar codes on this and the facing page to ensure that the scanner reads only the bar code you intend to scan.
3. Complete the programming sequence by scanning the ENTER/EXIT Programming Mode bar code.



★ Code 128 Minimum Read = 1



Code 128 Minimum Read = 2



Code 128 Minimum Read = 3



Code 128 Minimum Read = 4

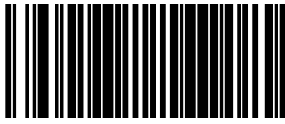

## Code 128 Length Control

This feature specifies whether variable-length or fixed-length decoding will be set for Code 128.

To set this feature:

1. Scan the ENTER/EXIT Programming Mode bar code.
2. Scan your selection from the bar codes below. You'll need to cover any unused bar codes on this and the facing page to ensure that the scanner reads only the bar code you intend to scan.
3. Complete the programming sequence by scanning the ENTER/EXIT Programming Mode bar code.



★ Code 128 Length Control = Variable Length



Code 128 Length Control = Fixed Length

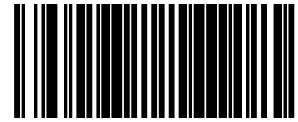

## Code 128 Length 1

If Code 128 Length Control is set to Fixed-Length decoding, this feature specifies Code 128 first fixed length. If Code 128 Length Control is set to Variable-Length decoding, this feature specifies the minimum label length.

To set this feature:

1. Scan the ENTER/EXIT Programming Mode bar code.
2. Scan the bar code, [Set Code 128 Length 1](#) below. You'll need to cover any unused bar codes on this and the facing page to ensure that the scanner reads only the bar code you intend to scan.
3. Scan the appropriate digits from the [Alpha-Numeric Keypad in Appendix C](#) that represent the desired label length. The selectable range for this option is 01 to 80. Pad all single digit numbers with a leading zero to yield a two-digit entry (01-80).
4. Complete the programming sequence by scanning the ENTER/EXIT Programming Mode bar code.

★ Default setting for this feature = 01



Set Code 128 Length 1

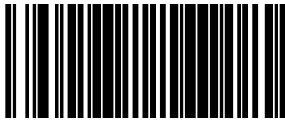

## Code 128 Length 2

If Code 128 Length Control is set to Fixed-Length decoding, this feature specifies Code 128 second fixed length. If Code 128 Length Control is set to Variable-Length decoding, this feature specifies the maximum label length.



**NOTE: When in Fixed Length mode, if Length 2 is set to the value of 00 (zero), then only Length 1 will apply.**

To set this feature:

1. Scan the ENTER/EXIT Programming Mode bar code.
2. Scan the bar code, [Set Code 128 Length 2](#) below. You'll need to cover any unused bar codes on this and the facing page to ensure that the scanner reads only the bar code you intend to scan.
3. Scan the appropriate digits from the [Alpha-Numeric Keypad in Appendix C](#) that represent the desired label length. The selectable range for this option is 01 to 80. Pad all single digit numbers with a leading zero to yield a two-digit entry (01-80).
4. Complete the programming sequence by scanning the ENTER/EXIT Programming Mode bar code.

★ Default setting for this feature = 50 (length = 80)



Set Code 128 Length 2

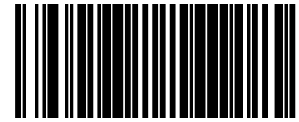

## Code 128 Stitching

Enables/disables stitching for Code 128 labels. When parts of a Code 128 bar code are presented to the scanner with this feature enabled, the bar code parts will be assembled by the scanner's software, and the data will be decoded if all bar code proofing requirements are met.

To set this feature:

1. Scan the ENTER/EXIT Programming Mode bar code.
2. Scan your selection from the bar codes below. You'll need to cover any unused bar codes on this and the facing page to ensure that the scanner reads only the bar code you intend to scan.
3. Complete the programming sequence by scanning the ENTER/EXIT Programming Mode bar code.



Code 128 Stitching = Disable



★ Code 128 Stitching = Enable

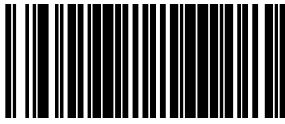

## EAN-128

### EAN-128 Enable

Enables/disables the ability of the scanner to translate EAN128 labels to the EAN128 data format.

To set this feature:

1. Scan the ENTER/EXIT Programming Mode bar code.
2. Scan either the enable or disable bar code below. You'll need to cover any unused bar codes on this and the facing page to ensure that the scanner reads only the bar code you intend to scan.
3. Complete the programming sequence by scanning the ENTER/EXIT Programming Mode bar code.



★ EAN-128 = Transmit EAN128 labels in Code128 data format



EAN-128 = Transmit EAN128 labels in EAN128 data format



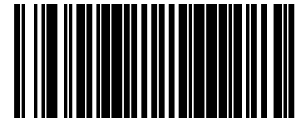

## Interleaved 2 of 5 (I 2 OF 5)

### Interleaved 2 of 5 (I 2 OF 5) Enable

Enables/disables the ability of the scanner to decode Interleaved 2 of 5 labels.

To set this feature:

1. Scan the ENTER/EXIT Programming Mode bar code.
2. Scan either the enable or disable bar code below. You'll need to cover any unused bar codes on this and the facing page to ensure that the scanner reads only the bar code you intend to scan.
3. Complete the programming sequence by scanning the ENTER/EXIT Programming Mode bar code.



★ I 2 of 5 = Disable



I 2 of 5 = Enable

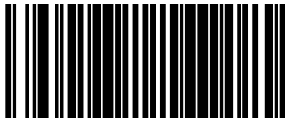

## I 2 of 5 Check Character Calculation

Enables/disables calculation and verification of an optional Interleaved 2 of 5 check character.



**NOTE: If check character calculation is disabled, the risk is increased that a misread can occur. When disabled, any check characters in a bar code are treated as data characters.**

1. To set this feature:
2. Scan the ENTER/EXIT Programming Mode bar code.
3. Scan either the enable or disable bar code below. You'll need to cover any unused bar codes on this and the facing page to ensure that the scanner reads only the bar code you intend to scan.
4. Complete the programming sequence by scanning the ENTER/EXIT Programming Mode bar code.



★ I 2 of 5 Check Character Calculation = Disable

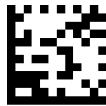

I 2 of 5 Check Character Calculation = Enable

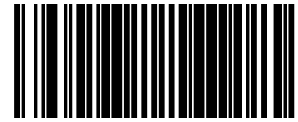

## I 2 of 5 Check Character Transmission

Enables/disables transmission of an optional Interleaved 2 of 5 check character.



**NOTE: This feature applies only when I 2 of 5 Check Character Calculation is enabled. This item is ignored when the advanced feature, Full Label Edit, is enabled.**

To set this feature:

1. Scan the ENTER/EXIT Programming Mode bar code.
2. Scan either the enable or disable bar code below. You'll need to cover any unused bar codes on this and the facing page to ensure that the scanner reads only the bar code you intend to scan.
3. Complete the programming sequence by scanning the ENTER/EXIT Programming Mode bar code.



I 2 of 5 Check Character Transmission = Disable



★ I 2 of 5 Check Character Transmission = Enable

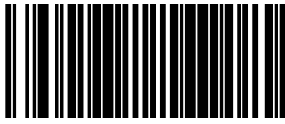

## I 2 of 5 Minimum Read

This feature specifies the minimum number of consecutive I 2 of 5 decodes before is accepted as good read.

To set this feature:

1. Scan the ENTER/EXIT Programming Mode bar code.
2. Scan your selection from the bar codes below. You'll need to cover any unused bar codes on this and the facing page to ensure that the scanner reads only the bar code you intend to scan.
3. Complete the programming sequence by scanning the ENTER/EXIT Programming Mode bar code.



★ I 2 of 5 Minimum Read = 1



I 2 of 5 Minimum Read = 2



I 2 of 5 Minimum Read = 3



I 2 of 5 Minimum Read = 4

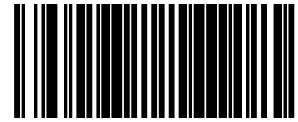

## I 2 of 5 Length Control

This feature specifies whether variable-length or fixed-length decoding will be set for I 2 of 5.

To set this feature:

1. Scan the ENTER/EXIT Programming Mode bar code.
2. Scan your selection from the bar codes below. You'll need to cover any unused bar codes on this and the facing page to ensure that the scanner reads only the bar code you intend to scan.
3. Complete the programming sequence by scanning the ENTER/EXIT Programming Mode bar code.



★ I 2 of 5 Length Control = Variable Length



I 2 of 5 Length Control = Fixed Length

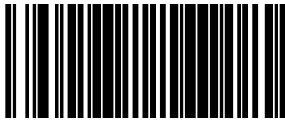

## I 2 of 5 Length 1

If I 2 of 5 Length Control is set to Fixed-Length decoding, this feature specifies I 2 of 5 first fixed length. If I 2 of 5 Length Control is set to Variable-Length decoding, this feature specifies the minimum label length.

To set this feature:

1. Scan the ENTER/EXIT Programming Mode bar code.
2. Scan the bar code, [Set I 2 of 5 Length 1](#) below. You'll need to cover any unused bar codes on this and the facing page to ensure that the scanner reads only the bar code you intend to scan.
3. Scan the appropriate digits from the [Alpha-Numeric Keypad in Appendix C](#) that represent the desired label length. The selectable range for this option is 02 to 50, even numbers only. Pad all single digit numbers with a leading zero to yield a two-digit entry (02-50).
4. Complete the programming sequence by scanning the ENTER/EXIT Programming Mode bar code.

★ Default setting for this feature = Length 06



Set I 2 of 5 Length 1

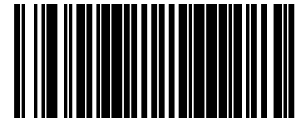

## I 2 of 5 Length 2

If I 2 of 5 Length Control is set to Fixed-Length decoding, this feature specifies I 2 of 5 second fixed length. If I 2 of 5 Length Control is set to Variable-Length decoding, this feature specifies the maximum label length.



**NOTE: When in Fixed Length mode, if Length 2 is set to the value of 00 (zero), then only Length 1 will apply.**

To set this feature:

1. Scan the ENTER/EXIT Programming Mode bar code.
2. Scan the bar code, [Set I 2 of 5 Length 2](#) below. You'll need to cover any unused bar codes on this and the facing page to ensure that the scanner reads only the bar code you intend to scan.
3. Scan the appropriate digits from the [Alpha-Numeric Keypad in Appendix C](#) that represent the desired label length. The selectable range for this option is 00, or 02 to 50; even numbers only. Pad all single digit numbers with a leading zero to yield a two-digit entry (02-50).
4. Complete the programming sequence by scanning the ENTER/EXIT Programming Mode bar code.

★ Default setting for this feature = 32 (length = 50)



Set I 2 of 5 Length 2

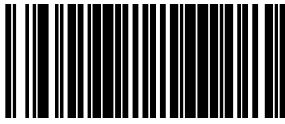

## Codabar

### Codabar Enable

Enables/disables the ability of the scanner to decode Codabar labels.

To set this feature:

1. Scan the ENTER/EXIT Programming Mode bar code.
2. Scan either the enable or disable bar code below. You'll need to cover any unused bar codes on this and the facing page to ensure that the scanner reads only the bar code you intend to scan.
3. Complete the programming sequence by scanning the ENTER/EXIT Programming Mode bar code.



★ Codabar = Disable



Codabar = Enable



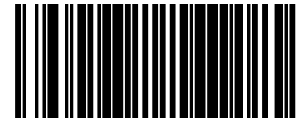

## Codabar Start Stop Character Transmission

Enables/disables transmission of Codabar start and stop characters.



**NOTE: This item is ignored when the advanced feature, Full Label Edit, is enabled.**

To set this feature:

1. Scan the ENTER/EXIT Programming Mode bar code.
2. Scan either the enable or disable bar code below. You'll need to cover any unused bar codes on this and the facing page to ensure that the scanner reads only the bar code you intend to scan.
3. Complete the programming sequence by scanning the ENTER/EXIT Programming Mode bar code.



Codabar Start Stop Character Transmission = Disable



★ Codabar Start Stop Character Transmission = Enable

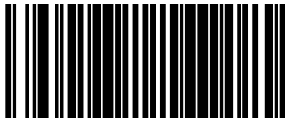

## Codabar Start Stop Character Set

This feature specifies the format of transmitted Codabar start/stop characters.

Options are:

- ABCD/TN\* E
- ABCD/ABCD
- abcd/tn\* e
- abcd/abcd

To set this feature:

1. Scan the ENTER/EXIT Programming Mode bar code.
2. Scan the bar code below or from the following page representing the desired option. You'll need to cover any unused bar codes and facing pages to ensure that the scanner reads only the bar code you intend to scan.
3. Complete the programming sequence by scanning the ENTER/EXIT Programming Mode bar code.



Codabar Start Stop Character Set = ABCD/TN\* E



Codabar Start Stop Character Set = ABCD/ABCD



Codabar Start Stop Character Set = abcd/tn\* e



★ Codabar Start Stop Character Set = abcd/abcd

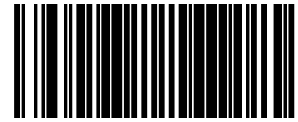

## Codabar Start Stop Character Match

Enables/disables the requirement that Codabar start and stop characters match.

To set this feature:

1. Scan the ENTER/EXIT Programming Mode bar code.
2. Scan either the enable or disable bar code below. You'll need to cover any unused bar codes on this and the facing page to ensure that the scanner reads only the bar code you intend to scan.
3. Complete the programming sequence by scanning the ENTER/EXIT Programming Mode bar code.



★ Codabar Start Stop Character Match = Disable



Codabar Start Stop Character Match = Enable

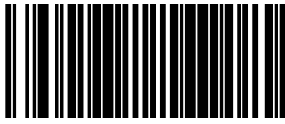

## Codabar Check Character Calculation

Enables/disables calculation and verification of an optional Codabar check character.



**NOTE: If check character calculation is disabled, the risk is increased that a misread can occur. When disabled, any check characters in a bar code are treated as data characters.**

To set this feature:

1. Scan the ENTER/EXIT Programming Mode bar code.
2. Scan either the enable or disable bar code below. You'll need to cover any unused bar codes on this and the facing page to ensure that the scanner reads only the bar code you intend to scan.
3. Complete the programming sequence by scanning the ENTER/EXIT Programming Mode bar code.

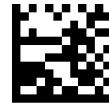

★ Codabar Check Character Calculation = Disable



Codabar Check Character Calculation = Enable

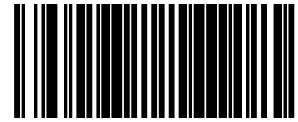

## Codabar Check Character Transmission

Enables/disables transmission of an optional Codabar check character.



**NOTE: Applies only when Codabar Check Character Calculation is enabled. This item is ignored when the advanced feature, Full Label Edit, is enabled.**

To set this feature:

1. Scan the ENTER/EXIT Programming Mode bar code.
2. Scan either the enable or disable bar code below. You'll need to cover any unused bar codes on this and the facing page to ensure that the scanner reads only the bar code you intend to scan.
3. Complete the programming sequence by scanning the ENTER/EXIT Programming Mode bar code.



Codabar Check Character Transmission = Disable



★ Codabar Check Character Transmission = Enable

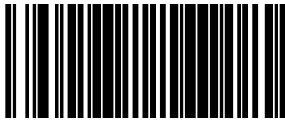

## Codabar Minimum Read

This feature specifies the minimum number of consecutive Codabar decodes before is accepted as good read.

To set this feature:

1. Scan the ENTER/EXIT Programming Mode bar code.
2. Scan your selection from the bar codes below. You'll need to cover any unused bar codes on this and the facing page to ensure that the scanner reads only the bar code you intend to scan.
3. Complete the programming sequence by scanning the ENTER/EXIT Programming Mode bar code.



★ Codabar Minimum Read = 1



Codabar Minimum Read = 2



Codabar Minimum Read = 3



Codabar Minimum Read = 4

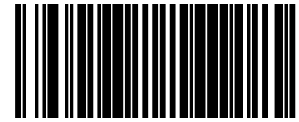

## Codabar Length Control

This feature specifies whether variable-length or fixed-length decoding will be set for Codabar.

To set this feature:

1. Scan the ENTER/EXIT Programming Mode bar code.
2. Scan your selection from the bar codes below. You'll need to cover any unused bar codes on this and the facing page to ensure that the scanner reads only the bar code you intend to scan.
3. Complete the programming sequence by scanning the ENTER/EXIT Programming Mode bar code.



★ Codabar Length Control = Variable Length



Codabar Length Control = Fixed Length

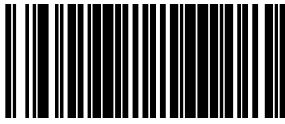

## Codabar Length 1

If Codabar Length Control is set to Fixed-Length decoding, this feature specifies Codabar first fixed length. If Codabar Length Control is set to Variable-Length decoding, this feature specifies the minimum label length.

To set this feature:

1. Scan the ENTER/EXIT Programming Mode bar code.
2. Scan the bar code, [Set Codabar Length 1](#) below. You'll need to cover any unused bar codes on this and the facing page to ensure that the scanner reads only the bar code you intend to scan.
3. Scan the appropriate digits from the [Alpha-Numeric Keypad in Appendix C](#) that represent the desired label length. The selectable range for this option is 03 to 50. Pad all single digit numbers with a leading zero to yield a two-digit entry (03-50).
4. Complete the programming sequence by scanning the ENTER/EXIT Programming Mode bar code.

★ Default setting for this feature = 03



Set Codabar Length 1



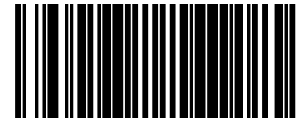

## Codabar Length 2

If Codabar Length Control is set to Fixed-Length decoding, this feature specifies Codabar second fixed length. If Codabar Length Control is set to Variable-Length decoding, this feature specifies the maximum label length.



**NOTE: When in Fixed Length mode, if Length 2 is set to the value of 00 (zero), then only Length 1 will apply.**

To set this feature:

1. Scan the ENTER/EXIT Programming Mode bar code.
2. Scan the bar code, [Set Codabar Length 2](#) below. You'll need to cover any unused bar codes on this and the facing page to ensure that the scanner reads only the bar code you intend to scan.
3. Scan the appropriate digits from the [Alpha-Numeric Keypad in Appendix C](#) that represent the desired label length. The selectable range for this option is 00 (meaning ignore this length), or 03 to 50. Pad all single digit numbers with a leading zero to yield a two-digit entry (03-50).
4. Complete the programming sequence by scanning the ENTER/EXIT Programming Mode bar code.

★ Default setting for this feature is Length = 32 (length = 50)



Set Codabar Length 2

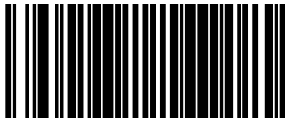

## Codabar Require Margins

Enables/disables the requirement that quiet zones be present in a Codabar bar code.

To set this feature:

1. Scan the ENTER/EXIT Programming Mode bar code.
2. Scan either the enable or disable bar code below. You'll need to cover any unused bar codes on this and the facing page to ensure that the scanner reads only the bar code you intend to scan.
3. Complete the programming sequence by scanning the ENTER/EXIT Programming Mode bar code.



★ Codabar Require Margins = Quiet Zones Not Required



Codabar Require Margins = Quiet Zones Required

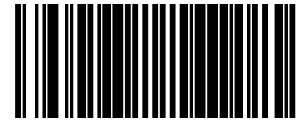

## Code 93

### Code 93 Enable

Enables/disables the ability of the scanner to decode Code 93 labels.

To set this feature:

1. Scan the ENTER/EXIT Programming Mode bar code.
2. Scan either the enable or disable bar code below. You'll need to cover any unused bar codes on this and the facing page to ensure that the scanner reads only the bar code you intend to scan.
3. Complete the programming sequence by scanning the ENTER/EXIT Programming Mode bar code.



★ Code 93 = Disable



Code 93 = Enable

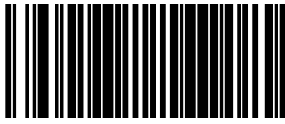

## Code 93 Minimum Read

This feature specifies the minimum number of consecutive Code 93 decodes before is accepted as good read.

To set this feature:

1. Scan the ENTER/EXIT Programming Mode bar code.
2. Scan your selection from the bar codes below. You'll need to cover any unused bar codes on this and the facing page to ensure that the scanner reads only the bar code you intend to scan.
3. Complete the programming sequence by scanning the ENTER/EXIT Programming Mode bar code.



★ Code 93 Minimum Read = 1



Code 93 Minimum Read = 2



Code 93 Minimum Read = 3



Code 93 Minimum Read = 4

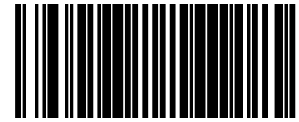

## Code 93 Length Control

This feature specifies whether variable-length or fixed-length decoding will be set for Code 93.

To set this feature:

1. Scan the ENTER/EXIT Programming Mode bar code.
2. Scan your selection from the bar codes below. You'll need to cover any unused bar codes on this and the facing page to ensure that the scanner reads only the bar code you intend to scan.
3. Complete the programming sequence by scanning the ENTER/EXIT Programming Mode bar code.



★ Code 93 Length Control = Variable Length



Code 93 Length Control = Fixed Length

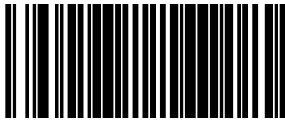

## Code 93 Length 1

If Code 93 Length Control is set to Fixed-Length decoding, this feature specifies Code 93 first fixed length. If Code 93 Length Control is set to Variable-Length decoding, this feature specifies the minimum label length.

To set this feature:

1. Scan the ENTER/EXIT Programming Mode bar code.
2. Scan the bar code, [Set Code 93 Length 1](#) below. You'll need to cover any unused bar codes on this and the facing page to ensure that the scanner reads only the bar code you intend to scan.
3. Scan the appropriate digits from the [Alpha-Numeric Keypad in Appendix C](#) that represent the desired label length. The selectable range for this option is 01 to 50. Pad all single digit numbers with a leading zero to yield a two-digit entry (01-50).
4. Complete the programming sequence by scanning the ENTER/EXIT Programming Mode bar code.

★ Default setting for this feature = 01

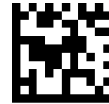

Set Code 93 Length 1

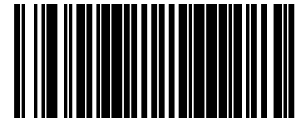

## Code 93 Length 2

If Code 93 Length Control is set to Fixed-Length decoding, this feature specifies Code 93 second fixed length. If Code 93 Length Control is set to Variable-Length decoding, this feature specifies the maximum label length.



**NOTE: When in Fixed Length mode, if Fixed Length 2 is set to the value of 00 (zero), then only Length 1 will apply.**

To set this feature:

1. Scan the ENTER/EXIT Programming Mode bar code.
2. Scan the bar code, [Set Code 93 Length 2](#) below. You'll need to cover any unused bar codes on this and the facing page to ensure that the scanner reads only the bar code you intend to scan.
3. Scan the appropriate digits from the [Alpha-Numeric Keypad in Appendix C](#) that represent the desired label length. The selectable range for this option is 00 (meaning ignore this length), or 01 to 50. Pad all single digit numbers with a leading zero to yield a two-digit entry (01-50).
4. Complete the programming sequence by scanning the ENTER/EXIT Programming Mode bar code.

★ Default setting for this feature = 32 (length = 50)



Set Code 93 Length 2

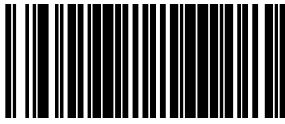

## MSI

### MSI Enable

Enables/disables the ability of the scanner to decode MSI labels.

To set this feature:

1. Scan the ENTER/EXIT Programming Mode bar code.
2. Scan either the enable or disable bar code below. You'll need to cover any unused bar codes on this and the facing page to ensure that the scanner reads only the bar code you intend to scan.
3. Complete the programming sequence by scanning the ENTER/EXIT Programming Mode bar code.



★ MSI = Disable



MSI = Enable



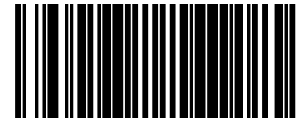

## MSI Check Character Calculation

Enables/disables calculation and verification of optional MSI check characters.



**NOTE: If check character calculation is disabled, the risk is increased that a misread can occur. When disabled, any check characters in a bar code are treated as data characters.**

To set this feature:

1. Scan the ENTER/EXIT Programming Mode bar code.
2. Scan either the enable or disable bar code below. You'll need to cover any unused bar codes on this and the facing page to ensure that the scanner reads only the bar code you intend to scan.
3. Complete the programming sequence by scanning the ENTER/EXIT Programming Mode bar code.



MSI Check Character Calculation = Disable



★ MSI Check Character Calculation = Enable

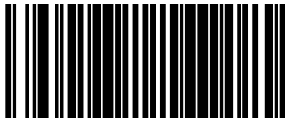

ENTER/EXIT PROGRAMMING MODE

---

## MSI Number of Check Characters

Specifies number of MSI check characters to be calculated and verified.



**NOTE: Check characters are always modulus 10.**

To set this feature:

1. Scan the ENTER/EXIT Programming Mode bar code.
2. Scan the bar code below representing the desired number of MSI check characters to be calculated and verified. You'll need to cover any unused bar codes on this and the facing page to ensure that the scanner reads only the bar code you intend to scan.
3. Complete the programming sequence by scanning the ENTER/EXIT Programming Mode bar code.



★ MSI Number of Check Characters = 1



MSI Number of Check Characters = 2

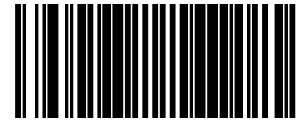

## MSI Check Character Transmission

Enables/disables transmission of optional MSI check characters.



**NOTE: This feature applies only when MSI Check Character Calculation is enabled. This item is ignored when the advanced feature, Full Label Edit, is enabled.**

To set this feature:

1. Scan the ENTER/EXIT Programming Mode bar code.
2. Scan either the enable or disable bar code below. You'll need to cover any unused bar codes on this and the facing page to ensure that the scanner reads only the bar code you intend to scan.
3. Complete the programming sequence by scanning the ENTER/EXIT Programming Mode bar code.



MSI Check Character Transmission = Disable



★ MSI Check Character Transmission = Enable

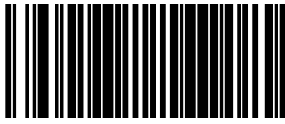

## MSI Minimum Read

This feature specifies the minimum number of consecutive MSI decodes before is accepted as good read.

To set this feature:

1. Scan the ENTER/EXIT Programming Mode bar code.
2. Scan your selection from the bar codes below. You'll need to cover any unused bar codes on this and the facing page to ensure that the scanner reads only the bar code you intend to scan.
3. Complete the programming sequence by scanning the ENTER/EXIT Programming Mode bar code.



★ MSI Minimum Read = 1



MSI Minimum Read = 2



MSI Minimum Read = 3



MSI Minimum Read = 4

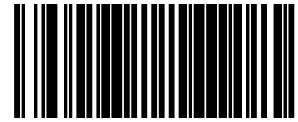

## MSI Length Control

This feature specifies whether variable-length or fixed-length decoding will be set for MSI.

To set this feature:

1. Scan the ENTER/EXIT Programming Mode bar code.
2. Scan your selection from the bar codes below. You'll need to cover any unused bar codes on this and the facing page to ensure that the scanner reads only the bar code you intend to scan.
3. Complete the programming sequence by scanning the ENTER/EXIT Programming Mode bar code.



★ MSI Length Control = Variable Length



MSI Length Control = Fixed Length

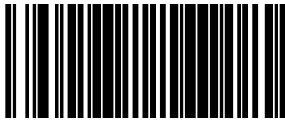

## MSI Length 1

If MSI Length Control is set to Fixed-Length decoding, this feature specifies MSI first fixed length. If MSI Length Control is set to Variable-Length decoding, this feature specifies the minimum label length.

To set this feature:

1. Scan the ENTER/EXIT Programming Mode bar code.
2. Scan the bar code below. You'll need to cover any unused bar codes on this and the facing page to ensure that the scanner reads only the bar code you intend to scan.
3. Scan the appropriate digits from the [Alpha-Numeric Keypad in Appendix C](#) that represent the desired label length. The selectable range for this option is 4 to 16. Pad all single digit numbers with a leading zero to yield a two-digit entry (04-16).
4. Complete the programming sequence by scanning the ENTER/EXIT Programming Mode bar code.

★ Default setting for this feature = 04



Set MSI Length 1

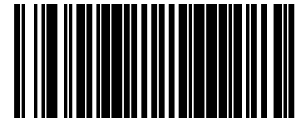

## MSI Length 2

If MSI Length Control is set to Fixed-Length decoding, this feature specifies MSI second fixed length. If MSI Length Control is set to Variable-Length decoding, this feature specifies the maximum label length.



**NOTE: When in Fixed Length mode, if Length 2 is set to the value 00 (zero), then only Length 1 will apply.**

To set this feature:

1. Scan the ENTER/EXIT Programming Mode bar code.
2. Scan the bar code, [Set MSI Length 2](#) below. You'll need to cover any unused bar codes on this and the facing page to ensure that the scanner reads only the bar code you intend to scan.
3. Scan the appropriate digits from the [Alpha-Numeric Keypad in Appendix C](#) that represent the desired label length. The selectable range for this option is 00 (meaning ignore this length), or 04 to 16. Pad all single digit numbers with a leading zero to yield a two-digit entry (00, 04-16).
4. Complete the programming sequence by scanning the ENTER/EXIT Programming Mode bar code.

★ Default setting for this feature = 10 (length = 16)



Set MSI Length 2

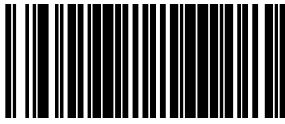

## Standard 2 of 5

### Standard 2 of 5 Enable

Enables/disables the ability of the scanner to decode Standard 2 of 5 labels.

To set this feature:

1. Scan the ENTER/EXIT Programming Mode bar code.
2. Scan either the enable or disable bar code below. You'll need to cover any unused bar codes on this and the facing page to ensure that the scanner reads only the bar code you intend to scan.
3. Complete the programming sequence by scanning the ENTER/EXIT Programming Mode bar code.



★ Standard 2 of 5 = Disable



Standard 2 of 5 = Enable



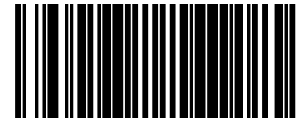

## Standard 2 of 5 Check Character Calculation

Enables/disables calculation and verification of an optional Standard 2 of 5 check character.



**NOTE: If check character calculation is disabled, the risk is increased that a misread can occur. When disabled, any check character in a bar code is treated as data character.**

To set this feature:

1. Scan the ENTER/EXIT Programming Mode bar code.
2. Scan either the enable or disable bar code below. You'll need to cover any unused bar codes on this and the facing page to ensure that the scanner reads only the bar code you intend to scan.
3. Complete the programming sequence by scanning the ENTER/EXIT Programming Mode bar code.



★ Standard 2 of 5 Check Character Calculation = Disable



Standard 2 of 5 Check Character Calculation = Enable

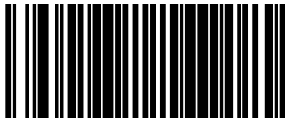

## Standard 2 of 5 Check Character Transmission

Enables/disables transmission of an optional Standard 2 of 5 check character.



**NOTE: This feature applies only when Standard 2 of 5 Check Character Calculation is enabled. This item is ignored when the advanced feature, Full Label Edit, is enabled.**

To set this feature:

1. Scan the ENTER/EXIT Programming Mode bar code.
2. Scan either the enable or disable bar code below. You'll need to cover any unused bar codes on this and the facing page to ensure that the scanner reads only the bar code you intend to scan.
3. Complete the programming sequence by scanning the ENTER/EXIT Programming Mode bar code.



Standard 2 of 5 Check Character Transmission = Disable



★ Standard 2 of 5 Check Character Transmission = Enable

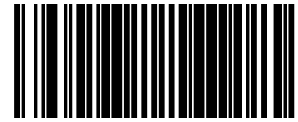

## Standard 2 of 5 Minimum Read

This feature specifies the minimum number of consecutive Standard 2 of 5 decodes before is accepted as good read.

To set this feature:

1. Scan the ENTER/EXIT Programming Mode bar code.
2. Scan your selection from the bar codes below. You'll need to cover any unused bar codes on this and the facing page to ensure that the scanner reads only the bar code you intend to scan.
3. Complete the programming sequence by scanning the ENTER/EXIT Programming Mode bar code.



★ Standard 2 of 5 Minimum Read = 1



Standard 2 of 5 Minimum Read = 2



Standard 2 of 5 Minimum Read = 3



Standard 2 of 5 Minimum Read = 4

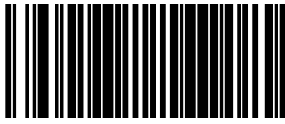

## Standard 2 of 5 Length Control

This feature specifies whether variable-length or fixed-length decoding will be set for Standard 2 of 5.

To set this feature:

1. Scan the ENTER/EXIT Programming Mode bar code.
2. Scan your selection from the bar codes below. You'll need to cover any unused bar codes on this and the facing page to ensure that the scanner reads only the bar code you intend to scan.
3. Complete the programming sequence by scanning the ENTER/EXIT Programming Mode bar code.



★ Standard 2 of 5 Length Control = Variable Length

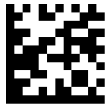

Standard 2 of 5 Length Control = Fixed Length

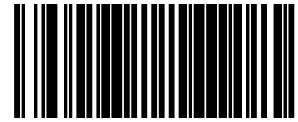

## Standard 2 of 5 Length 1

If Standard 2 of 5 Length Control is set to Fixed-Length decoding, this feature specifies Standard 2 of 5 first fixed length. If Standard 2 of 5 Length Control is set to Variable-Length decoding, this feature specifies the minimum label length.

To set this feature:

1. Scan the ENTER/EXIT Programming Mode bar code.
2. Scan the bar code, [Set Standard 2 of 5 Length 1](#) below. You'll need to cover any unused bar codes on this and the facing page to ensure that the scanner reads only the bar code you intend to scan.
3. Scan the appropriate digits from the [Alpha-Numeric Keypad in Appendix C](#) that represent the desired label length. The selectable range for this option is 1 to 50. Pad all single digit numbers with a leading zero to yield a two-digit entry (01-50).
4. Complete the programming sequence by scanning the ENTER/EXIT Programming Mode bar code.

★ Default setting for this feature = 08



Set Standard 2 of 5 Length 1

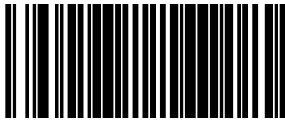

## Standard 2 of 5 Length 2

If Standard 2 of 5 Length Control is set to Fixed-Length decoding, this feature specifies Standard 2 of 5 second fixed length. If Standard 2 of 5 Length Control is set to Variable-Length decoding, this feature specifies the maximum label length.



**NOTE: When in Fixed Length mode, if Length 2 is set to the value of 00 (zero), then only Length 1 will apply.**

To set this feature:

1. Scan the ENTER/EXIT Programming Mode bar code.
2. Scan the bar code, [Set Standard 2 of 5 Length 2](#) below. You'll need to cover any unused bar codes on this and the facing page to ensure that the scanner reads only the bar code you intend to scan.
3. Scan the appropriate digits from the [Alpha-Numeric Keypad in Appendix C](#) that represent the desired label length. The selectable range for this option is 1 to 50. Pad all single digit numbers with a leading zero to yield a two-digit entry (01-50).
4. Complete the programming sequence by scanning the ENTER/EXIT Programming Mode bar code.

★ Default setting for this feature = 32 (length = 50)



Set Standard 2 of 5 Length 2

# CONFIGURATION | 2D SYMBOLOGIES / BAR CODES

## 2D CODES



**NOTE:** If the scanner's interface type must be changed, always be sure that interface configuration is the **FIRST** item scanned during a programming session. (Selecting an interface type resets **ALL** other configuration items — including symbology programming — to the factory default for that interface type.)

The following pages contain configuration information concerning the various 2D bar code types the scanner supports.

SECTION CONTENTS
<b>DATA MATRIX</b> starting on page 230
<b>PDF 417</b> starting on page 234
<b>MICRO PDF 417</b> starting on page 238
<b>QR CODE</b> starting on page 242
<b>MICRO QR CODE</b> starting on page 247
<b>AZTEC CODE</b> starting on page 250
<b>HAN XIN CODE</b> starting on page 253
<b>DOTCODE</b> starting on page 254

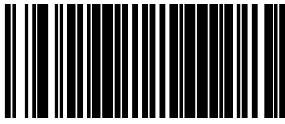

## DATA MATRIX

### Data Matrix Enable

Enables/disables the ability of the scanner to decode Data Matrix labels.

To set this feature:

1. Scan the Enter/Exit Programming Mode bar code.
2. Scan either the enable or disable bar code below. You'll need to cover any unused bar codes on this and the facing page to ensure that the scanner reads only the bar code you intend to scan.
3. Complete the programming sequence by scanning the Enter/Exit Programming Mode bar code.



★ Data Matrix = Disable



Data Matrix = Enable



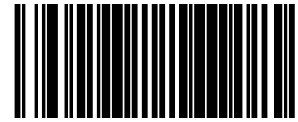

## Data Matrix Length Control

**Fixed Length Decoding:** When fixed length decoding is enabled, the scanner will decode a bar code if the label length matches one of the configurable fixed lengths.

**Variable Length Decoding:** When variable length decoding is enabled, the scanner will decode a bar code if the label length falls in the range of the configurable minimum and maximum length.

1. Scan the ENTER/EXIT Programming Mode bar code.
2. Scan the Fixed Length Decoding bar code.
3. Scan the ENTER/EXIT Programming Mode bar code.
4. Set Length 1 to the first fixed length using the [Data Matrix Length 1, Length 2 Programming Instructions](#) that follow this page.
5. Set Length 2 to the second fixed length (or to '0000' if there is only one fixed length) using the [Data Matrix Length 1, Length 2 Programming Instructions](#).

### Configuring Variable Length Decoding:

1. Scan the ENTER/EXIT Programming Mode bar code.
2. Scan the Variable Length Decoding bar code.
3. Scan the ENTER/EXIT Programming Mode bar code.
4. Set Length 1 to the minimum length using the [Data Matrix Length 1, Length 2 Programming Instructions](#) that follow this page.
5. Set Length 2 to the maximum length using the [Data Matrix Length 1, Length 2 Programming Instructions](#).



★ Data Matrix Length Control = Variable Length



Data Matrix Length Control = Fixed Length

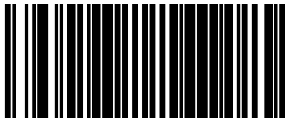

## Data Matrix Length 1, Length 2 Programming Instructions

If Data Matrix Length Control is set to Fixed-Length decoding, this feature specifies Data Matrix first fixed length. If Data Matrix Length Control is set to Variable-Length decoding, this feature specifies the minimum label length.



**NOTE: For Data Matrix bar codes, only the data characters are included in the length calculations.**

To set this feature:

1. Scan the ENTER/EXIT Programming Mode bar code.
2. Scan the bar code, [Set Data Matrix Length 1](#) or [Set Data Matrix Length 2](#) below. You'll need to cover any unused bar codes on this and the facing page to ensure that the scanner reads only the bar code you intend to scan.
3. Scan the appropriate digits from the [Alpha-Numeric Keypad in Appendix C](#) that represent the desired label length. The selectable range for this option is 0001 to 3116. Pad all numbers with leading zeros to yield a four-digit entry (0001-3116).
4. Complete the programming sequence by scanning the ENTER/EXIT Programming Mode bar code.



Set Data Matrix Length 1

★ Default setting for this feature = 0001



Set Data Matrix Length 2

★ Default setting for this feature = 0320 (length = 800)

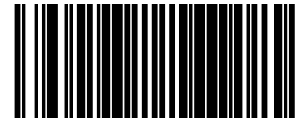

## GS1 Datamatrix Enable

Enables/disables the ability of the scanner to decode GS1 Datamatrix labels.

Four settings are available for this feature:

- 00=Transmit GS1 Datamatrix labels as standard Datamatrix labels
- 01=Transmit GS1 Datamatrix labels as GS1 Datamatrix labels
- 02=Do not decode GS1 Datamatrix labels
- 03=Transmit GS1 Datamatrix labels as GS1 Datamatrix labels. Do not decode standard Datamatrix labels.

To set this feature:

1. Scan the Enter/Exit Programming Mode bar code.
2. Scan your selection from the bar codes below. Cover any unused bar codes on this and the facing page to ensure that the scanner reads only the bar code you intend to scan.
3. Complete the programming sequence by scanning the Enter/Exit Programming Mode bar code.



★ Transmit GS1 Datamatrix labels as standard Datamatrix labels



Transmit GS1 Datamatrix labels as GS1 Datamatrix labels



Do not decode GS1 Datamatrix labels



Transmit GS1 Datamatrix labels as GS1 Datamatrix labels. Do not decode standard Datamatrix labels

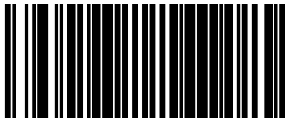

## PDF 417

### PDF 417 Enable

Enables the processing of PDF417 labels.

To set this feature:

1. Scan the Enter/Exit Programming Mode bar code.
2. Scan either the enable or disable bar code below. You'll need to cover any unused bar codes on this and the facing page to ensure that the scanner reads only the bar code you intend to scan.
3. Complete the programming sequence by scanning the Enter/Exit Programming Mode bar code.



PDF 417 = Disable



★ PDF 417 = Enable

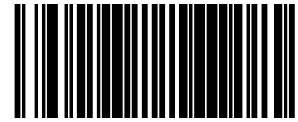

## PDF 417 Length Control

**Fixed Length Decoding:** When fixed length decoding is enabled, the scanner will decode a bar code if the label length matches one of the configurable fixed lengths.

**Variable Length Decoding:** When variable length decoding is enabled, the scanner will decode a bar code if the label length falls in the range of the configurable minimum and maximum length.

Configuring Fixed Length Decoding:

1. Scan the ENTER/EXIT Programming Mode bar code.
2. Scan the Fixed Length Decoding bar code.
3. Scan the ENTER/EXIT Programming Mode bar code.
4. Set Length 1 to the first fixed length using the [PDF 417 Length 1, Length 2 Programming Instructions](#) that follow this page.
5. Set Length 2 to the second fixed length (or to '0000' if there is only one fixed length) using the [PDF 417 Length 1, Length 2 Programming Instructions](#).

Configuring Variable Length Decoding:

1. Scan the ENTER/EXIT Programming Mode bar code.
2. Scan the Variable Length Decoding bar code.
3. Scan the ENTER/EXIT Programming Mode bar code.
4. Set Length 1 to the minimum length using the [PDF 417 Length 1, Length 2 Programming Instructions](#) that follow this page.
5. Set Length 2 to the maximum length using the [PDF 417 Length 1, Length 2 Programming Instructions](#).



★ PDF 417 Length Control = Variable Length



PDF 417 Length Control = Fixed Length

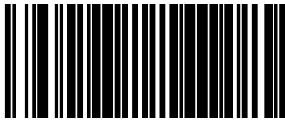

## PDF 417 Length 1, Length 2 Programming Instructions

If PDF417 Length Control is set to Fixed-Length decoding, this feature specifies PDF417 first fixed length. If PDF417 Length Control is set to Variable-Length decoding, this feature specifies the minimum label length.



**NOTE: This tag is only valid for units with a model id that supports PDF.**

**Length 1 is the minimum label length if in variable length mode, or the first fixed length if in fixed length mode. Length 2 is the maximum label length if in variable length mode, or the second fixed length if in fixed length mode. Length includes the bar code's data characters only. Any value > 2710 will be considered to be 2710.**

To set this feature:

1. Scan the ENTER/EXIT Programming Mode bar code.
2. Scan the bar code, [Set PDF 417 Length 1](#) or [Set PDF 417 Length 2](#) below. You'll need to cover any unused bar codes on this and the facing page to ensure that the scanner reads only the bar code you intend to scan.
3. Scan the appropriate digits from the [Alpha-Numeric Keypad in Appendix C](#) that represent the desired label length. The selectable range for this option is 0001 to 2710. Pad all numbers with leading zeros to yield a four-digit entry (0001-2710).
4. Complete the programming sequence by scanning the ENTER/EXIT Programming Mode bar code.



Set PDF 417 Length 1

★ Default setting for this feature = 0001



Set PDF 417 Length 2

★ Default setting for this feature =  
0A96 (length = 2710)

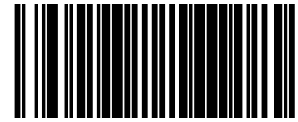

## PDF 417 Read Option

This feature specifies an additional read control option for PDF 417 bar codes.

To set this feature:

1. Scan the Enter/Exit Programming Mode bar code.
2. Scan either the enable or disable bar code below. You'll need to cover any unused bar codes on this and the facing page to ensure that the scanner reads only the bar code you intend to scan.
3. Complete the programming sequence by scanning the Enter/Exit Programming Mode bar code.



★ PDF 417 Read Option = None



PDF 417 Read Option = Turn Off Codeword  
Length Checking

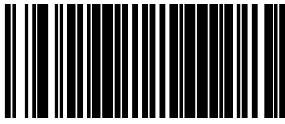

## MICRO PDF 417

### Micro PDF 417 Enable

Enables/disables the ability of the scanner to decode Micro PDF 417 labels.

To set this feature:

1. Scan the Enter/Exit Programming Mode bar code.
2. Scan either the enable or disable bar code below. You'll need to cover any unused bar codes on this and the facing page to ensure that the scanner reads only the bar code you intend to scan.
3. Complete the programming sequence by scanning the Enter/Exit Programming Mode bar code.



★ Micro PDF 417 = Disable



Micro PDF 417 = Enable



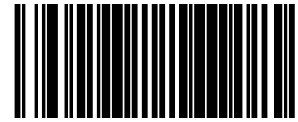

## Micro PDF 417 Length Control

**Fixed Length Decoding:** When fixed length decoding is enabled, the scanner will decode a bar code if the label length matches one of the configurable fixed lengths.

**Variable Length Decoding:** When variable length decoding is enabled, the scanner will decode a bar code if the label length falls in the range of the configurable minimum and maximum length.

Configuring Fixed Length Decoding:

1. Scan the ENTER/EXIT Programming Mode bar code.
2. Scan the Fixed Length Decoding bar code.
3. Scan the ENTER/EXIT Programming Mode bar code.
4. Set Length 1 to the first fixed length using the [Micro PDF 417 Length 1, Length 2 Programming Instructions](#) that follow this page.
5. Set Length 2 to the second fixed length (or to '0000' if there is only one fixed length) using the [Micro PDF 417 Length 1, Length 2 Programming Instructions](#).

Configuring Variable Length Decoding:

1. Scan the ENTER/EXIT Programming Mode bar code.
2. Scan the Variable Length Decoding bar code.
3. Scan the ENTER/EXIT Programming Mode bar code.
4. Set Length 1 to the minimum length using the [Micro PDF 417 Length 1, Length 2 Programming Instructions](#) that follow this page.
5. Set Length 2 to the maximum length using the [Micro PDF 417 Length 1, Length 2 Programming Instructions](#).



★ Micro PDF 417 Length Control = Variable Length



Micro PDF 417 Length Control = Fixed Length

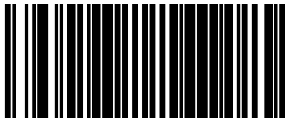

## Micro PDF 417 Length 1, Length 2 Programming Instructions

If Micro PDF 417 Length Control is set to Fixed-Length decoding, this feature specifies Micro PDF 417 first fixed length. If Micro PDF 417 Length Control is set to Variable-Length decoding, this feature specifies the minimum label length.



**NOTE: This tag is only valid for units with a model ID that supports PDF.**

**Length 1 is the minimum label length if in variable length mode, or the first fixed length if in fixed length mode. Length 2 is the maximum label length if in variable length mode, or the second fixed length if in fixed length mode. Length includes the bar code's data characters only. Any value > 0366 will be considered to be 0366.**

To set this feature:

1. Scan the ENTER/EXIT Programming Mode bar code.
2. Scan the bar code, [Set Micro PDF 417 Length 1](#) or [Set Micro PDF 417 Length 2](#) below. You'll need to cover any unused bar codes on this and the facing page to ensure that the scanner reads only the bar code you intend to scan.
3. Scan the appropriate digits from the [Alpha-Numeric Keypad in Appendix C](#) that represent the desired label length. The selectable range for this option is 0001 to 0366. Pad all numbers with leading zeros to yield a four-digit entry (0001-0366).
4. Complete the programming sequence by scanning the ENTER/EXIT Programming Mode bar code.



Set Micro PDF 417 Length 1  
★ Default setting for this feature = 0001



Set Micro PDF 417 Length 2  
★ Default setting for this feature = 016E (length = 366)

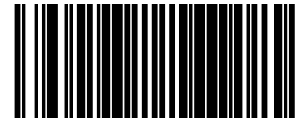

## Micro PDF 417 128 Emulation

This feature specifies which AIM ID to use for Micro PDF 417 labels when performing Code 128 or EAN 128 emulation.

To set this feature:

1. Scan the Enter/Exit Programming Mode bar code.
2. Scan the bar code below for the desired setting. You'll need to cover any unused bar codes on this and the facing page to ensure that the scanner reads only the bar code you intend to scan.
3. Complete the programming sequence by scanning the Enter/Exit Programming Mode bar code.



★ Micro PDF 417 128 Emulation = Micro PDF AIM ID and label type when emulating EAN128 or Code 128



Micro PDF 417 128 Emulation = Code 128 / EAN128  
AIM ID and label type when emulating EAN128 or Code  
128

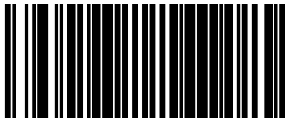

## QR CODE

### QR Code Enable

Enables/disables the ability of the scanner to decode QR Code labels.

To set this feature:

1. Scan the Enter/Exit Programming Mode bar code.
2. Scan your selection from the bar codes below. You'll need to cover any unused bar codes on this and the facing page to ensure that the scanner reads only the bar code you intend to scan.
3. Complete the programming sequence by scanning the Enter/Exit Programming Mode bar code.



★ QR Code = Disable



QR Code = Enable

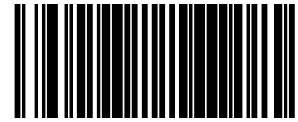

## QR Code Length Control

**Fixed Length Decoding:** When fixed length decoding is enabled, the scanner will decode a bar code if the label length matches one of the configurable fixed lengths.

**Variable Length Decoding:** When variable length decoding is enabled, the scanner will decode a bar code if the label length falls in the range of the configurable minimum and maximum length.

Configuring Fixed Length Decoding:

1. Scan the ENTER/EXIT Programming Mode bar code.
2. Scan the Fixed Length Decoding bar code.
3. Scan the ENTER/EXIT Programming Mode bar code.
4. Set Length 1 to the first fixed length using the [QR Code Length 1, Length 2 Programming Instructions](#) that follow this page.
5. Set Length 2 to the second fixed length (or to '0000' if there is only one fixed length) using the [QR Code Length 1, Length 2 Programming Instructions](#).

Configuring Variable Length Decoding:

1. Scan the ENTER/EXIT Programming Mode bar code.
2. Scan the Variable Length Decoding bar code.
3. Scan the ENTER/EXIT Programming Mode bar code.
4. Set Length 1 to the minimum length using the [QR Code Length 1, Length 2 Programming Instructions](#) that follow this page.
5. Set Length 2 to the maximum length using the [QR Code Length 1, Length 2 Programming Instructions](#).



★ QR Code Length Control = Variable Length



QR Code Length Control = Fixed Length

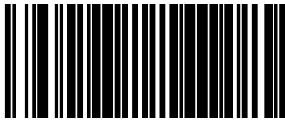

## QR Code Length 1, Length 2 Programming Instructions

If QR Code Length Control is set to Fixed-Length decoding, this feature specifies QR Code first fixed length. If QR Code Length Control is set to Variable-Length decoding, this feature specifies the minimum label length.



**NOTE: Length 1 is the minimum label length if in variable length mode, or the first fixed length if in fixed length mode. Length 2 is the maximum label length if in variable length mode, or the second fixed length if in fixed length mode. Length includes the bar code's data characters only. Any value > 2710 will be considered to be 2710.**

To set this feature:

1. Scan the ENTER/EXIT Programming Mode bar code.
2. Scan the bar code, [Set QR Code Length 1](#) or [Set QR Code Length 2](#) below. You'll need to cover any unused bar codes on this and the facing page to ensure that the scanner reads only the bar code you intend to scan.
3. Scan the appropriate digits from the [Alpha-Numeric Keypad in Appendix C](#) that represent the desired label length. The selectable range for this option is 0001 to 2710. Pad all numbers with leading zeros to yield a four-digit entry (001-02710).
4. Complete the programming sequence by scanning the ENTER/EXIT Programming Mode bar code.



Set QR Code Length 1

★ Default setting for this feature = 0001



Set QR Code Length 2

★ Default setting for this feature = 0A96 (length = 2710)

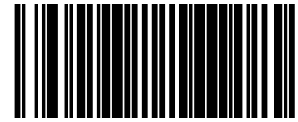

## QR Code URL Link Enable

Enables/Disables the decoding of QR codes with a URL link on imagers other than the optional Customer Service Scanner (CSS).

To set this feature:

1. Scan the Enter/Exit Programming Mode bar code.
2. Scan your selection from the bar codes below. Cover any unused bar codes on this and the facing page to ensure that the scanner reads only the bar code you intend to scan.
3. Complete the programming sequence by scanning the Enter/Exit Programming Mode bar code.



★ QR Code URL Link = Disable



QR Code URL Link = Enable

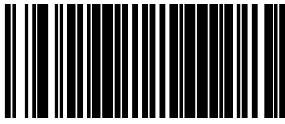

## GS1 QR Code Enable

This feature controls the ability of the scanner to decode GS1 QR Code labels.

Four settings are available:

- 00=Transmit GS1 QRCode labels as standard QRCode labels
- 01=Transmit GS1 QRCode labels as GS1 QRCode labels. Decode standard QRCode labels and transmit as standard QRCode labels.
- 02=Do not decode GS1 QRCode labels
- 03=Transmit GS1 QRCode labels as GS1 QRCode labels. Do not decode standard QRCode labels.

To set this feature:

1. Scan the Enter/Exit Programming Mode bar code.
2. Scan your selection from the bar codes below. Cover unused bar codes if needed, to ensure that the scanner reads only the bar code you intend to scan.
3. Complete the programming sequence by scanning the Enter/Exit Programming Mode bar code.



★ GS1 QR Code = 00 Transmit GS1 QRCode labels as standard QR Code labels



GS1 QR Code = 01 Transmit GS1 QRCode labels as GS1 QRCode labels. Decode standard QRCode labels and transmit as standard QRCode labels



GS1 QR Code = 02 Do not decode GS1 QRCode labels



GS1 QR Code = 03 Transmit GS1 QRCode labels as GS1 QRCode labels. Do not decode standard QRCode labels



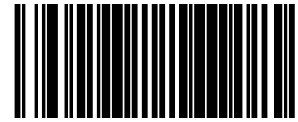

## MICRO QR CODE

### Micro QR Code Enable

Enables/disables the ability of the scanner to decode Micro QRCode labels.

To set this feature:

1. Scan the Enter/Exit Programming Mode bar code.
2. Scan your selection from the bar codes below. Cover any unused bar codes on this and the facing page to ensure that the scanner reads only the bar code you intend to scan.
3. Complete the programming sequence by scanning the Enter/Exit Programming Mode bar code.



★ Micro QR Code = Disable

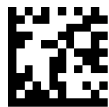

Micro QR Code = Enable

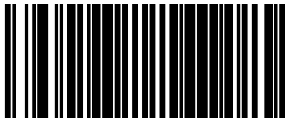

## Micro QR Code Length Control

**Fixed Length Decoding:** When fixed length decoding is enabled, the scanner will decode a bar code if the label length matches one of the configurable fixed lengths.

**Variable Length Decoding:** When variable length decoding is enabled, the scanner will decode a ar code if the label length falls in the range of the configurable minimum and maximum length.

Configuring Fixed Length Decoding:

1. Scan the ENTER/EXIT Programming Mode bar code.
2. Scan the Fixed Length Decoding bar code.
3. Scan the ENTER/EXIT Programming Mode bar code.
4. Set Length 1 to the first fixed length using the [Micro QR Code Length 1, Length 2 Programming Instructions](#) that follow this page.
5. Set Length 2 to the second fixed length (or to '0000' if there is only one fixed length) using the [Micro QR Code Length 1, Length 2 Programming Instructions](#).

Configuring Variable Length Decoding:

1. Scan the ENTER/EXIT Programming Mode bar code.
2. Scan the Variable Length Decoding bar code.
3. Scan the ENTER/EXIT Programming Mode bar code.
4. Set Length 1 to the minimum length using the [Micro QR Code Length 1, Length 2 Programming Instructions](#) that follow this page.
5. Set Length 2 to the maximum length using the [Micro QR Code Length 1, Length 2 Programming Instructions](#).



★ Micro QR Code Length Control = Variable Length



Micro QR Code Length Control = Fixed Length

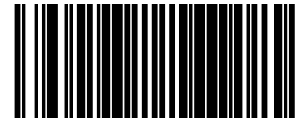

## Micro QR Code Length 1, Length 2 Programming Instructions

If Micro QR Code Length Control is set to Fixed-Length decoding, this feature specifies Micro QR Code first fixed length. If Micro QR Code Length Control is set to Variable-Length decoding, this feature specifies the minimum label length.



**NOTE: Length 1 is the minimum label length if in variable length mode, or the first fixed length if in fixed length mode. Length 2 is the maximum label length if in variable length mode, or the second fixed length if in fixed length mode. Length includes the bar code's data characters only. Any value > 3700 will be considered to be 3700.**

To set this feature:

1. Scan the ENTER/EXIT Programming Mode bar code.
2. Scan the bar code, [Set Aztec Length 1](#) or [Set Micro QR Code Length 2](#) below. You'll need to cover any unused bar codes on this and the facing page to ensure that the scanner reads only the bar code you intend to scan.
3. Scan the appropriate digits from the [Alpha-Numeric Keypad in Appendix C](#) that represent the desired label length. The selectable range for this option is 0001 to 3700. Pad all numbers with leading zeros to yield a four-digit entry (0001-3700).
4. Complete the programming sequence by scanning the ENTER/EXIT Programming Mode bar code.



Set Micro QR Code Length 1

★ Default setting for this feature = 0001



Set Micro QR Code Length 2

★ Default setting for this feature =

0E74 (length = 3700)

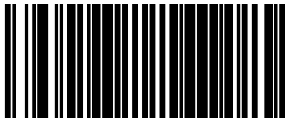

## AZTEC CODE

### Aztec Enable

Enables/disables the ability of the scanner to decode Aztec labels.

To set this feature:

1. Scan the Enter/Exit Programming Mode bar code.
2. Scan your selection from the bar codes below. Cover any unused bar codes on this and the facing page to ensure that the scanner reads only the bar code you intend to scan.
3. Complete the programming sequence by scanning the Enter/Exit Programming Mode bar code.



★ Aztec = Disable



Aztec = Enable

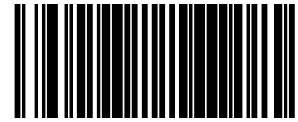

## Aztec Length Control

**Fixed Length Decoding:** When fixed length decoding is enabled, the scanner will decode a bar code if the label length matches one of the configurable fixed lengths.

**Variable Length Decoding:** When variable length decoding is enabled, the scanner will decode a bar code if the label length falls in the range of the configurable minimum and maximum length.

Configuring Fixed Length Decoding:

1. Scan the ENTER/EXIT Programming Mode bar code.
2. Scan the Fixed Length Decoding bar code.
3. Scan the ENTER/EXIT Programming Mode bar code.
4. Set Length 1 to the first fixed length using the [Aztec Length 1, Length 2 Programming Instructions](#) that follow this page.
5. Set Length 2 to the second fixed length (or to '0000' if there is only one fixed length) using the [Aztec Length 1, Length 2 Programming Instructions](#).

Configuring Variable Length Decoding:

1. Scan the ENTER/EXIT Programming Mode bar code.
2. Scan the Variable Length Decoding bar code.
3. Scan the ENTER/EXIT Programming Mode bar code.
4. Set Length 1 to the minimum length using the [Aztec Length 1, Length 2 Programming Instructions](#) that follow this page.
5. Set Length 2 to the maximum length using the [Aztec Length 1, Length 2 Programming Instructions](#).



★ Aztec Length Control = Variable Length



Aztec Length Control = Fixed Length

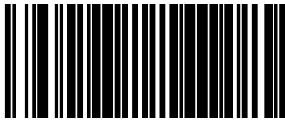

## Aztec Length 1, Length 2 Programming Instructions

If Aztec Length Control is set to Fixed-Length decoding, this feature specifies Aztec first fixed length. If Aztec Length Control is set to Variable-Length decoding, this feature specifies the minimum label length.



**NOTE: Length 1 is the minimum label length if in variable length mode, or the first fixed length if in fixed length mode. Length 2 is the maximum label length if in variable length mode, or the second fixed length if in fixed length mode. Length includes the bar code's data characters only. Any value > 3700 will be considered to be 3700.**

To set this feature:

1. Scan the ENTER/EXIT Programming Mode bar code.
2. Scan the bar code, [Set Aztec Length 1](#) or [Set Aztec Length 2](#) below. You'll need to cover any unused bar codes on this and the facing page to ensure that the scanner reads only the bar code you intend to scan.
3. Scan the appropriate digits from the [Alpha-Numeric Keypad in Appendix C](#) that represent the desired label length. The selectable range for this option is 0001 to 3700. Pad all numbers with leading zeros to yield a four-digit entry (0001-3700).
4. Complete the programming sequence by scanning the ENTER/EXIT Programming Mode bar code.



Set Aztec Length 1

Default setting for this feature = 0001



Set Aztec Length 2

Default setting for this feature = 0E74 (length = 3700)

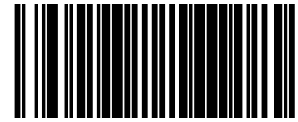

## HAN XIN CODE

### Han Xin Enable

Enables/disables the ability of the scanner to decode Han Xin labels.

To set this feature:

1. Scan the Enter/Exit Programming Mode barcode at the top of the page.
2. Scan either the enable or disable barcode below. You'll need to cover any unused barcodes on this and the facing page to ensure that the scanner reads only the barcode you intend to scan.
3. Complete the programming sequence by scanning the Enter/Exit Programming Mode barcode.



★ Han Xin Code = Disable



Han Xin Code = Enable

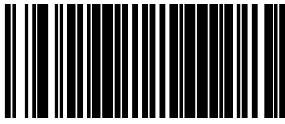

## DOTCODE

### Dotcode Enable

Enables/disables the ability of the scanner to decode Dotcode labels.

To set this feature:

1. Scan the Enter/Exit Programming Mode barcode at the top of the page.
2. Scan either the enable or disable barcode below. You'll need to cover any unused barcodes on this and the facing page to ensure that the scanner reads only the barcode you intend to scan.
3. Complete the programming sequence by scanning the Enter/Exit Programming Mode barcode.



★ Dotcode = Disable



Dotcode = Enable



# CHAPTER 3

## REFERENCES

---

This section contains explanations and examples of selected bar code features. See the programming sections for the actual bar code labels used to configure the reader.

SECTION CONTENTS
<b>GLOBAL PREFIX/SUFFIX</b> <a href="#">starting on page 256</a>
<b>LABEL ID</b> <a href="#">starting on page 257</a>
<b>LENGTH CONTROL</b> <a href="#">starting on page 258</a>

## GLOBAL PREFIX/SUFFIX

Up to 20 ASCII characters may be added as a prefix (in a position before the bar code data) and/or as a suffix (in a position following the bar code data) as shown.

### Prefix and Suffix Positions

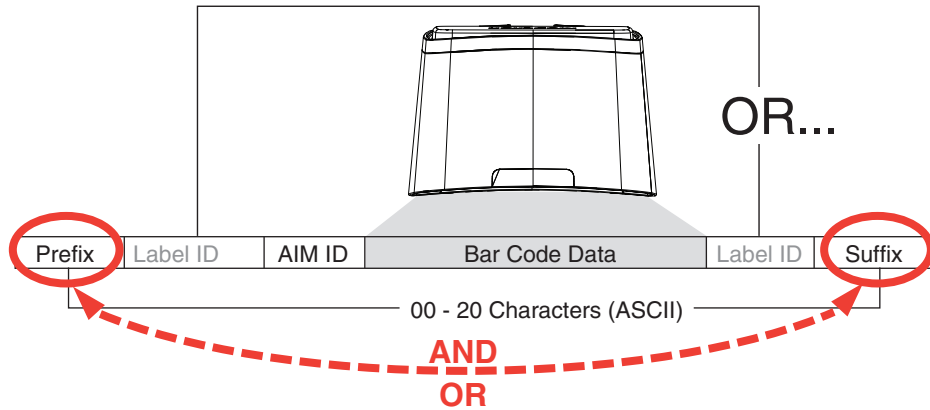

### Example: Setting a Prefix

In this example, we'll set a prefix for all symbologies.

1. Determine which ASCII character(s) are to be added to scanned bar code data. In this example, we'll add a dollar sign ('\$') as a prefix.
2. Scan the Enter/Exit Programming Mode bar code.
3. Scan the SET PREFIX bar code.
4. Reference the [ASCII Character Set](#) on the inside back cover of this manual, to find the hex value assigned to the desired character. The corresponding hex number for the '\$' character is 24. To enter this selection code, scan the '2' and '4' bar codes from [Appendix C, Alpha-Numeric Keypad](#).
5. Scan the END bar code once to finish the string, then scan END again to exit Programming Mode.



**NOTE: If all 20 characters will be used in the prefix or suffix, do not scan the END bar code to finish the string. It is done automatically.**

6. The resulting message string would appear as follows:  
Scanned bar code data:12345  
Resulting message string output: \$12345

## LABEL ID

A Label ID is used to identify a bar code (symbology) type. See [Appendix D](#), for a listing for common symbologies. It can be appended previous to or following the transmitted bar code data depending upon how this option is enabled. This feature provides options for configuring custom Label IDs individually per symbology. If you wish to program the scanner to always include an industry standard label identifier for ALL symbology types, see the feature, [AIM ID](#) on page 90.

The Label ID is a customizable code of up to three ASCII characters (each of which are 00-7F) followed by a control character (00-01). This control character, when set to zero, does nothing. When set to one, it appends the symbology's AIM ID to the Label ID.



**NOTE: When the control character is set to 01 for UPC-A and UPC-E, it expands the label to EAN-13 and thus follows the EAN-13 Label ID settings.**

### Label ID Position Options

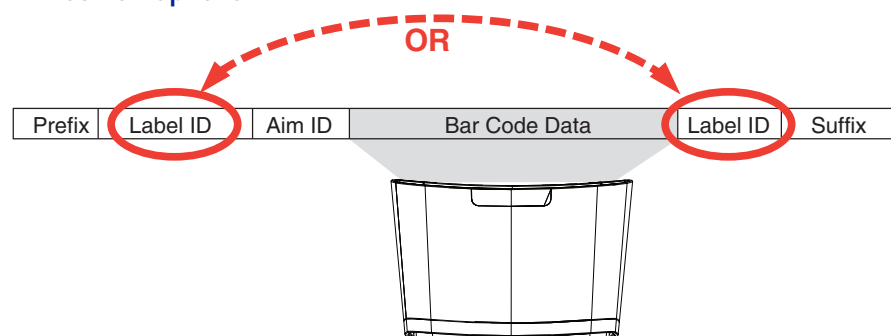

1. Go to [Label ID Control](#) on page 91 of the Data Editing chapter.
2. Scan the Enter/Exit Programming Mode bar code.
3. Select Label ID position as either BEFORE or AFTER by scanning the appropriate bar code.
4. Scan a bar code for the desired symbology from [Setting Label ID](#) on page 92 to select the symbology for which you wish to configure a custom Label ID.
5. Determine the desired character(s) (you may choose up to three) which will represent the Label ID for the selected symbology.
6. Next, turn to the [ASCII Character Set](#) on the inside back cover of this manual and find the equivalent hex digits associated with your choice of Label ID. For example, to make an equal sign (=), scan '3' and 'D' followed by '0' six times.
7. Turn to [Appendix C](#) and scan the bar codes representing the hex characters determined in the previous step. Since this is a three-character buffer, '00' is scanned for character two, '00' for character three and '00' for the control character. ('00' indicates no character.)
8. End by scanning the Enter/Exit Programming Mode bar code again.

## LENGTH CONTROL

**Fixed Length Decoding:** When fixed length decoding is enabled, the scanner will decode a bar code if the label length matches one of the configurable fixed lengths.

**Variable Length Decoding:** When variable length decoding is enabled, the scanner will decode a bar code if the label length falls in the range of the configurable minimum and maximum length.

Configuring Fixed Length Decoding:

1. Scan the Enter/Exit Programming Mode bar code.
2. Scan the Fixed Length Decoding bar code for the desired symbology.
3. Scan the Enter/Exit Programming Mode bar code.
4. Set Length 1 to the first fixed length by following the [Length 1, Length 2 Programming Instructions](#) below.
5. Set Length 2 to the second fixed length (or to '00' if there is only one fixed length) by following the [Length 1, Length 2 Programming Instructions](#) below.

### Configuring Variable Length Decoding:

1. Scan the Enter/Exit Programming Mode bar code.
2. Scan the Variable Length Decoding bar code for the desired symbology.
3. Scan the Enter/Exit Programming Mode bar code.
4. Set Length 1 to the first variable length by following the [Length 1, Length 2 Programming Instructions](#) below.
5. Set Length 2 to the second variable length by following the [Length 1, Length 2 Programming Instructions](#) below.

### Length 1, Length 2 Programming Instructions

1. Scan the Enter/Exit Programming Mode bar code.
2. Scan either the Set Length 1 or Set Length 2 bar code for the desired symbology.
3. Turn to [Appendix C](#) and scan the two digits (zero padded) representing the length in decimal notation. The number of characters that can be set varies, depending upon the symbology. Reference the page for your selected symbology to see specific variables.
4. Scan the Enter/Exit Programming Mode bar code

# APPENDIX A

## PRODUCT SPECIFICATIONS

---

SECTION CONTENTS
<b>TECHNICAL SPECIFICATIONS</b> starting on page 260 <ul style="list-style-type: none"><li>• <b>DECODING CAPABILITY</b> starting on page 260</li><li>• <b>ELECTRICAL SPECIFICATIONS</b> starting on page 260</li><li>• <b>ENVIRONMENTAL</b> starting on page 260</li><li>• <b>INTERFACES</b> starting on page 260</li><li>• <b>OPTIONAL FEATURES</b> starting on page 261</li><li>• <b>OPTIONAL FEATURES</b> starting on page 261</li></ul>
<b>PHYSICAL CHARACTERISTICS</b> starting on page 261
<b>READING PERFORMANCE</b> starting on page 262 <ul style="list-style-type: none"><li>• <b>READING RANGES</b> starting on page 262</li></ul>
<b>SAFETY &amp; REGULATORY</b> starting on page 262
<b>UTILITIES</b> starting on page 263
<b>WARRANTY</b> starting on page 263
<b>LED AND BEEPER INDICATORS</b> starting on page 263
<b>ERROR CODES</b> starting on page 264

## TECHNICAL SPECIFICATIONS

### Decoding Capability

ITEM	DESCRIPTION
1D / Linear Codes	Autodiscriminates All Standard 1D Codes Including GS1 Databar™ Linear Codes.
2D Codes	Aztec Code; Data Matrix; QR Code
Stacked Codes	GS1 Databar Composites; GS1 Databar Expanded Stacked; GS1 Databar Stacked; GS1 Databar Stacked Omnidirectional; Micro-PDF417; PDF417
Digital Watermarks	Optional Support For Digimarc® Barcodes/GS1 DW Code

### Electrical Specifications

ITEM	DESCRIPTION
AC Power Requirements	AC Input: 100-240 Vac, 50-60 Hz; DC Input: 5-12 V
Power Consumption	Maximum: 2.25W @ 5V; 3.3W @ 12V Typical (RMS): 1.6W @ 5V; 2.1W @ 12V Sleep Mode (RMS): 0.95W @ 5V; 1.25W @ 12V

### Environmental

ITEM	DESCRIPTION
Ambient Light	0 - 86,100 Lux
ESD Protection (Air Discharge)	25 kV
Humidity (Non-condensing)	5 - 95%
Particulate And Water Sealing	IP52
Temperature	Operating: 10 to 40 °C / 50 to 104 °F Storage/transport: -40 to 70 °C / -40 to 158 °F

### Interfaces

PARAMETER	SPECIFICATION
Interfaces	USB Keyboard; USB COM; OEM (IBM) USB; USB-TEC; RS-232
Auxiliary Port	Powered Type A USB (USB Com requires power supply or 12V Host power)

## Optional Features

PARAMETER	SPECIFICATION
EAS Features	Good Read signal available for use with various EAS hardware, such as Checkpoint Systems and Sensormatic devices.
Value Added Features	Diagnostic Reporting; Host Download; Magellan ULE Scripting

## PHYSICAL CHARACTERISTICS

PARAMETER	SPECIFICATION
Dimensions	Magellan Model 3410VSi: 13.7 X 15.2 X 9.4 cm / 5.4 X 6.0 X 3.7 in
Weight	0.6 kg /1.3 lb

### Scanner Dimensions

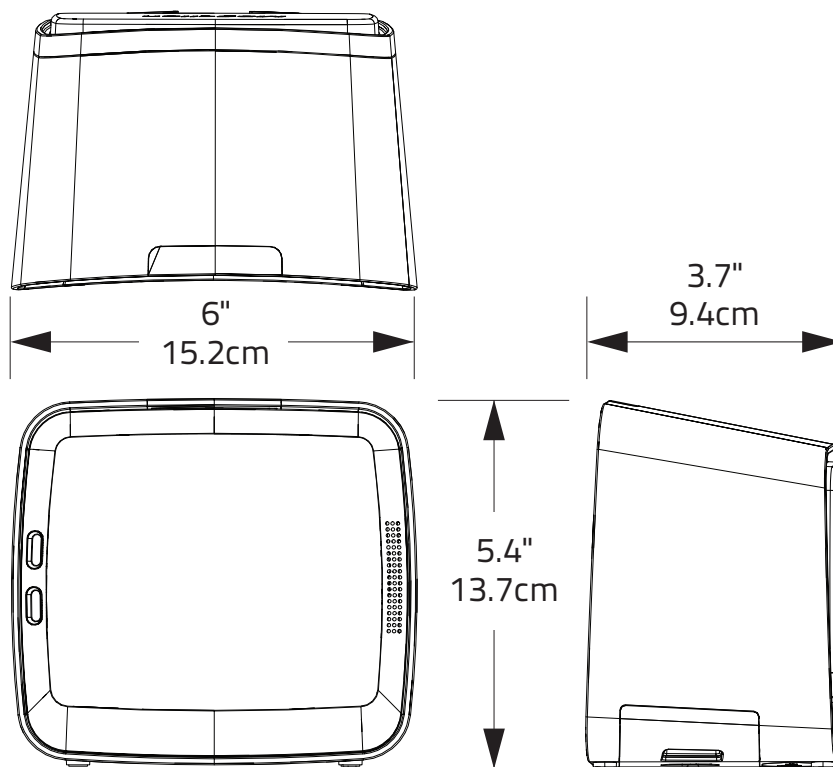

## READING PERFORMANCE

PARAMETER	SPECIFICATION
Image Capture	Graphic Formats: BMP, JPEG
Imager Sensor	1280 X 800
Light Source	Multiple Diffused LEDs, Orientation and Wavelength Optimized for Eye Comfort
Print Contrast Ratio (Minimum)	25%
Read Height	14.0 cm / 5.5 in
Read Rate (Maximum)	30 Million Pixels per Second
Reading Angle	Pitch: +/- 65°; Roll (Tilt): 0 - 360°; Skew (Yaw): +/- 75°
Reading Indicators	Audio Beeper w/Adjustable Tone and Volume; Good Read LED; Good Transmission
Resolution (Maximum)	5 Mil

## Reading Ranges

PARAMETER	SPECIFICATION
Typical Depth Of Field	Printing Resolution, Symbol Length, Scan Angle, Contrast and Ambient Light Dependent
1D / Linear Codes	5 Mils: 0 to 6.4 cm / 0 to 2.5 in
	10 Mils: 0 to 15.2 cm / 0 to 6.0 in
	13 Mils: 0 to 20.3 cm / 0 to 8.0 in
2D Codes (Optional)	6.6 Mils: PDF: 0 to 5.1 cm / 0 to 2.0 in
	10 Mils: PDF: 0 to 12.7 cm / 0 to 5.0 in
	10 Mils: Data Matrix: 0 to 6.4 cm / 0 to 2.5 in
	20 Mils: Data Matrix: 0 to 18.0 cm / 0 to 7.0 in

## SAFETY & REGULATORY

PARAMETER	SPECIFICATION
Agency Approvals	The product meets necessary safety and regulatory approvals for its intended use.
Environmental Compliance	Complies to China RoHS; Complies to EU RoHS
LED Classification	EN62471 and IEC62471 Lamp Illumination - Exempt Group



## UTILITIES

PARAMETER	SPECIFICATION
Scanalyzer	Magellan Scanalyzer Configuration Software is available for download at no charge.
OPOS / JavaPOS	JavaPOS Utilities are available for download at no charge. OPOS Utilities are available for download at no charge.

## WARRANTY

Warranty	3-year Factory Warranty
----------	-------------------------

## LED AND BEEPER INDICATORS

The scanner's beeper sounds and its green LED illuminates to indicate various functions or errors on the scanner. The tables below list these indications. The scanner's functions are programmable, and so may or may not be turned on. For example, certain indications such as the power-up beep can be disabled using programming bar code labels.

LED INDICATION	INDICATION	COMMENT
Power-on indication	Constant bright green	Indicates the scanner is running power-up tests and is not yet ready for operation.
Good Read Indication	Bright green flash	Indicates a bar code has been read and decoded.
Scanner Ready	Constant dim green	The scanner is ready for operation.
Sleep Mode	Green LED flashes every 2 seconds (10mS on, 1990mS off).	The scanner is in Sleep Mode. To wake the scanner up, move an object in front of its window or press the Scanner Button. This indication is optionally configurable, and may have been programmed to behave differently.
Host Disable	Constant green flash at 1 Hz (100mS on, 900mS off)	The scanner is disabled due to receiving a disable command from the POS terminal.
Diagnostics	Varies (see Error Codes on page 264 for more information)	The LED can provide diagnostic feedback if the scanner discovers a problem during SelfTest.
Prog. Mode	Constant green flash at 1 Hz (500 ms on, 500 ms off).	The scanner is in Programming Mode.

BEEPER INDICATION	INDICATION	COMMENT
Power On Beep	Single beep	The Power-On LED indication is a configurable feature which can be enabled or disabled. When enabled, this beep Indicates the scanner has finished all its power-up tests and is now ready for operation.
Good Read Indication	Single beep	The good read beep indication is configurable. Options include: Enable/disable, frequency, duration and volume. See " <a href="#">LED and Beeper Indicators</a> " on page 25 for more information.
Diagnostics	Varies (see " <a href="#">Error Codes</a> " for more information)	The Beeper can provide diagnostic feedback if the scanner discovers a problem during SelfTest.

BEEPER INDICATION	INDICATION	COMMENT
Programming Mode Indications	Varies depending upon the feature(s) being configured.	The Beeper will sound as programming bar code labels are scanned, indicating progress during scanner configuration.

## ERROR CODES

If an error is detected, the scanner will sound a long low tone (for three seconds) and flash its LED, indicating a failure. When this occurs, press the Scanner Pushbutton to hear the error code. If it is configured to do so, the scanner will sound a series of beeps corresponding to the error code and/or flash its LED simultaneous to the beeps. The table below describes what these codes mean and what action should be taken for each.

NUMBER OF LED FLASHES/ BEEPS	ERROR	CORRECTIVE ACTION
1	Configuration	Contact Helpdesk for assistance
2	Host Interface	
6	Main PCB	
10	Button Error	
11	USB Device	
13	CPLD ID	

# APPENDIX B

## CABLE PINOUTS

---

### STANDARD CABLE PINOUTS (PRIMARY INTERFACE CABLES)

Pin #	RS-232	USB-OEM	USB, USB Keyboard, USB COM
1		D+	D+
2	CTS		
3		D-	D-
4	RTS		
5	RxD		
6	TxD		
7			
8	Vin	Vin/VBUS	Vin/VBUS
9	GND	GND	GND
10	ERI	ERI	ERI

# APPENDIX C

## ALPHA-NUMERIC KEYPAD

---



A



B



C



D



E



F



1



2

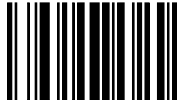

3



4



5



6



7



8



9



0

# APPENDIX D

## FACTORY DEFAULT SETTINGS

The following table provides a listing of the most common factory settings for the interfaces shown.



**NOTE: Some of the individual interfaces listed in the defaults table below appear in the same column since they share similar feature settings with few (if any) exceptions.**

**Keep in mind though, that the actual configuration storage area for each interface is unique and that updates & changes to factory defaults can be made at any time without notice.**

### Factory Default Settings

Feature	Default Master	RS-232	RS-232 Wincor-Nixdorf	Keyboard	USB COM / USB TEC	USB OEM
<b>General Scanner Features</b>						
1D Double Read Timeout	28 (400ms)	28 (400ms)	28 (400ms)	28 (400ms)	28 (400ms)	28 (400ms)
2D Double Read Timeout	46 (700ms)	46 (700ms)	46 (700ms)	46 (700ms)	46 (700ms)	46 (700ms)
Double Read Table Size	7 Entries	7 Entries	7 Entries	7 Entries	7 Entries	7 Entries
Digital Watermark (Digimarc) Enable	00 (disable)	00 (disable)	00 (disable)	00 (disable)	00 (disable)	00 (disable)
Digital Watermark (Digimarc) Double Read Timeout	32 (500ms)	32 (500ms)	32 (500ms)	32 (500ms)	32 (500ms)	32 (500ms)
Digital Watermark (Digimarc) Data Format	00 (compatibility mode)	00 (compatibility mode)	00 (compatibility mode)	00 (compatibility mode)	00 (compatibility mode)	00 (compatibility mode)
Sleep Mode Timer	14 (5 minutes)	14 (5 minutes)	14 (5 minutes)	14 (5 minutes)	14 (5 minutes)	14 (5 minutes)
1D Inverse Read Control	00 (normal)	00 (normal)	00 (normal)	00 (normal)	00 (normal)	00 (normal)
2D Inverse Read Control	00 (normal)	00 (normal)	00 (normal)	00 (normal)	00 (normal)	00 (normal)
Power On Alert	01 (enable)	01 (enable)	01 (enable)	01 (enable)	01 (enable)	01 (enable)
Reading Illumination Duration	64 (5 sec)	64 (5 sec)	64 (5 sec)	64 (5 sec)	64 (5 sec)	64 (5 sec)
Illumination During Disable Mode	01 (enable)	01 (enable)	01 (enable)	01 (enable)	01 (enable)	01 (enable)
Object Sense Control	01 (enable)	01 (enable)	01 (enable)	01 (enable)	01 (enable)	01 (enable)

Feature	Default Master	RS-232	RS-232 Wincor-Nixdorf	Keyboard	USB COM / USB TEC	USB OEM
External Read Indicator (ERI)	00 (Active Low)	00 (Active Low)	00 (Active Low)	00 (Active Low)	00 (Active Low)	00 (Active Low)
ERI Timeout	02 (20ms)	02 (20ms)	02 (20ms)	02 (20ms)	02 (20ms)	02 (20ms)
Good Read LED Idle State	02 (on dim)	02 (on dim)	02 (on dim)	02 (on dim)	02 (on dim)	02 (on dim)
Scanner Control Button Options	01 (enable only volume, tone, and reset)	01 (enable only volume, tone, and reset)	01 (enable only volume, tone, and reset)	01 (enable only volume, tone, and reset)	01 (enable only volume, tone, and reset)	01 enable only volume, tone, and reset)
Good Read Beep Control	01 (enable)	01 (enable)	01 (enable)	01 (enable)	01 (enable)	01 (enable)
Good Read Beep Frequency	01 (med.)	01 (med.)	01 (med.)	01 (med.)	01 (med.)	01 (med.)
Good Read Beep Length	08 (80ms)	08 (80ms)	08 (80ms)	08 (80ms)	08 (80ms)	08 (80ms)
Good Read Beep Volume	02 (med)	02 (med)	02 (med)	02 (med)	02 (med)	02 (med)
Good Read When to Indicate	00 (after decode)	00 (after decode)	00 (after decode)	00 (after decode)	00 (after decode)	00 (after decode)
Illumination Blank on Beep	00 (disable)					
Handheld Host Download Timeout	0F (15 seconds)	0F (15 seconds)	0F (15 seconds)	0F (15 seconds)	0F (15 seconds)	0F (15 seconds)
<b>Imaging Features</b>						
Camera Button Mode	00 (disable)	00 (disable)	00 (disable)	00 (disable)	00 (disable)	00 (disable)
Image Destination	00 (disable)	00 (disable)	00 (disable)	00 (disable)	00 (disable)	00 (disable)
Picture Retrieval Timeout	05 (5 sec.)	05 (5 sec.)	05 (5 sec.)		05 (5 sec.)	05 (5 sec.)
Image Capture Delay	05 (5 sec.)	05 (5 sec.)	05 (5 sec.)	05 (5 sec.)	05 (5 sec.)	05 (5 sec.)
Image Format	00 (JPG)	00 (JPG)	00 (JPG)	00 (JPG)	00 (JPG)	00 (JPG)
Image Size	00 (VGA)	00 (VGA)	00 (VGA)	00 (VGA)	00 (VGA)	00 (VGA)
Image Brightness	00 (Level 0)	00 (Level 0)	00 (Level 0)	00 (Level 0)	00 (Level 0)	00 (Level 0)
Image Contrast	00 (Level 0)	00 (Level 0)	00 (Level 0)	00 (Level 0)	00 (Level 0)	00 (Level 0)
Image Compression	64 (Compression = 100)	64 (Compression = 100)	64 (Compression = 100)	64 (Compression = 100)	64 (Compression = 100)	64 (Compression = 100)
Region of Interest (ROI)	000004FF00 00031F (full size)	000004FF00 00031F (full size)	000004FF00 00031F (full size)	000004FF00 00031F (full size)	000004FF00 00031F (full size)	000004FF00 00031F (full size)
Cell Phone Mode	02 (always on)	02 (always on)	02 (always on)	02 (always on)	02 (always on)	02 (always on)
Cell Mode Percent	Low	Low	Low	Low	Low	Low
<b>Interface Related Features</b>						
Maximum Host-Transmitted Message Length	00 (no length limit)	00 (no length limit)	00 (no length limit)	00 (no length limit)	00 (no length limit)	00 (no length limit)
Ignore Host Commands	00 (don't ignore)	00 (don't ignore)	00 (don't ignore)	00 (don't ignore)	00 (don't ignore)	00 (don't ignore)
RS-232 Baud Rate	01 (9600)	01 (9600)	01 (9600)		01 (9600)	
RS-232 Number of Data Bits	01 (8 data bits)	01 (8 data bits)	01 (8 data bits)		01 (8 data bits)	

Feature	Default Master	RS-232	RS-232 Wincor-Nixdorf	Keyboard	USB COM / USB TEC	USB OEM
RS-232 Number of Stop Bits	00 (1 stop bit)	00 (1 stop bit)	00 (1 stop bit)		00 (1 stop bit)	
RS-232 Parity	00 (none)	00 (none)	02 (odd)		00 (none)	
RS-232 Hardware Control	00 (disable)	00 (disable)	01 (enable CTS flow control)		00 (disable)	
RS-232 Intercharacter Delay	00 (no delay)	00 (no delay)	00 (no delay)		00 (no delay)	
RS-232 Software Flow Control	00 (disable)	00 (disable)	00 (disable)		00 (disable)	
RS-232 Beep on ASCII BEL	00 (disable)	00 (disable)	00 (disable)		00 (disable)	
Beep on Not on File	01 (low vol)	01 (low vol)	01 (low vol)		01 (low vol)	01 (low vol)
ACK NAK Enable	00 (disable)	00 (disable)	00 (disable)		00 (disable)	
RS-232 ACK Character	06 (ACK)	06 (ACK)	06 (ACK)		06 (ACK)	
RS-232 NAK Character	15 (NAK)	15 (NAK)	15 (NAK)		15 (NAK)	
RS-232 Retry on ACK NAK Timeout	01 (enable)	01 (enable)	01 (enable)		01 (enable)	
RS-232 ACK NAK Timeout Value	01 (200ms)	01 (200ms)	01 (200ms)		01 (200ms)	
RS-232 ACK NAK Retry Count	03 (3 retries)	03 (3 retries)	03 (3 retries)		03 (3 retries)	
RS-232 ACK NAK Error Handling	00 (ignore)	00 (ignore)	00 (ignore)		00 (ignore)	
RS-232 Indicate Transmission Failure	01 (enable)	01 (enable)	01 (enable)		01 (enable)	
USB Power Compliance	00 (disable)	00 (disable)	00 (disable)	01 (enable)	00 (disable)	00 (disable)
USB OEM Scanner Device Type	00 (table top)					00 (table top)
USB OEM Additional Interface Options	00 (disabled upon enumeration)					00 (disabled upon enumeration)
USB Keyboard Country Mode	00 (USA)			00 (USA)		
USB Keyboard Caps Lock State	00 (caps lock OFF)			00 (caps lock OFF)		
USB Keyboard Send Control Characters	00 (disable)			00 (disable)		
Quiet Interval	0A (100ms)			0A (100ms)		
USB Keyboard Intercharacter Delay	01 (10ms)			01 (10ms)		
USB Keyboard Additional Interface Options	40 (Rev D)	00	00	40 (Rev D)	40 (Rev D)/00	46
<b>Data Editing</b>						
Global Prefix	00 (no prefix)	00 (no prefix)	00 (no prefix)	00 (no prefix)	00 (no prefix)	00 (no prefix)
Global Suffix	0D00 (CR)	0D00 (CR)	0D00 (CR)	0D00 (CR)	0D00 (CR)	0D00 (CR)
AIM ID	00 (disable)	00 (disable)	00 (disable)	00 (disable)	00 (disable)	
Label ID	01 (Enable as prefix)	01 (Enable as prefix)	01 (Enable as prefix)	01 (Enable as prefix)	01 (Enable as prefix)	



Feature	Default Master	RS-232	RS-232 Wincor-Nixdorf	Keyboard	USB COM / USB TEC	USB OEM
Global Mid-Label ID	00 (no mid-label ID)	00 (no mid-label ID)	00 (no mid-label ID)	00 (no mid-label ID)	00 (no mid-label ID)	
Case Conversion	00 (no case conversion)	00 (no case conversion)	00 (no case conversion)	00 (no case conversion)	00 (no case conversion)	00 (no case conversion)
Character Conversion	FFFFFFFF (no character conversion)	FFFFFFFF (no character conversion)	FFFFFFFF (no character conversion)	FFFFFFFF (no character conversion)	FFFFFFFF (no character conversion)	FFFFFFFF (no character conversion)
<b>1D Symbology Programming</b>						
Coupon Control Enable	04 (Databar coupon label priority)	04 (Databar coupon label priority)	04 (Databar coupon label priority)	04 (Databar coupon label priority)	04 (Databar coupon label priority)	04 (Databar coupon label priority)
Coupon Label Priority Timer	14 (200ms)	14 (200ms)	14 (200ms)	14 (200ms)	14 (200ms)	14 (200ms)
UPC-A Enable	01 (enable)	01 (enable)	01 (enable)	01 (enable)	01 (enable)	01 (enable)
UPC-A Number System Character Transmission	01 (enable)	01 (enable)	01 (enable)	01 (enable)	01 (enable)	01 (enable)
UPC-A Check Character Transmission	01 (enable)	01 (enable)	01 (enable)	01 (enable)	01 (enable)	01 (enable)
UPC-A Minimum Read	01 (1 read)	01 (1 read)	01 (1 read)	01 (1 read)	01 (1 read)	01 (1 read)
Expand UPC-A to EAN-13	00 (disable)	00 (disable)	01 (enable)	00 (disable)	00 (disable)	00 (disable)
UPC-E Enable	01 (enable)	01 (enable)	01 (enable)	01 (enable)	01 (enable)	01 (enable)
UPC-E Number System Character Transmission	01 (enable)	01 (enable)	01 (enable)	01 (enable)	01 (enable)	01 (enable)
UPC-E Check Character Transmission	01 (enable)	01 (enable)	00 (disable)	01 (enable)	01 (enable)	01 (enable)
Expand UPC-E to UPC-A	00 (disable)	00 (disable)	00 (disable)	00 (disable)	00 (disable)	00 (disable)
Expand UPC-E to EAN-13	00 (disable)	00 (disable)	00 (disable)	00 (disable)	00 (disable)	00 (disable)
UPC-E Minimum Read	01 (1 read)	01 (1 read)	01 (1 read)	01 (1 read)	01 (1 read)	01 (1 read)
EAN-13	01 (enable)	01 (enable)	01 (enable)	01 (enable)	01 (enable)	01 (enable)
EAN-13 First Character Transmission	01 (enable)	01 (enable)	01 (enable)	01 (enable)	01 (enable)	01 (enable)
EAN-13 Check Character Transmission	01 (enable)	01 (enable)	01 (enable)	01 (enable)	01 (enable)	01 (enable)
EAN-13 ISBN Conversion Enable	00 (disable)	00 (disable)	00 (disable)	00 (disable)	00 (disable)	00 (disable)
EAN-13 Minimum Read	01 (1 read)	01 (1 read)	01 (1 read)	01 (1 read)	01 (1 read)	01 (1 read)
EAN-8	01 (enable)	01 (enable)	01 (enable)	01 (enable)	01 (enable)	01 (enable)
EAN-8 Check Character Transmission	01 (enable)	01 (enable)	01 (enable)	01 (enable)	01 (enable)	01 (enable)
Expand EAN-8 to EAN-13	00 (disable)	00 (disable)	00 (disable)	00 (disable)	00 (disable)	00 (disable)
EAN-8 Minimum Read	01 (1 read)	01 (1 read)	01 (1 read)	01 (1 read)	01 (1 read)	01 (1 read)

Feature	Default Master	RS-232	RS-232 Wincor-Nixdorf	Keyboard	USB COM / USB TEC	USB OEM
EAN-8 Guard Insertion	00 (disable)	00 (disable)	00 (disable)	00 (disable)	00 (disable)	00 (disable)
EAN-8 Guard Substitution	00 (disable)	00 (disable)	00 (disable)	00 (disable)	00 (disable)	00 (disable)
EAN-8/Jan-8 Both Guards Substitution	00 (disable)	00 (disable)	00 (disable)	00 (disable)	00 (disable)	00 (disable)
EAN-8 Stitch Exact Label Halves	00 (disable)	00 (disable)	00 (disable)	00 (disable)	00 (disable)	00 (disable)
EAN-8 Stitch Unlike Label Halves	00 (disable)	00 (disable)	00 (disable)	00 (disable)	00 (disable)	00 (disable)
EAN-8 Minimum Segment Length	08 (8 chars)	08 (8 chars)	08 (8 chars)	08 (8 chars)	08 (8 chars)	08 (8 chars)
EAN-8 Decoding Levels	01 (very conservative)	01 (very conservative)	01 (very conservative)	01 (very conservative)	01 (very conservative)	01 (very conservative)
In-Store Printed Label Minimum Read	01 (1 read)	01 (1 read)	01 (1 read)	01 (1 read)	01 (1 read)	01 (1 read)
UPC/EAN Guard Insertion	00 (disable)	00 (disable)	00 (disable)	00 (disable)	00 (disable)	00 (disable)
UPC/EAN Stitch Exact Label Halves	00 (disable)	00 (disable)	00 (disable)	00 (disable)	00 (disable)	00 (disable)
UPC/EAN Stitch Unlike Label Halves	00 (disable)	00 (disable)	00 (disable)	00 (disable)	00 (disable)	00 (disable)
UPC/EAN Minimum Segment Length	05 (5 char.)	05 (5 char.)	05 (5 char.)	05 (5 char.)	05 (5 char.)	05 (5 char.)
Price Weight Check	00 (disable)	00 (disable)	00 (disable)	00 (disable)	00 (disable)	00 (disable)
Enable EAN Two Label	00 (disable)	00 (disable)	00 (disable)	00 (disable)	00 (disable)	00 (disable)
EAN Two Label Minimum Read	01 (1 read)	01 (1 read)	01 (1 read)	01 (1 read)	01 (1 read)	01 (1 read)
EAN Two Label Combined Transmission	00 (disable)	00 (disable)	00 (disable)	00 (disable)		
Add-ons	disable all	disable all	disable all	disable all	disable all	disable all
P2 Add-on Minimum Read	02 (2 reads)	02 (2 reads)	02 (2 reads)	02 (2 reads)	02 (2 reads)	02 (2 reads)
P5 Add-on Minimum Read	01 (1 read)	01 (1 read)	01 (1 read)	01 (1 read)	01 (1 read)	01 (1 read)
UPC/EAN Composites	00 (disable)	00 (disable)	00 (disable)	00 (disable)	00 (disable)	
GTIN	00 (disable)	00 (disable)	00 (disable)	00 (disable)	00 (disable)	
DataBar Omnidirectional Enable	00 (disable)	00 (disable)	00 (disable)	00 (disable)	00 (disable)	00 (disable)
DataBar Omnidirectional/EAN-128 Emulation	00 (disable)	00 (disable)	00 (disable)	00 (disable)	00 (disable)	00 (disable)
DataBar Omnidirectional 2D Component Enable	00 (disable)	00 (disable)	00 (disable)	00 (disable)	00 (disable)	00 (disable)
DataBar Omnidirectional Minimum Read	01 (1 read)	01 (1 read)	01 (1 read)	01 (1 read)	01 (1 read)	01 (1 read)
DataBar Omnidirectional Double Read Timeout	32 (2.5 Sec.)	32 (2.5 Sec.)	32 (2.5 Sec.)	32 (2.5 Sec.)	32 (2.5 Sec.)	32 (2.5 Sec.)
DataBar Limited Enable	00 (disable)	00 (disable)	00 (disable)	00 (disable)	00 (disable)	00 (disable)

Feature	Default Master	RS-232	RS-232 Wincor-Nixdorf	Keyboard	USB COM / USB TEC	USB OEM
DataBar Limited Minimum Read	01 (1 read)	01 (1 read)	01 (1 read)	01 (1 read)	01 (1 read)	01 (1 read)
DataBar Limited 2D Component Enable	00 (disable)	00 (disable)	00 (disable)	00 (disable)	00 (disable)	00 (disable)
DataBar Limited EAN128 Emulation Enable	00 (disable)	00 (disable)	00 (disable)	00 (disable)	00 (disable)	00 (disable)
DataBar Expanded	00 (disable)	00 (disable)	00 (disable)	00 (disable)	00 (disable)	00 (disable)
DataBar Expanded EAN-128 Emulation	00 (disable)	00 (disable)	00 (disable)	00 (disable)	00 (disable)	00 (disable)
DataBar Expanded 2D Component Enable	00 (disable)	00 (disable)	00 (disable)	00 (disable)	00 (disable)	00 (disable)
DataBar Expanded Minimum Read	01 (1 read)	01 (1 read)	01 (1 read)	01 (1 read)	01 (1 read)	01 (1 read)
DataBar Expanded Length Control	00 (variable)	00 (variable)	00 (variable)	00 (variable)	00 (variable)	00 (variable)
DataBar Expanded Length 1	01 (1 char)	01 (1 char)	01 (1 char)	01 (1 char)	01 (1 char)	01 (1 char)
DataBar Expanded Length 2	4A (74 chars)	4A (74 chars)	4A (74 chars)	4A (74 chars)	4A (74 chars)	4A (74 chars)
DataBar Expanded Reverse Retry	00 (disable)	00 (disable)	00 (disable)	00 (disable)	00 (disable)	00 (disable)
Code 39	01 (enable)	01 (enable)	01 (enable)	01 (enable)	01 (enable)	01 (enable)
Code 39 Start Stop Character Transmission	00 (disable)	00 (disable)	00 (disable)	00 (disable)	00 (disable)	00 (disable)
Code 39 Check Character Calculation	00 (disable)	00 (disable)	00 (disable)	00 (disable)	00 (disable)	00 (disable)
Code 39 Check Character Transmission	01 (enable)	01 (enable)	01 (enable)	01 (enable)	01 (enable)	01 (enable)
Code 39 Full ASCII	00 (disable)	00 (disable)	00 (disable)	00 (disable)	00 (disable)	00 (disable)
Code 39 Minimum Read	01 (1 read)	01 (1 read)	01 (1 read)	01 (1 read)	01 (1 read)	01 (1 read)
Code 39 Length Control	00 (variable)	00 (variable)	00 (variable)	00 (variable)	00 (variable)	00 (variable)
Code 39 Length 1	02 (2 chars)	02 (2 chars)	02 (2 chars)	02 (2 chars)	02 (2 chars)	02 (2 chars)
Code 39 Length 2	32 (50 chars)	32 (50 chars)	32 (50 chars)	32 (50 chars)	32 (50 chars)	32 (50 chars)
Code 39 Stitching	01 (enable)	01 (enable)	01 (enable)	01 (enable)	01 (enable)	01 (enable)
Code 39 Require Margins	00 (disable)	00 (disable)	00 (disable)	00 (disable)	00 (disable)	00 (disable)
Code 32 Italian Pharmacode	00 (disable)	00 (disable)	00 (disable)	00 (disable)	00 (disable)	00 (disable)
Code 32 Start Stop Character Transmission	00 (disable)	00 (disable)	00 (disable)	00 (disable)	00 (disable)	00 (disable)
Code 32 Check Character Transmission	00 (disable)	00 (disable)	00 (disable)	00 (disable)	00 (disable)	
Code 128	01 (enable)	01 (enable)	01 (enable)	01 (enable)	01 (enable)	01 (enable)
Code 128 Transmit Function Characters	00 (disable)	00 (disable)	00 (disable)	00 (disable)	00 (disable)	00 (disable)

Feature	Default Master	RS-232	RS-232 Wincor-Nixdorf	Keyboard	USB COM / USB TEC	USB OEM
Expand Code128 to Code 39	00 (disable)	00 (disable)	00 (disable)	00 (disable)	00 (disable)	00 (disable)
Code 128 Minimum Read	01 (1 read)	01 (1 read)	01 (1 read)	01 (1 read)	01 (1 read)	01 (1 read)
Code 128 Length Control	00 (variable)	00 (variable)	00 (variable)	00 (variable)	00 (variable)	00 (variable)
Code 128 Length 1	01 (1 char)	01 (1 char)	01 (1 char)	01 (1 char)	01 (1 char)	01 (1 char)
Code 128 Length 2	50 (80 chars)	50 (80 chars)	50 (80 chars)	50 (80 chars)	50 (80 chars)	50 (80 chars)
Code 128 Stitching	01 (enable)	01 (enable)	01 (enable)	01 (enable)	01 (enable)	01 (enable)
EAN-128	00 (transmit EAN128 labels as Code 128)	00 (transmit EAN128 labels as Code 128)	00 (transmit EAN128 labels as Code 128)	00 (transmit EAN128 labels as Code 128)	00 (transmit EAN128 labels as Code 128)	00 (transmit EAN128 labels as Code 128)
Interleaved 2 of 5 (I 2 OF 5)	00 (disable)	00 (disable)	00 (disable)	00 (disable)	00 (disable)	00 (disable)
I 2 of 5 Check Character Calculation	00 (disable)	00 (disable)	00 (disable)	00 (disable)	00 (disable)	00 (disable)
I 2 of 5 Check Character Transmission	01 (enable)	01 (enable)	01 (enable)	01 (enable)	01 (enable)	01 (enable)
I 2 of 5 Minimum Read	01 (1 read)	01 (1 read)	01 (1 read)	01 (1 read)	01 (1 read)	01 (1 read)
I 2 of 5 Length Control	00 (variable)	00 (variable)	00 (variable)	00 (variable)	00 (variable)	00 (variable)
I 2 of 5 Length 1	06 (6 chars)	06 (6 chars)	06 (6 chars)	06 (6 chars)	06 (6 chars)	06 (6 chars)
I 2 of 5 Length 2	32 (50 chars)	32 (50 chars)	32 (50 chars)	32 (50 chars)	32 (50 chars)	32 (50 chars)
Codabar	00 (disable)	00 (disable)	00 (disable)	00 (disable)	00 (disable)	00 (disable)
Codabar Start Stop Character Transmission	01 (enable)	01 (enable)	01 (enable)	01 (enable)	01 (enable)	01 (enable)
Codabar Start Stop Character Set	03 (abcd/abcd)	03 (abcd/abcd)	03 (abcd/abcd)	03 (abcd/abcd)	03 (abcd/abcd)	03 (abcd/abcd)
Codabar Start Stop Character Match	00 (disable)	00 (disable)	00 (disable)	00 (disable)	00 (disable)	00 (disable)
Codabar Check Character Calculation	00 (disable)	00 (disable)	00 (disable)	00 (disable)	00 (disable)	00 (disable)
Codabar Check Character Transmission	01 (enable)	01 (enable)	01 (enable)	01 (enable)	01 (enable)	01 (enable)
Codabar Minimum Read	01 (1 read)	01 (1 read)	01 (1 read)	01 (1 read)	01 (1 read)	01 (1 read)
Codabar Length Control	00 (variable)	00 (variable)	00 (variable)	00 (variable)	00 (variable)	00 (variable)
Codabar Length 1	03 (3 chars)	03 (3 chars)	03 (3 chars)	03 (3 chars)	03 (3 chars)	03 (3 chars)
Codabar Length 2	32 (50 chars)	32 (50 chars)	32 (50 chars)	32 (50 chars)	32 (50 chars)	32 (50 chars)
Codabar Require Margins	00 (disable)	00 (disable)	00 (disable)	00 (disable)	00 (disable)	00 (disable)
Code 93	00 (disable)	00 (disable)	00 (disable)	00 (disable)	00 (disable)	00 (disable)
Code 93 Minimum Read	01 (1 read)	01 (1 read)	01 (1 read)	01 (1 read)	01 (1 read)	01 (1 read)
Code 93 Length Control	00 (variable)	00 (variable)	00 (variable)	00 (variable)	00 (variable)	00 (variable)

Feature	Default Master	RS-232	RS-232 Wincor-Nixdorf	Keyboard	USB COM / USB TEC	USB OEM
Code 93 Length 1	01 (1 char)	01 (1 char)	01 (1 char)	01 (1 char)	01 (1 char)	01 (1 char)
Code 93 Length 2	32 (50 chars)	32 (50 chars)	32 (50 chars)	32 (50 chars)	32 (50 chars)	32 (50 chars)
MSI	00 (disable)	00 (disable)	00 (disable)	00 (disable)	00 (disable)	
MSI Check Character Calculation	01 (enable)	01 (enable)	01 (enable)	01 (enable)	01 (enable)	
MSI Number of Check Characters	00 (1 char)	00 (1 char)	00 (1 char)	00 (1 char)	00 (1 char)	
MSI Check Character Transmission	01 (enable)	01 (enable)	01 (enable)	01 (enable)	01 (enable)	
MSI Minimum Read	01 (1 read)	01 (1 read)	01 (1 read)	01 (1 read)	01 (1 read)	
MSI Length Control	00 (variable)	00 (variable)	00 (variable)	00 (variable)	00 (variable)	
MSI Length 1	04 (4 chars)	04 (4 chars)	04 (4 chars)	04 (4 chars)	04 (4 chars)	
MSI Length 2	10 (16 chars)	10 (16 chars)	10 (16 chars)	10 (16 chars)	10 (16 chars)	
Standard 2 of 5	00 (disable)	00 (disable)	00 (disable)	00 (disable)	00 (disable)	00 (disable)
Standard 2 of 5 Check Character Calculation	00 (disable)	00 (disable)	00 (disable)	00 (disable)	00 (disable)	00 (disable)
Standard 2 of 5 Check Character Transmission	01 (enable)	01 (enable)	01 (enable)	01 (enable)	01 (enable)	01 (enable)
Standard 2 of 5 Length Control	00 (disable)	00 (disable)	00 (disable)	00 (disable)	00 (disable)	00 (disable)
Standard 2 of 5 Length Control	00 (variable)	00 (variable)	00 (variable)	00 (variable)	00 (variable)	00 (variable)
Standard 2 of 5 Length 1	08 (8 chars)	08 (8 chars)	08 (8 chars)	08 (8 chars)	08 (8 chars)	08 (8 chars)
Standard 2 of 5 Length 2	32 (50 chars)	32 (50 chars)	32 (50 chars)	32 (50 chars)	32 (50 chars)	32 (50 chars)
<b>2D Symbology Programming</b>						
Data Matrix	00 (disable)	00 (disable)	00 (disable)	00 (disable)	00 (disable)	00 (disable)
Data Matrix Length Control	00 (variable)	00 (variable)	00 (variable)	00 (variable)	00 (variable)	00 (variable)
Set Data Matrix Length 1	0001 (1 char)	0001 (1 char)	0001 (1 char)	0001 (1 char)	0001 (1 char)	0001 (1 char)
Set Data Matrix Length 2	0320 (800 chars)	0320 (800 chars)	0320 (800 chars)	0320 (800 chars)	0320 (800 chars)	0320 (800 chars)
GS1 Datamatrix Enable	00 (transmit as std Data-matrix label)	00 (transmit as std Data-matrix label)	01 (transmit as GS1 Data-matrix label)	00 (transmit as std Data-matrix label)	00 (transmit as std Data-matrix label)	00 (transmit as std Data-matrix label)
PDF 417 Enable	01 (enable)	01 (enable)	01 (enable)	01 (enable)	01 (enable)	01 (enable)
PDF 417 Length Control	00 (variable)	00 (variable)	00 (variable)	00 (variable)	00 (variable)	00 (variable)
Set PDF 417 Length 1	0001 (1 char)	0001 (1 char)	0001 (1 char)	0001 (1 char)	0001 (1 char)	0001 (1 char)
Set PDF 417 Length 2	0A96 (2710 chars)	0A96 (2710 chars)	0A96 (2710 chars)	0A96 (2710 chars)	0A96 (2710 chars)	0A96 (2710 chars)

Feature	Default Master	RS-232	RS-232 Wincor-Nixdorf	Keyboard	USB COM / USB TEC	USB OEM
PDF 417 Read Option	00 (enforce codeword length checking)	00 (enforce codeword length checking)	00 (enforce codeword length checking)	00 (enforce codeword length checking)	00 (enforce codeword length checking)	00 (enforce codeword length checking)
Micro PDF 417	00 (disable)	00 (disable)	00 (disable)	00 (disable)	00 (disable)	00 (disable)
Micro PDF 417 Length Control	00 (variable)	00 (variable)	00 (variable)	00 (variable)	00 (variable)	00 (variable)
Set Micro PDF 417 Length 1	0001 (1 char)	0001 (1 char)	0001 (1 char)	0001 (1 char)	0001 (1 char)	0001 (1 char)
Set Micro PDF 417 Length 2	016E (366 chars)	016E (366 chars)	016E (366 chars)	016E (366 chars)	016E (366 chars)	016E (366 chars)
Micro PDF 417 128 Emulation	00 (Micro PDF 417 AIM ID & label type)	00 (Micro PDF 417 AIM ID & label type)	00 (Micro PDF 417 AIM ID & label type)	00 (Micro PDF 417 AIM ID & label type)	00 (Micro PDF 417 AIM ID & label type)	00 (Micro PDF 417 AIM ID & label type)
QR Code	00 (disable)	00 (disable)	00 (disable)	00 (disable)	00 (disable)	00 (disable)
QR Code Length Control	00 (variable)	00 (variable)	00 (variable)	00 (variable)	00 (variable)	00 (variable)
Set QR Code Length 1	0001 (1 char)	0001 (1 char)	0001 (1 char)	0001 (1 char)	0001 (1 char)	0001 (1 char)
Set QR Code Length 2	0A96 (2710 chars)	0A96 (2710 chars)	0A96 (2710 chars)	0A96 (2710 chars)	0A96 (2710 chars)	0A96 (2710 chars)
QR Code URL Link Enable	00 (disable)	00 (disable)	00 (disable)	00 (disable)	00 (disable)	00 (disable)
GS1 QR Code Enable	00 (transmit as std QR Code label)	00 (transmit as std QR Code label)	01 (transmit as GS1 QR Code label)	00 (transmit as std QR Code label)	00 (transmit as std QR Code label)	00 (transmit as std QR Code label)
Micro QR Code	00 (disable)	00 (disable)	00 (disable)	00 (disable)	00 (disable)	00 (disable)
Micro QR Code Length Control	00 (variable)	00 (variable)	00 (variable)	00 (variable)	00 (variable)	00 (variable)
Set Micro QR Code Length 1	0001 (1 char)	0001 (1 char)	0001 (1 char)	0001 (1 char)	0001 (1 char)	0001 (1 char)
Set Micro QR Code Length 2	0E74 (3700 chars)	0E74 (3700 chars)	0E74 (3700 chars)	0E74 (3700 chars)	0E74 (3700 chars)	0E74 (3700 chars)
Aztec Code	00 (disable)	00 (disable)	00 (disable)	00 (disable)	00 (disable)	00 (disable)
Aztec Length Control	00 (variable)	00 (variable)	00 (variable)	00 (variable)	00 (variable)	00 (variable)
Set Aztec Length 1	0001 (1 char)	0001 (1 char)	0001 (1 char)	0001 (1 char)	0001 (1 char)	0001 (1 char)
Set Aztec Length 2	0E74 (3700 chars)	0E74 (3700 chars)	0E74 (3700 chars)	0E74 (3700 chars)	0E74 (3700 chars)	0E74 (3700 chars)
Han Xin Code	00 (disable)	00 (disable)	00 (disable)	00 (disable)	00 (disable)	00 (disable)
Dotcode	00 (disable)	00 (disable)	00 (disable)	00 (disable)	00 (disable)	00 (disable)

# APPENDIX E

## KEYBOARD FUNCTION KEY MAPPINGS

---

USB Function Key Usage Map

ASCII	Key value	Usage Name	Modifier/Scancode
02	STX	F11	00h 44h
03	ETX	F12	00h 45h
04	EOT	GUI right Make	80h 00h
05	ENQ	GUI right Break	00h 00h
06	ACK	CTRL right Make	10h 00h
07	BEL	CTRL right Break	00h 00h
08	BS	BS	00h 2Ah
09	HT	TAB right	00h 2Bh
0A	LF	RIGHT arrow (inner keypad)	00h 4Fh
0B	VT	TAB left	02h 2Bh
0C	FF	Enter (right keypad)	00h 58h
0D	CR	CR	00h 28h
0E	SO	INSERT (inner keypad)	00h 49h
0F	SI	PAGE UP (inner keypad)	00h 4Bh
10	DLE	PAGE DOWN (inner keypad)	00h 4Eh
11	DC1	HOME (inner keypad)	00h 4Ah
12	DC2	LEFT arrow (inner keypad)	00h 50h
13	DC3	DOWN arrow (inner keypad)	00h 51h
14	DC4	UP arrow (inner keypad)	00h 52h
15	NAK	F6	00h 3Fh
16	SYN	F1	00h 3Ah
17	ETB	F2	00h 3Bh
18	CAN	F3	00h 3Ch
19	EM	F4	00h 3Dh
1A	SUB	F5	00h 3Eh
1B	ESC	ESC	00h 29h
1C	FS	F7	00h 40h

ASCII	Key value	Usage Name	Modifier/Scancode
1D	GS	<b>F8</b>	00h 41h
1E	RS	<b>F9</b>	00h 42h
1F	US	<b>F10</b>	00h 43h

The following keys can be optionally configured to correspond to the Rev C version of this function table. See "USB Keyboard Additional Interface Options" on page 85 to set this feature.

ASCII	Key value	Usage Name	Modifier/Scancode
02	STX	<b>F11</b>	00h 44h
03	ETX	<b>F12</b>	00h 45h
04	EOT	<b>GUI right Make</b>	80h 00h
05	ENQ	<b>GUI right Break</b>	00h 00h

### Scanset 1 Function Key Map

ASCII (hex)	ASCII code	Key	Scancode
02	STX	<b>ALT left Make</b>	38h
03	ETX	<b>ALT left Break</b>	B8h
04	EOT	<b>CTRL left Make</b>	1Dh
05	ENQ	<b>CTRL left Break</b>	9Dh
06	ACK	<b>CTRL right Make</b>	E0h 1Dh
07	BEL	<b>CTRL right Break</b>	E0h 9Dh
08	BS	<b>BS</b>	0Eh
09	HT	<b>TAB right</b>	0Fh
0A	LF	<b>RIGHT arrow (inner keypad)</b>	4Dh + E0
0B	VT	<b>TAB left</b>	0Fh + S
0C	FF	<b>Enter (inner keypad)</b>	1Ch + E0
0D	CR	<b>CR</b>	1Ch
0E	SO	<b>INSERT (inner keypad)</b>	52h + E0
0F	SI	<b>PAGE UP (inner keypad)</b>	49h + E0
10	DLE	<b>PAGE DOWN (inner keypad)</b>	51h + E0
11	DC1	<b>HOME (inner keypad)</b>	47h + E0
12	DC2	<b>LEFT arrow (inner keypad)</b>	4Bh + E0
13	DC3	<b>DOWN arrow (inner keypad)</b>	50h + E0
14	DC4	<b>UP arrow (inner keypad)</b>	48h + E0



## Scanset 2 Function Key Map

ASCII (hex)	ASCII code	Key	Scancode
02	STX	<b>ALT left Make</b>	11h
03	ETX	<b>ALT left Break</b>	F0h 11h
04	EOT	<b>CTRL left Make</b>	14h
05	ENQ	<b>CTRL left Break</b>	F0h 14h
06	ACK	<b>CTRL right Make</b>	E0h 14h
07	BEL	<b>CTRL right Break</b>	E0h F0h 14h
08	BS	<b>BS</b>	66h
09	HT	<b>TAB right</b>	0Dh
0A	LF	<b>RIGHT arrow (inner keypad)</b>	74h + E0
0B	VT	<b>TAB left</b>	0Dh + S
0C	FF	<b>Enter (right keypad)</b>	5Ah + E0
0D	CR	<b>CR</b>	5Ah
0E	SO	<b>INSERT (inner keypad)</b>	70h + E0
0F	SI	<b>PAGE UP (inner keypad)</b>	7Dh + E0
10	DLE	<b>PAGE DOWN (inner keypad)</b>	7Ah + E0
11	DC1	<b>HOME (inner keypad)</b>	6Ch + E0
12	DC2	<b>LEFT arrow (inner keypad)</b>	6Bh + E0
13	DC3	<b>DOWN arrow (inner keypad)</b>	72h + E0
14	DC4	<b>UP arrow (inner keypad)</b>	75h + E0
15	NAK	<b>F6</b>	0Bh
16	SYN	<b>F1</b>	05h
17	ETB	<b>F2</b>	06h
18	CAN	<b>F3</b>	04h
19	EM	<b>F4</b>	0Ch
1A	SUB	<b>F5</b>	03h
1B	ESC	<b>ESC</b>	76h
1C	FS	<b>F7</b>	83h
1D	GS	<b>F8</b>	0Ah
1E	RS	<b>F9</b>	01h
1F	US	<b>F10</b>	09h

### Scanset 3, 102-Key Function Key Map

ASCII (hex)	ASCII code	Key	Scancode
02	STX	ALT left Make	19h
03	ETX	ALT left Break	F0h 19h
04	EOT	CTRL left Make	11h
05	ENQ	CTRL left Break	F0h 11h
06	ACK	CTRL right Make	58h
07	BEL	CTRL right Break	F0h 58h
08	BS	BS	66h
09	HT	TAB right	0Dh
0A	LF	RIGHT arrow (inner keypad)	6Ah
0B	VT	TAB left	0Dh + S
0C	FF	Enter (inner keypad)	79h
0D	CR	CR	5Ah
0E	SO	INSERT (inner keypad)	67h
0F	SI	PAGE UP (inner keypad)	6Fh
10	DLE	PAGE DOWN (inner keypad)	6Dh
11	DC1	HOME (inner keypad)	6Eh
12	DC2	LEFT arrow (inner keypad)	61h
13	DC3	DOWN arrow (inner keypad)	60h
14	DC4	UP arrow (inner keypad)	63h
15	NAK	F6	2Fh
16	SYN	F1	07h
17	ETB	F2	0Fh
18	CAN	F3	17h
19	EM	F4	1Fh
1A	SUB	F5	27h
1B	ESC	ESC	08h
1C	FS	F7	37h
1D	GS	F8	3Fh
1E	RS	F9	47h
1F	US	F10	4Fh

### Scanset 3 122-Key Function Key Map

ASCII (hex)	ASCII code	Key	Scancode
02	STX	<b>ALT left Make</b>	19h
03	ETX	<b>ALT left Break</b>	F0h 19h
04	EOT	<b>CTRL left (RESET) Make only</b>	11h
05	ENQ	<b>CTRL left (RESET) Make/Break</b>	11h F0h 11h
06	ACK	<b>ONLINE Enter Make only</b>	58h
07	BEL	<b>ONLINE Enter Make/Break</b>	58h F0h 58h
08	BS	<b>BS</b>	66h
09	HT	<b>TAB right</b>	0Dh
0A	LF	<b>RIGHT arrow (inner keypad)</b>	6Ah
0B	VT	<b>TAB left</b>	0Dh + S
0C	FF	<b>CR (FIELD EXIT) Make only</b>	5Ah F0h 5Ah
0D	CR	<b>CR (FIELD EXIT) Make/Break</b>	5Ah
0E	SO	<b>INSERT (inner keypad)</b>	65h
0F	SI	<b>FIELD +</b>	79h
10	DLE	<b>FIELD -</b>	7Ch
11	DC1	<b>HOME (inner keypad)</b>	62h
12	DC2	<b>LEFT arrow (inner keypad)</b>	61h
13	DC3	<b>DOWN arrow (inner keypad)</b>	60h
14	DC4	<b>UP arrow (inner keypad)</b>	63h
15	NAK	<b>F6</b>	2Fh
16	SYN	<b>F1</b>	07h
17	ETB	<b>F2</b>	0Fh
18	CAN	<b>F3</b>	17h
19	EM	<b>F4</b>	1Fh
1A	SUB	<b>F5</b>	27h
1B	ESC	<b>ESC</b>	08h
1C	FS	<b>F7</b>	37h
1D	GS	<b>F8</b>	3Fh
1E	RS	<b>F9</b>	47h
1F	US	<b>F10</b>	4Fh

## Japanese DOS Function Key Map

ASCII value	ASCII code	Key	Scancode
02h	STX	ALT left Make	31h
03h	ETX	ALT left Break	B1h
04h	EOT	CTRL left Make	41h
05h	ENQ	CTRL left Break	C1h
06h	ACK	CTRL right Make	41h
07h	BEL	CTRL right Break	C1h
08h	BS	BS	3Eh
09h	HT	TAB right	3Ch
0Ah	LF	RIGHT arrow (inner keypad)	4Dh
0Bh	VT	TAB left	3Ch + S
0Ch	FF	Enter (right keypad)	60h
0Dh	CR	CR	3Bh
0Eh	S0	INSERT (inner keypad)	52h
0Fh	SI	PAGE UP (inner keypad)	49h
10h	DLE	PAGE DOWN (inner keypad)	51h
11h	DC1	HOME (inner keypad)	4Ch
12h	DC2	LEFT arrow (inner keypad)	4Bh
13h	DC3	DOWN arrow (inner keypad)	4Ah
14h	DC4	UP arrow (inner keypad)	4Eh
15h	NAK	F6	6Dh
16h	SYN	F1	68h
17h	ETB	F2	69h
18h	CAN	F3	6Ah
19h	EM	F4	6Bh
1Ah	SUB	F5	6Ch
1Bh	ESC	ESC	3Dh
1Ch	FS	F7	6Eh
1Dh	GS	F8	6Fh
1Eh	RS	F9	70h
1Fh	US	F10	71h

## NEC 9801-Key Function Key Map

ASCII value	ASCII code	Key	Scancode
00h	NUL	unused	n/a
01h	SOH	CR	1Ch
02h	STX	CAPS LOCK ON (make)	71h
03h	ETX	CAPS LOCK OFF (break)	F1h
04h	EOT	CTRL left Make	74h
05h	ENQ	CTRL left Break	F4h
06h	ACK	CTRL-C	60h
07h	BEL	n/a	n/a
08h	BS	BS	0Eh
09h	HT	TAB right	0Fh
0Ah	LF	RIGHT arrow (inner keypad)	3Ch
0Bh	VT	TAB left	0Fh + S
0Ch	FF	DELETE	39h
0Dh	CR	CR	1Ch
0Eh	SO	INSERT (inner keypad)	38h
0Fh	SI	KATAKANA LOCK ON (Make)	72h
10h	DLE	KATAKANA LOCK OFF (Break)	F2h
11h	DC1	HOME (inner keypad)	3Eh
12h	DC2	LEFT arrow (inner keypad)	3Bh
13h	DC3	DOWN arrow (inner keypad)	3Dh
14h	DC4	UP arrow (inner keypad)	3Ah
15h	NAK	F6	67h
16h	SYN	F1	62h
17h	ETB	F2	63h
18h	CAN	F3	64h
19h	EM	F4	65h
1Ah	SUB	F5	66h
1Bh	ESC	ESC	00h
1Ch	FS	F7	68h
1Dh	GS	F8	69h
1Eh	RS	F9	6Ah
1Fh	US	F10	6Bh

# APPENDIX F

## HOST COMMANDS

---

### ACCEPTING RS-232 AND USB COM COMMANDS

The scanner responds to the following RS-232 and USB COM commands:

COMMAND	ASCII	HEX	COMMENT
Enable Scanner	E	0x45	
Disable Scanner	D	0x44	
Reset Scanner	R	0x52	
Not On File Indication	F	0x46	Long series of beeps
Beep Good Read Tone	B	0x42	Beeps if Good Read Beep is enabled
Force Good Read Tone	!	0x01	Beeps regardless of beep setting
Identification request	i	0x69	Returns long response <sup>a</sup>
Health request	h	0x68	Returns long response <sup>a</sup>
Status request	s	0x73	Returns long response <sup>a</sup>
Beep on ASCII BEL	!	0x07	Beeps if Beep on ASCII BEL is enabled

a. Call Tech Support for information.

If one of the above commands is received, the scanner will perform the steps indicated for the command. Host commands for other interfaces are also available. Contact Tech Support for more details.

Also see the section [“Image Capture to the Host by Host Command”](#) on page 40 for details concerning that feature.

# APPENDIX G

## SAMPLE SYMBOLS

---

### 1D SYMBOL SAMPLES

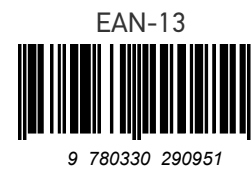

### 1D Symbols (continued)

Code 2 of 5

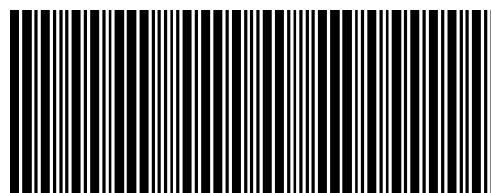

123456

GS1 DataBar Omnidirectional



(01)00123456789012

GS1 DataBar Expanded



0100123456789050

GS1 DataBar Limited



(01)16543210987654



# 2D SAMPLE SYMBOLS

PDF 417



A12B3C

Micro PDF 417



BV17453

Datamatrix

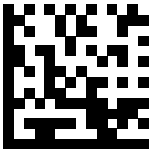

1314H17LL

QR Code

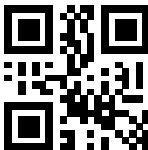

35900G9

Micro QR Code



ABCDEF

Aztec



This is an Aztec Code

# COMPOSITE SAMPLE SYMBOLS

GS1 DataBar Limited Composite

(17) 050923 (10) ABC123



GS1 DataBar Truncated Composite

(17)050923(10)ABC123



# APPENDIX H

## MICROSD CARD

---

<b>MICROSDHC COMPATIBILITY</b> <a href="#">starting on page 290</a> <ul style="list-style-type: none"><li>• <a href="#">microSD Card Insertion</a></li><li>• <a href="#">microSD Card Removal</a></li></ul>
<b>AUTORUN FILE PROCESSING</b> <a href="#">starting on page 291</a>
<b>MICROSD FUNCTION SUMMARY</b> <a href="#">starting on page 291</a>
<b>MICROSD FUNCTION DETAILS</b> <a href="#">starting on page 292</a> <ul style="list-style-type: none"><li>• <a href="#">From Scanner to microSD Card</a></li><li>• <a href="#">From microSD Card to Scanner</a></li></ul>

## MICROSDHC COMPATIBILITY

At the time of this writing, the microSD card interface for this product supports SD-Memory Card Specifications/ Part 1. Physical Layer Specification; Version 1.01, but the processor MCI can communicate with SDHC Cards. For example, the scanner can perform the functions specified in this appendix for the SDA 2.0 specification. Both FAT16 and FAT32 formats are supported.

Filenames are limited to the 8.3 file naming format (i.e., FILENAME . EXT), and MUST be capitalized.

### microSD Card Insertion

1. Read all of these instructions before starting.
2. If you have not already done so, remove the scanner from its installed position to allow access to the microSD card slot.
3. Separate the scanner from its back cover.
4. Ensure there are no other cables attached to the scanner, then apply power and wait for the reset beep.
5. Lift and rotate the rubber cover to access the card slot, then carefully insert the microSD card into the slot until it "clicks" into place.

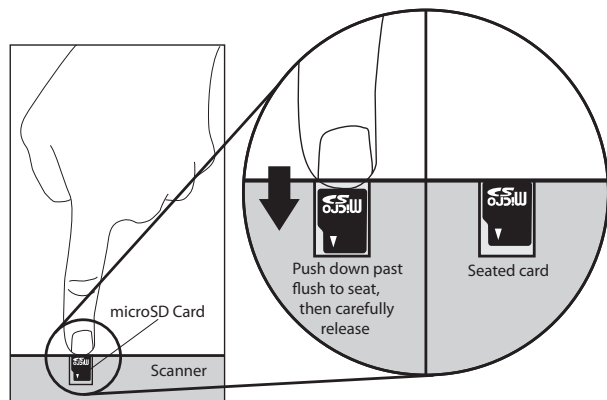

**CAUTION: The microSD card slot is spring loaded. Keep your finger lightly in place atop the card until you are sure it is fully seated in place. See the illustration on the following page.**

**Use your finger or thumbnail to push in on the top edge of the card to be slightly below flush with the scanner enclosure when inserting or removing the card. This will engage/disengage the spring mechanism.**

**Never insert tools or other foreign objects into the microSD card slot.**

6. If installed properly, you should immediately hear an audible signal upon insertion or removal of a microSD card. Various operations will also be indicated by the scanner's good read LED.

### microSD Card Removal

1. Push in gently using your finger or thumbnail to disengage and remove the microSD card. Remember to keep your finger in place atop the card's edge to avoid accidentally "launching" the card from the spring-loaded slot.
2. Reconnect all cables which were disconnected earlier.

## AUTORUN FILE PROCESSING

After insertion of the card, the scanner will mount the microSD card and search for the file “**AUTORUN.DLS**”. Embedded in that file is a validation pattern of the ASCII strings “\$START\$” and “\$END\$” located at the respective starting and ending of the file.

If the validation pattern is found, the file may contain any of the following commands. The scanner will parse the file taking action according to these commands. Filenames in this format specify a user-defined name.

Example AUTORUN.DLS file:

```
$START$ (required)
CONFIG, FILENAME . TEX
DUMPSTATS, FILENAME . TXT
DUMPCFG, FILENAME . TEX
LOADSW, FILENAME . S37
$END$ (required)
```

## MICROSD FUNCTION SUMMARY

The following table summarizes various functions of microSD card. Contact tech support regarding upgrade license for new features.

FUNCTION		Export Status	Export Configuration	Load Applic	Load Config	Load CPLD Code <sup>a</sup>	Feature Upgrade <sup>b</sup>
Direction	Scanner ⇒ microSD Card	√	√				
	microSD Card ⇒ Scanner			√	√	√	√
Initiated by	Scanning a label			√	√		
	AUTORUN.DLS file in microSD card	√	√	√	√	√	√

- a. The only way to load CPLD code (i.e., FPGA code) is to load a new application package.
- b. The only way to do a feature upgrade is to load a new application package.

## MICROSD FUNCTION DETAILS

### From Scanner to microSD Card

#### Capture and save an image to a microSD card by button press

1. Insert the secure microSD card into the scanner.
2. Place the item to be captured in front of the scanner.
3. Press and release the Camera Button for one second. The scanner will automatically capture and save the image to the microSD card.
4. The scanner will emit an audible signal when complete, and the image is saved to the microSD card.



**NOTE: The microSD card must contain a secure file to save images. Contact Customer Support for more details about this feature.**

**The image file name range is from image-1 to image-999. If the same name already exists in the microSD card, the scanner skips that name and uses the next.**

**Image format (.BMP, .JPG), image size (VGA, WVGA, Full size), Brightness (0~9), contrast (0~9), and JPG compression ratio (0~100) are defined in configuration.**

#### Export a Configuration file from the Scanner to the microSD card

##### By AUTORUN.DLS file

1. Generate a text file by any text editor as follows and save it as AUTORUN.DLS .
 

```

$START$
DUMPCFG,SDCONFIG.TEX (Filename can be anything, for example
"SOMETHING.TEX")
$END$

```
2. Save or copy file AUTORUN.DLS to microSD card
3. Insert the microSD card to scanner.
4. Wait for 3 seconds; a scanner configuration file named SDCONFIG.TXT is saved to the microSD card.

### From microSD Card to Scanner

#### Application code load to scanner

##### By AUTORUN.DLS file

1. Generate a text file by any text editor as follows and save it as AUTORUN.DLS
 

```

$START$
LOADSW,R96-APP1.S37
$END$

```

2. Save or copy file `AUTORUN.DLS` to microSD card and copy the application code (example `R96-APP1.S37`) to the microSD card.
3. Insert the microSD card into the scanner.
4. Upon scanner audio indication of completion, the application code `R96-APP1.S37` is loaded to the scanner. Typically, this takes about 45 seconds.

## Configuration load to scanner

### By Autorun file

1. Generate a text file by any text editor as follows and save it as `AUTORUN.DLS`  
**\$START\$**  
**CONFIG,R96-CFG1.TEX**  
**\$END\$**
2. Save or copy the `autorun.dls` file, and copy the CPLD code (example `R96-CFG1.TEX`) to the microSD card.
3. Insert the microSD card into the scanner.
4. Upon scanner audio indication of completion, configuration `R96-CFG1.TEX` is loaded to the scanner.

# APPENDIX I

## HANDHELD DATA FORMAT REQUIREMENTS

---

This appendix provides application notes to describe the general format of data that can be accepted by the scanner from a handheld scanner connected via the USB port.

### HANDHELD DATA FORMAT REQUIREMENTS GENERAL

- USB handhelds enumerate as a CDC ACM serial device.
- USB devices should also bracket the data with the RTS equivalent.
- The time between character transmission can be no longer than 50 milliseconds.
- Symbologies requiring fixed lengths (UPC/EAN) will enforce length requirements for validation of the label.
- Handheld will be required to transmit start and stop characters for Codabar and Code39 labels.
- Appropriate industrial length requirements will be enforced (if configured) for validation of the label.
- Maximum label lengths will be enforced for label validation (i.e. labels longer than the maximum label size will not be validated).
- Standard Datalogic formats generally use a single prefix character. See specific formats section.
- Maximum label size allowed including identifiers is 2714 bytes
- Recommendations:
  - Handheld should not be configured for audible label read indication.
  - Handheld should not be configured for visual label read indication.
  - Handheld should not be configured for continuous label read mode.

### Datalogic Handheld Data Format Requirements

The following sections describe label transmission formats that are typically observed in factory configurations of Datalogic handheld scanners.

#### GS1 DataBar Omnidirectional

- Prefix must be ASCII characters 'R4'
- Check character must be included in label
- Application identifier "01" must follow the prefix and precede the base label
- Label length excluding prefix characters must be 16 characters.
- Example: 'R40101044123456789'



## GS1 DataBar Expanded

- Prefix must be ASCII characters 'R4'
- Check character must be included in label

## UPC-A

- Number system must be included in label data.
- Check digit must be included in label data and is assumed to be correct.
- Prefix must be an ASCII character 'A' - total length including prefix must be 13.
- Example: 'A060992011187'.

## UPC-A with 2-Digit Supplemental

- Number system must be included in label data.
- Check digit must be included in label data and is assumed to be correct.
- Supplemental data is appended to base label.
- Prefix must be an ASCII character 'A' - total length including prefix must be 15.
- Example: 'A06099201118712'.

## UPC-A with 5-Digit Supplemental

- Number system must be included in label data
- Check digit must be included in label data and is assumed to be correct
- Prefix must be an ASCII character 'A' - total length including prefix must be 18
- Example: 'A06099201118712345'

## UPC-E

- Number system must be included in label data
- Check digit must be included in label data and is assumed to be correct
- Prefix must be an ASCII character 'E' - total length including prefix must be 9
- Example: 'E09988750'

## UPC-E with 2-Digit Supplemental

- Number system must be included in label data.
- Check digit must be included in label data and is assumed to be correct.
- Supplemental data is appended to base label.
- Prefix must be an ASCII character 'E' - total length including prefix must be 11.
- Example: 'E0998875012'.

## UPC-E with 5-Digit Supplemental

- Number system must be included in label data.
- Check digit must be included in label data and is assumed to be correct.
- Prefix must be an ASCII character 'E' - total length including prefix must be 14.
- Example: 'E0998875012345'.

## EAN-8

- Check digit must be included in label data and is assumed to be correct
- Prefix must be an ASCII characters 'FF' - total length including prefix must be 10
- Example: 'FF00210126'

## EAN-8 with 2-Digit Supplemental

- Check digit must be included in label data and is assumed to be correct.

- Supplemental data is appended to base label.
- Prefix must be an ASCII characters 'FF' - total length including prefix must be 12.
- Example: 'FF0021012612'.

### **EAN-8 with 5-Digit Supplemental**

- Check digit must be included in label data and is assumed to be correct.
- Prefix must be an ASCII characters 'FF' - total length including prefix must be 15.
- Example: 'FF0021012612345'.

### **EAN-13**

- Check digit must be included in label data and is assumed to be correct
- Prefix must be an ASCII character 'F' - total length including prefix must be 14
- Example: 'F1101234567891'

### **EAN-13 with 2-Digit Supplemental**

- Check digit must be included in label data and is assumed to be correct
- Supplemental data is appended to base label
- Prefix must be an ASCII character 'F' - total length including prefix must be 16
- Example: 'F110123456789112'

### **EAN-13 with 5-Digit Supplemental**

- Check digit must be included in label data and is assumed to be correct.
- Prefix must be an ASCII character 'F' - total length including prefix must be 19.
- Example: 'F110123456789112345'.

### **Code 39**

- Check character must be included in label data.
- Label length including start, stop and check characters and excluding prefix character must meet requirements imposed by the main scanner's fixed or variable label length control for this symbology type.
- Start and stop characters "\*" must be included in label.
- Prefix must be an ASCII character '\*'.
- Example: '\*\*Code 39.TEST\*'.

### **Code 39-Pharmacode**

- Check character must be included in label data.
- Label length including start, stop and check characters and excluding prefix character must meet requirements imposed by the main scanner's fixed or variable label length control for this symbology type.
- Start and stop characters "\*" must be included in label.
- Prefix must be an ASCII character 'p'.
- Example: 'p\*123456789\*'.

### **I 2 of 5**

- Check character must be included in label data.
- Label length including check characters and excluding prefix character must meet requirements imposed by the main scanner's fixed or variable label length control for this symbology type.
- Prefix must be an ASCII character 'i'.
- Example: 'i0123456789'.

## Codabar

- Check character must be included in label data.
- Label length including check character and excluding prefix character must meet requirements imposed by the main scanner's fixed or variable label length control for this symbology type.
- Prefix must be an ASCII character '%'.
- Start stop character sets must meet the matching requirement set forth by the scanner configuration item *Codabar Start Stop Character Match*.
- Start stop character sets must be of the form ABCD/ABCD and must be included in the label.
- Example: '%s\$99.95s' (the lower case 's' at each end of the example is a placeholder for the start stop character set).

## Code 128

- Prefix must be an ASCII character '#'.
- Label length excluding prefix character or function code 3 for Code 128 programming labels must meet requirements imposed by the main scanner's fixed or variable label length control for this symbology type.
- Function characters may be transmitted as a hexadecimal value 8x. Where x correlates to function characters 1 thru 4 as follows:
  - x80 = function code 1
  - x81 = function code 2
  - x82 = function code 3
  - x83 = function code 4
- For Code 128 programming labels the format is of the general form '#/82nnnnn/r' - /82 is hexadecimal 82 and /r is carriage return.
- Example: '#Code\_128.Test'.

## MSI

- Check character must be included in label data.
- Label length including check character and excluding prefix character must meet requirements imposed by the main scanner's fixed or variable label length control for this symbology type.
- Prefix must be an ASCII character '@'.
- Example: '@144769254'.

## Code 93

- Prefix must be an ASCII character '&'.
- Label length excluding prefix character must meet requirements imposed by the main scanner's fixed or variable label length control for this symbology type.
- Example: '&Code93-test'.

## PDF417

- Prefix must be an ASCII character 'P'.
- Label length excluding prefix character cannot exceed 300 characters. In addition to this, label length excluding prefix character must meet requirements imposed by the main scanner's fixed or variable label length control for this symbology type.

## AIM Formats

AIM specifies a 3-character string that is attached as a prefix to the label data for transmission. Because AIM specifies one identifier for UPC-A, UPC-E and EAN-13 labels, UPC-A, UPC-E and EAN-13 will be received from the handheld and transmitted by the scanner as EAN-13. The ']' character must be the first character received in the label transmission from the handheld.

The following sections describe the prefix strings and identify what specific label characteristics can be supported.

### UPC-A

- AIM does not specify UPC-A as a separate symbology using this transmission format - labels will be transmitted as EAN-13.
- Example: ']E00060992011187'.

### UPC-E

- AIM does not specify UPC-E as a separate symbology using this transmission format - labels will be transmitted as EAN-13.
- Example: ']E00000000998875'.

### EAN-13

- Check digit must be included in label data and is assumed to be correct.
- Prefix must be ASCII characters ']E0' - total length including prefix must be 16.
- Example: ']E01101234567891'.

### EAN-8

- Check digit must be included in label data and is assumed to be correct.
- Prefix must be ASCII characters ']E4' - total length including prefix must be 11.
- Example: ']E400210126'.

### 2-Digit Supplemental

- Supplemental data is appended to any EAN base label.
- Prefix must be ASCII characters ']E1'.
- length of Supplemental data including prefix must be 5. Total required length is 21 for EAN-13 and 16 for EAN-8.
- Examples: add-on portion is highlighted data is underlined.

UPC-A 2-Digit add-on	]E00060992011187 <u>JE112</u> '
UPC-E 2-Digit add-on	]E00000000998875 <u>JE112</u> '
EAN-8 2-Digit add-on	]E400210126 <u>JE112</u> '
EAN-13 2-Digit add-on	]E01101234567891 <u>JE112</u> '

### 5-Digit Supplemental

- Supplemental data is appended to any EAN base label.
- Prefix must be ASCII characters ']E2'.
- Length of supplemental data including prefix must be 8. Total required length is 24 for EAN-13 and 19 for EAN-8.

- Examples: add-on portion is highlighted data is underlined.

UPC-A 5-Digit add-on	']E00060992011187]E2 <u>12345</u> '
UPC-E 5-Digit add-on	']E00000000998875]E2 <u>12345</u> '
EAN-8 5-Digit add-on	']E400210126]E2 <u>12345</u> '
EAN-13 5-Digit add-on	']E01101234567891]E2 <u>12345</u> '

## Bookland

- The 'Bookland' / ISBN code will be formatted as a vendor specific AIM label.
- Prefix must be ASCII characters ']X0'.
- length of label data including prefix is 13.
- Examples: ']X01234567890'.

## Code 39

- Check character must be included in label data.
- Label length including start, stop and check characters and excluding prefix characters must meet requirements imposed by the main scanner's fixed or variable label length control for this symbology type.
- Start and stop characters "\*" must be included in label.
- Prefix must be ASCII characters ']A0' or ']A1'.
- Example: '\*]A0Code 39.TEST\*'.

## Codabar

- Check character must be included in label data.
- Label length including check character and excluding prefix characters must meet requirements imposed by the main scanner's fixed or variable label length control for this symbology type.
- Prefix must be ASCII characters ']F0'.
- Start stop character sets must meet the matching requirement set forth by the scanner configuration item *Codabar Start Stop Character Match*.
- Start stop character sets s must be of the form ABCD/ABCD and must be included in the label.
- Example: ']F0s\$99.95s' (the lower case 's' at each end of the example is a placeholder for the start stop character set).

## MSI

- Check character must be included in label data.
- Label length including check character and excluding prefix characters must meet requirements imposed by the main scanner's fixed or variable label length control for this symbology type.
- Prefix must be ASCII characters ']M0'.
- Example: ']M0144769254'.

## Code 93

- Prefix must be ASCII characters ']G0'.
- Label length excluding prefix characters must meet requirements imposed by the main scanner's fixed or variable label length control for this symbology type.
- Example: ']G0Code93-test'.

## RSS-14

- Prefix must be ASCII characters ']e0'.
- Check character must be included in label.
- Label length excluding prefix characters must be 14 characters.
- Example: ']e001044123456789'.

## RSS Expanded

- Prefix must be ASCII characters ']e0'.
- Label length excluding prefix characters must be at least 1 character. Maximum length is the maximum label size supported by the scanner.
- Example: ']e001900123456789083103001750'.

## I 2 of 5

- Check character must be included in label data.
- Label length including check characters and excluding prefix characters must meet requirements imposed by the main scanner's fixed or variable label length control for this symbology type.
- Prefix must be an ASCII character ']I1' (other prefixes specify different check character properties which are not supported).
- Example: ']I10123456789'.

## Code 128 / EAN128

- Prefix must be either ASCII characters ']C0', ']C1' or ']C2'.
- Label length excluding prefix character must meet requirements imposed by the main scanner's fixed or variable label length control for this symbology type.
- If EAN-128 Symbology is Enabled and prefix is ']C1', label will be identified as an EAN128 otherwise it is identified as a Code 128.
- A prefix of ']C0' designates that no function code is present in the 1st or 2nd character position.
- A prefix of ']C2' designates that a function code 1 is present in the 2nd character.
- Example: ']C0Code\_128.Test'.

## PDF417

- Prefix must be an ASCII characters ']L0'.
- Label length excluding prefix character cannot exceed 300 characters. In addition to this, label length excluding prefix character must meet requirements imposed by the main scanner's fixed or variable label length control for this symbology type.
- Example: ']L0pdf\_test\_label'.

## “Unknown” AIM ID (an AIM ID which is not specified above)

If a label is received that does not have an AIM ID as specified above, and the first three label characters qualify as follows...

- The first character is a ']'
- The second character is a capital or small letter
- The third character is a digit

...then the label type is set to GENERIC\_DATA and the “unknown” AIM ID is left-appended to the beginning of the label data.

# APPENDIX J

## ASCII CHART

---

ASCII Char.	Hex No.	ASCII Char.	Hex No.	ASCII Char.	Hex No.	ASCII Char.	Hex No.
NUL	00	SP	20	@	40	'	60
SOH	01	!	21	A	41	a	61
STX	02	"	22	B	42	b	62
ETX	03	#	23	C	43	c	63
EOT	04	\$	24	D	44	d	64
ENQ	05	%	25	E	45	e	65
ACK	06	&	26	F	46	f	66
BEL	07	'	27	G	47	g	67
BS	08	(	28	H	48	h	68
HT	09	)	29	I	49	i	69
LF	0A	*	2A	J	4A	j	6A
VT	0B	+	2B	K	4B	k	6B
FF	0C	,	2C	L	4C	l	6C
CR	0D	-	2D	M	4D	m	6D
SO	0E	.	2E	N	4E	n	6E
SI	0F	/	2F	O	4F	o	6F
DLE	10	0	30	P	50	p	70
DC1	11	1	31	Q	51	q	71
DC2	12	2	32	R	52	r	72
DC3	13	3	33	S	53	s	73
DC4	14	4	34	T	54	t	74
NAK	15	5	35	U	55	u	75
SYN	16	6	36	V	56	v	76
ETB	17	7	37	W	57	w	77
CAN	18	8	38	X	58	x	78
EM	19	9	39	Y	59	y	79
SUB	1A	:	3A	Z	5A	z	7A
ESC	1B	;	3B	[	5B	{	7B
FS	1C	<	3C	\	5C		7C
GS	1D	=	3D	]	5D	}	7D
RS	1E	>	3E	^	5E	~	7E
US	1F	?	3F	_	5F	DEL	7F

© 2021-2022 Datalogic S.p.A. and /or its affiliates • All rights reserved • Without limiting the rights under copyright, no part of this documentation may be reproduced, stored in or introduced into a retrieval system, or transmitted in any form or by any means, or for any purpose, without the express written permission of Datalogic S.p.A. and/or its affiliates • Datalogic and the Datalogic logo are registered trademarks of Datalogic S.p.A. in many countries, including the U.S. and the E.U.

 **DATALOGIC**  
[www.datalogic.com](http://www.datalogic.com)

**Datalogic S.r.l.**

Via S. Vitalino, 13 | 40012 Calderara di Reno | Bologna - Italy  
Tel. +39 051 3147011 | Fax +39 051 3147205



820118900

(Rev C)

April 2022