

FortiAP™ Series



FortiLAN Cloud- or FortiGate-Managed Access Points

FortiAP™ access points are managed centrally by the integrated WLAN controller of any FortiGate® security appliance or through the FortiLAN Cloud provisioning and management portal. With the integration of the wireless controller functionality into the market-leading FortiGate appliance, these APs are perfect for campus and branch deployments. Fortinet's Security Fabric enables you to easily manage wired and wireless security from a Single-pane-of-glass management console and protects your network from the latest security threats.

Highlights

- Unified management console simplifies operations, ensuring consistency in effective policy enforcement and compliance
- Built-in foundation for zero-trust network access (ZTNA) and secure access service edge (SASE), allowing you the flexibility to easily deploy microbranches with the security you need at the edge of your network
- Wireless LAN security done right, from the leader in network security. Integrated Firewall, IPS, Application Control, and Web Filter protect the wireless LAN from the latest security threats
- Protects the network from advanced wireless threats and satisfies industry compliance such as PCI DSS

HARDWARE OFFERINGS		ANTENNA TYPE	INDOOR USE	OUTDOOR USE
802.11be Wi-Fi 7				
FAP-441K	4x4 Indoor quad-radio 11be 6Ghz Capable APs	Internal	☑	
FAP-443K	4x4 Indoor quad-radio 11be 6Ghz Capable APs	External	☑	
802.11ax Wi-Fi 6E				
FAP-431G	4x4 Indoor tri-radio 11ax 6Ghz Capable APs	Internal	☑	
FAP-432G	4x4 Ruggedized Tri-radio indoor/outdoor 11ax (6Ghz) Capable APs	External	☑	☑
FAP-433G	4x4 Indoor tri-radio 11ax 6Ghz Capable APs	External	☑	
FAP-231G	2x2 Indoor tri-radio 11ax 6Ghz Capable APs	Internal	☑	
FAP-233G	2x2 Indoor tri-radio 11ax 6Ghz Capable APs	External	☑	
FAP-234G	2x2 Ruggedized Tri-radio indoor/outdoor 11ax (6Ghz) Capable APs	Internal	☑	☑
802.11ax Wi-Fi 6				
FAP-831F	8x8 Indoor tri-radio 11ax AP	Internal	☑	
FAP-433F	4x4 Indoor tri-radio 11ax APs	External	☑	
FAP-432F	4x4 Ruggedized indoor/outdoor tri-radio 11ax AP	External	☑	☑
FAP-432FR	4x4 C1D2 Certified tri-radio 11ax AP	External	☑	☑
FAP-431F	4x4 Indoor tri-radio 11ax APs	Internal	☑	
FAP-231F	2x2 Indoor tri-radio 11ax AP	Internal	☑	
FAP-234F	2x2 Ruggedized indoor/outdoor tri-radio 11ax AP	Internal	☑	☑
FAP-23JF	2x2 Wall-mount tri-radio AP	Internal	☑	
802.11ac (Wave 2) Wi-Fi 5				
FAP-223E	2x2 Indoor dual-radio APs	External	☑	
FAP-221E	2x2 Indoor dual-radio APs	Internal	☑	

Use Cases

FortiAPs allow for a versatile collection of installation topologies with options to fit any enterprise.



Campus

A single building with multiple floors, or a corporate or education campus with a group of large buildings.

- High-capacity designs including Dual 5GHz and tri-band with Wi-Fi 6E allow a maximal number of client devices to attach to the network at the same time without over-air congestion
- Complete NOC functionality with network visibility and AIOps simplify a complex network deployment into a solution manageable by IT teams of any size



Branch Office / SD-Branch

A highly distributed number of small sites, often with no on-site IT.

- Built in NAC functions* allow secure onboarding of devices at remote locations where IT doesn't have reliable visibility
- Management orchestration with zero-touch deployment allows for quick and easy rollouts without the need for skilled installers at each site



Micro Branch

Ultra small sites that still fall under IT's responsibility.

- Can act as a SASE endpoint as a foundation for zero-trust network access (ZTNA)
- Simple management and provisioning through FortiSASE interface



Remote Workers

A remote AP installed at a worker's home or at micro-branch office space.

- Split tunneling allows local traffic to remain local while sending other traffic to the data center for inspection when needed
- Desktop mounting options for wall-plate models allow the use of Ethernet as well as Wi-Fi connectivity while leveraging the same secure tunnel



SMB

Single site or small collection of sites with limited IT resources.

- Built-in NAC functions* bring security to the wireless network with no need to install and manage additional products
- Network and security convergence decreases management overhead while keeping the network secure

*FortiGate-managed installations only.

Highlights

FortiAP 443K and 441K

These high performance enterprise class Wi-Fi 7 indoor APs provide four radios and four spatial streams. These access points support the 6 GHz band and have 10 Gigabit Ethernet ports. The APs can provide 24/7 scanning across all bands while still providing access on 2.4 GHz, 5 GHz, and 6 GHz bands. The integrated BLE/ ZigBee radio can be used for beacons and locationing applications.



Wi-Fi 7 | Tri-Radio 2.4GHz + 5GHz + 6GHz + Scan | 8 Internal Antennas /
4 External RPSMA Connectors + 4 External Permanently attached Antennas



4x4 MU-MIMO | Up to 1.148 Gbps + 8.648 Gbps + 11.53 Gbps



FAP-441K



FAP-443K

Specifications

	FortiAP 441K	FortiAP 443K
Hardware		
Type	Indoor AP	
Number of Radios	4 + 1 BLE	
Number of Antennas	Internal x4 2.4/5GHz Dual band WiFi + x4 6GHz band WiFi x2 Tri-band Scanning + 1 Single band 2.4GHz BLE/ ZigBee + 1GPS antenna	External x4 2.4/5GHz Dual band WiFi + x4 6GHz band WiFi x2 Tri-band Scanning + 1 Single band 2.4GHz BLE/ ZigBee + 1GPS antenna
Antenna Type and Peak Gain	Omni Directional Antenna Dual band antenna: 4.0 dBi for 2.4GHz 5.6 dBi for 5 GHz 6GHz antenna: 5.4dBi for 6GHz band Tri-band antenna: 4.0 dBi for 2.4 GHz, 6.0 dBi for 5 GHz and 5.7 dBi for 6 GHz band BLE antenna: 5.1 dBi for 2.4GHz GPS active antenna: 2.2 dBi antenna	Omni Directional Antenna Dual band antenna: 5.0 dBi for 2.4GHz 5.0 dBi for 5 GHz 6GHz antenna: 5.8dBi for 6GHz band Tri-band antenna: 5.0 dBi for 2.4 GHz, 5.0 dBi for 5 GHz and 4.0 dBi for 6 GHz band BLE antenna: 5.1 dBi for 2.4GHz GPS active antenna: 2.2 dBi antenna
Frequency Bands (GHz)	<ul style="list-style-type: none"> . ISM 2.4-2.484 GHz . U-NII-1 5.15-5.25 GHz . U-NII-2A 5.25-5.35 GHz . U-NII-2C 5.47-5.725 GHz . U-NII-3 5.725-5.85 GHz . U-NII-4 5.850-5.925 GHz . U-NII-5 5.925-6.425 GHz . U-NII-6 6.425-6.525 GHz . U-NII-7 6.525-6.875 GHz . U-NII-8 6.875-7.125 GHz 	
Radio 1 Capabilities	Frequency band: 2.4GHz Channel width: 20/40MHz Modulation: BPSK, QPSK, 64/256/1024 QAM MIMO Chains: 4x4 Service	
Radio 2 Capabilities	Frequency band: 5.0GHz UNII-1 to UNII-4 Channel width: 20/40/80/160/240MHz Modulation: BPSK, QPSK, 64/256/1024/4096 QAM MIMO Chains: 4x4 Service	
Radio 3 Capabilities	Frequency band: 6.0GHz UNII-5 to UNII-8 Channel width: 20/40/80/160/320MHz Modulation: BPSK, QPSK, 64/256/1024/4096 QAM MIMO Chains: 4x4 Service	
Radio 4 Capabilities	Frequency band: 2.4/5.0/6.0GHz Channel width: 20/40/80/160MHz Modulation: BPSK, QPSK, 64/256/1024 QAM MIMO Chains: 2x2 Scanning	
Maximum Data Rate	2.4GHz band: up to 1.148 Gbps 5.0GHz band: up to 8.648 Gbps 6.0GHz band: up to 11.530 Gbps	
Bluetooth Low Energy (BT/BLE) Radio	Bluetooth scanning and iBeacon advertisement @10 dBm max TX power	
GNSS	<ul style="list-style-type: none"> . Supported Bands GPS L1 C/A, QZSS L1 C/A: . Default constallations 1575.42 MHz, . Number of Tracking Channels GLONASS L1: . Number of Concurrent GNSS BDS B11 : 1561.098 MHz, . SBAS Galileo E1: 1575.42 MHz . Sensitivity (@ Default Constallations) GPS + GLONASS + BDS + Galileo + QZSS 47 5 WAAS, EGNOS, MSAS and GAGAN -147dBm 	
Interfaces	x2 100M/1000M/2.5G/5.0G/10G Multigigabit Ethernet (RJ45) x1 Type 3.0 USB at 4.5W x1 RS-232 RJ45 Serial Port	
Power over Ethernet (PoE)	x1 802.3bt PoE default or x2 802.3at PoE (Dual PoE current sharing)	



	FortiAP 441K	FortiAP 443K
Simultaneous SSIDs	Up to 24	
EAP Type(s)	EAP-TLS, EAP-TTLS/MSCHAV2, PEAPv0/EAP-MSCHAPv2, PEAPv1/EAP-GTC, EAP-SIM, EAP-AKA, EAP-FAST	
User/Device Authentication	WPA™, WPA2™, and WPA3™ with 802.1x or Preshared key, WEP, Web Captive Portal, MAC blacklist and whitelist	
Maximum Tx Power (Conducted)	2.4GHz band: 29 dBm / 794 mW (4 chains combined)* 5.0GHz band: 27.8 dBm / 602 mW (4 chains combined)* 6.0GHz band: 23 dBm / 200 mW (4 chains combined @ 160MHz BW)*	
Kensington Lock	Yes	
IEEE Standards	802.11a, 802.11b, 802.11be, 802.11e, 802.11g, 802.11h, 802.11i, 802.11j, 802.11k, 802.11n, 802.11r, 802.11v, 802.11ac, 802.11ax, 802.1X, 802.3ad, 802.3at, 802.3bt, 802.3az	
SSID Types Supported	Local-Bridge, Mesh, and Tunnel	
Per Radio Client Capacity	Up to 512 clients per radio (Radio1, Radio2 and Radio3)	
Cellular Co-existence	Yes	
LED Off Mode	Yes	
Advanced 802.11 Features		
OFDMA	Yes	
Spatial Reuse (BSS Coloring)	Yes	
UL MU-MIMO	Yes	
DL- MU-MIMO	Yes	
Enhanced Target Wake Time (TWT)	Yes	
ZeroWait DFS	No	
Onboard Security Functions		
UTP Capable	No	
UTP Features	N/A	
Wireless Monitoring Capabilities		
Rogue Scan radio modes	Background, Dedicated	
WIPS / WIDS radio modes	Background, Dedicated (recommended)	
Packet Sniffer Mode	Yes	
Spectrum Analyzer	Yes	
Dimensions		
Length x Width x Height	9.84 × 9.84 × 2.26 inches (250 × 250 × 57.5 mm)	
Weight	4.36 lbs (1.98 kg)	
Package (shipping) Weight	6.9 lbs (3.13 kg)	
Mounting Options	Ceiling, T-Rail, and Wall	
Included Accessories	Standard Mounting Kit for Ceiling, T-Rail, and Wall	
Environment		
Power Supply	GPI-145 or SP-FAP250-PA-10	
Power Consumption (Max)	41.7 W	
PoE Mode	802.3at : R1(2.4Ghz) and R2(5 GHz) operation in Low Tx Power 17dBm ; Chain 4x4; USB – Disabled 802.3bt / DC : Full – Tx Power Full ; Chain 4x4; USB- Enabled	
Humidity	5% to 90% non-condensing	
Operating/Storage Temperature	32°F to 122°F (0°C to 50°C) / -22°F to 158°F (-30°C to 70°C)	
Directives	Low Voltage Directive * RoHS	
UL2043 Plenum Material	Yes	
Mean Time Between Failures	>10 Years	
IP Rating	N/A	
Surge Protection Built In	Yes	
Hit-less PoE Failover	N/A	
Certifications		
Wi-Fi Alliance Certified	Certified (Wi-Fi 7 in progress)	
DFS	No	
Warranty		
Limited Lifetime Warranty	Yes	

RF Rx/Tx Performance Table

FORTIAP 441K / 443K						
Data rate	2.4 GHz Band		5.0 GHz Band		5.0 GHz Band	
	Tx power/chain (dBm)	Rx Sensitivity (dBm)	Tx power/chain (dBm)	Rx Sensitivity (dBm)	Tx power/chain (dBm)	Rx Sensitivity (dBm)
	802.11b					
1 Mbps	23	-96				
11 Mbps	23	-99				
	802.11g		802.11a			
6 Mbps	23	-94	23	-90		
54 Mbps	22	-77	20	-73		
	802.11n HT20					
MCS0	23	-94	23	-90		
MCS7	21	-77	20	-72		
	802.11n HT40					
MCS0	23	-93	23	-89		
MCS7	21	-74	20	-70		
	802.11ac VHT20					
MCS0	23	-95	22	-88		
MCS9	21	-73	19	-69		
	802.11ac VHT40					
MCS0	22	-92	22	-87		
MCS9	19	-70	19	-64		
	802.11ac VHT80					
MCS0			21	-85		
MCS9			18	-62		
	802.11ax HE20		802.11ax HE20 / 802.11be EHT20			
MCS0	23	-92	22	-88	22	-87
MCS11	18	-70	19	-65	19	-65
	802.11ax HE40		802.11ax HE40 / 802.11be EHT40			
MCS0	22	-90	22	-87	20	-85
MCS11	17	-61	19	-63	18	-62
			802.11ax HE80 / 802.11be EHT80			
MCS0			21	-85	19	-82
MCS13			18	-61	17	-59
			802.11be EHT160		802.11ax HE80 / 802.11be EHT80	
MCS0			19	79	18	-81
MCS13			17	-56	16	-58
			802.11be EHT240			
MCS0			17	79		
MCS13			16	-56		
					802.11be EHT320	
MCS0					19	-80
MCS13					15	-58



Antenna Radiation Patterns

FAP-441K

FAP-443K



Highlights

FortiAP 431G and 433G

These high performing enterprise class extended frequency band Wi-Fi 6E indoor APs provide three radios and four spatial streams. These access points support the 6 GHz band, OFDMA, and a 5 Gigabit Ethernet port. The APs can provide 24/7 scanning across all bands while still providing access on both the 2.4 GHz and 5 GHz bands or 2.4 GHz and dual 5 GHz service or the AP can be configured to provide simultaneous access on 2.4 GHz, 5 GHz, and the 6 GHz bands. The integrated BLE/ ZigBee radio can be used for beacons and locationing applications.

 **Wi-Fi 6E | Tri-Radio 2.4 + 5GHz + 5GHz / 6GHz / Scanning | 8 Internal Antennas / 4 External RPSMA Connectors + 4 External Permanently attached Antennas**

 **4x4 MU-MIMO | Up to 1148 Mbps + 2402 Mbps + 4804 Mbps**



FAP-431G



FAP-433G

Specifications

	FortiAP 431G	FortiAP 433G
Hardware		
Hardware Type	Indoor AP	Indoor AP
Number of Radios	3 + 1 BLE	3 + 1 BLE
Number of Antennas	Internal: x4 Dual band Wi-Fi + x4 Tri-band Wi-Fi and Scanning + 1 Single band 2.4GHz BLE/ZigBee	External: x4 Dual band Wi-Fi + x4 Tri-band Wi-Fi and Scanning (permanently attached) Internal: 1 Single band 2.4GHz BLE/ZigBee
Antenna Type and Peak Gain	Omni Directional antenna. Dual band: 4.0 dBi for 2.4GHz, 5.6 dBi for 5 GHz Tr-band: 4.0 dBi for 2.4GHz, 6.0 dBi for 5 GHz and 5.7dBi for 6GHz band BLE antenna: 5.1dBi for 2.4Ghz	Omni Directional antenna. Dual band: 5.0 dBi for 2.4GHz, 5.0 dBi for 5 GHz Tr-band: 5.0 dBi for 2.4GHz, 5.0 dBi for 5 GHz and 4.0dBi for 6GHz band BLE Omni Directional antenna Single band: 4.0dBi for 2.4GHz
Frequency Bands (GHz)*	2.400–2.4835, 5.150–5.250, 5.250–5.350, 5.350–5.470m 5.470–5.725, 5.725–5.850, 5.925–6.425, 6.425–6.525, 6.525–7, 5.925–6.875, 6.875–7.125	
Radio 1 Capabilities	Frequency band: 2.4GHz Channel width: 20/40MHz Modulation: BPSK, QPSK, 64/256/1024 QAM MIMO Chains: 4x4 Service	
Radio 2 Capabilities	Frequency band: 5.0GHz Channel width: 20/40/80/80+80MHz Modulation: BPSK, QPSK, 64/256/1024 QAM MIMO Chains: 4x4 Service	
Radio 3 Capabilities	Frequency band: 2.4GHz, 5.0GHz, and 6.0GHz Channel width: 20/40/80/160MHz Modulation: BPSK, QPSK, 64/256/1024 QAM MIMO Chains: 4X4 Service (2x2 when Scanning)	
Maximum Data Rate	Radio 1: up to 1148 Mbps Radio 2: up to 2402 Mbps Radio 3: Up to 4804 Mbps	
Bluetooth Low Energy Radio	Bluetooth scanning and iBeacon advertisement @10 dBm max TX power	
Interfaces	x2 100/1000/2500/5000 Base-T RJ45, 1 Type 3.0 USB, 1 RS-232 RJ45 Serial Port	
MDI/MDIX	Supported	Supported
Power over Ethernet (PoE)	1 802.3bt PoE default or x2 802.3at PoE (Dual PoE current sharing)	
Simultaneous SSIDs	Up to 8 per client serving radio (7 if background scanning is enabled)	
EAP Type(s)	EAP-TLS, EAP-TTLS/MSCHAPv2, PEAPv0/EAP-MSCHAPv2, PEAPv1/EAP-GTC, EAP-SIM, EAP-AKA, EAP-FAST	
User/Device Authentication	WPA™, WPA2™, and WPA3™ with 802.1x or Preshared key, WEP, Web Captive Portal, MAC blacklist and allowlist	
Maximum Tx Power	Radio 1: 2.4GHz: 27 dBm / 501 mW (4 chains combined)* Radio 2: 5GHz: 26 dBm / 400 mW (4 chains combined)* Radio 3: 5GHz: 26 dBm / 400 mW (4 chains combined)* 6GHz: 24 dBm 251 mW (4 chains combined @ 160MHz BW)*	
Kensington Lock	Yes	Yes
IEEE Standards	802.11a, 802.11b, 802.11d, 802.11e, 802.11g, 802.11h, 802.11i, 802.11j, 802.11k, 802.11n, 802.11r, 802.11u, 802.11v, 802.11w, 802.11ac, 802.11ax, 802.1Q, 802.1X, 802.3ad, 802.3at, 802.3bt, 802.3az, 802.3bz	
SSID Types Supported	Local-Bridge, Mesh, and Tunnel	
Per Radio Client Capacity	Up to 512 clients per radio (Radio1, Radio2 and Radio3)	
Cellular Co-existence	Yes	Yes
LED Off Mode	Yes	Yes

	FortiAP 431G	FortiAP 433G
Advanced 802.11 Features		
OFDMA	Yes	Yes
Spatial Reuse (BSS Coloring)	Yes	Yes
UL MU-MIMO	Yes	Yes
DL- MU-MIMO	Yes	Yes
Enhanced Target Wake Time (TWT)	Yes	Yes
ZeroWait DFS	No	No
Onboard Security Functions		
UTP Capable	Yes	Yes
UTP Features	Application control and Web filtering	
Wireless Monitoring Capabilities		
Rogue Scan Radio Modes	Background, Dedicated	
WIPS / WIDS Radio Modes	Background, Dedicated (recommended)	
Packet Sniffer Mode	Yes	Yes
Spectrum Analyzer	Yes	Yes
Dimensions		
Length x Width x Height	8.85× 8.85 × 2.12 inches (225.0× 225.0 × 54.0 mm)	
Weight	3.05 lbs (1.4 kg)	
Package (shipping) Weight	5.25 lbs (2.4 kg)	
Accessories		
Mounting Options	Ceiling, T-Rail, and Wall	
Included Accessories	Standard Mounting kit for Ceiling, T-Rail and Wall	
Power Supply	SP-FAP250-PA-10 or SP-FAP400-PA-XX or 802.3bt PoE(GPI-145)	
Environment		
Power Consumption (Max)	31.7 Watts	31.7 Watts
PoE Mode	802.3af : Low – All Radios Disabled ; USB – Disabled 802.3at : Low – Tx Power 17dBm ; Chain 4x4; USB – Disabled 802.3bt / DC : Full – Tx Power Full ; Chain 4x4;USB – Enabled	
Humidity	5% to 90% non-condensing	
Operating / Storage Temperature	32°F to 122°F (0°C to 50°C) / -22°F to 158°F (-30°C to 70°C)	
Directives	Low Voltage Directive • RoHS	
UL2043 Plenum Material	Yes	Yes
Mean Time Between Failures	>10 Years	>10 Years
IP Rating	N/A	N/A
Surge Protection Built In	No	No
Hit-less PoE Failover	Yes	Yes
Certifications		
Wi-Fi Alliance Certified	Yes (includes Passpoint)	Yes (includes Passpoint)
DFS	CE, FCC, Singapore	CE, FCC, Singapore
Warranty		
Limited Lifetime Warranty	Yes	Yes

* Frequency selection and power may be restricted to abide by regional regulatory compliance laws.



RF Rx/Tx Performance Table

FORTIAP 431G / 433G							
Data rate	Radio 1 802.11ax 4x4		Radio 2 802.11ax 4x4		Radio3 4x4 Tri band Service and 2x2 Scanning radio		
	Tx power/chain (dBm)	Rx Sensitivity (dBm)	Tx power/chain (dBm)	Rx Sensitivity (dBm)	Tx power/chain (dBm)	Rx Sensitivity (dBm)	
2.4GHz, 802.11b							
1 Mbps	21	-99				-99	
11 Mbps	21	-91				-91	
2.4GHz, 802.11g							
6 Mbps	21	-93				-95	
54 Mbps	21	-77				-78	
2.4GHz, 802.11n HT20							
MCS0	21	-95				-92	
MCS7	19	-77				-74	
2.4GHz, 802.11n HT40							
MCS0	20	-92				-90	
MCS7	18	-74				-72	
2.4GHz, 802.11ax HE20							
MCS0	21	-94				-90	
MCS11	19	-64				-71	
2.4GHz, 802.11ax HE40							
MCS0	21	-91				-91	
MCS11	19	-62				-72	
5.0GHz, 802.11a							
6 Mbps			23	-93	22	-93	
54 Mbps			21	-76	21	-76	
5.0GHz, 802.11n HT20							
MCS0			22	-93	21	-93	
MCS7			20	-75	18	-73	
5.0GHz, 802.11n HT40							
MCS0			21	-93	21	-90	
MCS7			18	-78	18	-71	
5.0GHz, 802.11ac VHT20							
MCS0			22	-93	21	-93	
MCS9			20	-72	18	-69	
5.0GHz, 802.11ac VHT40							
MCS0			22	-91	21	-90	
MCS9			19	-70	18	-64	
5.0GHz, 802.11ac VHT80							
MCS0			20	-86	19	-88	
MCS9			18	-65	16	-61	
5.0GHz, 802.11ax HE20							
MCS0			22	-93	22	-92	
MCS11			19	-63	19	-65	
5.0GHz, 802.11ax HE40							
MCS0			21	-90	22	-88	
MCS11			19	-70	19	-61	
5.0GHz, 802.11ax HE80							
MCS0			18	-86	20	-85	
MCS11			16	-59	17	-58	
5.0GHz, 802.11ax HE160							
MCS0					19	-82	
MCS11					16	-57	
6.0GHz, 802.11ax HE160							
MCS0					17	-82	
MCS11					14	-56	

Maximum capability of the Hardware provided (Excluding antenna gain)



Antenna Radiation Patterns

FAP-431G

FAP-433G

Radio1 and Radio2 2.45GHz plots

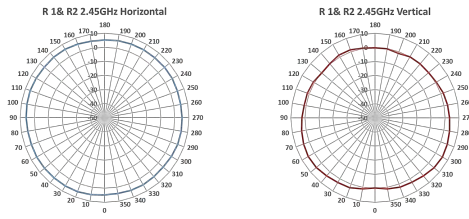

FAP-433G Radio 1&2 antenna plots

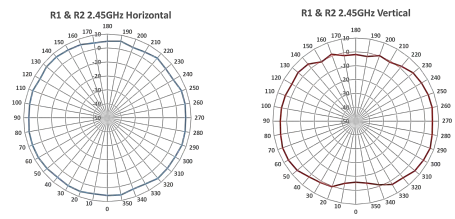

Radio1 and Radio2 5.5GHz plots

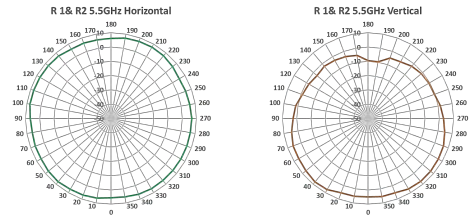

FAP-433G Radio 1&2 antenna plots

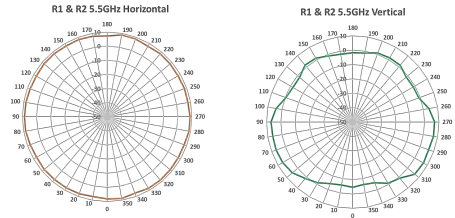

Radio3 2.45GHz plots

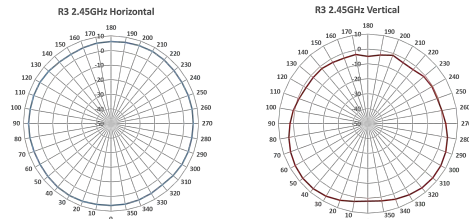

FAP-433G Radio3 antenna plots

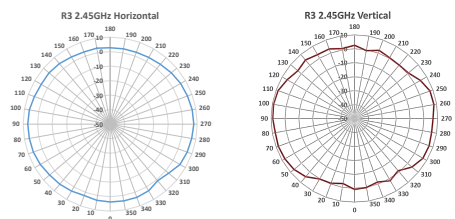

Radio3 5.5GHz plots

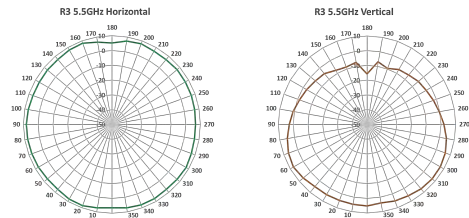

FAP-433G Radio3 antenna plots

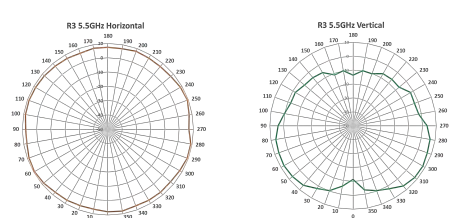

Radio3 6.5GHz plots

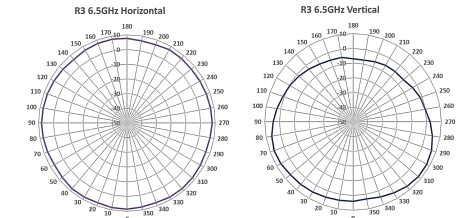

FAP-433G Radio3 antenna plots

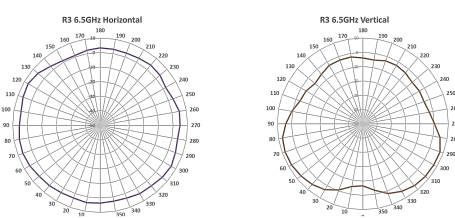

BLE/ZigBee 2.45GHz plots

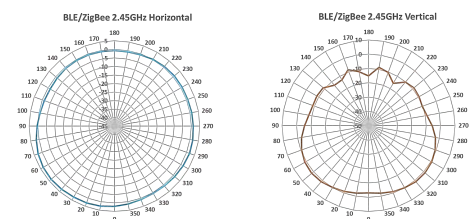

FAP-433G BLE/ZigBee antenna plots

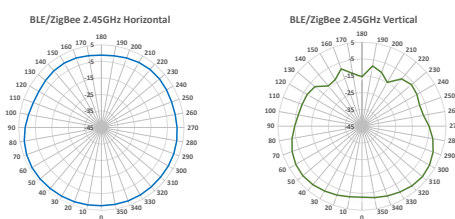

Highlights

FortiAP 432G

This enterprise class 802.11ax ruggedized indoor/outdoor AP provides three radios for tri-band access on radio capable of four spatial streams. As a Wi-Fi 6E access point it provides 6GHz band operation, OFDMA, a 10 Gigabit Ethernet port, plus an additional 1 Gbps Ethernet port with PoE out. The integrated BLE radio can be used for beacons and locating applications.

 802.11ax | Tri-Radio 2.4 GHz + 5 GHz + 6 GHz | 8 External Antennas

 4x4 MU-MIMO | Up to 1148 Mbps + 2402 Mbps + 4804 Mbps



FAP-432G



FAP-432G
Pole/Wall Mounting

Specifications

FortiAP 432G	
Hardware	
Hardware Type	Wi-Fi 6E 4x4 MIMO Outdoor AP
Number of Radios	3 + 1 BLE
Number of Antennas	External: x4 Dual band WiFi + x4 Tri-band WiFi and Scanning + x1 2.4GHz band BLE/ZigBee
Antenna Type and Peak Gain	Omni Directional antenna. Dual band: 5.1 dBi for 2.4GHz, 6.4 dBi for 5 GHz Tr-band: 4.9 dBi for 2.4GHz, 5.8 dBi for 5 GHz and 6.0dBi for 6GHz band BLE antenna: 4.7dBi for 2.4GHz
Frequency Bands (GHz)*	2.4-2.484GHz 5.925-6.425GHz 5.15-5.25GHz 6.425-6.525GHz 5.25-5.35GHz 6.525-6.875GHz 5.47-5.725GHz 6.875-7.125GHz 5.725-5.85GHz
Radio 1 Capabilities	Frequency band: 2.4GHz Channel width: 20/40MHz Modulation: BPSK, QPSK, 64/256/1024 QAM MIMO Chains: 4x4 Service
Radio 2 Capabilities	Frequency band: 5.0GHz Channel width: 20/40/80MHz Modulation: BPSK, QPSK, 64/256/1024 QAM MIMO Chains: 4x4 Service
Radio 3 Capabilities	Frequency band: 6.0GHz Channel width: 20/40/80/160MHz Modulation: BPSK, QPSK, 64/256/1024 QAM MIMO Chains: 4X4 Service and 2x2 Scanning
Maximum Data Rate	Radio 1: up to 1182 Mbps Radio 2: up to 2475 Mbps Radio 3: Up to 4804 Mbps
Bluetooth Low Energy Radio	Bluetooth scanning and iBeacon advertisement @10 dBm max TX power
Interfaces	x1 10GBASE-T/5GBASE-T/2.5GBASE-T/1000BASE-T/100BASE-TX/10BASE-T RJ45, x1 10/100/1000 Base-T RJ45, x1 RS-232 RJ45 Serial Port
MDI/MDIX	Supported
Power over Ethernet (PoE)	802.3bt PoE on LAN1/10G PoE port
Simultaneous SSIDs	Up to 8 per client serving radio (7 if background scanning is enabled)
EAP Type(s)	EAP-TLS, EAP-TTLS/MSCHAPv2, PEAPv0/EAP-MSCHAPv2, PEAPv1/EAP-GTC, EAP-SIM, EAP-AKA, EAP-FAST
User/Device Authentication	WPA™, WPA2™, and WPA3™ with 802.1x or Preshared key, WEP, Web Captive Portal, MAC blacklist and whitelist
Maximum Tx Power	Radio 1: 2.4GHz: 29.8 dBm / 955 mW (4 chains combined)* Radio 2: 5GHz: 29.8 dBm / 955 mW (4 chains combined)* Radio 3: 6GHz: 26 dBm / 400 mW (4 chains combined @ 160MHz BW)*
Kensington Lock	Yes
IEEE Standards	802.11a, 802.11b, 802.11e, 802.11g, 802.11h, 802.11i, 802.11j, 802.11k, 802.11n, 802.11r, 802.11v, 802.11ac, 802.11ax, 802.11X, 802.3ad, 802.3at, 802.3bt, 802.3az
SSID Types Supported	Local-Bridge, Mesh, and Tunnel
Per Radio Client Capacity	Up to 512 clients per radio (Radio1, Radio2, and Radio3)
Cellular Co-existence	Yes
LED Off Mode	Yes

FortiAP 432G	
Advanced 802.11 Features	
OFDMA	Yes
Spatial Reuse (BSS Coloring)	Yes
UL MU-MIMO	Yes
DL- MU-MIMO	Yes
Enhanced Target Wake Time (TWT)	Yes
ZeroWait DFS	No
Onboard Security Functions	
UTP Capable	Yes
UTP Features	Application control and Web filtering
Wireless Monitoring Capabilities	
Rogue Scan Radio Modes	Background, Dedicated
WIPS / WIDS Radio Modes	Background, Dedicated (recommended)
Packet Sniffer Mode	Yes
Spectrum Analyzer	Yes
Dimensions	
Length x Width x Height	9.45 × 9.45 × 2.74 inches (240.0 × 240.0 × 69.6 mm)
Weight	7.05 lbs (3.2 kg)
Package (shipping) Weight	13.2 lbs (6.0 kg)
Accessories	
Mounting Options	Pole and Wall
Included Accessories	Standard Mounting kit for Ceiling, T-Rail, and Wall
Environment	
Power Supply	PIN060-54PR 60W PoE with reset switch shipped with the AP
Power Consumption (Max)	41.2 Watts (Including PSE out of 12.9 watts)
PoE Mode	802.3af: Low – All Radios Disabled 802.3at: Low – Tx Power 17dBm; Chain 4x4, no PSE out 802.3bt/DC: Full – Tx Power Full; Chain 4x4; PSE out enabled
Humidity	5% to 90% non-condensing
Operating / Storage Temperature	-40°F to 140°F (-40°C to 60°C) / -58°F to 158°F (-50°C to 70°C)
Directives	Low Voltage Directive • RoHS
UL2043 Plenum Material	No
Mean Time Between Failures	>10 Years
IP Rating	IP67
Surge Protection Built In	No
Hit-less PoE Failover	N/A
Certifications	
Wi-Fi Alliance Certified	No
DFS	No
Warranty	
Limited Lifetime Warranty	Yes

* Frequency selection and power may be restricted to abide by regional regulatory compliance laws.



RF Rx/Tx Performance Table

FORTIAP 432G							
Data rate	2.4 GHz Band		5.0 GHz Band		6 GHz Band		
	Tx power/chain (dBm)	Rz Sensitivity (dBm)	Tx power/chain (dBm)	Rz Sensitivity (dBm)	Tx power/chain (dBm)	Rx Sensitivity (dBm)	
802.11b							
1 Mbps	27	-99				-99	
11 Mbps	27	-91				-91	
802.11g/a							
		802.11g			802.11a		
6 Mbps	27	-94	25	-92	22	-94	
54 Mbps	27	-78	23	-75	21	-77	
802.11n HT20							
MCS0	26	-94	25	-91			
MCS7	26	-77	22	-73			
802.11n HT40							
MCS0	25	-93	25	-89			
MCS7	25	-74	22	-70			
802.11ac VHT20							
MCS0	23	-95	25	-91			
MCS9	21	-73	22	-70			
802.11ac VHT40							
MCS0	23	-92	23	-89			
MCS9	20	-70	21	-67			
802.11ac VHT80							
MCS0			23	-85			
MCS9			21	-62			
802.11ax HE20							
MCS0	26	-94	23	-91	22	-91	
MCS11	24	-71	21	-63	19	-65	
802.11ax HE40							
MCS0	25	-92	22	-88	21	-89	
MCS11	23	-63	20	-60	19	-61	
802.11ax HE80							
MCS0			22	-85	21	-85	
MCS11			20	-57	18	-60	
802.11ax HE160							
MCS0					20	-85	
MCS11					17	-56	

Maximum capability of the Hardware provided (Excluding antenna gain)



Antenna Radiation Patterns

FAP-432G

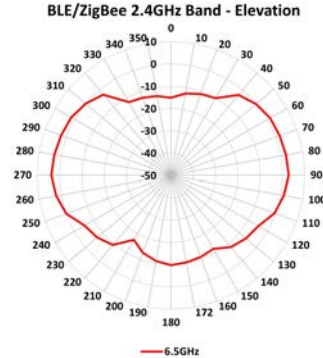
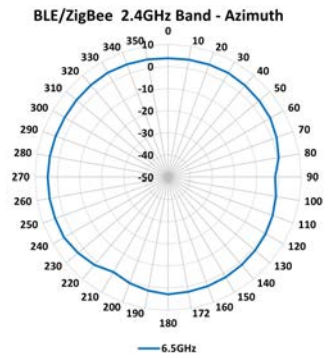
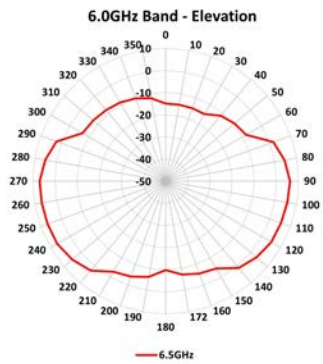
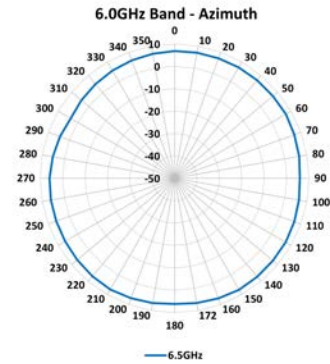
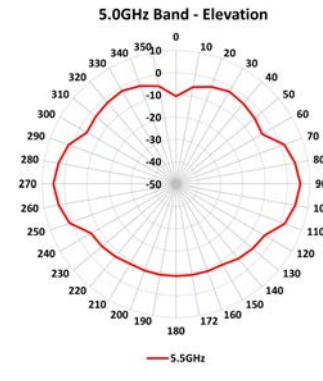
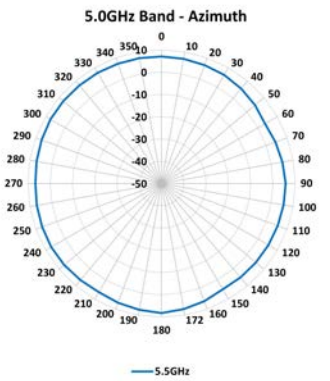
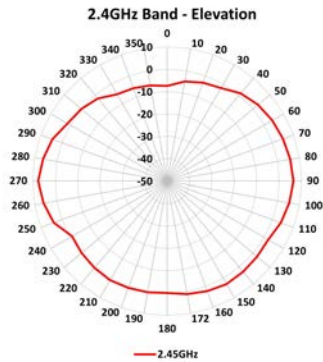
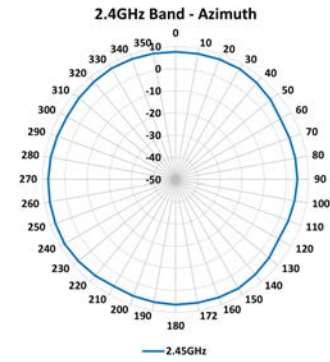

Highlights

FortiAP 231G and 233G

These enterprise class extended frequency band Wi-Fi 6E indoor APs provide three radios and two spatial streams. These access points support the 6 GHz band, OFDMA, a 2.5 Gigabit Ethernet port, plus an additional 1 Gbps Ethernet port for PoE diversity. The APs can provide 24/7 scanning across all bands while still providing access on both the 2.4 GHz and 5 GHz bands or 2.4 GHz and dual 5 GHz service or the AP can be configured to provide simultaneous access on 2.4 GHz, 5 GHz, and the 6 GHz bands. The integrated BLE/ ZigBee radio can be used for beacons and locationing applications.

 **Wi-Fi 6E | Tri-Radio 2.4 GHz + 5 GHz + 5 GHz / 6 GHz / scanning | 4 Internal Antennas / 2 External RPSMA Connectors + 2 External Permanently attached Antennas**

 **2x2 MU-MIMO | Up to 574 Mbps + 1201 Mbps + 2402 Mbps**



FAP-231G



FAP-233G

Specifications

	FortiAP 231G	FortiAP 233G
Hardware		
Hardware Type	Indoor AP	Indoor AP
Number of Radios	3 + 1 BLE	3 + 1 BLE
Number of Antennas	Internal x2 Dual band Wi-Fi + x2 Tri-band Wi-Fi and Scanning + 1 Single band 2.4GHz BLE/ZigBee	External x2 Dual band Wi-Fi + x2 Tri-band Wi-Fi and Scanning (permanently attached) + Internal 1 Single band 2.4GHz BLE/ZigBee
Antenna Type and Peak Gain	Omni Directional antenna. Dual band: 4.5 dBi for 2.4GHz, 5.5 dBi for 5 GHz Tr-band: 4.5 dBi for 2.4GHz, 5.5 dBi for 5 GHz and 5.5dBi for 6GHz band BLE antenna: 4.0dBi for 2.4Ghz	Omni Directional antenna. Dual band: 4.5 dBi for 2.4GHz, 4.5 dBi for 5 GHz. Tr-band: 4.5 dBi for 2.4GHz, 4.5 dBi for 5 GHz and 4.5dBi for 6GHz band BLE Omni Directional antenna. Single band: 4.0dBi for 2.4GHz
Frequency Bands (GHz)*	2.400–2.4835, 5.150–5.250, 5.250–5.350, 5.470–5.725, 5.725–5.850, 5.925–6.425, 6.425–6.525, 6.525–7, 5.925– 6.875, 6.875–7.125	
Radio 1 Capabilities	Frequency band: 2.4GHz Channel width: 20/40MHz Modulation: BPSK, QPSK, 64/256/1024 QAM MIMO Chains: 2x2 Service	
Radio 2 Capabilities	Frequency band: 5.0GHz Channel width: 20/40/80MHz Modulation: BPSK, QPSK, 64/256/1024 QAM MIMO Chains: 2x2 Service	
Radio 3 Capabilities	Frequency band: 2.4GHz, 5.0GHz, and 6.0GHz Channel width: 20/40/80/160MHz Modulation: BPSK, QPSK, 64/256/1024 QAM MIMO Chains: 2x2 Service and Scanning	
Maximum Data Rate	Radio 1: up to 574 Mbps Radio 2: up to 1201 Mbps Radio 3: Up to 2401 Mbps	
Bluetooth Low Energy Radio	Bluetooth scanning and iBeacon advertisement @10 dBm max TX power	
Interfaces	1 100/1000/2500 Base-T RJ45, 1 10/100/1000 Base-T RJ45, 1x Type 3.0 USB, 1 RS-232 RJ45 Serial Port	
MDI/MDIX	Supported	Supported
Power over Ethernet (PoE)	1 x 802.3at PoE default	
Simultaneous SSIDs	Up to 8 per client serving radio (7 if background scanning is enabled)	
EAP Type(s)	EAP-TLS, EAP-TTLS/MSCHAPv2, PEAPv0/EAP-MSCHAPv2, PEAPv1/EAP-GTC, EAP-SIM, EAP-AKA, EAP-FAST	
User/Device Authentication	WPA™, WPA2™, and WPA3™ with 802.1x or Preshared key, WEP, Web Captive Portal, MAC blacklist and allowlist	
Maximum Tx Power	Radio 1: 2.4GHz: 23 dBm / 200 mW (2 chains combined)* Radio 2: 5GHz: 23 dBm / 200 mW (2 chains combined)* Radio 3: 5GHz: 23 dBm / 200 mW (2 chains combined)* 6GHz: 21 dBm 126 mW (2 chains combined @ 160MHz BW)*	
Kensington Lock	Yes	Yes
IEEE Standards	802.11a, 802.11b, 802.11d, 802.11e, 802.11g, 802.11h, 802.11i, 802.11j, 802.11k, 802.11n, 802.11r, 802.11u, 802.11v, 802.11w, 802.11ac, 802.11ax, 802.1Q, 802.1X, 802.3ad, 802.3af, 802.3at, 802.3az, 802.3bz	
SSID Types Supported	Local-Bridge, Mesh, and Tunnel	
Per Radio Client Capacity	Up to 512 clients per radio (Radio1, Radio2 and Radio3)	
Cellular Co-existence	Yes	Yes
LED Off Mode	Yes	Yes

	FortiAP 231G	FortiAP 233G
Advanced 802.11 Features		
OFDMA	Yes	Yes
Spatial Reuse (BSS Coloring)	Yes	Yes
UL MU-MIMO	Yes	Yes
DL- MU-MIMO	Yes	Yes
Enhanced Target Wake Time (TWT)	Yes	Yes
ZeroWait DFS	No	No
Onboard Security Functions		
UTP Capable	Yes	Yes
UTP Features	Application control and Web filtering	
Wireless Monitoring Capabilities		
Rogue Scan Radio Modes	Background, Dedicated	
WIPS / WIDS Radio Modes	Background, Dedicated (recommended)	
Packet Sniffer Mode	Yes	Yes
Spectrum Analyzer	Yes	Yes
Dimensions		
Length x Width x Height	7.18 x 7.18 x 2.12 inches (182.4 x 182.4 x 54.0 mm)	
Weight	1.75 lbs (0.8 kg)	1.95 lbs (0.88 kg)
Package (shipping) Weight	3.05 lbs (1.4 kg)	3.35 lbs (1.51 kg)
Accessories		
Mounting Options	Ceiling, T-Rail, and Wall	
Included Accessories	Standard Mounting kit for Ceiling, T-Rail and Wall	
Power Supply	SP-FAP200-PA-XX or 802.3at PoE (GPI-130)	
Environment		
Power Consumption (Maximum)	Based on the PoE standard. 802.3af = 15.4W max 802.3at = 25.5W max	
PoE Mode	802.3af : Low – Tx Power limited to 17 dBm; Radio3 – Disabled; USB – Disabled 802.3at / DC: High/Full – Tx Power Full; USB – Enabled ;	
Humidity	5% to 90% non-condensing	
Operating / Storage Temperature	32°F to 122°F (0°C to 50°C)/-22°F to 158°F (-30°C to 70°C)	
Directives	Low Voltage Directive • RoHS	
UL2043 Plenum Material	Yes	Yes
Mean Time Between Failures	>10 Years	>10 Years
IP Rating	N/A	N/A
Surge Protection Built In	No	No
Hit-less PoE Failover	N/A	N/A
Certifications		
Wi-Fi Alliance Certified	Yes (includes Passpoint)	Yes (includes Passpoint)
DFS	CE, FCC, JP, Indonesia, Korea, Taiwan	CE, FCC, JP, Indonesia, Korea, Taiwan
Warranty		
Limited Lifetime Warranty	Yes	Yes

* Frequency selection and power may be restricted to abide by regional regulatory compliance laws.



RF Rx/Tx Performance Table

FORTIAP 231G / 233G						
Data rate	Radio 1 802.11ax 4x4		Radio 2 802.11ax 4x4		Radio3 Tri band Service and Scanning radio	
	Tx power/chain (dBm)	Rx Sensitivity (dBm)	Tx power/chain (dBm)	Rx Sensitivity (dBm)	Tx power/chain (dBm)	Rx Sensitivity (dBm)
2.4GHz, 802.11b						
1 Mbps	23	-99				-92
11 Mbps	23	-91				-91
2.4GHz, 802.11g						
6 Mbps	23	-94				-92
54 Mbps	23	-78				-77
2.4GHz, 802.11n HT20						
MCS0	23	-94				-92
MCS7	21	-75				-74
2.4GHz, 802.11n HT40						
MCS0	22	-92				-90
MCS7	20	-73				-72
2.4GHz, 802.11ax HE20						
MCS0	23	-90				-90
MCS11	21	-71				-71
2.4GHz, 802.11ax HE40						
MCS0	22	-91				-91
MCS11	20	-72				-72
5.0GHz, 802.11a						
6 Mbps			23	-92	19	-93
54 Mbps			23	-76	19	-76
5.0GHz, 802.11n HT20						
MCS0			23	-93	19	-93
MCS7			21	-74	18	-73
5.0GHz, 802.11n HT40						
MCS0			22	-91	21	-90
MCS7			21	-72	18	-71
5.0GHz, 802.11ac VHT20						
MCS0			23	-91	21	-93
MCS9			21	-72	18	-69
5.0GHz, 802.11ac VHT40						
MCS0			22	-91	21	-90
MCS9			19	-72	18	-64
5.0GHz, 802.11ac VHT80						
MCS0			21	-86	20	-88
MCS9			18	-62	17	-61
5.0GHz, 802.11ax HE20						
MCS0			23	-91	19	-91
MCS11			20	-72	17	-72
5.0GHz, 802.11ax HE40						
MCS0			22	-91	21	-91
MCS11			19	-72	18	-72
5.0GHz, 802.11ax HE80						
MCS0			21	-87	21	-87
MCS11			18	-58	17	-58
6.0GHz, 802.11ax HE160						
MCS0					18	-87
MCS11					16	-57

Maximum capability of the Hardware provided (Excluding antenna gain)



Highlights

FortiAP 234G

This enterprise class Wi-Fi 6E ruggedized indoor/outdoor AP provides three radios with internal antennas and two spatial streams. This access point supports the 6 GHz band, OFDMA, a 2.5 Gigabit Ethernet port, plus an additional 1 Gbps Ethernet port for PoE diversity. The AP can provide 24/7 scanning across all bands while still providing access on both the 2.4 GHz and 5 GHz bands or 2.4 GHz and dual 5 GHz service or the AP can be configured to provide simultaneous access on 2.4 GHz, 5 GHz, and the 6 GHz bands. The integrated BLE radio can be used for beacons and locationing applications.

 **Wi-Fi 6E | Tri-Radio 2.4 GHz + 5 GHz + 5 GHz / 6 GHz / scanning | 8 Internal Antennas**

 **2x2 MU-MIMO | Up to 574 Mbps + 1201 Mbps + 2402 Mbps**



FAP-234G

Specifications

FortiAP 234G	
Hardware	
Hardware Type	Outdoor AP
Number of Radios	3 + 1 BLE
Number of Antennas	10 2*2.4GHz WiFi + 2*5GHz band WiFi + 2*5/6GHz dual band + 2*Tri-band Scanning + 1*Single band 2.4GHz BLE/ ZigBee + 1*GPS antenna
Antenna Type and Peak Gain	Cross dipole 2.4GHz band: 6.8dBi Cross dipole 5.0GHz band: 8.4dBi Cross dipole Dual band: 8.1 dBi for 5.0GHz, 5.5 dBi for 6 GHz Tr-band: 4.5 dBi for 2.4GHz, 5.5 dBi for 5 GHz, and 8.4 dBi for 6GHz band BLE antenna: 4.4dBi for 2.4GHz GPS Circular polarized patch antenna 5.0dBi
Frequency Bands (GHz)*	2.4GHz Band: 2.400–2.4835 5.0GHz Band: 5.150–5.250, 5.250–5.350, 5.470–5.725, 5.725–5.850, 6.0GHz Band: 5.925–6.425, 6.425–6.525, 6.525–7, 5.925–6.875, 6.875–7.125
Radio 1 Capabilities	Frequency band: 2.4GHz Channel width: 20/40MHz Modulation: BPSK, QPSK, 64/256/1024 QAM MIMO Chains: 2x2 Service
Radio 2 Capabilities	Frequency band: 5.0GHz Channel width: 20/40/80/80+80MHz Modulation: BPSK, QPSK, 64/256/1024 QAM MIMO Chains: 2x2 Service
Radio 3 Capabilities	Frequency band: 2.4GHz, 5.0GHz, and 6.0GHz Channel width: 20/40/80/160MHz Modulation: BPSK, QPSK, 64/256/1024 QAM MIMO Chains: 2x2 Service and Scanning
Maximum Data Rate	Radio 1: up to 574 Mbps Radio 2: up to 1201 Mbps Radio 3: Up to 2401 Mbps
Bluetooth Low Energy Radio	Bluetooth scanning and iBeacon advertisement @10 dBm max TX power
Interfaces	1*100/1000/2500 Base-T RJ45, 1*10/100/1000 Base-T RJ45, 1*RS-232 RJ45 Serial Port
MDI/MDIX	Supported
Power over Ethernet (PoE)	IEEE 802.3bt
Simultaneous SSIDs	Up to 24
EAP Type(s)	EAP-TLS, EAP-TTLS/MSCHAPv2, PEAPv0/EAP-MSCHAPv2, PEAPv1/EAP-GTC, EAP-SIM, EAP-AKA, EAP-FAST
User/Device Authentication	WPA™, WPA2™, and WPA3™ with 802.1x or Preshared key, WEP, Web Captive Portal, MAC blacklist and allowlist
Maximum Tx Power	Radio 1: 2.4GHz: 26 dBm / 398 mW (2 chains combined)* Radio 2: 5GHz: 26 dBm / 398 mW (2 chains combined)* Radio 3: 5GHz: 26 dBm / 398 mW (2 chains combined)*, 6GHz: 26dBm/398 mW (2 chains combined EIRP)*
Kensington Lock	
IEEE Standards	802.11a, 802.11b, 802.11d, 802.11e, 802.11g, 802.11h, 802.11i, 802.11k, 802.11n, 802.11r, 802.11u, 802.11v, 802.11w, 802.11ac, 802.11ax, 802.1Q, 802.1X, 802.3ad, 802.3af, 802.3at, 802.3az, 802.3bz
SSID Types Supported	Local-Bridge, Mesh, and Tunnel
Per Radio Client Capacity	Up to 512 clients per radio (Radio1, Radio2 and Radio3)
Cellular Co-existence	Yes
LED Off Mode	Yes

FortiAP 234G	
Advanced 802.11 Features	
OFDMA	Yes
Spatial Reuse (BSS Coloring)	Yes
UL MU-MIMO	Yes
DL- MU-MIMO	Yes
Enhanced Target Wake Time (TWT)	Yes
ZeroWait DFS	No
Onboard Security Functions	
UTP Capable	Yes
UTP Features	Application control and Web filtering
Wireless Monitoring Capabilities	
Rogue Scan Radio Modes	Background, Dedicated
WIPS / WIDS Radio Modes	Background, Dedicated (recommended)
Packet Sniffer Mode	Yes
Spectrum Analyzer	Yes
Dimensions	
Length x Width x Height	10.15 × 8.50 × 2.26 inches (258 × 216 × 57.3 mm)
Weight	3.05 lbs (1.38 kg)
Package (shipping) Weight	8.15 lbs (3.7 kg)
Accessories	
Mounting Options	Wall and Pole installation
Included Accessories	Wall and Pole installation brackets with mounting kits
Environment	
Power Supply	PIN060-54PR 60W PoE with reset switch shipped with the AP
Power Consumption (Maximum)	28 Watts
PoE Mode	
Humidity	5% to 90% non-condensing
Operating / Storage Temperature	-40°F to 140°F (-40°C to 60°C) / -58°F to 158°F (-50°C to 70°C)
Directives	Low Voltage Directive • RoHS
UL2043 Plenum Material	Yes
Mean Time Between Failures	> 10 Years
IP Rating	IP67
Surge Protection Built In	No
Hit-less PoE Failover	Yes
Certifications	
Wi-Fi Alliance Certified	No
DFS	No
Warranty	
Limited Lifetime Warranty	Yes

* Frequency selection and power may be restricted to abide by regional regulatory compliance laws.



RF Rx/Tx Performance Table

FORTIAP 234G						
Data rate	Radio1 2.4GHz Band		Radio2 5.0GHz Band		Radio3 6GHz Band	
	Tx power/chain (dBm)	Rz Sensitivity (dBm)	Tx power/chain (dBm)	Rz Sensitivity (dBm)	Tx power/chain (dBm)	Rx Sensitivity (dBm)
802.11b						
1 Mbps	23	-99				
11 Mbps	23	-91				
802.11g/a	802.11g		802.11a			
6 Mbps	23	-94	23	-92	17	-94
54 Mbps	23	-78	22	-75	17	-77
802.11n HT20						
MCS0	23	-94	23	-91		
MCS7	21	-77	21	-73		
802.11n HT40						
MCS0	23	-93	23	-89		
MCS7	21	-74	21	-70		
802.11ac VHT20						
MCS0	23	-95	23	-91		
MCS9	21	-73	21	-70		
802.11ac VHT40						
MCS0	23	-92	23	-89		
MCS9	20	-70	20	-67		
802.11ac VHT80						
MCS0			22	-85		
MCS9			19	-62		
802.11ax HE20						
MCS0	23	-94	22	-91	17	-94
MCS11	20	-71	19	-63	15	-67
802.11ax HE40						
MCS0	20	-92	22	-88	16	-91
MCS11	17	-63	19	-60	14	-63
802.11ax HE80						
MCS0			21	-85	16	-88
MCS11			18	-57	13	-61
802.11ax HE160						
MCS0					15	-85
MCS11					12	-58



Antenna Radiation Patterns

FAP-234G

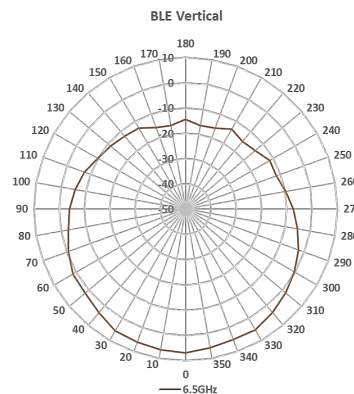
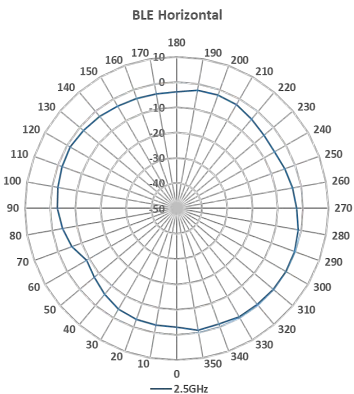
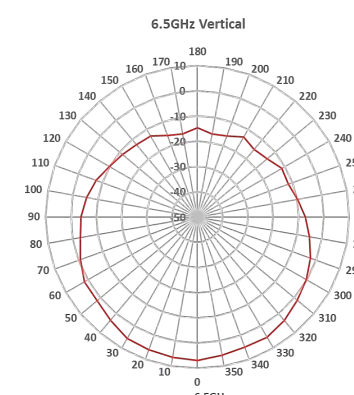
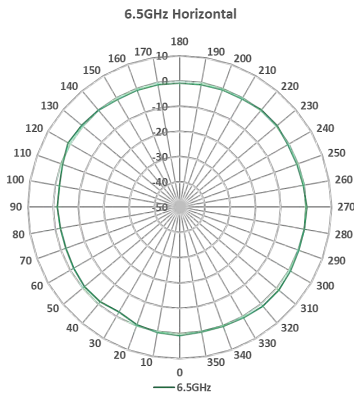
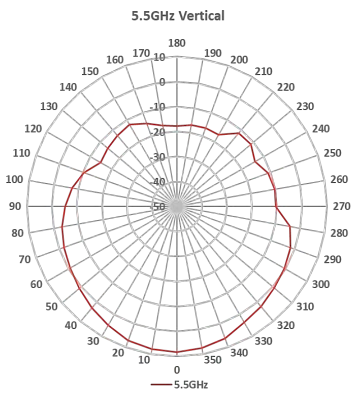
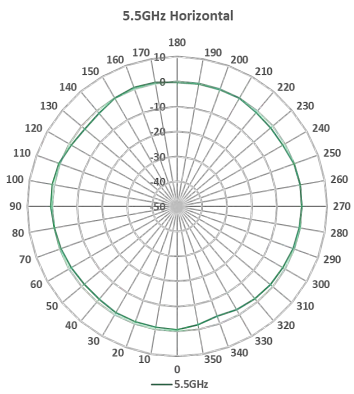
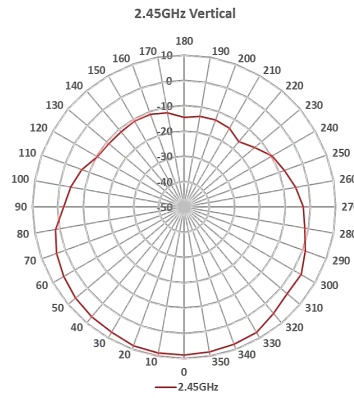
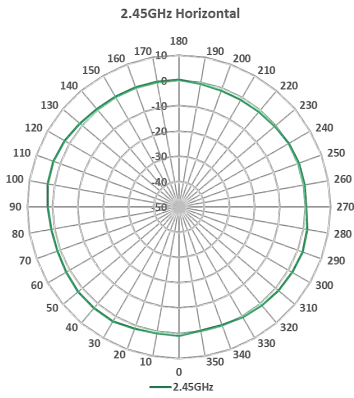

Highlights

FortiAP 831F

This high throughput enterprise class 802.11ax indoor AP provides three radios and 8 spatial streams. This top-of-the line access point supports OFDMA, a 5.0 Gigabit Ethernet port, plus an additional 1 Gbps Ethernet port for PoE diversity. The AP can provide 24/7 scanning across both bands while still providing access on both the 2.4 GHz and 5 GHz bands. The integrated BLE radio can be used for beacons and locationing applications.

 802.11ax | Tri-Radio 2.4 GHz + 5 GHz + scanning | 13 Internal Antennas

 8x8 MU-MIMO | Up to 1147 Mbps + 4804 Mbps



FAP-831F

Specifications

FortiAP 831F	
Hardware	
Hardware Type	Indoor AP
Number of Radios	3 + 1 BLE
Number of Antennas	4 2.4GHz band WiFi + 8 5GHz band WiFi + 1 Dual band Scanning + 1 2.4GHz band BLE
Antenna Type and Peak Gain	PIFA: 4.0 dBi for 2.4 GHz band WiFi antennas 6.0 dBi for 5.0 GHz band WiFi antennas 4.0 dBi for dual band Scanning radio antenna 4.5 dBi for 2.4 GHz band BLE antenna
Frequency Bands (GHz)*	2,400–2,4835, 5,150–5,250, 5,250–5,350, 5,470–5,725, 5,725–5,850
Radio 1 Capabilities	Frequency Band: 2.4 GHz Channel width: 20/40 MHz Modulation: BPSK, QPSK, QAM64 MIMO chains: 4x4 service
Radio 2 Capabilities	Frequency Band: 5.0 GHz Channel width: 20/40/80/80+80/160MHz Modulation: BPSK, QPSK, QAM64, QAM256, and QAM1024 Mimo chains: 8x8 service in mode 1 or 4x4+4x4 service in mode 2
Radio 3 Capabilities	Frequency band: 2.4/5.0 GHz MIMO chains: 1x1 frequency scanning
Maximum Data Rate	Radio 1: up to 1147.5 Mbps Radio 2: up to 4.804 Gbps in 8x8 MIMO and in 4x4 + 4x4 MIMO modes
Bluetooth Low Energy Radio	Bluetooth scanning and iBeacon advertisement @ 10 dBm max TX power
Interfaces	1x 100/1000/2500/5000 Base-T RJ45 1x 10/100/1000 Base-T RJ45 1x Type 3.0 USB, 1x RS-232 RJ45 Serial Port
MDI/MDIX	Supported Supported
Power over Ethernet (PoE)	2x 802.3at/bt/30W Passive PoE in (Full function) 1x 802.3at PoE in (USB3.1 disabled)
Simultaneous SSIDs	Up to 8 per client serving radio (7 if background scanning is enabled)
EAP Type(s)	EAP-TLS, EAP-TTLS/MSCHAPv2, PEAPv0/EAP-MSCHAPv2, PEAPv1/EAP-GTC, EAP-SIM, EAP-AKA, EAP-FAST
User/Device Authentication	WPA™, WPA2™, and WPA3™ with 802.1x or Preshared key, WEP, Web Captive Portal, MAC blacklist and allowlist
Maximum Tx Power (Conducted)	Radio 1: 2.4 GHz 27 dBm / 500 mW (4 chains combined)* Radio 2: 5 GHz 25.5 dBm / 354 mW (4 chains combined)* Radio 3: NA
Kensington Lock	Yes
IEEE Standards	802.11a, 802.11b, 802.11d, 802.11e, 802.11g, 802.11h, 802.11i, 802.11j, 802.11k, 802.11n, 802.11r, 802.11u, 802.11v, 802.11ac, 802.11ax (Wi-Fi 6), 802.1Q, 802.1X, 802.3ad, 802.3af, 802.3at, 802.3az, 802.3bz
SSID Types Supported	Local-Bridge, Mesh, Tunnel
Per Radio Client Capacity	up to 512 clients per radio (Radio1 and Radio2)
Cellular Co-existence	Yes
LED Off Mode	Yes

FortiAP-831F	
Advanced 802.11 Features	
OFDMA	Yes (UL and DL)
Spatial Reuse (BSS Coloring)	Yes
UL-MU-MIMO 802.11ax mode	Yes
DL-MU-MIMO	Yes
Enhanced Target Wake Time (TWT)	Yes
ZeroWait DFS /Agile DFS	No
Onboard Security Functions	
UTP Capable	No
UTP Features	N/A
Wireless Monitoring Capabilities	
Rogue Scan Radio Mode	Dedicated
WIPS / WIDS RAdio Modes	Dedicated
Packet Sniffer Mode	Yes
Spectrum Analyzer	Yes
Dimensions	
Length x Width x Height	9.05 x 89.05 x 2.15 inches (230 x 230 x 55 mm)
Weight	2.25 lbs (1.02 kg)
Package (shipping) Weight	4.2 lbs (1.9 kg)
Accessories	
Mounting Options	Ceiling, T-Rail, and Wall
Included Accessories	Mount kit for Ceiling, T-Rail, and Wall
Power Supply	SP-FAP400-PA-XX or GPI-130
Environment	
PSE Functionality	No
Power Consumption (Max)	33 W
PoE Mode	
Single 5G	DC/2at → Full Mode ; Radios will be in (8x8 4x4) and USB Enabled 1at/2af → High Mode ; Radios will be in (8x8 4x4) and USB Disabled 1af → Low Mode ; Radios will be [2x2 2x2], Tx Power 10 dBm and USB Disabled
Dual 5G	DC/2at → Full Mode ; Radios will be in [4x4 4x4 4x4] and USB Enabled 1at/2af → High Mode ; Radios will be in [4x4 4x4 4x4] and USB Disabled 1af → Low Mode ; Radios will be [2x2 2x2 2x2], Tx Power 10 dBm and USB Disabled
Humidity	5% to 90% Non-Condensing
Operating / Storage Temp.	32°F to 122°F(0°C to 50°C) / -22°F to 158°F(-30°C to 70°C)
Directives	Low Voltage Directive • RoHS
UL2043 Plenum Material	No
Mean Time Betw. Failures	>10 Years
Surge Protection Built In	No
Certifications	
Wi-Fi Alliance Certified	Yes (includes Passpoint)
DFS	FCC, IC, CE, Brazil and Taiwan
Warranty	
Limited Lifetime Warranty	Yes



RF Rx/Tx Performance Table

FortiAP 831F								
Data rate	Radio 1		Radio 2		Radio 3			
	2.4 GHz Tx Power per chain (dBm)	Rx Sensitivity (dBm)	5 GHz Tx Power per Chain (dBm)	Rx Sensitivity (dBm)	2.4 GHz Tx Power per chain (dBm)	Rx Sensitivity (dBm)	5 GHz Tx Power per Chain (dBm)	Rx Sensitivity (dBm)
802.11b								
1 Mbps	21	-98	—	—	21	-96	—	—
11 Mbps	23	-89	—	—	18	-87	—	—
802.11g								
6 Mbps	20	-94	—	—	20	-92	—	—
54 Mbps	22	-75	—	—	18	-73	—	—
802.11n HT20								
MCS0	20	-93	—	—	20	-91	—	—
MCS7	20	-74	—	—	17	-72	—	—
802.11n HT40								
MCS0	17	-92	—	—	19	-90	—	—
MCS7	18	-73	—	—	17	-71	—	—
802.11ax HE20								
MCS0	21	-90	—	—	—	—	—	—
MCS11	17	-71	—	—	—	—	—	—
802.11ax HE40								
MCS0	17	-88	—	—	—	—	—	—
MCS11	17	-68	—	—	—	—	—	—
802.11a								
6 Mbps	—	—	20	-92	—	—	20	-90
54 Mbps	—	—	20	-72	—	—	17.5	-72
802.11n HT20								
MCS0	—	—	20	-91	—	—	20	-90
MCS7	—	—	19	-72	—	—	17.5	-71
802.11n HT40								
MCS0	—	—	20	-88	—	—	19	-88
MCS7	—	—	18	-69	—	—	16.5	-69
802.11ac VHT20								
MCS0	—	—	20	-91	—	—	19	-90
MCS9	—	—	19	-67	—	—	17.5	-67
802.11ac VHT40								
MCS0	—	—	20	-88	—	—	19	-88
MCS9	—	—	18	-62	—	—	16	-62
802.11ac VHT80								
MCS0	—	—	18	-85	—	—	18	-85
MCS9	—	—	17	-59	—	—	16	-58
802.11ax HE20								
MCS0	—	—	20	-90	—	—	—	—
MCS11	—	—	18	-66	—	—	—	—
802.11ax HE40								
MCS0	—	—	20	-87	—	—	—	—
MCS11	—	—	18	-61	—	—	—	—
802.11ax HE80								
MCS0	—	—	18	-94	—	—	—	—
MCS11	—	—	17	-58	—	—	—	—



FAP 831F Antenna Radiation Patterns

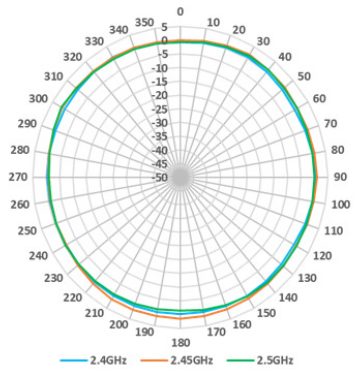

Radio1 2.4 GHz Horizontal

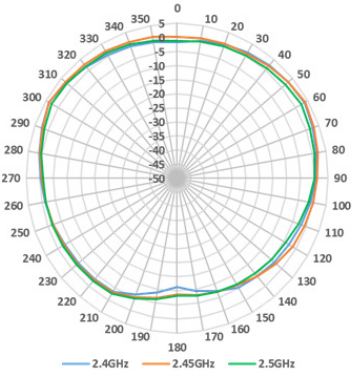

Radio1 2.4 GHz Vertical

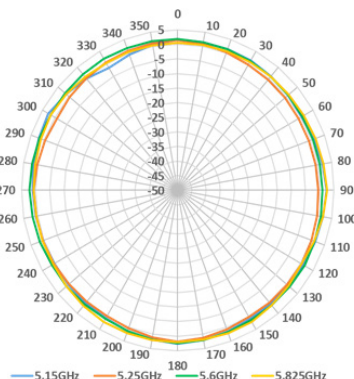

Radio2 5.0 GHz Horizontal

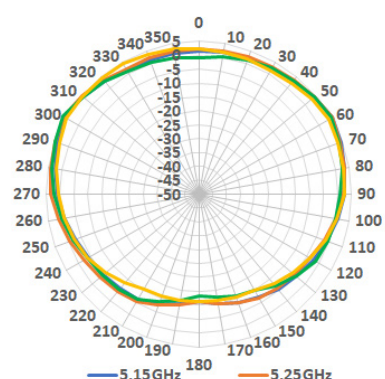

Radio2 5.0 GHz Vertical

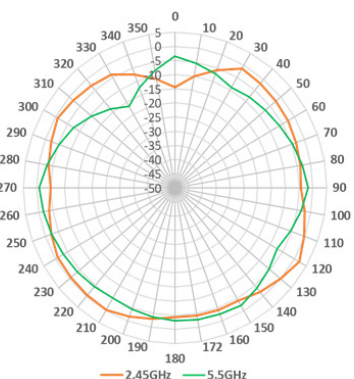

Scanning Radio Horizontal

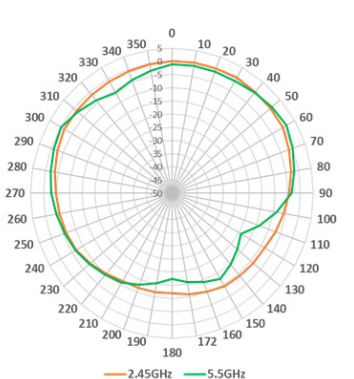

Scanning Radio Vertical

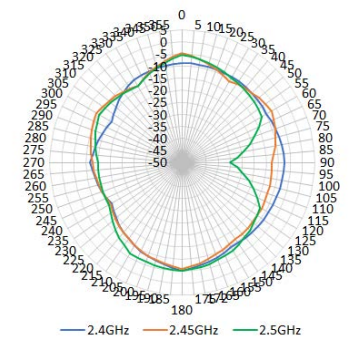

BLE Radio Horizontal

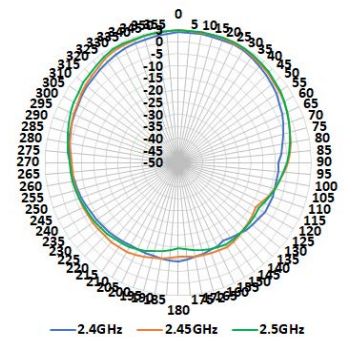

BLE Radio Vertical



Highlights

FortiAP 431F and 433F

These enterprise class 802.11ax indoor APs provide three radios and four spatial streams. These top-of-the-line access points provide OFDMA, a 2.5 Gigabit Ethernet port, plus an additional 1 Gbps Ethernet port for PoE diversity. The APs can provide 24/7 scanning across both bands while still providing access on both the 2.4 GHz and 5 GHz bands. The integrated BLE radio can be used for beacons and locationing applications.

 802.11ax | Tri-Radio 2.4 GHz + 5 GHz + scanning | 5 Internal/External Antennas

 4x4 MU-MIMO | Up to 1147 Mbps + 2402 Mbps



FAP-433F



FAP-431F

Specifications

	FortiAP 431F	FortiAP 433F
Hardware		
Hardware Type	Indoor AP	Indoor AP
Number of Radios	3 + 1 BLE	3 + 1 BLE
Number of Antennas	5 Internal + 1 BLE Internal	5 External (RP-SMA) + 1 BLE Internal
Antenna Type and Peak Gain	PIFA: 4 dBi for 2.4 GHz, 5 dBi for 5 GHz	Omni directional rubber duck antenna: 4 dBi for 2.4 GHz, 6 dBi for 5 GHz
Frequency Bands (GHz)*	2.400–2.4835, 5.150–5.250, 5.725–5.850	5.250–5.350, 5.470–5.725, 5.725–5.850
Radio 1 Capabilities	Frequency Band: 2.4 GHz Channel width: 4x4 20/40 MHz Modulation: BPSK, QPSK, QAM64, QAM256, and QAM1024 MIMO chains: 4x4 service	
Radio 2 Capabilities	Frequency Band: 5.0 GHz Channel width: 4x4 20/40/80MHz and 2x2 160MHz contiguous Modulation: BPSK, QPSK, QAM64, QAM256, and QAM1024 Mimo chains: 4x4 service	
Radio 3 Capabilities	Frequency band: 2.4/5.0 GHz MIMO chains: 1x1 frequency scanning	
Maximum Data Rate	Radio 1: up to 1147 Mbps Radio 2: up to 2402 Mbps Radio 3: scan only	Radio 1: up to 1147 Mbps Radio 2: up to 2402 Mbps Radio 3: scan only
Bluetooth Low Energy Radio	Bluetooth scanning and iBeacon advertisement @ 6 dBm max TX power	
Interfaces	1x 100/1000/2500 Base-T RJ45, 1x 10/100/1000 Base-T RJ45, 1x Type A USB, 1x RS-232 RJ45 Serial Port	
MDI/MDIX	Supported	Supported
Simultaneous SSIDs	Up to 8 per client serving radio (7 if background scanning is enabled)	
EAP Type(s)	EAP-TLS, EAP-TTLS/MSCHAPv2, PEAPv0/EAP-MSCHAPv2, PEAPv1/EAP-GTC, EAP-SIM, EAP-AKA, EAP-FAST	
User/Device Authentication	WPA™, WPA2™, and WPA3™ with 802.1x or Preshared key, WEP, Web Captive Portal, MAC blacklist and allowlist	
Maximum Tx Power (Conducted)	Radio 1: 2.4 GHz 24 dBm / 251 mW (4 chains combined)* Radio 2: 5 GHz 23 dBm / 200 mW (4 chains combined)* Radio 3: NA	
Kensington Lock	Yes	Yes
IEEE Standards	802.11a, 802.11b, 802.11d, 802.11e, 802.11g, 802.11h, 802.11i, 802.11j, 802.11k, 802.11n, 802.11r, 802.11u, 802.11v, 802.11w, 802.11ac, 802.11ax (Wi-Fi 6), 802.1Q, 802.1X, 802.3ad, 802.3af, 802.3at, 802.3az, 802.3bz	
SSID Types Supported	Local-Bridge, Mesh, Tunnel	Local-Bridge, Mesh, Tunnel
Per Radio Client Capacity	512 per Radio1 and Radio2	512 per Radio1 and Radio2
Cellular Co-existence	Yes	Yes
Reset Button	Yes	Yes
LED Off Mode	Yes	Yes
Advanced 802.11 Features		
OFDMA	Yes (UL and DL)	Yes (UL and DL)
2.4 GHz OFDMA	Yes	Yes
Spatial Reuse (BSS Coloring)	Yes	Yes
HE-MU-MIMO	Yes	Yes
UL-MU-MIMO 802.11ax mode	Yes	Yes
DL-MU-MIMO	Yes	Yes
Enhanced Target Wake Time (TWT)	Yes	Yes
ZeroWait DFS /Agile DFS	No	No

	FortiAP-431F	FortiAP-433F
Onboard Security Functions		
UTP Capable	No	No
UTP Features	N/A	N/A
Wireless Monitoring Capabilities		
Rogue Scan Radio Mode	Background, Dedicated	Background, Dedicated
WIPS / WIDS RAdio Modes	Background, Dedicated (recommended)	
Packet Sniffer Mode	Yes	Yes
Spectrum Analyzer	Yes	Yes
Dimensions		
Length x Width x Height	8.27 x 8.27 x 2.22 inches (210 x 210 x 56.5 mm)	
Weight	2.16 lbs (0.98 kg)	2.19 lbs (0.995 kg)
Package (shipping) Weight	3.97 lbs (1.8 kg)	4.4 lbs (2 kg)
Accessories		
Mounting Options	Ceiling, T-Rail, and Wall	Ceiling, T-Rail, and Wall
Included Accessories	Mount kit for Ceiling, T-Rail and Wall	Mount kit for Ceiling, T-Rail and Wall. 5 RP-SMA Male dual-band dipole antenna
Power Supply	SP-FAP400-PA-XX or GPI-130	SP-FAP400-PA-XX or GPI-130
Optional Antennas** (Professional Installer Required for FCC domains)	N/A	FANT-04ABGN-0606-O-R FANT-04ABGN-0606-P-R
Environment		
Power Consumption (Max)	24.5 W	24.5 W
PoE Mode	802.3at PoE default 1 port powered by 802.3at or 2 ports powered by 802.3af - Full System functionality + USB support 1 port is connected to 802.3af - No USB support, Operate in 2x2 mode with reduced power R1/R2 17dBm(Tx power)	
Humidity	5% to 90% Non-Condensing	5% to 90% Non-Condensing
Operating / Storage Temperature	32°F to 113°F (0°C to 45°C) / -31°F to 94°F (-35°C to 70°C)	
Directives	Low Voltage Directive • RoHS	Low Voltage Directive • RoHS
UL2043 Plenum Material	No	No
Mean Time Between Failures	>10 Years	>10 Years
IP Rating	—	—
Surge Protection Built In	No	No
Hit-less PoE Failover	Yes	Yes
Certifications		
Wi-Fi Alliance Certified	Yes (includes Passpoint)	Yes (includes Passpoint)
DFS	FCC, IC, CE, Japan, Brazil and Taiwan	FCC, IC, CE, Japan, Brazil and Taiwan
Warranty		
Limited Lifetime Warranty	Yes	Yes

* Frequency selection and power may be restricted to abide by regional regulatory compliance laws.

** Refer to the Fortinet Antenna datasheet [here](#).



RF Rx/Tx Performance Table

FortiAP 431F / 433F								
Data rate	Radio 1		Radio 2		Radio 3			
	2.4 GHz Tx Power per chain (dBm)	Rx Sensitivity (dBm)	5 GHz Tx Power per Chain (dBm)	Rx Sensitivity (dBm)	2.4 GHz Tx Power per chain (dBm)	Rx Sensitivity (dBm)	5 GHz Tx Power per Chain (dBm)	Rx Sensitivity (dBm)
802.11b								
1 Mbps	23	-98	—	—	20	-96	—	—
11 Mbps	23	-89	—	—	18	-87	—	—
802.11g								
6 Mbps	23	-94	—	—	20	-92	—	—
54 Mbps	22	-75	—	—	18	-73	—	—
802.11n HT20								
MCS0	22	-93	—	—	20	-91	—	—
MCS7	20	-74	—	—	17	-72	—	—
802.11n HT40								
MCS0	20	-92	—	—	19	-90	—	—
MCS7	18	-73	—	—	17	-71	—	—
802.11ax HE20								
MCS0	22	-90	—	—	—	—	—	—
MCS11	17	-71	—	—	—	—	—	—
802.11ax HE40								
MCS0	19	-88	—	—	—	—	—	—
MCS11	17	-68	—	—	—	—	—	—
802.11a								
6 Mbps	—	—	20	-92	—	—	20	-90
54 Mbps	—	—	20	-72	—	—	17.5	—
802.11n HT20								
MCS0	—	—	20	-91	—	—	20	-90
MCS7	—	—	19	-72	—	—	17.5	-71
802.11n HT40								
MCS0	—	—	20	-88	—	—	19	-88
MCS7	—	—	18	-69	—	—	16.5	-69
802.11ac VHT20								
MCS0	—	—	20	-91	—	—	19	-90
MCS9	—	—	19	-67	—	—	17.5	-67
802.11ac VHT40								
MCS0	—	—	20	-88	—	—	19	-88
MCS9	—	—	18	-62	—	—	16	-62
802.11ac VHT80								
MCS0	—	—	18	-85	—	—	18	-85
MCS9	—	—	17	-59	—	—	16	-58
802.11ax HE20								
MCS0	—	—	20	-90	—	—	—	—
MCS11	—	—	18	-66	—	—	—	—
802.11ax HE40								
MCS0	—	—	20	-87	—	—	—	—
MCS11	—	—	18	-61	—	—	—	—
802.11ax HE80								
MCS0	—	—	18	-94	—	—	—	—
MCS11	—	—	17	-58	—	—	—	—



Antenna Radiation Patterns

FAP-431F



H-Plane Pattern

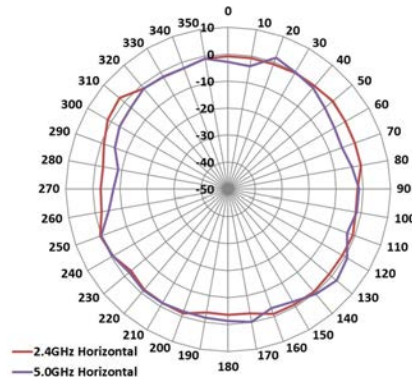

E-Plane Pattern

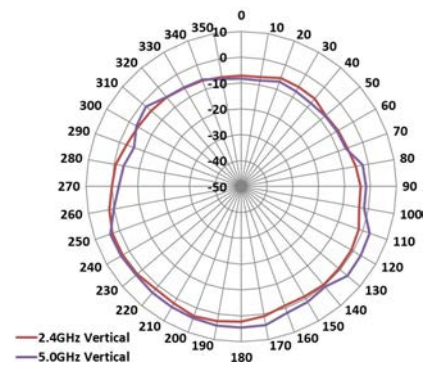

FAP-433F

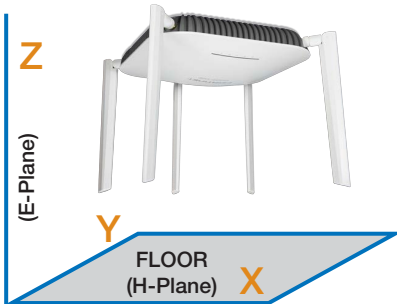

H-Plane Pattern

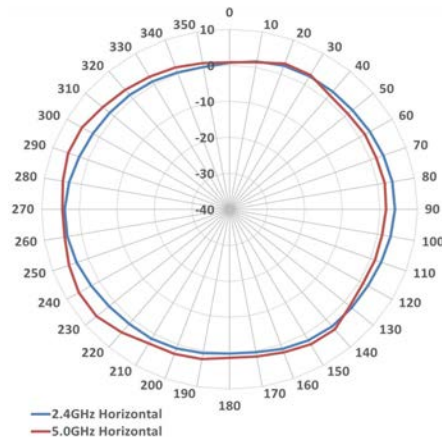

E-Plane Pattern

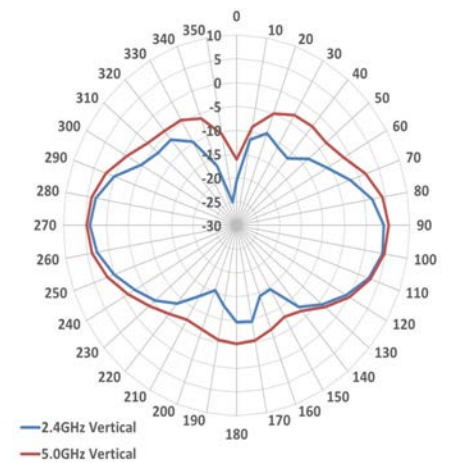

Highlights

FortiAP 432F

This enterprise class 802.11ax ruggedized indoor/outdoor AP provides three radios and four spacial streams. As a top-of-the-line Wi-Fi 6 access point it provides OFDMA, a 2.5 Gigabit Ethernet port, plus an additional 1 Gbps Ethernet port with PoE out. The AP can provide 24/7 scanning across both bands while still providing access on both the 2.4 GHz and 5 GHz bands. The integrated BLE radio can be used for beacons and locationing applications.

 802.11ax | Tri-Radio 2.4 GHz + 5 GHz + scanning | 6 External Antennas

 4x4 MU-MIMO | Up to 1147 Mbps + 2402 Mbps



FAP-432F

Specifications

FortiAP 432F	
Hardware	
Hardware Type	Ruggedized indoor/outdoor AP
Number of Radios	3 + 1 BLE
Number of Antennas	4 dual band WiFi + 1 dual band scanning + 1 single band 2.4 GHz BLE/ZigBee
Antenna Type and Peak Gain	WiFi and scanning radio dual band antenna: 5.5 dBi in 2.4 GHz and 7.2 dBi in 5 GHz band BLE antenna: 5.0 dBi in 2.4 GHz band
Frequency Bands (GHz)*	2.400–2.4835, 5.150–5.250, 5.250–5.350, 5.470–5.725, 5.725–5.850
Radio 1 Capabilities	Frequency band: 2.4 GHz Channel width: 20/40MHz Modulation: BPSK, QPSK, 64/256/1024 QAM MIMO Chains: 4x4 Service
Radio 2 Capabilities	Frequency band: 5.0 GHz Channel width: 4x4 20/40/80MHz and 2x2 160 MHz contiguous Modulation: BPSK, QPSK, QAM64, QAM256, and QAM1024 MIMO Chains: 4x4 Service
Radio 3 Capabilities	Frequency bands: 2.4 GHz and 5.0 GHz MIMO Chains: 1x1 Frequency Scanning
Maximum Data Rate	Radio 1: up to 1147 Mbps Radio 2: up to 2402 Mbps Radio 3: Frequency scanning only
Bluetooth Low Energy Radio	Bluetooth scanning and iBeacon advertisement @ 10 dBm max TX power
Interfaces	1x 100/1000/2500 Base-T RJ45, 1 x 10/100/1000 Base-T RJ45 (802.3af PoE PSE), 1x RS-232 RJ45 Serial Port
MDI/MDIX	Supported Supported
Simultaneous SSIDs	Up to 8 per client serving radio (7 if background scanning is enabled)
EAP Type(s)	EAP-TLS, EAP-TTLS/MSCHEAPv2, PEAPv0/EAP-MSCHAPv2, PEAPv1/EAP-GTC, EAP-SIM, EAP-AKA, EAP-FAST
User/Device Authentication	WPA™, WPA2™, and WPA3™ with 802.1x or preshared key, WEP, Web Captive Portal, MAC blacklist and allowlist
Maximum Tx Power (Conducted)	Radio 1: 2.4 GHz 30 dBm / 1000 mW (4 chains combined)* Radio 2: 5 GHz 26 dBm / 398 mW (4 chains combined)* Radio 3: N/A
Kensington Lock	No
IEEE Standards	802.11a, 802.11b, 802.11d, 802.11e, 802.11g, 802.11h, 802.11i, 802.11j, 802.11k, 802.11n, 802.11r, 802.11u, 802.11v, 802.11w, 802.11ac, 802.11ax (Wi-Fi 6), 802.1Q, 802.1X, 802.3ad, 802.3af, 802.3at, 802.3az, 802.3bt, 802.3bz
SSIDs Supported	Local-Bridge, Tunnel, and Mesh
Per Radio Client Capacity	Up to 512 clients per radio (Radio1 and Radio2)
Cellular Co-existence	Yes
LED Off Mode	Yes
Advanced 802.11 Features	
OFDMA	Yes (UL and DL)
Spatial Reuse (BSS Coloring)	Yes
UL MU-MIMO	Yes
DL-MU-MIMO	Yes
Enhanced Target Wake Time (TWT)	Yes
ZeroWait DFS	No

FortiAP 432F	
Onboard Security Functions	
UTP Capable	No
UTP Features	N/A
Wireless Monitoring Capabilities	
Rogue Scan radio modes	Background, Dedicated
WIPS / WIDS radio modes	Background, Dedicated (recommended)
Packet Sniffer Mode	Yes
Spectrum Analyzer	Yes
Dimensions	
Length x Width x Height	8.23 x 8.23 x 2.38 inches (209 x 209 x 60.5 mm)
Weight	5.12 lbs (2.325 kg)
Package (shipping) Weight	12.56.93 lbs (5.7 kg)
Accessories	
Mounting Options	Wall and Pole
Included Accessories	Wall and Pole mounting kit
Power Supply	802.3bt PoE, ships with PoE injector (reset functionality)
Optional Antennas** (Professional Installer Required for FCC domains)	FANT-04ABGN-0606-O-N FANT-04ABGN-1414-P-N FANT-04ABGN-8065-P-N
Environment	
PSE functionality	Yes (while powered by PoE injector shipped with product)
Power Consumption (Maximum)	25 W without PSE out and 37.9 W with PSE out
PoE Mode	802.3bt PoE default (ships with Passive PoE injector Powered by 802.3at PoE - Operate in 4x4 mode with reduced Tx power Radio1/R2 17dBm This product only supports PSE functionality when it is powered by PoE injector that ships with the product.
Humidity	10% to 90% non condensing
Operating / Storage Temperature	-40°F to 140°F (-40°C to 60°C) / -40°F to 176°F (-40°C to 80°C)
Directives	Low Voltage Directive • RoHS
UL2043 Plenum Material	No
Mean Time Between Failures	> 10 Years
IP Rating	IP67
Surge Protection Built In	Yes
Hit-less PoE Failover	N/A
Certifications	
WiFi Alliance Certified	Yes (includes Passpoint)
DFS	FCC, IC, CE, Japan, Brazil and Taiwan
Warranty	
Limited Lifetime Warranty	Yes

* Frequency selection and power may be restricted to abide by regional regulatory compliance laws.

** Refer to the Fortinet Antenna datasheet [here](#).



RF Rx/Tx Performance Table

FortiAP 432F							
Data rate	Radio 1		Radio 2		Radio 3 Scanning		
	2.4 GHz Tx Power per chain (dBm)	Rx Sensitivity (dBm)	5 GHz Tx Power per Chain (dBm)	Rx Sensitivity (dBm)	2.4 GHz Tx Power per chain (dBm)	5 GHz Tx Power per Chain (dBm)	Rx Sensitivity (dBm)
802.11b							
1 Mbps	24	-99	—	—	20	—	-92
11 Mbps	24	-91	—	—	18	—	-91
802.11g							
6 Mbps	24	-94	—	—	20	—	-92
54 Mbps	23	-78	—	—	18	—	-77
802.11n HT20							
MCS0	24	-94	—	—	20	—	-92
MCS7	23	-75	—	—	17	—	-74
802.11n HT40							
MCS0	23	-92	—	—	19	—	-90
MCS7	22	-73	—	—	17	—	-72
802.11ax HE20							
MCS0	23	-90	—	—	—	—	—
MCS11	21	-71	—	—	—	—	—
802.11ax HE40							
MCS0	21	-91	—	—	—	—	—
MCS11	19	-72	—	—	—	—	—
802.11a							
6 Mbps	—	—	22	-92	—	20	-93
54 Mbps	—	—	22	-76	—	19	-76
802.11n HT20							
MCS0	—	—	22	-93	—	20	-93
MCS7	—	—	21	-74	—	19	-73
802.11n HT40							
MCS0	—	—	22	-91	—	19	-90
MCS7	—	—	21	-72	—	18	-71
802.11ac VHT20							
MCS0	—	—	22	-91	—	19	-93
MCS9	—	—	20	-72	—	18	-69
802.11ac VHT40							
MCS0	—	—	22	-91	—	19	-90
MCS9	—	—	19	-72	—	16	-64
802.11ac VHT80							
MCS0	—	—	20	-86	—	17	-88
MCS9	—	—	17	-62	—	17	-61
802.11ax HE20							
MCS0	—	—	22	-91	—	—	—
MCS11	—	—	19	-72	—	—	—
802.11ax HE40							
MCS0	—	—	22	-91	—	—	—
MCS11	—	—	19	-72	—	—	—
802.11ax HE80							
MCS0	—	—	20	-87	—	—	—
MCS11	—	—	18	-58	—	—	—



Antenna Radiation Patterns

FAP-432F

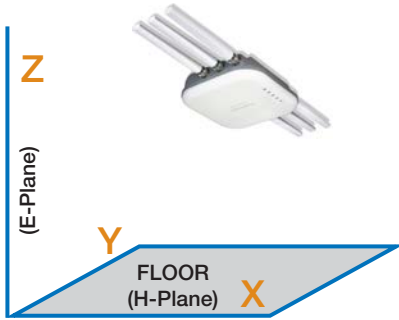

H-Plane Pattern Radio1 Horizontal

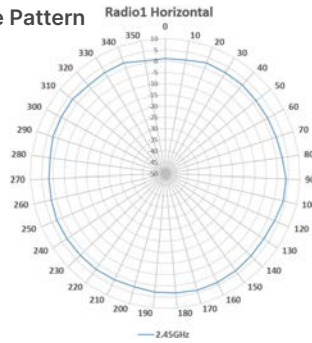

E-Plane Pattern Radio1 Vertical

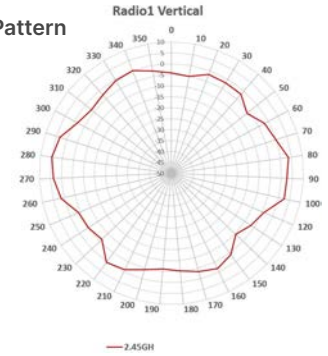

Radio2 Horizontal

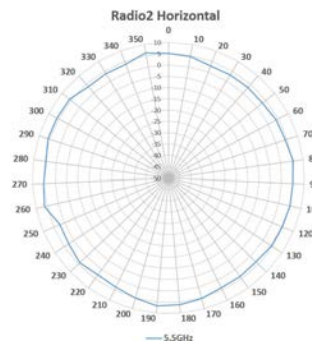

Radio2 Vertical

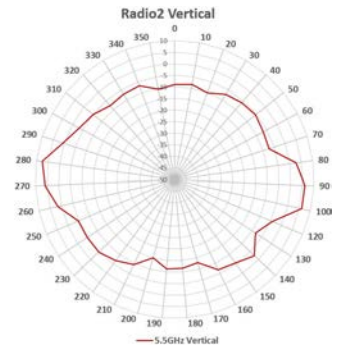

BLE Horizontal

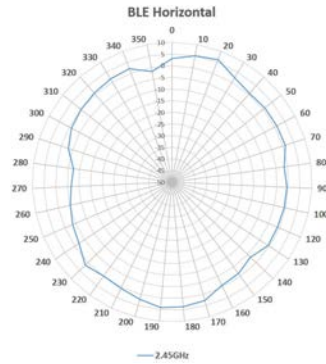

BLE Vertical

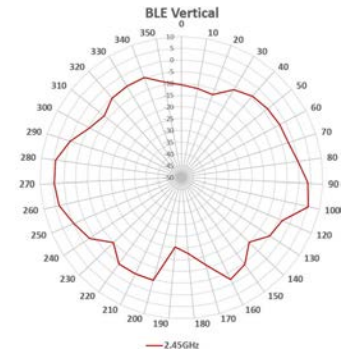

Scanning Radio Horizontal

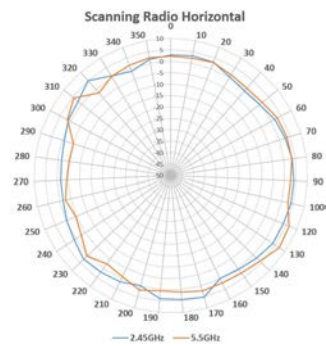

Scanning Radio Vertical

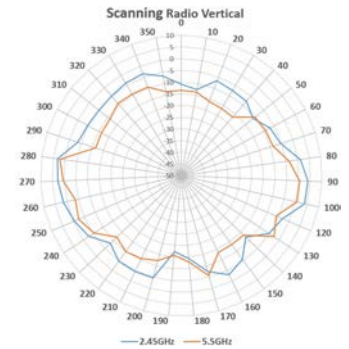

Highlights

FortiAP 432FR

This enterprise class 802.11ax ruggedized indoor/outdoor/industrial AP provides three radios and four spatial streams. As a top-of-the-line Wi-Fi 6 access point it provides OFDMA, a 2.5 Gigabit Ethernet port, plus an additional 1 Gbps Ethernet port with PoE out. The AP can provide 24/7 scanning across both bands while still providing access on both the 2.4 GHz and 5 GHz bands. The integrated BLE radio can be used for beacons and locationing applications.

FAP-432FR is ideal for hazardous environments such as oil rigs, industrial manufacturing, and transportation sites.

 802.11ax | Tri-Radio 2.4 GHz + 5 GHz + scanning | 6 External Antennas

 4x4 MU-MIMO | Up to 1147 Mbps + 2402 Mbps



FAP-432FR



FAP-432FR

Specifications

FortiAP 432FR	
Hardware	
Hardware Type	Indoor / Outdoor / Industrial AP
Number of Radios	3 + 1 BLE
Number of Antennas	4 dual band WiFi + 1 dual band scanning + 1 single band 2.4 GHz BLE/ZigBee
Antenna Type and Peak Gain	WiFi and scanning radio dual band antenna: 5.5 dBi in 2.4 GHz and 7.2 dBi in 5 GHz band BLE antenna: 5.0 dBi in 2.4 GHz band
Frequency Bands (GHz)*	2.400–2.4835, 5.150–5.250, 5.250–5.350, 5.470–5.725, 5.725–5.850
Radio 1 Capabilities	Frequency band: 2.4 GHz Channel width: 20/40MHz Modulation: BPSK, QPSK, 64/256/1024 QAM MIMO Chains: 4x4 Service
Radio 2 Capabilities	Frequency band: 5.0 GHz Channel width: 4x4 20/40/80MHz and 2x2 160 MHz contiguous Modulation: BPSK, QPSK, QAM64, QAM256, and QAM1024 MIMO Chains: 4x4 Service
Radio 3 Capabilities	Frequency bands: 2.4 GHz and 5.0 GHz MIMO Chains: 1x1 Frequency Scanning
Maximum Data Rate	Radio 1: up to 1147 Mbps Radio 2: up to 2402 Mbps Radio 3: Frequency scanning only
Bluetooth Low Energy Radio	Bluetooth scanning and iBeacon advertisement @ 10 dBm max TX power
Interfaces	1x 100/1000/2500 Base-T RJ45, 1x 10/100/1000 Base-T RJ45 (802.3af PoE PSE), 1x RS-232 RJ45 Serial Port
MDI/MDIX	Supported Supported
Simultaneous SSIDs	Up to 8 per client serving radio (7 if background scanning is enabled)
EAP Type(s)	EAP-TLS, EAP-TTLS/MSCHEAPv2, PEAPv0/EAP-MSCHAPv2, PEAPv1/EAP-GTC, EAP-SIM, EAP-AKA, EAP-FAST
User/Device Authentication	WPA™, WPA2™, and WPA3™ with 802.1x or preshared key, WEP, Web Captive Portal, MAC blacklist and allowlist
Maximum Tx Power (Conducted)	Indoor / Outdoor / Industrial: Radio 1: 2.4 GHz 29 dBm / 794 mW (4 chains combined)* Radio 2: 5 GHz 28 dBm / 630 mW (4 chains combined)* Radio 3: N/A
Kensington Lock	No
IEEE Standards	802.11a, 802.11b, 802.11d, 802.11e, 802.11g, 802.11h, 802.11i, 802.11j, 802.11k, 802.11n, 802.11r, 802.11u, 802.11v, 802.11w, 802.11ac, 802.11ax (Wi-Fi 6), 802.1Q, 802.1X, 802.3ad, 802.3af, 802.3at, 802.3az, 802.3bt, 802.3bz
SSIDs Supported	Local-Bridge, Tunnel, and Mesh
Per Radio Client Capacity	Up to 512 clients per radio (Radio1 and Radio2)
Cellular Co-existence	Yes
LED Off Mode	Yes
Advanced 802.11 Features	
OFDMA	Yes (UL and DL)
Spatial Reuse (BSS Coloring)	Yes
UL MU-MIMO	Yes
DL-MU-MIMO	Yes
Enhanced Target Wake Time (TWT)	Yes
ZeroWait DFS	No

FortiAP 432FR	
Onboard Security Functions	
UTP Capable	No
UTP Features	N/A
Wireless Monitoring Capabilities	
Rogue Scan radio modes	Background, Dedicated
WIPS / WIDS radio modes	Background, Dedicated (recommended)
Packet Sniffer Mode	Yes
Spectrum Analyzer	Yes
Dimensions	
Length x Width x Height	8.23 x 8.23 x 2.38 inches (209 x 209 x 60.5 mm)
Weight	5.12 lbs (2.325 kg)
Package (shipping) Weight	12.56.93 lbs (5.7 kg)
Accessories	
Mounting Options	Wall and Pole
Included Accessories	Wall and Pole mounting kit
Power Supply	802.3bt PoE, ships with PoE injector (reset functionality)
Optional Antennas** (Professional Installer Required for FCC domains)	FANT-04ABGN-0606-O-N FANT-04ABGN-1414-P-N FANT-04ABGN-8065-P-N
Environment	
PSE functionality	Yes (while powered by PoE injector shipped with product)
Power Consumption (Maximum)	25 W without PSE out and 37.9 W with PSE out
PoE Mode	802.3bt PoE default (ships with Passive PoE injector Powered by 802.3at PoE - Operate in 4x4 mode with reduced Tx power Radio1/R2 17dBm This product only supports PSE functionality when it is powered by PoE injector that ships with the product.
Humidity	10% to 90% non condensing
Operating / Storage Temperature	-40°F to 140°F (-40°C to 60°C) / -50°F to 176°F (-58°C to 80°C)
Directives	Low Voltage Directive • RoHS
UL2043 Plenum Material	No
Mean Time Between Failures	> 10 Years
IP Rating	IP67
Surge Protection Built In	Yes
Hit-less PoE Failover	N/A
Certifications	
	FCC/ISED CE Marked UKCA Marked AS/NZS Radio Equipment Directive (RED) 2014/53/EU UL/IEC/EN 62368-1 IEC 60529 Class I Division 2 (CID2) EN 50385 EN 62311
Radio Equipment Directive (RED)	2014/53/EU
WiFi Alliance Certified	Yes (includes Pass point)
DFS	In Process
Warranty	
Limited Lifetime Warranty	Yes

* Frequency selection and power may be restricted to abide by regional regulatory compliance laws.

** Refer to the Fortinet Antenna datasheet [here](#).



RF Rx/Tx Performance Table

FortiAP 432FR							
Data rate	Radio 1		Radio 2		Radio 3 Scanning		
	2.4 GHz Tx Power per chain (dBm)	Rx Sensitivity (dBm)	5 GHz Tx Power per Chain (dBm)	Rx Sensitivity (dBm)	2.4 GHz Tx Power per chain (dBm)	5 GHz Tx Power per Chain (dBm)	Rx Sensitivity (dBm)
802.11b							
1 Mbps	24	-99	—	—	20	—	-92
11 Mbps	24	-91	—	—	18	—	-91
802.11g							
6 Mbps	24	-94	—	—	20	—	-92
54 Mbps	23	-78	—	—	18	—	-77
802.11n HT20							
MCS0	24	-94	—	—	20	—	-92
MCS7	23	-75	—	—	17	—	-74
802.11n HT40							
MCS0	23	-92	—	—	19	—	-90
MCS7	22	-73	—	—	17	—	-72
802.11ax HE20							
MCS0	23	-90	—	—	—	—	—
MCS11	21	-71	—	—	—	—	—
802.11ax HE40							
MCS0	21	-91	—	—	—	—	—
MCS11	19	-72	—	—	—	—	—
802.11a							
6 Mbps	—	—	22	-92	—	20	-93
54 Mbps	—	—	22	-76	—	19	-76
802.11n HT20							
MCS0	—	—	22	-93	—	20	-93
MCS7	—	—	21	-74	—	19	-73
802.11n HT40							
MCS0	—	—	22	-91	—	19	-90
MCS7	—	—	21	-72	—	18	-71
802.11ac VHT20							
MCS0	—	—	22	-91	—	19	-93
MCS9	—	—	20	-72	—	18	-69
802.11ac VHT40							
MCS0	—	—	22	-91	—	19	-90
MCS9	—	—	19	-72	—	16	-64
802.11ac VHT80							
MCS0	—	—	20	-86	—	17	-88
MCS9	—	—	17	-62	—	17	-61
802.11ax HE20							
MCS0	—	—	22	-91	—	—	—
MCS11	—	—	19	-72	—	—	—
802.11ax HE40							
MCS0	—	—	22	-91	—	—	—
MCS11	—	—	19	-72	—	—	—
802.11ax HE80							
MCS0	—	—	20	-87	—	—	—
MCS11	—	—	18	-58	—	—	—



Antenna Radiation Patterns

FAP-432FR

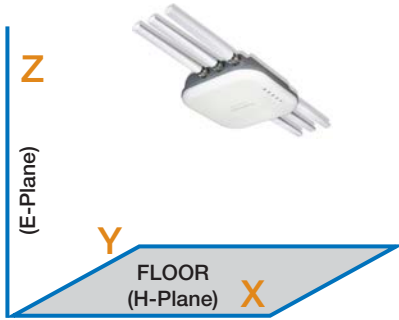

H-Plane Pattern Radio1 Horizontal

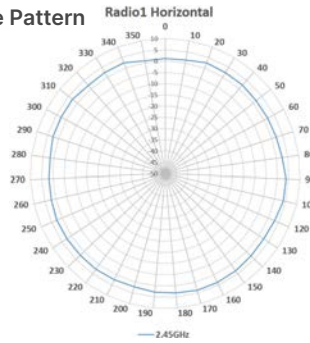

E-Plane Pattern Radio1 Vertical

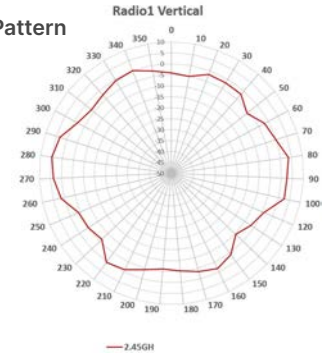

Radio2 Horizontal

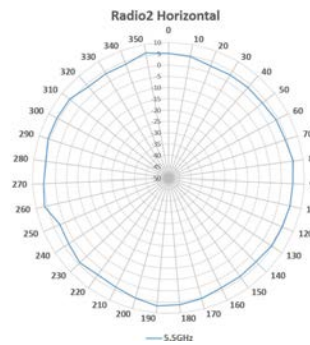

Radio2 Vertical

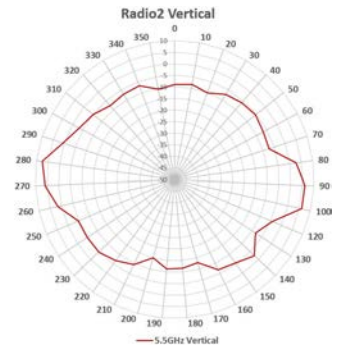

BLE Horizontal

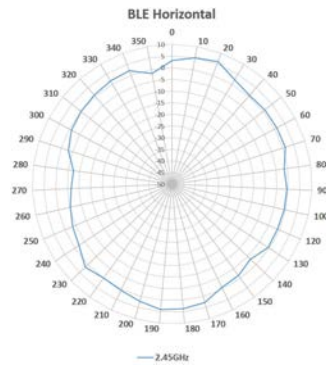

BLE Vertical

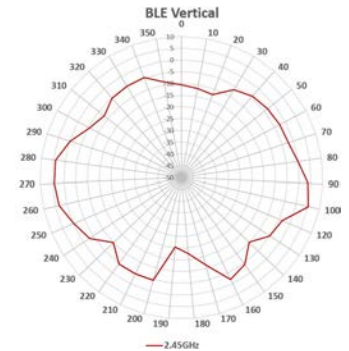

Scanning Radio Horizontal

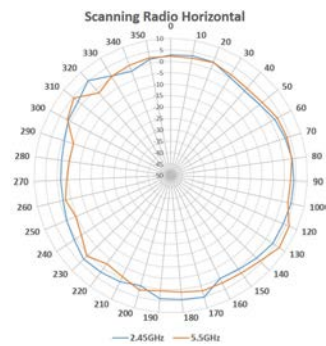

Scanning Radio Vertical

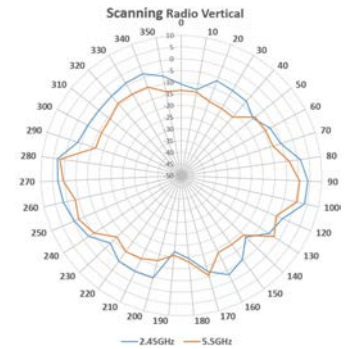

Highlights

FortiAP 231F

This enterprise class Wi-Fi 6 indoor AP provides three radios and two spacial streams, as well as features such as OFDMA and dual 1 Gbps Ethernet ports. The AP can provide 24/7 scanning across both bands while still providing access on both the 2.4 GHz and 5 GHz bands. The integrated BLE radio can be used for beacons and locationing applications.

 802.11ax | Tri-Radio 5 GHz + 2.4 GHz + scanning | 3 Antennas

 2x2 MU-MIMO | Up to 574 Mbps + 1201 Mbps + scanning



FAP-231F

Specifications

FortiAP 231F	
Hardware	
Hardware Type	Indoor AP
Number of Radios	3 + 1 BLE
Number of Antennas	3 Dual band Internal Wi-Fi + 1 BLE/ZigBee
Antenna Type and Peak Gain	Omni Directional antenna Dual band: 4.5dBi for 2.4GHz and 5.5dBi for 5GHz BLE antenna 4.0dBi at 2.4GHz band
Frequency Bands (GHz)*	2.400–2.4835, 5.150–5.250, 5.250–5.350, 5.470–5.725, 5.725–5.850
Radio 1 Capabilities	Frequency band: 2.4GHz Channel width: 20/40MHz Modulation: BPSK, QPSK, 64/256/1024 QAM MIMO Chains: 2x2 Service
Radio 2 Capabilities	Frequency band: 5.0GHz Channel width: 20/40/80MHz Modulation: BPSK, QPSK, 64/256/1024 QAM MIMO Chains: 2x2 Service
Radio 3 Capabilities	Frequency bands: 2.4GHz and 5.0GHz MIMO Chains: 1x1 Frequency Scanning
Maximum Data Rate	Radio 1: up to 574 Mbps Radio 2: up to 1201 Mbps Radio 3: Frequency scanning only
Bluetooth Low Energy Radio	Bluetooth scanning and iBeacon advertisement @ 10 dBm max TX power
Interfaces	2x 10/100/1000 Base-T RJ45, 1x Type 2.0 USB, 1x RS-232 RJ45 Serial Port
MDI/MDIX	Supported Supported
Simultaneous SSIDs	Up to 8 per client serving radio (7 if background scanning is enabled)
EAP Type(s)	EAP-TLS, EAP-TTLS/MSCHAPv2, PEAPv0/EAP-MSCHAPv2, PEAPv1/EAP-GTC, EAP-SIM, EAP-AKA, EAP-FAST
User/Device Authentication	WPA™, WPA2™, and WPA3™ with 802.1x or Preshared key, WEP, Web Captive Portal, MAC blocklist and allowlist
Maximum Tx Power (Conducted)	Radio 1: 2.4GHz: 23 dBm / 200 mW (2 chains combined)* Radio 2: 5GHz: 22 dBm / 158 mW (2 chains combined)* Radio 3: NA
Kensington Lock	Yes
IEEE Standards	802.11a, 802.11b, 802.11d, 802.11e, 802.11g, 802.11h, 802.11i, 802.11j, 802.11k, 802.11n, 802.11r, 802.11u, 802.11v, 802.11w, 802.11ac, 802.11ax, 802.11q, 802.11x, 802.3ad, 802.3af, 802.3at, 802.3az
SSID Types Supported	Local-Bridge, Tunnel, and Mesh
Per Radio Client Capacity	Up to 512 clients per radio (Radio1 and Radio2)
Cellular Co-existence	Yes
Reset Button	Yes
LED Off Mode	Yes

FortiAP 231F	
Advanced 802.11 Features	
OFDMA	Yes (UL and DL)
Spatial Reuse (BSS Coloring)	Yes
UL MU-MIMO 802.11ax mode	Yes
DL-MU-MIMO	Yes
Enhanced Target Wake Time (TWT)	Yes
ZeroWait DFS/Agile DFS	No
Onboard Security Functions	
UTP Capable	No
UTP Features	N/A
Wireless Monitoring Capabilities	
Rogue Scan radio modes	Background, Dedicated
WIPS / WIDS radio modes	Background, Dedicated (recommended)
Packet Sniffer Mode	Yes
Spectrum Analyzer	Yes
Dimensions	
Length x Width x Height	6.0 × 6.0 × 2.86 inches (153.2 × 153.2 × 53.0 mm)
Weight	1.0 lbs (0.543 kg)
Package (shipping) Weight	2.1lbs (0.95 kg)
Accessories	
Mounting Options	Ceiling, T-Rail, and Wall
Included Accessories	Standard Mount kit for Ceiling, T-Rail, and Wall
Power Supply	SP-FAP200-PA-XX, or SP-FAP250-PA-10, or 802.3at PoE GPI-130
Environment	
Power Consumption (Maximum)	17W
PoE Mode	802.3at PoE default 1 port powered by 802.3at - full system functionality + USB support 1 port is connected to 802.3af - no USB support
Humidity	5% to 90% non condensing
Operating / Storage Temperature	32°F to 122°F (0°C to 50°C) / -22°F to 158°F (-30°C to 70°C)
Directives	Low Voltage Directive • RoHS
UL2043 Plenum Material	No
Mean Time Between Failures	> 10 Years
IP Rating	N/A
Surge Protection Built In	No
Hit-less PoE Failover	N/A
Certifications	
WiFi Alliance Certified	Yes (includes Passpoint)
DFS	FCC, IC, CE, Japan, Brazil, Taiwan and Korea
Warranty	
Limited Lifetime Warranty	Yes

* Frequency selection and power may be restricted to abide by regional regulatory compliance laws.



RF Rx/Tx Performance Table

FortiAP 231F				
Data rate	Radio 1		Radio 2	
	2.4 GHz Tx Power per chain (dBm)	Rx Sensitivity (dBm)	5 GHz Tx Power per Chain (dBm)	Rx Sensitivity (dBm)
802.11b				
1 Mbps	21	-99	—	—
11 Mbps	21	-90	—	—
802.11g				
6 Mbps	20	-94	—	—
54 Mbps	20	-77	—	—
802.11n HT20				
MCS0	19	-94	—	—
MCS7	18	-76	—	—
802.11n HT40				
MCS0	19	-92	—	—
MCS7	19	-73	—	—
802.11ax HE20				
MCS0	19	-94	—	—
MCS11	17	-65	—	—
802.11ax HE40				
MCS0	19	-91	—	—
MCS11	16	-63	—	—
802.11a				
6 Mbps	—	—	22	-94
54 Mbps	—	—	21	-77
802.11n HT20				
MCS0	—	—	21	-94
MCS7	—	—	19	-76
802.11n HT40				
MCS0	—	—	21	-91
MCS7	—	—	19	-73
802.11ac VHT20				
MCS0	—	—	21	-94
MCS9	—	—	18	-72
802.11ac VHT40				
MCS0	—	—	21	-91
MCS9	—	—	18	-68
802.11ac VHT80				
MCS0	—	—	19	-88
MCS9	—	—	17	-64
802.11ax HE20				
MCS0	—	—	21	-94
MCS11	—	—	17	-64
802.11ax HE40				
MCS0	—	—	21	-91
MCS11	—	—	17	-62
802.11ax HE80				
MCS0	—	—	19	-88
MCS11	—	—	16	-58



Antenna Radiation Patterns

FAP-231F



H-Plane Pattern

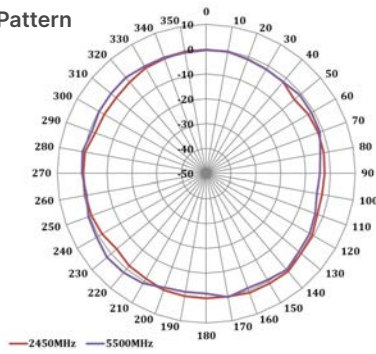

E-Plane Pattern

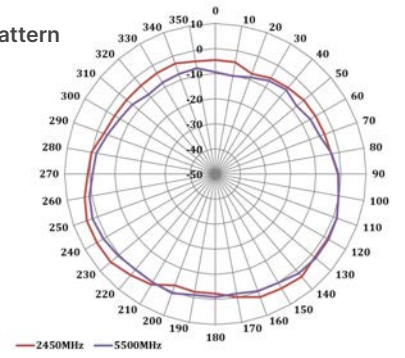

Highlights

FortiAP 234F

This enterprise class Wi-Fi 6 ruggedized indoor/outdoor AP provides three radios with internal antennas and two spacial streams, as well as features such as OFDMA and dual 1 Gbps Ethernet ports. The AP can provide 24/7 scanning across both bands while still providing access on both the 2.4 GHz and 5 GHz bands. The integrated BLE radio can be used for beacons and locationing applications.

 802.11ax | Tri-Radio 5 GHz + 2.4 GHz + scanning | 2 5G antenna + 2 2.4G antenna + 1 dual band antenna + 1 single band 2.4 Ghz BLE/Zigbee

 2x2 MU-MIMO | Up to 574 Mbps + 1201 Mbps + scanning



FAP-234F

Specifications

FortiAP 234F	
Hardware	
Hardware Type	Ruggedized indoor/outdoor AP
Number of Radios	3 + 1 BLE
Number of Antennas	2 dual band WiFi + 1 dual band scanning + 1 single band 2.4 GHz BLE/ZigBee
Antenna Type and Peak Gain	Directional patch antenna Single band antennas: 10 dBi in 2.4 GHz band, 10 dBi in 5.0 GHz band Scanning radio: 3.5 dBi in 2.4 GHz band and 4.5 dBi in 5 GHz band BLE antenna: 3.5 dBi in 2.4 GHz band
Antenna Beam Width	2.4GHz Horizontal BW 70 degree Vertical BW 30 degree 5.0GHz Horizontal BW 78 degree Vertical BW 25 degree
Frequency Bands (GHz)*	2.400–2.4835, 5.150–5.250, 5.250–5.350, 5.470–5.725, 5.725–5.850
Radio 1 Capabilities	Frequency band: 2.4GHz Channel width: 20/40MHz Modulation: BPSK, QPSK, 64/256/1024 QAM MIMO Chains: 2x2 Service
Radio 2 Capabilities	Frequency band: 5.0GHz Channel width: 20/40/80MHz Modulation: BPSK, QPSK, 64/256/1024 QAM MIMO Chains: 2x2 Service
Radio 3 Capabilities	Frequency bands: 2.4 GHz and 5.0 GHz MIMO Chains: 1x1 Frequency Scanning
Maximum Data Rate	Radio 1: up to 574 Mbps Radio 2: up to 1200 Mbps Radio 3: Frequency scanning only
Bluetooth Low Energy Radio	Bluetooth scanning and iBeacon advertisement @ 10 dBm max TX power
Interfaces	2 x 10/100/1000 Base-T RJ45, 1x RS-232 RJ45 Serial Port
MDI/MDIX	Supported Supported
Simultaneous SSIDs	Up to 8 per client serving radio (7 if background scanning is enabled)
EAP Type(s)	EAP-TLS, EAP-TTLS/MSCHAPv2, PEAPv0/EAP-MSCHAPv2, PEAPv1/EAP-GTC, EAP-SIM, EAP-AKA, EAP-FAST
User/Device Authentication	WPA™, WPA2™, and WPA3™ with 802.1x or Preshared key, WEP, Web Captive Portal, MAC blacklist and allowlist
Maximum Tx Power (Conducted)	Radio 1: 2.4 GHz: 27 dBm / 500 mW (2 chains combined)* Radio 2: 5 GHz: 25.5 dBm / 354 mW (2 chains combined)* Radio 3: N/A
Kensington Lock	No
IEEE Standards	802.11a, 802.11b, 802.11d, 802.11e, 802.11g, 802.11h, 802.11i, 802.11j, 802.11k, 802.11n, 802.11r, 802.11u, 802.11v, 802.11w, 802.11ac, 802.11ax (Wi-Fi 6), 802.1Q, 802.1X, 802.3ad, 802.3af, 802.3at, 802.3az
SSID Types Supported	Local-Bridge, Tunnel, and Mesh
Per Radio Client Capacity	Up to 512 clients per radio (Radio1 and Radio2)
Cellular Co-existence	Yes
LED Off Mode	Yes

FortiAP 234F	
Advanced 802.11 Features	
OFDMA	Yes (UL and DL)
Spatial Reuse (BSS Coloring)	Yes
UL MU-MIMO	Yes
DL-MU-MIMO	Yes
Enhanced Target Wake Time (TWT)	Yes
ZeroWait DFS	No
Onboard Security Functions	
UTP Capable	No
UTP Features	N/A
Wireless Monitoring Capabilities	
Rogue Scan radio modes	Background, Dedicated
WIPS / WIDS radio modes	Background, Dedicated (recommended)
Packet Sniffer Mode	Yes
Spectrum Analyzer	Yes
Dimensions	
Length x Width x Height	12.45 x 8.6 x 1.66 inches (316 x 218 x 42 mm)
Weight	2.88 lbs (1.307 kg)
Package (shipping) Weight	7.93 lbs (3.6 kg)
Accessories	
Mounting Options	Wall and Pole
Included Accessories	Wall and Pole mounting kit
Power Supply	802.3at PoE: GPI-130 ; ships with PoE Injector (reset functionality)
Environment	
PSE functionality	No
Power Consumption (Maximum)	15.5 W
PoE Mode	802.3at PoE default(Ships with Passive PoE injector) 1 port powered by 802.3at or 2 ports powered by 802.3af - Full System functionality 1 port is connected to 802.3af - No USB support, Operate in 2x2 mode with reduced Tx power R1/R2 17dBm
Humidity	10% to 90% non condensing
Operating / Storage Temperature	-40°F to 140°F (-40°C to 60°C) / -40°F to 176°F (-40°C to 80°C)
Directives	Low Voltage Directive • RoHS
UL2043 Plenum Material	No
Mean Time Between Failures	> 10 Years
IP Rating	IP67
Surge Protection Built In	Yes
Hit-less PoE Failover	N/A
Certifications	
WiFi Alliance Certified	Yes (includes Passpoint)
DFS	FCC, IC, CE, Japan, Brazil, Taiwan and Korea
Warranty	
Limited Lifetime Warranty	Yes

* Frequency selection and power may be restricted to abide by regional regulatory compliance laws.



RF Rx/Tx Performance Table

FortiAP 234F							
Data rate	Radio 1		Radio 2		Radio 3 Scanning		
	2.4 GHz Tx Power per chain (dBm)	Rx Sensitivity (dBm)	5 GHz Tx Power per Chain (dBm)	Rx Sensitivity (dBm)	2.4 GHz Tx Power per chain (dBm)	5 GHz Tx Power per Chain (dBm)	Rx Sensitivity (dBm)
802.11b							
1 Mbps	24	-99	—	—	20	—	-92
11 Mbps	24	-91	—	—	18	—	-91
802.11g							
6 Mbps	24	-95	—	—	20	—	-92
54 Mbps	23	-78	—	—	18	—	-77
802.11n HT20							
MCS0	24	-94	—	—	20	—	-92
MCS7	23	-78	—	—	17	—	-74
802.11n HT40							
MCS0	23	-92	—	—	19	—	-90
MCS7	22	-74	—	—	17	—	-72
802.11ax HE20							
MCS0	23	-90	—	—	—	—	—
MCS11	21	-71	—	—	—	—	—
802.11ax HE40							
MCS0	21	-91	—	—	—	—	—
MCS11	19	-72	—	—	—	—	—
802.11a							
6 Mbps	—	—	21	-93	—	20	-93
54 Mbps	—	—	21	-77	—	19	-76
802.11n HT20							
MCS0	—	—	21	-91	—	20	-93
MCS7	—	—	20	-72	—	19	-73
802.11n HT40							
MCS0	—	—	21	-91	—	19	-90
MCS7	—	—	20	-72	—	18	-71
802.11ac VHT20							
MCS0	—	—	20	-91	—	19	-93
MCS9	—	—	18	-72	—	18	-69
802.11ac VHT40							
MCS0	—	—	19	-87	—	19	-90
MCS9	—	—	17	-64	—	16	-64
802.11ac VHT80							
MCS0	—	—	22	-91	—	17	-88
MCS9	—	—	19	-72	—	17	-61
802.11ax HE20							
MCS0	—	—	22	-91	—	—	—
MCS11	—	—	19	-72	—	—	—
802.11ax HE40							
MCS0	—	—	22	-91	—	—	—
MCS11	—	—	19	-72	—	—	—
802.11ax HE80							
MCS0	—	—	20	-89	—	—	—
MCS11	—	—	18	-59	—	—	—



Antenna Radiation Patterns

FAP-234F

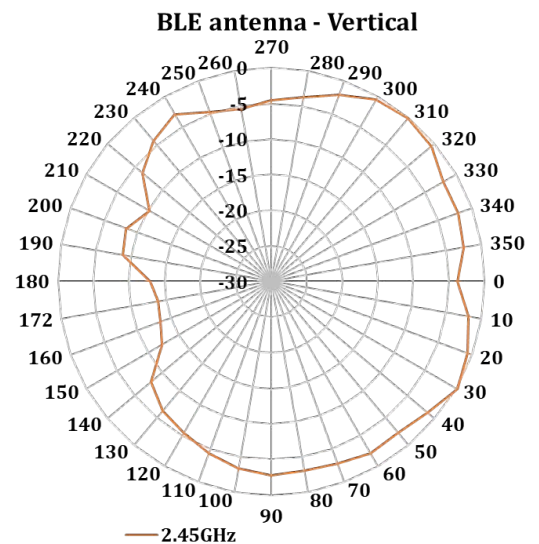
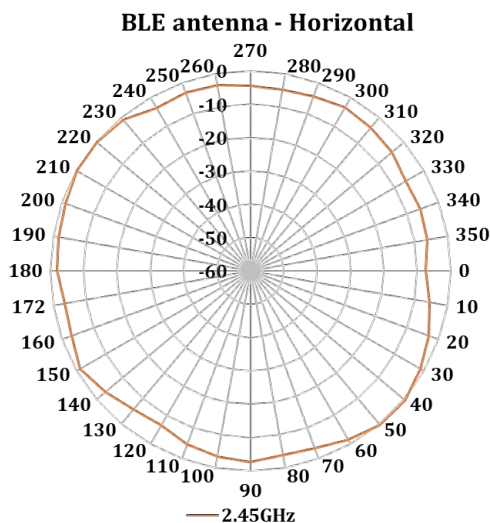
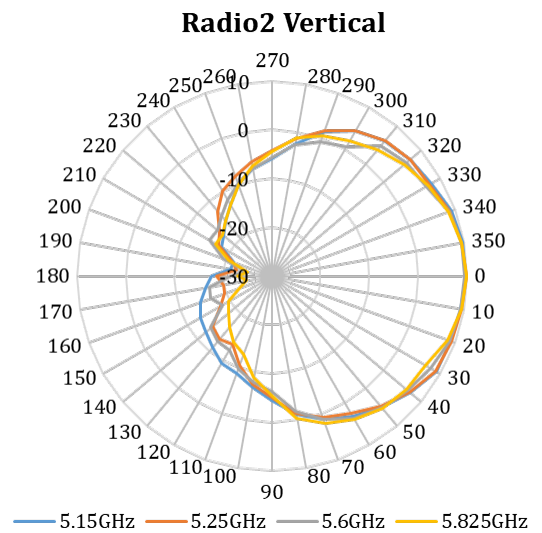
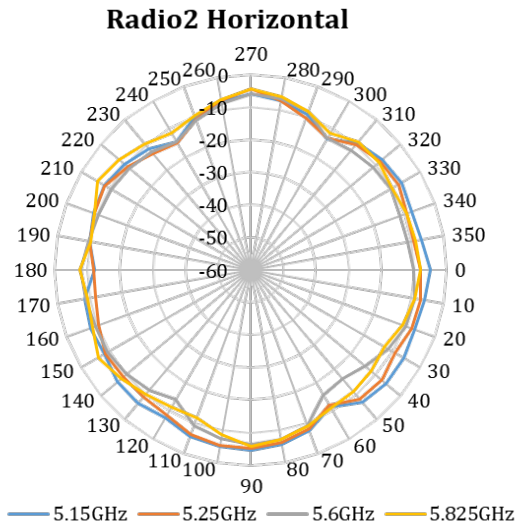
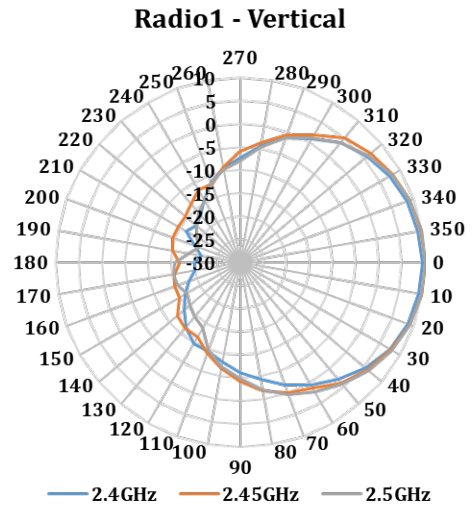
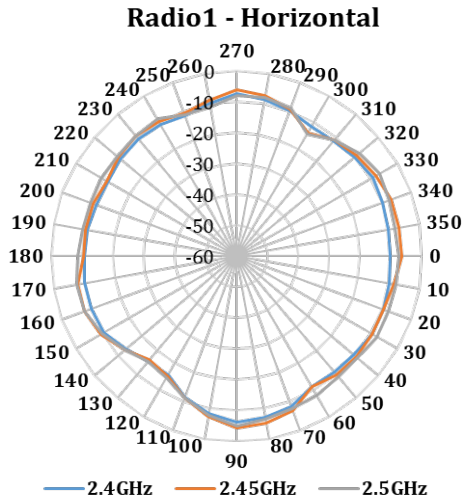

Highlights

FortiAP 23JF

This enterprise class Wi-Fi 6 wall plate AP provides three radios with internal antennas and two spatial streams, as well as features such as OFDMA and is PSE-capable. The AP can provide 24/7 scanning across both bands while still providing access on both the 2.4 GHz and 5 GHz bands. The integrated BLE radio can be used for beacons and locationing applications. Additional features include PoE out for downstream devices and RJ45 passthrough. This access point can be installed in minutes, right over the existing wall plate, or with the optional desk mount, makes a perfect remote / work from home AP.

 802.11ax | Tri-Radio 5 GHz + 2.4 GHz + scanning | 3 Antennas

 2x2 MU-MIMO | Up to 574 Mbps + 1200 Mbps + scanning



FAP-23JF

Specifications

FortiAP 23JF	
Hardware	
Hardware Type	Indoor walljack/desktop AP
Number of Radios	3 + 1 BLE
Number of Antennas	3 dual band internal Wi-Fi + 1 single band 2.4 GHz BLE/ZigBee
Antenna Type and Peak Gain	PCB antenna Dual band: 4.0 dBi in 2.4 GHz band and 4.0 dBi in 5 GHz band BLE antenna: 3.5 dBi in 2.4 GHz band
Frequency Bands (GHz)*	2.400–2.4835, 5.150–5.250, 5.250–5.350, 5.470–5.725, 5.725–5.850
Radio 1 Capabilities	Frequency band: 2.4 GHz Channel width: 20/40 MHz Modulation: BPSK, QPSK, 64/256/1024 QAM MIMO Chains: 2x2 Service
Radio 2 Capabilities	Frequency band: 5.0 GHz Channel width: 20/40/80 MHz Modulation: BPSK, QPSK, 64/256/1024 QAM MIMO Chains: 2x2 Service
Radio 3 Capabilities	Frequency bands: 2.4 GHz and 5.0 GHz MIMO Chains: 1x1 Frequency Scanning
Maximum Data Rate	Radio 1: up to 574 Mbps Radio 2: up to 1200 Mbps Radio 3: Frequency scanning only
Bluetooth Low Energy Radio	Bluetooth scanning and iBeacon advertisement @ 10 dBm max TX power
Interfaces	4 × 10/100/1000 Base-T RJ45 Ports (1× 802.3at PoE(PD), 1× 802.3af PoE (PSE), 2x Non-PoE Ports) 3 RJ-45 Ports (1xPass-through in, 1x Pass-through out, 1x RS-232 Serial Port)
MDI/MDIX	Supported Supported
Simultaneous SSIDs	Up to 8 per client serving radio (7 if background scanning is enabled)
EAP Type(s)	EAP-TLS, EAP-TTLS/MSCHAPv2, PEAPv0/EAP-MSCHAPv2, PEAPv1/EAP-GTC, EAP-SIM, EAP-AKA, EAP-FAST
User/Device Authentication	WPA™, WPA2™, and WPA3™ with 802.1x or preshared key, WEP, Web Captive Portal, MAC blocklist and allowlist
Maximum Tx Power (Conducted)	Radio 1: 2.4 GHz: 25 dBm / 158 mW (2 chains combined)* Radio 2: 5 GHz: 21 dBm / 158 mW (2 chains combined)* Radio 3: N/A
Kensington Lock	Yes
IEEE Standards	802.11a, 802.11b, 802.11d, 802.11e, 802.11g, 802.11h, 802.11i, 802.11j, 802.11k, 802.11n, 802.11r, 802.11u, 802.11v, 802.11w, 802.11ac, 802.11ax (Wi-Fi 6), 802.1Q, 802.1X, 802.3ad, 802.3af, 802.3at, 802.3az
SSID Types Supported	Local-Bridge, Tunnel, and Mesh
Per Radio Client Capacity	Up to 512 clients per radio (Radio1 and Radio2)
Cellular Co-existence	Yes
LED Off Mode	Yes

FortiAP 23JF	
Advanced 802.11 Features	
OFDMA	Yes (UL and DL)
Spatial Reuse (BSS Coloring)	Yes
UL MU-MIMO	Yes
DL-MU-MIMO	Yes
Enhanced Target Wake Time (TWT)	Yes
ZeroWait DFS	No
Onboard Security Functions	
UTP Capable	No
UTP Features	N/A
Wireless Monitoring Capabilities	
Rogue Scan radio modes	Background, Dedicated
WIPS / WIDS radio modes	Background, Dedicated (recommended)
Packet Sniffer Mode	Yes
Spectrum Analyzer	Yes
Dimensions	
Length x Width x Height	6.6 × 4.6 × 1.1 inches (168 × 117 × 28 mm)
Weight	0.99 lbs (0.45 kg)
Package (shipping) Weight	1.54 lbs (0.7 kg)
Accessories	
Mounting Options	Wall Plate, Optional Desk Mount FAP-MNT-WJ-20
Included Accessories	Standard Mount kit for Ceiling, T-Rail, and Wall
Power Supply	802.3at PoE: GPI-130 Optional DC power adaptor SP-FAP23J-PA-10
Environment	
PSE functionality	Yes
Power Consumption (Maximum)	17.5W without PSE out and 31W with PSE out
PoE Mode	802.3at PoE default(optional DC adaptor) Powered via DC power supply - Full System functionality + USB + PSE (8023af 15.4W) Powered by 802.3af - Only Radio functionality is operational (No USB/PSE supported) Powered by 802.3at - Full System functionality+ PSE(7w)
Humidity	10% to 90% non condensing
Operating / Storage Temperature	32°F to 122°F (0°C to 50°C) / -22°F to 158°F (-30°C to 70°C)
Directives	Low Voltage Directive • RoHS
UL2043 Plenum Material	No
Mean Time Between Failures	> 10 Years
IP Rating	N/A
Surge Protection Built In	No
Hit-less PoE Failover	N/A
Certifications	
WiFi Alliance Certified	Yes (includes Passpoint)
DFS	FCC, IC, CE, Japan, Brazil, Taiwan and Korea
Warranty	
Limited Lifetime Warranty	Yes

* Frequency selection and power may be restricted to abide by regional regulatory compliance laws.



RF Rx/Tx Performance Table

FortiAP 23JF							
Data rate	Radio 1		Radio 2		Radio 3 Scanning		
	2.4 GHz Tx Power per chain (dBm)	Rx Sensitivity (dBm)	5 GHz Tx Power per Chain (dBm)	Rx Sensitivity (dBm)	2.4 GHz Tx Power per chain (dBm)	5 GHz Tx Power per Chain (dBm)	Rx Sensitivity (dBm)
802.11b							
1 Mbps	22	-98	—	—	20	—	-92
11 Mbps	20	-90	—	—	18	—	-91
802.11g							
6 Mbps	22	-93	—	—	20	—	-92
54 Mbps	20	-77	—	—	18	—	-77
802.11n HT20							
MCS0	22	-94	—	—	20	—	-92
MCS7	20	-76	—	—	17	—	-74
802.11n HT40							
MCS0	22	-92	—	—	19	—	-90
MCS7	20	-73	—	—	17	—	-72
802.11ax HE20							
MCS0	22	-90	—	—	—	—	—
MCS11	20	-71	—	—	—	—	—
802.11ax HE40							
MCS0	20	-90	—	—	—	—	—
MCS11	18	-70	—	—	—	—	—
802.11a							
6 Mbps	—	—	18	-93	—	20	-91
54 Mbps	—	—	18	-77	—	19	-75
802.11n HT20							
MCS0	—	—	19	-94	—	20	-90
MCS7	—	—	19	-75	—	19	-72
802.11n HT40							
MCS0	—	—	21	-91	—	19	-90
MCS7	—	—	20	-72	—	18	-71
802.11ac VHT20							
MCS0	—	—	21	-91	—	19	-93
MCS9	—	—	20	-72	—	18	-69
802.11ac VHT40							
MCS0	—	—	20	-91	—	19	-90
MCS9	—	—	18	-72	—	16	-64
802.11ac VHT80							
MCS0	—	—	19	-87	—	17	-88
MCS9	—	—	17	-64	—	17	-61
802.11ax HE20							
MCS0	—	—	20	-91	—	—	—
MCS11	—	—	18	-72	—	—	—
802.11ax HE40							
MCS0	—	—	19	-91	—	—	—
MCS11	—	—	17	-62	—	—	—
802.11ax HE80							
MCS0	—	—	18	-89	—	—	—
MCS11	—	—	16	-60	—	—	—



Antenna Radiation Patterns

FAP-23JF

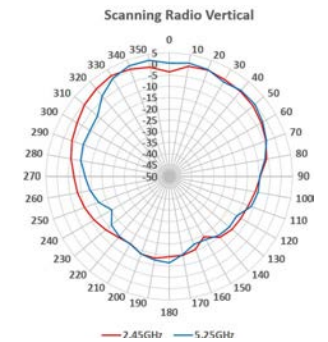
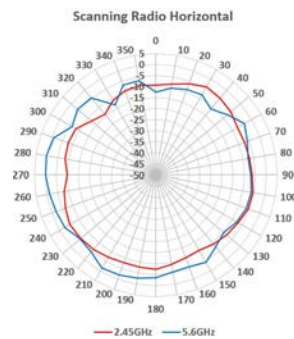
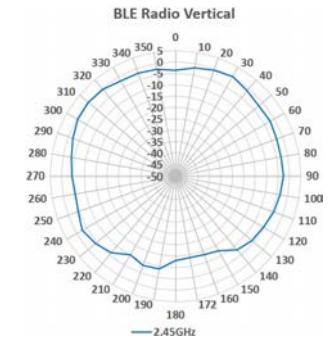
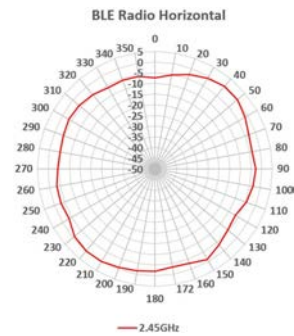
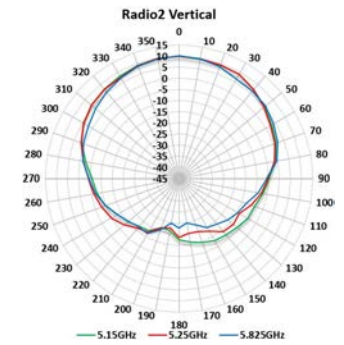
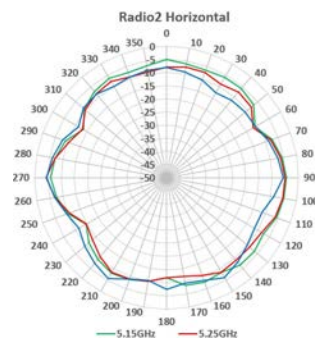
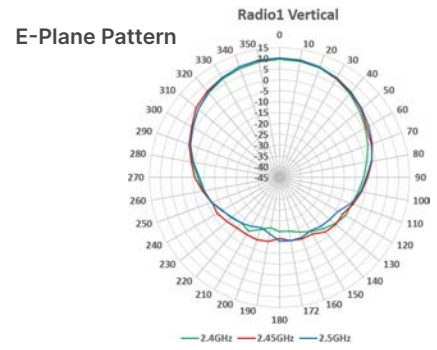
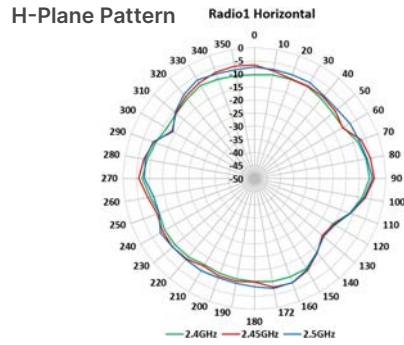
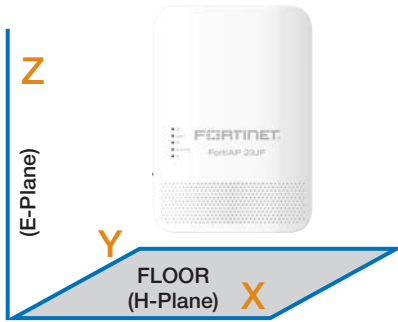

Highlights

FortiAP 221E and 223E

The FortiAP 221E and 223E are medium-density 802.11ac Wave 2 access points and provides two radio and two spacial streams. These enterprise-class access points are ideal for medium-density environments such as an office or classroom with performance throughput of up to 867 Mbps.



802.11ac Wave 2 | Dual Radio 2.4 and 5 GHz | 4 Internal/External Antennas



2x2 MU-MIMO | Up to 400 + 867 Mbps



FAP-221E



FAP-223E

Specifications

	FortiAP 221E	FortiAP 223E
Hardware		
Hardware Type	Indoor AP	Indoor AP
Number of Radios	2 + 1 BLE	2 + 1 BLE
Number of Antennas	4 Internal + 1 Internal BLE	4 External + 1 Internal BLE
Antenna Type and Peak Gain	Patch: 4 dBi for 2.4 GHz, 5 dBi for 5 GHz	Dipole: 4 dBi for 2.4 GHz, 5 dBi for 5 GHz
Frequency Bands (GHz)*	2.400–2.4835, 5.150–5.250, 5.250–5.350, 5.470–5.725, 5.725–5.850	
Radio 1 Capabilities	2.4 GHz b/g/n (2×2:2 stream) 20/40 MHz (256 QAM)	2.4 GHz b/g/n (2×2:2 stream) 20/40 MHz (256 QAM)
Radio 2 Capabilities	5 GHz a/n/ac (2×2:2 stream) 20/40/80 MHz (256 QAM)	5 GHz a/n/ac (2×2:2 stream) 20/40/80 MHz (256 QAM)
Maximum Data Rate	Radio 1: up to 400 Mbps Radio 2: up to 867 Mbps	Radio 1: up to 400 Mbps Radio 2: up to 867 Mbps
Bluetooth Low Energy Radio	Bluetooth scanning and iBeacon advertisement @ 4 dBm max TX power	
Interfaces	1× 10/100/1000 Base-T RJ45	1× 10/100/1000 Base-T RJ45
MDI/MDIX	Supported	Supported
Power over Ethernet (PoE)	IEEE 802.3af	IEEE 802.3af
Simultaneous SSIDs	Up to 8 per client serving radio (7 if background scanning is enabled)	
EAP Type(s)	EAP-TLS, EAP-TTLS/MSCHAPv2, PEAPv0/EAP-MSCHAPv2, PEAPv1/EAP-GTC, EAP-SIM, EAP-AKA, EAP-FAST	
User/Device Authentication	WPA™, WPA2™, and WPA3™ with 802.1x or preshared key, WEP, Web Captive Portal, MAC blocklist and allowlist	
Maximum Tx Power	2.4 GHz: 23 dBm / 200 mW (2 chains combined)* 5 GHz: 24 dBm / 251 mW (2 chains combined)*	
Kensington Lock	Yes	Yes
IEEE Standards	802.11a, 802.11b, 802.11d, 802.11e, 802.11g, 802.11h, 802.11i, 802.11j, 802.11k, 802.11n, 802.11r, 802.11u, 802.11v, 802.11w, 802.11ac, 802.11q, 802.11x, 802.3af, 802.3az	
SSID Types Supported	Local-Bridge, Tunnel, Mesh	Local-Bridge, Tunnel, Mesh
Per Radio Client Capacity	Up to 512	Up to 512
Cellular Co-existence	Yes	Yes
Reset Button	Yes	Yes
LED Off Mode	Yes	Yes
Advanced 802.11 Features		
802.11ac Wave 2 MU-MIMO	Yes	Yes
Transmit Beam Forming (TxBF)	Yes	Yes
Low-Density Parity Check (LDPC) Encoding	Yes	Yes
Maximum Likelihood Demodulation (MLD)	Yes	Yes
Maximum Ratio Combining (MRC)	Yes	Yes
A-MPDU and A-MSDU Packet Aggregation	Yes	Yes
MIMO Power Save	Yes	Yes
Short Guard Interval	Yes	Yes

	FortiAP 221E	FortiAP 223E
Onboard Security Functions		
UTP Capable	No	No
UTP Features	N/A	N/A
Wireless Monitoring Capabilities		
Rogue Scan Radio Modes	Background, Dedicated	Background, Dedicated
WIPS / WIDS Radio Modes	Background, Dedicated	Background, Dedicated
Packet Sniffer Mode	Yes	Yes
Spectrum Analyzer	Yes	Yes
Dimensions		
Length x Width x Height	6.3 × 6.3 × 1.85 inches (160 × 160 × 47 mm)	
Weight	1.1 lbs (0.5 kg)	1.1 lbs (0.5 kg)
Package (shipping) Weight	4.95 lbs (2.2 kg)	5.3 lbs (2.4 kg)
Accessories		
Mounting Options	Ceiling, T-Rail, and Wall	Ceiling, T-Rail, and Wall
Included Accessories	Mount kits for Ceiling, T-Rail, and Wall	Mount kits for Ceiling, T-Rail, and Wall, 4 dipole antennas
Power Supply	SP-FAP200-PA-XX, GPI-115, or GPI-130	
Environment		
Power Consumption (Max.)	12.36 W	12.36 W
Humidity	5% to 90% non-condensing	5% to 90% non-condensing
Operating / Storage Temperature	-4°F to 113°F (-20°C to 45°C) / -40°F to 158°F (-40°C to 70°C)	
Directives	Low Voltage Directive • RoHS	Low Voltage Directive • RoHS
UL2043 Plenum Material	No	No
Mean Time Between Failures	>30 Years	>30 Years
IP Rating	—	—
Surge Protection Built In	—	—
Hit-less PoE Failover	No	No
Certifications		
Wi-Fi Alliance Certified	Yes (includes Passpoint)	Yes (includes Passpoint)
DFS	FCC, IC, CE, Japan, Taiwan, Korea	FCC, IC, CE, Japan, Taiwan, Korea
Warranty		
Limited Lifetime Warranty	Yes	Yes

* Frequency selection and power may be restricted to abide by regional regulatory compliance laws.



RF Rx/Tx Performance Table

FortiAP 221E / 223E				
Data rate	RADIO 1		RADIO 2	
	2.4 GHz Tx Power (dBm)	Rx Sensitivity (dBm)	5 GHz Tx Power (dBm)	Rx Sensitivity (dBm)
802.11 a/g				
6 Mbps	20	-93	21	-91
9 Mbps	20	-91	21	-90
12 Mbps	20	-90	21	-89
18 Mbps	19	-88	21	-86
24 Mbps	19	-85	21	-83
36 Mbps	18	-82	21	-80
48 Mbps	18	-77	19	-76
54 Mbps	17	-75	19	-74
802.11n HT20				
MCS 0/8/16	20	-91	21	-91
MCS 1/9/17	19	-89	21	-88
MCS 2/10/18	19	-86	21	-86
MCS 3/11/19	18	-83	21	-83
MCS 4/12/20	18	-80	21	-79
MCS 5/13/21	17	-75	21	-75
MCS 6/14/22	17	-73	19	-74
MCS 7/15/23	16	-71	19	-72
802.11n HT40				
MCS 0/8/16	19	-89	20	-88
MCS 1/9/17	19	-86	20	-85
MCS 2/10/18	18	-84	20	-82
MCS 3/11/19	18	-81	20	-79
MCS 4/12/20	17	-77	20	-76
MCS 5/13/21	17	-73	20	-72
MCS 6/14/22	16	-71	19	-70
MCS 7/15/23	16	-69	19	-69
802.11ac VHT20				
MCS 0	19	-91	21	-91
MCS 1	19	-89	21	-88
MCS 2	19	-86	21	-86
MCS 3	18	-83	21	-83
MCS 4	18	-80	21	-79
MCS 5	18	-76	21	-75
MCS 6	18	-73	19	-74
MCS 7	18	-71	19	-72
MCS 8	18	-68	18	-69

FortiAP 221E / 223E				
Data rate	RADIO 1		RADIO 2	
	2.4 GHz Tx Power (dBm)	Rx Sensitivity (dBm)	5 GHz Tx Power (dBm)	Rx Sensitivity (dBm)
802.11ac VHT40				
MCS 0	19	-89	20	-88
MCS 1	19	-86	20	-85
MCS 2	19	-84	20	-82
MCS 3	18	-81	20	-79
MCS 4	17	-77	20	-76
MCS 5	17	-73	20	-72
MCS 6	17	-71	19	-70
MCS 7	17	-69	19	-69
MCS 8	17	-68	18	-65
MCS 9	16	-66	17	-64
802.11ac VHT80				
MCS 0	—	—	19	-85
MCS 1	—	—	19	-83
MCS 2	—	—	19	-80
MCS 3	—	—	19	-77
MCS 4	—	—	19	-74
MCS 5	—	—	19	-71
MCS 6	—	—	18	-69
802.11acVHT80				
MCS 7	—	—	18	-68
MCS 8	—	—	17	-63
MCS 9	—	—	17	-61



Antenna Radiation Patterns

FAP-221E

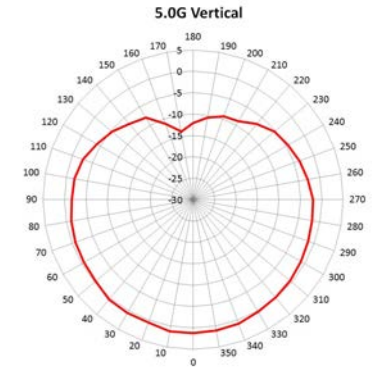
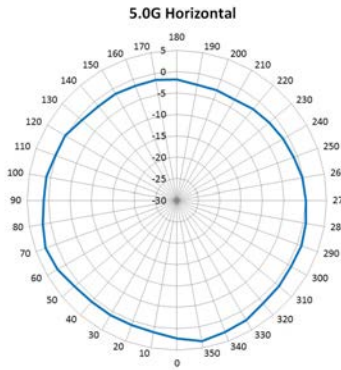
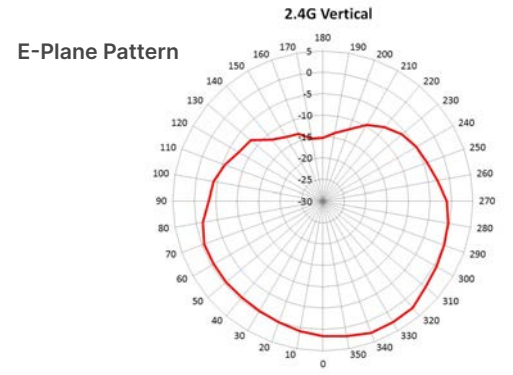
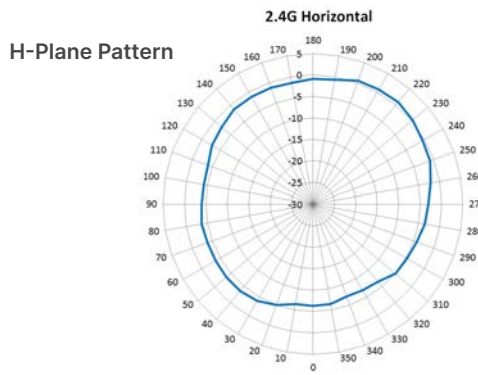
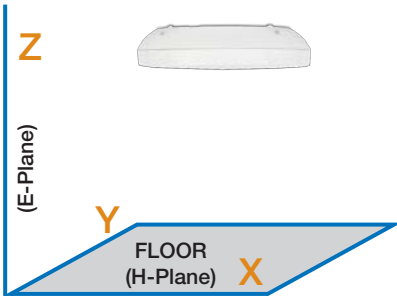

FAP-223E

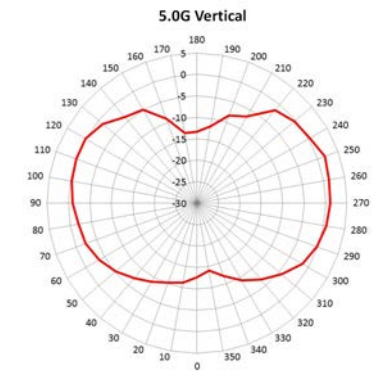
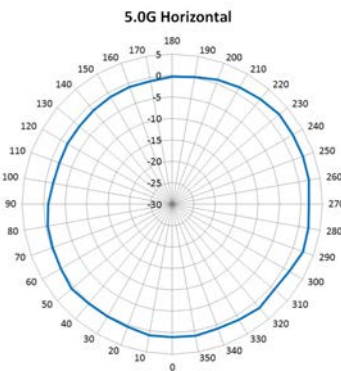
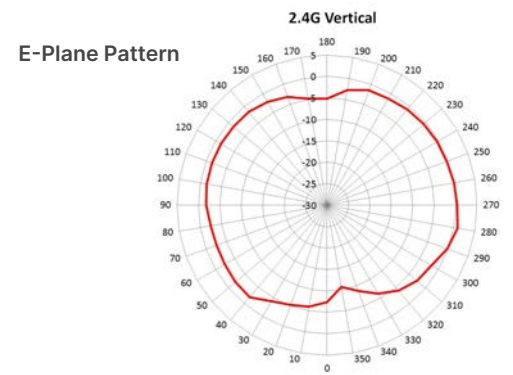
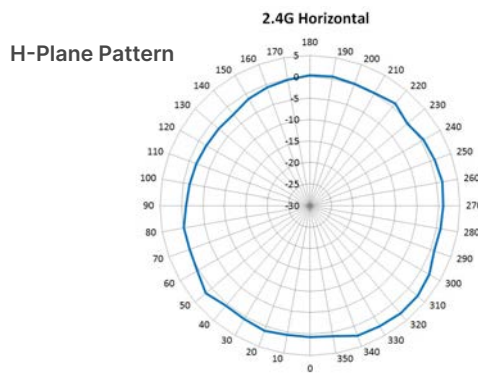
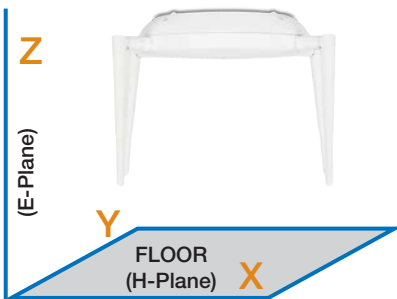

Ordering Information

Product	SKU	Description
FortiAP-441K	FAP-441K	Indoor Wireless AP - 4 radios (Wi-Fi-7 Tri-band 2.4/5/6GHz 4+4+4 4 streams 4 radios), internal antennas, 2x 10G Base-T RJ45, BT/BLE, 1x Type A USB, 1x RS-232 RJ45 Serial Port. Ceiling/wall mount kit included. For power order: 802.3bt PoE injector.
	FC-10-FP41K-247-02-DD	FortiCare Premium Support.
	FC-10-FP41K-284-02-DD	FortiCare Elite Support.
FortiAP-443K	FAP-443K-A	Indoor Wireless AP - 4 radios (Wi-Fi-7 Tri-band 2.4/5/6GHz 4+4+4 4 streams 4 radios), external antennas, 2x 10G Base-T RJ45, BT/BLE, 1x Type A USB, 1x RS-232 RJ45 Serial Port. Ceiling/wall mount kit included. For power order: 802.3bt PoE injector. Region Code A.
	FC-10-FP43K-247-02-DD	FortiCare Premium Support.
	FC-10-FP43K-284-02-DD	FortiCare Elite Support.
FortiAP 431G	FAP-431G	Indoor Wireless AP - Tri radio (Wi-Fi-6E IEEE 802.11ax Tri-band 2.4/5/6GHz and dual 5G operation 4+4+4 4 streams 3 radios), internal antennas, 2x 5G Base-T RJ45, BT/BLE, 1x Type A USB, 1x RS-232 RJ45 Serial Port. Ceiling/wall mount kit included. For power order: 802.3bt PoE injector or AC adapter SP-FAP400-PA. SP-FAP-250-PA.
	FC-10-PG431-247-02-DD	FortiCare Premium Support.
	FC-10-PG431-284-02-DD	FortiCare Elite Support.
	FC-10-PG431-595-02-DD	FortiSASE subscription for cloud managed FortiAP with 2 Mbps bandwidth included.
FortiAP 432G	FAP-432G-A	Outdoor Wireless FortiAP - Tri radio (1x 802.11b/g/n/ax 4x4 radio, 1x 802.11a/n/ac/ax 4x4 Radio and 1x 802.11 a/b/g/n/ac/ax 6GHz, 2x2), 1x 10/100/1000/2500/10000 Base-T RJ45, 1x 10/100/1000 Base-T RJ45, BT/BLE + Zigbee, 1x RS-232 RJ45 Serial Port. External Dual Band N-Type Omni Directional antennas, Integrated mounting bracket for Antenna included + Wall/Pole Mount mounting kit. Ships with PoE injector.
	FC-10-P432G-247-02-DD	FortiCare Premium Support.
	FC-10-P432G-284-02-DD	FortiCare Elite Support.
	FC-10-P432G-595-02-DD	FortiSASE subscription for cloud managed FortiAP with 2 Mbps bandwidth included.
FortiAP 433G	FAP-433G	Indoor Wireless AP - Tri radio (Wi-Fi-6E IEEE 802.11ax Tri-band 2.4/5/6GHz and dual 5G operation 4+4+4 4 streams 3 radios), external antennas, 2x 5G Base-T RJ45, BT/BLE, 1x Type A USB, 1x RS-232 RJ45 Serial Port. Ceiling/wall mount kit included. For power order: 802.3bt PoE injector or AC adapter SP-FAP400-PA. SP-FAP-250-PA. Region Code A.
	FC-10-PG433-247-02-DD	FortiCare Premium Support.
	FC-10-PG433-284-02-DD	FortiCare Elite Support.
	FC-10-PG433-595-02-DD	FortiSASE subscription for cloud managed FortiAP with 2 Mbps bandwidth included.
FortiAP 231G	FAP-231G	Indoor Wireless AP - Tri radio (Wi-Fi-6E IEEE 802.11ax Tri-band 2.4/5/6GHz and dual 5G operation 2+2+2 2 streams 3 radios), internal antennas, 1x10/100/1000 RJ45, 1x 100/1000/2500 Base-T RJ45, BT/BLE, 1x Type A USB, 1x RS-232 RJ45 Serial Port. Ceiling/wall mount kit included. For power order: 802.3at PoE injector GPI-130 or AC adapter SP-FAP200-PA.
	FC-10-PG231-247-02-DD	FortiCare Premium Support.
	FC-10-PG231-284-02-DD	FortiCare Elite Support.
	FC-10-PG231-595-02-DD	FortiSASE subscription for cloud managed FortiAP with 2 Mbps bandwidth included.
FortiAP 233G	FAP-233G	Indoor Wireless AP - Tri radio (Wi-Fi-6E IEEE 802.11ax Tri-band 2.4/5/6GHz and dual 5G operation 2+2+2 2 streams 3 radios), external antennas, 1x10/100/1000 RJ45, 1x 100/1000/2500 Base-T RJ45, BT/BLE, 1x RS-232 RJ45 Serial Port. Ceiling/wall mount kit included. For power order: 802.3at PoE injector GPI-130 or AC adapter SP-FAP200-PA.
	FC-10-PG233-247-02-DD	FortiCare Premium Support.
	FC-10-PG233-284-02-DD	FortiCare Elite Support.
	FC-10-PG233-595-02-DD	FortiSASE subscription for cloud managed FortiAP with 2 Mbps bandwidth included.
FortiAP 234G	FAP-234G	Outdoor Wireless AP - Tri radio, WiFi 6E, included, 2x 2.5G RJ45 port, BT/BLE, 1x Type A USB, 1x RS-232 RJ45 Serial Port. Pole/wall mount kit included. Region Code A. Ships with PoE injector.
	FC-10-PG234-247-02-DD	FortiCare Premium Support.
	FC-10-PG234-284-02-DD	FortiCare Elite Support.
	FC-10-PG234-595-02-DD	FortiSASE subscription for cloud managed FortiAP with 2 Mbps bandwidth included.
FortiAP 831F	FAP-831F	Indoor Wireless AP - Tri radio (1x 802.11 a/b/g/n/ac/ax 4x4 MIMO, 1x 802.11 a/b/g/n/ac/ax 8x8 MIMO and 1x 802.11 a/b/g/n/ac Wave 2 1x1 MU-MIMO), internal antennas, 1x 100/1000/5000 Base-T RJ45, 1x 10/100/1000 Base-T RJ45, BT/BLE, 1x Type A USB, 1x RS-232 RJ45 Serial Port. Ceiling/wall mount kit included. For power order 802.3at PoE injector GPI-130 or AC adapter SP-FAP400-PA.
	FC-10-F831F-247-02-DD	FortiCare Premium Support.
	FC-10-P831F-284-02-DD	FortiCare Elite Support.
	FC-10-P831F-595-02-DD	FortiSASE subscription for cloud managed FortiAP with 2 Mbps bandwidth included.
FortiAP 431F	FAP-431F	Indoor Wireless AP - Tri radio (2x 802.11 a/b/g/n/ac/ax, 4x4 MIMO and 1x 802.11 a/b/g/n/ac Wave 2, 1x1 MU-MIMO), internal antennas, 1x 100/1000/2500 Base-T RJ45, 1x 10/100/1000 Base-T RJ45, BT/BLE, 1x Type A USB, 1x RS-232 RJ45 Serial Port. Ceiling/wall mount kit included. For power order 802.3at PoE injector GPI-130 or AC adapter SP-FAP400-PA.
	FC-10-F431F-247-02-DD	FortiCare Premium Support.
	FC-10-F431F-284-02-DD	FortiCare Elite Support.
	FC-10-F431F-595-02-DD	FortiSASE subscription for cloud managed FortiAP with 2 Mbps bandwidth included.
FortiAP 433F	FAP-433F	Indoor Wireless AP - Tri radio (2x 802.11 a/b/g/n/ac/ax, 4x4 MIMO and 1x 802.11 a/b/g/n/ac Wave 2, 1x1 MU-MIMO), external antennas included, 1x 100/1000/2500 Base-T RJ45, 1x 10/100/1000 Base-T RJ45, BT/BLE, 1x Type A USB, 1x RS-232 RJ45 Serial Port. Ceiling/wall mount kit included. For power order 802.3at PoE injector GPI-130 or AC adapter SP-FAP400-PA.
	FC-10-F433F-247-02-DD	FortiCare Premium Support.
	FC-10-F433F-284-02-DD	FortiCare Elite Support.
	FC-10-F433F-595-02-DD	FortiSASE subscription for cloud managed FortiAP with 2 Mbps bandwidth included.



Ordering Information

Product	SKU	Description
FortiAP 432F	FAP-432F	Ruggedized indoor/outdoor Wireless FortiAP - Tri radio (1× 802.11b/g/n/ax 4×4 radio, 1 × 802.11a/n/ac/ax 4×4 Radio and 1× 802.11 a/b/g/n/ac Wave 2, 2×2), 1× 100/1000/2500 Base-T RJ45, 1× 10/100/1000 Base-T RJ45, BT/BLE + Zigbee, 1x RS-232 RJ45 Serial Port. External Dual Band N-Type Omnidirectional antennas, Integrated mounting bracket for Antenna included + Wall/Pole Mount mounting kit. Ships with passive PoE injector.
	FC-10-PF432-247-02-DD	FortiCare Premium Support.
	FC-10-PF432-284-02-DD	FortiCare Elite Support.
	FC-10-PF432-595-02-DD	FortiSASE subscription for cloud managed FortiAP with 2 Mbps bandwidth included.
FortiAP 432FR	FAP-432FR	UL Class 1, Division 2. Outdoor Wireless FortiAP - Tri radio (1× 802.11b/g/n/ax 4×4 radio, 1 × 802.11a/n/ac/ax 4×4 Radio and 1× 802.11 a/b/g/n/ac Wave 2, 2×2), 1× 10/100/1000/2500 Base-T RJ45, 1× 10/100/1000 Base-T RJ45, BT/BLE + Zigbee, 1x RS-232 RJ45 Serial Port. External Dual Band N-Type Omni Directional antennas, Integrated mounting bracket for Antenna included + Wall/Pole Mount mounting kit. For power order: 802.3at PoE injector GPI-130 or AC adapter SP-FAP400-PA.
	FC-10-FR432-247-02-DD	FortiCare Premium Support.
	FC-10-FR432-284-02-DD	FortiCare Elite Support.
	FC-10-FR432-595-02-DD	FortiSASE subscription for cloud managed FortiAP with 2 Mbps bandwidth included.
FortiAP 231F	FAP-231F	Indoor Wireless AP - Tri radio (802.11 b/g/n/ax 2×2 MU-MIMO, 802.11 a/n/ac/ax 2×2 MU-MIMO and 1× 802.11 a/b/g/n/ac Wave 2, 1×1), internal antennas, 2× 10/100/1000 RJ45 port, BT/BLE, 1x Type A USB, 1x RS-232 RJ45 Serial Port. Ceiling/wall mount kit included. For power order 802.3at PoE injector GPI-130 or AC adapter SP-FAP250-PA-10.
	FC-10-PF231-247-02-DD	FortiCare Premium Support.
	FC-10-PF231-284-02-DD	FortiCare Elite Support.
	FC-10-PF231-595-02-DD	FortiSASE subscription for cloud managed FortiAP with 2 Mbps bandwidth included.
FortiAP 234F	FAP-234F	Outdoor Wireless AP - Tri radio (802.11 b/g/n/ax 2×2 MU-MIMO, 802.11 a/n/ac/ax 2×2 MU-MIMO and 1× 802.11 a/b/g/n/ac Wave 2, 1×1), internal antennas, 2× 10/100/1000 RJ45 port, BT/BLE, 1x RS-232 RJ45 Serial Port. Pole/wall mount kit and PoE injector included. Region Code A.
	FC-10-P234F-247-02-DD	FortiCare Premium Support.
	FC-10-P234F-284-02-DD	FortiCare Elite Support.
	FC-10-P234F-595-02-DD	FortiSASE subscription for cloud managed FortiAP with 2 Mbps bandwidth included.
FortiAP 23JF	FAP-23JF	Wall Plate AP - Tri radio (802.11 b/g/n/ax 2×2 MU-MIMO, 802.11 a/n/ac/ax 2×2 MU-MIMO and 1× 802.11 a/b/g/n/ac Wave 2, 1×1), internal antennas, 4 × 10/100/1000 RJ45 port (1× 802.3at PoE PD, 1× 802.3af PoE PSE, 2x Non-PoE Ports), 2 RJ-45 Ports (1xPass-through in, 1x Pass-through out), BT / BLE, 1x RS-232 RJ45 Serial Port. Wall plate mounting kit included. For power order 802.3at PoE injector GPI-130. Optional Accessory AC power adapter SP-FAP23J-PAX-10; Desktop stand FAP-MNT-WJ-20.
	FC-10-P23JF-247-02-DD	FortiCare Premium Support.
	FC-10-P23JF-284-02-DD	FortiCare Elite Support.
	FC-10-P23JF-595-02-DD	FortiSASE subscription for cloud managed FortiAP with 2 Mbps bandwidth included.
FortiAP 221E	FAP-221E	Indoor Wireless AP - Dual radio (802.11 b/g/n and 802.11 a/n/ac Wave 2, 2×2 MU-MIMO), internal antennas, 1 × 10/100/1000 RJ45 port, BT / BLE. Ceiling/wall mount kit included. For power order 802.3af PoE injector GPI-115 or AC adapter SP-FAP200-PA.
	FC-10-PE221-247-02-DD	FortiCare Premium Support.
	FC-10-PE221-284-02-DD	FortiCare Elite Support.
FortiAP 223E	FAP-223E	Indoor Wireless AP - Dual radio (802.11 b/g/n and 802.11 a/n/ac Wave 2, 2×2 MU-MIMO), external antennas included, 1 × 10/100/1000 RJ45 port, BT / BLE. Ceiling/wall mount kit included. For power order 802.3af PoE injector GPI-115 or AC adapter SP-FAP200-PA.
	FC-10-PE223-247-02-DD	FortiCare Premium Support.
	FC-10-PE223-284-02-DD	FortiCare Elite Support.
UTP Services (G Series)	FC-10-APGIS-768-02-DD	FortiAP G Series FortiGuard Universal Threat Protection Subscription Service License for Application control and Web filtering modules. Applicable to FortiGate or FortiCloud managed G-Series or later FortiAP family Access Points.
FortiLAN Cloud	FC-10-90AP1-639-02-DD	FortiLAN Cloud FortiAP Management License Includes: Full suite of FortiAP Management Features, 1 year Log Retention, FortiCare Premium (Note, FortiCare only applicable when used with FortiLAN Cloud).
Gigabit PoE Injector	GPI-115	1-port Gigabit PoE power injector, 802.3af 15.4 W, 10/100/1000.
	GPI-130	1-port Gigabit PoE power injector, 802.3at up to 30 W.
	GPI-145	1-port Multi-Gigabit PoE power injector, 802.3bt up to 60W.
Power Adapter	SP-FAP400-PA	AC power adapter 12v, 3.0A - 36W for FAP-231G, FAP-233G, FAP-431G, FAP-433G, FAP-831F, FAP-431F, FAP-433F, and FAP-C24JE.
	SP-FAP200-PA	AC power adapter 12v, 2.5A - 30W for FAP-221E, and FAP-223E.
	SP-FAP23J-PA-10	AC power adapter 48v, 1.04A - 50W without power cord for FAP-23JF.
	SP-FAP250-PA-10	AC power adapter 12v, 4.0A - 48W with Extended operating temp 0°C - 50°C with US and EU plugs for FAP-U231F, FAP-231F, FAP-431G, and FAP-433G.
Desktop Stand	FAP-MNT-WJ-20	Desktop stand for FAP/FAP-C/FAP-U wall jack style APs. Converts wall mounting hardware included with unit to desktop mounting - 20 pack.

Notes.

- Additional external antenna options available for some models. See antenna datasheet for details.
- A country suffix code (-A, -B, -C, -D, -E, -F, -I, -J, -K, -N, -P, -S, -T, -U, -V, -W, or -Y) applies to all AP models based upon country of deployment. Work with your local supplier for the correct model in your regulatory domain.
- Access Points mentioned in this datasheet are covered by a Limited Lifetime Hardware Warranty. Terms and conditions can be found in the EULA at <https://www.fortinet.com/content/dam/fortinet/assets/legal/EULA.pdf>

For more information on Support levels, please reference FortiCare Services [here](#).



Fortinet CSR Policy

Fortinet is committed to driving progress and sustainability for all through cybersecurity, with respect for human rights and ethical business practices, making possible a digital world you can always trust. You represent and warrant to Fortinet that you will not use Fortinet's products and services to engage in, or support in any way, violations or abuses of human rights, including those involving illegal censorship, surveillance, detention, or excessive use of force. Users of Fortinet products are required to comply with the [Fortinet EULA](#) and report any suspected violations of the EULA via the procedures outlined in the [Fortinet Whistleblower Policy](#).

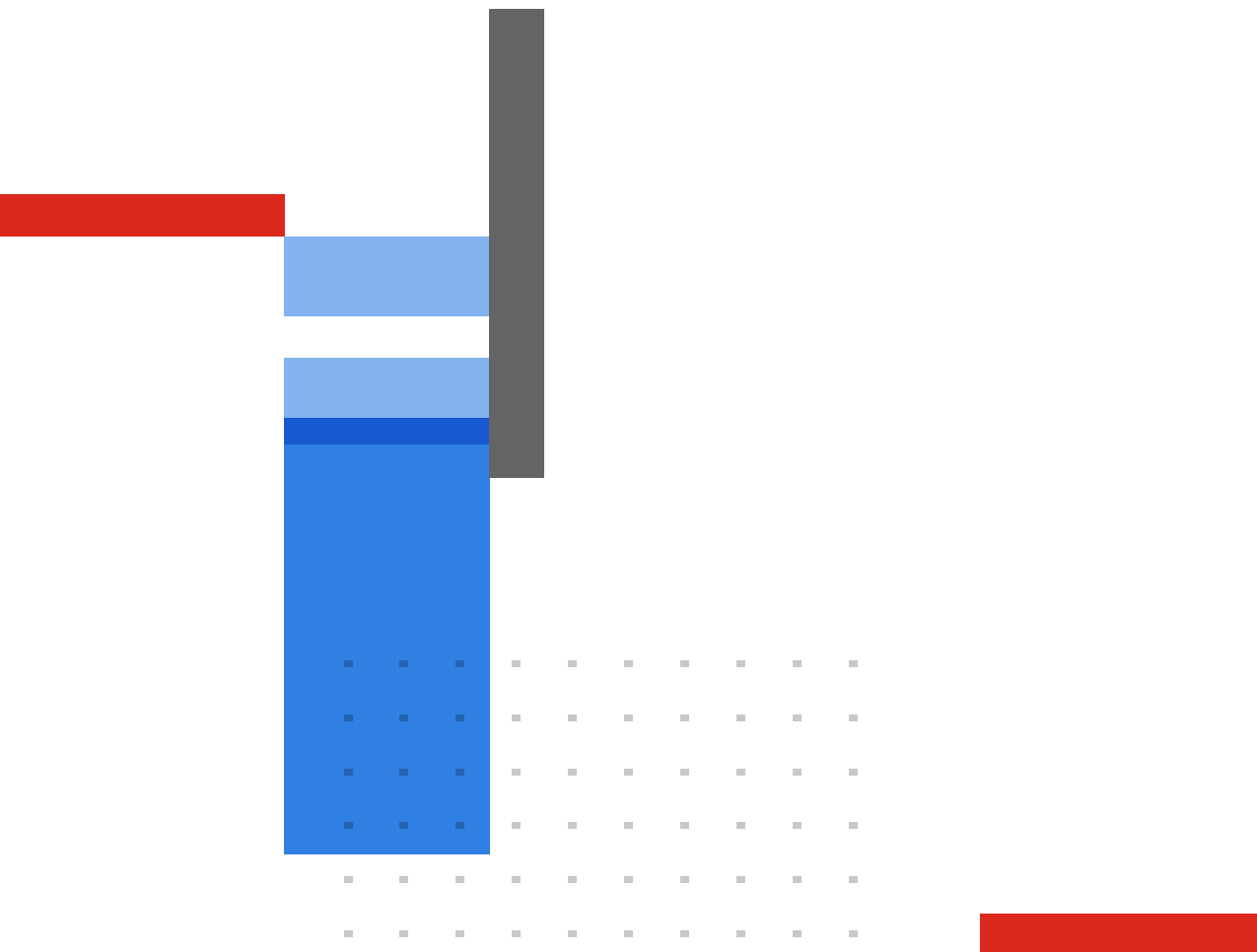

www.fortinet.com

Copyright © 2024 Fortinet, Inc. All rights reserved. Fortinet®, FortiGate®, FortiCare® and FortiGuard®, and certain other marks are registered trademarks of Fortinet, Inc., and other Fortinet names herein may also be registered and/or common law trademarks of Fortinet. All other product or company names may be trademarks of their respective owners. Performance and other metrics contained herein were attained in internal lab tests under ideal conditions, and actual performance and other results may vary. Network variables, different network environments and other conditions may affect performance results. Nothing herein represents any binding commitment by Fortinet, and Fortinet disclaims all warranties, whether express or implied, except to the extent Fortinet enters a binding written contract, signed by Fortinet's Chief Legal Officer, with a purchaser that expressly warrants that the identified product will perform according to certain expressly-identified performance metrics and, in such event, only the specific performance metrics expressly identified in such binding written contract shall be binding on Fortinet. For absolute clarity, any such warranty will be limited to performance in the same ideal conditions as in Fortinet's internal lab tests. Fortinet disclaims in full any covenants, representations, and guarantees pursuant hereto, whether express or implied. Fortinet reserves the right to change, modify, transfer, or otherwise revise this publication without notice, and the most current version of the publication shall be applicable.