

## GV-TDR4704 4MP H.265 Super Low Lux WDR Pro IR Mini Fixed Rugged IP

### Dome



- 1/3" progressive scan super low lux CMOS sensor
- Min. illumination at 0.003 lux
- Dual streams from H.265, H.264 or MJPEG
- Up to 30 fps at 2688 x 1520
- Intelligent IR
- Day and night function (with removable IR-cut filter)
- Wide Dynamic Range Pro (WDR Pro)
- IR distance up to 30 m (100 ft)
- Built-in micro SD card slot (SD / SDHC / SDXC / UHS-I) for local storage
- 3-axis mechanism (pan / tilt / rotate)
- Ingress protection (IP67)
- Vandal Resistance (IK10)
- DC 12 V / PoE (IEEE 802.3af)
- Defog
- 3D noise reduction
- Motion detection
- Text overlay
- Privacy mask
- 12 languages supported
- ONVIF (Profile G, S, T) conformant

### Introduction

The Mini Fixed Rugged IP Dome is an outdoor, fixed, network camera equipped with an automatic IR-cut filter and an IR LED for day and night surveillance. The camera supports H.265 video codec to achieve better compression ratio while maintaining high quality pictures at reduced network bandwidths. It adheres to IP67 and IK10 standards, and can be powered through PoE. With its WDR Pro, it can process scenes with contrasting intensity of lights and produce clear image.

### Models

Model	Iris	Focal Length (mm)	Horizontal FOV	Maximum Aperture	Image Format
GV-TDR4704-2F	Fixed	2.8 mm	101°	F/1.6	1/3"
GV-TDR4704-4F		4 mm	83.7°		

### Dimensions

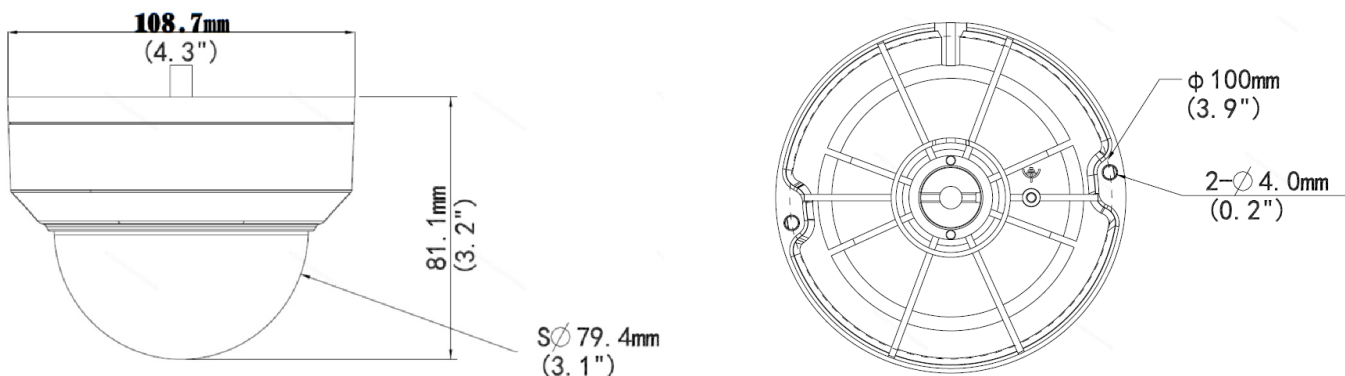

## Specifications

Camera					
Image Sensor		1/3" progressive scan super low lux CMOS			
Picture Elements		2688 (H) x 1520 (V)			
Minimum Illumination	Color	0.003 Lux (F1.6, AGC ON)			
	IR ON	0 Lux			
Shutter Speed		Auto / Manual (1 ~ 1/100000s)			
White Balance		Auto / Manual			
Gain Control		Auto / Manual			
S/N Ratio		56 dB			
WDR Pro		Yes			
Dynamic Range		120 dB			
Lens		GV-TDR4704-2F	GV-TDR4704-4F		
Megapixel		4 MP			
Day / Night		Yes (with removable IR-cut filter)			
Lens Type		Fixed			
Focal Length		2.8 mm	4 mm		
Maximum Aperture		F/1.6			
Mount		M12			
Horizontal FOV		101°	83.7°		
Operation	Focus	Fixed			
	Zoom				
	Iris				
IR LED Quantity		1 IR LED			
Max. IR Distance		30 m (100 ft)			
DORI		Detect	Observe	Recognize	Identify
Lens	2.8 mm	63 m (206.7 ft)	25.2 m (82.7 ft)	12.6 m (41.3 ft)	6.3 m (20.7 ft)
Operation					
Video Compression		H.265, H.264, MJPEG			
Video Streaming		Dual streams from H.265, H.264 or MJPEG			
Video Resolution	Main Stream	2688 x 1520 (Default), 2560 x 1440, 2304 x 1296, 1920 x 1080, 1280 x 720			
	Sub Stream	1280 x 720, 720 x 576, 640 x 480, 640 x 360 (Default)			
Frame Rate		30 fps at 2688 x 1520 (60 / 50 Hz) * The frame rate and performance may vary depending on the number of connections and data bitrates (different scenes).			
Video Analytics		Motion Detection, Tampering Alarm, Cross Line, Intrusion *Tampering Alarm, Cross Line, Intrusion are only accessible through the camera's Web interface, which can be used to trigger alerts such as e-mail and FTP			
Image Setting		Brightness, Contrast, Saturation, Sharpness, Flicker-less, Image Orientation (Flip, Mirror, 0°, 90°, 180°, 270°-including Corridor format)			
Network					
Interface		10/100 Ethernet			
Protocol		802.1x, ARP, DHCP, DDNS, DNS, DynDNS, FTP, HTTP, HTTPS, ICMP, IGMP, IPv4, IPv6, NTP, PPPoE, QoS, RTCP, RTP, RTSP, SMTP, SNMP, TCP, UDP, UPnP, ONVIF (Profile G, S, T)			
Mechanical					
Temperature Detector		No			
Camera Angle Adjustment	Pan	3° ~ 360°			
	Tilt	0° ~ 68°			
	Rotate	3° ~ 360°			
Connectors	Power	DC Jack (DC 12 V, 1.25 A), PoE			
	Ethernet	RJ-45 connector			
	Local Storage	Micro SD card slot (SD/SDHC/SDXC/UHS-I, Class 10) *UHS-II card type is not supported.			
General					
Operating Temperature		-30 °C ~ 60 °C (-22 °F ~ 140 °F)			
Humidity		0% ~ 95% (no condensation)			

Power Source	12 V DC / PoE (IEEE802.3af)
Max. Power Consumption	5.5 W
Dimensions	∅ 108.7 x 81.1 mm (∅4.3" x 3.2")
Weight	0.35 kg (0.77 lb)
Ingress Protection	IP67
Vandal Resistance	IK10
Certification	FCC, CE, RoHS, UL compliant
<b>Web Interface</b>	
Installation Management	Web-based configuration
Maintenance	Firmware upgrade through Web Browser or GV-IP Device Utility
Access from Web Browser	Live View, Video Recording, Change Video Quality, Bandwidth Control, Image Snapshot, Defog, Text Overlay, Image Masking
Language	Czech, English, French, German, Hungarian, Italian, Japanese, Polish, Portuguese, Russian, Spanish, Traditional Chinese
<b>Applications</b>	
Software Supported	GV-VMS (V17.4.1 / V18.2.1), GV-DVR / NVR (V8.9.1), GV-Control Center (V3.8.0), GV-Recording Server / Video Gateway (V2.0.0), GV-Edge Recording Manager Win version (V2.0.0), GV-Redundant / Failover Server (V1.2.0), GV-Mobile Server (V1.5.0.0)
Smart Device Access	GV-Eye for iOS and Android
Live Viewing	Browser (IE, Edge, Chrome, Firefox), Mobile App

**Note:**





1. It is required to apply patch files to some or all of the supported software.
2. Do not use clothes or any ordinary material to clean the camera cover since they may result in scratches.
3. Specifications are subject to change without notice.

**Packing List**

- |                          |                          |
|--------------------------|--------------------------|
| 1. GV-TDR4704 Dome       | 4. Torx Wrench           |
| 2. Waterproof Rubber Set | 5. Drill Template Paster |
| 3. Screw Kit             | 6. Download Guide        |

**Accessories**

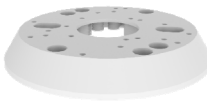
Model No.	Name		Details
GV-Mount107 (must be used with GV-Mount213)	Pendant Bracket		Dimensions: ∅ 120 x 334 mm (∅ 4.72" x 13.15") Weight: 0.74 kg (1.63 lb)
GV-Mount211P	Wall Mount and Junction Box		Dimensions: ∅ 233 x 125 x 125 mm (∅ 9.2" x 4.9" x 4.9") Weight: 1 kg (2.2 lb)
GV-Mount213	Wall / Ceiling Box Mount		Dimensions: ∅ 109 x 39 mm (∅ 4.3" x 1.5") Weight: 0.2 kg (0.44 lb)
GV-Mount300-2	Convex Corner Mount		Dimensions: 137 x 233 x 160 mm (5.4" x 9.17" x 6.3") Weight: 1.65 kg (3.64 lb)

GV-Mount310-2	Concave Corner Mount		Dimensions: 111.2 x 369.9 x 210 mm (2.6" x 11.4" x 6.6") Weight: 1.65 kg (3.64 lb)
GV-Mount420 (must be used with GV-Mount211P)	Pole Mount Bracket		Dimensions: $\varnothing$ 120 x 120 x 53.4 mm ( $\varnothing$ 4.7" x 4.7" x 2.1") Weight: 0.45 kg (0.99 lb) Steel Strap Diameter: $\varnothing$ 67 ~ 127 mm ( $\varnothing$ 2.6" ~ 5")
GV-Mount704 (must be used with GV-Mount107)	Extension Tube		Dimensions: $\varnothing$ 3.5 x 10 or 20 or 30 or 50 cm ( $\varnothing$ 1.38" x 3.9" or 7.9" or 11.8" or 19.7") Weight: 225 g or 360 g or 500 g or 780 g (0.5 lb or 0.79 lb or 1.1 lb or 1.72 lb)
GV-Mount924 (for standard US single and double gang boxes only)	Power Box Mount Bracket		Dimensions: $\varnothing$ 128 x 18.5 mm ( $\varnothing$ 5" x 0.7") Weight: 0.15 kg (0.33 lb)
GV-PA191	PoE Adapter		The GV-PA191 is a Power over Ethernet (PoE) adapter designed to provide power to the IP device through a single Ethernet cable.
GV-PA301	Gigabit PoE Adapter		GV-PA301 is a Gigabit Power over Ethernet (PoE) adapter.
GV-POE Switch		GV-POE Switch is designed to provide power along with network connection for IP devices. The GV-POE Switch is available in various models with different numbers and types of ports.	
Power Adapter		Contact our sales representatives for the countries and areas supported.	