

SN3402

2-Port RS-232/422/485 Secure Device Server





Instantly Connect Serial Devices with Secure Access

SN3402 Secure Device Server



An easy-to-use, secure, and reliable solution makes it easier to connect a wide range of serial devices to an IP-based Ethernet LAN in an instant. The ATEN SN3402 Secure Device Server provides simple, fast serial-to-Ethernet connectivity, allowing users to remotely access serial RS-232/422/485 devices from a PC located anywhere. With various reliable features, the SN3402 solution is ideal for commercial and industrial process control applications.



Serial-to-Ethernet



Surge Protection



1.5 kV Magnetic Isolation

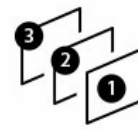

3-step Web Console



Power Redundancy

Surge and Isolation Protection Ensure System Stability

Surge protection is a vital aspect of any facility's coordinated electrical protection to ensure safe and reliable operation. To this end, in addition to 1.5kV magnetic isolation protection for Ethernet signals, the SN3402 Secure Device Server features surge protection for serial, Ethernet, and power that protect against voltage spikes or uncontrolled increase in current. Furthermore, as well as industrial safety standards compliance, they are also tested to meet IEC 61000-4 surge wave form requirements to ensure system stability and reliability.

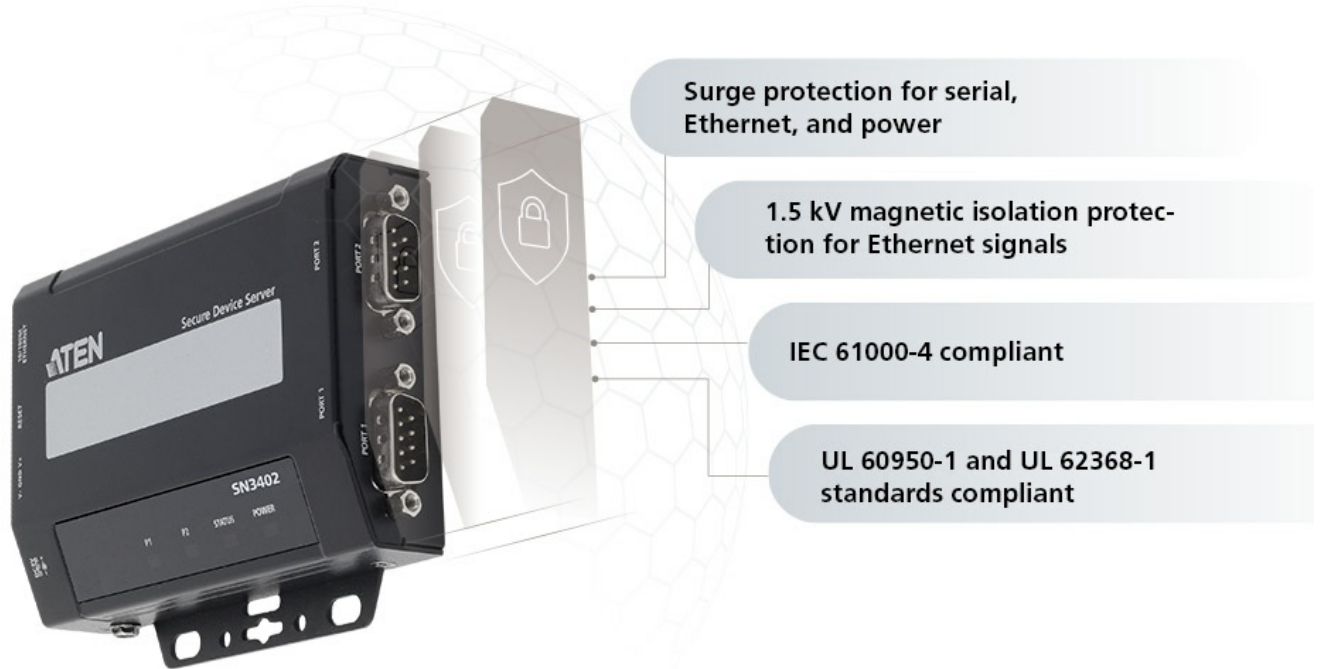

Level-up Device Security at Every Stage

The growing numbers of cyber attacks in the industrial IoT era has the potential to bring down systems and cause huge losses of time and money. In order to avoid potential vulnerability risks, enterprises need a multi-layered defense system to ensure secure data transmissions that include regular firmware upgrades, as well as various encrypted forms of authentication and access control. The SN3402 secure serial-to-Ethernet solution is equipped with security functions at every level, including network access control and user authentication, data integrity, and confidentiality. Furthermore, with an operation mode available for advanced security functions, you can acquire any field data needed and provide frontline protection.



User Authentication

- Secure web access with HTTPS
- Secure console access with SSHv2
- Local and third-party authentication (RADIUS)
- User privilege control

Encrypted Data Transmission and Confidentiality

- Real COM
- TCP Server/Client
- Serial Tunneling Server/Client
- Console Management (SSHv2)

Network Access Control and Authentication

- IP address filter

Vulnerability Management

- Administrator can determine which network services need to be enabled
- Regular firmware upgrades

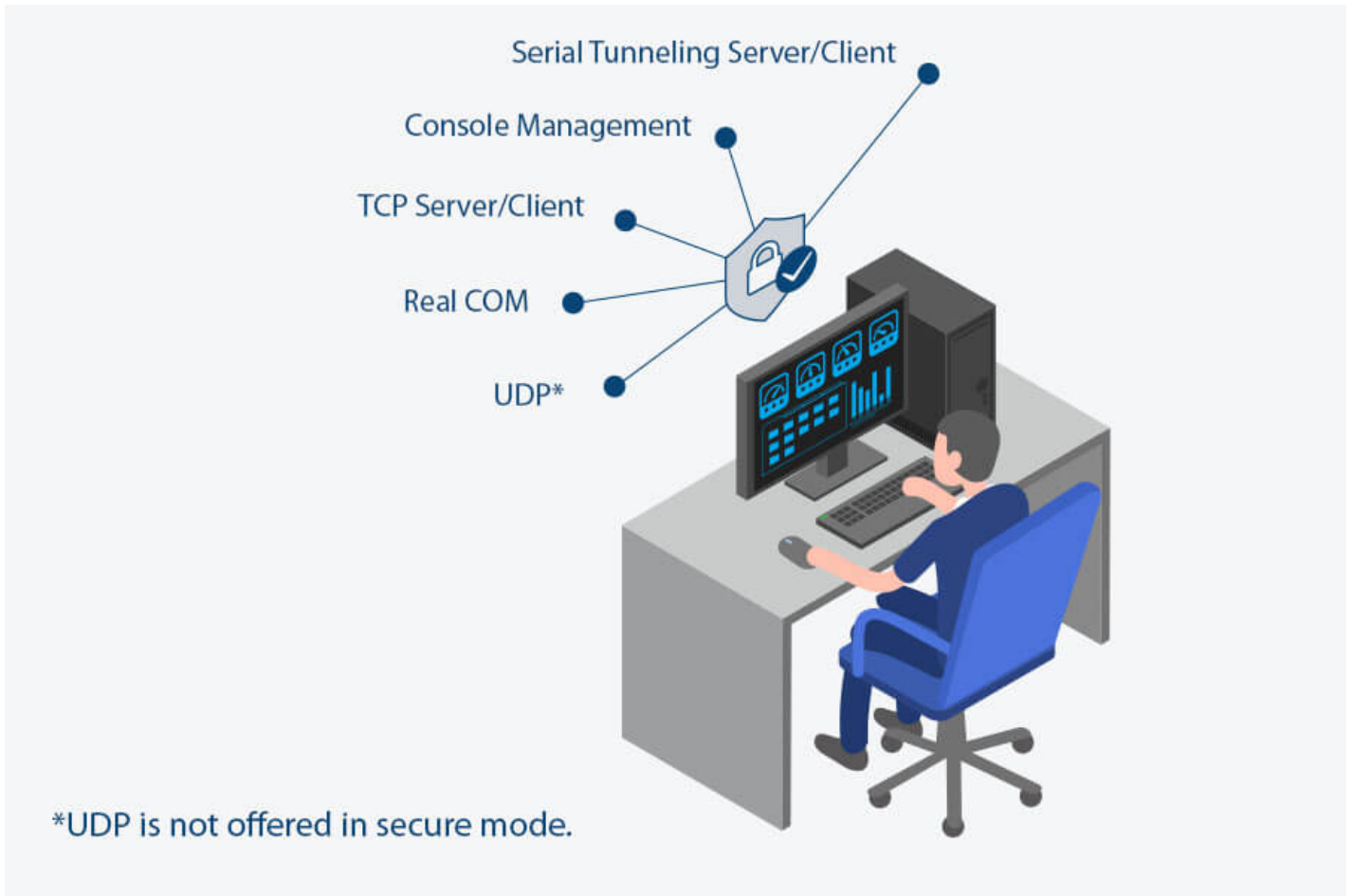

Comprehensive Secure Operation Modes

The SN3402 offers a broad choice of operation modes to help different types of serial devices to be seen on the network including Real COM, TCP, Serial Tunneling, Console Management, and UDP. With each operation mode the SN3402 is equipped with advanced secure functions to assist users in streamlining operations and ensuring serial data is securely transmitted.

*UDP is not offered in secure mode.

Seamless and Cost-Effective Modbus Gateway

The SN3402 can be used as standard Modbus gateway for conversion between Modbus TCP and Modbus RTU / ASCII protocols. It can integrate Modbus serial slave devices seamlessly into an existing Modbus TCP network, thereby making them accessible to serial master devices.

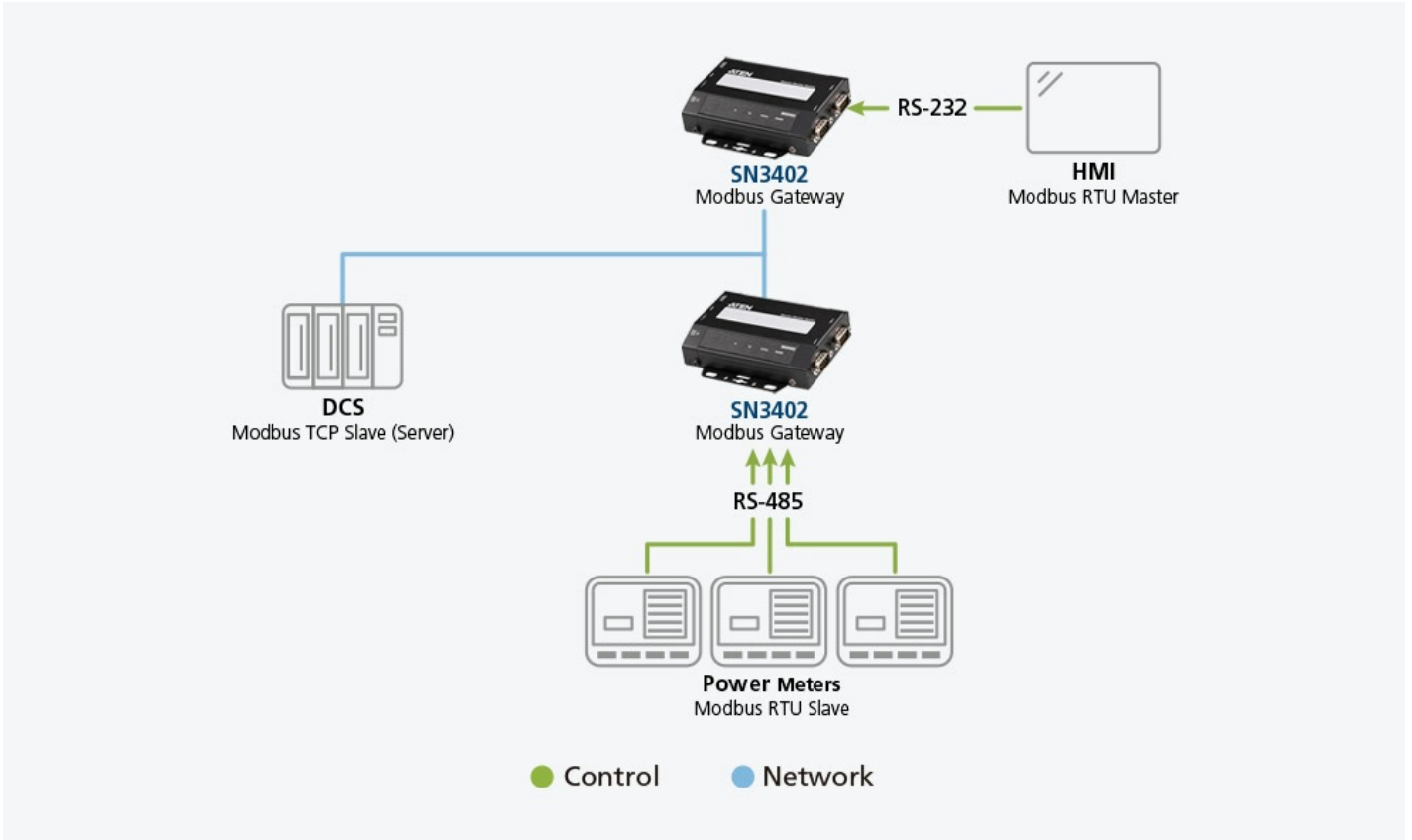

Easy Setup with Web Console and Telnet/SSH Console

The SN3402 offers a 3-step setup web console for fast installation. Its browser access is supported via intuitive multi-language features that facilitate a quick setup and control of the devices in just three configuration steps to activate the application. This makes setup simple and fast, and users can complete it in an average of only one minute. Moreover, for bandwidth-sensitive applications, a Telnet/SSH console is also available as a low-bandwidth solution.



Intuitive web console for fast configuration



Terminal-based access via Telnet/SSH console for low-bandwidth applications



Ultra-Low Power Consumption

Operates in standby mode of less than 1W for power critical applications or cost saving.



Redundant Power

Ensures constant system availability and uptime in industrial environments.

Contact Us

Get a quote for this product or get in touch with our sales experts

[Get Quote](#)

[Contact Sales](#)

Easy to Troubleshoot

ATEN understands the seriousness of data loss and breaches. The SN3402 features 64 KB port buffering to prevent data loss in case a network is down, and event notifications will be sent automatically by SMTP email and SNMP Trap if serial devices go offline due to power failure, or trigger a user defined error. Moreover, system event logs are available to record and track operation history, and can be saved to internal memory or a Syslog server, so you can retrieve data for monitoring and troubleshooting at any time.

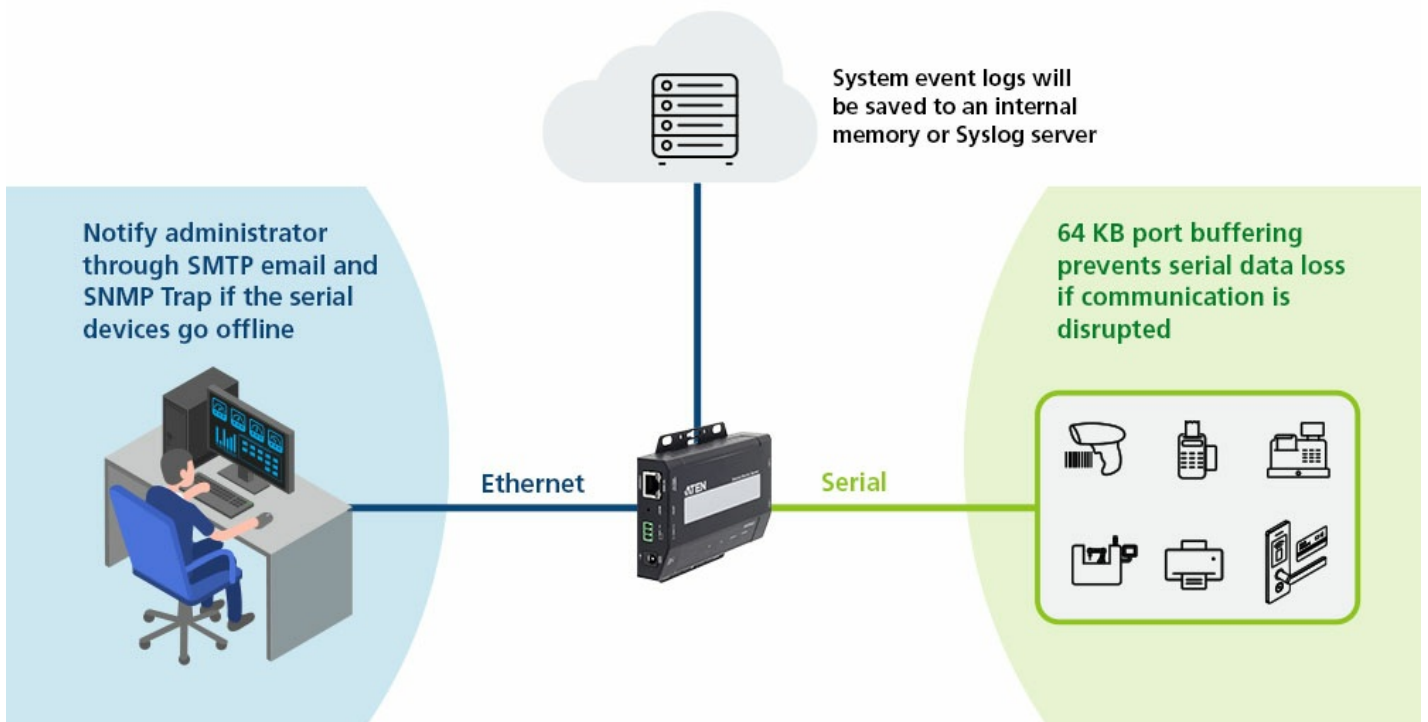

Target Applications

The SN3402 enables instant networking of serial devices and can be deployed in a variety of commercial applications and industrial process automation environments that require serial-to-Ethernet connectivity. These include POS, access control, SCADA systems, environment monitoring, sensor monitoring, device management, remote site management, and more.

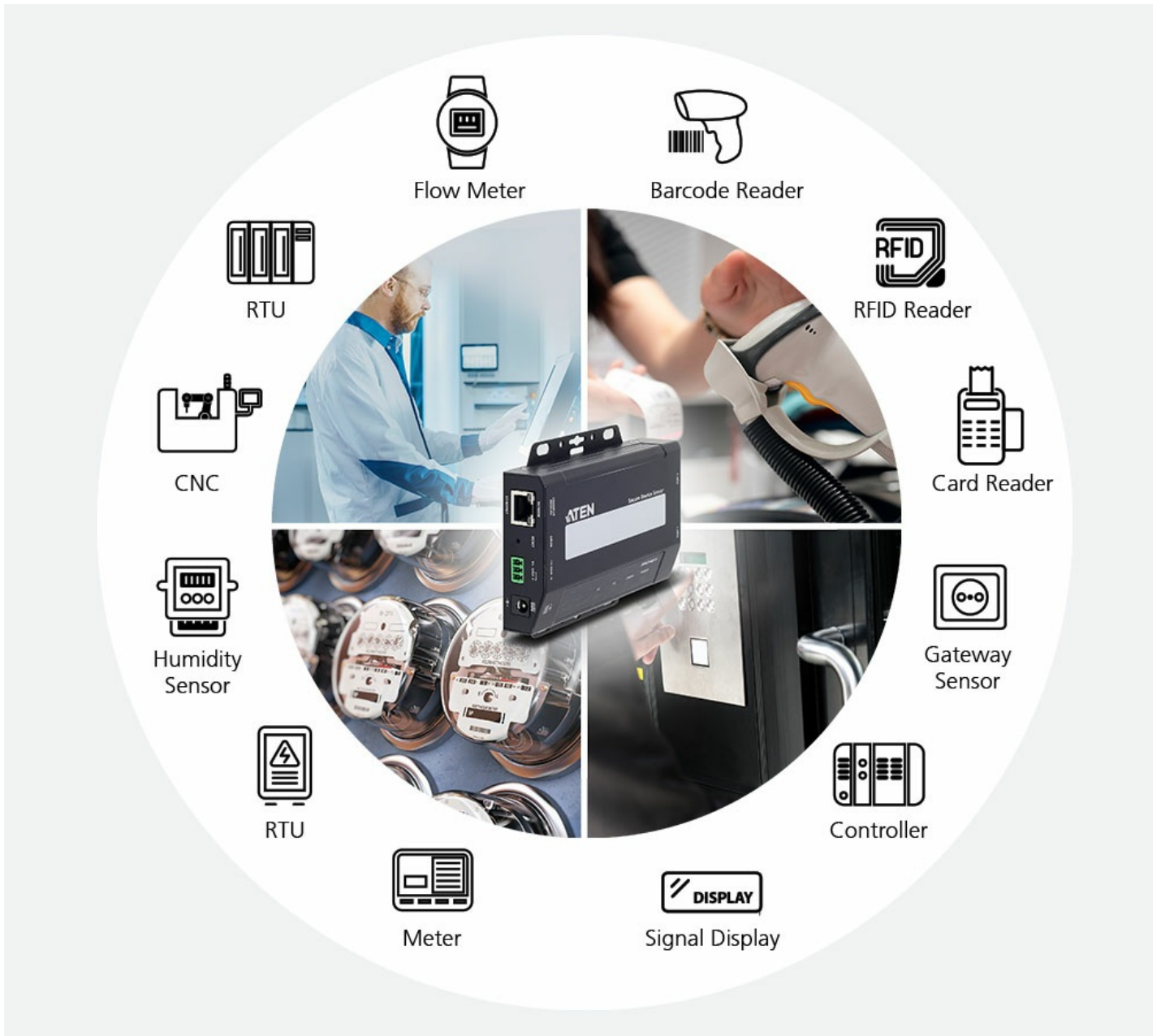

Versatile Mounting Options

The SN3402 can be flexibly mounted in various installation environments, so you can easily configure them to your workplace. Mounting options include wall, desktop, DIN rail mounting, or rack mounting (with optional kit [VE-RMK1U](#)) as required.



Product Comparison

Talk to Our Experts

If you prefer to have ATEN contact you, please complete the form and a representative will be in touch with you shortly



Features

The SN3402 Secure Device Server is external IP-based network device that securely connects legacy RS-232/422/485 serial devices to an Ethernet network to be accessed remotely from a computer located anywhere, allowing users to expand the number of serial ports for any host computer over a network.

The SN3402 is especially suited for industrial process control applications, given the abundant use of the Supervisory Control and Data Acquisition (SCADA) systems across many industries for collecting data from PLCs, meters, and sensors via serial ports. The SN3402 bi-directionally translates data between serial and Ethernet formats, and facilitates access to the data from all data collection instruments from local and remote sites through an Ethernet network.

The SN3402 has a number of useful operation modes. It supports secure TCP server / client, secure serial tunneling server / client, secure Real COM, and console management modes for security-critical applications, such as telecom, access control, and remote site management.

The SN3402 can be used as standard Modbus gateway to convert between Modbus TCP and Modbus RTU / ASCII protocols. It can integrate Modbus serial slave devices seamlessly into an existing Modbus TCP network and thereby make them accessible to serial master devices.

• **Serial-to-Ethernet Connectivity**

- 2 RS-232/422/485 serial ports for secured serial data over Ethernet transmission
- Software-configurable termination (120 Ω) and pull high/low resistor (1K ohms or 150K ohms) integrated to the RS-485 mode to avoid signal reflection
- Secured operation modes – Secure Real COM, Secure TCP Server / Client, Secure Serial Tunneling Server / Client, Console Management (SSH), and Console Management Direct (SSH)
- Standard operation modes – Real COM, TCP Server / Client, Serial Tunneling Server / Client, UDP, Console Management (Telnet), and Console Management Direct (Telnet)
- Real COM, Real TTY, and Fixed TTY drivers for Windows, Linux, and UNIX
- Convenient console management access via Java viewer (SSH / Telnet) or third-party clients such as PuTTY
- Easy console port access via Java viewer and Sun Solaris ready ("break-safe")
- Multiple users can simultaneously access the same port – up to 16 connections per port
- Support Modbus gateway to convert between Modbus TCP and Modbus RTU / ASCII protocols

• **Hardware**

- Redundant power input (power jack and terminal block) for fail-safe power
- Surge protection for serial, Ethernet, and power
- DIN-rail mounting, wall mounting, rack mounting, and desktop installation available
- Supports baud rates of 110, 134, 150, 300, 600, 1200, 1800, 2400, 4800, 7200, 9600, 19200, 38400, 57600, 115200, 230.4k, 460.8k, 921.6k bps

• **Security**

- Supports secured login from browsers with TLS 1.2 data encryption and RSA 2048-bit certificates
- Configurable user permissions for port access and control
- Local and remote authentication and login
- Third-party authentication (e.g. RADIUS)
- IP address filter for security protection

• **System Management**

- Browser access with an intuitive GUI design
- Web-based quick setup wizard for fast configuration
- Terminal-based access with a menu-driven UI via Telnet / SSH
- Online / Offline detection of connected serial devices (including terminal blocks) – automatically sending event notifications when the devices are offline (e.g. power failure) for device status monitoring
- System event logs and port logs will be saved to an internal memory or Syslog server
- SNMP agent (v1 / v2c)
- Event notification – supports notification of SMTP email and SNMP Trap (v1 / v2c)
- Backup / Restore system configuration and upgradeable firmware
- 64 KB port buffer prevents data loss when the network is down
- NTP for time server synchronization
- Multi-language web-based GUI

Specifications

Connectors	
Serial	2 x DB-9 Male
Network	1 x RJ-45 Female
Power	1 x DC Jack 1 x 3-pole Terminal Block
Switches	
Reset	1 x Semi-recessed Pushbutton
LEDs	
Power	1 (Green)

Status	1 (Yellow Green/Red)
10/100 Mbps	2 (Green/Orange)
Ports	2 (Green/Orange)
Input voltage	DC Jack: 9VDC (Power Adapter: 9VDC , 100-240VAC 50~60 Hz) Terminal Block: 9-48 VDC
Power Consumption	DC9V:1.19W:6BTU DC48V:1.30W:6BTU
Interfaces	
Serial	RS-232: TxD, RxD, RTS, CTS, DTR, DSR, DCD, GND RS-422: Tx+, Tx-, Rx+, Rx-, GND RS-485-4w: Tx+, Tx-, Rx+, Rx-, GND RS-485-2w: Data+, Data-, GND Pull High/Low Resistor for RS-485: 1 kilo-ohm, 150 kilo-ohms Baud Rate: 110, 134, 150, 300, 600, 1200, 1800, 2400, 4800, 7200, 9600, 19200, 38400, 57600, 115200, 230400, 460800, 921600 bps Data Bits: 5, 6, 7, 8 Parity: None, Even, Odd, Space, Mark Stop Bits: 1, 1.5, 2 Flow Control: RTS/CTS, DTR/DSR, XON/XOFF
Network	10/100 Base TX Built-in 1.5 kV Magnetic Isolation Protection
Industrial Protocols	Ethernet: Modbus TCP Client (Master), Modbus TCP Server (Slave) Serial: Modbus RTU/ASCII Master, Modbus RTU/ASCII Slave Max. 16 connections under Modbus Master mode and 32 connections under Modbus Slave mode.
Compliance	EMC: EN 55032/35 EMI: CISPR 32, FCC Part 15B Class A EMS: IEC 61000-4-2 ESD: Contact: 4 kV; Air: 8 kV IEC 61000-4-3 RS: 80 MHz to 1 GHz: 3 V/m IEC 61000-4-4 EFT: Power: 1 kV; Signal: 0.5 kV IEC 61000-4-5 Surge: Power: 2 kV (Power Adapter), 1kV (Terminal Block); Signal: 1 kV IEC 61000-4-6 CS: 150 kHz to 10 MHz: 3 V/m; 10 kHz to 30 MHz: 3 to 1 V/m; 30 kHz to 80 MHz: 1 V/m IEC 61000-4-8 PFMF IEC 61000-4-11 DIPs Safety: UL 60950-1 and UL 62368-1 standards compliant RoHS
Environmental	
Operating Temperature	0 - 60°C
Storage Temperature	-40 - 75°C
Humidity	5 ~ 95% RH, Non-condensing
Physical Properties	
Housing	Metal
Weight	0.21 kg (0.46 lb)
Dimensions (L x W x H)	9.80 x 11.70 x 2.60 cm (3.86 x 4.61 x 1.02 in.)
Installation	Desktop, Wall Mounting, Din-Rail Mounting, Rack Mounting (with VE-RMK1U)
Others	Rack mounting kit (VE-RMK1U) is sold separately.
Note	For some of rack mount products, please note that the standard physical dimensions of WxDxH are expressed using a LxWxH format.

Diagram

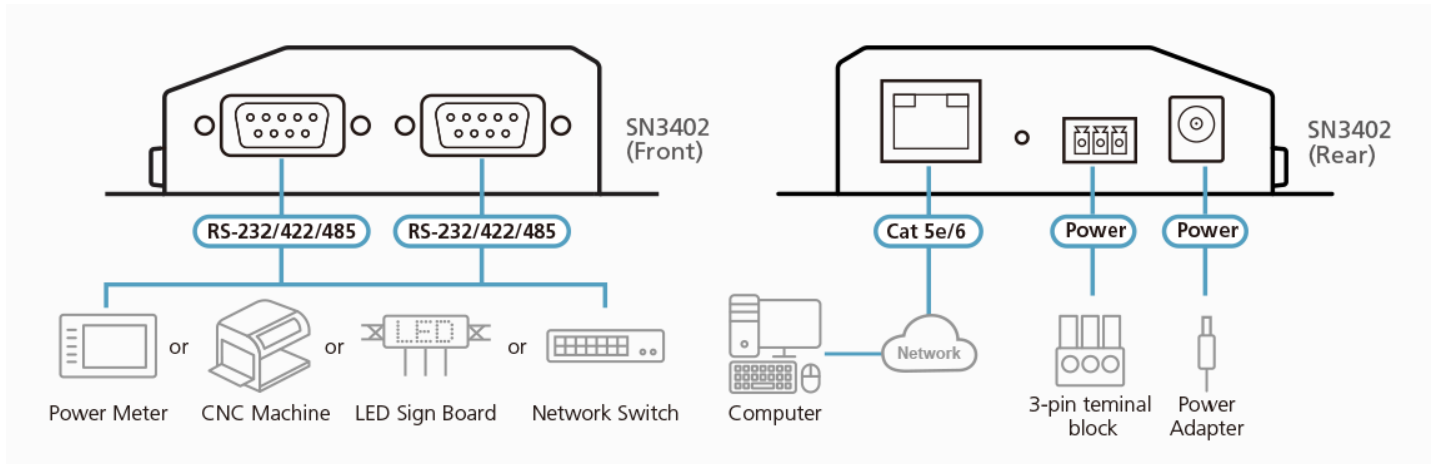

ATEN International Co., Ltd.

3F, No.125, Sec. 2, Datong Rd., Sijhih District., New Taipei City 221, Taiwan
 Phone: 886-2-8692-6789 Fax: 886-2-8692-6767
 www.aten.com E-mail: marketing@aten.com



© Copyright 2015 ATEN® International Co., Ltd.
 ATEN and the ATEN logo are trademarks of ATEN International Co., Ltd.
 All rights reserved. All other trademarks are the property of their respective owners.