

Veritas™ 5260 Appliance Product Description Guide

VERITAS™

Veritas 5260 Appliance Product Description Guide

Last updated: 2024-05-20

Legal Notice

Copyright © 2024 Veritas Technologies LLC. All rights reserved.

Veritas, the Veritas Logo, and NetBackup are trademarks or registered trademarks of Veritas Technologies LLC or its affiliates in the U.S. and other countries. Other names may be trademarks of their respective owners.

This product may contain third-party software for which Veritas is required to provide attribution to the third party ("Third-party Programs"). Some of the Third-party Programs are available under open source or free software licenses. The License Agreement accompanying the Software does not alter any rights or obligations you may have under those open source or free software licenses. Refer to the Third-party Legal Notices document accompanying this Veritas product or available at:

<https://www.veritas.com/about/legal/license-agreements>

The product described in this document is distributed under licenses restricting its use, copying, distribution, and decompilation/reverse engineering. No part of this document may be reproduced in any form by any means without prior written authorization of Veritas Technologies LLC and its licensors, if any.

THE DOCUMENTATION IS PROVIDED "AS IS" AND ALL EXPRESS OR IMPLIED CONDITIONS, REPRESENTATIONS AND WARRANTIES, INCLUDING ANY IMPLIED WARRANTY OF MERCHANTABILITY, FITNESS FOR A PARTICULAR PURPOSE OR NON-INFRINGEMENT, ARE DISCLAIMED, EXCEPT TO THE EXTENT THAT SUCH DISCLAIMERS ARE HELD TO BE LEGALLY INVALID. VERITAS TECHNOLOGIES LLC SHALL NOT BE LIABLE FOR INCIDENTAL OR CONSEQUENTIAL DAMAGES IN CONNECTION WITH THE FURNISHING, PERFORMANCE, OR USE OF THIS DOCUMENTATION. THE INFORMATION CONTAINED IN THIS DOCUMENTATION IS SUBJECT TO CHANGE WITHOUT NOTICE.

The Licensed Software and Documentation are deemed to be commercial computer software as defined in FAR 12.212 and subject to restricted rights as defined in FAR Section 52.227-19 "Commercial Computer Software - Restricted Rights" and DFARS 227.7202, et seq. "Commercial Computer Software and Commercial Computer Software Documentation," as applicable, and any successor regulations, whether delivered by Veritas as on premises or hosted services. Any use, modification, reproduction release, performance, display or disclosure of the Licensed Software and Documentation by the U.S. Government shall be solely in accordance with the terms of this Agreement.

Veritas Technologies LLC
2625 Augustine Drive
Santa Clara, CA 95054

<https://www.veritas.com>

Technical Support

Technical Support maintains support centers globally. All support services will be delivered in accordance with your support agreement and the then-current enterprise technical support policies. For information about our support offerings and how to contact Technical Support, visit our website:

<https://www.veritas.com/support>

You can manage your Veritas account information at the following URL:

<https://my.veritas.com>

If you have questions regarding an existing support agreement, please email the support agreement administration team for your region as follows:

Worldwide (except Japan)

CustomerCare@veritas.com

Japan

CustomerCare_Japan@veritas.com

Documentation

Make sure that you have the current version of the documentation. Each document displays the date of the last update on page 2. The latest documentation is available on the Veritas website:

https://www.veritas.com/content/support/en_US/dpp.Appliances.html

Documentation feedback

Your feedback is important to us. Suggest improvements or report errors or omissions to the documentation. Include the document title, document version, chapter title, and section title of the text on which you are reporting. Send feedback to:

APPL.docs@veritas.com

You can also see documentation information or ask a question on the Veritas community site:

<https://www.veritas.com/community/>

Veritas Services and Operations Readiness Tools (SORT)

Veritas Services and Operations Readiness Tools (SORT) is a website that provides information and tools to automate and simplify certain time-consuming administrative tasks. Depending on the product, SORT helps you prepare for installations and upgrades, identify risks in your datacenters, and improve operational efficiency. To see what services and tools SORT provides for your product, see the data sheet:

https://sort.veritas.com/data/support/SORT_Data_Sheet.pdf

Contents

Chapter 1	About the Veritas 5260 Appliance	6
	Veritas 5260 Appliance overview	6
	Features and components of the Veritas 5260 Appliance	8
	Locating the appliance serial number	10
	Veritas 5260 Appliance front panel drive configurations	11
	About the drive LEDs	12
	About the Veritas 5260 Appliance front panel USB port	13
	About the 5260 Appliance control panel	13
	About the System Status LED states	16
	About the Power button LED states	19
	About the 5260 Appliance rear panel	20
	Veritas 5260 Appliance I/O configuration options	22
	Veritas 5260 Appliance total I/O on-board and PCIe ports	25
	Customizable I/O configurations by slot for existing Veritas 5260 Appliance	25
	Broadcom P225p 10/25Gb PCIe Ethernet card	26
	QLE2772 dual-port 32 Gb Fibre Channel host bus adapter	27
	Intel RAID Adapter RS3P4MF088F	29
Chapter 2	Veritas 2U12 65.5TiB/72TB Storage Shelf	31
	Storage Shelf overview	31
	Usable appliance storage capacities	32
	Components of the Storage Shelf	33
	Storage Shelf front panel components	33
	Storage Shelf control panel	35
	Storage Shelf rear components	38
	Storage Shelf I/O modules	39
	I/O module Status LED location and conditions	41
	I/O module SAS Activity LED location and conditions	41
	Storage Shelf Power Cooling Modules	42
	Power Cooling Module LEDs	44

Chapter 3	Veritas 5260 Appliance and Veritas 2U12 65.5TiB/72TB Storage Shelf cables	46
	Power cables	46
	Network cable	47
	Multi-Mode fiber optic cable	48
	Twinaxial copper cables	49
	SAS-3 cable	50
Appendix A	Technical specifications, Environmental/Protocol standards, and Compliance standards	52
	Veritas 5260 Appliance technical specifications	52
	Veritas 2U12 65.5TiB/72TB Storage Shelf technical specifications	55
	Environmental specifications	57
	Protocol standards	58
	Regulatory, compliance, and certification information	58
	Product regulatory compliance	59
	Country approvals	59
	Product safety compliance	60
	Product EMC Compliance - Class A Compliance	60
	Product environmental compliance	61
Index	62

About the Veritas 5260 Appliance

This chapter includes the following topics:

- [Veritas 5260 Appliance overview](#)
- [Features and components of the Veritas 5260 Appliance](#)
- [Locating the appliance serial number](#)
- [Veritas 5260 Appliance front panel drive configurations](#)
- [About the Veritas 5260 Appliance front panel USB port](#)
- [About the 5260 Appliance control panel](#)
- [About the 5260 Appliance rear panel](#)
- [Veritas 5260 Appliance I/O configuration options](#)

Veritas 5260 Appliance overview

The Veritas 5260 Appliance is a hardware and software storage system that can scale to 429.4 TiB of available backup capacity. It consists of a Veritas 5260 Appliance and up to six optional Veritas 2U12 65.5TiB/72TB storage shelves. By itself, the 2U Veritas 5260 Appliance offers internal storage from 9.1 TiB to 36.4 TiB, depending on the appliance configuration purchased.

Figure 1-1 Veritas 5260 Appliance

A Veritas 2U12 storage shelf offers 65.5 TiB of storage. Attaching six storage shelves offers 429.4 TiB of storage. As with previous generations of the Flex 52xx appliances, the Veritas 5260 Appliance can be configured as a primary server or a media server. It can also be configured as both. The 5260 Appliance supports up to 6 storage shelves.

See [“Usable appliance storage capacities”](#) on page 32.

SAS-3 cables connect the Veritas 5260 Appliance to the storage shelves. SAS-3 cables also connect the storage shelves to each other.

The Veritas 5260 Appliance supports the following software:

- Flex Appliance 3.2 and above

About Veritas 5260 Appliance configurations

To determine the right Veritas 5260 Appliance system for your environment, you should consider the environment’s future storage requirements over the lifetime of the system.

Veritas offers multiple I/O configurations from which to choose. You can use the supported Veritas 5260 Appliance I/O configurations to best serve the needs of your particular environment.

These configurations include the following:

- One Veritas 5260 Appliance with 9.1 TiB of internal storage only
- One Veritas 5260 Appliance with 36.4 TiB of internal storage only
- One Veritas 5260 Appliance with up to six external 65.5TiB/72TB storage shelves for a total of 429.4 TiB of storage

If your environment requires more than 36TiBs of storage, consider the Veritas 5260 Appliance with 9.1TiBs of internal storage and one 65.5TiB/72TB Veritas 2U12 65.5TiB/72TB Storage Shelf. If more storage is required, you can add up to five additional storage shelves to this configuration.

Features and components of the Veritas 5260 Appliance

This section describes the features and components of the Veritas 5260 Appliance.

Table 1-1 Veritas 5260 Appliance features

Feature	Description
Processor	Intel Xeon Scalable Third generation Silver 4314
Appliance software version	Flex Appliance 3.2 or higher
Performance and capacity	<ul style="list-style-type: none"> ■ Supports high-performance processors with low-power consumption. ■ Provides high-capacity intra-appliance switching bandwidth, along with high I/O throughput. ■ Available internal storage capacities of 9 TB, or 36 TB without optional external storage shelves. The available capacity can be allocated either in part or in whole to a deduplication pool or to an AdvancedDisk pool (non-deduplicated storage).
System memory configuration (DIMMS)	64GB, up to a maximum of 512GB Note: When you purchase the first expansion storage shelf, the Storage Expansion kit that comes with the storage shelf includes a replacement of 256GB memory. A Memory Expansion kit containing eight 32GB DIMM memory chip is needed to support the fifth storage shelf.
Space reduction	The deduplication engine provides up to 100 times reduction in storage. The client-side plug-in provides similar levels of bandwidth reduction.
Scalable architecture	Due to fingerprinting and RAID redundancy, the overall storage capabilities are not a simple multiplication of the disk size and the total number of disks.
High availability	Supports redundant hot-swappable disks and power modules.

Table 1-1 Veritas 5260 Appliance features (*continued*)

Feature	Description	
RAID levels	<p>RAID 1 (standard mirroring) and RAID 6 (block level striping with double distributed parity) are implemented as follows:</p> <ul style="list-style-type: none"> ■ Appliance system disks: RAID 1 ■ Appliance storage disks: RAID 6 ■ Storage shelf data storage disks: RAID 6 <p>Note: The disk drives in the appliance are pre-formatted before the appliance is shipped. These drives should not be moved into different slots or otherwise rearranged.</p>	
Fibre Channel support	<p>The Veritas 5260 Appliance can be ordered with one, two, three or four PCIe 32 Gb Fibre Channel host bus adapter cards preinstalled.</p> <p>See “Veritas 5260 Appliance I/O configuration options” on page 22.</p> <p>See “Customizable I/O configurations by slot for existing Veritas 5260 Appliance” on page 25.</p>	
PCIe 10/25 Gb Ethernet cards	Yes (with Fibre Optic ports)	
I/O Ports See “Veritas 5260 Appliance total I/O on-board and PCIe ports” on page 25.	12 Gb SAS-3 ports (PCIe-based) (RAID controller)	2 Used to connect the Veritas Appliance compute node to the 2U12 Primary Storage Shelf
	10/25 GbE Ethernet/iSCSI-capable ports (PCIe-based)	Up to six, depending on the appliance I/O configuration
	32 Gb Fibre Channel ports (PCIe-based)	Up to eight, depending on the appliance I/O configuration
	10 Gb Ethernet ports (on-board)	4
Additional storage	<p>Yes</p> <p>You can attach up to six optional storage shelves to the Veritas 5260 Appliance. Depending on the appliance configuration you purchase, a total of 429.4 TB of usable storage capacity is available.</p> <p>See “Usable appliance storage capacities” on page 32.</p>	

Locating the appliance serial number

The serial number is located on the rear panel of the appliance above PSU 1 and begins with letters VTAS.

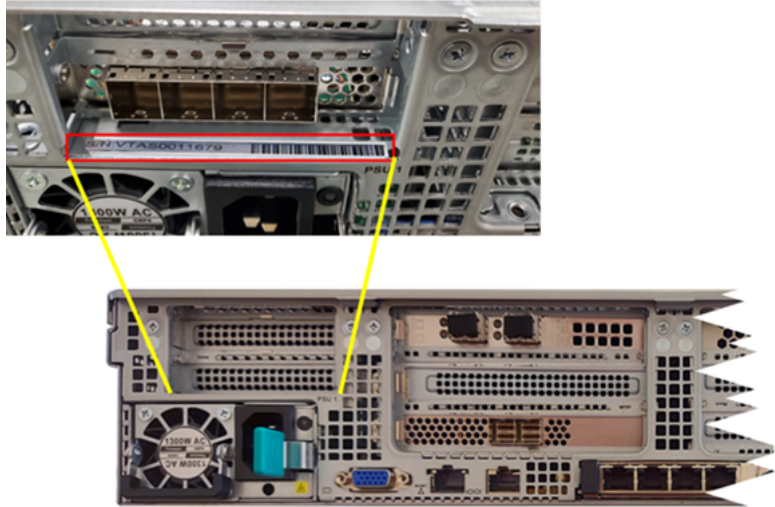

The serial number can also be found on the pull-out tab on the front of the appliance.

5260 Appliance



Veritas 5260 Appliance front panel drive configurations

The Veritas 5260 Appliance contains 3 NVMe solid state drives, and 8 SAS hard disk drives, which can be accessed from the appliance's front panel.

Figure 1-2 Appliance front panel drive slot assignments



The drives that are located in slot 4 and slot 5 are configured as the RAID1, VOLUME0 device. These drives contain the appliance operating system and the Flex application along with the log files. You can hot-swap one of these drives at a time; however, you cannot operate the appliance if both drives are removed.

The drive in slot 6 acts as a hot spare for OS and log files.

The drives in slots 0-3 and slots 8-10 store user data. They are configured as a RAID 6 array, which uses block-level striping with two parity blocks across each of the drives in the volume.

The appliance uses the drive that is located in slot 11 as a hot-spare drive. If one of the drives fails in slots 0-3 or slots 8-10, the appliance automatically initiates a RAID 6 rebuild operation. It rebuilds the RAID 6 array by using the hot-spare drive in slot 11. After you replace the failed drive, the appliance then copies the information from the drive in slot 11 to the new replacement drive. When the copy operation finishes, the drive in slot 11 again becomes the hot-spare drive.

Note: The hot-spare drive size depends on the data drive size.

Warning: The drives are pre-formatted before the appliance is shipped. Do not rearrange the drives from their original locations.

Table 1-2 Veritas 5260 Appliance front panel drive configurations

Slot	RAID Configuration	Drive size	Drive role
0-3 8-10	RAID 6	2TB (Available internal storage is 9.1TiB) 8TB (Available internal storage is 36.4TiB)	User data
4,5	RAID 1	1.92 TB	OS/log files
6	RAID 1	1.92 TB	Hot spare for OS and log drives
11	RAID 6	2TB 8TB	Hot spare for user storage data

About the drive LEDs

Figure 1-3 Appliance drive LEDs



Table 1-3 Drive Status LED descriptions

Description	LED behavior	Condition
Amber Status LED	Off	No drive access and no disk drive faults
	Solid amber	A drive fault has occurred
	Blinking amber	A RAID rebuild is in progress (1Hz blink) Locating / identifying the drive (2Hz blink)

Table 1-4 Drive Activity LED States

Description	LED behavior	Condition
Green Activity LED	Off	Power on - the drive has spun down
	Solid green	Power on - no drive activity
	Blinking green	Power on - I/O is being processed by the drive or Power on - the drive is spinning up

About the Veritas 5260 Appliance front panel USB port

The Veritas 5260 Appliance front panel includes a USB 3.0-compliant port that supports a data transfer rate of up to 500 Mb/second.



About the 5260 Appliance control panel

The front control panel provides push button system controls and LED indicators for several system features.

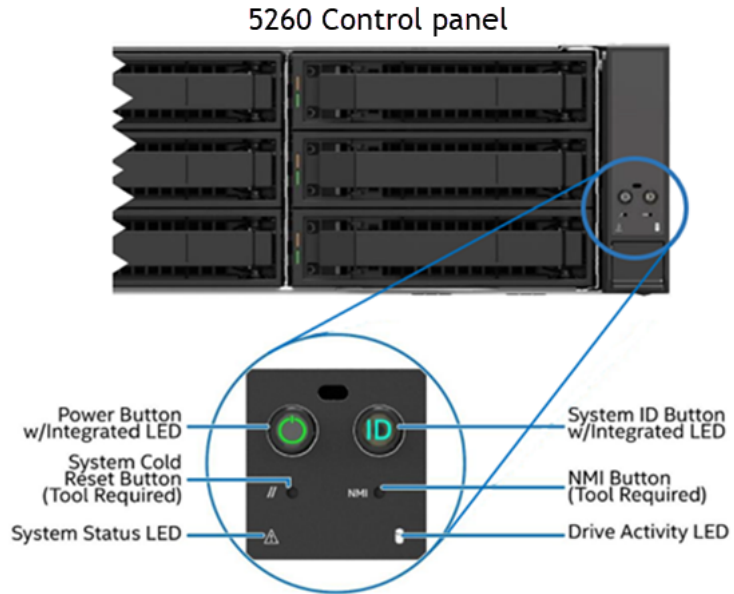

Table 1-5 Control panel system LED descriptions

LED	System information
Power button with integrated LED	<p>The Power button toggles the system on and off. This button also functions as a sleep button if enabled by an ACPI compliant operating system. Pressing this button sends a signal to the integrated BMC that either powers on or powers off the system. Holding the power button for 10 seconds or more leads to a hard shutdown.</p> <p>The integrated LED is a single color (green) and supports different indicator states as defined in the following table. See “About the Power button LED states” on page 19.</p>
Drive Activity LED	<p>The drive activity LED on the front panel indicates drive activity from the server board SATA and SATA storage controllers. The server board also has an I2C header labeled “SAS_MODULE_MISC” to provide access to this LED for add-in SATA or SATA storage controllers.</p>

Table 1-5 Control panel system LED descriptions (*continued*)

LED	System information
System ID button with integrated LED	<p>Toggles the integrated ID LED and the blue server board system ID LED on and off. Both LEDs are tied together and show the same state. The onboard system ID LED is on the back edge of the server board, viewable from the back of the system. The system ID LEDs are used to identify the system for maintenance when installed in a rack of similar server systems. Two options available for illuminating the system ID LEDs are:</p> <ul style="list-style-type: none"> ■ The front panel system ID LED button is pushed, which causes the LEDs to illuminate to a solid On state until the button is pushed again. ■ An IPMI <code>Chassis Identify</code> command is remotely entered that causes the LEDs to blink for 15 seconds.
NMI button (recessed, tool required for use)	<p>When the NMI button is pressed, it puts the system in a halt state and issues a non-maskable interrupt (NMI). This situation can be useful when performing diagnostics for a given issue where a memory download is necessary to help determine the cause of the problem. To prevent an inadvertent system halt, the actual NMI button is behind the front control panel faceplate where it is only accessible with the use of a small tipped tool like a pin or paper clip.</p>
System Cold Reset Button	<p>When pressed, this button reboots and re-initializes the system. Unlike the power button, the reset button does not disconnect the power to the system. It just starts the system's Power-On Self-Test (POST) sequence over again.</p>

Table 1-5 Control panel system LED descriptions (*continued*)

LED	System information
System Status LED	<p>The system status LED is a bi-color (green/amber) indicator that shows the current health of the server system.</p> <p>The system provides two locations for this feature; one is on the front control panel and the other is on the back edge of the server board, viewable from the back of the system. Both LEDs are tied together and show the same state. The system status LED states are driven by the server board platform management subsystem. When the server is powered down (transitions to the DC-Off state or S5), the BMC is still on standby power and retains the sensor and front panel status LED state established before the power-down event.</p> <p>Two locations are provided for you to monitor the health of the system. You can find the first location on the front control panel, while the second location is located on the back edge of the server board. It is viewable from the rear of the appliance. Both LEDs show the same state of health.</p> <p>See “About the System Status LED states” on page 16.</p>

About the System Status LED states

The following table provides a description of each LED state.

Table 1-6 System Status LED states

Color	State	Criticality	Description
No color	Off - The system is not operating.	Not ready	<ul style="list-style-type: none"> ■ System power is off (AC and/or DC) ■ System is in EuP Lot6 Off Mode

Table 1-6 System Status LED states (*continued*)

Color	State	Criticality	Description
Green	Solid on (SO)	Healthy	<ul style="list-style-type: none"> ■ System is in S5 Soft-Off State ■ Indicates that the system is running (in S0 State) and its status is “Healthy”. The system is not exhibiting any errors. AC power is present and BMC has booted and manageability functionality is up and running. ■ After a BMC reset, and with the chassis ID solid on, the BMC is booting Linux*. Control has been passed from BMC uBoot to BMC Linux*. The BMC is in this state for roughly 10–20 seconds.
Green	~1 Hz blink	<p>Degraded</p> <p>The system is operating in a degraded state although still functional.</p> <p>or</p> <p>The system is operating in a redundant state but with an impending failure warning.</p>	<p>System degraded:</p> <ul style="list-style-type: none"> ■ Redundant loss, such as power supply or fan. Applies only if the associated platform sub-system has redundancy capabilities. ■ Fan warning or failure when the number of fully operational fans is more than minimum number needed to cool the system. ■ Non-critical threshold crossed: Temperature (including HSBP temp), voltage, input power to power supply, output current for main power rail from power supply and Processor Thermal Control (Therm Ctrl) sensors. ■ Power supply predictive failure occurred while redundant power supply configuration was present. ■ Unable to use all of the installed memory (one or more DIMMs failed/disabled but functional memory remains available). ■ Battery failure ■ BMC executing in uBoot. (Indicated by Chassis ID blinking at 3Hz). System in degraded state (no manageability). BMC uBoot is running but has not transferred control to the BMC Linux. Server will be in this state 6-8 seconds after BMC reset while it pulls the Linux image into flash.

Table 1-6 System Status LED states (*continued*)

Color	State	Criticality	Description
Green	~1 Hz blink	Degraded (continued)	System degraded (continued): <ul style="list-style-type: none"> ■ BMC Watchdog has reset the BMC. ■ Power unit sensor offset for configuration error is asserted. ■ SSD Hot Swap Controller is off-line or degraded.
Green and amber alternately	~1 Hz blink	System is initializing after source power is applied	<ul style="list-style-type: none"> ■ PFR in the process of updating/authenticating/recovering when source power is connected, system firmware being updated. ■ System not ready to take power button event/signal.
Amber	~1 Hz blink	Non-critical The system is operating in a degraded state with an impending failure warning. However, the system is still functioning.	Non-fatal, although the system is likely to fail due to the following issues: <ul style="list-style-type: none"> ■ Critical threshold crossed – Voltage, temperature (including HSBP temp), input power to power supply, output current for main power rail from power supply and PROCHOT (Therm Ctrl) sensors. ■ VRD Hot asserted ■ Minimum number of fans to cool the system not present or failed ■ Hard drive fault ■ Power Unit Redundancy sensor – Insufficient resources offset (indicates not enough power supplies present) ■ In non-sparing and non-mirroring mode, if the threshold of correctable errors is crossed within the window. ■ Invalid firmware image detected during boot up or firmware update.

Table 1-6 System Status LED states (*continued*)

Color	State	Criticality	Description
Amber	Solid on	Critical, non-recoverable – System is halted	<p>Fatal alarm – system has failed or shutdown:</p> <ul style="list-style-type: none"> ■ CPU CATERR signal asserted ■ MSID mismatch detected (CATERR also asserts for this case) ■ CPU0 is missing ■ CPU Thermal Trip ■ No power – power fault ■ DIMM failure when there is only one DIMM present; no other good DIMM memory present ■ Runtime memory uncorrectable error in non-redundant mode. ■ DIMM Thermal Trip or equivalent ■ BMC/Video memory test failed (Chassis ID shows blue/solid-on for this condition) ■ SBB Thermal Trip or equivalent ■ 240VA fault ■ Both uBoot BMC FW images are bad (Chassis ID shows blue/solid-on for this condition) ■ Fatal Error in processor initialization: <ul style="list-style-type: none"> ■ Processor family not identical ■ Processor model not identical ■ Processor core/thread counts not identical ■ Processor cache size not identical ■ Unable to synchronize processor frequency ■ Unable to synchronize QPI link frequency ■ BMC fail authentication with non-recoverable condition, system hang at T-1; boot PCH only, system hang; PIT failed, system lockdown.

About the Power button LED states

The following table provides a description of each power state.

Table 1-7 Power button LED states

State	Power Mode	LED	Description
Power - off	Non-ACPI	Off	The system power is off, and the BIOS has not initialized the chipset.
Power - on	Non-ACPI	On	The system power is on and the green Power button LED is active.
S0	ACPI (Advanced Configuration and Power Interface)	Steady on	The system and the operating system are up and running.
S5	ACPI (Advanced Configuration and Power Interface)	Off	Mechanical is off and the operating system has not saved any context to the hard disk drive.

About the 5260 Appliance rear panel

The rear panel of the appliance has several access ports and other features, which are displayed in the following figures.

Figure 1-4 Veritas 5260 Appliance rear panel and connectors

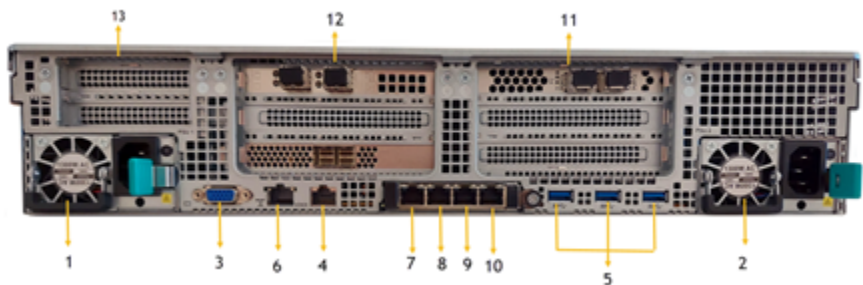

Table 1-8 Veritas 5260 Appliance rear panel features and connectors

Number	Function
1,2	Power Supply 1 and Power Supply 2 - Dual, redundant, and hot-swappable power supply modules
3	DB-15 VGA monitor connector

Table 1-8 Veritas 5260 Appliance rear panel features and connectors
(continued)

Number	Function
4	Serial port - Serial connection for Veritas Technical Support use only
5	Three USB 3.0 ports for general use
6	IPMI port - An external RJ45 port used for appliance remote management purposes
7	Flex Appliance (host0): A 1-10 GbE port copper connector that you can connect to an administrative network to manage the appliance system. It is bonded during initial configuration as a standalone bond mgmt0.
8	Flex Appliance (NIC0): A 1-10 GbE port for general use.
9	Flex Appliance (NIC1): A 1-10 GbE port for general use.
10	Flex Appliance (NIC2): A 1-10 GbE port for general use.
11	PCIe riser assembly 1
12	PCIe riser assembly 2
13	PCIe riser assembly 3 Contains two half height PCIe slots. Note: PCIe riser assembly 2 and riser assembly 3 are riveted together. As a result, riser assembly 2 and riser assembly 3 are removed as one unit.

Note: You should not bond copper 1-10 Gb Ethernet ports that are installed in the appliance chassis with PCIe-based 10/25 Gb Ethernet Fibre Channel ports.

Veritas appliances may include grounding studs in case your lab environment has such a requirement. The studs are located on the rear panel of the appliance. You can use standard grounding practices to connect grounding wires to the studs.

The serial number is located on a vertical bar on the rear panel of the appliance.

The ports on the rear panel are color-coded for easy identification.

Figure 1-5 Veritas 5260 Appliance rear panel color codes

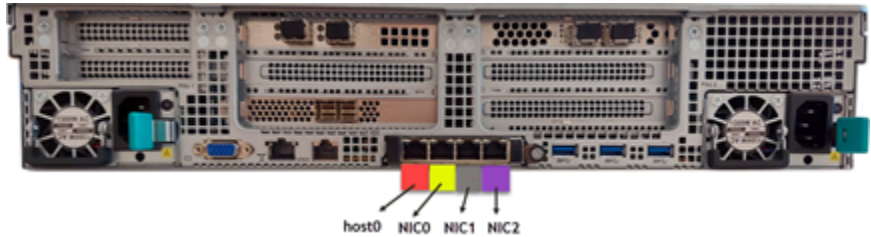

Veritas 5260 Appliance I/O configuration options

The rear panel of the Veritas 5260 Appliance contains three PCIe riser card assemblies. PCIe riser card assemblies 1 and 2 each support three standard PCIe cards, while PCIe riser card assembly 3 supports two low profile PCIe cards. The slots are labeled 1 to 8. Slots 1, 2, and 3 are located in PCIe riser card assembly 2. Slots 4, 5, and 6 are located in PCIe riser card assembly 1, while slots 7 and 8 are located in PCIe riser card assembly 3.

Figure 1-6 Rear panel riser assembly locations and PCIe slot number assignments

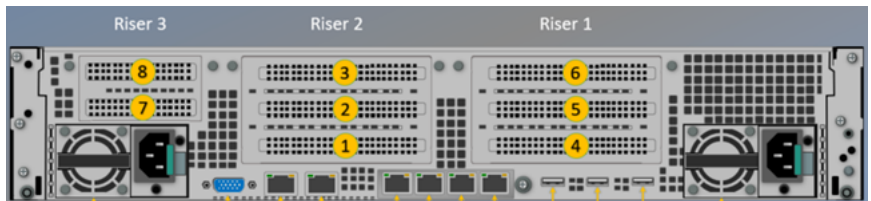

The Veritas 5260 Appliance supports multiple PCIe-based I/O configuration options. The following table shows the different I/O configuration options that are available.

Table 1-9 Available Veritas 5260 Appliance PCIe-based I/O configuration options

I/O configuration option	Slot 1 *	Slot 2	Slot 3	Slot 4	Slot 5	Slot 6	Slot 7	Slot 8
A	-	-	10/25 GbE NIC	-	-	32 Gb FC HBA	-	-

Table 1-9 Available Veritas 5260 Appliance PCIe-based I/O configuration options *(continued)*

I/O configuration option	Slot 1 *	Slot 2	Slot 3	Slot 4	Slot 5	Slot 6	Slot 7	Slot 8
B	-	10/25 GbE NIC	10/25 GbE NIC	10/25 GbE NIC	32 Gb FC HBA	32 Gb FC HBA	-	-
C	-	10/25 GbE NIC	10/25 GbE NIC	32 Gb FC HBA	32 Gb FC HBA	32 Gb FC HBA	-	-
D	-	32 Gb FC HBA	10/25 GbE NIC	32 Gb FC HBA	32 Gb FC HBA	32 Gb FC HBA	-	-

* Slot 1 contains a factory installed PCIe RAID controller

Figure 1-7 Flex 5260 Model A

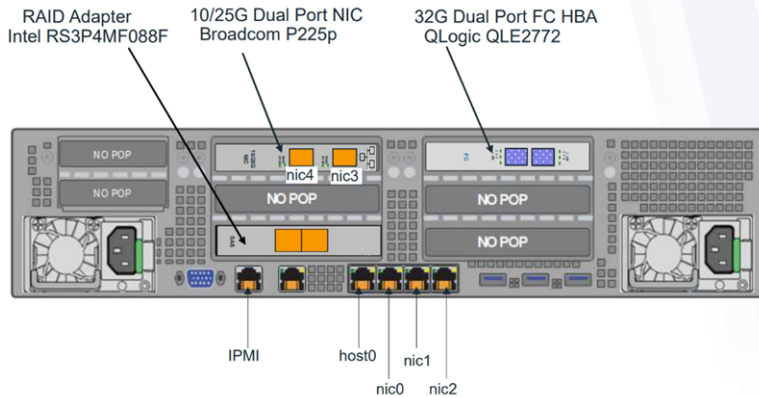

Figure 1-8 Flex 5260 Model B

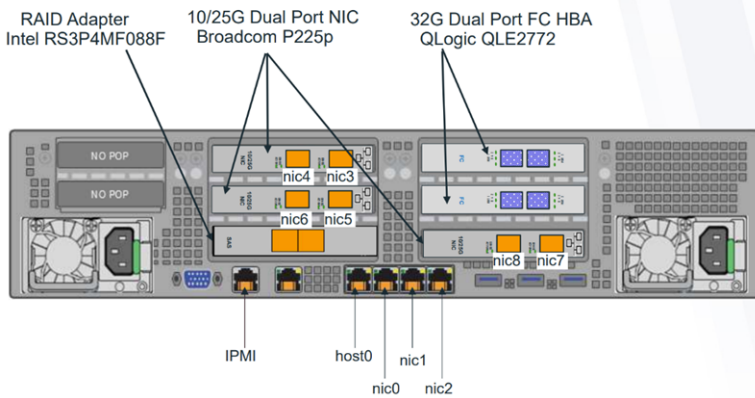

Figure 1-9 Flex 5260 Model C

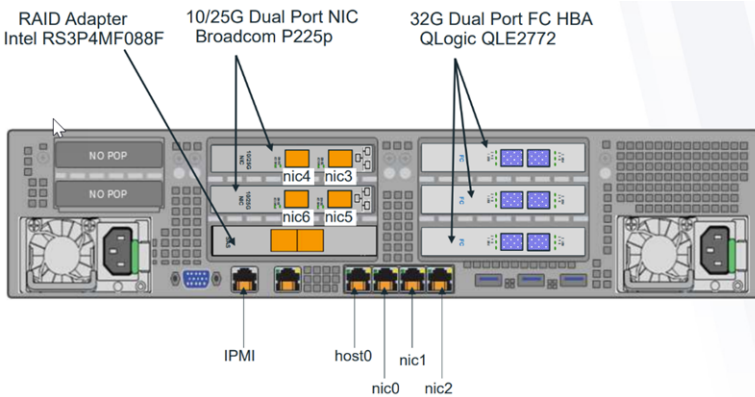
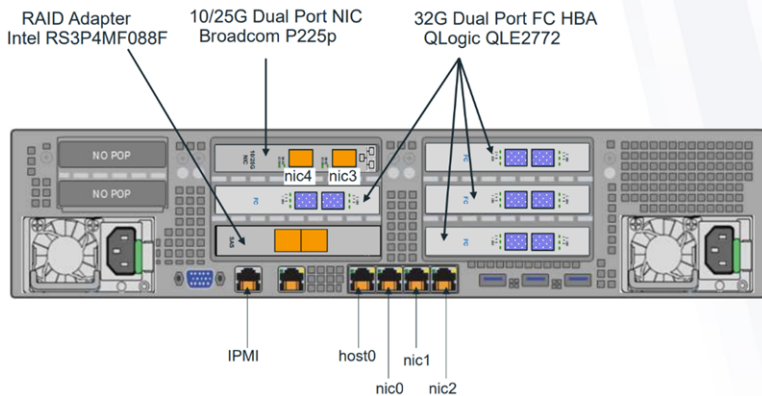

Figure 1-10 Flex 5260 Model D



Veritas 5260 Appliance total I/O on-board and PCIe ports

Table 1-10 Total number of Veritas 5260 Appliance on-board and PCIe I/O ports for each I/O configuration

I/O Configuration option	10 GbT Ethernet ports (copper)	10/25 Gb Ethernet PCIe ports (optical/SFP)	32 Gb Fibre Channel PCIe ports (optical/SFP)
A	4 on-board	2	2
B	4 on-board	6	4
C	4 on-board	4	6
D	4 on-board	2	8

Cable connection types:

copper = Standard copper cable

optical = Fiber optic cable

Customizable I/O configurations by slot for existing Veritas 5260 Appliance

You can use the supported Veritas 5260 Appliance I/O configurations to best serve the needs of your particular environment.

The controller is installed in both non-shelf and with-shelf configurations

The following table provides information on the make and model of each the PCIe cards that are available for use in each appliance I/O slot.

Table 1-11 Acceptable PCIe-based I/O cards for each appliance I/O slot

Slot	Acceptable PCIe I/O card	Comment
1	INTEL RS3P4MF088F 12Gb/s 8 port Internal / 8 port External PCI-Express 4.0 X 8 SAS RAID controller	External RAID controller to which you connect a Veritas 2U12 65.5TiB/72TB Storage Shelf
2	QLE2772 dual-port 32 Gb Fibre Channel host bus adapter Broadcom P225p Ethernet card	PCIe-based 32 Gb Fibre Channel host bus adapter PCIe-based 10/25 Gb network interface card
3	Broadcom P225p Ethernet card	PCIe-based 10/25 Gb network interface cards
4	QLE2772 dual-port 32 Gb Fibre Channel host bus adapter Broadcom P225p Ethernet card	PCIe-based 32 Gb Fibre Channel host bus adapter PCIe-based 10/25 Gb network interface cards
5	QLE2772 dual-port 32 Gb Fibre Channel host bus adapter	PCIe-based 32 Gb Fibre Channel host bus adapter
6	QLE2772 dual-port 32 Gb Fibre Channel host bus adapter	PCIe-based 32 Gb Fibre Channel host bus adapter

Broadcom P225p 10/25Gb PCIe Ethernet card

The Broadcom® BCM957414A4142CC is a dual-port 25 Gb/s, PCI-Express Gen3 x8 Network Interface Card that supports both SFP28/SFP+ optical modules and copper direct attach cable. The card uses the Broadcom BCM57414 25GbE MAC controller with the integrated dual channel 25GbE SFI transceiver.

By default, a 10 GB SFP is shipped with the appliance.



Note: Veritas recommends that you use Finisar FTLX8574D3BCV SFP part for 10G connectivity and Broadcom AFBR-735SMZ SFP part for 25G connectivity.

Table 1-12 Broadcom P225p NIC adapter specifications

Item	Specification
Bracket height	Full height
Power consumption	Typical: 12.5 watts Maximum: 12.9 watts
Operating temperature	0°C to 55°C (32 F to 131 F)
Storage temperature	-40°C to +70°C (-49°F to +221°F)
Storage humidity	90% at 35°C
System interface type	PCIe v3.0
Speed and slot width	8.0 GT/s (gigatransfers per second), 8-Lane
Data rate supported per port	10/25Gb
Air Flow (minimum)	150 LFM (linear feet per minute)

QLE2772 dual-port 32 Gb Fibre Channel host bus adapter

The QLE2772 dual-port 32 Gb Fibre Channel (FC) host bus adapter connects the appliance compute node to the storage area network.



Table 1-13 QLE2772 dual-port 32Gb Fibre Channel host bus adapter specifications

Item	Description
Bracket height	Full Height
Form factor	Low-profile PCIe card (6.6 inches × 2.731 inches)
Power consumption (watts)	Nominal: 11.0 W Maximum: 13.7 W
Operating temperature	0°C to 55°C (32°F to 131°F)
Storage temperature	-20°C to 70°C (-4°F to 158°F)
Operating humidity	10% to 90%
Storage humidity	5% to 95%

Table 1-13 QLE2772 dual-port 32Gb Fibre Channel host bus adapter specifications (*continued*)

Item	Description				
System interface type	PCIe v4.0				
Certifications	UL, CSA, TUV, CB, FCC, VCCI				
Maximum cable distances	Rate	Cable and Distance (m) (multimode optic cable)			
		OM2	OM3	OM4	OM5
	8 Gbps	50	150	190	190
	16 Gbps	35	100	125	125
	32 Gbps	20	70	100	100

Intel RAID Adapter RS3P4MF088F

The Intel RAID Adapter RS3P4MF088F is a tri-mode RAID Adapter with 12Gb SAS-3 MegaRAID 8 internal ports.

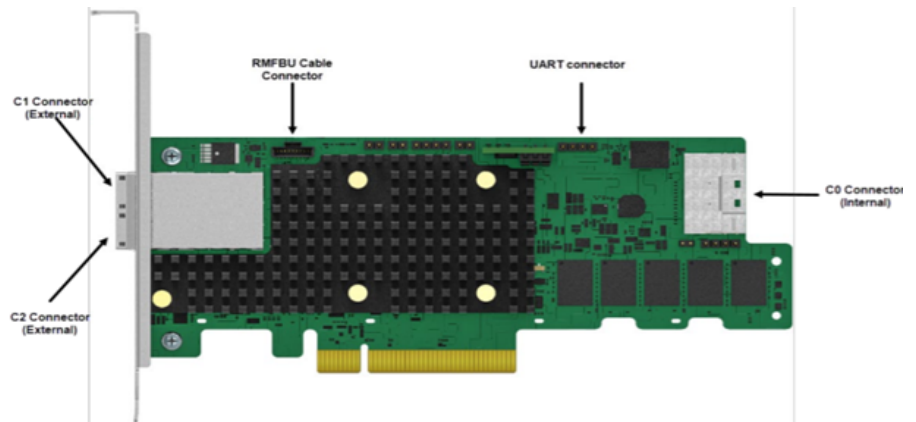

Table 1-14 RS3P4MF088F RAID adapter specifications

Item	Specification
Bracket height	Low profile mounting bracket
Power consumption	Typical: 16.70 watts Maximum: 17.71 watts
Operating temperature	0°C to 55°C (32 F to 131 F)
Storage temperature	-45°C to +105°C (-49°F to +221°F)
Storage humidity	20-80% RH (operating) 05-90% RH (non-operating)
System interface type	PCIe v4.0 (x8 PCI Express* 4.0 PCIe*)
Speed and slot width	16 GT/s (gigatransfers per second), per lane
Data rate supported per port	12, 6, 3 Gbps per port SAS 6, 3 Gbps per port SATA 16 Gbps per lane NVMe*
Air Flow (minimum)	200 LFM (linear feet per minute)

Veritas 2U12 65.5TiB/72TB Storage Shelf

This chapter includes the following topics:

- [Storage Shelf overview](#)
- [Usable appliance storage capacities](#)
- [Components of the Storage Shelf](#)

Storage Shelf overview

Figure 2-1 5260 Appliance Storage Shelves



The optional Veritas 2U12 65.5TiB/72TB Storage Shelf is a 2U12 drive enclosure that contains twelve 8TB 7200 rpm SAS hard disk drives. Available storage capacity of the storage shelf is 65 TiB. Each disk drive can be accessed from the storage shelf's front panel. The PCIe RAID controller is used to configure the disk drives

into a RAID 6 configuration. One of the disk drives is reserved as a global hot spare and can be used in case of any drive failure.

The Storage Shelf also contains two Storage Bay Bridge 2.1 compliant (SBB) Input/Output (I/O) modules. Each I/O module has three mini-SAS HD ports, which are labeled A, B, and C. As such, each storage shelf contains a total of six mini-SAS HD I/O ports. However, only ports A and B of each I/O module are used to connect the storage shelf to the appliance or other storage shelves.

Each I/O module also includes one Ethernet port and a 3.5mm RS232 Interface-to-Enclosure Services Processor jack. The Ethernet port and the RS232 jack are only used during on-site debugging operations. They are not used during normal appliance operations.

Along with the I/O modules and the disk drives, the Storage Shelf also includes a front control panel. The control panel provides LED indications of the health of the storage shelf. It uses a dual seven segment display for enclosure identification and a switch that is used for storage shelf configuration purposes.

The Storage Shelf serial number appears on a plastic panel on the left side of Power Cooling Module 0 (PCM 0). The storage shelf serial number begins with the letters SH.

See [“Storage Shelf front panel components”](#) on page 33.

See [“Storage Shelf rear components”](#) on page 38.

See [“Storage Shelf control panel”](#) on page 35.

Usable appliance storage capacities

Table 2-1 Usable storage capacities - Veritas 5260 Appliance and Veritas 2U12 65.5TiB/72TB Storage Shelves

Appliance only	Storage shelf capacity	Appliance and one storage shelf	Appliance and two storage shelves	Appliance and three storage shelves	Appliance and four storage shelves	Appliance and five storage shelves	Appliance and six storage shelves
10TB (9.1TiB)	72TB (65.5TiB)	82TB (74.6 TiB)	154TB (140.1 TiB)	226TB (205.6 TiB)	298TB (271.1TiB)	370TB (336.6TiB)	442TB (402.1TiB)
40TB* (36.4TiB)	72TB (65.5TiB)	112TB (101.9TiB)	184TB (167.4TiB)	256TB (232.9TiB)	328TB (292.4TiB)	400TB (363.9TiB)	472TB (429.4TiB)

Note: Usable storage capacities are rounded values. Veritas calculates these values from the raw storage capacities of the various Veritas 5260 Appliance-only configurations. The raw capacity of the Veritas 2U12 65.5TiB/72TB Storage Shelf is 65.5 tebibyte. To determine the exact usable capacities of each configuration, use the following formulas: <appliance-only capacity> + 65.5 = exact usable capacity

* You can add up to six Storage Shelves to an existing Veritas 5260 Appliance with internal storage capacities of 9.1TiB or 36.4TiB. However, before you place the system into a production environment, you must migrate all MSDP data from the appliance to the first external storage shelf. After you migrate the MSDP data, the system's usable storage space may fluctuate, depending on how much actual storage space the MSDP data pool uses.

A 256GB memory upgrade kit is available for purchase when adding the first 2U12 65.5TiB/72TB Storage Shelf, which replaces all existing DIMM modules in the appliance. Contact your Veritas account representative for details.

Note: Spanning MSDP data across both Veritas 5260 Appliance internal storage and a storage shelf is not recommended as it may result in degraded performance.

Warning: Failure to migrate MSDP data after you connect a storage shelf may result in degraded appliance throughput performance.

For more information about migrating MSDP data, see the following document: [Moving the MSDP partition from a base disk to an expansion disk for optimum performance.](#)

Components of the Storage Shelf

The following sections describe the components of the Veritas 2U12 65.5TiB/72TB Storage Shelf.

Storage Shelf front panel components

Hard disk drive capacities and drive bay slot assignments

The Veritas 2U12 65.5TiB/72TB Storage Shelf contains 12 disk drive storage bays that are populated with 8 TB 7200 rpm SAS hard disk drives. The available backup storage capacity of the storage shelf equals 65 TiB. One of the disk drives is reserved as a hot spare. All disk drives are accessible from the front panel of the storage shelf after you remove the storage shelf bezel.

The following figure shows the front panel disk drive slot assignments within the Veritas 2U12 65.5TiB/72TB Storage Shelf.

Figure 2-2 Veritas 2U12 65.5TiB/72TB Storage Shelf disk drive slot layout



The storage shelf uses the drive that is located in slot 11 as a hot-spare drive.

Hard disk drive carrier characteristics

Each storage shelf hard drive is housed in a disk drive carrier. Each disk drive carrier uses a locking mechanism that secures the disk drive within the storage shelf.

Figure 2-3 Hard disk drive tray components

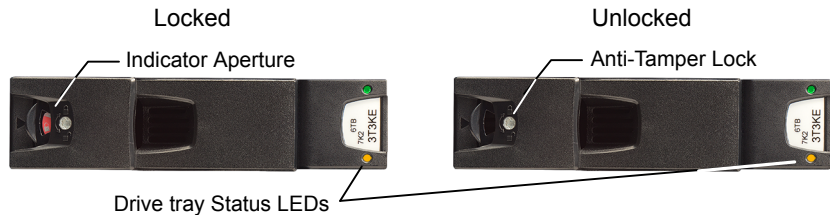

The following table describes the disk drive carrier LEDs. Note that the combination of both LEDs provides the status.

Table 2-2 Veritas 2U12 65.5TiB/72TB Storage Shelf disk drive carrier LED status

Status	Activity (green) LED	Fault (amber) LED
No disk drive installed.	OFF	OFF
Drives are installed, turned on, and operational.	Blinks during I/O activity and during startup.	OFF
SCSI Enclosure Services (SES) Device identity set.	ON	Blinks at a rate of 1 second ON and 1 second OFF.
Drive slot fault.	OFF	ON

Table 2-2 Veritas 2U12 65.5TiB/72TB Storage Shelf disk drive carrier LED status (*continued*)

Status	Activity (green) LED	Fault (amber) LED
Drive fault. Power control circuit fault.	ON	ON
Logical fault. Possible drive failed.	ON	Blinks at a rate of 3 seconds ON and one 1 second OFF.

Note: For security purposes, each drive tray is locked by default when the storage shelf is shipped from the factory. To access a hard disk drive, each storage bay must be unlocked using a T10 torx screw driver.



Storage Shelf control panel

The Veritas 2U12 65.5TiB/72TB Storage Shelf control panel is installed on the front left side of the storage shelf.

Figure 2-4 Veritas 2U12 65.5TiB/72TB Storage Shelf control panel



Table 2-3 Veritas 2U12 65.5TiB/72TB Storage Shelf control panel functions

Number	Item	Description
1	Input switch	The Input switch enables you to set the Unit Identification display.
2	Power On / Standby LED (Green or Amber)	The Power On/Standby LED shows Amber when only standby power is available. Otherwise, the LED shows Green when system power is available.
3	Module Fault LED (Power Cooling Module, Cooling, I/O module status) (Amber)	The Module Fault LED illuminates when there is a system hardware fault. The system hardware fault may be associated with a fault LED on a Power Cooling Module (PCM) or on an I/O module.
4	Logical status LED (amber)	The Logical Status LED shows a change of status or a fault. Typically these changes of status or faults are associated with the shelf's disk drives. However, the Logical Status LED can also indicate an issue with an internal RAID controller or external RAID controller, or with a host bus adapter.

Table 2-3 Veritas 2U12 65.5TiB/72TB Storage Shelf control panel functions
(continued)

Number	Item	Description
5	Unit Identification Display	The Unit Identification Display is a dual digit display that provides information about the storage shelf. Its primary function is to assist in the configuration of multiple storage shelves.

Table 2-4 Control panel LED conditions and statuses

System Power (Green or Amber)	Module Fault (Amber)	Logical Fault (Amber)	Associated LEDs/Alarms	Status
On (Amber)	Off	Off	None	Standby power present, Overall Power failed or switched off
On (Green)	On (Amber)	N/A	Single beep, then double beep	Control Panel Power on - test state (Test state = 5 seconds)
On (Green)	Off	Off	None	Power On - All functions good
On (Green)	On (Amber)	N/A	Power Cooling Module Fault LEDs Fan Fault LEDs	Any Power Cooling Module Fault, Fan Fault, or an over or under temperature issue
On (Green)	On (Amber)	N/A	I/O module LEDs	Any I/O module fault
On (Green)	On (Amber)	N/A	None	Enclosure Logical Fault
On (Green)	Flashing	N/A	Module Fault LED on an I/O module	Unknown I/O module type installed (Invalid or Mixed)
On (Green)	Flashing	N/A	Power Cooling Module Fault LEDs Fan Fault LEDs	Unknown Power Cooling Module installed. (Invalid or Mixed)

Table 2-4 Control panel LED conditions and statuses (*continued*)

System Power (Green or Amber)	Module Fault (Amber)	Logical Fault (Amber)	Associated LEDs/Alarms	Status
On (Green)	N/A	On	Array in a failed or degraded state	Drive failure has occurred causing loss of availability or redundancy
On (Green)	N/A	Flashing	Arrays in an impacted state	Array operating background function
On	Flashing	N/A	SES state S1	Enclosure ID setting different from "start of day" setting

N/A - Not Applicable

For more information, see the *Veritas 5260 Appliance Hardware Installation Guide*.

Storage Shelf rear components

This section describes the rear panel features of the Veritas 2U12 65.5TiB/72TB Storage Shelf.

The following figure provides an overview of the components that comprise the Veritas 2U12 65.5TiB/72TB Storage Shelf rear panel.

Figure 2-5 Veritas 2U12 65.5TiB/72TB Storage Shelf rear components

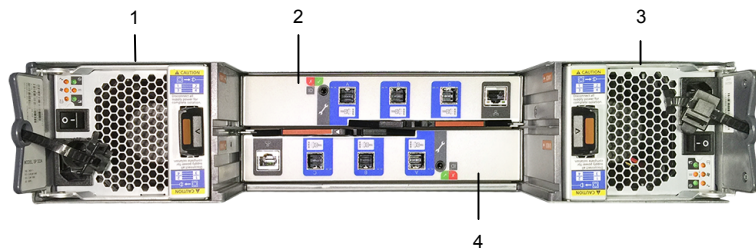

Table 2-5 Veritas 2U12 65.5TiB/72TB Storage Shelf rear components

Number	Component
1	Power Cooling Module 0 (PCM0)

Table 2-5 Veritas 2U12 65.5TiB/72TB Storage Shelf rear components
(continued)

Number	Component
2	I/O module 0
3	Power Cooling Module 1 (PCM1)
4	I/O module 1

Storage Shelf I/O modules

This section discusses the Veritas 2U12 65.5TiB/72TB Storage Shelf I/O modules.

Figure 2-6 Veritas U12 65.5TiB/72TB Storage Shelf I/O module

The following figure and table provides details of the two Veritas 2U12 65.5TiB/72TB Storage Shelf I/O module canisters.

Figure 2-7 Veritas 2U12 65.5TiB/72TB Storage Shelf I/O modules

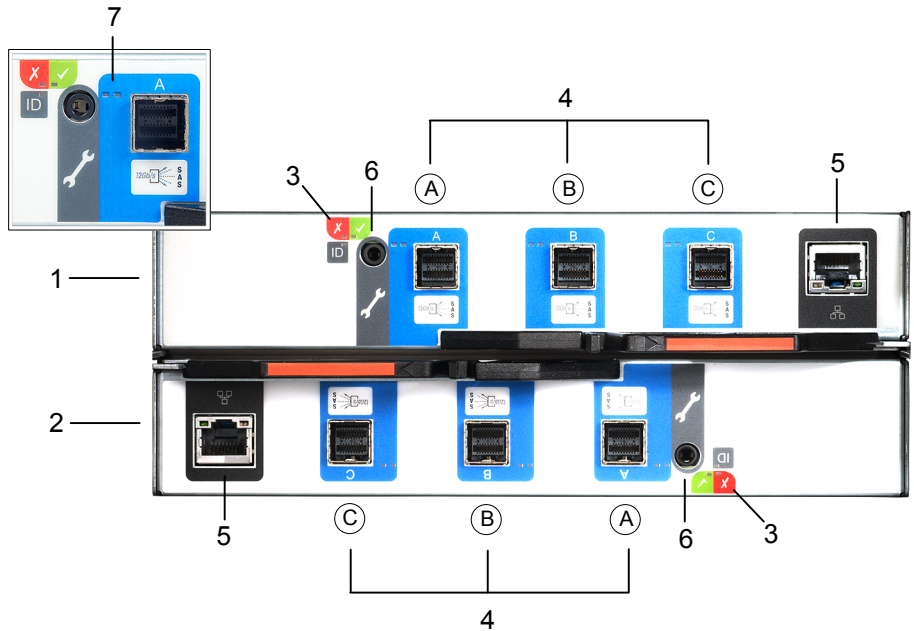

Table 2-6 Veritas 2U12 65.5TiB/72TB Storage Shelf I/O module components

Number	Description
1	I/O module 0
2	I/O module 1
3	I/O module Status LEDs See “I/O module Status LED location and conditions” on page 41.
4	mini-SAS HD ports - A, B, and C
5	Ethernet port (debugging purposes only)
6	RS232 jack (debugging purposes only)
7	SAS Activity LEDs See “I/O module SAS Activity LED location and conditions” on page 41.

I/O module Status LED location and conditions

This section discusses the location of the Status LEDs on the I/O module and the Status LED conditions.

Figure 2-8 I/O module Status indicator LED location

I/O module Status LED location

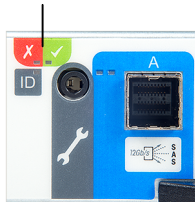

Table 2-7 I/O module Status LED conditions

Condition	Activity LED (green)	Fault LED (amber)
Module Fault (amber)	On	The I/O module has encountered a fault condition.
	Off	The I/O module is operating normally.
Power (green)	On	The I/O module is on.
	Off	The I/O module is off.
ID (blue)	On	The I/O module controller is being identified.

I/O module SAS Activity LED location and conditions

This section discusses the location of the SAS Activity LEDs on the I/O module and the SAS Activity LED conditions.

Figure 2-9 I/O module SAS Activity LED location

SAS Activity LED location



Table 2-8 I/O module SAS Activity LED conditions

Condition	Activity LED (green)	Fault LED (amber)
No Cable Present	Off	Off
Cable Present All links up, no activity.	On	Off
Cable Present All links up.	Flash with aggregate port activity	Off
Critical Fault Any fault which causes operation of the cable to cease or fail to start. For example, an OVERCURRENT trip.	Off	On
Non-Critical Fault Any fault which does not cause the connection to cease operation. For example, not all links established; OVERTEMPERATURE condition detected.	Flash with aggregate port activity	Flashing - One second on; one second off

Storage Shelf Power Cooling Modules

The Veritas 2U12 65.5TiB/72TB Storage Shelf includes two Power Cooling Modules (PCM). The dual PCMs provide redundant power to the storage shelf. If one PCM fails, the storage shelf continues to operate as the second PCM continues to supply the storage shelf with power.

Figure 2-10 Power Cooling Module



Table 2-9 Power Cooling Module components

Number	Component
1	Power Cooling Module LEDs See “Power Cooling Module LEDs” on page 44.
2	On/Off switch
3	Release tab
4	AC power socket

Table 2-10 Power Cooling Module LED legend

Number	LED condition
1	AC fail
2	Fan fail
3	Power Cooling Module OK
4	DC fail

Table 2-11 Power Cooling Module LED conditions

Status	Power Cooling Module OK (Green)	Fan Fail (Amber)	AC Fail (Amber)	DC Fail (Amber)
No AC Power (any Power Cooling Module)	Off	Off	Off	Off
No AC Power (this Power Cooling Module only)	Off	Off	On	On
AC Present (Power Cooling Module On OK)	On	Off	Off	Off
Power Cooling Module fan out of tolerance	On	Off	Off	On
Power Cooling Module fan fail	Off	On	Off	Off
Power Cooling Module Fault (Over temp, over volts, over current)	Off	On	On	On
Standby Mode	Flashing	Off	Off	Off
Power Cooling Module firmware download	Off	Flashing	Flashing	Flashing

See [“Storage Shelf Power Cooling Modules”](#) on page 42.

Veritas 5260 Appliance and Veritas 2U12 65.5TiB/72TB Storage Shelf cables

This chapter includes the following topics:

- [Power cables](#)
- [Network cable](#)
- [Multi-Mode fiber optic cable](#)
- [Twinaxial copper cables](#)
- [SAS-3 cable](#)

Power cables

Power cables include a live line, a neutral line, and a grounding line.

Figure 3-1 AC power cable



- A AC power connector (IEC-60320-C14) to an external power supply Power Distribution Unit (PDU) on a rack.
- B AC power connector (IEC-60320-C13) to an appliance or a storage device.

Note: If your power distribution unit is not compatible with the IEC-60320-C14 plug, then Veritas recommends that you purchase your power cable locally. Make sure the power cable meets or exceeds the indicated power rating.

See [“Multi-Mode fiber optic cable”](#) on page 48.

See [“SAS-3 cable”](#) on page 50.

See [“Twinaxial copper cables”](#) on page 49.

See [“Network cable”](#) on page 47.

Network cable

The appliance communicates with the Ethernet networks through an Ethernet network cable. One end of the network cable connects to the management network port or service network port of the appliance. The other end of the cable connects to the network switch or an external gateway. Both ends of the cable are RJ45 connectors.

Figure 3-2 Network cable

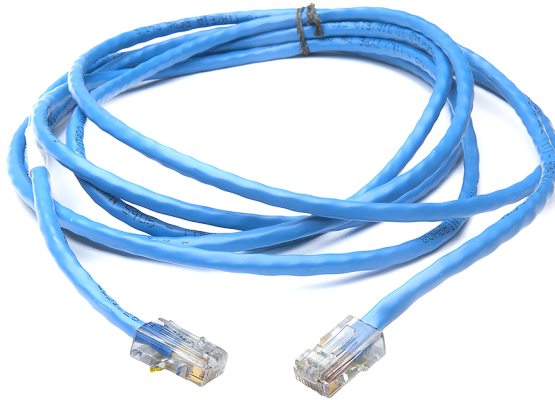

See “[Power cables](#)” on page 46.

See “[Multi-Mode fiber optic cable](#)” on page 48.

See “[SAS-3 cable](#)” on page 50.

See “[Twinaxial copper cables](#)” on page 49.

Multi-Mode fiber optic cable

Figure 3-3 Multi-Mode fiber cable

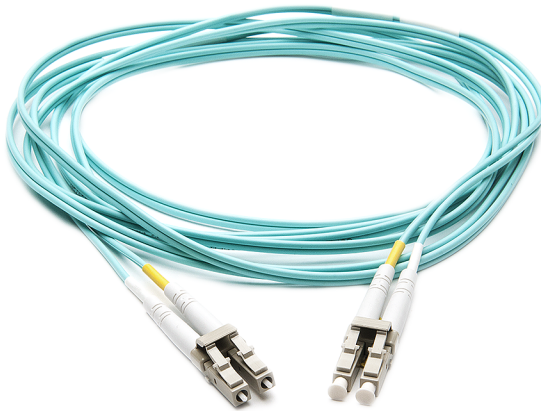

Fiber optic cables require Small Form-factor Pluggable (SFP+) transceivers, which are provided with each device having Fibre Channel ports. The diagram shows the SFP, labeled 1, and the fiber optic cable which is attached to it, labeled 2.

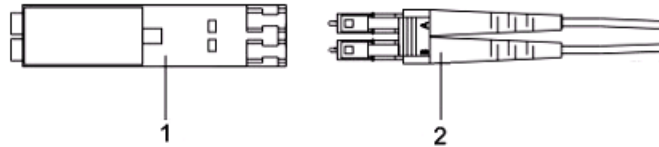

Supported SFPs are listed:

- Finisar
- JDSU

Note: Veritas recommends that you use Finisar FTLX8574D3BCV SFP part for 10G connectivity and Mellanox MMA2P00-AS SFP part for 25G connectivity.

See [“Power cables”](#) on page 46.

See [“SAS-3 cable”](#) on page 50.

See [“Twinaxial copper cables”](#) on page 49.

See [“Network cable”](#) on page 47.

Twinaxial copper cables

These cables are also known as Direct-Access Copper (DAC) cables, and are available in 1-meter, 3-meter, or 5-meter lengths.



See [“Power cables”](#) on page 46.

See [“Multi-Mode fiber optic cable”](#) on page 48.

See [“SAS-3 cable”](#) on page 50.

See [“Network cable”](#) on page 47.

SAS-3 cable

SAS-3 data cables are used to connect the optional Veritas 2U12 65.5TiB/72TB Storage Shelf to the Veritas 5260 Appliance. SAS-3 cables have a mini-SAS HD connector on both ends. Two 1m SAS-3 cables are shipped with each S Series Storage Shelf. For the D Series Storage Shelves, a 2 meter cable is standard. Longer SAS-3 cables are supported with the 2U12 Storage Shelf if needed for the configuration.

Figure 3-4 SAS-3 cable



See [“Power cables”](#) on page 46.

See [“Multi-Mode fiber optic cable”](#) on page 48.

See [“Twinaxial copper cables”](#) on page 49.

See [“Network cable”](#) on page 47.

Technical specifications, Environmental/Protocol standards, and Compliance standards

This appendix includes the following topics:

- [Veritas 5260 Appliance technical specifications](#)
- [Veritas 2U12 65.5TiB/72TB Storage Shelf technical specifications](#)
- [Environmental specifications](#)
- [Protocol standards](#)
- [Regulatory, compliance, and certification information](#)
- [Product regulatory compliance](#)
- [Country approvals](#)
- [Product safety compliance](#)
- [Product EMC Compliance - Class A Compliance](#)
- [Product environmental compliance](#)

Veritas 5260 Appliance technical specifications

The following table provides technical specifications for the Veritas 5260 Appliance.

Table A-1 Veritas 5260 Appliance technical specifications

Technical Specification	Veritas 5260 Appliance
Rack information	<p>19" EIA standard</p> <p>The rack rails that are provided for the 5260 Appliance compute node are extensible to 32" (820mm). The minimum distance or depth allowed between the rack posts is 24.6" (623mm). The maximum distance or depth allowed between the rack posts is 37" (942mm). If the distance between rack posts is longer than 37" (942mm), the rails and the appliance cannot be properly installed.</p>
Processor	Intel Xeon Scalable Third generation Silver 4314
CPU speed	2.40 GHz
Cores	32 (16 per processor)
System memory (currently supported)	<p>64 GB</p> <p>256 GB</p> <p>512GB</p> <p>Note: When you purchase the first expansion storage shelf, the Storage Expansion Kit that comes with the storage shelf includes 256 GB of memory that replaces the existing 64GB. Additional 256GB memory kit is required when you add the fifth shelf.</p>
Memory type and configuration (DIMMs)	<p>DDR4 RDIMM</p> <p>8 x 8GB (64GB)</p> <p>8 x 32GB (256GB)</p> <p>16 x 32GB (512GB)</p>
SAS RAID card installed in a PCIe riser assembly (Y/N)	PCIe RAID card: Yes
RAID cache	4 GB is also included on the external PCIe RAID controller
Usable MSDP and AdvancedDisk storage capacity (TiB)	<p>Appliance: 9.1TiB, 36.4TiB</p> <p>Each storage shelf: 65.5TiB</p> <p>Maximum configuration shipped from the factory: 429.4TiB</p>
Maximum number of storage shelves	6

Table A-1 Veritas 5260 Appliance technical specifications (*continued*)

Technical Specification	Veritas 5260 Appliance
10 Gb Ethernet ports	Up to 4 maximum
10/25 Gb Ethernet ports	Up to 6 maximum
32 Gb Fibre Channel ports	Up to 8 maximum
Dimensions (IEC rack compliant)	Height: 8.9cm (3.5") (approximately 2U) Width: 43.9cm (17.28") Depth: 71.2cm (28.03")
Maximum weight	23.3 kg (51.37 lbs)
AC power requirements	110 VAC at 10.0 A 220 VAC at 5.0 A
AC power cable	Specification: IEC-60320-C14 to IEC-60320-C13, 10A/250V, Black, 4 ft The IEC-60320-C14 plugs into a Power Distribution Unit. The IEC-60320-C13 plugs into an appliance or storage shelf power supply. Note: If your power distribution unit is not compatible with the IEC-60320-C14 plug, then Veritas recommends that you purchase your power cable locally. Make sure the power cable meets or exceeds the indicated power rating. See "Power cables" on page 46.
AC Frequency range	50/60Hz
Typical power consumption	400 watts
Typical power consumption with a maximum of six connected external storage shelves	1,936 watts
Maximum power consumption	1100 watts
Maximum power consumption with a maximum of six connected external storage shelves	3,980 watts

Table A-1 Veritas 5260 Appliance technical specifications (*continued*)

Technical Specification	Veritas 5260 Appliance
System cooling requirement (heat dissipation)	1365 BTU/hr (Typical) 3753 BTU/hr (Maximum)
System cooling requirement with maximum external storage (heat dissipation)	6606 BTU/hr (Typical) 13580 BTU/hr (Maximum)
Operating voltage	90V – 140 VAC 180V – 264 VAC
Power conversion efficiency	90% +
Acoustic noise	70 dBA

See [“Veritas 2U12 65.5TiB/72TB Storage Shelf technical specifications”](#) on page 55.

See [“Environmental specifications”](#) on page 57.

Veritas 2U12 65.5TiB/72TB Storage Shelf technical specifications

The following table provides technical specifications for a Veritas 2U12 65.5TiB/72TB Storage Shelf.

Table A-2 Veritas 2U12 65.5TiB/72TB Storage Shelf technical specifications

Technical specification	Description
Rack information	<p>The rack installation height is the space occupied by a storage shelf in a rack cabinet. The height for the storage shelf is 3.5 inches, 88.9mm. The shelf fits into a 2U rack space. Install the storage shelf in a rack cabinet that is 19 inches (483mm) wide.</p> <p>The rack rails that are provided for the storage shelf are extensible to 32” (813mm). This distance is the maximum depth that is allowed between rack posts. If the distance between rack posts is longer than 32” (813mm) the rails and the appliance cannot be properly installed.</p>
Hot swappable components	Disk drives, power cooling modules, and I/O modules (Storage Bay Bridge (SBB) 2.1)

Table A-2 Veritas 2U12 65.5TiB/72TB Storage Shelf technical specifications
(continued)

Technical specification	Description
Usable storage capacity (TB)	65.5TiB/72TB
Maximum weight (fully populated)	28 kg (62 lbs)
Shipping weight	52 kg (115 lbs)
Dimensions	Height: 8.89cm (3.5") (approximately 2U) Width: 48.26cm (19") ICE rack compliant Depth: 60.20cm (23.7")
Device types supported	Dual ported 12Gb/s SAS drives
Maximum drives per enclosure	12
AC power requirements	110 VAC at 5.2 A 220 VAC at 2.6 A
Typical power consumption	256 watts per storage shelf You can connect a maximum of six storage shelves to the Veritas 5260 Appliance.
Maximum power consumption	480 watts per storage shelf You can connect a maximum of six storage shelves to the Veritas 5260 Appliance.
System cooling requirement (heat dissipation)	873 BTU/hr (typical) 1637.8 BTU/hr (Maximum)
Operating voltage	100V - 127VAC 200V - 240VAC
AC Frequency range	50/60Hz
Power conversion efficiency	>80% @ 100V, >80% @240V (>30% load)
Acoustic noise	63 dBA
Non-operational altitude	-300 to 12,192 m (-1,000 to 40,000 ft)
Operational shock	2g 11mSec half sine
Non-operational shock	25g 10mSec half sine

Table A-2 Veritas 2U12 65.5TiB/72TB Storage Shelf technical specifications
(continued)

Technical specification	Description
Operational vibration	0.21g RMS 5-500Hz random
Non-operational vibration	1.04g RMS 2-200Hz random
Relocation vibration (Non-operational)	0.3g 2-200Hz sinusoidal

See [“Veritas 5260 Appliance technical specifications”](#) on page 52.

See [“Environmental specifications”](#) on page 57.

Environmental specifications

Veritas Appliance compute node environmental specifications

Table A-3 Veritas Appliance compute node environmental specifications

Specification	5260 Appliance compute node
Operating temperature	ASHRAE A2 (10°C to 35°C) (50°F to 95°F)
Non-operating temperature	-40 °C to 70 °C (-40 °F to 158 °F) The non-operating temperature is defined as the temperature of the system when the system is turned off. It is also referred to as the storage temperature. Veritas recommends that you do not store the system in an environment where the temperatures fall outside of the listed temperature range.
Operating humidity (RH)	20% RH to 80% RH
Non-operating humidity	8% RH to 90% RH
Operating altitude (feet)	3050 m (10,006 ft)
Temperature gradient (per hour)	10°C/h (50°F/h)

See [“Veritas 5260 Appliance technical specifications”](#) on page 52.

See [“Veritas 2U12 65.5TiB/72TB Storage Shelf technical specifications”](#) on page 55.

See [“Protocol standards”](#) on page 58.

See [“Regulatory, compliance, and certification information”](#) on page 58.

Protocol standards

The following table provides standards with which the Veritas 5260 Appliance and the Veritas 2U12 Storage Shelf comply.

Table A-4 Veritas 5260 Appliance / Veritas 2U12 Storage Shelf standards compliance

Standard	Version
IPMI 2.0	Intelligent Platform Management Interface Specification Second Generation v2.0, Document Revision 1.0
SMBIOS	System Management BIOS (SMBIOS) Reference Specification, Version 3.5.0
SAS	SAS - 3.0
ACPI	Advanced Configuration and Power Interface Specification, Revision 6.3
IP	RFC0791: Internet Protocol
FC	INCITS T11 (X3T9.3)
PCIe Express	PCIe 4.0

See [“Veritas 5260 Appliance technical specifications”](#) on page 52.

See [“Veritas 2U12 65.5TiB/72TB Storage Shelf technical specifications”](#) on page 55.

See [“Environmental specifications”](#) on page 57.

Regulatory, compliance, and certification information

The following sections give information about the product regulations and compliance.



WARNING

To ensure regulatory compliance, you must adhere to the assembly instructions in this guide to ensure and maintain compliance with existing product certifications and approvals. Use only the described, regulated components that are specified in this guide. Use of other products or components may void the regulatory approvals of the product. The result is noncompliance with product regulations in the region in which the product is sold.

Alterations to the configuration of your appliance may require additional compliance testing.

This product is an FCC Class A device. Integration of it into a Class B system does not result in a Class B device.

Product regulatory compliance

The appliance, when correctly integrated per this guide, complies with the following safety and electromagnetic compatibility (EMC) regulations.

Intended Application - This product was evaluated as Information Technology Equipment (ITE), which may be installed in offices, schools, computer rooms, and similar commercial type locations. The suitability of this product for other product categories and environments, other than an ITE application, may require further evaluation. Other product categories and environments may include medical, industrial, telecommunications, NEBS, residential, alarm systems, and test equipment.

Country approvals

- US/Canada
- CE - European Union (EU)
- Australia / New Zealand
- KCC South Korea
- IRAM Certification (Argentina)
- CCC Certification (China)

- BIS India
- NOM Mexico
- InMetro Brazil
- NRCS & SABS South Africa
- BSMI Taiwan
- VCCI Japan

Note: Other countries are either based on these requirements or do not require certification. For more regulatory compliance information please refer to this link: [Regulatory Compliance / Homologation](#)

Product safety compliance

The following is a list of product safety compliance norms for different countries:

- EN 62368-1:2014 + AC:2015
- EU Directive: Low Voltage 2014/35/EU
- CSA C22.2 No. 62368-1
- CB Certificate & Report, IEC62368-1 (report to include all country deviations)

Product EMC Compliance - Class A Compliance

The following is a list of EMC compliance norms for different countries:

- EU Directive: EMC 2014/30/EU
- EN 55035:2017 +A11:2020
- EN 55032:2015 +A11:2020
- EN 61000-3-2:2014
- EN 61000-3-3:2013
- FCC /ICES-003 - Emissions (USA/Canada) Verification
- VCCI Emissions (Japan)
- AS/NZS 3548 Emissions (Australia / New Zealand)

Note: For a complete list of regulatory notices please refer to this link:

[Veritas Safety and Compliance Guide](#)

Product environmental compliance

Use of banned substances are restricted in accordance with world-wide regulatory requirements. Restrictions include quantity limitations on the following:

- Quantity limit of 0.1% by mass (1000 PPM) for: Lead, Mercury, Cadmium, Hexavalent Chromium, Polybrominated Biphenyls Diphenyl-Ethers (PBB/PBDE), Bis (2-ethylhexyl) phthalate (DEHP), Benzyl butyl phthalate (BBP), Dibutyl phthalate (DBP), Diisobutyl phthalate (DiBP).
- Quantity limit of 0.01% by mass (100 PPM) for: Cadmium
- California Code of Regulations, Title 22, Division 4.5, Chapter 33: Best Management Practices for Perchlorate Materials
- China - Restriction of Hazardous Substances (China RoHS)
- India RoHS
- EU WEEE Directive
- EU Packaging Directive
- EU Batteries Directive
- EU Commission Regulation (EU) 2019/424 of 15 March 2019
- EU REACH Regulation

Product environmental declarations of compliance are available in this [link](#).

Index

A

- Appliance
 - configurations 6
 - overview 6
 - usable storage capacities 32

C

- cables
 - multi-mode fiber optic
 - description 48
 - network
 - description 47
 - power
 - description 46
 - SAS-3
 - description 50
 - Twinaxial copper
 - description 49

E

- Environmental specifications 57

O

- overview
 - appliance 6

P

- protocol standards
 - Veritas 5260 Appliance / Veritas 2U12 Storage Shelf 58

U

- usable storage capacities
 - appliance 32